

This article was downloaded by: [Rajith Dissanayake]

On: 12 November 2011, At: 16:26

Publisher: Taylor & Francis

Informa Ltd Registered in England and Wales Registered Number: 1072954 Registered office: Mortimer House, 37-41 Mortimer Street, London W1T 3JH, UK



Journal of Natural History

Publication details, including instructions for authors and subscription information:

<http://www.tandfonline.com/loi/tnah20>

The systematics of the dusky striped squirrel, *Funambulus sublineatus* (Waterhouse, 1838) (Rodentia: Sciuridae) and its relationships to Layard's squirrel, *Funambulus layardi* Blyth, 1849

Rajith Dissanayake^a & Tatsuo Oshida^b

^a School of Biomedical and Health Sciences, King's College, University of London; Mammal Section, Natural History Museum, Cromwell Road, London, SW7 5BD, UK

^b Laboratory of Wildlife Biology, Obihiro University of Agriculture and Veterinary Medicine, Obihiro, Hokkaido, 080-8555, Japan

Available online: 10 Nov 2011

To cite this article: Rajith Dissanayake & Tatsuo Oshida (2012): The systematics of the dusky striped squirrel, *Funambulus sublineatus* (Waterhouse, 1838) (Rodentia: Sciuridae) and its relationships to Layard's squirrel, *Funambulus layardi* Blyth, 1849, *Journal of Natural History*, 46:1-2, 91-116

To link to this article: <http://dx.doi.org/10.1080/00222933.2011.626126>

PLEASE SCROLL DOWN FOR ARTICLE

Full terms and conditions of use: <http://www.tandfonline.com/page/terms-and-conditions>

This article may be used for research, teaching, and private study purposes. Any substantial or systematic reproduction, redistribution, reselling, loan, sub-licensing, systematic supply, or distribution in any form to anyone is expressly forbidden.

The publisher does not give any warranty express or implied or make any representation that the contents will be complete or accurate or up to date. The accuracy of any instructions, formulae, and drug doses should be independently verified with primary sources. The publisher shall not be liable for any loss, actions, claims, proceedings,

demand, or costs or damages whatsoever or howsoever caused arising directly or indirectly in connection with or arising out of the use of this material.

The systematics of the dusky striped squirrel, *Funambulus sublineatus* (Waterhouse, 1838) (Rodentia: Sciuridae) and its relationships to Layard's squirrel, *Funambulus layardi* Blyth, 1849

Rajith Dissanayake^{a*} and Tatsuo Oshida^b

^aSchool of Biomedical and Health Sciences, King's College, University of London; Mammal Section, Natural History Museum, Cromwell Road, London, SW7 5BD, UK; ^bLaboratory of Wildlife Biology, Obihiro University of Agriculture and Veterinary Medicine, Obihiro, Hokkaido 080–8555, Japan

(Received 12 August 2010; final version received 7 September 2011; printed 10 November 2011)

The systematics of the dusky striped squirrel, *Funambulus sublineatus* (Waterhouse, 1838) are reassessed against new evidence following a revision of its genus, *Funambulus* Lesson, 1835. Mitochondrial DNA suggests that the Sri Lankan subspecies of *F. sublineatus* is the sister taxon of *Funambulus layardi* Blyth, 1849, despite its phenotypic similarity to the nominate species. Morphological and mtDNA evidence is presented for these species plus additional mtDNA data from *Funambulus palmarum* (Linnaeus, 1766) and *Funambulus pennantii* Wroughton, 1905. Morphometric data indicate that the two taxa conventionally considered subspecies of *F. sublineatus* are sufficiently distinct for them to be ranked separately, resulting in two further endemic mammal species in India and Sri Lanka and an increase in *Funambulus* diversity. The name of the Sri Lankan species changes to *Funambulus obscurus* (Pelzeln and Kohl 1886). Whether the mtDNA phylogeny is a true reflection of *F. obscurus* and *F. layardi* remains unresolved pending further data.

Keywords: *Funambulus*; palm squirrels; biogeography; phylogeny; South Asia

Introduction

Striped squirrels of the genus *Funambulus* Lesson, 1835, often conspicuous in urban landscapes, have their greatest diversity towards South India and Sri Lanka (Corbet and Hill 1992). A significant lack of information on members of this genus reflects wider gaps in knowledge of the squirrels of the Indomalayan region, despite its hotspot status for global sciurid diversity, incorporating 30% of recognized genera (Koprowski and Nandini 2008).

The last major published revision of *Funambulus* was by Moore and Tate (1965). Five species are currently recognized (Thorington and Hoffmann 2005): *Funambulus palmarum* (Linnaeus, 1766) from India and Sri Lanka, *Funambulus tristriatus* (Waterhouse, 1837) confined to southwest India, *Funambulus sublineatus* (Waterhouse, 1838) from southwest India and Sri Lanka, *Funambulus layardi* (Blyth, 1849) from Sri Lanka and South India, and *Funambulus pennantii* Wroughton, 1905, in northern India extending westwards through Pakistan to Iran, and introduced to

*Corresponding author. Email: rajith@clara.co.uk

Australia. Evidence from recent research (Dissanayake 2008) is here reworked focusing on *F. sublineatus* and a potential, unexpected relative, *F. layardi*, as highlighted by molecular work.

The foundation of modern taxonomy for *Funambulus* was laid by the Bombay Natural History Society's (BNHS) mammal survey from 1912 to 1923 (Corbet and Hill 1992). This concluded that *F. sublineatus* was better seen as comprising two species, *F. sublineatus (sensu stricto)* of India (IN), and *F. kathleenae* Thomas and Wroughton, 1915, in Sri Lanka (SL).

Subsequent to the publication of the name *F. kathleenae*, Robinson and Kloss (1918) presented a taxonomic checklist that drew from the BNHS work. They considered these taxa conspecific: *F. s. sublineatus* in India and *F. s. obscurus* (Pelzeln and Kohl, 1886) in Sri Lanka, of which *F. kathleenae* is a junior synonym. Robinson and Kloss (1918) indicated that their work was provisional, serving to lump together several doubtful taxa with further assessments intended as future work. Several highly questionable species from the BNHS survey were demoted to subspecies rank, particularly under the Indian *F. palmarum*. Ellerman (1961), using this checklist, accepted *F. sublineatus* as a single species. Moore and Tate (1965) largely echoed Ellerman. Historical systematic diagnoses above were mostly based on pelage and size considerations. Given that the treatment by Robinson and Kloss (1918) was provisional, a review of the status of *F. sublineatus* is fairly urgently required.

Funambulus sublineatus remains the least known species in the genus with scant and dated observations from India (Ryley 1913a; Hutton 1949) for subspecies *F. s. sublineatus*, and so Hayssen (2008) provided only a weight estimate for the species in the absence of published data. *Funambulus s. obscurus* from Sri Lanka is better evaluated (Bambaradeniya 2006; de Silva Wijeyratne 2008).

Funambulus layardi, originally described from Sri Lanka, is also little known (Phillips 1981) with confusion as to its distribution. Jerdon (1874) asserted that Layard's squirrel occurred in India, an assessment echoed (doubtfully) by Thorington and Hoffmann (2005) and authors such as Alfred et al. (2006). These assessments are based on a single specimen, the type (a juvenile according to Srinivasulu et al. 2004), of *F. layardi dravidianus* Robinson, 1917. Given that there have been no further convincing records or material from the mainland, it is here considered endemic to Sri Lanka (Hill 1939; Kotagama 2004; Srinivasulu et al. 2004; Bambaradeniya 2006), with the dubious Indian specimen a probable misidentification. Robinson's designation of *F. l. dravidianus* was somewhat cursory (in vindication of Jerdon's assertion above) with the vague type locality of western Travancore (Robinson 1917). No measurements were provided because of skull damage and the "light" dorsal stripes were ill described between a "black" saddle, a description that could apply to *F. tristriatus* as below.

Funambulus layardi is highly distinctive: its entire venter to its tail tip is ferruginous, as are the three dorsal stripes. It should not be confused with any other *Funambulus* species. Dissanayake (2008) noted two specimens in London (British Museum of Natural History; BMNH) labelled *F. tristriatus* from Karnataka that were similar to *F. layardi* with reddish venters but white stripes. In another series of eight similar specimens of *F. tristriatus* (closer to the type locality of *F. l. dravidianus*), two bore the collector label "*Sciurus layardi*" (crossed out later) from Palakkad, Kerala, with white stripes amidst a black saddle. Hutton's (1949) Indian field descriptions of

F. layardi (cited in Moore and Tate 1965) appear misidentified as hypothesized for other mammals in his account (Nandini and Mudappa 2010).

Of primary concern here is to test whether *F. sublineatus* should be split into two species as treated by the BNHS work and to review its nomenclature. In particular, a counterintuitive mitochondrial DNA (mtDNA) sister relationship (Dissanayake 2008) between *F. s. obscurus* and *F. layardi*, based on two gene sections, is reanalysed incorporating morphometric, geographic and further DNA data within a relatively comprehensive framework to hypothesize evolutionary history and speciation patterns (Corbet 1990).

Morphological and morphometric work follows research into *Funambulus* from its BNHS phase. Detailed distributional data were collated for mapping purposes. The subspecies of *F. sublineatus* are well separated between India and Sri Lanka. *Funambulus s. obscurus* and *F. layardi* have been filmed (Dissanayake 2008), under circumstances of scant observational evidence for these. Herein, *F. layardi* is considered the rarest and most elusive Sri Lankan squirrel: “its range is confined to the damp forests [altitude 300–1200 m] . . . generally only amongst the tallest forest trees” (Phillips 1981, p. 189).

Novel mtDNA data from fragments of 12S and 16S are presented for all taxa under discussion including *F. pennantii* and *F. palmarum*, complementing published evidence (Mercer and Roth 2003). *Funambulus pennantii* is the most studied, widespread and well-defined species (e.g. Ghose *et al.* 2004) with *F. palmarum*, best characterized from Sri Lanka (Phillips 1981), as used here, including molecular work to date (Mercer and Roth 2003). Such evidence addresses long-recognized challenges in distinguishing between certain squirrel species based on morphology alone (Gray 1867; Moore 1959).

Materials and methods

Morphological and morphometric evaluation

A comprehensive dataset of skull and skin measurements was amassed for the taxa under consideration (Table 1, Figure 1) with sample sizes in Table 2. This included four type specimens of relevance here. Three pertained to *F. sublineatus* including the original type as identified and listed in Table 1. Juvenile age classes with un-erupted molars (Morris 1972; Endo *et al.* 2004; Hayashida *et al.* 2007) were excluded from this selection.

The coefficient of variation (CV – Long and Frank 1968; Sokal and Rohlf 2003) is the standard deviation divided by the mean (for a given sample) expressed as a percentage. Twenty-five measurements were used (Figure 1) that excluded a CV of over 5% from an original set of 37, increasing rigour and incorporating seven traditional cranial measurements in rodent taxonomy (Rosevear 1969). Measurements were taken using Mitutoyo Digimatic[®] electronic callipers accurate to 0.05 mm. Other cranial characters assessed are reported selectively. Data from collectors such as head and body and hind foot length (Rosevear 1969) are also presented below.

A difference in the pattern of stripes between the subspecies of *F. sublineatus* (Ryley 1914) was quantified in Moore and Tate (1965). To complement the comparison, two pelage measurements were made from *F. sublineatus (s.l.)*: (1) the distance from the centre of the pale midline to the outer line on the right (as measured by Moore and Tate 1965) and (2) the diameter between the three pale stripes at this point.

Table 1. Specimens of *Funambulus* species used in morphometric analyses (arranged latitudinally).

ID No.	Registration	Taxon	Location	Lat. (E)	Long. (N)
1	NMSL59K	<i>F. layardi</i>	Horopatana, SL	8.550	80.832
2	BMNH23.12.15.2	<i>F. layardi</i>	Mousakanda, SL	7.567	80.700
3	NMSL59H	<i>F. layardi</i>	Mousakanda, SL	7.567	80.700
4	FMNH99487	<i>F. layardi</i>	Meda-Maha-Nuwara, SL	7.283	80.817
5	FMNH99488	<i>F. layardi</i>	Meda-Maha-Nuwara, SL	7.283	80.817
6	FMNH99489	<i>F. layardi</i>	Meda-Maha-Nuwara, SL	7.283	80.817
7	BMNH15.3.1.73	<i>F. layardi</i> (<i>F. l. signatus</i>)	Ratnapura district, SL	6.683	80.399
8	NMSL58-12	<i>F. layardi</i>	Balangoda, SL	6.649	80.672
9	NMSL59E	<i>F. layardi</i>	Balangoda, SL	6.649	80.672
10	NMSL59M	<i>F. layardi</i>	Hallinna Kiu, SL	6.617	80.600
11	NMSL59	<i>F. layardi</i>	Timbulketiya, SL	6.417	80.783
12	USNM114094	<i>F. layardi</i>	Bintenna, SL	6.240	80.696
13	BMNH54.3.21.3	<i>F. layardi</i>	No location, SL		
14	BMNH71.811	<i>F. layardi</i>	No location, SL		
1	BMNH13.8.22.51	<i>F. s. sublineatus</i>	Huvinakadu E., Karnataka, IN	12.417	75.750
2	BMNH19.6.2.37	<i>F. s. sublineatus</i>	Rorkerg E., Tamil Nadu, IN	11.450	76.958
3	BMNH55.12.24.321	<i>F. s. sublineatus</i> (<i>S. delesserti</i>)	Nilgiris, Tamil Nadu, IN	11.417	76.500
4	BMNH217a	<i>F. s. sublineatus</i> (<i>S. sublineatus</i>)	Nilgiris, Tamil Nadu, IN	11.417	76.500
5	BMNH82.6.9.1	<i>F. s. sublineatus</i>	Nilgiris, Tamil Nadu, IN	11.417	76.500
6(S5)	BMNH84.12.12.2	<i>F. s. sublineatus</i>	Coonoor, Tamil Nadu, IN	11.350	76.817
7	BMNH21.11.5.17	<i>F. s. sublineatus</i>	Shernelly E., Kerala, IN	10.533	76.662
8	BMNH25.10.1.25	<i>F. s. sublineatus</i>	Kodaikanal, Tamil Nadu, IN	10.233	77.483
9	BMNH7.7.7.4446	<i>F. s. sublineatus</i>	Kodaikanal, Tamil Nadu, IN	10.233	77.483
10	BMNH91.10.7.96	<i>F. s. sublineatus</i>	Kodaikanal, Tamil Nadu, IN	10.233	77.483
11	BMNH25.10.1.26	<i>F. s. sublineatus</i>	Tiger Shola, Tamil Nadu, IN	10.233	77.517
12	BMNH22.8.28.10	<i>F. s. sublineatus</i>	“Travancore”, Kerala, IN	9.750	77.167
13(S6)	BMNH22.8.28.9	<i>F. s. sublineatus</i>	“Travancore”, Kerala, IN	9.750	77.167
14	BMNH95.10.9.25	<i>F. s. sublineatus</i>	Ponmudi E., Kerala, IN	8.766	77.130
15	BMNH95.10.9.20	<i>F. s. sublineatus</i>	Kuttyani, Kerala, IN	8.586	76.921
16	BMNH95.10.9.21	<i>F. s. sublineatus</i>	Kuttyani, Kerala, IN	8.586	76.921
17	BMNH95.10.9.22	<i>F. s. sublineatus</i>	Kuttyani, Kerala, IN	8.586	76.921
18	BMNH95.10.9.23	<i>F. s. sublineatus</i>	Kuttyani, Kerala, IN	8.586	76.921
19	BMNH95.10.9.24	<i>F. s. sublineatus</i>	Kuttyani, Kerala, IN	8.586	76.921
20	BMNH79.11.21.368	<i>F. s. sublineatus</i>	South India		
1	MCZ27550	<i>F. s. obscurus</i>	Mousakanda, SL	7.567	80.700
2	FMNH96317	<i>F. s. obscurus</i>	Nuwara Eliya, SL	6.967	80.783
3	FMNH96321	<i>F. s. obscurus</i>	Nuwara Eliya, SL	6.967	80.783
4	NMSL60B	<i>F. s. obscurus</i>	Hakgala, SL	6.917	80.833
5	BMNH53.592	<i>F. s. obscurus</i>	Tonacombe E., SL	6.867	81.117
6	BMNH53.593	<i>F. s. obscurus</i>	Tonacombe E., SL	6.867	81.117

(Continued)

Table 1. (Continued).

ID No.	Registration	Taxon	Location	Lat. (E)	Long. (N)
7	BMNH15.3.1.74	<i>F. s. obscurus</i>	Pattipola, SL	6.850	80.833
8	BMNH15.3.1.75	<i>F. s. obscurus</i>	Pattipola, SL	6.850	80.833
9	BMNHUnregistered. (4900' WWA Phillips)	<i>F. s. obscurus</i>	Kotiyagalla, SL	6.783	80.683
10	BMNH31.8.11.5	<i>F. s. obscurus</i>	Ohiya, W. Haputale, SL	6.817	80.833
11	BMNH31.8.11.6	<i>F. s. obscurus</i>	Ohiya, W. Haputale, SL	6.817	80.833
12	BMNH31.8.11.7	<i>F. s. obscurus</i>	Ohiya, W. Haputale, SL	6.817	80.833
13	NMSL60XC	<i>F. s. obscurus</i>	Ohiya, W. Haputale, SL	6.817	80.833
14	NMSL60J	<i>F. s. obscurus</i>	Bogawantalawa, SL	6.800	80.683
15	NMSL60XE	<i>F. s. obscurus</i>	Horton Plains, SL	6.800	80.800
16	BMNH15.7.1.1	<i>F. s. obscurus</i> (<i>F. kathleenae</i>)	Kottawa, SL	6.100	80.300
17	BMNH53.12.27.46	<i>F. s. obscurus</i>	No location, SL		

Notes: Collection abbreviations: BMNH, Natural History Museum, London, UK; FMNH, Field Museum Chicago, IL, USA; MCZ, Museum of comparative zoology Harvard, USA; NMSL, National Museum, Colombo, Sri Lanka. In Location E. = Estate; decimal geographical coordinates (approx. in some).

Types and molecular specimens in bold type (S1 in Table 3 excluded because of missing variables).

Multivariate analyses were performed under PAST (Hammer et al. 2001) using log-transformed data. Hotelling's T^2 (Hammer and Harper 2006 – comparing multivariate means) tests conducted on a larger dataset using five intact variables for all adult specimens in these taxa revealed no significant sexual dimorphism and sexes were pooled (Dissanayake 2008) for further analysis as in similar studies (Heaney 1985; Hayashida et al. 2007). Two morphometric analyses were performed after partitioning a selection of specimens that maximized available data and type material (Table 1).

Dataset 1 used the most intact skulls available (i.e. that retained all 25 measurements) at the expense of some other available specimens. It included 10 *F. layardi* (Table 1: specimens 1–6, 8 and 9 inclusive), 12 *F. s. sublineatus* (specimens 1, 2, 7, 8, 11, 12, 14–19) and 11 *F. s. obscurus* (1, 2, 4–8, 11, 13–15). Dataset 1 excluded type material as all these specimens lacked some of the 25 variables. A principal components analysis (PCA) was carried out (Hammer and Harper 2006) using the correlation matrix (all 25 variables included). To execute subsequent multivariate tests of difference between taxa, the number of variables needed to be fewer than the number of specimens per taxon. The 25 variables were therefore reduced to eight by eliminating those with a CV below 0.25%: this left the most precise and statistically reliable variables 1, 2, 3, 8, 11, 12, 13 and 24. Tests of comparisons were conducted between the two taxa of *F. sublineatus* to compare their means and variances, following confirmation that the data in each population were normally distributed. These included a Hotelling's T^2 test and a multivariate two-group permutation test (Hammer and Harper 2006).

Dataset 2 used only 10 variables (3, 9, 10, 11, 12, 13, 15, 19, 24, 25) of the 25 common to the type specimens incorporating *all* specimens in Table 1. Here the numbers of specimens (14 *F. layardi*, 20 *F. s. sublineatus* and 17 *F. s. obscurus*) were maximized

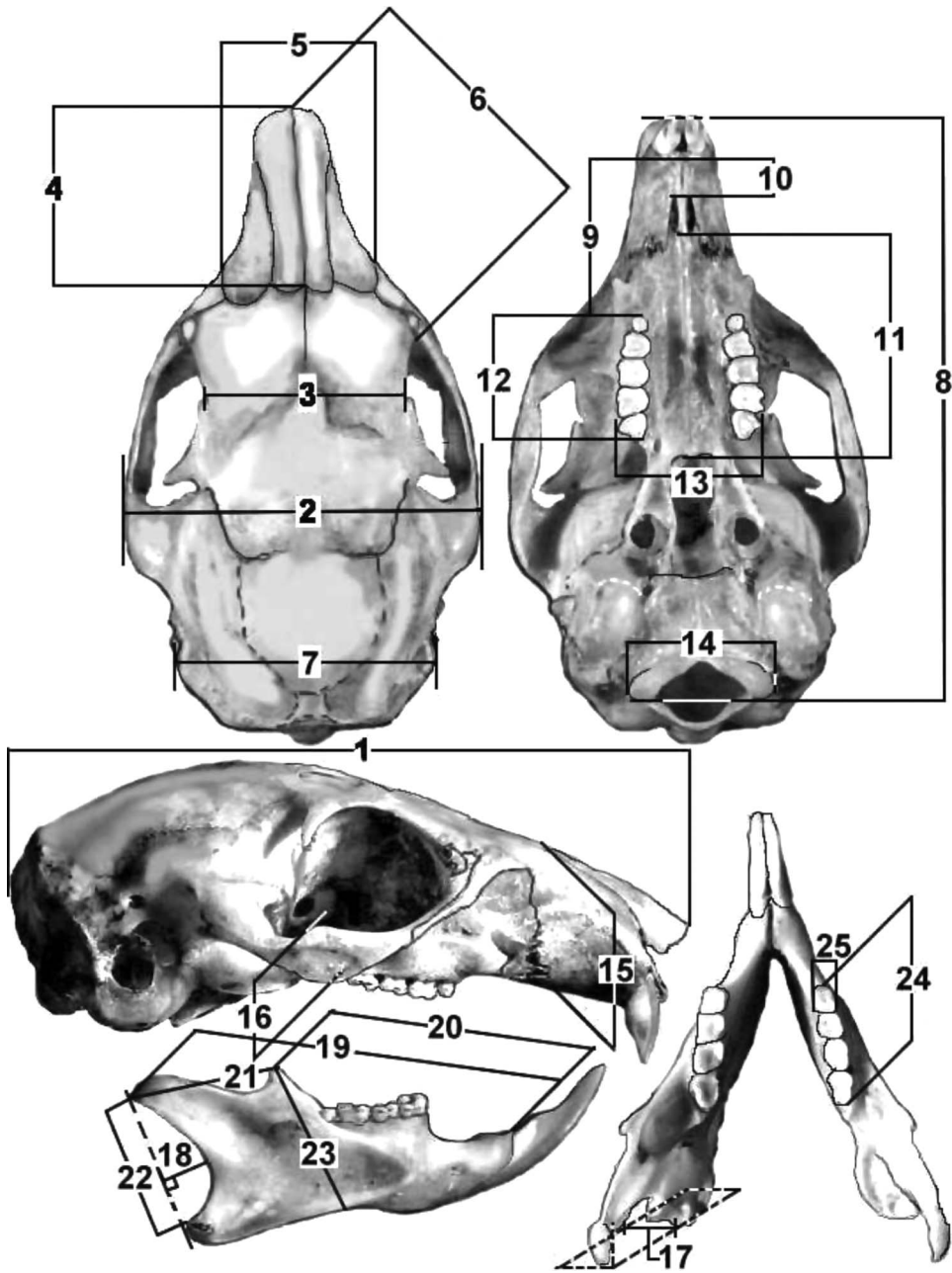

Figure 1. Twenty-five measurements and their definitions used in this study, figure is based on a *Funambulus tristriatus* skull.

at the expense of variables available for PCA. Subsequent multivariate comparisons as applied to dataset 1 were carried out with no need to similarly restrict the numbers of variables used.

Table 2. Summary statistics of morphological data for *Funambulus* species (characters 1–25 in Figure 1) in mm.

Taxon Character	<i>F. layardi</i> , SL				<i>F. sublineatus obscurus</i> , SL				<i>F. sublineatus sublineatus</i> , N				
	<i>n</i>	Mean	SD	Range	<i>n</i>	Mean	SD	Range	<i>n</i>	Mean	SD	Range	
1	22	39.80	±2.21	33.00–42.17	17	34.94	±1.58	32.08–39.34	16	33.98	±0.86	32.38–35.34	
2	24	23.67	±1.39	19.65–25.50	23	19.71	±0.53	18.00–20.32	20	19.06	±0.82	16.63–20.02	
3	23	13.98	±1.27	10.86–16.01	24	11.13	±0.49	10.26–12.20	22	10.80	±0.54	9.67–11.85	
4	23	11.36	±1.05	9.40–13.56	24	9.11	±0.67	7.98–10.37	22	9.58	±0.56	8.45–10.56	
5	23	10.75	±0.60	9.32–11.80	24	9.17	±0.60	7.71–10.71	23	8.19	±0.51	7.30–9.59	
6	24	16.46	±1.18	13.89–17.87	23	13.73	±0.82	11.76–15.72	21	13.33	±0.63	12.01–14.20	
7	21	17.30	±0.80	15.61–18.76	17	15.07	±0.31	14.67–16.10	16	14.65	±0.36	14.07–15.16	
8	18	36.30	±1.67	32.56–38.35	16	31.11	±1.73	27.87–36.17	14	29.33	±1.12	27.03–30.87	
9	20	9.45	±0.49	8.41–10.42	23	8.28	±0.55	7.39–9.75	22	7.74	±0.40	7.03–8.38	
10	22	2.56	±0.25	1.96–3.31	22	2.27	±0.24	1.92–3.03	22	2.04	±0.23	1.50–2.39	
11	22	13.06	±0.67	11.57–14.21	21	10.89	±0.65	10.20–13.20	22	10.04	±0.43	9.33–10.87	
12	20	7.88	±0.37	7.22–8.55	21	6.47	±0.42	6.01–7.59	22	6.15	±0.19	5.78–6.54	
13	20	8.60	±0.42	7.33–9.09	21	7.54	±0.28	6.94–8.27	22	7.19	±0.17	6.84–7.54	
14	19	9.48	±0.72	8.18–10.47	17	8.25	±0.34	7.72–8.83	13	8.06	±0.30	7.50–8.58	
15	23	8.28	±0.63	6.89–9.25	22	7.19	±0.45	6.37–8.04	22	7.26	±0.27	6.72–7.70	
16	22	3.33	±0.55	2.08–3.89	19	2.41	±0.28	1.99–2.99	20	2.31	±0.26	1.91–2.67	
17	18	2.44	±0.42	1.70–3.11	17	2.25	±0.31	1.68–2.88	18	2.38	±0.28	1.87–3.10	
18	18	2.78	±0.20	2.50–3.21	17	2.42	±0.30	1.88–3.17	18	2.12	±0.30	1.41–2.58	
19	20	23.78	±1.20	21.70–25.39	17	20.54	±1.07	18.03–23.50	22	19.74	±0.73	18.24–20.73	
20	19	16.37	±0.75	14.93–17.80	18	13.94	±0.80	12.50–15.18	21	13.42	±0.44	12.64–14.13	
21	18	8.50	±0.84	6.51–9.55	18	7.31	±0.69	6.01–9.20	21	7.16	±0.45	6.31–7.95	
22	19	7.95	±0.50	6.54–8.74	18	6.77	±0.53	6.06–7.78	19	6.58	±0.52	5.53–7.18	
23	20	10.13	±0.62	9.00–11.29	17	8.70	±0.55	7.36–9.53	20	8.51	±0.44	7.56–9.29	
24	20	7.42	±0.36	6.79–8.10	22	6.21	±0.39	5.78–7.50	23	5.88	±0.20	5.46–6.19	
25	19	1.52	±0.17	1.12–1.84	22	1.22	±0.12	0.95–1.55	22	1.14	±0.08	0.93–1.31	
Head and body	28	154.04	±11.46	120–170	19	119.26	±8.05	100–131	13	117.77	±6.42	110–130	
Tail	25	142.71	±15.92	85–165	19	107.06	±12.39	79–122	21	117.65	±9.25	98.42–135	
Hind foot	29	35.91	±3.01	29–40	22	29.53	±2.67	24–38	16	25.81	±3.99	17.50–31	
Ear	22	16.30	±1.40	14–19	21	14.05	±1.56	11–18	14	12.96	±1.75	9–15	
No. bulla septa	18	1 = 44%, 2 = 50%, 1.5 = 6%				16	1 = 75%, 2 = 6.25%, 1.5 = 9.4%				14	1 = 78.6%, 1.5 = 21.42%	

Notes: Body measurements from collectors. Proportions of specimens in last row based on septa counts from right bulla following Moore (1959) with dominant proportions highlighted. IN, India; SD, standard deviation; SL, Sri Lanka.

Molecular analysis

Material and field collection

Reliable assessments of taxon identity on molecular dendrograms are helped by the pairing of at least two specimens per species. Mercer and Roth's (2003) genus-level tree for the Sciuridae (corroborated by Steppan et al. 2004) was based on three DNA sequences per specimen, two mitochondrial (fragments of 12S and 16S as used here) and one nuclear, but the paucity of museum material meant that only single specimens often represented species. Related studies have sometimes only relied on a single, substantive, mtDNA gene section (Dalebout et al. 2004; Oshida et al. 2005; Yuan et al. 2006).

Funambulus s. sublineatus was only available from dry museum specimens and DNA was sought from skull scrapings. Whereas nuclear DNA would have bolstered the quality of phylogenies, only mtDNA sequences were obtained, given the challenges of obtaining sequences from degraded material. Sequences from two specimens per taxon were obtained. Voucher material, localities, identities and accession numbers granted for all species included in the molecular work are listed in Table 3 (some specimens also in Table 1).

Three whole naturalized Australian *F. pennantii* (Long 2003) were obtained, saturated in ethanol and maintained at -20°C along with a whole Sri Lankan *F. palmarum* (P2, in 70% ethanol) yielding ample tissue for DNA extraction. Fresh muscle tissue from *F. s. obscurus* in ethanol (S4) was obtained from material from the Colombo museum [National Museum Sri Lanka (NMSL) – Table 3] identified and labelled from a locality that continues to harbour this taxon. Given the tenuous amounts of tissue obtained for specimen S4, no voucher material remains in the UK (though this is traceable to the NMSL).

The remainder of fresh material came from blood samples gathered from the field in Sri Lanka onto Whatman Classic FTA[®] card (www.whatman.com, 2010). All the taxa used in molecular work here were readily identified with confidence. Dry museum material used was clearly labelled and skulls and skins could be matched to verifiable specimens. The identities of any DNA sequences obtained were tested on the basis of reference sequences (see below) including verified sequences obtained during this work. Species in the field were identified by locality, behaviour and appearance with assistance from Goonatilake, a trained zoologist. Collection permits were obtained from the Department of Wildlife Conservation (DWLC) in Sri Lanka, and guidelines for handling animals were followed. Squirrels were trapped non-lethally, and blood was taken along with a record of sex, weight and body measurements including head-and-body, tail, ear and hind foot length, per specimen (Rosevear 1969); photographs were taken before animals were released. Typically 30–100 μl blood was obtained, taking into account the health of animals following consultation (Dissanayake 2008). Eight blood samples were collected: five from *F. palmarum*, two from *F. layardi* and one from *F. s. obscurus*. Voucher material was registered and deposited at the BMNH (Table 3).

DNA extraction, targeting and sequencing

Two mtDNA sequences were obtained representing fragments of 12S (c. 820 base pairs) and 16S (c. 550 base pairs) per 17 specimens targeted (Table 3) as in Mercer and Roth (2003) incorporating six identified taxa (the five above and *Rubrisciurus*, as below).

Table 3. Summary of material for molecular work on *Fumambulus* species.

Taxon, Sequence ID and type of material*	Registration BMNH	Collection locality†	12S			16S					
			Length (bp)	Unique characters	Accession no.	Length (bp)	Unique characters	Accession no.			
<i>F. pennantii</i> Pen425	W	2002.425	Perth, A	31.933S	115.833E	823		FJ861252	552		FJ861268
<i>F. pennantii</i> Pen426	W	2002.426	Perth, A	31.933S	115.833E	823		FJ861253	552		FJ861269
<i>F. pennantii</i> Pen427	W	2002.427	Perth, A	31.933S	115.833E	823		FJ861254	552		FJ861270
<i>F. layardi</i> L1	B	ZD2006.525	Sinharaja, SL	6.452N	80.610E	821		FJ861244	553		FJ861260
<i>F. layardi</i> L2	B	ZD2006.526	Sinharaja, SL	6.452N	80.610E	821		FJ861245	553		FJ861261
<i>F. palmarum</i> P2	W	2002.484	Gampaha, SL	7.083N	80.000E	823		FJ861246	552		FJ861262
<i>F. palmarum</i> P3	B	ZD2006.528	Medettenne, SL	7.053N	80.666E	823		FJ861247	552		FJ861263
<i>F. palmarum</i> P4	B	ZD2006.529	Medettenne, SL	7.053N	80.666E	823		FJ861248	552		FJ861264
<i>F. palmarum</i> P5	B	ZD2006.530	Colombo, SL	6.898N	79.872E	823		FJ861249	552		FJ861265
<i>F. palmarum</i> P6	B	ZD2006.531	Colombo, SL	6.898N	79.872E	823		FJ861250	552		FJ861266
<i>F. palmarum</i> P7	B	ZD2006.532	Nilgala, SL	7.183N	81.300E	823		FJ861251	552		FJ861267
<i>F. s. sublineatus</i> S1	D	23.11.12.1	Benhops, IN	11.342N	76.879E	823	10	FJ861255	554	23	FJ861271
<i>F. s. sublineatus</i> S5	D	84.12.12.2	Coonoor, IN	11.350N	76.817E	534		FJ861258	553		FJ861274
<i>F. s. sublineatus</i> S6	D	22.8.28.9	Travancore, IN	e9.750N	c.77.167E	825	24	FJ861259	552		FJ861275
<i>F. s. obscurus</i> S3	B	ZD 2006.527	Eton Estate, SL	7.030N	80.670E	821		FJ861256	553		FJ861272
<i>F. s. obscurus</i> S4	W	unregistered	Agarapatana, SL	6.850N	80.683E	419		FJ861257	553		FJ861273

Notes: *D, dry; W, wet; B, blood.

†A, Australia; IN, India; SL, Sri Lanka; Decimal Lat. and Long.

Fresh material

Excepting blood samples, the Qiagen Dneasy[®] Tissue Kit, and the Qiagen[®] DNA blood and tissue kit were used along with the accompanying protocols (www1.qiagen.com, 2010; Qiagen 2004). The Nanodrop[™] spectrophotometer (www.nanodrop.com, 2010) was used to assay extract concentration. Blood specimens were ready for direct polymerase chain reaction (PCR) following purification (www.whatman.com, 2010). The PCR required the initial and final pair of primers (Figure 2, Table 4, following Mercer and Roth 2003; Mercer personal communication 2005) in 25- μ l batches using “illustra PuReTaq Ready-To-Go[™] PCR Beads” (Amersham Biosciences, Piscataway, NJ, USA) using the manufacturer’s instructions with negative controls. Table 5 covers the cycling parameters. Typically, product was assessed using 1% ethidium bromide agarose gels (Hillis et al. 1996) with a Promega[™] Hyperladder IV.

PCR products were purified using the QIAquick[™] PCR Purification Kit (Qiagen 2002) or the QIAquick[™] Gel Extraction Kit using the associated protocols and assayed using Nanodrop[™]. For sequencing, pairs of complementary sequences were always sought and sequence reactions were conducted in 10- μ l batches in 0.2-ml tubes using 1 μ l Applied Biosystem’s BigDye[®] V.1-3 Terminator solution. Sequencing followed (Applied Biosystems 3730xl DNA Analyser) using a single-column polyacrylamide gel (Hillis et al. 1996).

SEQUENCHER[®] v. 4.6, Build 2500 (www.genecodes.com, 2010) was used for sequence editing using reference DNA from Mercer and Roth (2003) and additional sequences from this work.

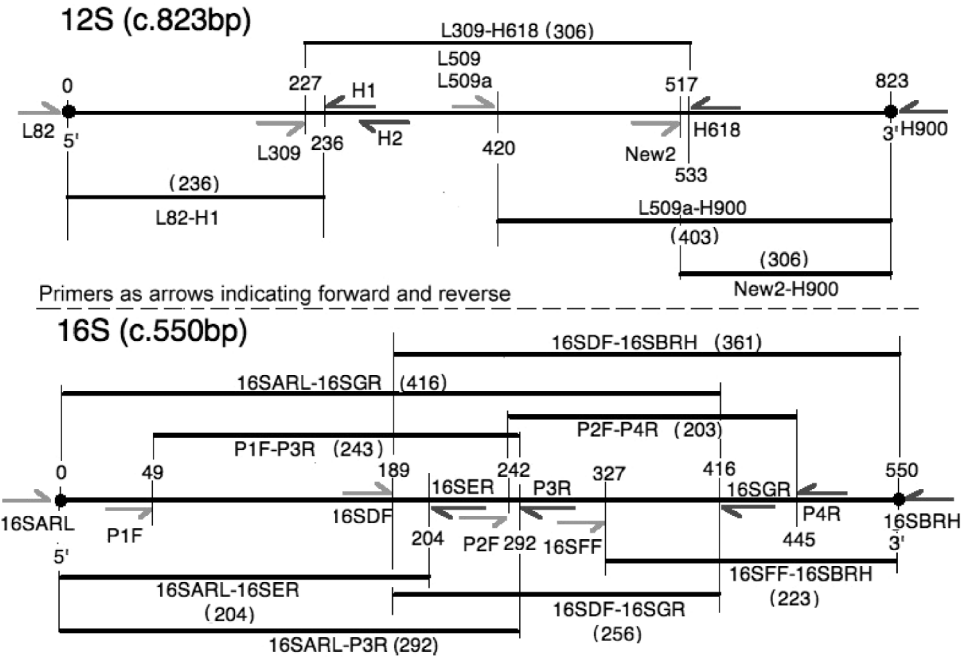

Figure 2. Primers used and approximate lengths (base pairs) of DNA targeted (parenthesis). Primer annealing position indicated by base number of primary target along its length.

Downloaded by [Rajith Dissanayake] at 16:26 12 November 2011

Table 4. Primers used to obtain sequences.

12S Forward primers		12S Reverse primers	
L82	CATAGACACAGAGGTTTGGTCC	H1	RRTTTATCGTATGACCG
L309	GTTGGTAAATCTCGTGC	H2	TAAACACGCTTTACRCC
L509	AAAAAGCTTCAAACCTGGGATTAGATACCCCACTAT	H618	TATCGATTATAGAACAGGCTCC
L509a	AAAAAGCTTCAAACCTGGGATTAGATAC	H900	TGACTGCAGAGGGTGACGGGGGTTGTGT
New 2	CTCAAAGGACTTGGCGGTGC Used more than L509a		
16S Forward primers		16S Reverse primers	
16SARL	CGCCTGTTTTCAAAAACAT	16SER	GCTCCATAGGGTCTTCTCGTC
16SDF	TTGACCTTCCCCTGAAAAGGC	16SGR	GGCTGTTATCCCTGGGTAAAC
16SFF	GGTTGGGTGACCTCGGAG	16SBRH	CCGTCGAACTCAGATCACGT
P1F	TGCCGTGCCAGTGACATAC (nested)	P3R	CAACCRAAATCYSTRGYTCA (nested)
P2F	CAGCTTWAATCYAAYTAGCT (nested)	P4R	CTGTCGATATGGACTCTTGRG (nested)

Notes: Ambiguities R: A/G; Y: C/T; W: A/T; S: C/G; the labels of novel primers created during this work are shaded.

Table 5. Cycling parameters (cyclical steps shaded)

Step	Temperature °C	Time	No.	Description
Standard sequencing parameters used, as applied to most of the 16S sequences				
1	94	5 min	×1	Initial denaturation
2	94	40 s		Denaturation
3	50	30 s	×45	Annealing
4	72	1 min		Extension
5	72	5 min	×1	Final extension
6	4	Hold	×1	
Altered parameters for L509a-H900 fragment – all steps except 3 as above				
3	61.5	30 s	×45	Annealing
Main 12S parameters (using New 2-H900) – all steps except 3 as above (Gradient cycling)				
3	47.6(L82-H1), 51.8(L309-H618), 66(2–900)	30 s	×45	Annealing
Nested primers for 16S S5 – all steps except 3 and 4 as above (Gradient cycling)				
3	47(P2F-P4R), 52(P1F-P3R), 52.3(16SARL-P3R)	30 s		Annealing
4	72	45 s		Extension

Dry museum material

Fresh material DNA protocols were relatively straightforward yielding reliable complementary sequences. Degraded DNA proved challenging, and additional steps are described (supplementary section).

DNA extraction was as above but instead of 20 μ l Proteinase K (20 mg/ml), 25 μ l was used. DNA concentration in the extract elute of 400 μ l was too dilute for assay or PCR. The Novagen[®] Pellet Paint[™] kit (www.emdbiosciences.com, 2010) and protocol was applied (Novagen 2006) with non-fluorescent dye. Here DNA was precipitated out as a bulked pellet, rehydrated as a 40- μ l extract elute. Nanodrop[™] assays as above only required *c.* 1 μ l elute, greatly conserving the concentrated extract and yielding more precise readings (ng/ μ l).

PCR required novel primers (Table 4, Figure 2) and each sequence was generally compiled from three overlapping fragments (Figure 2) representing six PCR per specimen for 12S and 16S following basic protocols above.

Sequence identity, alignment and phylogenetic analyses

Sequence identity and any contamination were checked individually using BLAST programs (via the *blastn* and *megablast* criteria – www.ncbi.nlm.nih.gov, 2010). In the vast majority of cases, the Mercer and Roth (2003) *Funambulus* sequences were the best match, followed by other squirrels and contamination was eliminated or resolved in the case of S6 (supplemental information).

Some dry material DNA indicated irresolvable ambiguities between complementary sequences (supplementary information). Homology between taxa was evaluated before aligning completed sequences using BLAST. All the *E* values (Claverie and Notredame 2007; the probability that the sequences were similar by chance alone) for

individual sequences – compared with *Funambulus* sequences from Mercer and Roth (2003), were 0. Similarly, all sequences were > 85% similar. Average genetic distance in each aligned block using the *P* distance model in MEGA (Kumar et al. 2004) was <5% (Kumar and Filipinski 2006; Hall 2008).

Partial 12S ribosomal RNA (rRNA; 821–823 base pairs) and 16S rRNA (552–554 base pairs) sequences were aligned and all gap-sites were excluded by eye. Of 12S rRNA haplotypes, the sequences of three *F. s. sublineatus* haplotypes (S4Agara, S5Coonr and S6Travn, Table 3) were too short for phylogenetic analyses, because it was difficult to amplify DNA sequences from aged specimens. Therefore these 12S rRNA sequences were excluded.

In establishing relationships in *Funambulus* using 12S and 16S rRNA sequences Maximum Likelihood and Bayesian analyses were performed using MODELTEST 3.06 (Posada and Crandall 1998) to select the most appropriate model of molecular evolution via the Akaike information criterion. For 12S rRNA sequences, this test chose the general time reversible (GTR) model of substitution (Rodríguez et al. 1990) following a gamma distribution shape parameter (G: 0.0848). Base frequencies were estimated as A = 0.3520, C = 0.2227, G = 0.1719 and T = 0.2535, and the rate matrix was also estimated as A–C = 6.8665×10^7 , A–G = 12.8952×10^7 , A–T = 5.0440×10^7 , C–G = 0.0001, C–T = 33.5700×10^7 and G–T = 1.0000. For 16S rRNA gene sequence data, this test also chose the GTR+G (0.1407). Base frequencies were estimated as A = 0.3111, C = 0.2180, G = 0.1988 and T = 0.2722, and the rate matrix was also estimated as A–C = 27.06541×10^7 , A–G = 36.3400×10^7 , A–T = 56.3157×10^7 , C–G = 0.3220, C–T = 252.9993×10^7 , and G–T of 1.0000. Bayesian inferences were carried out using MRBAYES 3.0b4 (Huelsenbeck and Ronquist 2001). The analyses involved two runs at one million iterations using four Markov chain Monte Carlo chains sampling every 1000 generations and a burn-in of 20%. Then, 50% majority rule consensus trees based on the remaining trees were generated. Posterior probabilities were used to assess nodal support of the Bayesian inference trees. Unweighted maximum parsimony analyses were performed. The maximum likelihood and unweighted maximum parsimony trees were constructed with the heuristic search algorithm using tree-bisection-reconnection in PAUP4.0* version 4.0b10 (Swofford 2001). In addition, neighbour-joining analyses (Saitou and Nei 1987) were performed with the GTR + G model in PAUP* version 4.0b10 for both 12S rRNA and 16S rRNA phylogenetic trees. Bootstrap values (Felsenstein 1985) were derived from 500 replications in the maximum likelihood analysis, 5000 replications in the maximum parsimony analysis, and 5000 replications in the neighbour-joining analysis for assessment of branching confidence.

All trees were rooted using *Rubrisciurus rubriventer* sequences [accession numbers: AY227520 (12S rRNA) and AY227464 (16S rRNA)] reported by Mercer and Roth (2003). Based on the interphotoreceptor retinoid binding protein (IRBP) and 12S and 16S rRNA gene sequences, Mercer and Roth (2003) demonstrated that *Rubrisciurus* is more closely related to *Funambulus* than are other Asian tree squirrels providing good candidacy as an out-group for phylogenetic assessment. Given intrageneric phylogeny signals would have been weakened by additional out-groups in the present analyses, out-group comparisons would be better facilitated elsewhere (Dissanayake in preparation).

Results

Distribution

Figure 3 indicates the distribution of *F. sublineatus*, demarcated between southern India and Sri Lanka. The type locality for *F. s. sublineatus* is somewhat general (Table 1). All the detailed distributional data for *F. s. sublineatus* pre-date 1950 with no recent studies. Given significant forest loss since then (Jha *et al.* 2000), it is difficult to evaluate its current distribution except from popular sources (e.g. Menon 2003) that suggest its continued presence in Nilgiri forests. The distribution of *F. s. obscurus* has been surveyed intermittently until relatively recently (Dissanayake 2008) in Sri Lanka since the establishment of a reliable type locality at Kottawa (Ryley 1914). Both taxa seem to prefer montane habitats (frequently above 1000 m) though they also occupy suitable lowland habitats that have since diminished. *Funambulus s. obscurus* occupies the highest altitudes in Sri Lanka (range 10–2300 m), and even historically appears to have been confined to the southwest wet zone of the island, (Bambaradeniya 2006) particularly the humid central montane massifs. The distribution of *F. s. sublineatus* is also biased towards mountain ridges, along the boundaries of Kerala and Tamil Nadu, southwest India (altitude range 39–1966 m). Both taxa occupy regions described as biodiversity hotspots such as Sinharaja (De Zoysa and Raheem 1993) or the Indian Western Ghats (Bossuyt *et al.* 2004). Thirty-six localities were available for *F. sublineatus* (*s. l.*). Tables 1 and 3 provide the bulk of relevant gazetteer data.

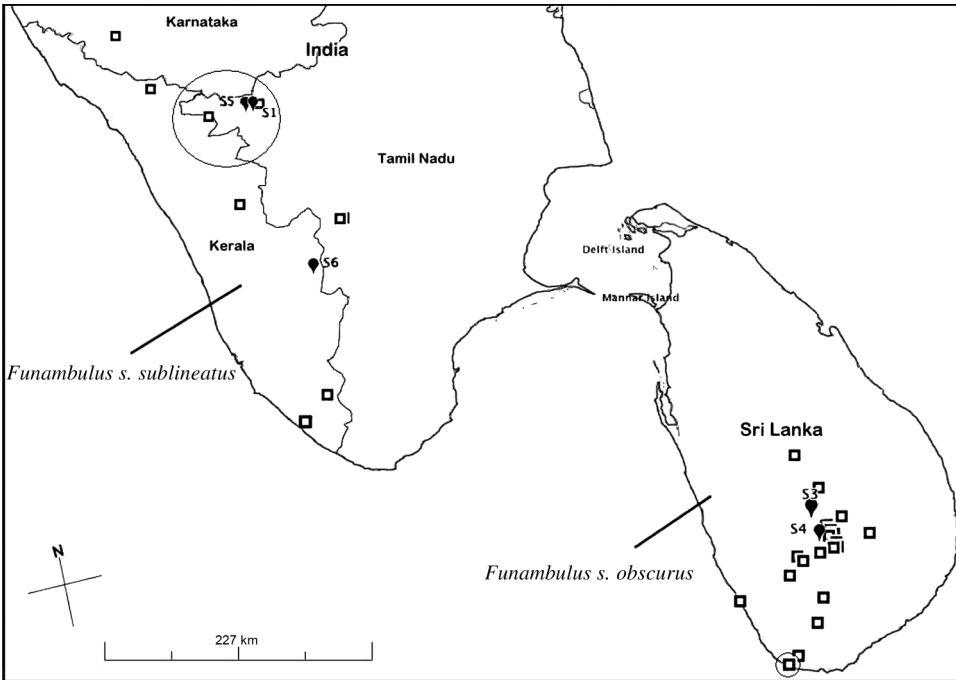

Figure 3. The distribution of *Funambulus sublineatus* based on specimens from all collections studied (Dissanayake 2008). This maps reflects historical distributions given likely habitat loss. Locations for specimens used in molecular work (Table 3) are indicated by their sequence code (Table 3) and the locations or regions of type material circled (Table 1).

Physical and morphometric evidence

Figure 4 compares and contrasts *F. layardi* and *F. sublineatus*. The distinctions between the two *F. sublineatus* taxa have been described elsewhere (Moore and Tate 1965; Ryley 1914). In reference to pelage measurements referred to above, the Indian form has a narrower band of three pale stripes. (1) The mean diameter between these at their widest point is 15.3 mm ($n = 22$) in *F. s. sublineatus* and 23.9 mm ($n = 11$) in *F. s. obscurus*. Similarly, (2) the gaps between the central stripe and the one to

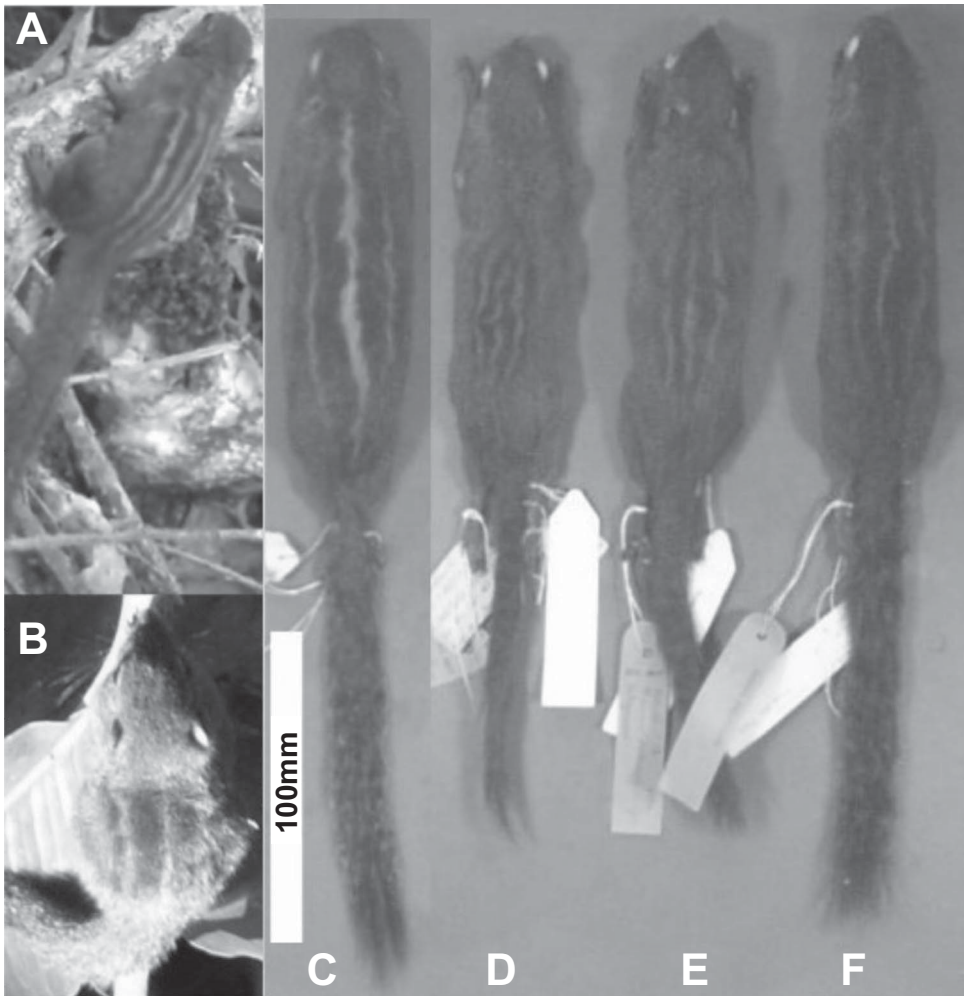

Figure 4. (A) *Funambulus sublineatus sublineatus* above (identified by Dissanayake from a video produced by Ajith Kumar on YouTube.com 2011 with permission); (B) *F. s. obscurus* below (Dissanayake). Right image, the three taxa with a scale bar, the types (C) *Funambulus layardi signatus*, (D) *Sciurus sublineatus* (= *F. s. sublineatus*), (E) *Sciurus delesserti* (= *F. s. sublineatus*), (F) *F. kathleena* (= *F. s. obscurus*) (see Table 1). *Funambulus s. obscurus* has longer pale stripes with a wider separation of the same general colour (brown) as the pelage outside the saddle area. By contrast *F. s. sublineatus* has shorter, distinctive paler stripes against a darker saddle.

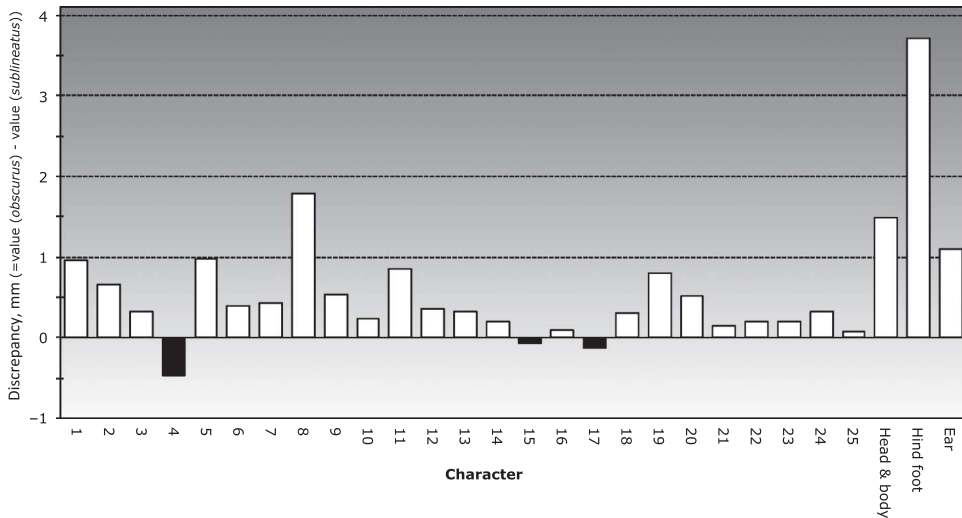

Figure 5. Discrepancy between means of linear characters including information from skins (excluding tail length), subtracting the same character values of *Funambulus sublineatus sublineatus* from *F. s. obscurus*, given that the latter is typically larger. Data from all suitable specimens (Table 2).

its right are 3.5 mm and 7.6 mm, respectively (4–5 and 7–8 mm in Moore and Tate 1965).

Table 2 provides statistics on the basis of *all* suitable specimens (Dissanayake 2008) including types examined for morphometric data and body measurements from collectors. The numbers of bulla septa (Moore 1959) are also indicated.

Information on the body weight of these squirrels is relatively scant. On the basis of two values [including that of S3 (Table 3), and Phillips 1981], the mass of *F. s. obscurus* is 70 g, larger than a single datum from a collector note for *F. s. sublineatus* of 42 g (as 1.5 oz; very similar to the estimated value of 40 g by Hayssen 2008). The mass of *F. layardi* is better documented (including L1–L2, $n = 7$), at an average of 138 g.

Craniometric data are most reliable for morphometrics, followed by hind foot length (Rosevear 1969). Figure 5 (from Table 2) indicates that most of the measurements are consistently larger in *F. s. obscurus* (as stated in Ryley 1914) than in its putative sister taxon (except for an average 10 mm longer tail length in *F. s. sublineatus*). The PCA and multivariate tests between two datasets corroborate this relatively independently. PCA from datasets 1 and 2 are indicated on Figures 6 and 7, respectively. In Figure 7, the type specimens are representative of their taxa. Component 1 is indicative of size and increases towards the left. A good separation between the two *F. sublineatus* taxa is suggested in both analyses with PC1 taking up > 79% of variation. *Funambulus layardi* in particular is better separated from the other two and cannot be confused with them. *Funambulus s. obscurus* is more closely allied to the former by size as indicated in the PCA and measurements (Table 2) including weight. A Hotelling T^2 , comparing means (Hammer and Harper 2006) applied over dataset 1

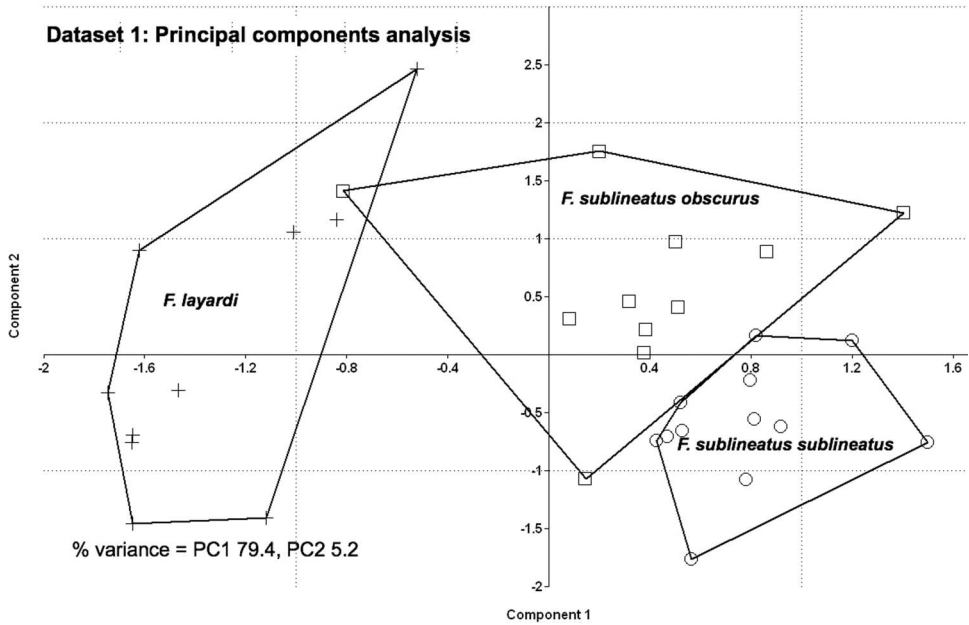

Figure 6. Principal components analysis for dataset 1.

comparing *F. s. sublineatus* and *F. s. obscurus* suggests a significant difference between them ($p = 0.0372$) as does a two-group permutation test ($p = 0.04$). The equivalent results for dataset 2 are $p = 0.006$ for both tests, suggesting a more significant separation between these taxa. Additional work (Dissanayake 2008) including multiple analyses of variance supported these findings.

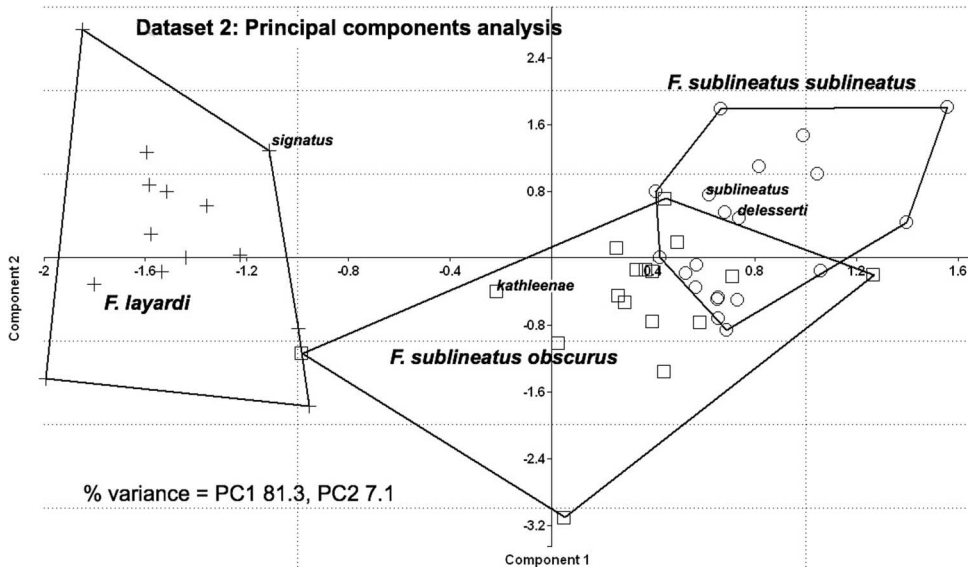

Figure 7. Principal components analysis for dataset 2 including type material examined.

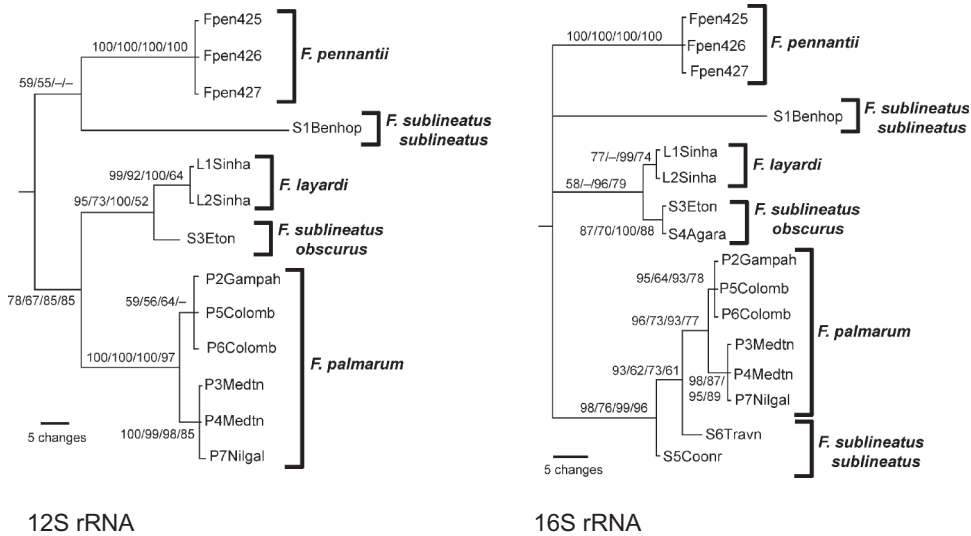

Figure 8. Rooted Bayesian trees from molecular analyses, Table 3 identifies the specimens. Nodal support values in each phylogenetic tree (BI/ML/MP/NJ) are given on branches.

Molecular evidence

Molecular data (Figure 8) support considering *obscurus* a different species from *F. sublineatus*. The sequences for *F. palmarum* and *F. pennantii* from Mercer and Roth (2003) aligned themselves congruently as expected (Dissanayake 2008), thereby indicating reliable data.

On the basis of the trees obtained, there is a clear split between the two *F. sublineatus* clades. Phylogenetic analyses in Dissanayake (2008) including maximum likelihood and neighbour-joining agreed as above, with a greater separation between the subspecies (*sublineatus* and *obscurus*) given the intervention of even more *Funambulus* taxa (several Indian *F. palmarum* and *F. tristriatus* taxa sampled from museum material).

Based on mtDNA, *F. s. sublineatus* does not appear monophyletic so two species are suggested, although morphometric data do not support this. As yet, the molecular specimens (S1 and S5) show no obvious geographical separation to create meaningful operational taxonomic units for statistical tests of disparity, and craniometric characters appear homogeneous. Further DNA evidence, particularly of nuclear DNA, from fresh material would facilitate clarity. In *all* the phylogenetic trees obtained, *F. layardi* was consistently sister group to *F. s. obscurus*, in a clade that was split from any remaining funambulines with high bootstrap or posterior probability support.

Uncorrected pairwise (P) distances (Oshida et al. 2006; Yuan et al. 2006) using MEGA (Hall 2008) were 6.58% between the two subspecies of *F. sublineatus* with an average value between generally accepted *Funambulus* species of 5.30%. This contrasts with 1.10% for distance between *F. layardi* and *F. s. obscurus*, comparable with the average P distance (1.13%) at an intraspecies level (Dissanayake 2008).

Discussion

Establishing F. sublineatus obscurus as a distinctive species

Superficially the two forms of *F. sublineatus* appear similar (Moore and Tate 1965) in size and pelage, although the lack of weight data compromises scalar comparisons (Figure 4). They share an unusual yellowish olive venter, a lack of an interorbital notch (in $\geq 90\%$ of specimens) that occurs in well over 50% of specimens in other funambulines (except *F. layardi*) and apparently similar habitats in tending to occupy cooler, montane, forested regions. Recent treatment as conspecifics reflects the history of taxonomic thinking in the twentieth century, characterized as a “regrettable trend from about 1920 to 1980, when specific recognition was excessively restrained, with correspondingly reckless subspecific recognition” (Brandon-Jones et al. 2004: p. 98).

A species-level division, under a phylogenetic species concept (e.g. Cracraft 1989), is well supported here by morphology (consistent differences in pelage and size; Figures 4 and 5): the two forms are unambiguously separated by pelage and are significantly different statistically in measurements, as indeed was suggested historically (Ryley 1914). The inter-taxon genetic distances of mtDNA between the two forms of *F. sublineatus* are strong: 17 informative sites between sequences for this pair of taxa indicate species-level differentiation. On the basis of Mercer and Roth (2003) indicating a split between *F. palmarum* in Sri Lanka and *F. pennantii* around 9.5 million years ago, the split between the mtDNA of the two taxa of *F. sublineatus* is at least as ancient (Dissanayake 2008). As there is no reasonable doubt that the analyses’ results truly reflect mtDNA relationships, the question now becomes to what extent these can be seen as representative of species phylogeny, a topic returned to below.

Circumstantially, polyphyly between Indian and Sri Lankan taxa thought to be conspecific has already been suggested in herpetofaunal groups among others (Bossuyt et al. 2004; Biju and Bossuyt 2008). The present work provides a similar mammalian example.

The affinities between F. sublineatus in Sri Lanka and F. layardi

The mitochondrial genetic affinity between *F. layardi* and *F. (s.) obscurus* could be taken to suggest a close evolutionary affinity of the squirrels themselves, were they not readily distinguished by appearance and vocalizations, and were they not sympatric in some areas (Kotagama and Goodale 2004). The close relationship of these two in mtDNA is more surprising, given the evident morphological similarity between *F. (s.) obscurus* and *F. (s.) sublineatus* but the relative absence of a kinship in these two taxa’s mtDNA. Although mtDNA phylogenies have often been taken uncritically to indicate the evolutionary relationships of the animals themselves, they are far from definitive in this respect. Many examples are now hypothesized of mtDNA introgression, such that the mtDNA sends a misleading signal of evolutionary relationships among the host organisms (Funk and Omland 2003; Hassanin and Ropiquet 2007). Among squirrels, *Glaucomys sabrinus* is paraphyletic, according to mtDNA, with regard to *Glaucomys volans* (Arbogast 2007). Examples of wider separations between the component taxa of traditional species have been discerned elsewhere (Gonçalves and De Oliveira 2004; Ohdachi et al. 2004). In some cases, past breeding patterns have led to an isolated population of one species having the mtDNA of another species,

although the isolated population is morphologically very similar to its conspecifics elsewhere, e.g. among deer *Odocoileus* (Cathey et al. 1998). Perhaps most relevant to the present status of these *Funambulus* taxa, there are cases in various mammalian orders where one form has mtDNA that is more similar to mtDNA in members of a distantly related species-group than it is to that in the other taxa in its own group (as assessed by both morphology and nuclear DNA), as in the European Bison *Bos bonasus* (Verkaar et al. 2004) and the Phayre's Leaf Monkey *Trachypithecus phayrei* (Liedigk et al. 2009). The Banteng *Bos javanicus* population on Java has mtDNA highly divergent from that of the mainland Southeast Asian populations tested, which themselves resemble the morphologically distinctive and sympatric Kouprey *B. sauveli* (Hassanin and Ropiquet 2007). Although the initial finding of mtDNA similarity between Kouprey and (mainland) Banteng led to a bizarre suggestion that the Kouprey was not therefore a valid species (Galbreath et al. 2006), these and similar incidences are generally taken as cases where the mtDNA phylogeny does not faithfully represent the evolutionary patterns of the animals. It is quite plausible that *F. (s.) sublineatus*, *F. (s.) obscurus* and *F. layardi* comprise another such case. The likelihood of this is increased by consideration of location and climatic history: *F. (s.) obscurus* lives on Sri Lanka, remote from *F. (s.) sublineatus* in India, but overlapping with *F. layardi*. With the changing climate over evolutionary time, areas of moist forest (the habitat of *F. sublineatus*) on Sri Lanka will have expanded and shrunk and perhaps at some particularly dry period, the lineage of *F. sublineatus* was small enough to have had its mtDNA replaced by that of the lineage that lead to *F. layardi*.

Hence, the true relationships of *F. (s.) obscurus* remain opaque, with morphology suggesting sister relationship to allopatric *F. (s.) sublineatus*, but mtDNA doing likewise to sympatric *F. layardi*. Morphological evidence may yet provide some support for the mtDNA result. Whereas the interorbital notch is largely absent from *F. sublineatus sensu lato* (Moore and Tate 1965; as observed here in = 90% of specimens) it is less developed in *F. layardi* (absent in c. 45% of specimens) than in the remaining congeners. Available bacular information (Hill 1936) is not diagnostic, but Amerasinghe (1983) established a morphological link between these dissimilar species in their microscopic hair structure. Unfortunately Amerasinghe and Hill had no access to *F. (s.) sublineatus*.

***Funambulus sublineatus* – nomenclature**

In recognizing *F. (s.) obscurus* as a distinctive taxon, the validity of the original name “*Sciurus palmarum var obscura*” (Pelzeln and Kohl 1886) must be scrutinized in the light of an earlier name advocated twice by a key *Funambulus* taxonomist (Ryley 1913b, 1914). *Sciurus trilineatus* is first mentioned in Blyth (1849), with no authority, in passing: “as in *Sc. trilineatus* (vel [= or] *Delesserti*)”. Kelaart (1850) then proposed it, as “*S. trilineatus?*”, in a list of Sri Lankan mammals (p. 159). Despite being well appraised on nomenclatural priority, e.g. as applied to *Sciurus palmarum*, Blyth (1847: p.874) recognized *trilineatus* with Waterhouse as authority as an addition to the squirrels of Ceylon (Blyth 1851). Kelaart (1852) substantiated the name as a title (p.54):

“SCIURUS TRILINEATUS. Waterhouse. The Newera-Ellia “ground” Squirrel.”

Waterhouse cannot be the authority as there is no record by him proposing this taxon (following Blyth 1851), but there is a good description in Kelaart (1852). *Sciurus sublineatus* is mentioned as a synonym but Kelaart (1852) recognized *S. trilineatus* occurring in southern India. On the strength of this publication, Kelaart (1852) has been accorded authority for *trilineatus* by subsequent authors. As the earliest name for the Sri Lankan species Ryley (1914: p.662) advocated it:

“D. – FUNAMBULUS TRILINEATUS, Kel. *The Newera Eliya ground Squirrel*. 1852. *Sciurus trilineatus*, Kelaart, Prod. p. 54 . . . The name of *trilineatus* must be used as although it only appears as a *nomen nudum* in 1850* [as above] and in 1851† Blyth mentions it as a synonym of *Sc. Delesserti*, Kelaart published a description . . . in 1852, though he did not separate it from the S. Indian species and gave Waterhouse the credit of describing it, including *Sc. Delesserti* and *sublineatus* as synonyms.”

Thomas and Wroughton (1915) rejected *trilineatus* as a junior synonym of *F. sublineatus* [given Kelaart (1852) added *F. sublineatus* as a synonym of *F. trilineatus*, although *sublineatus* had original priority] and created *F. kathleenae* honouring Ryley. Robinson and Kloss (1918) recognized the priority of *obscurus* (Pelzeln and Kohl 1886), a name that Thomas and Wroughton (1915) apparently overlooked as the earliest unambiguous name for this taxon. That it has no traceable type does not affect its availability. The first available name for the Sri Lankan taxon is therefore *Funambulus obscurus* (Pelzeln and Kohl, 1886) following the current code (ICZN 2000). Kelaart's *Nuwara Eliya ground squirrel* became the *Ceylon Dusky striped jungle squirrel* (Phillips 1928) after Sterndale's (1884) *Dusky striped squirrel*, formerly the *Nilgiri striped squirrel* (Grigg 1880; Jerdon 1874).

Funambulus obscurus may be recognized as a valid taxon as distinct from *F. sublineatus*, provisionally recognized here as a single species.

The nomenclatural history of *F. sublineatus sensu lato* is summarized elsewhere (Corbet and Hill 1992; Thorington and Hoffmann 2005) but the original authority for *Sciurus delesserti*, a synonym of *F. (s.) sublineatus* remains untraced. It was given as: (Gervais, 1841), by Corbet and Hill (1992) and Thorington and Hoffmann (2005), but elsewhere as Guérin, c. 1842 (quoted as “Guérin, *Mag. Zoo.* 1842, and *Zoologie du Voyage de M. Ad. Delessert*” p. 874 in Blyth 1847, untraced and excluded from bibliography).

Evolutionary history and biogeography

This work identifies two species, *F. sublineatus* and *F. obscurus*, regarded as sufficiently similar to have been treated as conspecific under twentieth century use of the biological species concept. Based on mtDNA, there appears a high degree of speciation since their separation, but the reliability of the mtDNA signal remains to be established. They have retained similarities in form and ecology, presumably reflecting their occupation of similar habitat in their respective ranges. If the mtDNA phylogeny is confirmed, it suggests ancestral resemblance in conservative traits or intrageneric homoplasy.

Overall, the three *Funambulus* species *F. layardi*, *F. obscurus* and *F. sublineatus* as considered here represent excellent examples of relict species (Ripley 1949, 1980), most

at risk of anthropogenic extinction. This work helps to refine Moore's (1960) sketch of *Funambulus* evolution along the lines implied in Mercer and Roth (2003).

Recent mammalian discoveries (Meegaskumbura *et al.* 2002, 2007) indicate lacunae in our understanding of mammalian diversity in this region and further work should enhance our knowledge of *Funambulus* with implications for conservation in South Asian biodiversity hotspots (Koprowski and Nandini 2008).

Acknowledgements

We are grateful to PhD supervisors Dr Sarah Churchfield (King's College) and Paula Jenkins (BMNH mammal section); Dr T. Sainsbury (Zoological Society London); Professor S. Kotagama (Colombo University); R. Mathavan (Eton Estate); to The Department of Wildlife Conservation (DWLC) regarding fieldwork; Dr R. Pethiyagoda (Wildlife Heritage Trust, Sri Lanka); to Winifred Kirkpatrick, Vertebrate Pest Research Western Australia for specimens; to Dr E. Michel and Professor D. Polly for statistical work and to Drs S. Carranza, P. Olson (BMNH); J. Mercer, and L. Roth (Duke University, USA). Special thanks are due to Dr David A. Johnston (BMNH) for molecular assistance and Sampath Goonatilake for fieldwork (IUCN Sri Lanka). We thank Dr William Duckworth for extensive and unstinting contributions to the manuscript. Dr D. Jeffares and C. Rallis provided help and encouragement (University College London). Ajith Kumar granted permission to reproduce Figure 4A. R.D. thanks Mrs A. Dissanayake and Dr S.A.W. Dissanayake who helped both fund and co-ordinate aspects of this research.

References

- Alfred JRB, Das AK, Sanyal AK. 2006. Animals of India: Mammals. Kolkata: ENVIS – Zool. Surv. India; p.1–236.
- Amerasinghe FP. 1983. The structure and identification of the hairs of the mammals of Sri Lanka. *Ceylon J Sci (Bio Sci)* 16(1&2):76–119.
- Arbogast BS. 2007. A brief history of the new world flying squirrels: phylogeny, biogeography, and conservation genetics. *J Mammal.* 88(4):840–849.
- Ballard JWO, Whitlock MC. 2004. The incomplete natural history of mitochondria. *Mol Ecol.* 13:729–744.
- Bambaradeniya CNB, (Ed.). 2006. Fauna of Sri Lanka: Status of Taxonomy, Research and Conservation. The World Conservation Union, Colombo, Sri Lanka & Government of Sri Lanka.
- Biju SD, Bossuyt F. 2008. Systematics and phylogeny of *Philautus* Gistel, 1848 (Anura, Rhacophoridae) in the Western Ghats of India, with descriptions of 12 new species. *Zool J Linn Soc.* 155(2):374–444.
- Blyth E. 1847. Supplementary Report by the Curator, Zoological Department. *J Asiatic Soc (Bengal)*. 16(1):864–880.
- Blyth E. 1849. Note on the Sciuri inhabiting Ceylon and those of the Tenasserim provinces. *J Asiatic Soc (Bengal)*. 18(1):600–603.
- Blyth E. 1851. Report on the Mammalia and the more remarkable species of Birds inhabiting Ceylon. *J Asiatic Soc (Bengal)*. 20(2):153–185.
- Bossuyt F, Meegaskumbura M, Beenaerts N, Gower DJ, Pethiyagoda R, Roelants K, Mannaert A, Wilkinson M, Bahir MM, Manamendra-Arachchi K, Ng PKL, Schneider CJ, Oommen OV, Milinkovitch MC. 2004. Local endemism within the Western Ghats - Sri Lanka biodiversity hotspot. *Science.* 306(5695):479–481.

- Brandon-Jones D, Eudey AA, Geissmann T, Groves CP, Melnick DJ, Morales JC, Shekelle M, Stewart CB. 2004. Asian primate classification. *Internat J Primatol.* 25:97–164.
- Cathey JC, Bickham JW, Patton JC. 1998. Introgressive hybridization and nonconcordant evolutionary history of maternal and paternal lineages in North American deer. *Evolution.* 52:1224–1229.
- Claverie J-M, Notredame C. 2007. *Bioinformatics for Dummies*. Hoboken: Wiley Publishing.
- Corbet GB. 1990. The relevance of metrical, chromosomal and allozyme variation to the systematics of the genus *Mus*. *Biol J Linn Soc.* 41(1–3):5–12.
- Corbet GB, Hill JE. 1992. *The Mammals of the Indomalayan region: a systematic review*. Oxford: Oxford University Press & Natural History Museum Publications.
- Cracraft J. 1989. Speciation and its ontology: the empirical consequences of alternative species concepts for understanding patterns and processes of differentiation. : In: D Otte, Endler JA, editors *Speciation and Its Consequences*. Sunderland: Sinauer Associates. p. 28–59.
- Dalebout ML, Baker CS, Mead JG, Cockcroft VG, Yamada TK. 2004. A comprehensive and validated molecular taxonomy of beaked whales, family Ziphiidae. *J Hered.* 95(6):459–473.
- de Silva Wijeyratne G. 2008. *A photographic guide to the mammals of Sri Lanka*. London: New Holland Publishers (UK).
- De Zoysa N, Raheem R. 1993. *Sinharaja – A Rain Forest in Sri Lanka*. Colombo: March for Conservation.
- Dissanayake R. 2008. *A taxonomic revision of Funambulus (Mammalia, Sciuridae)* [Unpublished PhD thesis]. London: School of Health and Life Sciences, Kings College, University of London.
- Ellerman JR. 1961. Genus 8. *Funambulus* Lesson. In: *The Fauna of India including Pakistan, Burma and Ceylon, Mammalia (second edition) Vol 3, Rodentia (in two parts), Part 1*. ML Roonwal editor. Delhi: Zoological Survey of India (Govt. of India). p. 190–240.
- Endo H, Kimura J, Oshida T, Stafford BJ, Rerkamnuaychoke W, Nishida T, Sasaki M, Hayashida A, Hayashi Y. 2004. Geographical and functional–morphological variations of the skull in the Gray-Bellied Squirrel. *J Vet Med Sci.* 66(3):277–282.
- Felsenstein J. 1985. Confidence limits on phylogenies: an approach using the bootstrap. *Evolution.* 39:783–791.
- Funk DJ, Omland KE. 2003. Species-level paraphyly and polyphyly: frequency, causes, and consequences, with insights from animal mitochondrial DNA. *Annu Rev Ecol Evol Syst.* 34:397–423.
- Galbreath GJ, Mordacq JC, Weiler FH. 2006. Genetically solving a zoological mystery: was the kouprey (*Bos sauveli*) a feral hybrid? *J Zool.* 270:561–564.
- Gervais H. 1841. In: Villant AE, Eydoux F, Souleyet FLA editors. *Voyage autour du monde, execute pendant les annees 1836 et 1837 sur la corvette la Bonite, commandee par M. Vaillant. Zoologie, par MM. Eydoux et Souleyet*. Paris: Bertrand.
- Ghose RK, Mandal AK, Ghose PS. 2004. A contribution to the taxonomy of (sic) Indian Fivestriped Squirrel (*Funambulus pennanti* Wroughton), with description of two new subspecies. *Records Zool Surv India* 102(3–4):89–103.
- Gonçalves PR, De Oliveira JA. 2004. Morphological and genetic variation between two sympatric forms of *Oxymycterus* (Rodentia: Sigmodontinae): an evaluation of hypotheses of differentiation within the genus. *J Mammal.* 85(1):148–161.
- Gray JE. 1867. XXXV. – Synopsis of the Asiatic Squirrels (Sciuridae) in the Collection of the British Museum, describing one new Genus and some new Species. *Ann Nat Hist.* 20: 270–286.
- Grigg HB. 1880. *A Manual of the Nilagiri District in the Madras Presidency*. Madras: Government Press.
- Hall BG. 2008. *Phylogenetic trees made easy: a how-to manual*. 3rd ed. Sunderland, MA: Sinauer Associates, Inc.

- Hammer Ø, Harper DAT. 2006. Paleontological data analysis. Malden, USA: Blackwell Publishing.
- Hammer Ø, Harper DAT, Ryan PD. 2001. PAST: Palaeontological Statistics Software Package for Education and Data Analysis. *Palaeontol Electronica*. 4(1):9pp.
- Hassanin A, Ropiquet A. 2007. What is the taxonomic status of the Cambodian banteng and does it have close genetic links with the kouprey? *J Zool*. 271:246–252.
- Hayashida A, Endo H, Sasaki M, Oshida T, Kimura J, Waengsothorn S, Kitamura N, Yamada J. 2007. Geographical variation in skull morphology of Gray-Bellied squirrel *Callosciurus caniceps*. *J Vet Med Sci*. 69(2):149–157.
- Hayssen V. 2008. Reproductive effort in squirrels: ecological, phylogenetic, allometric, and latitudinal patterns. *J Mammal*. 89(3):582–606.
- Heaney LR. 1985. Systematics of Oriental Pygmy Squirrels of the Genera *Exilisciurus* and *Nannosciurus* (Mammalia: Sciuridae). *Misc Publ Mus Zool, Univ Michigan*. 170:1–58.
- Hill WCO. 1936. The penis and its bone in Ceylonese squirrels; with special reference to its taxonomic importance. *Spolia Zeylanica* 20(1):99–113.
- Hill WCO. 1939. A revised check-list of the mammals of Ceylon. *Spolia Zeylanica* 21(2): 139–183.
- Hillis DM, Moritz C, Mable BK editors. 1996. *Molecular systematics*. 2nd ed. Sunderland MA: Sinauer Associates.
- Hofreiter M, Jaenicke V, Serre D, Haeseler Av, Paabo S. 2001. DNA sequences from multiple amplifications reveal artifacts induced by cytosine deamination in ancient DNA. *Nucleic Acids Res*. 29(23):4793–4799.
- Huelsenbeck JP, Ronquist F. 2001. MRBAYES: Bayesian inference of phylogeny. *Bioinformatics*. 17:754–755.
- Hutton AF. 1949. Notes on the snakes and mammals of the High Way Mountains, Madura District, south India. Pt. 2 – mammals. *J Bombay Nat Hist Soc*. 48:681–694.
- ICZN. 2000. International code of zoological nomenclature. London: the international trust for zoological nomenclature. London: The Natural History Museum.
- Jerdon TC. 1874. The mammals of India (reprinted as A handbook of the mammals of India). London/New Delhi: John Wheldon (original) / Mittal Publications 2004 (re-issuue).
- Jha CS, Dutt CBS, Bawa KS. 2000. Deforestation and land use changes in Western Ghats, India. *Curr Sci*. 79(2):231–238.
- Kelaart EF. 1850. 1. Catalogue of the Mammalia of Ceylon. Collected and observed by E. F. Kelaart, M. D., F.L.S. *Proc Zool Soc Lond*. (part XVIII).155–159.
- Kelaart EF. 1852. *Prodromus faunae Zeylanicae being contributions to the zoology of Ceylon*. Colombo: Observer Press.
- Koprowski JL, Nandini R. 2008. Global hotspots and knowledge gaps for tree and flying squirrels. *Curr Sci*. 95(7):851–856.
- Kotagama SW. 2004. *Pictorial Pocket Guide 3 – Mammals in Sri Lanka*. Colombo: Field Ornithology Group of Sri Lanka (FOGSL).
- Kotagama SW, Goodale E. 2004. The composition and spatial organisation of mixed-species flocks in a Sri Lankan rainforest. *Forktail, J Asian Ornithol*. 20:63–70.
- Kumar S, Filipski A. 2006. Multiple sequence alignment: in pursuit of homologous DNA positions. *Genome Res*. 17:127–135.
- Kumar S, Tamura K, Nei M. 2004. MEGA3: Integrated software for molecular evolutionary genetics analysis and sequence alignment. *Brief Bioinform*. 5(2):150–163.
- Lesson RP. 1835. *Illustrations De Zoologie, ou Recueil De Figures D’animaux peintes d’après nature*. Paris: Arthur Bertrand.
- Liedigk R, Thinh VN, Nadler T, Walter L, Roos C. 2009. Evolutionary history and phylogenetic position of the Indochinese grey langur (*Trachypithecus crepusculus*) Vietnam *J Primatol*. 1(3):1–8.

- Linnaeus C. 1766. *Systema naturae per regna tria naturae, secundum classes, ordines, genera, species, cum characteribus, differentiis, synonymis, locis*. 12th ed. Holmiae: Laurentii Salvii.
- Long CA, Frank T. 1968. Morphometric variation and function in the baculum, with comments on correlation of parts. *J Mammal*. 49(1):32–43.
- Long JL. 2003. *Introduced mammals of the world : their history, distribution and influence*. 1st ed. Victoria: CSIRO Publishing Australia & CABI Publishing UK.
- Meegaskumbura M, Bossuyt F, Pethiyagoda R, Manamendra-Arachchi K, Bahir M, Milinkovitch MC, Schneider CJ. 2002. Sri Lanka: An Amphibian hot spot. *Science*. 298:379.
- Meegaskumbura S, Meegaskumbura M, Pethiyagoda R, Manamendra-Arachchi K, Schneider CJ. 2007. *Crocidura hikmiya*, a new shrew (Mammalia: Soricomorpha: Soricidae) from Sri Lanka. *Zootaxa*. 1665:19–30.
- Menon V. 2003. *A field guide to Indian mammals*. Delhi: Dorling Kindersley.
- Mercer JM, Roth LV. 2003. The effects of Cenozoic global change on squirrel phylogeny. *Science*. 299:1569–1572.
- Moore JC. 1959. Relationships among the living squirrels of the Sciurinae. *Bull Am Mus Nat Hist*. 118(4):153–206.
- Moore JC. 1960. Squirrel geography of the Indian subregion. *Syst Zool*. 9(1):1–17.
- Moore JC, Tate GHH. 1965. A study of the diurnal squirrels, Sciurinae, of the Indian and Indo-Chinese subregions. *Fieldiana Zool*. 48:1–351.
- Morris P. 1972. A review of mammalian age determination methods. *Mammal Rev*. 2(3):69–104.
- Nandini R, Mudappa D. 2010. Mystery or myth: a review of history and conservation status of the Malabar Civet *Viverra civettina* Blyth, 1862. *Small Carnivore Conserv*. 43:47–59.
- Novagen. 2006. Pellet Paint Co-Precipitant. User Protocol TB146 Rev A0204 [Internet]. 2010. Darmstadt. Available from: www.novagen.com.
- Ohdachi SD, Iwasa MA, Nesterenko VA, Abe H, Masuda R, Haberl W. 2004. Molecular phylogenetics of *Crocidura* shrews (Insectivora) in east and central Asia. *J Mammal*. 85(3):396–403.
- Oshida T, Abramov A, Yanagawa H, Masuda R. 2005. Phylogeography of the Russian flying squirrel (*Pteromys volans*): implication of refugia theory in arboreal small mammal of Eurasia. *Mol Ecol*. 14:1191–1196.
- Oshida T, Lee J-K, Liang-Kong L, Chen Y-J. 2006. Phylogeography of Pallas's squirrel in Taiwan: geographical isolation in an arboreal small mammal. *J Mammal*. 87(2):247–254.
- Pelzeln Av, Kohl FF. 1886. Ueber eine Sendung von Säugethieren und Vögeln aus Ceylon. *Verhandel zool bot Ges Wien*. 35:525–528.
- Phillips WWA. 1928. A guide to the mammals of Ceylon, Part VIII, Rodentia. *Spolia Zeylanica*. 14(2):209–294.
- Phillips WWA. 1981. *Manual of the mammals of Sri Lanka*. 2nd ed. Colombo: Wildlife and Nature Protection Society of Sri Lanka.
- Posada D, Crandall KA. 1998. Modeltest: testing the model of DNA substitution. *Bioinformatics*. 14:817–818.
- Qiagen. 2002. QIAquick Spin Handbook. Crawley, West Sussex: Qiagen.
- Qiagen. 2004. DNeasy Tissue Handbook. Crawley, West Sussex: Qiagen.
- Ripley SD. 1949. Avian relicts and double invasions in penninsular India and Ceylon. *Evolution*. 3(2):150–159.
- Ripley SD. 1980. Avian relicts of Sri Lanka. *Spolia Zeylanica* 35(1&2):197–202.
- Robinson HC. 1917. On two new subspecies of squirrel from southern India. *Records Ind Mus*. 13(1):41–42.
- Robinson HC, Kloss CB. 1918. A nominal list of the Sciuridae of the Oriental region with a list of specimens in the collection of the Zoological Survey of India. *Records Ind Mus*. 15(4):171–254.

- Rodríguez F, Oliver JL, Marín A, Medina JR. 1990. The general stochastic model of nucleotide substitution. *J Theor Biol.* 142:485–501.
- Rosevear DR. 1969. The rodents of West Africa. London: Trustees of the British Museum (Natural History).
- Ryley KV. 1913a. Bombay Natural History Society's Mammal Survey of India (Collection No. 10, Kathiawar; 11, Coorg). *J Bombay Nat Hist Soc.* 22:464–513.
- Ryley KV. 1913b. Bombay Natural History Society's Mammal Survey of India, Burma and Ceylon (Report No. 13, S. Ceylon; 14, North Shan States Burma). *J Bombay Nat Hist Soc.* 22:700–725.
- Ryley KV. 1914. Scientific results from the Mammal Survey VI - (D.) FUNAMBULUS TRILINEATUS, Kel., *The Newera Eliya ground Squirrel*. *J Bombay Nat Hist Soc.* 23:662.
- Saitou N, Nei M. 1987. The neighbor-joining method: a new method for reconstructing phylogenetic trees. *Mol Biol Evol.* 4:406–425.
- Sokal RR, Rohlf FJ. 2003. *Biometry* (1995 edition). New York: W. H. Freeman and company.
- Srinivasulu C, Chakraborty S, Pradhan MS. 2004. Checklist of sciurids (Mammalia:Rodentia:Sciuridae) of south Asia. *Zoos' Print J* 19(2):1351–1360.
- Steppan SJ, Storz BL, Hoffman RS. 2004. Nuclear DNA phylogeny of the squirrels (Mammalia: Rodentia) and the evolution of arboreality from c-myc and RAG1. *Mol Phylogen Evol* 30:703–719.
- Sterndale RA. 1884. *Sterndale's Mammalia of India*; Finn F., issued 1929 and 2002. New Delhi: Cosmo Publications (2002).
- Swofford DL. 2001. PAUP* 4.0 Phylogenetic analysis using parsimony (* and other methods), Version 4.0 beta 10 (CD Rom). Sunderland, MA: Sinauer Associates.
- Thomas O, Wroughton RC. 1915. Results from Mammal Survey C. – The Singhalese species of *Funambulus*. *J Bombay Nat Hist Soc.* 24(1):29–66.
- Thorington RW, Jr., Hoffmann RS. 2005. In: Wilson DE, Reeder DM *Mammal species of the world - a taxonomic and geographic reference*. Baltimore: The Johns Hopkins University Press.
- Triant DA, DeWoody AJ. 2007. The occurrence, detection and avoidance of mitochondrial DNA translocations in mammalian systematics and phylogeography. *J Mammal.* 88(4):908–920.
- Verkaar ELC, Nijman IJ, Beeke M, Handkamp E, Lenstra JA. 2004. Maternal and paternal lineages in cross-breeding bovine species. Has Wisent a hybrid origin? *Mol Biol Evol.* 21:1165–1170.
- Waterhouse GR. 1837. Observations of the palm squirrel (*Sciurus palmàrum* of Authors). *Mag Nat Hist J Zool Bot Mineral Geol Meteorol*. Conducted by Edward Charlesworth (Charlesworth's Magazine of Natural History). 1:496–499.
- Waterhouse GR. 1838. On a new species of squirrel . . . *Sciurus sublineatus*. *Proc Zool Soc Lond.* (part VI) (6):19–20.
- Wroughton RC. 1905. The common striped palm squirrel. *J Bombay Nat Hist Soc.* 16:406–413.
- Yuan SL, Lin LK, Oshida T. 2006. Phylogeography of the mole-shrew (*Anourosorex yamashinai*) in Taiwan: implications of interglacial refugia in a high-elevation small mammal. *Mol Ecol.* 15:2119–2130.

Supplemental information

DNA extraction from dry material

During DNA extraction from dry material, the digesting buffer and enzyme mixture was incubated for longer, up to 5 days, at 55°C in sealed tubes during homogenization and digestion.

An Eppendorf® Gradient Mastercycler machine was used preferentially for 12S (96 0.2-ml wells), programmed to refine the basic cycling parameters and a faster Applied Biosystems GeneAmp® PCR system 2700 cycler for 16S sequences.

The last third of the 12S strand (509a-H900 – Figure 2) was not easily obtained and cycling parameters were altered (Table 5), the three target sequences (L82-H1, L309-618 and New2-H900) being ideally obtained simultaneously with a variable annealing temperature. Given that the L509a-H900 reaction proved challenging, New 2 was preferred as the forward primer (see Table 4, H2 was rarely employed).

When editing the S6 (Table 3) 16S sequence all except a short end strand 16SFF-16BRH was determined as human contamination. There was no further DNA template to complete the sequence. Two new pairs of primers (P1F-P4R) for exclusively sciurid DNA were developed and used along with 16SARL to obtain a *Funambulus* sequence out of largely human PCR product template. The contaminated PCR template (including squirrel product) was diluted up to a million-fold [original template diluted to 1/100 and further diluted successively (1/10² to 1/10³) until 1/10⁶; it was found that PCR worked well even at the highest dilution] and a nested PCR was performed incorporating the novel primers.

The standard parameter (Table 5) worked well for 16S sequences. Instead of using three primer pairs, results were possible with two (SARL-SGR and SDF-

SBRH). PCR purification and sequencing was as above. Poor sequence data was resolved by re-cleaning and re-sequencing in preference to repeating a sequence reaction. Despite repeat trials, the failure rate was high for 12S in particular, leaving some incomplete sequences (Table 3).

Sequence ambiguities from degraded mtDNA sequences

Sequencing error between PCR batches was possible but strands from the same batch also revealed ambiguities. No ready explanations including correlations with the age of specimens were available. Suggested lines of inquiry include cytosine deamination (Hofreiter et al. 2001) among others (Ballard and Whitlock 2004; Triant and DeWoody 2007). Numbers of ambiguities were S6 (12S: 23 – the most from all dry specimens; Dissanayake 2008, 16S: 2), S5 (16S: 2) with none in S1.

Extra sequences for *F. sublineatus* not included in the analyses

During the data-gathering process, two further sequences were obtained from a single specimen, identified as *F. sublineatus*, coded “S2” registered BM(NH)94.10.21.3 (London), collected in 1891 from Punmudi, (Travancore), Kerala, designated coordinates 08°45'58" N, 077°07'48" E, (the skull and skin clearly belong to this taxon). Whereas BLAST identity searches as above revealed that these sequences were *Funambulus*, during tree-building exercises (Dissanayake 2008), particularly using combined analyses of 12S and 16S, the specimen did not unite with S1, S5 and S6 that did join together in a monophyletic assemblage, albeit with long branch lengths. The presence of S2 in association with other *Funambulus* violated the assumption that *F. sublineatus* was a monophyletic lineage. The S2 sequences were not included in the original analyses and were left out of the above analyses, given

that their molecular affinity suggested and suggests contamination with another *Funambulus* taxon. As mtDNA evidence appears to question the monophyly of *F. sublineatus*, particularly in the case of S1 (Table 3), further work may vindicate the validity of these molecular sequences and they have therefore been uploaded to GenBank as follows: BM(NH)94.10.21.3 (S2, *F. sublineatus*), accession numbers: JF495165 (12S, 821BP); JF495164 (16S, 552BP).

These sequences were relatively complete and may be regarded as positively identified as *Funambulus* though taxon affinity remains questionable.