

A Graph Theory Based Energy Routing Algorithm in Energy Local Area Network (e-LAN)

Ruichi Wang, *Student Member, IEEE*, Jiande Wu, *Member, IEEE*, Zhongnan Qian, Zhengyu Lin,

Senior Member, IEEE, and Xiangning He, *Fellow, IEEE*

Abstract—The energy internet concept has been considered as a new development stage of the Smart Grid, which aims to increase the energy transmission efficiency and optimise the energy dispatching in time and space. Energy router is a core device in the energy internet and it connects all the devices together into a net structure and manages power flows among them. The research work presented in this paper described the energy router's structure and function expectations from the network perspective, and improved the existing energy router design. Open-shortest-path first (OSPF) protocol and virtual circuit switching mode are referenced from the Internet in the energy local area network (e-LAN) design. This paper proposed a design of an energy routing algorithm based on graph theory in an e-LAN. A lowest-cost routing selection algorithm is designed according to the features of power transmission, and a source selection and routing design algorithm is proposed for very heavy load conditions. Both algorithms have been verified by case analyses.

Index Terms—energy internet, energy router, routing algorithm, Smart Grid.

I. INTRODUCTION

In recent years, the increasing concern with the global energy shortages and environment problems has stimulated worldwide active research on the renewable energy sources, such as solar, wind and tide [1]-[4]. Because of their distributed, intermittent and fluctuated characteristics [5], [6], legacy grid cannot support these increased renewable sources effectively. Smart Grid with enhanced communication and sensing capabilities offers a suitable platform for exploiting the use of distributed renewable energy sources [7], [8]. In the Smart Grid, customers play both roles of the energy consumers and the energy producers [7]-[9], and power flows bidirectionally and flexibly end to end.

In the Smart Grid scenario, customers can exchange energy equally and freely, which is similar to the information exchange in the Internet. Based on this similarity, the concept 'energy internet' was proposed [10]-[12], which has been considered as a new development stage of the Smart Grid. It aims to increase the energy transmission efficiency and optimise the energy dispatching in time and space among renewable energy sources, energy storage units (ESUs) and load [12]. In a typical energy internet, all the devices are connected into a net structure by

energy routers [13]. According to the scale division of the Internet, a countrywide or worldwide large-scale energy wide area network (e-WAN) is divided into thousands of small-scale energy local area networks (e-LANs), such as a community or a campus, as shown in Fig.1. The energy router is a technological combination of power forwarding and information exchanges, and is the core device in the energy internet [14], [15].

For the community with renewable energy sources connected, the construction of e-LAN is especially valuable for the following three reasons [16]. Firstly, it can decrease the dependence on the main grid. Secondly, energy generated by renewable energy sources can be traded with other customers instead of storing for future use, which can reduce the start-up cost and energy storage devices size [7]. Thirdly, with properly designed energy routing, the optimised energy transmission and power dispatching can be achieved, which will reduce the energy losses. In the e-LAN, the design of the energy router and routing algorithm are two key factors, which determines the performance of the network.

The design of energy routers and energy routing algorithms have been proposed in some literatures. Future renewable electric energy delivery and management (FREEDM) system centre proposed the concept of energy router in [1], which can be considered as an integrated microgrid. In [1], research work mainly focused on the power electronic design of the energy router, such as the SSTs and the internal power control of energy routers. However, the output power of some ports is uncontrollable, and it did not mention the network forming and energy routing.

In [15] and [17]-[19], P. Yi *et al.* proposed an energy router deployed in an electric vehicles (EV) based energy internet. In this EV energy internet, EVs are responsible for transmitting, distributing, and storing energy from renewable energy sources to the places that need the energy. The energy router is defined as the charging station with battery, which can receive energy from one EV and forward energy to another. Based on this model, [15], [17] and [19] proposed the algorithms about energy routers placement, routing optimization especially in traffic jam, and multi-source shortest energy route algorithm in both ideal and realistic conditions. All these algorithms can be considered as generalized routing algorithms. However, the EV energy internet has some limitations. Firstly, it takes long time for energy transmission compared with power grid. Secondly, the charging stations and public buses need to add ESUs to satisfy the energy transmission requirement, which increases the cost and power consumption. Thirdly, all the generalized routing algorithms are subjected to the fixed public bus lines and traffic conditions.

In [12] a secure energy routing mechanism was proposed. Each house with its own renewable energy sources is considered as an

energy entity and connected with an energy router. Multiple energy routers are connected into a net structure, which is the energy internet. The mechanism is designed mainly for defending against major internal attacks against routing protocols, while the minimum energy losses based energy routing algorithm is inaccurate. Many details were not discussed, such as the structure and control of the energy router, power capacity of energy routers and power links, dynamic regulations of the network topology, routing information updating and exchange, etc.

According to the characteristics of power network, some unique requirements should be considered in energy router and routing algorithm design [20]. Firstly, the e-LAN contains diverse distributed power generations and storage devices, therefore the routing protocol should accommodate all of them. Besides, in the e-LAN, energy transmission is demand dominated, and for a certain load, the source is not specified. Also, to improve public energy security, the number of sources for a specific load should be as fewer as possible, to achieve higher reliability and robustness of the system. To address these requirement, this paper improves the existing energy router design [1] and proposes a lowest-cost routing algorithm based on graph theory [21].

In this paper, the community based e-LAN is proposed and it includes three types of devices: 1) renewable energy sources, such as PV and wind turbines, 2) ESUs, such as batteries and super capacitors, and 3) loads, such as lightings, household electric appliances and EVs. All these devices are connected together into a net structure by multiple energy routers, as shown in Fig.2. In the proposed e-LAN, any two devices can exchange energy via one or more energy routers and peer-to-peer energy service is achievable. In this work, the transmission voltage between energy routers is set dc 400V [22].

The energy router is responsible for energy forwarding and information exchange. The proposed energy router design is able to achieve controllable output power and power connections. Routing selection is critical since it can make the system work properly with high stability and efficiency. It also adopted

information routing protocols in the design of e-LAN, such as routing information protocol (RIP) and open shortest path first (OSPF). Common communication technologies will be used for the communication between energy routers, such as optical, power line communication (PLC), cellular communications, Bluetooth and cognitive radio [23]-[25], it will not be discussed in detail in this paper.

Because of its large power requirement, EV charging is a challenge not only for the legacy grid [26] but also for the e-LAN. According to the European EV charging standard IEC 61851, for private EV, the medium power charging can be up to 22kW [27], and thus it is likely that no single source in the e-LAN can power the EV. A routing algorithm is specially designed for this condition in this paper.

This paper is arranged as follows: Section II gives an overview of the improved energy routers and routing mode from the perspective of network. In Section III, the weighted energy routing algorithm is proposed and verified by case analysis. Finally, conclusions are given in Section IV.

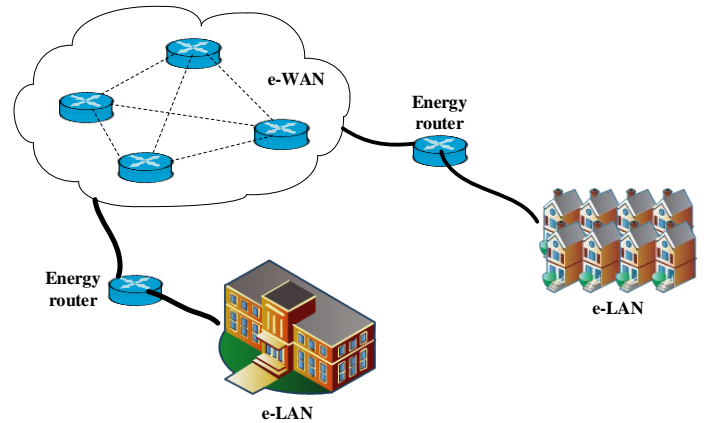

Fig.1 Scale division of the energy internet

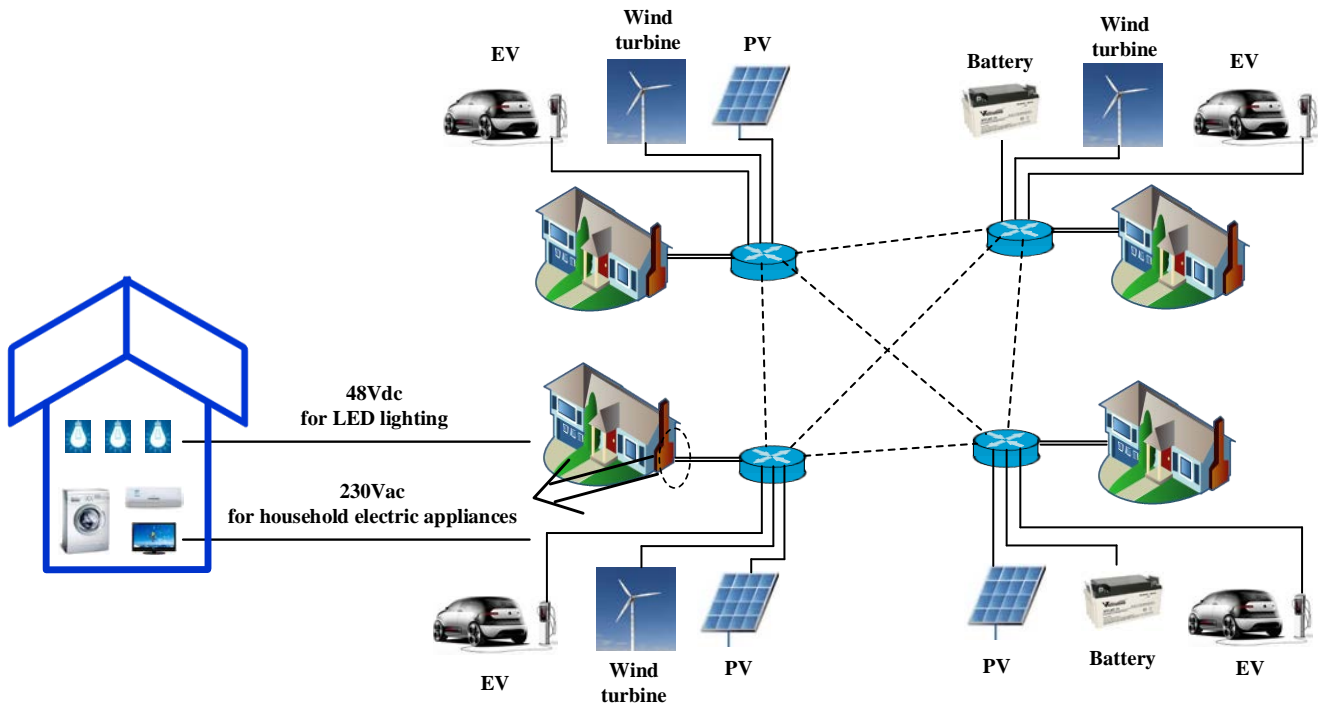

Fig.2 An example structure of the proposed e-LAN

II. AN OVERVIEW OF ENERGY ROUTERS FROM THE PERSPECTIVE OF NETWORK

The basic structure of the proposed energy router is shown in Fig.3. It is composed of a power exchange structure, several input/output ports and a controller, which is similar to the information router shown in Fig.4.

The exchange structure consists of a common power bus, an ESU and several converters. The 400V dc common power bus is the intermediate link of the energy forwarding and the ESU is for load balancing. It can absorb or compensate the power imbalance during a short period. Compared with the main grid, the power capacity of the ESU is much smaller, and thus the e-LAN has higher requirement on the speed of power adjustment of sources. It can be considered as a combination of memory-based and bus-based exchange structures [28] in the information router. The converters are the energy conversion unit. The input/output ports allow energy sources, ESUs, load and other energy routers to be connected.

As shown in Fig.3, the ports are divided into two categories: devices connected ports (shown on the left side) and energy routers connected ports (shown on the right side). On the left side, the upper four ports are specially designed for renewable energy sources, EV and ESU, while the two on the bottom are for normal load: ac 230V (taking an example of the European standard, and for other countries, the voltage level and frequency can be designed according to their own standards) supplies household electric appliances and dc 48V supplies LED lightings. On the right side, the upper set are input ports, the middle set are the input/output multiplexing ports and the bottom set are the output ports. The DC-DC converters in the shadow are aimed at controlling the output power, which is the main improvement compared with the energy router proposed in [1]. Since all the output power is controllable, routing algorithm can be adopted to accurately control the power flow. For the input/output multiplexing port, the DC-DC converter can be bypassed when the port acts as an input port. The routing controller includes a micro-processor and a communication module.

The proposed energy router has the following two functions.

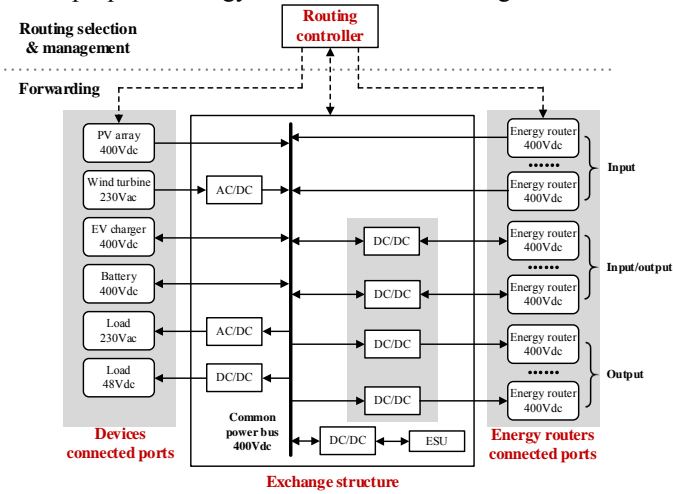

Fig.3 Proposed structure of the energy router

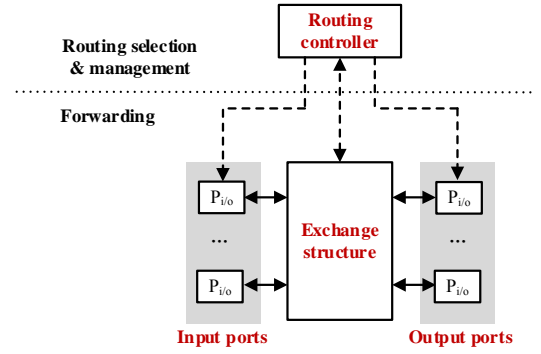

Fig.4 Basic structure of the information router

A. Condition monitoring

During the power conversion and transmission process, overflow, voltage mismatch and current overshoot, etc. may cause system crash and even safety accidents. Therefore, energy exchange has much higher requirement on safety and reliability than information exchange. Before the energy source is connected to the system, strict input voltage check is carried out to avoid damaging the energy router's internal hardware. So high voltage sensors and switches are put at each input port to monitor and control the input voltage at all times. When there is a power flow connection request, the controller checks the input voltage. If the voltage matches the expected level and form, the high voltage switch at the input port is switched on and the power is allowed to flow in. Otherwise, the energy is blocked outside the energy router. At the output ports, high voltage sensors and switches are also needed for output voltage checking and regulating. Power with voltage not matching the expected level or form is not allowed to flow out.

The exchange structure is the core hardware of the energy router and it is responsible for energy forwarding and conversion. For information routers, overflow may cause large time delay and data packets lost. While for the energy routers, energy overflow may cause much more serious consequences, such as overheating (lead to the efficiency decrease), device destroying, or even the crash of the whole energy router. To avoid these problems, the power values of converters and ports should be real-time monitored.

B. Information exchange and routing design

In an e-LAN, dynamic routing algorithm should be employed to adapt to the change of the network topology and frequent connect/disconnect of devices. OSPF protocol, a widely used information exchange method in the Internet [28], is referenced to the e-LAN design in this paper. Each energy router floods the connections and power status information of itself, directly connected devices and power links to other energy routers [28], so that all the energy routers acquire the whole network connections and energy status information of the e-LAN. When the connections or the power status have changed, the directly connected energy router floods the update to all the others. The power status information of all the devices, power links and energy routers in the e-LAN is contained in three power information tables and stored in every energy router. An example is shown in Table I to Table III. In these tables, P_{total} and P_{left} refer to the total power capacity and the left power capacity of the corresponding ports and eff is the efficiency of renewable energy sources. In Table II, eff is the power conversion efficiency of the power electronic converter in the corresponding port. In Table III,

r is the power link impedance and V_{trans} is the transmission voltage in the corresponding power link. Based on the equivalent digraph of the e-LAN, each energy router executes the graph traversal algorithm to find out all the possible power transmission paths from other energy routers to itself for the following routing calculation. This process repeats when the equivalent digraph changes.

In the Internet, information is actively sent by source hosts and transmits to the destination hosts via the lowest-cost path which is stored in the routing table. However, in the energy internet, energy transmission is demand dominated and the source is not specified. Also, the cost is disproportional to the added power value (it will be discussed in detail in next section). Therefore, every time a load is connected, a message about its power demand is sent to the directly connected energy router. Besides, table checking routing selection mode is not suitable in the e-LAN. The routing selection algorithm proposed in this paper is carried out in every energy router based on the local power information tables and then one or more sources with related paths are arranged to power the load.

TABLE I
DEVICES RELATED POWER INFORMATION TABLE

Device	P_{total}/kW	P_{left}/kW	eff
D_1	6.0	5.5	0.96
D_2	12.0	9.2	0.95
D_3	5.0	4.0	---
D_4	14.0	10.9	0.96
D_5	22.0	22.0	---

TABLE II
ENERGY ROUTERS RELATED POWER INFORMATION TABLE

Router	Port	P_{total}/kW	P_{left}/kW	eff
R_1	R_{1a}	20.0	19.5	1
	R_{1b}	15.0	9.0	0.98
R_2	R_{2a}	15.0	12.2	0.97
	R_{2b}	15.0	14.0	0.98
	R_{2c}	15.0	13.0	0.98
R_3	R_{3a}	18.0	12.0	1
	R_{3b}	15.0	14.0	0.98
	R_{3c}	15.0	15.0	1
R_4	R_{4a}	15.0	9.0	0.98
	R_{4b}	10.0	9.0	1
R_5	R_{5a}	15.0	13.0	1
	R_{5b}	18.0	12.0	0.98
	R_{5c}	15.0	15.0	1
R_6	R_{6a}	20.0	20.0	0.98
	R_{6b}	20.0	20.0	1
	P_{6c}	18.0	18.0	1
R_7	R_{7a}	25.0	25.0	1
	R_{7b}	20.0	20.0	1
	R_{7c}	25.0	23.0	1
	R_{7d}	25.0	25.0	1
R_8	R_{8a}	20.0	18.0	0.98
	R_{8b}	20.0	20.0	1
	R_{8c}	18.0	12.0	0.98
R_9	R_{9a}	20.0	14.0	0.98
	R_{9b}	20.0	16.9	1

TABLE III
POWER LINKS RELATED POWER INFORMATION TABLE

Power Link	P_{total}/kW	P_{left}/kW	r/Ω	V_{trans}/V
$L_{1,3}$	30	24	0.6	400dc
$L_{2,3}$	20	19	0.64	400dc
$L_{2,5}$	20	20	0.51	400dc
$L_{3,7}$	45	45	0.94	400dc
$L_{4,5}$	24	18	0.19	400dc
$L_{5,6}$	20	20	0.45	400dc
$L_{6,7}$	40	40	0.24	400dc

$L_{8,9}$	32	26	0.6	400dc
$L_{6,8}$	30	30	0.21	400dc
$L_{7,8}$	30	30	0.21	400dc

On the network layer of the Internet, two packet switching modes can be employed: virtual circuit and datagram [28]. Virtual circuit provides connected and reliable service. In this mode, a virtual circuit is set up from source to destination since the start of the communication and lasts until the end of the communication. For an end-to-end packet delivery, routing selection is carried out only once before data delivery and the path cannot be further optimised during data delivery process even if the network state is changed. Datagram network provides disconnected service. Sending data is divided into multiple data packets and each packet chooses its own paths separately according to current state of the network. It is more flexible, efficient and reliable. In the Internet, usually datagram network is adopted. However, in the e-LAN, virtual circuit is a better choice for the following two reasons: 1) For datagram mode, every time the path is changed, the related converters along the old path will shut down and the converters along the new path will start up. Such frequent startup and shutdown will cause additional power losses and deteriorate the reliability and robustness of the e-LAN. 2) Compared with datagram mode, a great disadvantage of virtual circuit mode is lower utilizations of data links. However, during energy transmission, when a load is connected, the energy transmission is usually continuous, until it is disconnected. In another word, this virtual circuit is always engaged during energy transmission process, which promises high utilization efficiency. As a result, virtual circuit mode is employed in the e-LAN.

III. PROPOSED ROUTING ALGORITHM

Graph theory [21] is employed to describe the energy routing selection problem. The proposed e-LAN shown in Fig.5(a) is equivalent to the digraph as shown in Fig.5(b). All the energy routers constitute the set of nodes $R = \{R_1, R_2, \dots, R_n\}$ and all the power links constitute the set of edges $L = \{L_{i,j}, \dots\}$ ($L_{i,j}$ is the power link connecting energy router R_i and R_j). The direction of the edge represents the energy flowing direction, and it is from an energy router's output port to an input port. The possible transmission path from source A to destination B is expressed as:

$$path(A \rightarrow B) := A \equiv R_i, R_j, \dots, R_k \equiv B \quad (1)$$

R_i, R_j, \dots, R_k are the energy routers along this path.

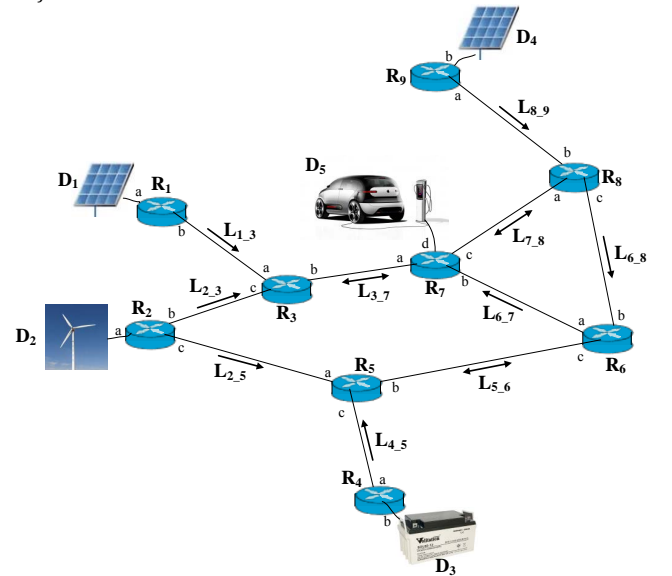

(a) Part of an e-LAN

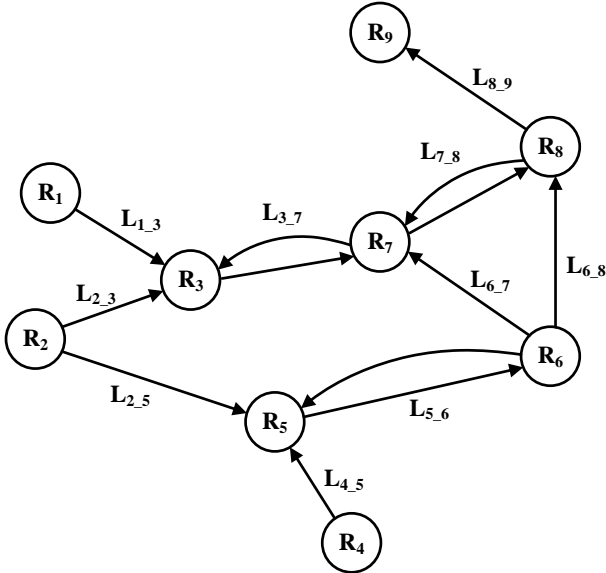

(b) The equivalent digraph of the e-LAN
Fig. 5 An example of an e-LAN and its equivalent digraph

A. Weighted routing algorithm

In practical applications, the total cost of transmission and conversion involves multiple factors, such as power losses and prices, therefore, it is necessary to assign weight to every edge and node according to its cost. In this paper, we mainly focus on the power losses and other factors will be considered in the future study of this project. Define W_i as the weight of energy router R_i and $W_{i,j}$ as the weight of the link $L_{i,j}$. To give priority to those energy routers and power links with smaller losses, the weight should be proportional to the added power losses Δp , as shown in (2) and (3).

$$W_i = k_{node} \Delta p_i \quad (2)$$

$$W_{i,j} = k_{edge} \Delta p_{i,j} \quad (3)$$

k_{node} and k_{edge} are two adjustable coefficients and in this paper they are defined as $k_{node} = k_{edge} = 1$.

The energy losses in an energy router are composed of the power conversion losses and power cable transmission losses inside the energy router. The later can be ignored since the power cables inside the energy routers are very short. The conversion losses of an energy router are not a fixed value, but decided by the converters at the ports through which the power flows. The weight of port x of energy router R_i is expressed as:

$$W_{ix} = k_{node} (1 - eff_{ix}) \Delta P_{ix} \quad (4)$$

where ΔP_{ix} is the added power value through port x of energy router R_i , and eff_{ix} is the efficiency of the electronic power converter between port x and the common power bus (if there is no converter, then $eff_{ix}=1$). For simplicity, the efficiency of a converter is considered as a constant measured under the rated power, and thus the conversion losses are linearly proportional to the converted power approximately. The total power losses of an energy router are expressed as (port x is the input port and port y is the output port):

$$W_i = k_{node} ((1 - eff_{ix}) + (1 - eff_{iy})) \Delta P_i \quad (5)$$

The total power losses in a power link between energy router R_i and R_j are calculated as:

$$p_{i,j} = \frac{r_{i,j}}{V_{i,j}^2} P_{i,j}^2 \quad (6)$$

$P_{i,j}$ is the power transmitting in the link. For added power $\Delta P_{i,j}$, the link weight is:

$$W_{i,j} = k_{edge} \frac{r_{i,j}}{V_{i,j}^2} ((\Delta P_{i,j} + P_{i,j})^2 - P_{i,j}^2), \quad (7)$$

where $r_{i,j}$ is the link resistance, $V_{i,j}$ is the link voltage, $P_{i,j}$ is the already existing power in the link, which can be found in the power links related power information table, and $\Delta P_{i,j}$ is the added power. It can be seen from (7) that for power transmission, the power losses are not a linear superposition. As shown in Fig. 6, the added power losses Δp caused by the same added power ΔP are increasing with the increase of the existing power in the power link. As a result, the weight of power links is variable according to the existing power and the added power. The total cost is the sum of all the nodes' and edges' weights along the power transmission path, as shown in (8):

$$C = \sum W_i + \sum W_{i,j}, \quad (8)$$

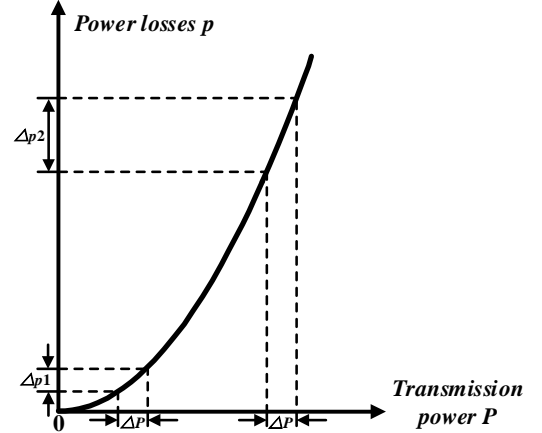

Fig. 6 Function graph of power link losses with respect to the transmission power

A Matlab based case analysis is carried out to verify the proposed weighted routing algorithm and a comparison is made with the existing energy routing algorithm. Part of an e-LAN topology is shown in Fig. 7 and Table IV shows the parameters. It is assumed that the left power capacities of each device, power link and energy router's ports are large enough. Two optional paths from source D_1 to load D_2 are found out after graph traversal:

$$Path1(D_1 \rightarrow D_2) := D_1 \equiv R_1, R_2, R_3, R_5 \equiv D_2, \quad (9)$$

$$Path2(D_1 \rightarrow D_2) := D_1 \equiv R_1, R_4, R_5 \equiv D_2, \quad (10)$$

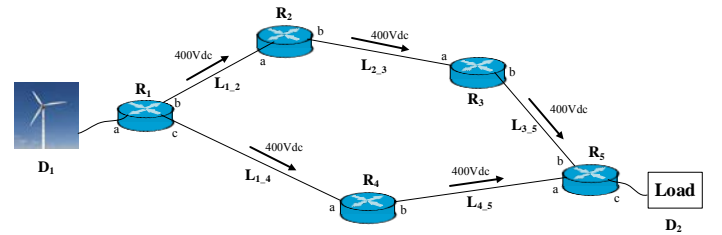

Fig. 7 Part of an e-LAN

TABLE IV
PARAMETERS OF THE E-LAN TOPOLOGY

Device		<i>eff</i>
D ₁		0.95
D ₂		---
Router	Port	<i>eff</i>
R ₁	P _a	0.97
	P _b	0.98
	P _c	0.98
R ₂	P _a	1
	P _b	0.98
R ₃	P _a	1
	P _b	0.98
R ₄	P _a	1

	P_b		0.98	
R_5	P_a		1	
	P_b		1	
	P_c		1	
Power Link	P_{total}/kW	P_{left}/kW	r/Ω	V_{trans}/V
$L_{1,2}$	20.0	13.5	0.28	400dc
$L_{2,3}$	20.0	17.0	0.1	400dc
$L_{3,5}$	20.0	18.0	0.56	400dc
$L_{1,4}$	20.0	20.0	0.83	400dc
$L_{4,5}$	20.0	20.0	0.76	400dc

According to the analysis before, the routing selection is related not only to the power links' impedance, but also to the existing power in the power links and the power of load. As a result, 3 cases are analysed. In case #1 and #2, it is assumed that currently no power exists in the network and the rated power of the load are 2kW and 10kW, respectively. In case #3, the existing power values are shown in Table IV and the load power is 10 kW. The calculation result is shown in Fig.8 and Fig.9. Fig.8 shows the result of case #1 and #2, in which the solid line represents the cost of path1 and the dotted line represents the cost of path2. From the graph it can be seen that for the 2kW load, path2 has lower cost while for the 10kW load, path1 is a better choice. Fig.9 shows the calculation result of case #3. It can be found that with the existing power of the network changed, the total cost is increased. Compared with case #2, the load power remains the same, but the cost of path2 is now lower than path1 and thus path2 is selected as the energy transmission path.

According to the existing energy routing algorithm in [12], the energy sharing efficiency between D_1 and D_2 is $\eta_1 = 0.88$ via path1 and $\eta_2 = 0.81$ via path2. Therefore, path1 is adopted as the energy transmission path in all the three cases. In case #1 and #3, the power losses in path1 are about 14% more than in path2, which shows the advantages of the proposed energy routing algorithm than the existing routing algorithm [12].

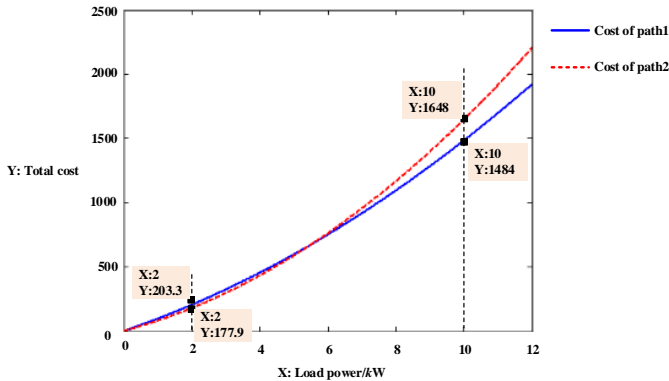

Fig.8 Matlab calculation result of case #1 and case #2

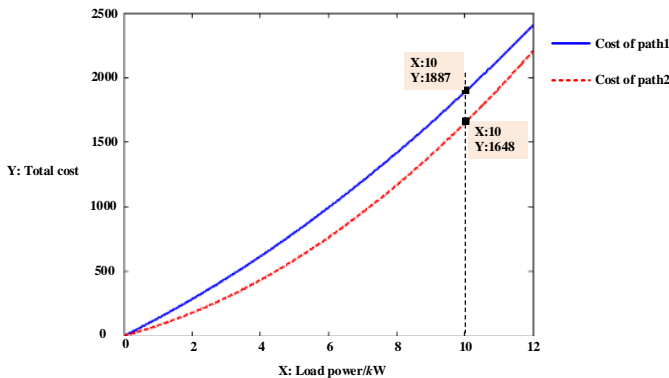
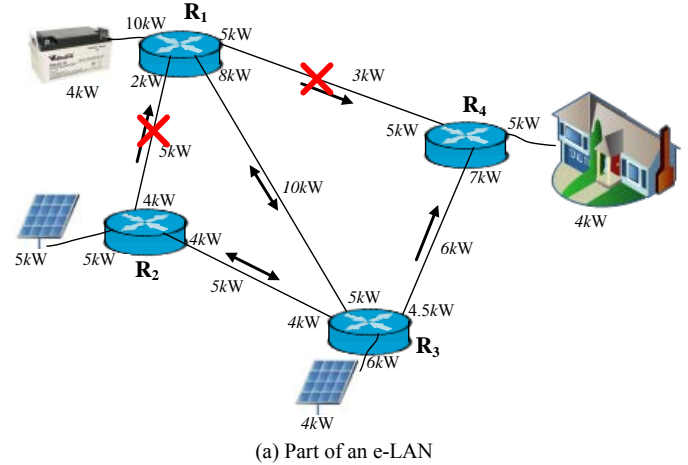
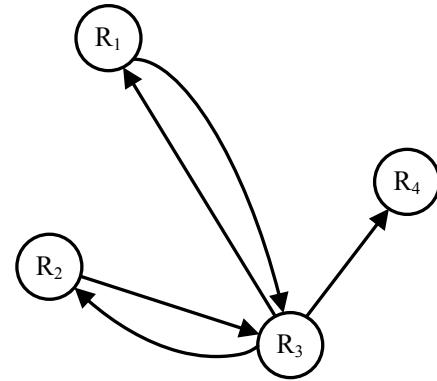

Fig.9 Matlab calculation result of case #3

For high power conditions and some critical links, over-flow often occurs. To avoid this problem, a screening process is required to firstly find out all the power links and energy routers' ports meeting the rate of the power demand. Others are deleted from the digraph and graph traversal is carried out based on the new digraph. As shown in Fig.10(a), the house needs the power of 6kW. The red cross marked power links are deleted since they, as well as directly connected ports, don't meet the power rate. The new digraph is shown in Fig.10(b).



(a) Part of an e-LAN



(b) The equivalent digraph after edge deletion

Fig.10 An example of edge deletion based on power constraints

For some low power and short distance transmission occasions with fast response requirement, the non-linear superposition problem and over-flow can be neglected. As a result, the weights of all the energy routers' ports and power links are proportional to the added power. In this case, power information tables are not needed, instead, in each energy router, the lowest-cost path from all the other energy routers are calculated and stored in a routing table. Therefore, the transmission path can be arranged immediately after the power demand appears. The energy routing table is updated only when the network connections are changed.

B. EV charging represented very heavy load

For a very heavy load, such as charging an EV, there may be no single energy source in the e-LAN that can supply the power to charge an EV. Therefore, according to the algorithm discussed in last section, no suitable source is found after screening, and thus more than one sources should be selected to power the load together. In this case, a source selection and power allocation algorithm is needed.

In the e-LAN, in order to decrease the complexity of energy routing selection and increase the reliability and robustness of the system, the scheme involving fewer sources is preferred. For a very heavy load, if no single source can power it, then the proposed routing algorithm will try to find whether there are two sources can power the load together. The number of sources will be gradually increased until the total output power meet the power rate of the load. Assume that there are totally N sources in the e-LAN and at least n sources are required to power the load, the number of sources combination sets are calculated as:

$$Q_n = C_N^n = \frac{N!}{n!(N-n)!}, \quad (11)$$

Among Q_n sets, assume there are m combination sets meeting the power rate and they are:

$$\begin{bmatrix} \text{set \#1} \\ \text{set \#2} \\ \dots \\ \text{set \#m} \end{bmatrix}_{m \times 1} = \begin{bmatrix} s_{11} & s_{12} & \dots & s_{1n} \\ s_{21} & s_{22} & \dots & s_{2n} \\ \dots & \dots & \dots & \dots \\ s_{m1} & s_{m2} & \dots & s_{mn} \end{bmatrix}_{m \times n}, \quad (12)$$

where s_{xy} is the y -th source in the combination set $\#x$. For the convenience of description, all the sources and energy routers are renumbered in the algorithm. In each sources combination set, sources are renumbered as $y=1, \dots, n$, paths from source to the load are renumbered as $k=1, \dots, K_y$, and energy routers along each path are renumbered as $i=1, \dots, I_{k,y}$. Along each path, the input ports of energy routers are defined as port a and the output ports are defined as port b . A digraph traversal is carried out to find out all the possible paths from these sources in the above matrix to the load. For a sources combination set $\#x$, the added power generated by each source is ΔP_y ($y=1, 2, \dots, n$) and the total added power is $\Delta P_{total} = \sum_{y=1}^n P_y$. As mentioned before, the total power losses in a path are related to the existing power and the added power. As a result, the total cost of set $\#x$ C_x is a function of the added power allocation among each path.

Routing algorithm for very heavy load

```

C_x = 0 //Initialization of C_x
for y = 1 to n do //from source 1 to source n
  for k = 1 to K_y do //from path 1 to path K_y
    for i = 1 to (I_{y,k} - 1) do //from router 1 to router (I_{y,k} - 1)
      C_x += k_{edge} \frac{r_{y,k,i,i+1}}{V_{y,k,i,i+1}^2} ((\Delta P_y + P_{y,k,i,i+1})^2 - P_{y,k,i,i+1}^2) +
      k_{node} ((1 - eff_{ia}) + (1 - eff_{ib})) \Delta P_y;
    end for
    i = I_{y,k};
    C_x += k_{node} ((1 - eff_{ia}) + (1 - eff_{ib})) \Delta P_y;
  end for
end for

```

In the algorithm, ΔP_y is the power generated by the y -th source. $P_{y,k,i,i+1}$ is the current power value of the corresponding power link, $V_{y,k,i,i+1}$ is the link voltage and $r_{y,k,i,i+1}$ is the link resistance. ΔP_y should be carefully selected so that the minimum value $C_{x,min}$ can be achieved. The lowest total cost is calculated as:

$$C_{min} = \min_{x=1,2,\dots,m} C_{x,min}. \quad (13)$$

A case analysis in Matlab and a simulation based on Simulink are carried out to verify the feasibility of the proposed routing algorithm for the very heavy load condition. The e-LAN topology is shown in Fig.5 and Table I to III show the parameters before renumbered. The rated charging power of the EV is set as 22kW according to the European EV charging standard IEC 61851, and thus it needs at least three sources to power it together. There are two possible sources combination sets as shown below:

$$\begin{bmatrix} \text{set \#1} \\ \text{set \#2} \end{bmatrix}_{2 \times 1} = \begin{bmatrix} s_{11} & s_{12} & s_{13} \\ s_{21} & s_{22} & s_{23} \end{bmatrix}_{2 \times 3} = \begin{bmatrix} D_1 & D_2 & D_4 \\ D_2 & D_3 & D_4 \end{bmatrix}_{2 \times 3}. \quad (14)$$

Considering set #1, for source D_1 , there is only one path to the destination D_5 :

$$\text{Path}(D_1 \rightarrow D_5) := D_1 \equiv R_1, R_3, R_7 \equiv D_5, \quad (15)$$

For sources D_2 and D_4 , there are two paths, respectively:

$$\text{Path1}(D_2 \rightarrow D_5) := D_2 \equiv R_2, R_3, R_7 \equiv D_5, \quad (16)$$

$$\text{Path2}(D_2 \rightarrow D_5) := D_2 \equiv R_2, R_5, R_6, R_7 \equiv D_5, \quad (17)$$

$$\text{Path1}(D_4 \rightarrow D_5) := D_4 \equiv R_9, R_8, R_6, R_7 \equiv D_5, \quad (18)$$

$$\text{Path2}(D_4 \rightarrow D_5) := D_4 \equiv R_9, R_8, R_7 \equiv D_5. \quad (19)$$

According to the routing algorithm for very heavy load, the total cost of set #1 C_1 is a function of the added power allocation from the three sources and the function graph is shown in Fig.11. According to the power limitation of sources, power links and energy routers' ports in each path, there are constraint conditions as shown below:

$$\begin{cases} 0 < \Delta P_1 \leq 5.5 \\ 0 < \Delta P_2 \leq 9.2 \\ \Delta P_1 + \Delta P_2 \geq 11.1 \end{cases}. \quad (20)$$

Then the power allocation with the lowest cost is shown in Fig.11 and the corresponding transmission paths are:

$$\begin{cases} \Delta P_1 = 5.5 \text{ kW} & \text{Path}(D_1 \rightarrow D_5) := D_1 \equiv R_1, R_3, R_7 \equiv D_5 \\ \Delta P_2 = 6.44 \text{ kW} & \text{Path}(D_2 \rightarrow D_5) := D_2 \equiv R_2, R_5, R_6, R_7 \equiv D_5, \\ \Delta P_4 = 10.06 \text{ kW} & \text{Path}(D_4 \rightarrow D_5) := D_4 \equiv R_9, R_8, R_7 \equiv D_5 \end{cases} \quad (21)$$

The total cost $C_{1,min} = 3673$.

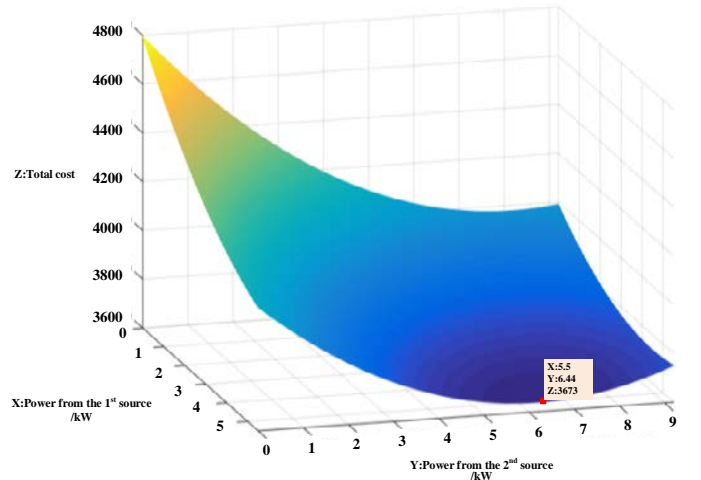

Fig.11 Function graph of the total cost of sources combination set #1

A simulation is carried out in Simulink to further verify the proposed energy routing algorithm. The simulation diagram is shown in Fig. 12. The energy router is modelled by a controllable current source and the power conversion efficiency is regulated by an adjustable constant. The power link is equivalent as a lumped parameter model of a resistor. Fig.13 shows the simulation result, in which the waveform above is the power generated by the sources, and the waveform below is the total cost during transmission and conversion. It can be seen that the total cost is about 3672, and it approximately matches with the calculation result $C_{1,min} = 3673$.

Similar calculation process and simulation are carried out on set #2 and the lowest cost power allocation and corresponding transmission paths are:

$$\begin{cases} \Delta P_2 = 7.1 \text{ kW} & \text{Path}(D_2 \rightarrow D_5) := D_1 \equiv R_2, R_5, R_6, R_7 \equiv D_5 \\ \Delta P_3 = 4.0 \text{ kW} & \text{Path}(D_3 \rightarrow D_5) := D_3 \equiv R_4, R_5, R_6, R_7 \equiv D_5 \\ \Delta P_4 = 10.9 \text{ kW} & \text{Path}(D_4 \rightarrow D_5) := D_4 \equiv R_9, R_8, R_7 \equiv D_5 \end{cases} \quad (22),$$

The total cost $C_{2,min} = 3452$. According to (13), the lowest cost is:

$$C_{min} = \min_{x=1,2} \{C_{1,min}, C_{2,min}\} = C_{2,min} = 3452. \quad (23)$$

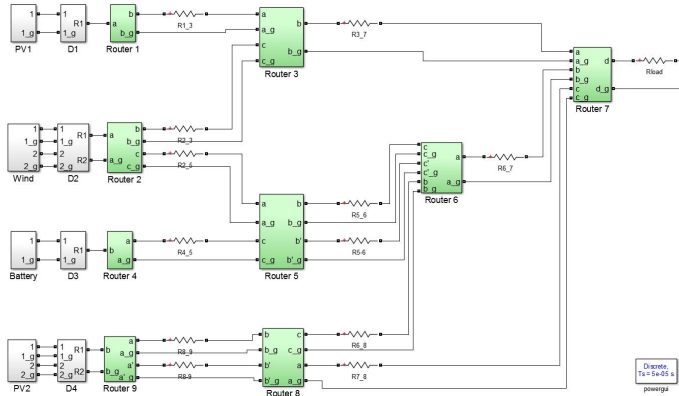

Fig. 12 The Simulink diagram of the e-LAN

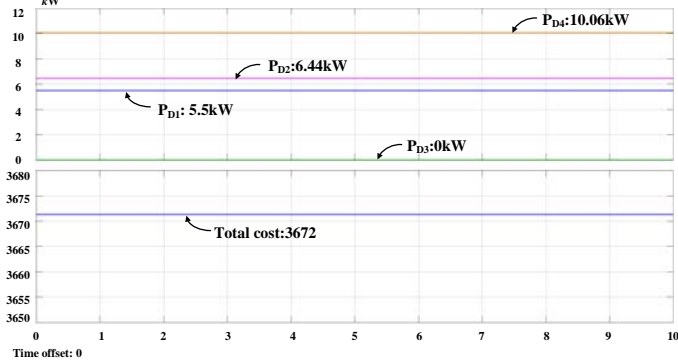

Fig. 13 The simulation result of the e-LAN

In the analysis, two sources combination sets with three sources respectively, are screened out. For each combination set, the total cost is expressed as a 3-D function with respect to the added power allocations. For the combination set with more sources, the function with more dimensions can be achieved. Then according to the routing algorithm for very heavy load and (13), the lowest-cost sources combination set with corresponding paths are finally adopted.

According to the existing energy routing algorithm in [12], the power transmission paths should be:

$$\begin{cases} \Delta P_1 = 1.9kW & Path(D_1 \rightarrow D_5) := D_1 \equiv R_1, R_3, R_7 \equiv D_5 \\ \Delta P_2 = 9.2kW & Path(D_2 \rightarrow D_5) := D_3 \equiv R_2, R_3, R_7 \equiv D_5, \\ \Delta P_4 = 10.9kW & Path(D_4 \rightarrow D_5) := D_4 \equiv R_9, R_8, R_7 \equiv D_5 \end{cases} \quad (24)$$

The total cost is $C = 3821$, which is 10.7% more than the that adopting the proposed energy routing algorithm.

In this case, the routing calculation costs much more time than the low power load condition. However, for EVs represented very heavy load, they do not have a very strict requirement on response time when plugged in. Besides, for safety consideration, when an EV is plugged in, multiple checks and confirmations are required, which offers enough time for routing calculation.

C. Renewable energy sources first

When the e-LAN is connected to the grid by energy routers, load has one more choice to fetch energy from the grid. Renewable energy sources in the e-LAN have much more advantages than fossil fuels and thus they are preferred to be used. To give priority to the renewable energy sources, such as PV and wind turbines, the weight of the energy routers' port a connected with these renewable energy sources should decrease, as shown below:

$$W_{ia} = k_{node}(1 - eff_{ia})P_i\alpha. \quad (25)$$

In the equation above, α is an adjustable coefficient and $0 < \alpha < 1$. For all the renewable energy sources, α can be the same, or it

can be designed according to the using priority level of different sources.

IV. CONCLUSION

This paper proposed an improved design of the energy router and designed a weighted routing algorithm adopted in an e-LAN. The structure of the proposed energy router is similar to the information router for the Internet, and it is responsible for energy transmission and conversion. The energy router's ports and exchange structure can be monitored all the time for safety and reliability consideration. Virtual circuit mode is adopted for energy exchange among energy routers in an e-LAN, which is more reliable and robust than datagram mode, especially for high power conditions. Power information tables are required to store the power information about all the devices, energy routers and power links. When load is connected, the proposed weighted routing algorithm is carried out by the directly connected energy router to arrange a lowest-cost power transmission path for the load. For very heavy load such as EVs, it is likely that more than one sources are required to supply the load together. In this case, the weighted routing algorithm is proposed, so that the lowest-cost power transmission with the fewest sources is achieved. Case analysis based on Matlab and simulations based on Simulink are carried out to verify the feasibility of the proposed routing algorithm. In the condition when the e-LAN is connected to the grid, an adjustable coefficient α is introduced to the weight calculation equation to give priority to the renewable energy sources.

The future work will include: 1) Further design of the energy router from the perspective of electricity, such as the power rate and the design of converters; 2) Adopting protection strategies to deal with fault conditions so that the system can be more stable and robust; 3) Further optimising the routing algorithm with more cost factors considered, to improve the accuracy and calculation performance.

REFERENCE

- [1] Y. Xu, J. Zhang, W. Wang, A. Juneja, and S. Bhattacharys, "Energy router: architectures and functionalities toward energy internet," presented at the IEEE Int. Conf. Smart Grid Communications (SmartGridComm), Oct. 2011.
- [2] D. Chen, A. Q. Huang, Y. Xu, F. Wang, and W. Yu, "Distributed and autonomous control of the FREEDM system: a power electronics based distributed system," presented at the IEEE 40th Int. Conf. IECON, Oct.-Nov. 2014.
- [3] A. Q. Huang, and J. Baliga, "FREEDM system: role of power electronics and power semiconductors in developing an energy internet," presented at the IEEE 21st Int. Sym. Power Semiconductor Devices & IC's, June 2009.
- [4] G. Zhabelova, V. Vyatkin, and V. N. Dubinin, "Toward industrially usable agent technology for smart grid automation," *IEEE Trans. Industrial Electronics*, vol. 62, no. 4, pp. 2629-2641, Apr. 2015.
- [5] T. Sauter, and M. Lobashov, "End-to-end communication architecture for smart grids," *IEEE Trans. Industrial Electronics*, vol. 58, no. 4, pp. 1218-1228, Apr. 2011.
- [6] S. Park, J. Lee, G. Hwang, and J. K. Choi, "Contribution-based energy-trading mechanism in microgrids for future smart grid: a game theoretic approach," *IEEE Trans. Industrial Electronics*, vol. 63, no. 7, pp. 4255-4265, July 2016.
- [7] W. Tushar, B. Chai, C. Yuen, D. B. Smith, K. L. Wood, Z. Yang, and H. V. Poor, "Three-party energy management with distributed energy resources in smart grid," *IEEE Trans. Industrial Electronics*, vol. 62, no. 4, pp. 2487-2498, Apr. 2015.
- [8] C. Tham, and T. Luo, "Sensing-driven energy purchasing in smart grid cyber-physical system," *IEEE Trans. Systems, Man, and Cybernetics*, vol. 43, no. 4, pp. 773-784, July 2013.
- [9] L. A. Barroso, H. Rudnick, F. Sensfuss, and P. Linares, "The Green Effect," *IEEE Power and Energy Mag.*, vol. 8, no. 5, pp. 22-35, Sept. 2010.

- [10] J. Zhang, W. Wang, and S. Bhattacharys, "Architecture of solid state transformer-based energy router and models of energy traffic," presented at the IEEE Int. Conf. Innovative Smart Grid Technologies (ISGT), Jan. 2012.
- [11] A. Q. Huang, M. L. Crow, G. T. Heydt, J. P. Zheng, and S. J. Dale, "The future renewable electric energy delivery and management (FREEDM) system: the energy internet," *Proceedings of IEEE*, vol. 99, no. 1, pp. 133-148, Nov. 2010.
- [12] T. Zhu, S. Xiao, Y. Ping, D. Towsley, and W. Gong, "A secure energy routing mechanism for sharing renewable energy in smart microgrid," presented at the IEEE Int. Conf. Smart Grid Communication (SmartGridComm), Oct. 2011.
- [13] J. Miao, N. Zhang, and C. Kang, "Generalized steady-state model for energy router with applications in power flow calculation," presented at the IEEE Int. Conf. Power and Energy Society General Meeting (PESGM), July 2016.
- [14] H. Guo, F. Wang, J. Luo, and L. Zhang, "Review of energy routers applied for the energy internet integrating renewable energy," presented at the IEEE 8th Int. Conf. Power Electronics and Motion Control Conference (IPEMC-ECCE Asia), May, 2016.
- [15] P. Yi, T. Zhu, B. Jiang, R. Jin, and B. Wang, "Deploying energy routers in an energy internet based on electric vehicles," *IEEE Trans. Vehicular Technology*, vol. 65, no. 6, pp. 4714-4725, June 2016.
- [16] L. Hao, and L. Weiding, "Future energy system in low-carbon community-energy internet," presented at the IEEE Int. Conf. Computer Distributed Control and Intelligent Environmental Monitoring (CDCIEM), Feb. 2011.
- [17] P. Yi, T. Zhu, G. Lin, and Q. Zhang, "Routing renewable energy using electric vehicles in mobile electrical grid," presented at the IEEE 10th Int. Conf. Mobile Ad-Hoc and Sensor Systems (MASS), Oct. 2013.
- [18] P. Yi, T. Zhu, B. Jiang, B. Wang, and D. Towsley, "An energy transmission and distribution network using electric vehicles," presented at the IEEE Int. Conf. Communications (ICC), June, 2012.
- [19] P. Yi, Y. Tang, Y. Hong, Y. Shen, T. Zhu, Q. Zhang, and M. M. Begovic, "Renewable energy transmission through multiple routes in a mobile electrical grid," presented at the IEEE PES Int. Conf. Innovative Smart Grid Technologies Conference (ISGT), Feb. 2014.
- [20] S. Temel, V. C. Gungor and T. Koçak, "Routing protocol design guidelines for smart grid environments," *Journal. Computer Networks*, vol. 60, pp. 160-170, Feb. 2014.
- [21] M. Cannataro, and P. H. Guzzi, "Graph theory and applications," Wiley-IEEE Press, 2012.
- [22] T. Dragičević, X. Lu, J. C. Vasquez, and J. M. Guerrero, "DC microgrids-part I: a review of control strategies and stabilization techniques," *IEEE Trans. Power Electronics*, vol. 31, no. 7, July 2016.
- [23] G. A. Shah, V. C. Gungor, and O. B. Akan, "A cross-layer QoS-aware communication framework in cognitive radio sensor networks for smart grid applications," *IEEE Trans. Industrial Informatics*, vol. 9, no. 3, pp. 1477-1485, Aug. 2013.
- [24] D. Niyato, P. Wang, and E. Hossain, "Reliability analysis and redundancy design of smart grid wireless communications system for demand side management," *IEEE Trans. Wireless Communications*, vol. 19, no. 3, pp. 1536-1284, July 2012.
- [25] M. H. Rehmani, M. E. Kantarci, A. Rachedi, M. Radenkovic, and M. Reisslein, "Smart grids: a hub of interdisciplinary research," *IEEE Access*, Vol. 3, pp. 3114-3118, 2015.
- [26] J. Zhang, Q. Zhou, M. Li, and H. Long, "Research on large scale EV charging optimization strategy," presented at the IEEE Int. Conf. Power System Technology (POWERCON), Sept.-Oct. 2016.
- [27] M. C. Falvo, D. Sbordone, I. S. Bayram, and M. Devetsikiotis, "EV Charging stations and modes: international standards," presented at the IEEE Int. Symposium Power Electronics, Electrical Drives, Automation and Motion (SPEEDAM), June 2014.
- [28] P. K. Sinha, "Computer networks", Wiley-IEEE Press, 1997.



Jiande Wu (M'11) was born in Zhejiang, China, in 1973. He received the B.Sc., M.Sc. and Ph.D. degree from the College of Electrical Engineering, Zhejiang University, Hangzhou, China, in 1994, 1997 and 2012, respectively. Since 1997, he has been a faculty member at Zhejiang University, where he is currently an associate professor. From 2013 to 2014, he was an academic visitor at the University of Strathclyde, Glasgow, U.K. His research interests include power electronics control, distributed power electronics system and fieldbus communication.



Zhongnan Qian received the B.Sc. degree in electrical engineering from Zhejiang University, Hangzhou, China, in 2014. He is currently working toward the Ph.D. degree in Electrical Engineering at Zhejiang University. His current research interests include wireless power transfer and communication techniques applied in power electronics.



Zhengyu Lin (S'03-M'05-SM'10) received the B.Sc. and M.Sc. degrees from the College of Electrical Engineering, Zhejiang University, Hangzhou, China, in 1998 and 2001, respectively, and the Ph.D. degree from Heriot-Watt University, Edinburgh, U.K., in 2005. He is currently a Lecturer in Electrical, Electronic and Power Engineering with Aston University, Birmingham, U.K. He was a Research Associate with the University of Sheffield from 2004 to 2006, an R&D Engineer with Emerson Industrial Automation, Control Techniques PLC from 2006 to 2011, a Senior Research Scientist with Sharp Laboratories of Europe Ltd. from 2011 to 2012, and a Lecturer with Coventry University from 2013 to 2014. His research interests include power electronics and its applications in renewable energy, energy storage, motor drives and power systems.



Xiangning He (M'95--SM'96--F'10) received the B.Sc. and M.Sc. degree from Nanjing University of Aeronautical and Astronautical, Nanjing, China, in 1982 and 1985, respectively, and Ph.D. degree from Zhejiang University, Hangzhou, China, in 1989.

In 1991, he obtained a Fellowship from the Royal Society of U.K., and conducted research in Heriot-Watt University, Edinburgh, U.K., as a Post-Doctoral Research Fellow for two years. In 1994, he joined Zhejiang University as an Associate Professor. Since 1996, he has been a Full Professor in the College of Electrical Engineering, Zhejiang University. His research interests are power electronics and their industrial applications.

Dr. He is a Fellow of The Institute of Electrical and Electronics Engineers (IEEE) and has been appointed as IEEE Distinguished Lecturer by the IEEE Power Electronics Society in 2011. He is also a Fellow of the Institution of Engineering and Technology (formerly IEE), U.K.



Ruichi Wang (S'14) received the B.S. degree in electrical engineering from Zhejiang University, Hangzhou, China, in 2013. Currently, she is working toward the Ph.D. degree in the College of Electrical Engineering, Zhejiang University, Hangzhou, China. She visited Aston University, Birmingham, UK, from September, 2015 to March, 2016. Her current research interests include communication technique applied in power electronics and EMI mitigation for SMPS.