

GRAPHIS

a free tool to *save, annotate*
and *visualise* regions in
graffiti photos

Martin Wieser
Geert Verhoeven
Massimiliano Carloni

projectindigo.eu

The INDIGO graffiti project is funded by the Heritage Science Austria
programme of the Austrian Academy of Sciences (ÖAW)





INDIGO
core division



INDIGO

core division

real graffito
physical resource



INDIGO

core division

real graffiti
physical resource

derivatives
digital resources



INDIGO

core division

real graffiti
physical resource

derivatives
digital resources

digital photos
textured 3D models
orthophotographs
polygons



INDIGO

core division

real graffiti
physical resource

derivatives
digital resources

digital photos

textured 3D models

orthophotographs

polygons

metadata

metadata



INDIGO

core division

real graffiti
physical resource

derivatives
digital resources

digital photos

textured 3D models

orthophotographs

polygons

metadata



metadata

PIXELS + metadata

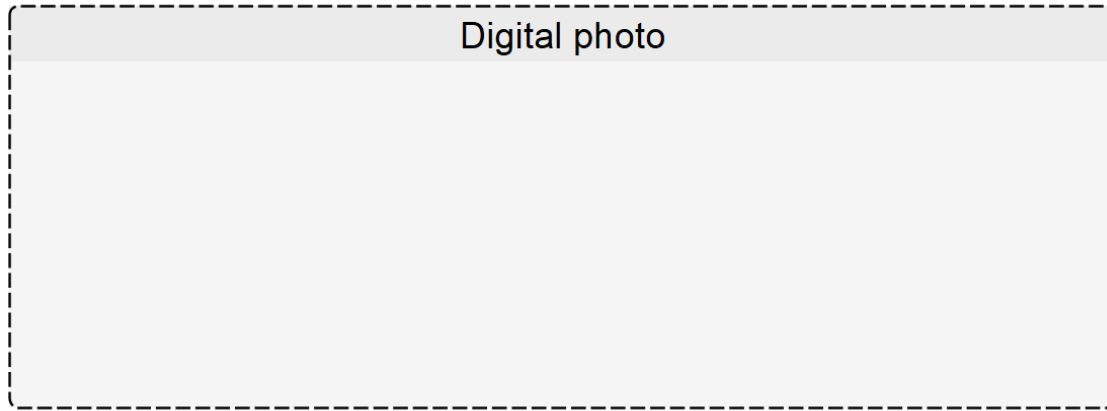

PIXELS + metadata

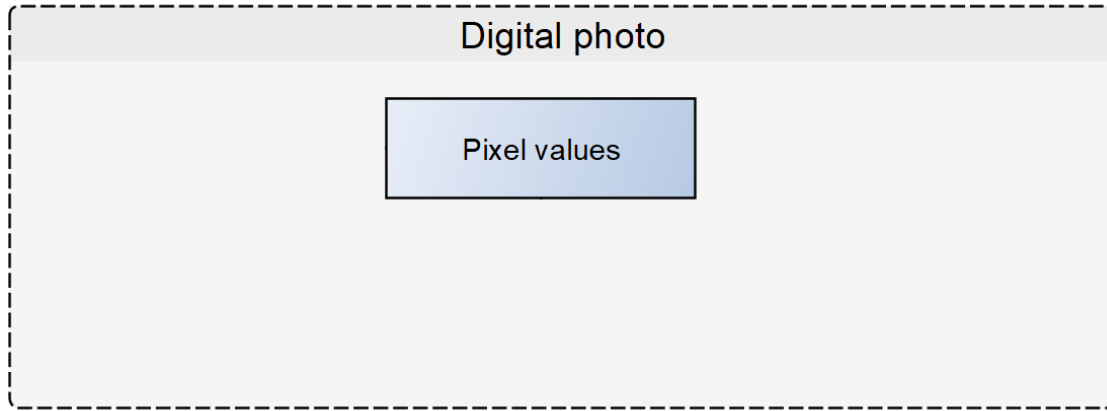

PIXELS + metadata

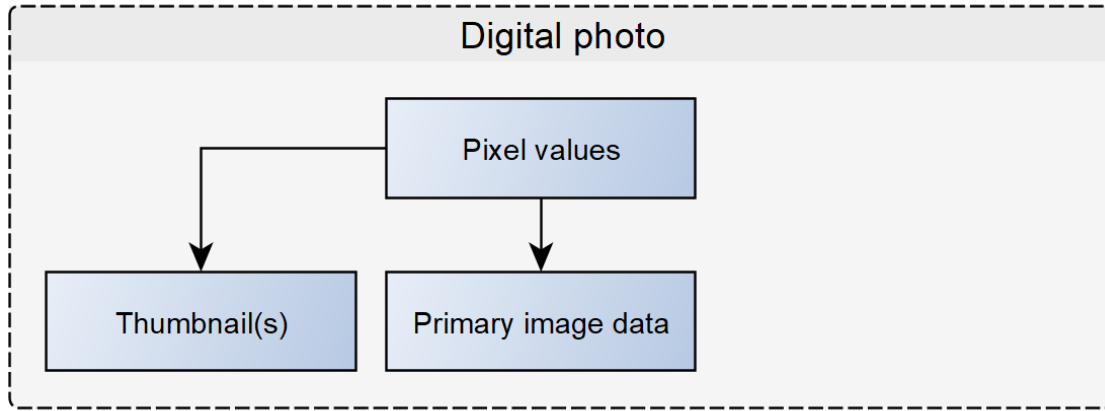

PIXELS + metadata

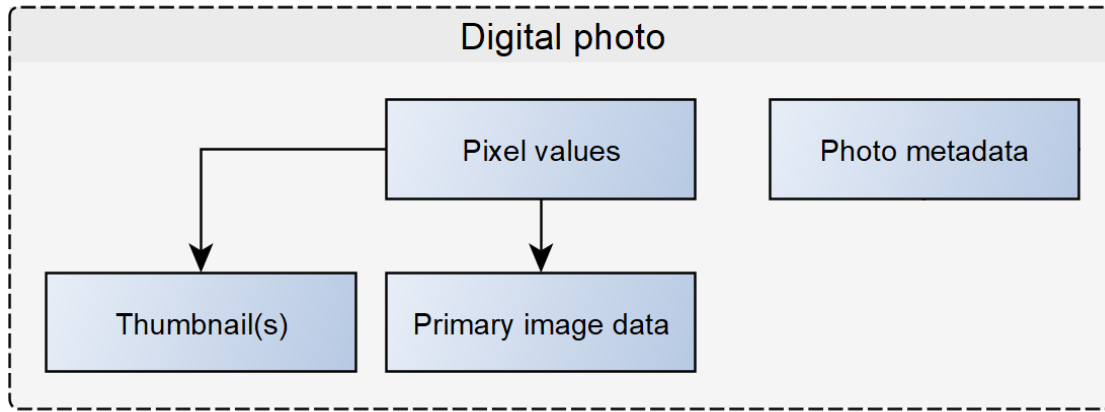

PIXELS + metadata

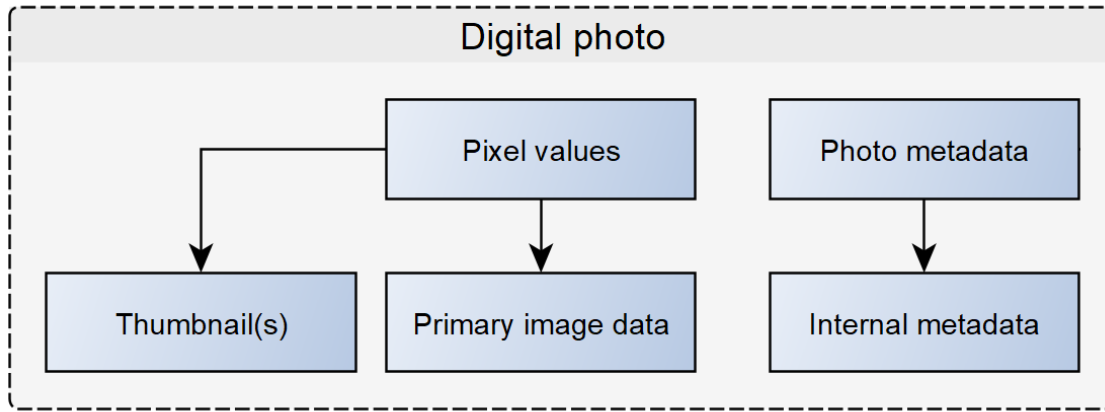

PIXELS + metadata

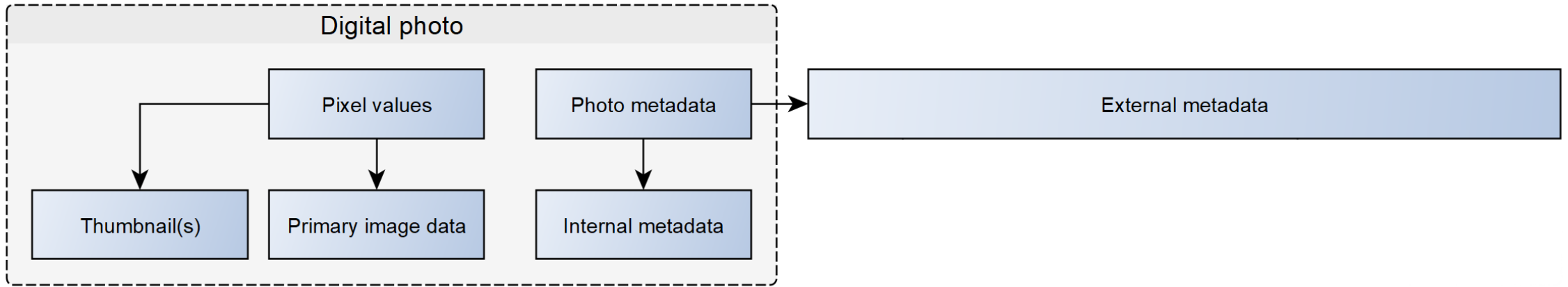

PIXELS + metadata

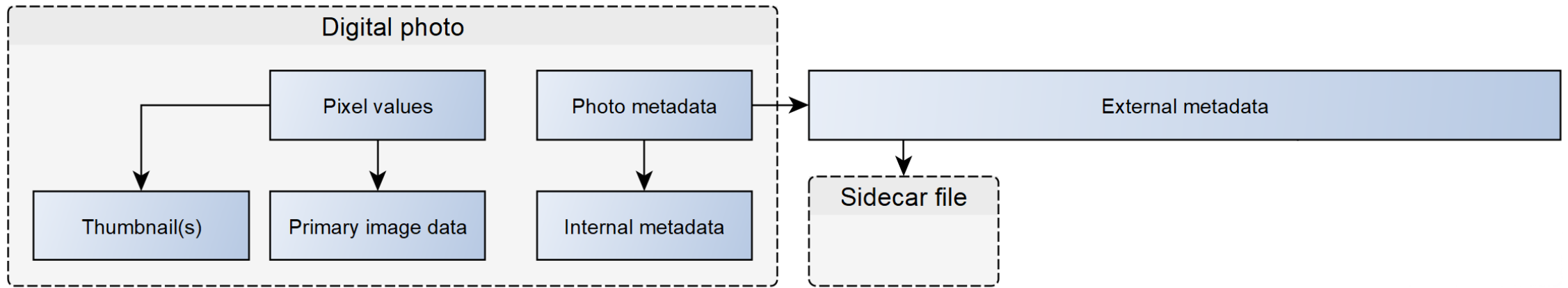

PIXELS + metadata

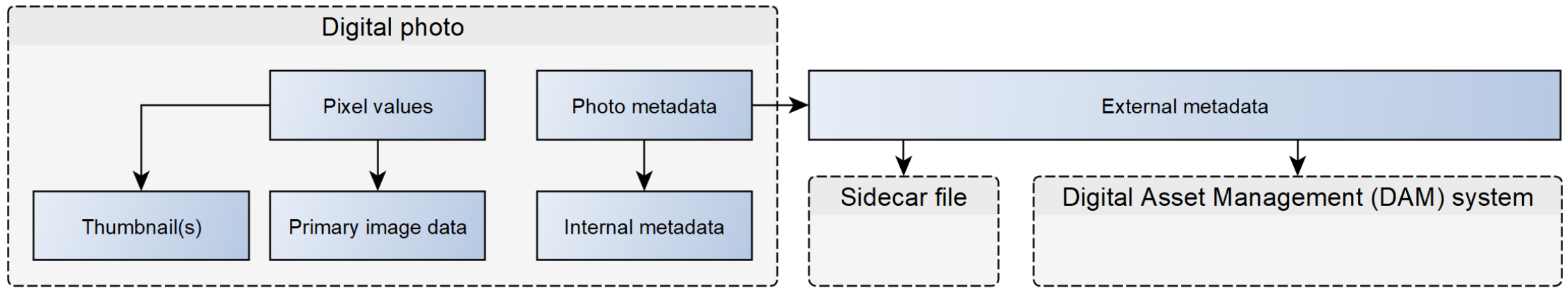

Exif + IPTC

Metadata categories

Exif + IPTC

Metadata categories

Administrative

Exif + IPTC

Metadata categories

Administrative

Descriptive

Exif + IPTC

Metadata categories

Administrative

Descriptive

Structural

Exif + IPTC

Metadata categories

Administrative

Descriptive

Exif + IPTC

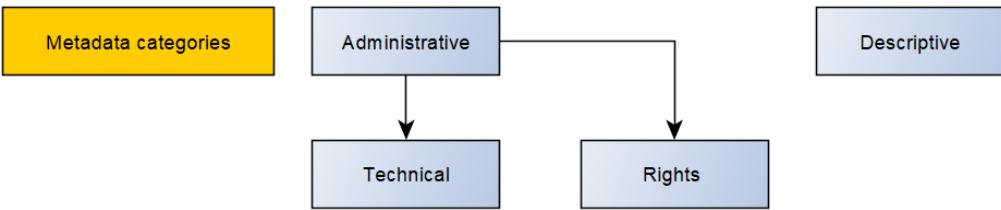

Exif + IPTC

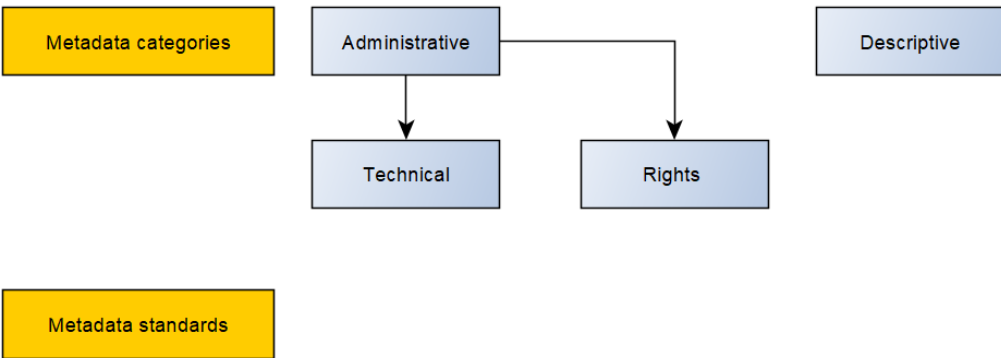

Exif + IPTC

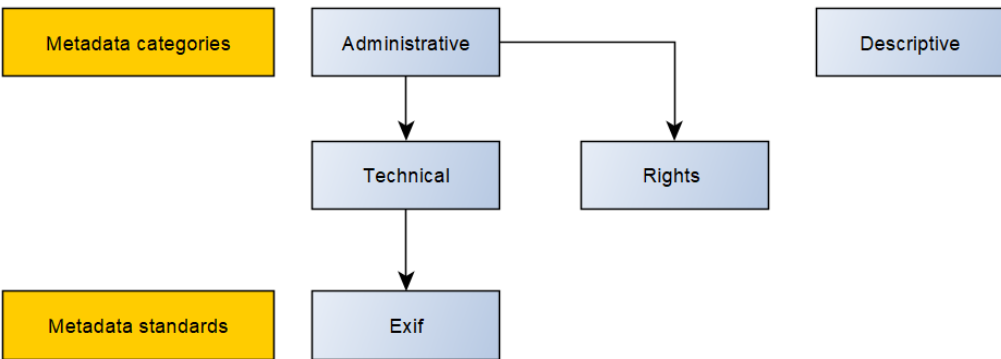

Exif + IPTC

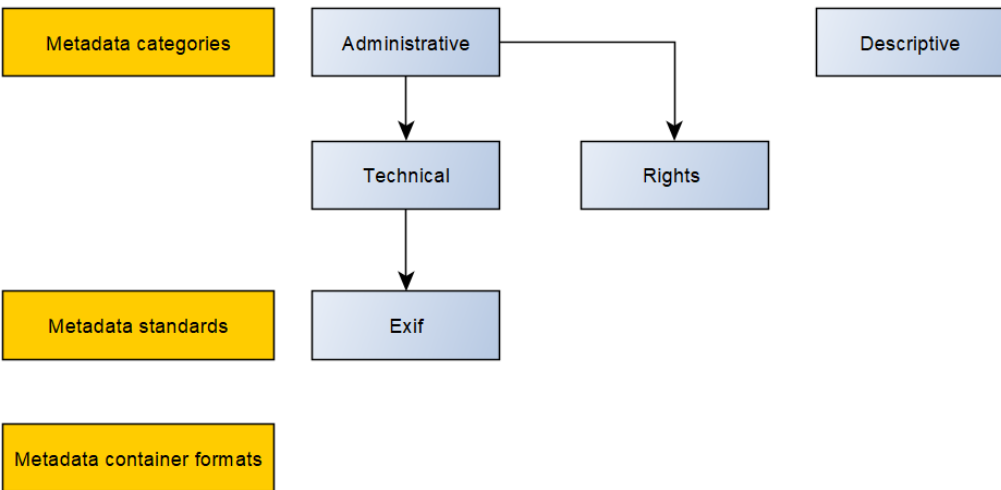

Exif + IPTC

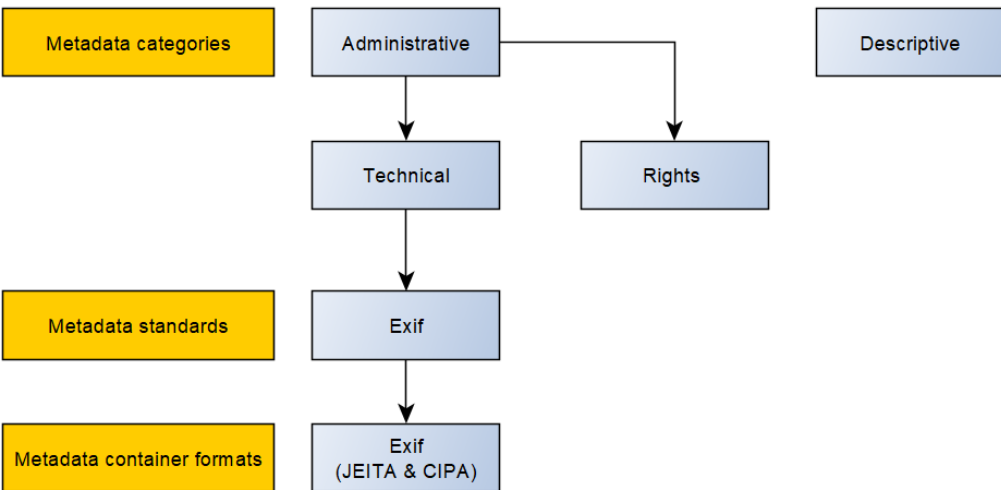

Exif + IPTC

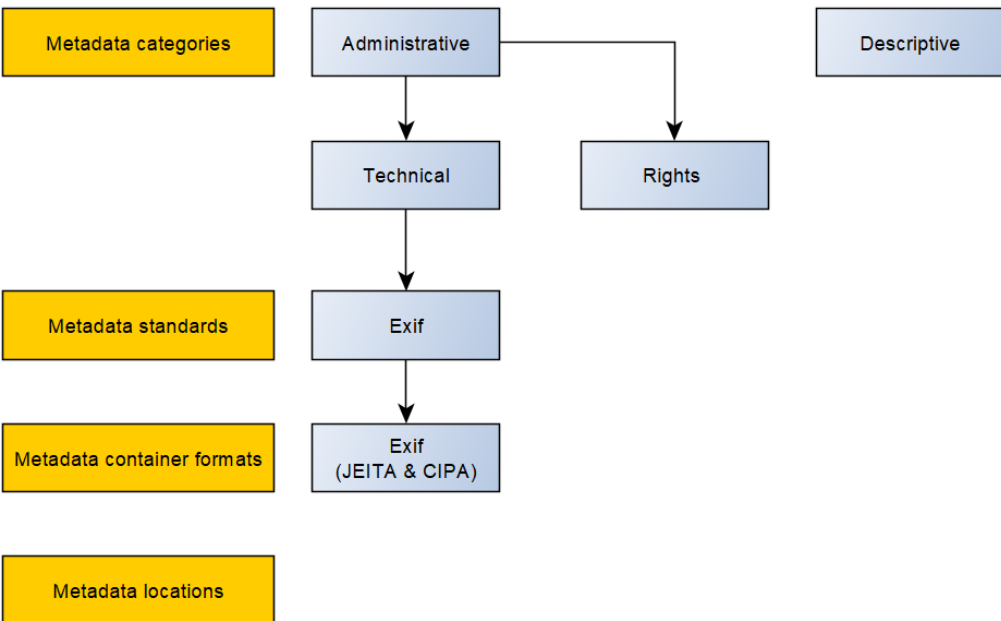

Exif + IPTC

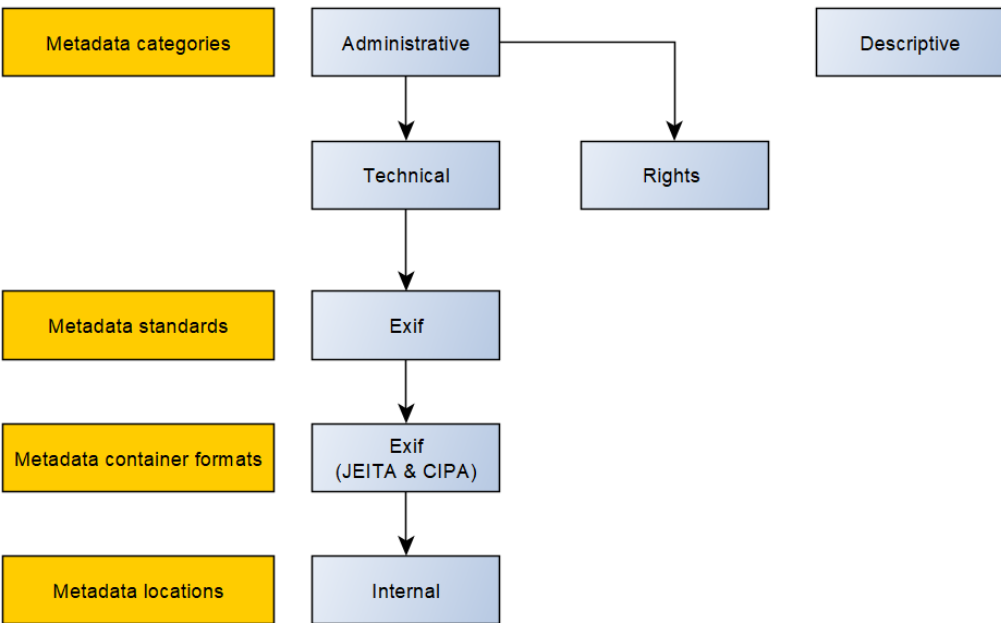

Exif + IPTC

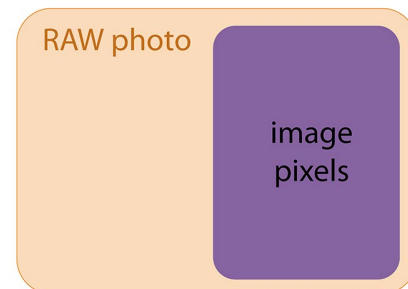
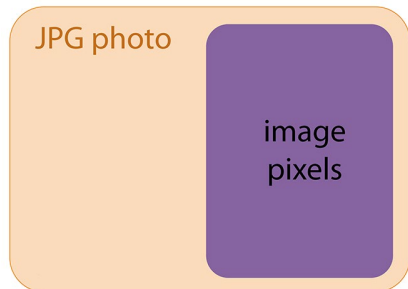
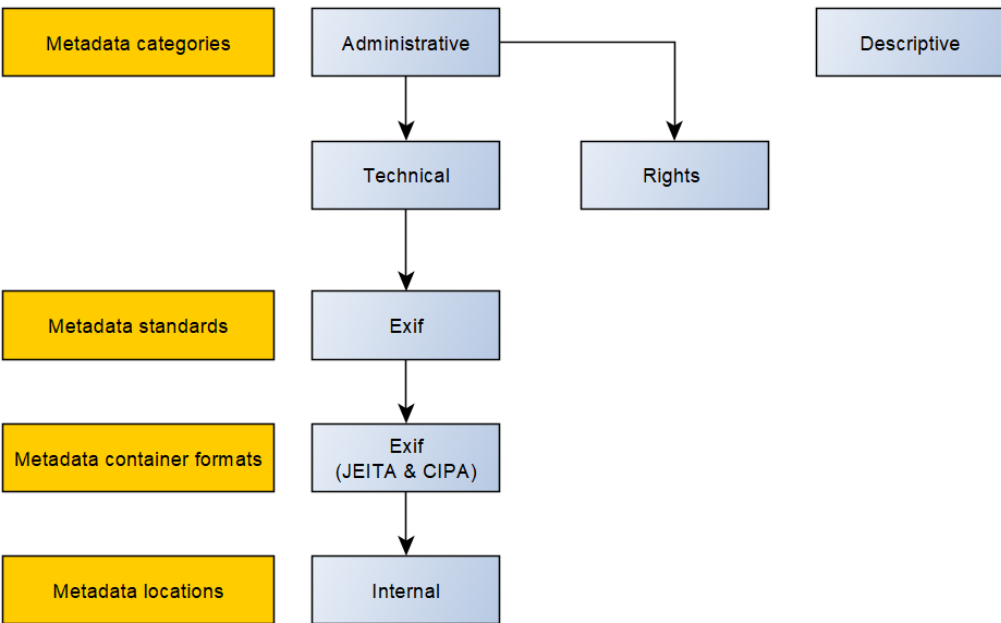

Exif + IPTC

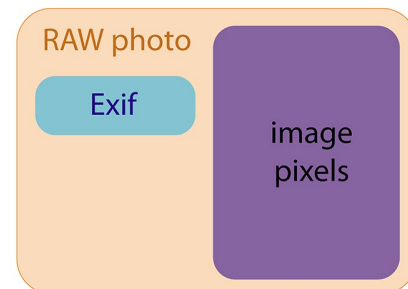
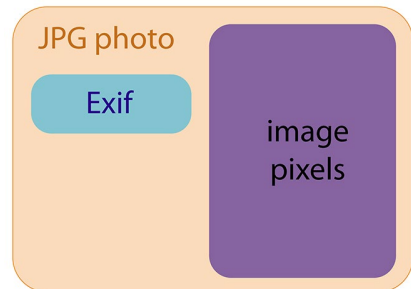
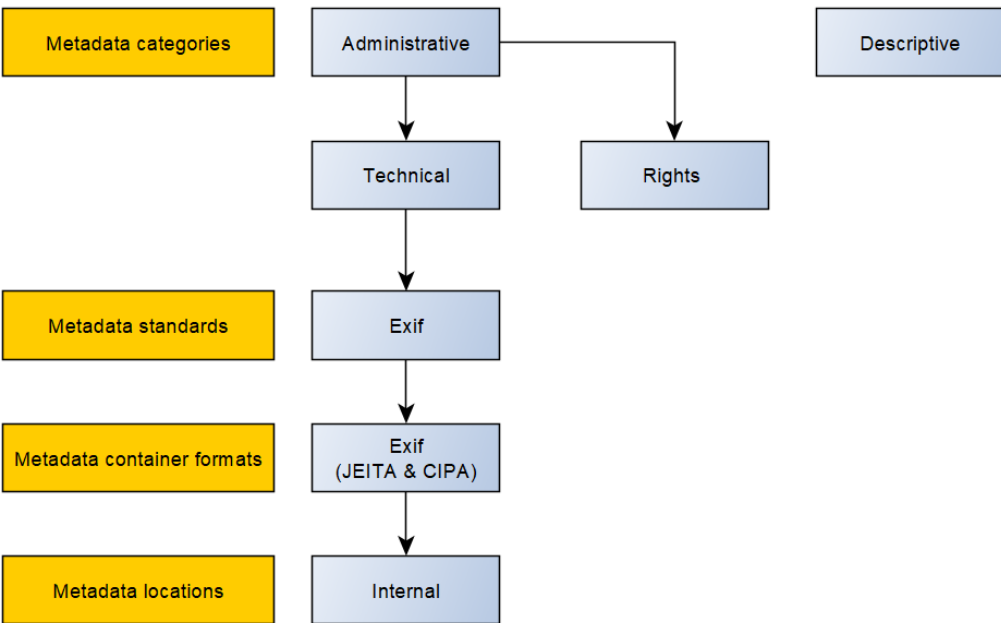

Exif + IPTC

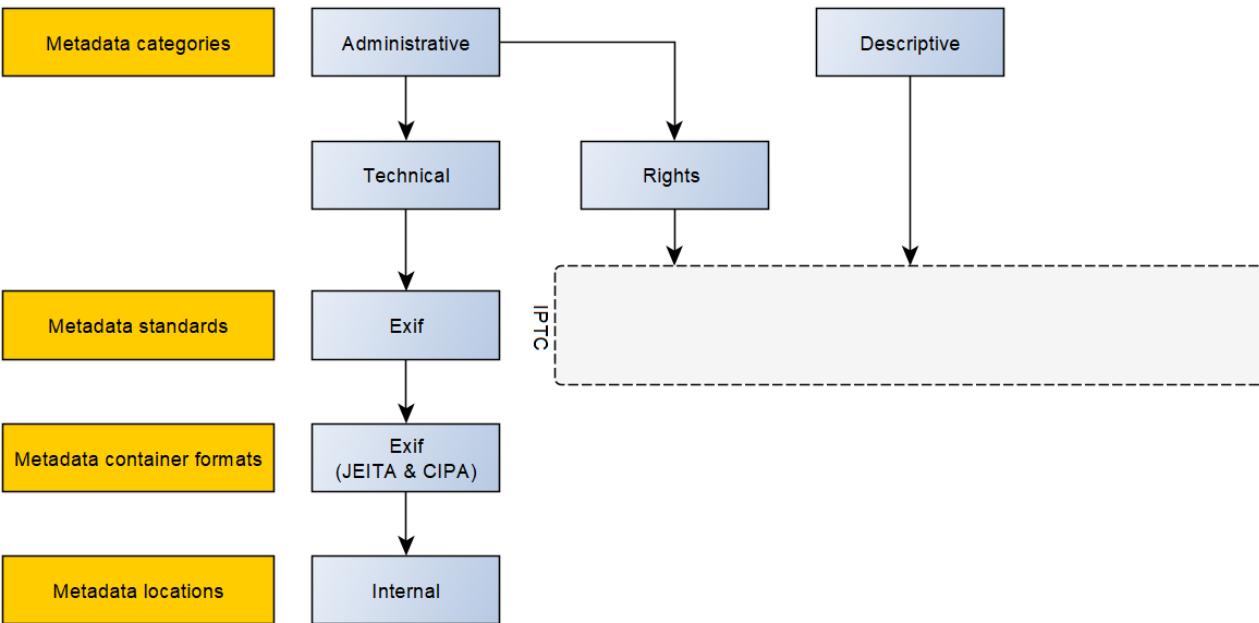

Exif + IPTC

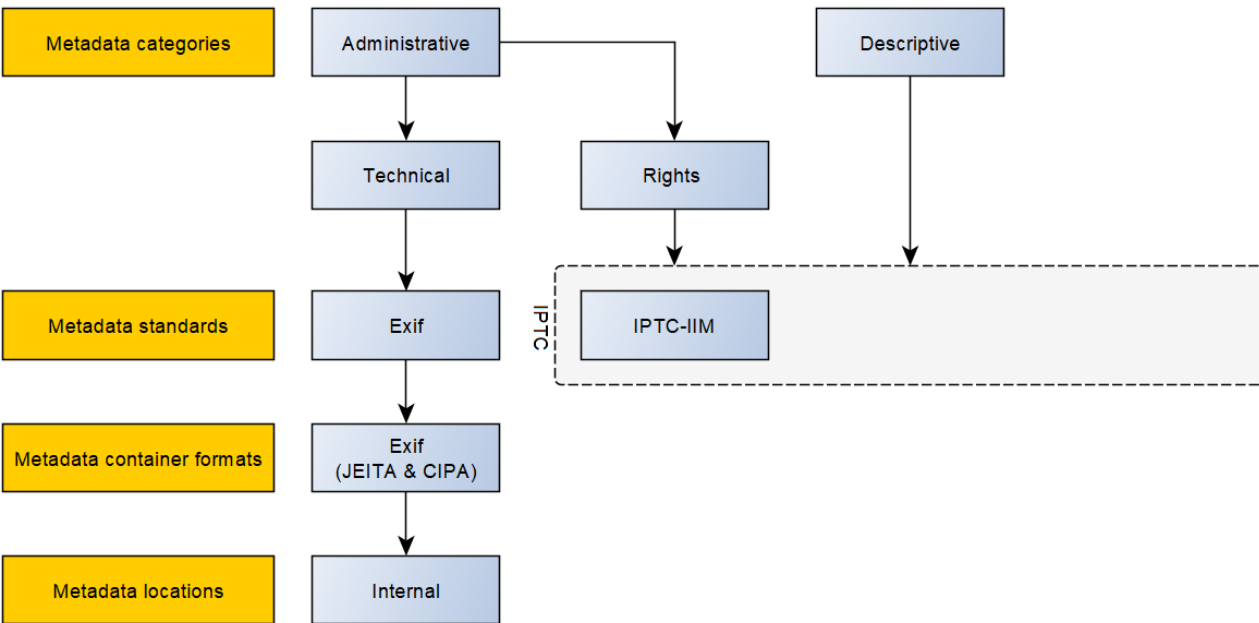

Exif + IPTC

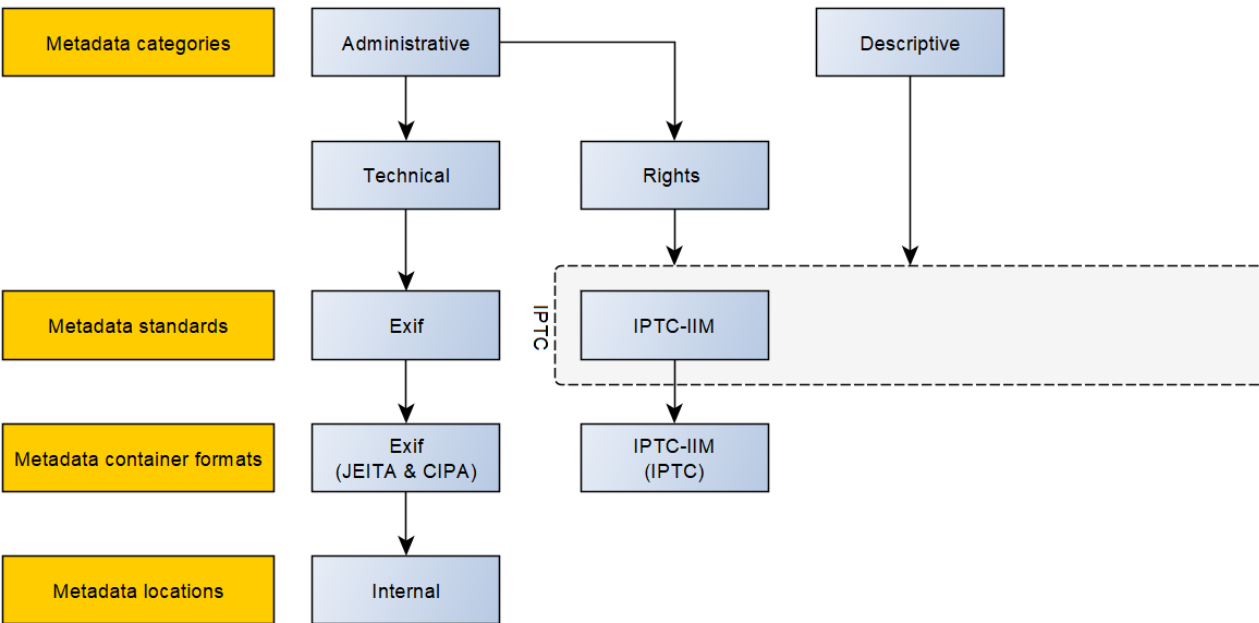

Exif + IPTC

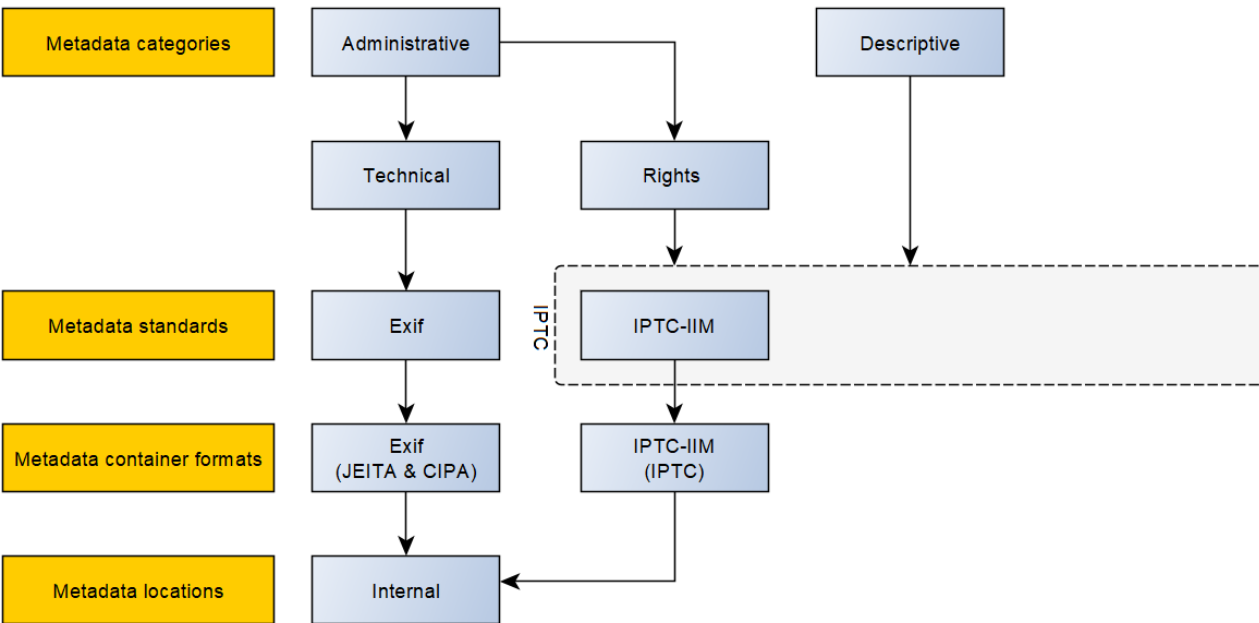

Exif + IPTC

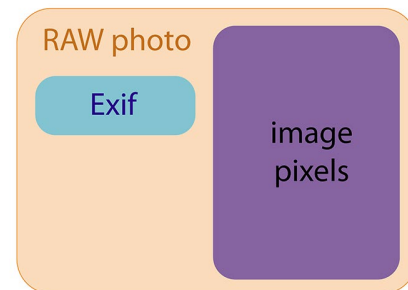
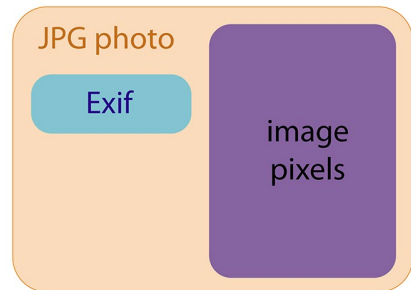
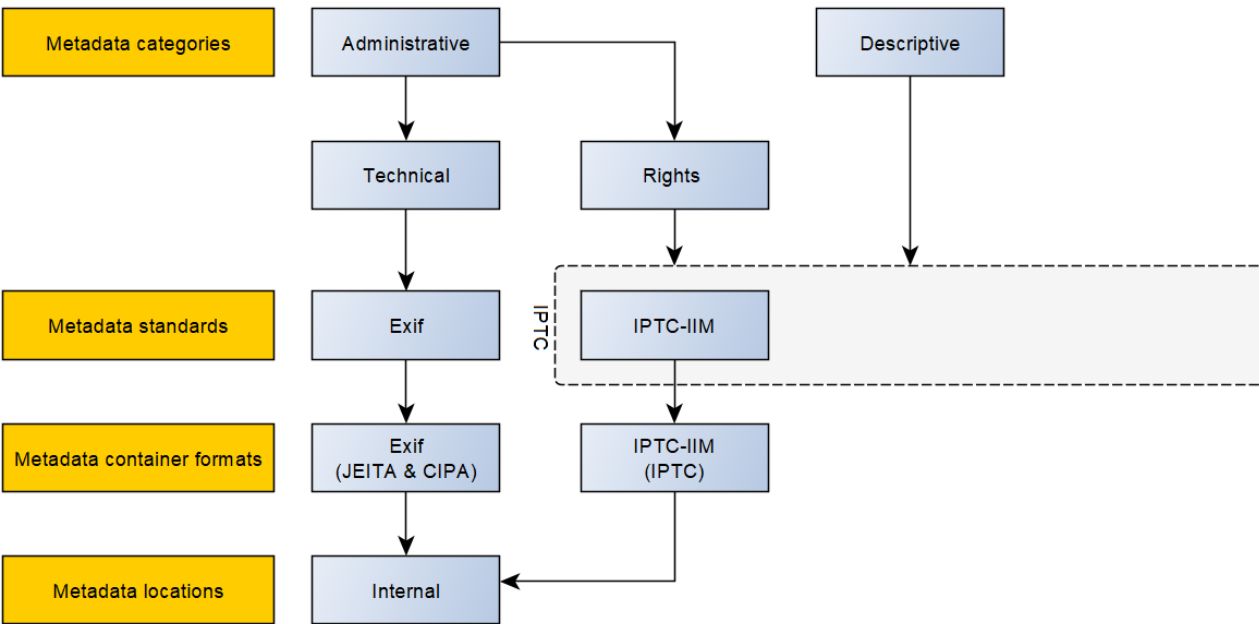

Exif + IPTC

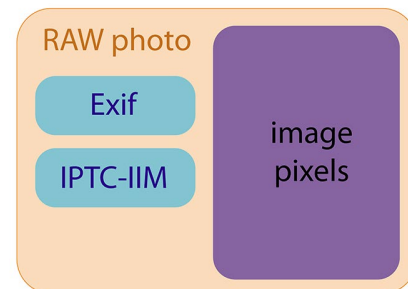
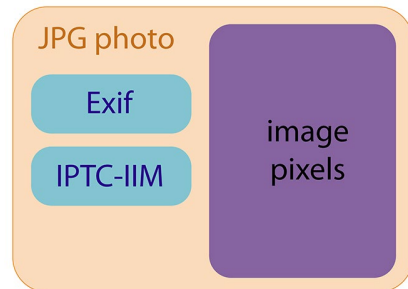
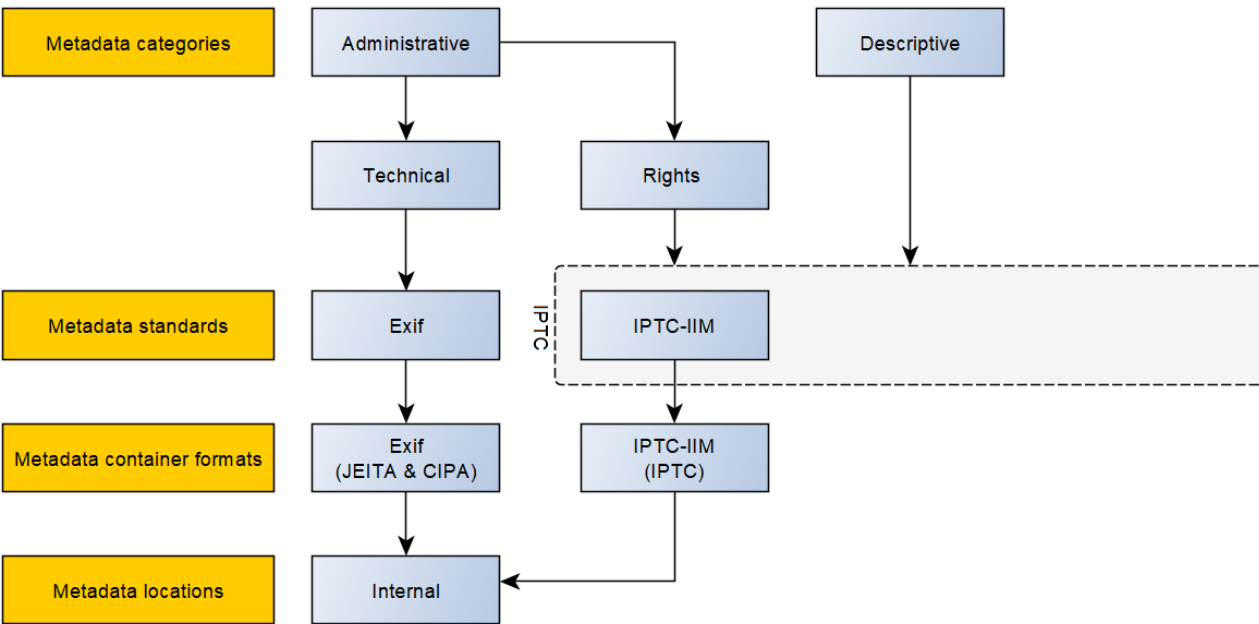

Exif + IPTC

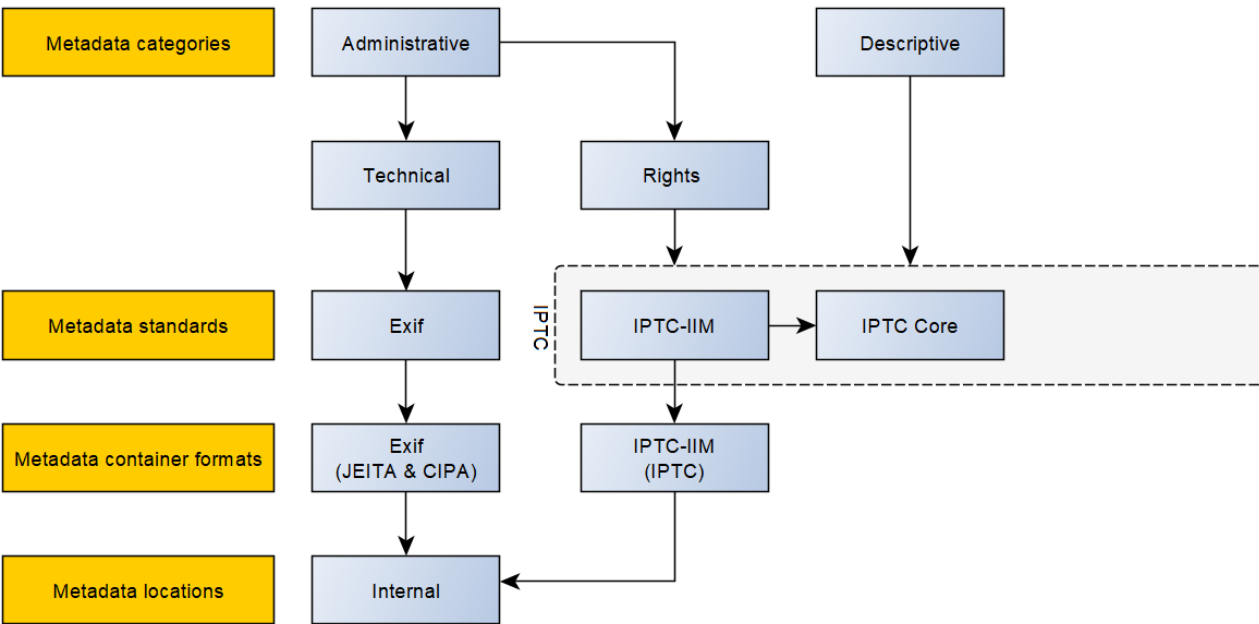

Exif + IPTC

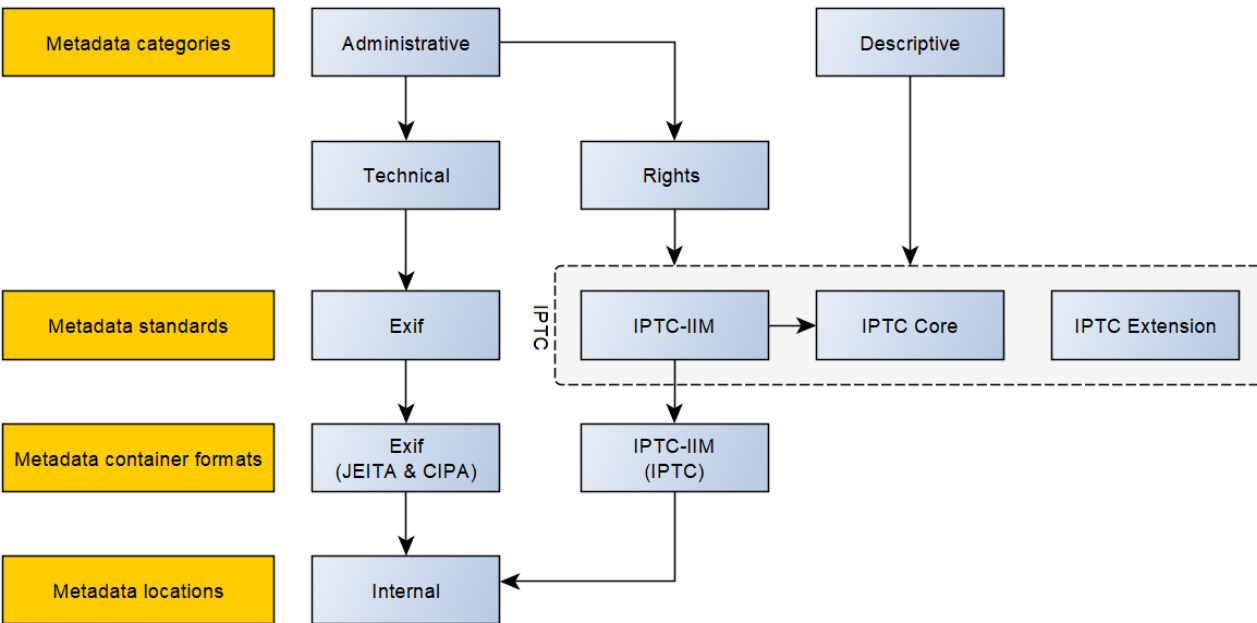

Exif + IPTC

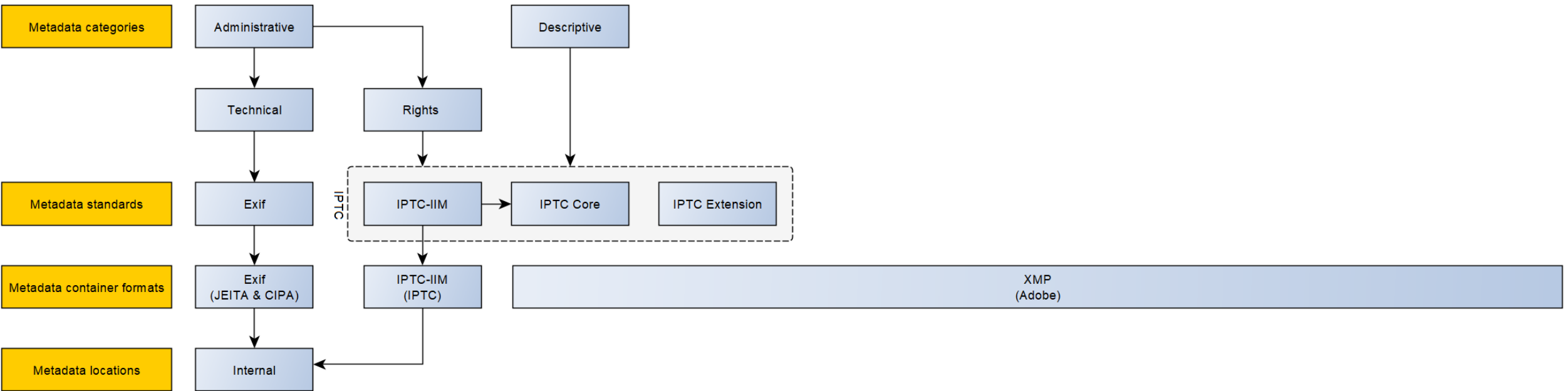

Exif + IPTC

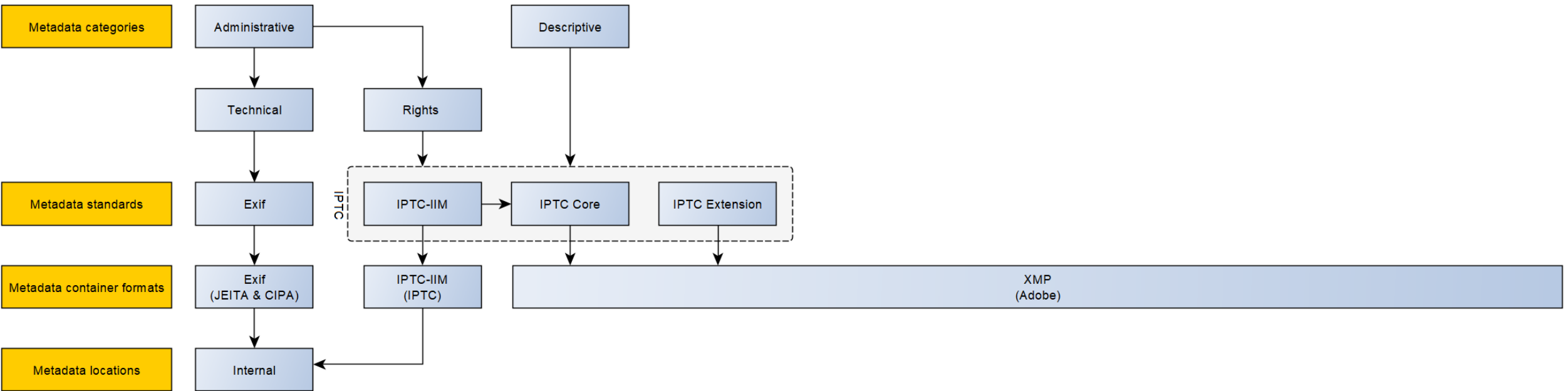

Exif + IPTC

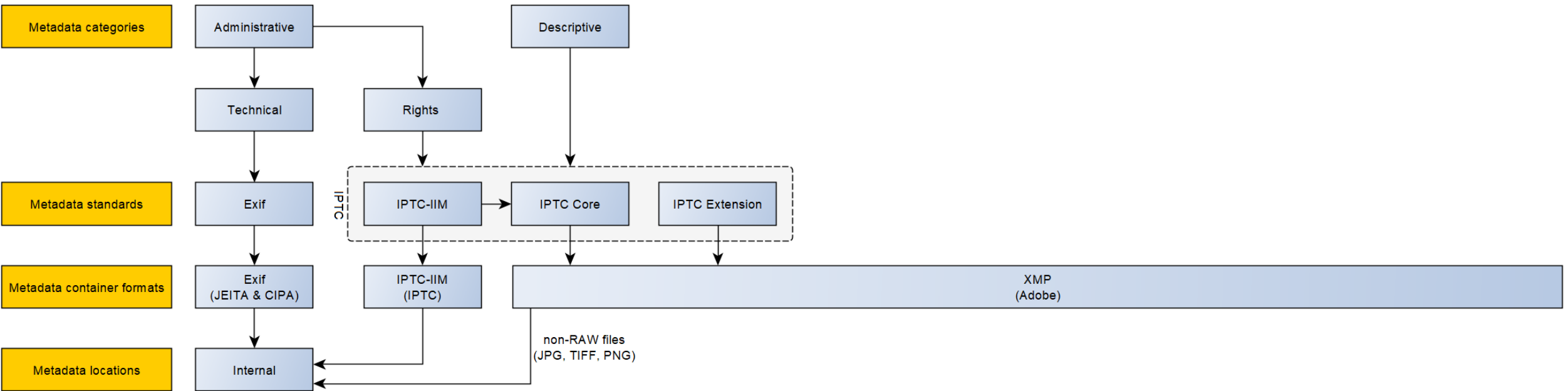

Exif + IPTC

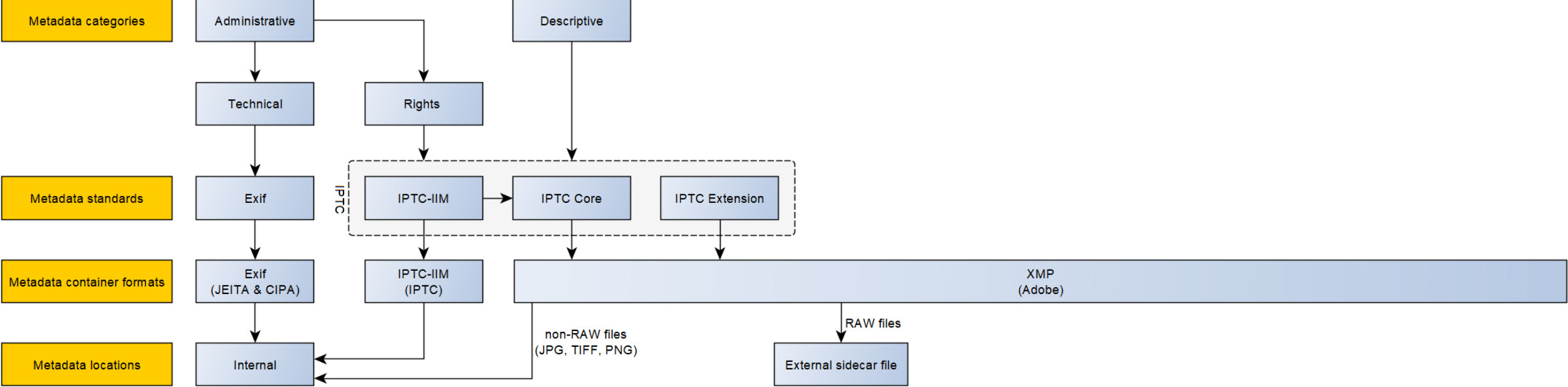

Exif + IPTC

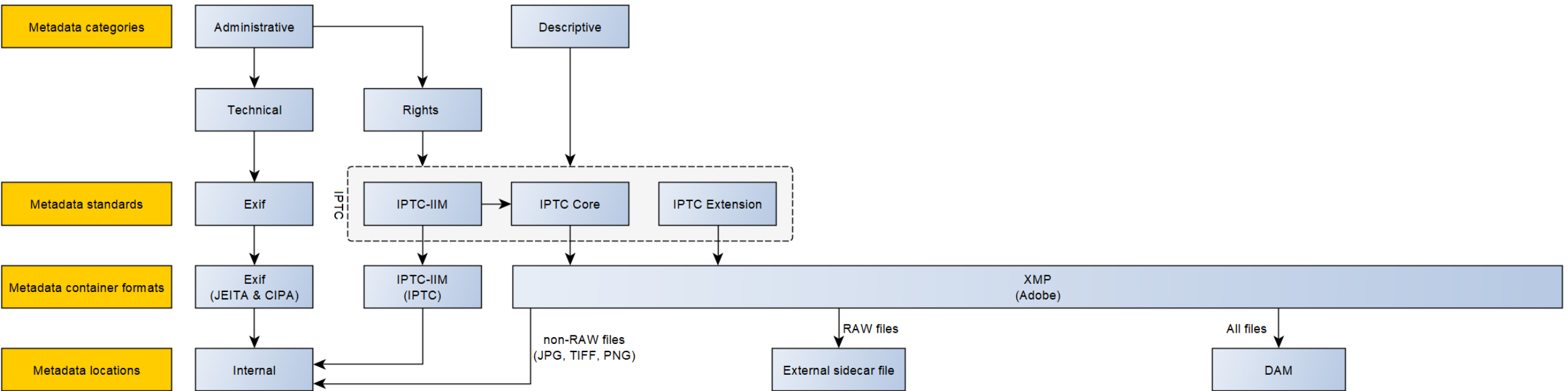

Exif + IPTC

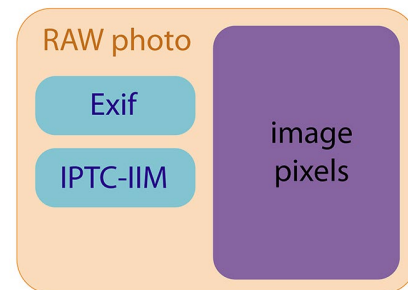
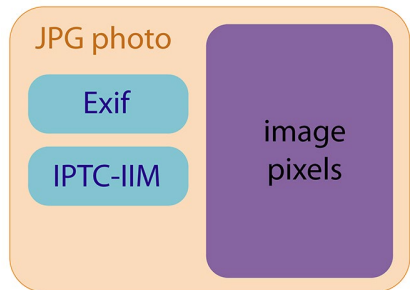
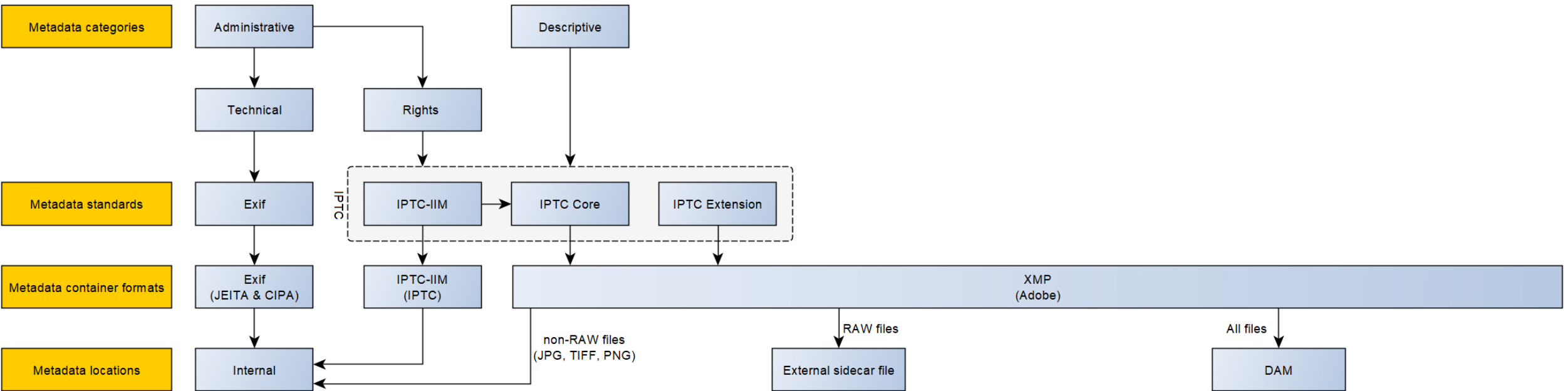

Exif + IPTC

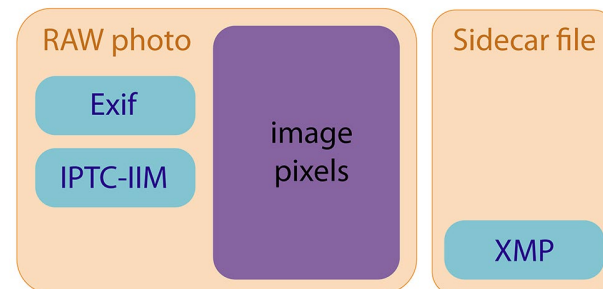
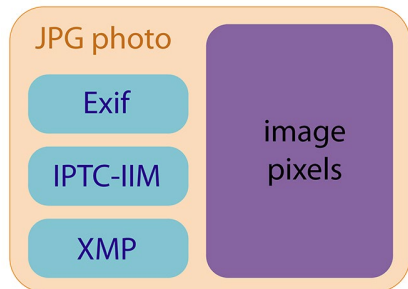
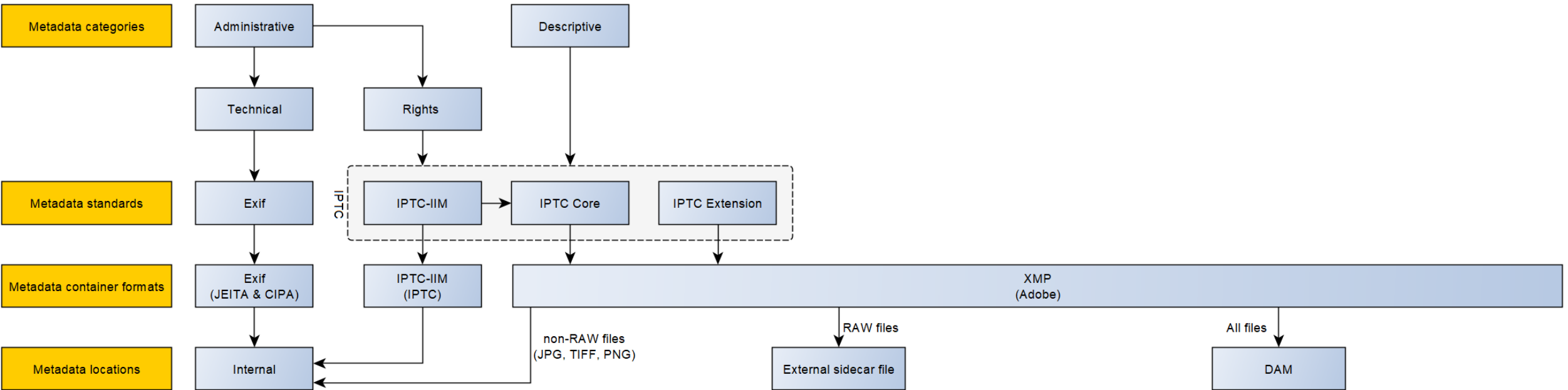

Exif + IPTC

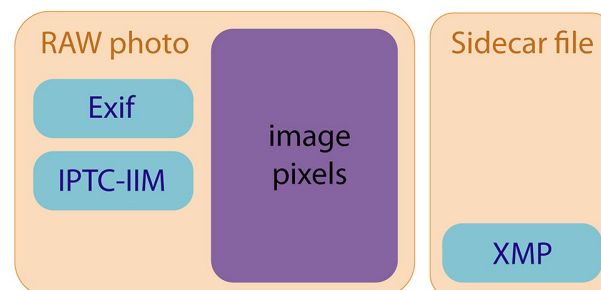
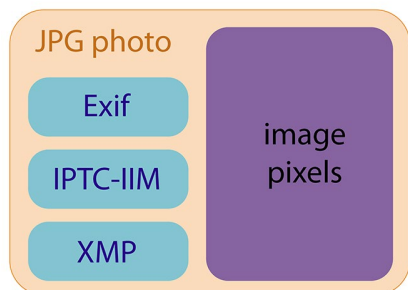
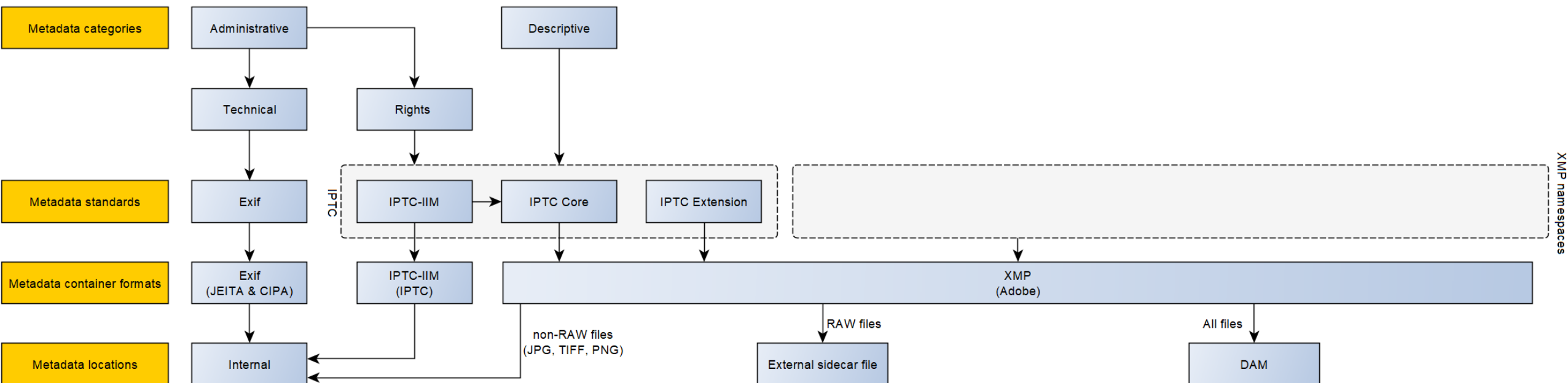

Exif + IPTC

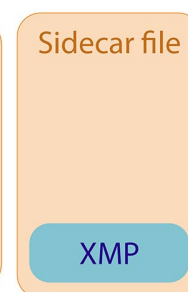
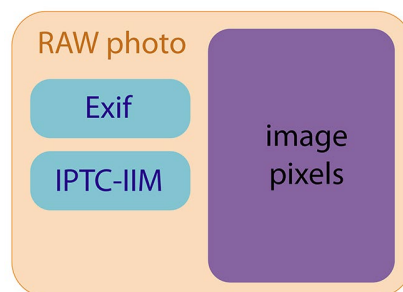
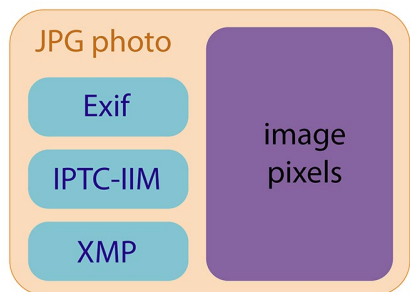
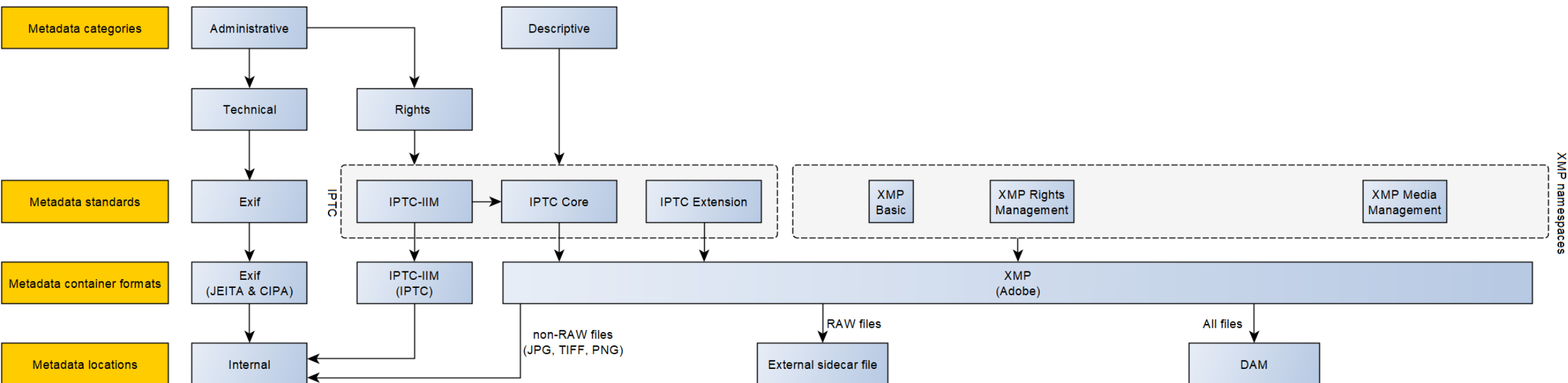

Exif + IPTC

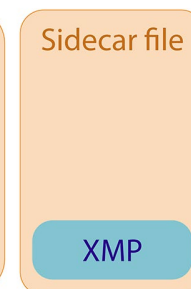
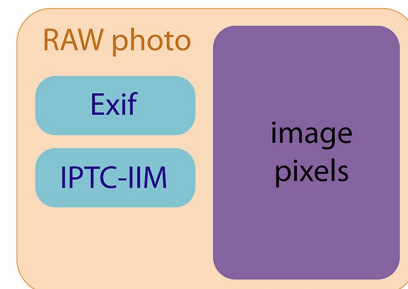
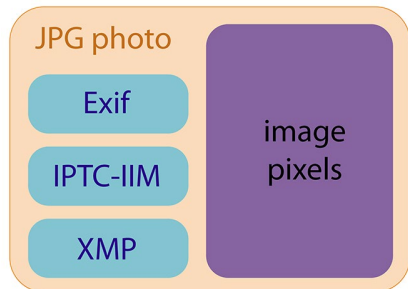
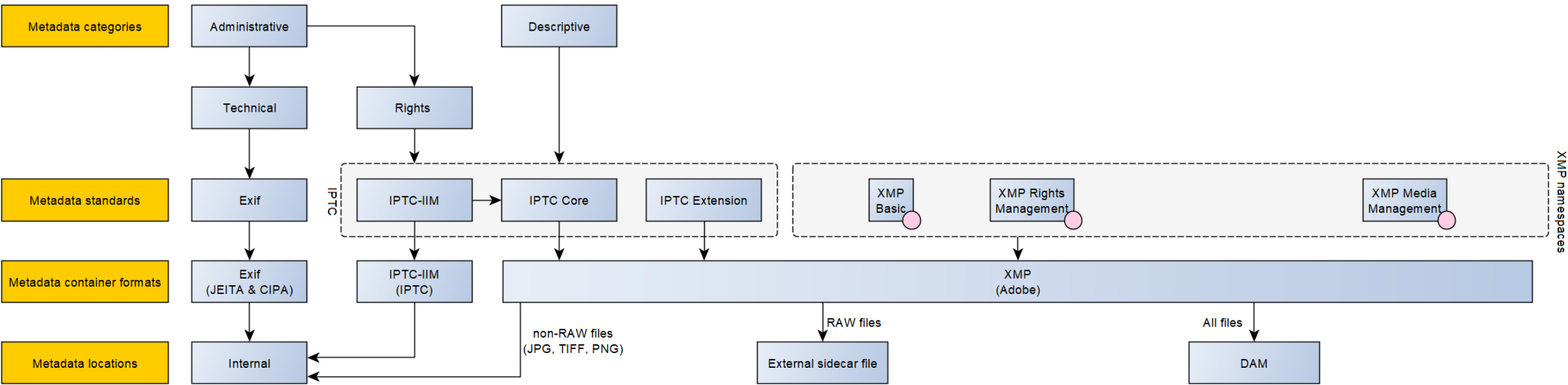

Exif + IPTC

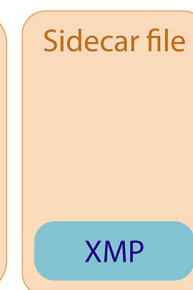
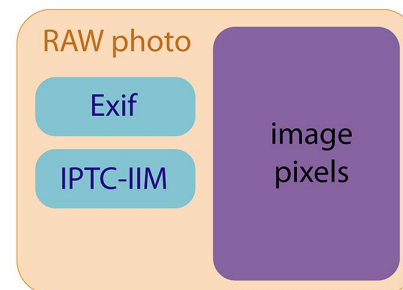
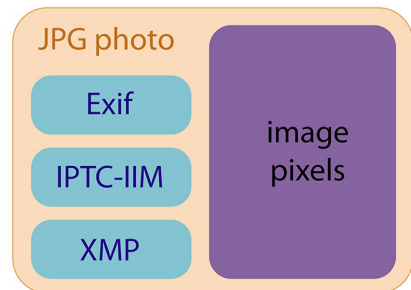
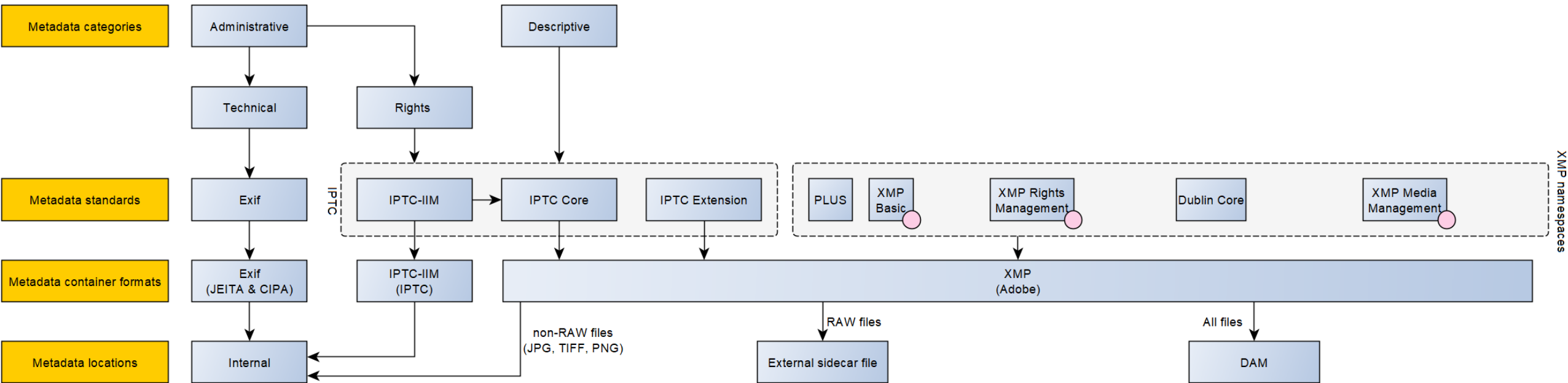

Exif + IPTC

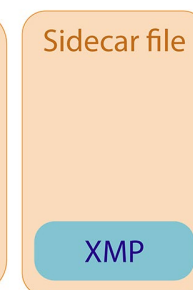
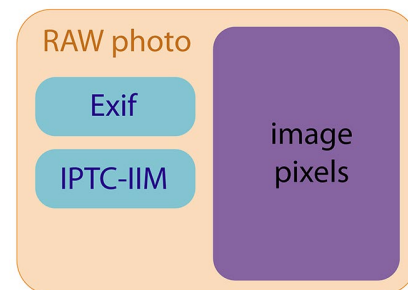
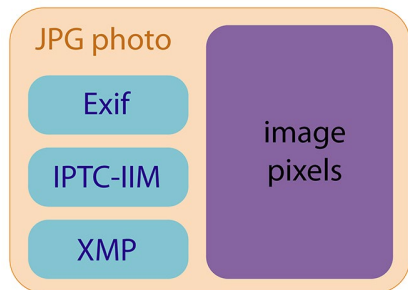
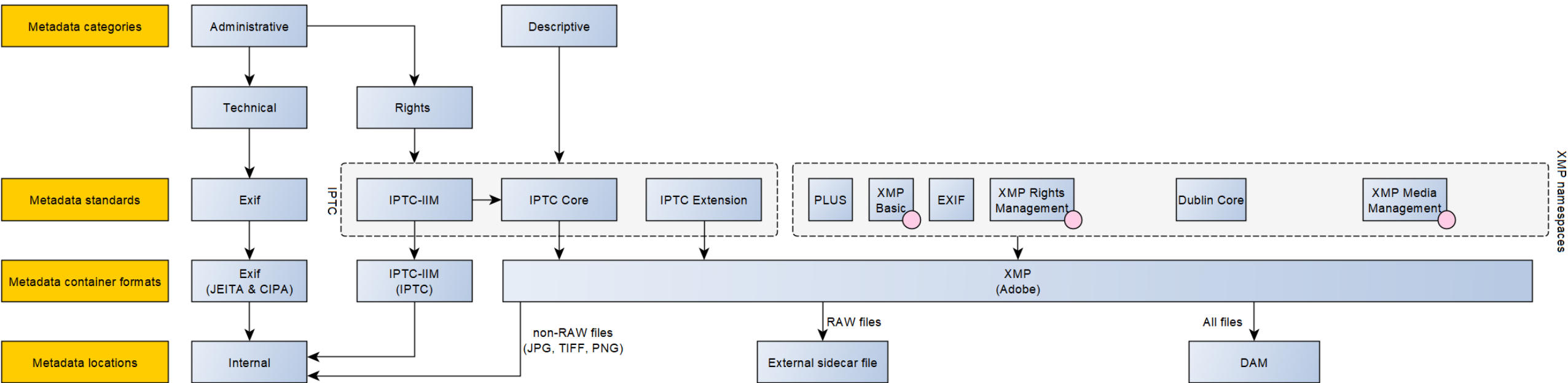

Exif + IPTC

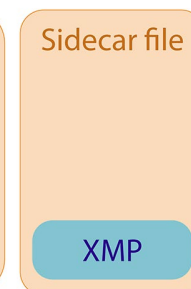
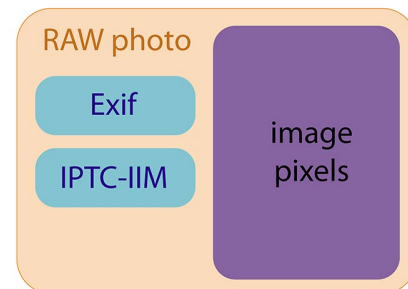
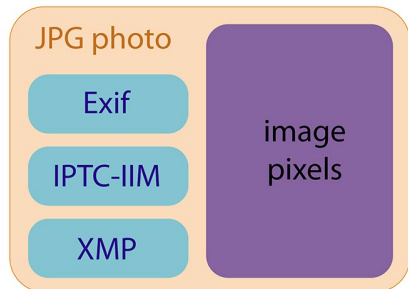
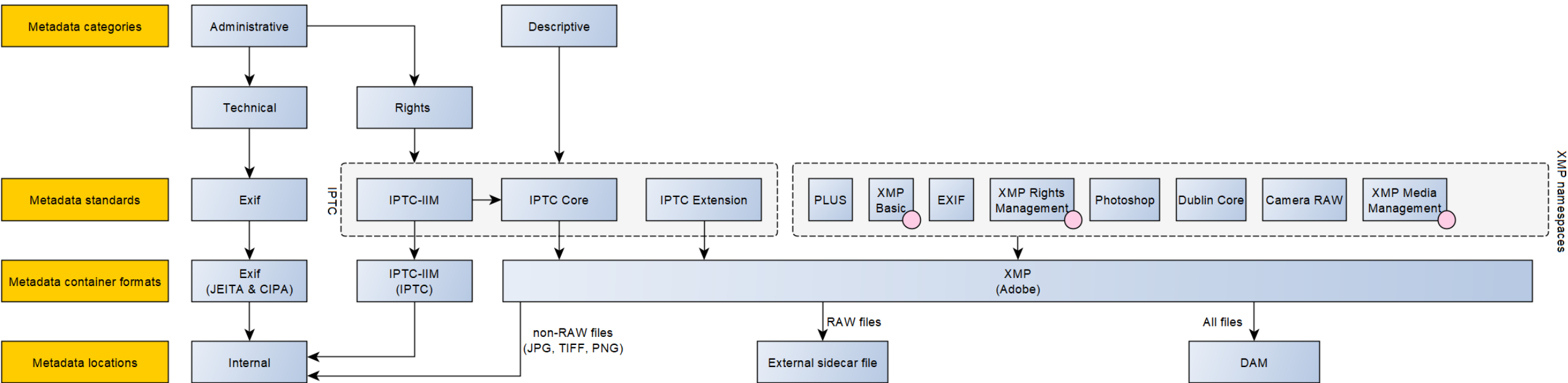

Exif + IPTC

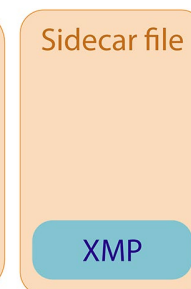
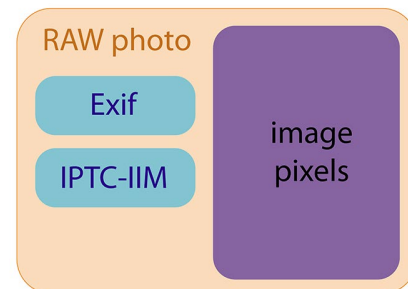
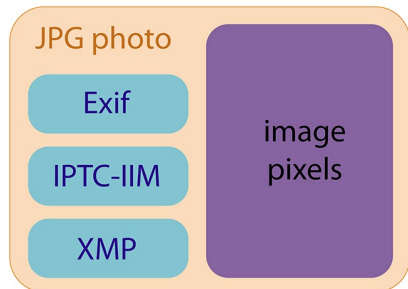
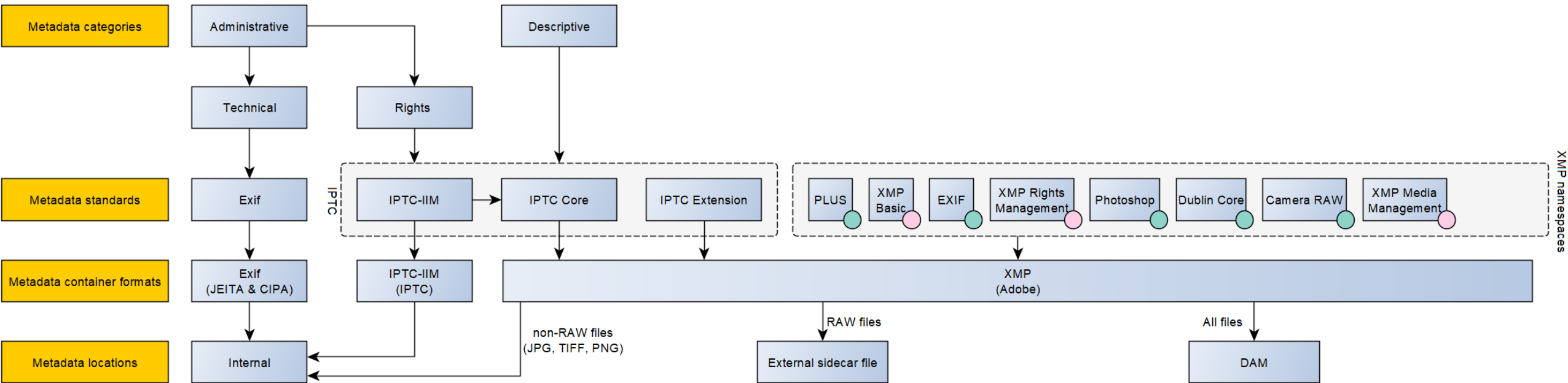

Exif + IPTC

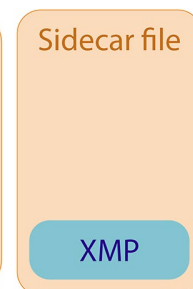
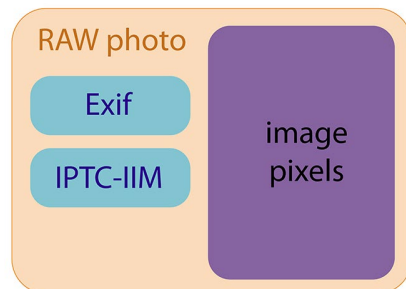
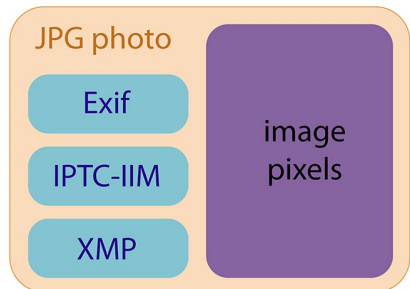
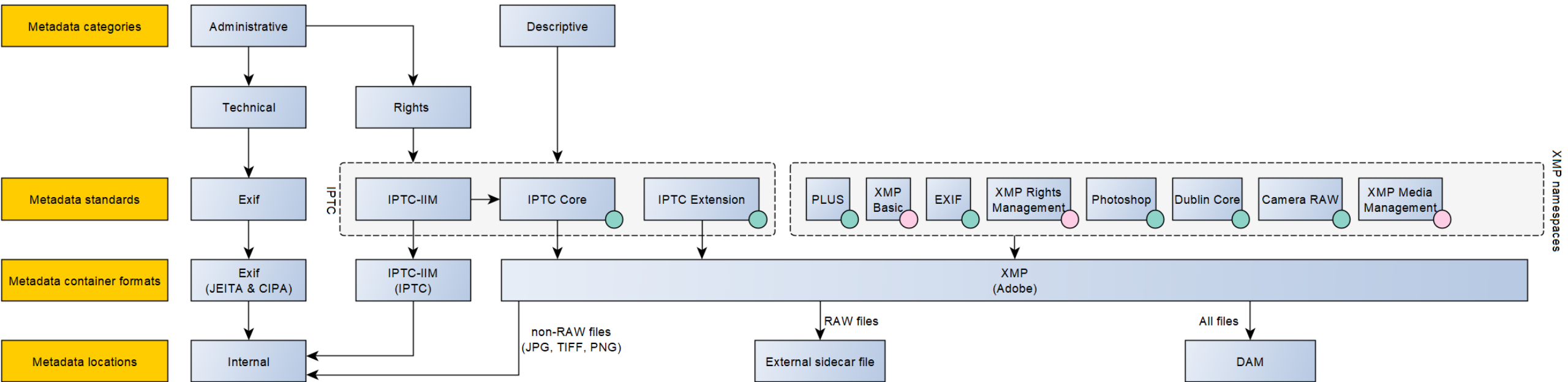

Exif + IPTC

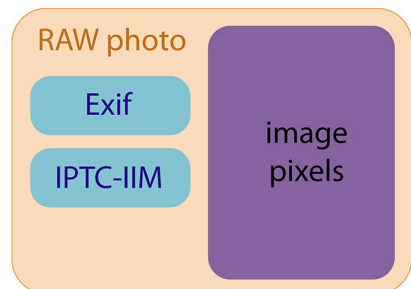
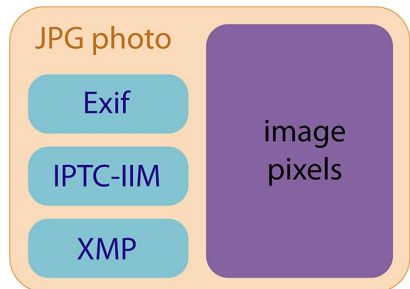
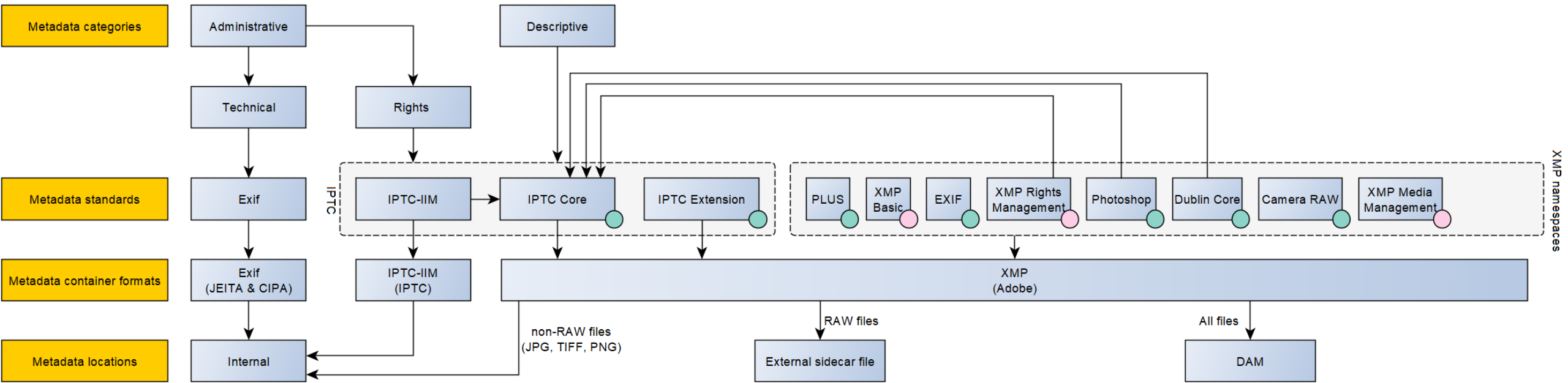

Exif + IPTC

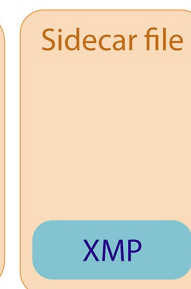
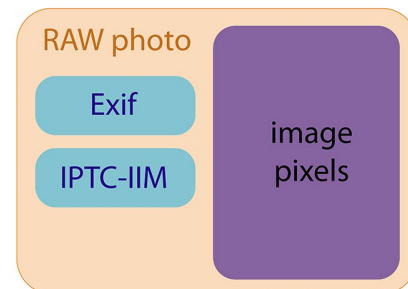
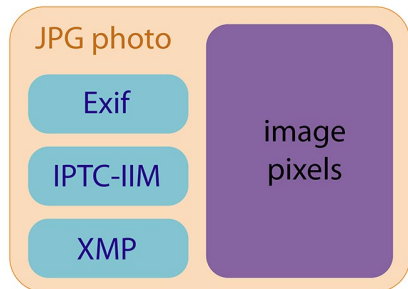
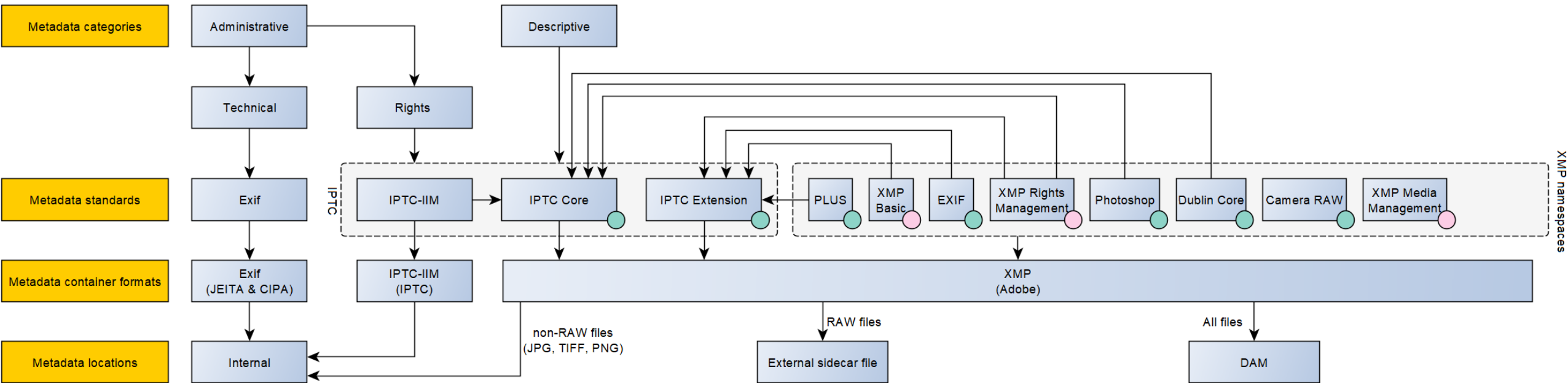

Exif + IPTC

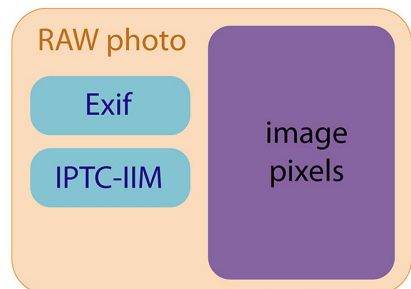
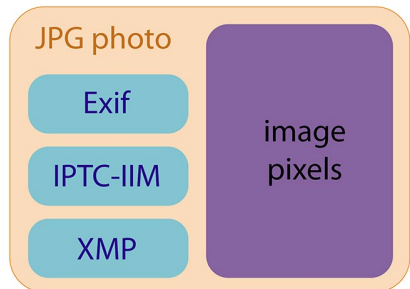
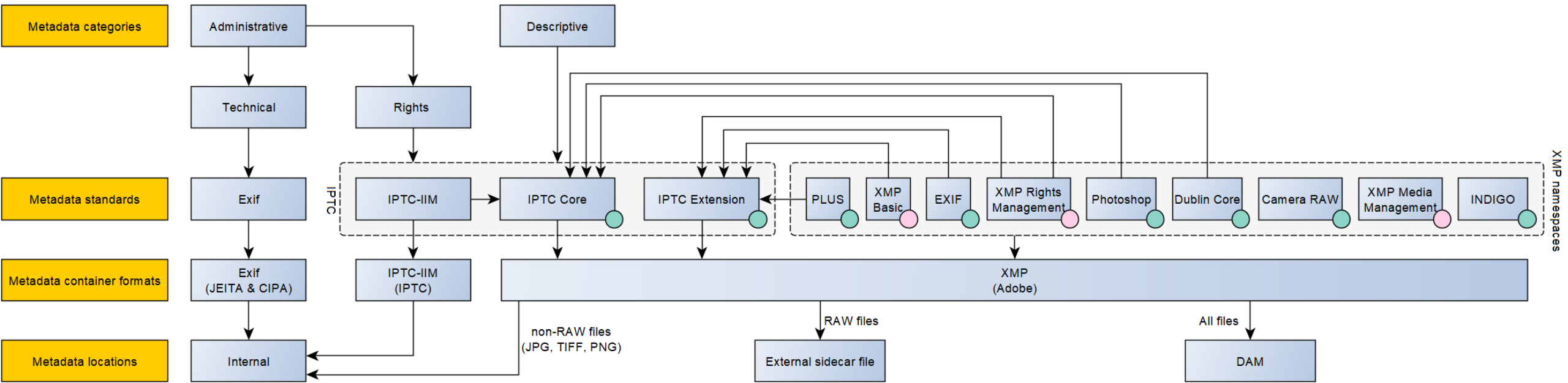

Exif + IPTC

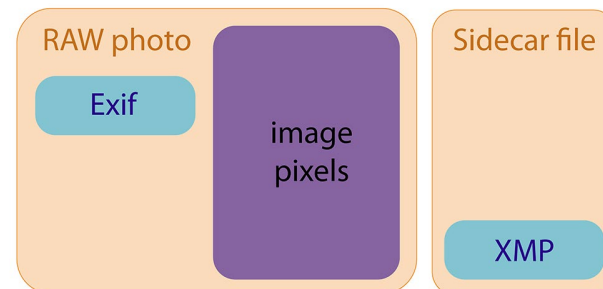
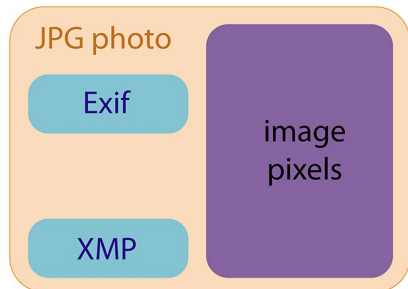
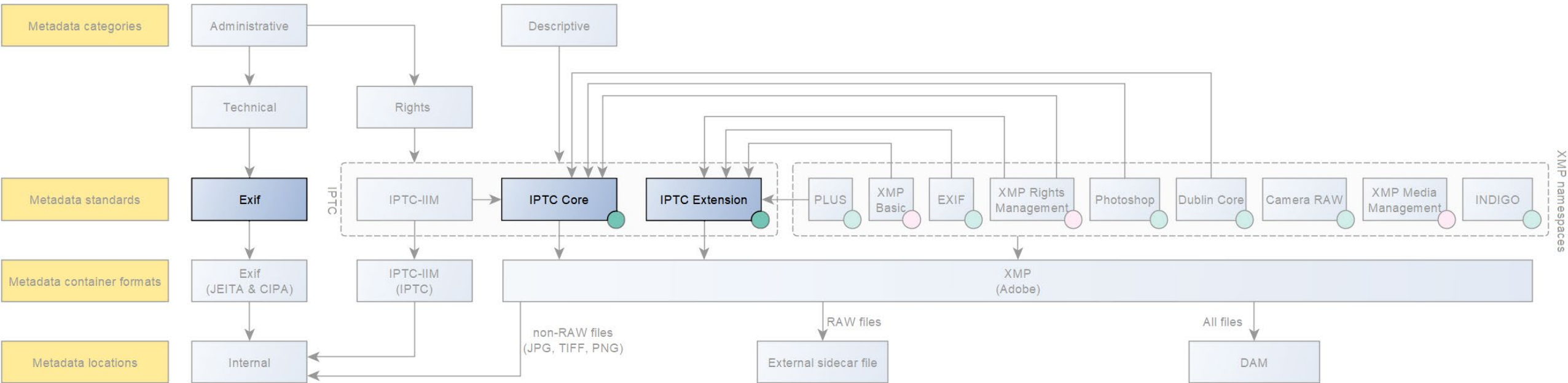

Exif + IPTC

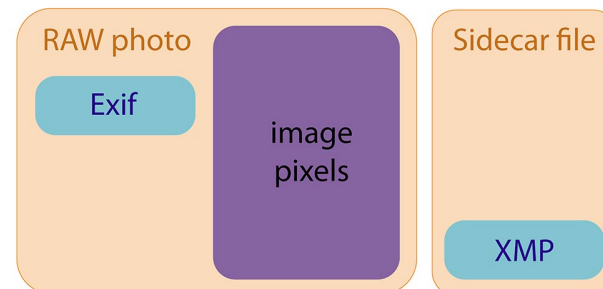
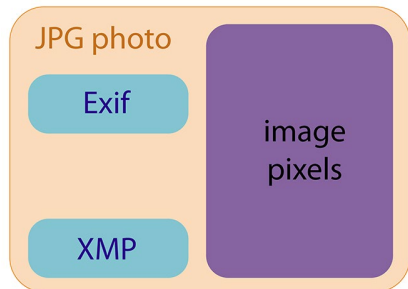
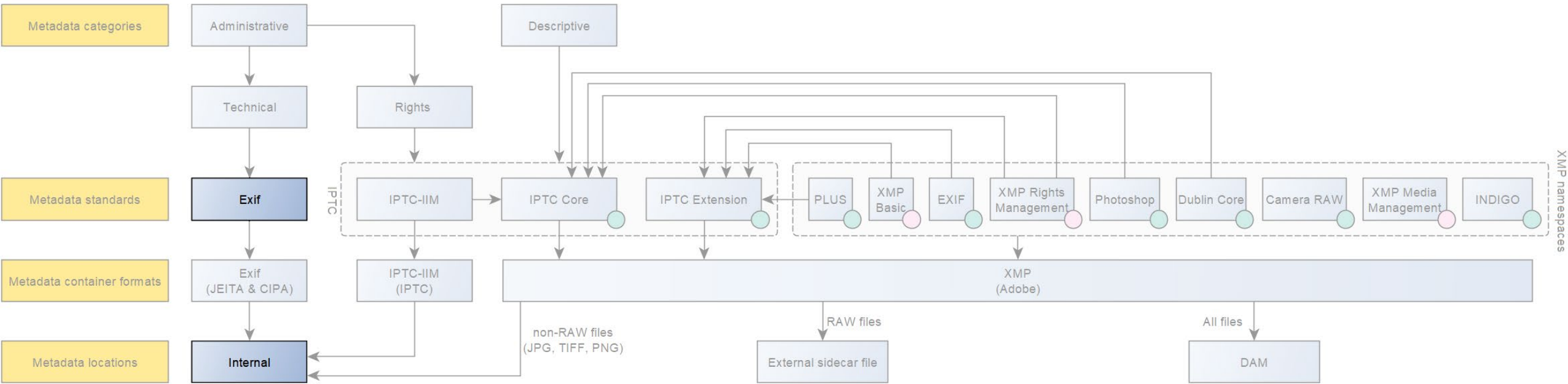

Exif + IPTC

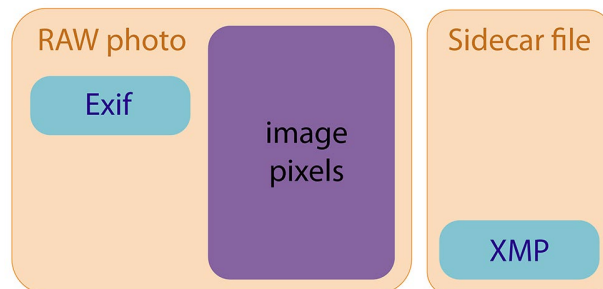
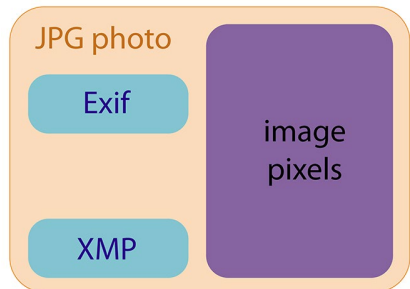
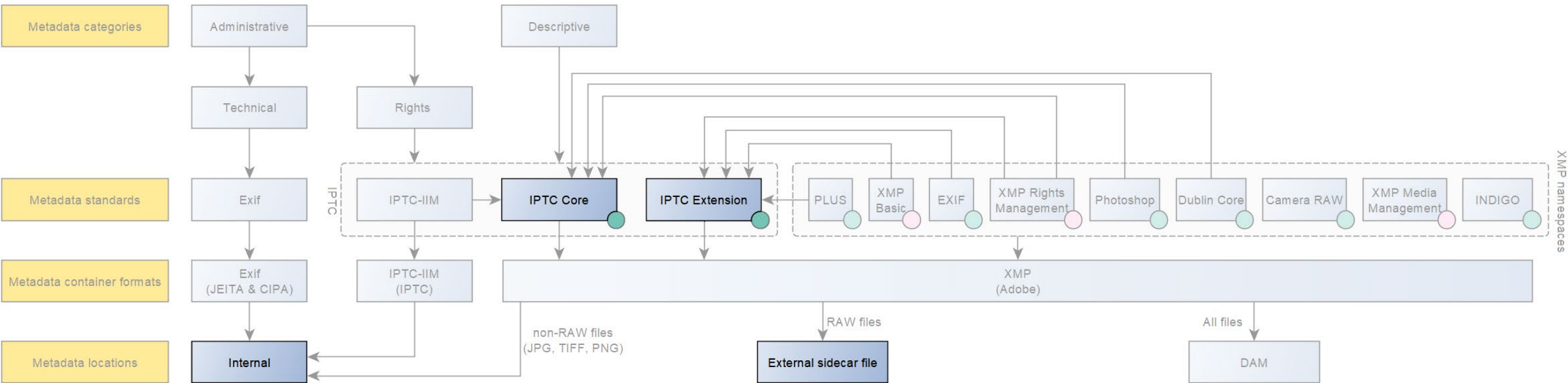

Exif + IPTC

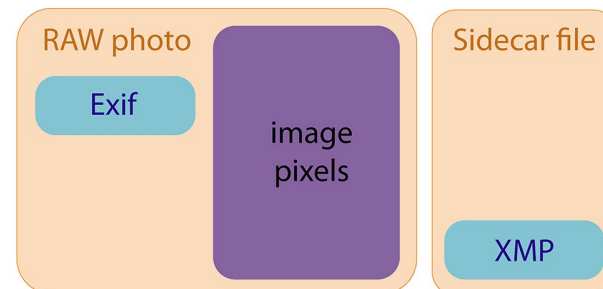
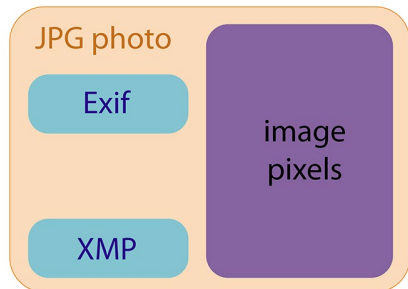
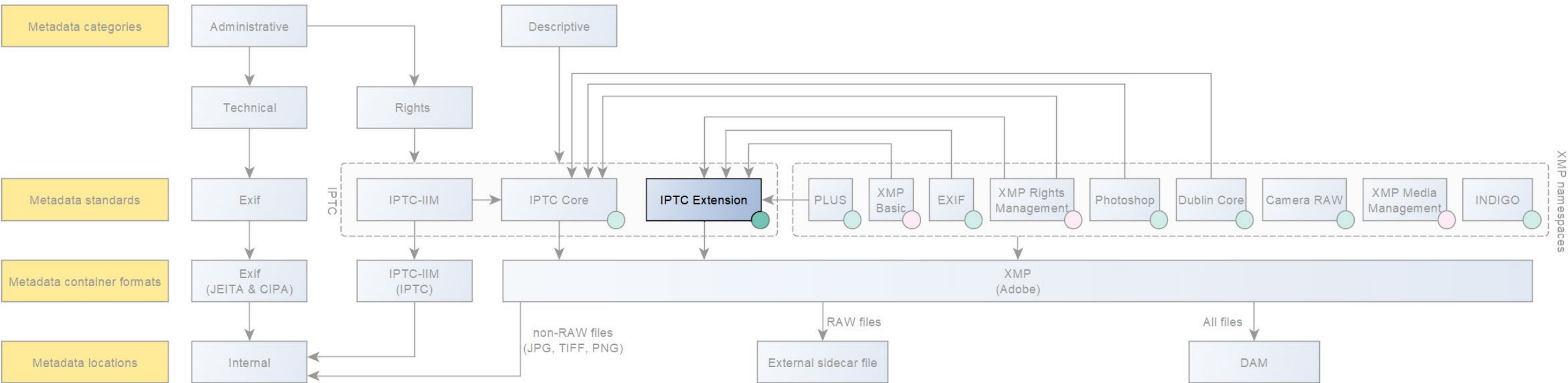

IMAGE region

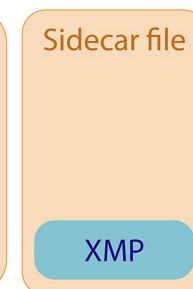
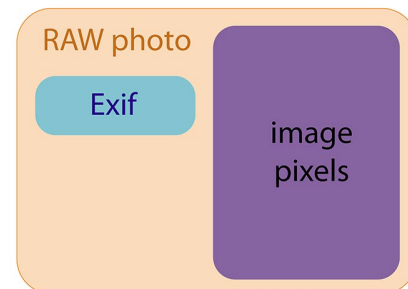
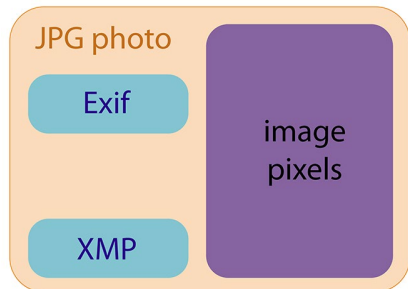
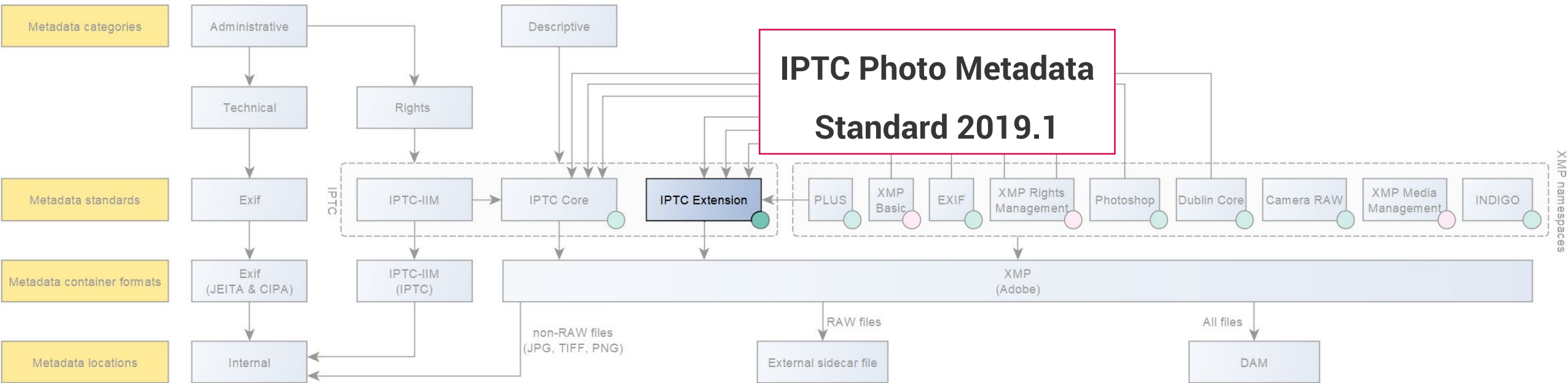



IMAGE region

Row header	Specification
Name	Image Region
Definition	Sets a region inside an image by defining its boundaries. All pixels of the boundary are also part of the region. It may include metadata related to this region.
Label	Image Region(s)
Basic Specs	Data type: Image Region structure / Cardinality: 0..unbounded
History Note(s)	Added by version 1.5 (2019.1)
XMP Specs	Iptc4xmpExt:ImageRegion [Bag ImageRegion structure <External>]
JSON Specs	imageRegion [object/ImageRegion/array]

IMAGE region

Level 1	Level 2	Level 3	User notes	Example

IMAGE region

Level 1	Level 2	Level 3	User notes	Example
Region Boundary	Boundary Shape Boundary Measuring Unit X-Axis Coordinate Y-Axis Coordinate Rectangle Width Rectangle Height Circle Radius Polygon Vertices	X-Axis Coordinate Y-Axis Coordinate	Rectangle, circle, polygon Pixel or relative	

IMAGE region

Level 1	Level 2	Level 3	User notes	Example
Region Boundary	Boundary Shape Boundary Measuring Unit X-Axis Coordinate Y-Axis Coordinate Rectangle Width Rectangle Height Circle Radius Polygon Vertices	X-Axis Coordinate Y-Axis Coordinate	Rectangle, circle, polygon Pixel or relative	INDIGO_20230516_0235
Region Identifier				

IMAGE region

Level 1	Level 2	Level 3	User notes	Example
Region Boundary	Boundary Shape Boundary Measuring Unit X-Axis Coordinate Y-Axis Coordinate Rectangle Width Rectangle Height Circle Radius Polygon Vertices	X-Axis Coordinate Y-Axis Coordinate	Rectangle, circle, polygon Pixel or relative	INDIGO_20230516_0235 Graffito 235
Region Identifier Region Name				

IMAGE region

Level 1	Level 2	Level 3	User notes	Example
Region Boundary	Boundary Shape Boundary Measuring Unit X-Axis Coordinate Y-Axis Coordinate Rectangle Width Rectangle Height Circle Radius Polygon Vertices	X-Axis Coordinate Y-Axis Coordinate	Rectangle, circle, polygon Pixel or relative	
Region Identifier Region Name Region Content Type	Identifier Name			INDIGO_20230516_0235 Graffito 235 URI of term in controlled vocabulary artwork

IMAGE region



NewsCodes Scheme (Controlled Vocabulary)

Results from requesting a Scheme URI

Copyright 2019 IPTC - www.iptc.org. The [Creative Commons Attribution \(CC BY\) 4.0 license](https://creativecommons.org/licenses/by/4.0/) applies to all I

Find a list of all available IPTC NewsCodes vocabularies at <http://cv.iptc.org/newscodes/>

View this scheme in other formats: [NewsML G2 Knowledge Item](#) | [RDF/XML](#) | [RDF/Turtle](#) | [JSON-LD](#)

Find help on using this CV server at <http://dev.iptc.org/NewsCodes-CV-Server>

The shown language(s) is/are: en-GB

Metadata about the scheme/controlled vocabulary

Scheme URI = <http://cv.iptc.org/newscodes/imageregiontype/>

Name_(en-GB): Image Region Type

Definition_(en-GB): Type of thing(s) depicted by a region in an image

* **Concept ID (QCode) = imgregtype:animal, ID (URI) = <http://cv.iptc.org/newscodes/imageregiontype/animal>**

Type: cpnat:abstract | created: 2019-12-06T12:00:00+00:00

Name_(en-GB): animal

Definition_(en-GB): A living organism different from humans or flora

Related concept (skos:exactMatch): <http://www.wikidata.org/entity/Q729>

Member of scheme: <http://cv.iptc.org/newscodes/imageregiontype/>

* **Concept ID (QCode) = imgregtype:artwork, ID (URI) = <http://cv.iptc.org/newscodes/imageregiontype/artwork>**

Type: cpnat:abstract | created: 2019-12-06T12:00:00+00:00

Name_(en-GB): artwork

Definition_(en-GB): Artistic work

Related concept (skos:broadMatch): <http://www.wikidata.org/entity/Q17537576>

Member of scheme: <http://cv.iptc.org/newscodes/imageregiontype/>

Example

INDIGO_20230516_0235

Graffito 235

of term in controlled vocabulary
artwork

Le
Region

Region
Region
Region Co

IMAGE region

Level 1	Level 2	Level 3	User notes	Example
Region Boundary	Boundary Shape Boundary Measuring Unit X-Axis Coordinate Y-Axis Coordinate Rectangle Width Rectangle Height Circle Radius Polygon Vertices		Rectangle, circle, polygon Pixel or relative	
Region Identifier Region Name Region Content Type	Identifier Name	X-Axis Coordinate Y-Axis Coordinate		INDIGO_20230516_0235 Graffito 235 URI of term in controlled vocabulary artwork
Region Role	Identifier Name			URI of term in controlled vocabulary area of interest

IMAGE region

Level 1	Level 2	Level 3	User notes	Example
Region Boundary	Boundary Shape Boundary Measuring Unit X-Axis Coordinate Y-Axis Coordinate Rectangle Width Rectangle Height Circle Radius Polygon Vertices		Rectangle, circle, polygon Pixel or relative	
Region Identifier				INDIGO_20230516_0235
Region Name				Graffito 235
Region Content Type	Identifier Name			URI of term in controlled vocabulary artwork
Region Role	Identifier Name			URI of term in controlled vocabulary area of interest
Other metadata property			Any valid XMP property	Description, contributor, keywords

GRAPHIS



GRAPHIS

Generate Regions and Annotations for PHotos using the IPTC Standard



GRAPHIS structure

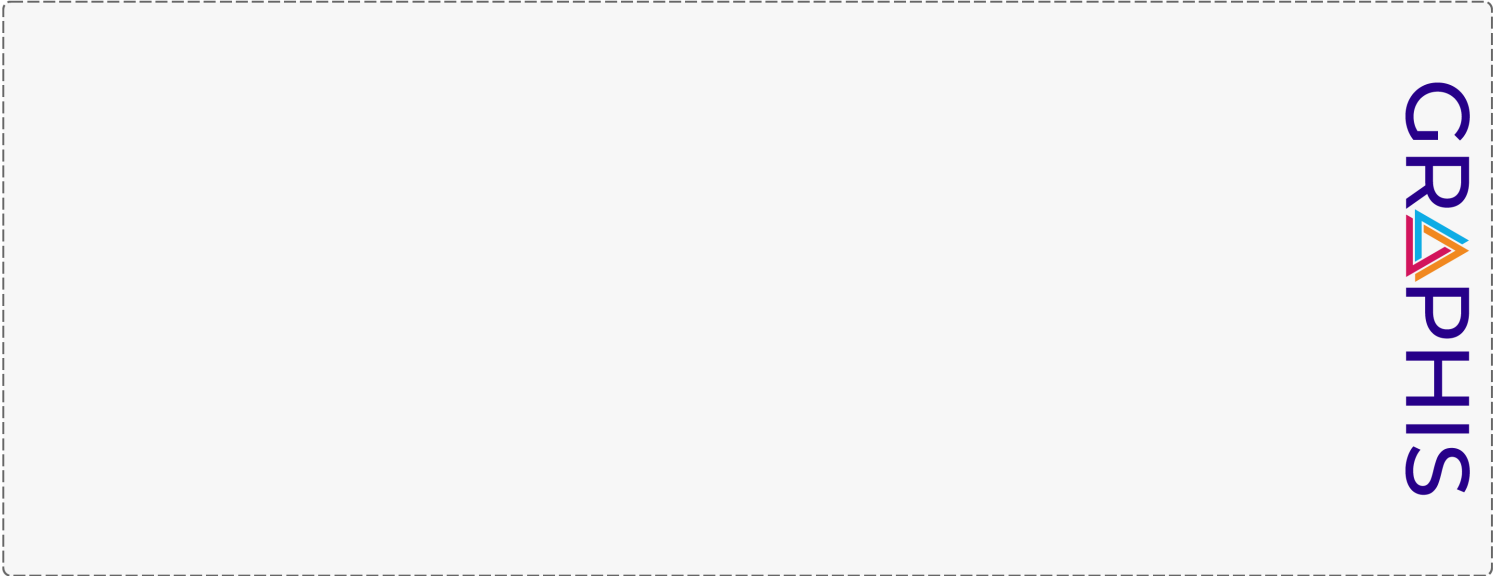

GRAPHIS structure

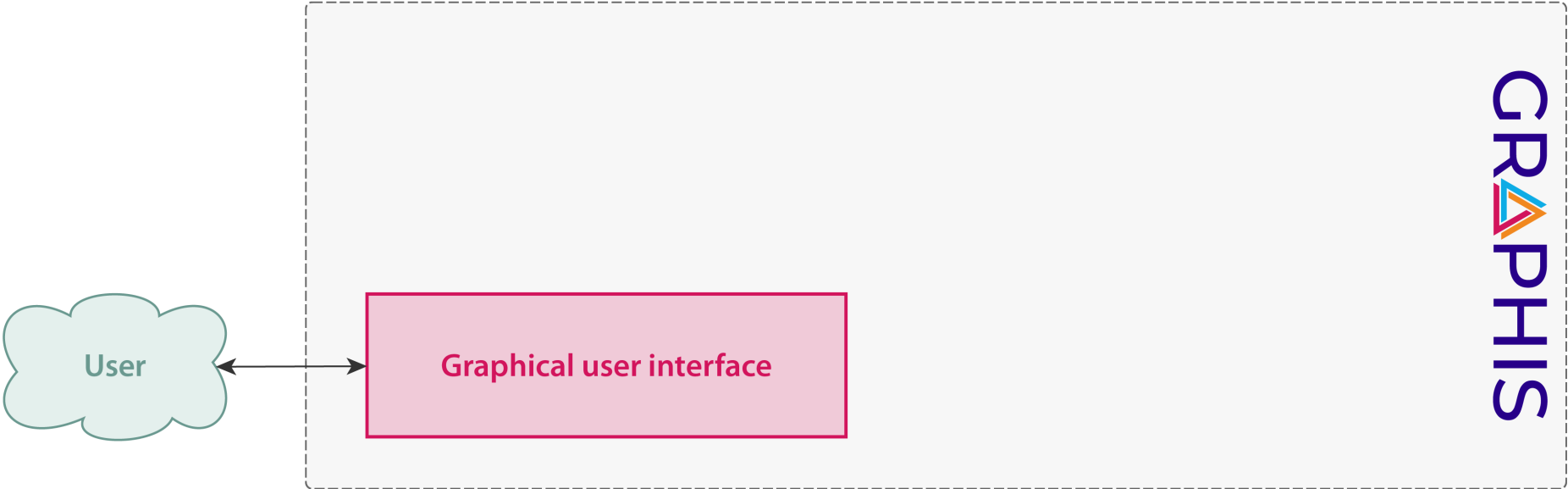

GRAPHIS structure

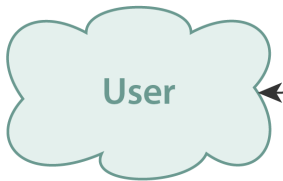
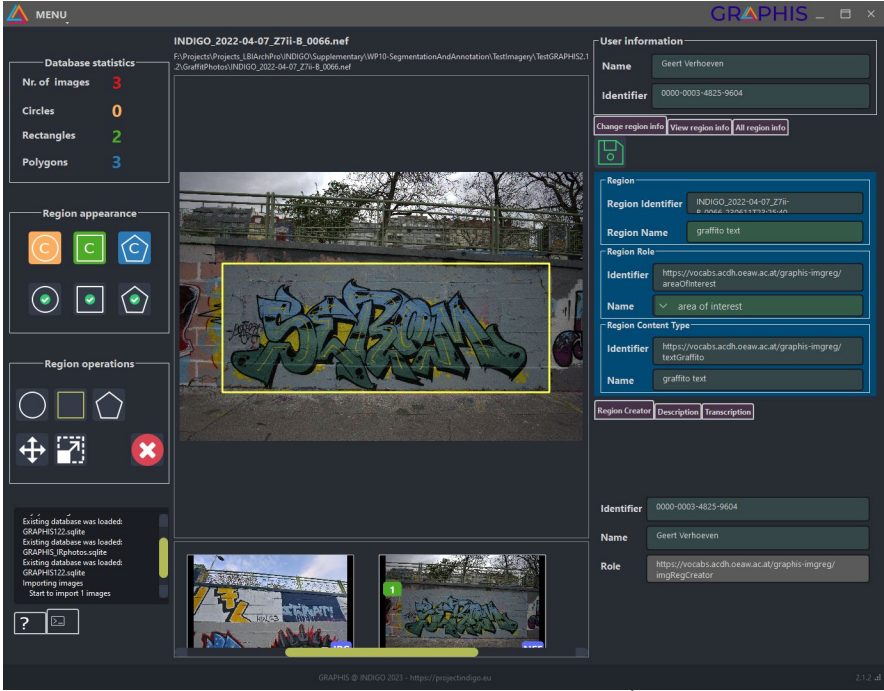

GRAPHIS

GRAPHIS structure

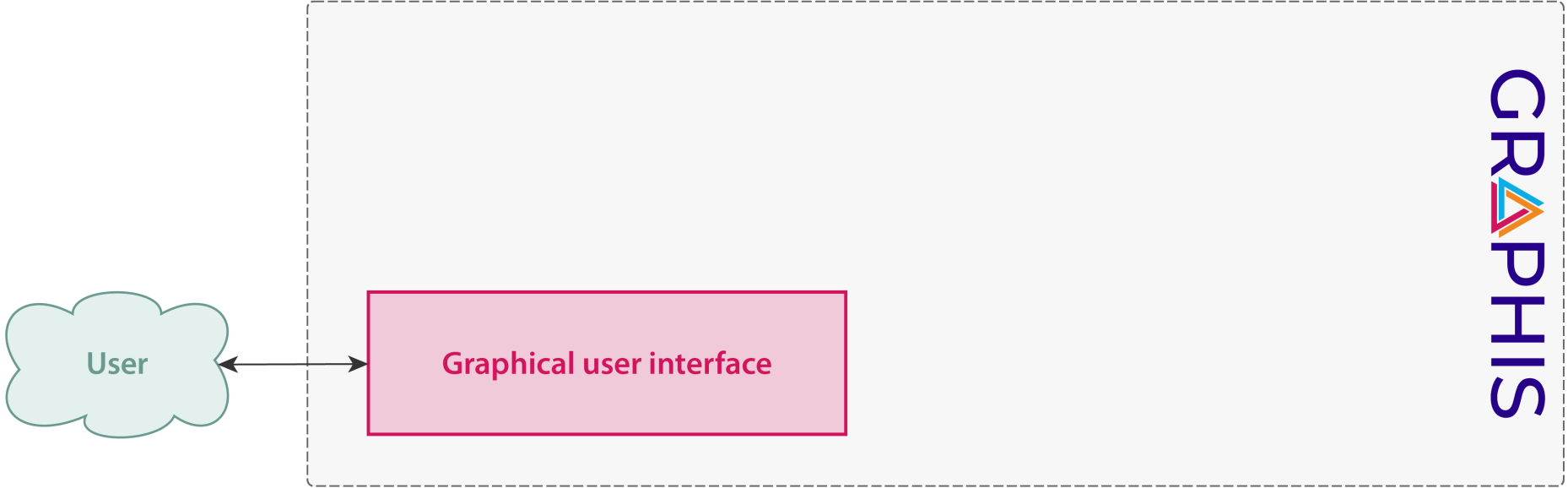

GRAPHIS structure

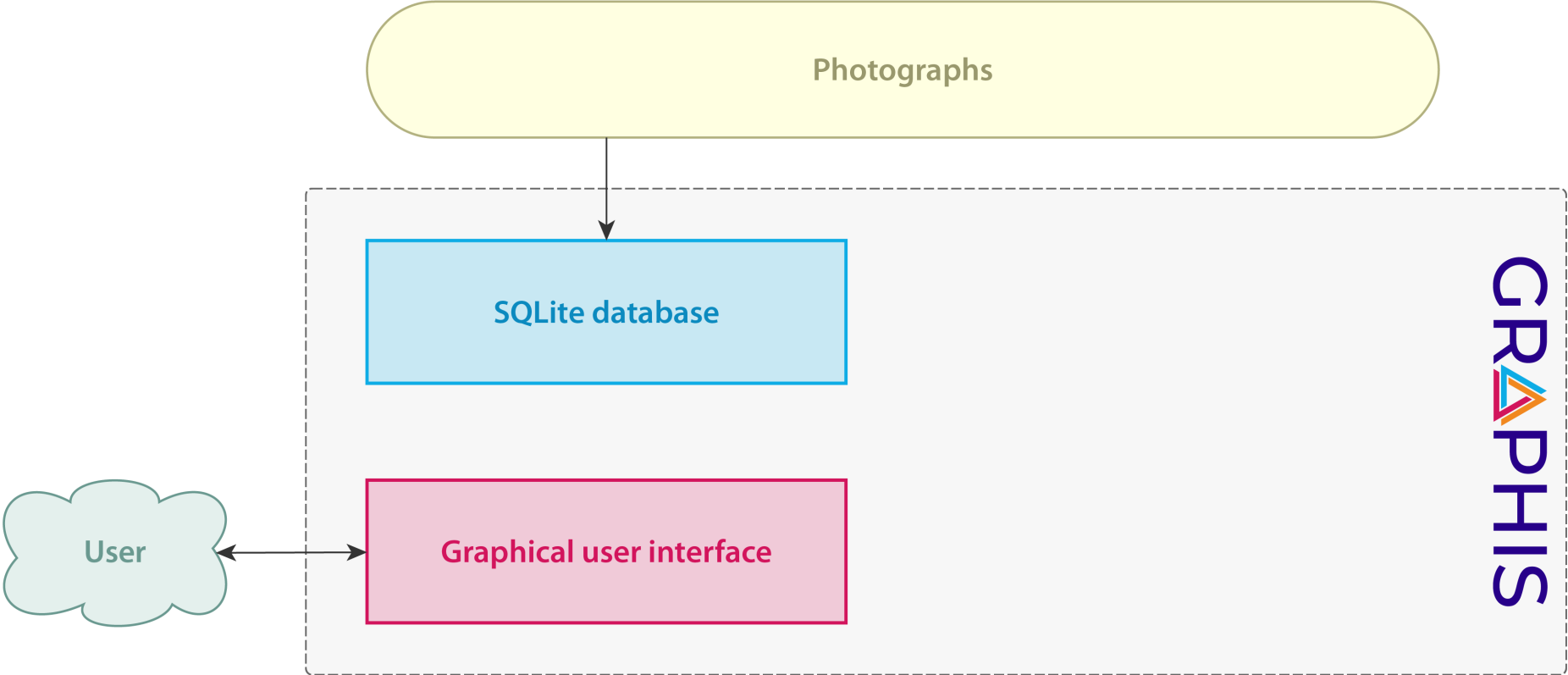

GRAPHIS structure

id	name	width	height	user	deleted_or	path
1	INDIGO_2022-04-07_Z7ii-B_0065.nef	8288	5520	Geert Verhoeven	0	../GraffitPhotos/INDIGO_2022-04-07_Z7ii-B_0065.nef
2	INDIGO_2023-03-27_Z7ii-B_0335.jpg	8256	5504	Geert Verhoeven	0	../GraffitPhotos/INDIGO_2023-03-27_Z7ii-B_0335.jpg
3	INDIGO_2022-04-07_Z7ii-B_0066.nef	8288	5520	Geert Verhoeven	0	../GraffitPhotos/INDIGO_2022-04-07_Z7ii-B_0066.nef

Photographs

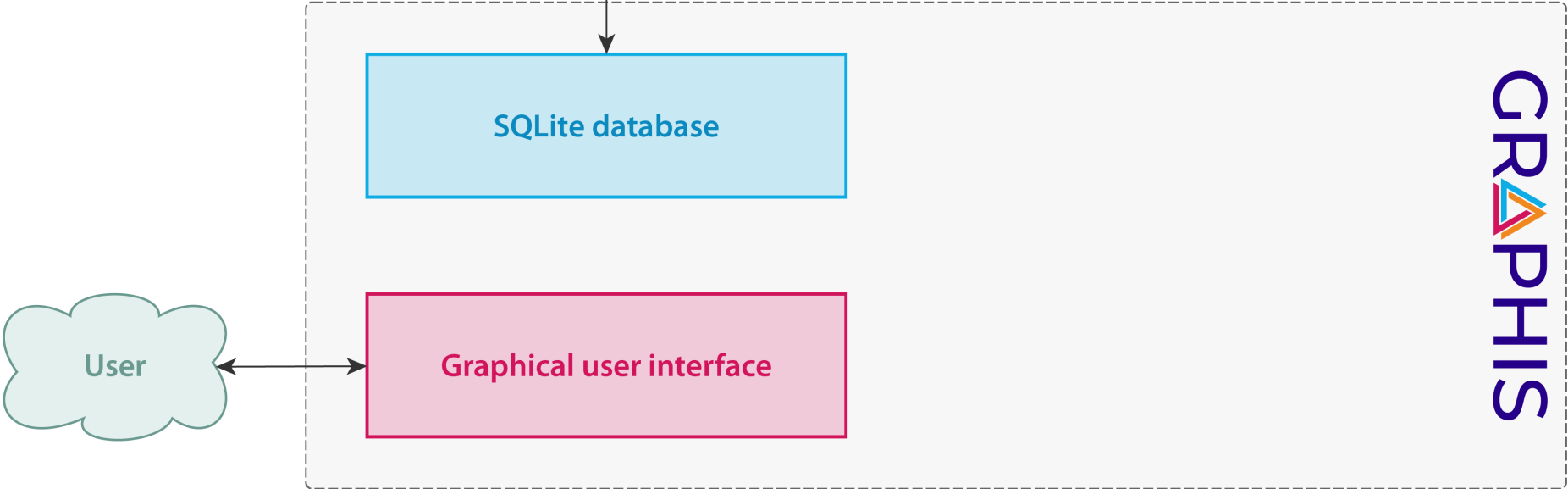

GRAPHIS structure

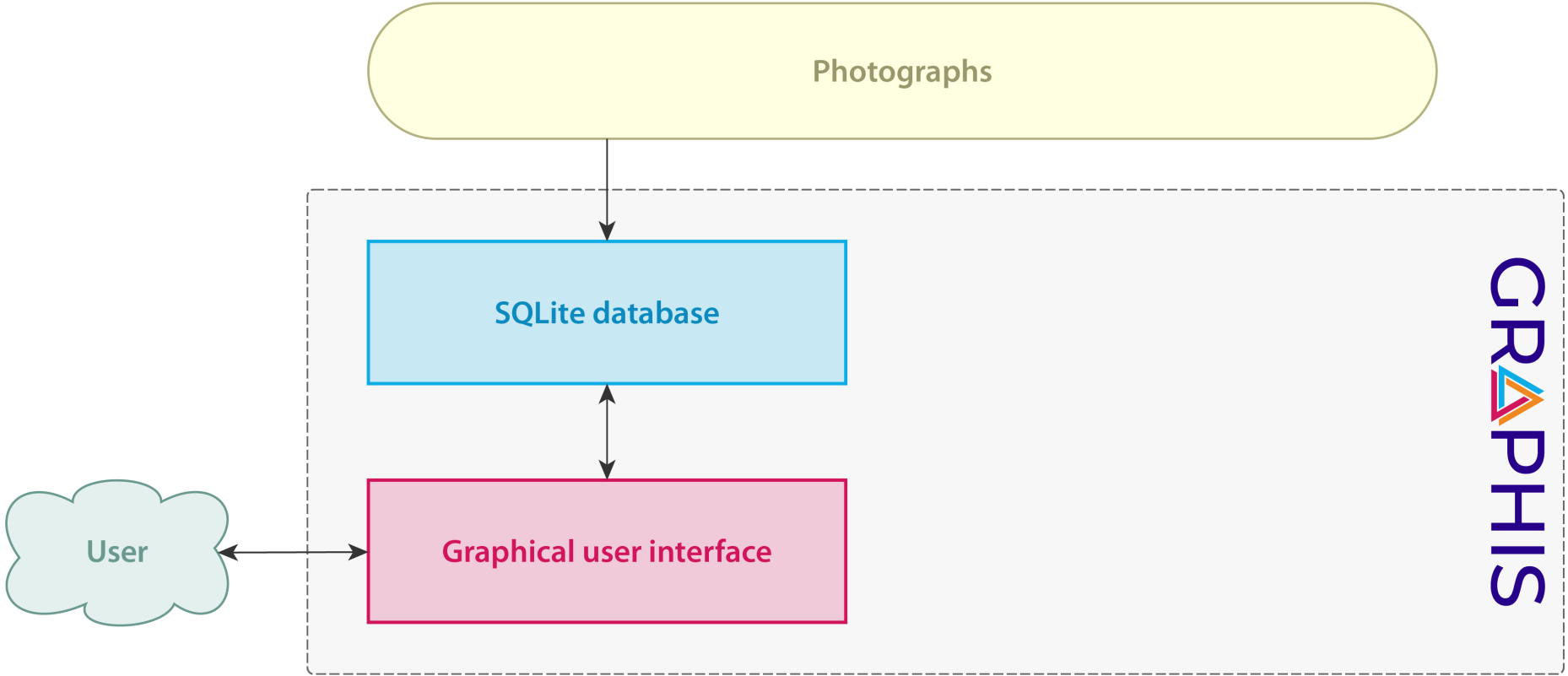

GRAPHIS structure

id	image	user	object_typ	orig_img_r	changed	data
1	1	Geert Verhoeven	polygon	NULL		1 {"attributes": {"RegionBoundary": {"RbUnit": "relative", "RbShape": "polygon", "RbVertices": [{"RbX": 0.5560606060606061, "RbY": 0.3298638559508125}, {"RbX": 0.743939393939394, "RbY": 0.3321387790953009}, {"RbX": 0.7393939393939395, "RbY": 0.7620992534036013}, {"RbX": 0.5522727272727274, "RbY": 0.7632367149758454}], "RcType": [{"Identifier": ["https://vocabs.acdh.oew.ac.at/graphis-imagreg/graffiti"], "Name": "graffito"}, {"Rid": "INDIGO_2022-04-07_Z7ii-B_0065_230603T22:24:31", "Name": "graffito", "RRole": [{"Identifier": ["https://vocabs.acdh.oew.ac.at/graphis-imagreg/mainSubjectArea"], "Name": "main subject area"}], "XMP-iptcExt:Contributor": [{"Identifier": ["0000-0003-4825-9604"], "Name": "Geert Verhoeven", "Role": ["https://vocabs.acdh.oew.ac.at/graphis-imagreg/imgRegCreator"]}], [{"Identifier": ["0000-0003-4825-9604"], "Name": "Geert Verhoeven", "Role": ["https://vocabs.acdh.oew.ac.at/graphis-imagreg/descrWriter"]}], "XMP-dc:Description": "24 pachtes of the X-Rite CCP2"}, {"coords": [[4608.630303030303, 1820.848484848485], [6165.769696969697, 1833.4060606060607], [6128.0969696969705, 4206.7878787879], [4577.236363636364, 4213.066666666667]]}}
2	1	Geert Verhoeven	polygon	NULL		1 {"attributes": {"RegionBoundary": {"RbUnit": "relative", "RbShape": "polygon", "RbVertices": [{"RbX": 0.2772727272727273, "RbY": 0.29119016249451035}, {"RbX": 0.7515151515151516, "RbY": 0.29119016249451035}, {"RbX": 0.7484848484848485, "RbY": 0.8041853315766359}, {"RbX": 0.27272727272727276, "RbY": 0.7996354852876592}], "RcType": [{"Identifier": ["https://vocabs.acdh.oew.ac.at/graphis-imagreg/graffiti"], "Name": "graffito"}, {"Rid": "INDIGO_2022-04-07_Z7ii-B_0065_230603T22:25:18", "Name": "graffito", "RRole": [{"Identifier": ["https://vocabs.acdh.oew.ac.at/graphis-imagreg/mainSubjectArea"], "Name": "main subject area"}], "XMP-iptcExt:Contributor": [{"Identifier": ["0000-0003-4825-9604"], "Name": "Geert Verhoeven", "Role": ["https://vocabs.acdh.oew.ac.at/graphis-imagreg/imgRegCreator"]}], [{"Identifier": ["0000-0003-4825-9604"], "Name": "Geert Verhoeven", "Role": ["https://vocabs.acdh.oew.ac.at/graphis-imagreg/descrWriter"]}], "XMP-dc:Description": "CCPP2 (without black border)"}, {"coords": [[2298.0363636363636, 1607.369696969697], [6228.557575757576, 1607.369696969697], [6203.442424242425, 4439.10303030303], [2260.3636363636365, 4413.987878787879]]}}
3	1	Geert Verhoeven	polygon	NULL		1 {"attributes": {"RegionBoundary": {"RbUnit": "relative", "RbShape": "polygon", "RbVertices": [{"RbX": 0.26136363636363636, "RbY": 0.25137900746596403}, {"RbX": 0.7810606060606066, "RbY": 0.2582037768994292}, {"RbX": 0.7795454545454551, "RbY": 0.8394466403162062}, {"RbX": 0.2507575757575758, "RbY": 0.8337593324549856}, {"RbX": 0.25227272727272726, "RbY": 0.7791611769872647}], "RcType": [{"Identifier": ["https://vocabs.acdh.oew.ac.at/graphis-imagreg/graffiti"], "Name": "graffito"}, {"Rid": "INDIGO_2022-04-07_Z7ii-B_0065_230603T22:25:44", "Name": "graffito", "RRole": [{"Identifier": ["https://vocabs.acdh.oew.ac.at/graphis-imagreg/mainSubjectArea"], "Name": "main subject area"}], "XMP-iptcExt:Contributor": [{"Identifier": ["0000-0003-4825-9604"], "Name": "Geert Verhoeven", "Role": ["https://vocabs.acdh.oew.ac.at/graphis-imagreg/imgRegCreator"]}], [{"Identifier": ["0000-0003-4825-9604"], "Name": "Geert Verhoeven", "Role": ["https://vocabs.acdh.oew.ac.at/graphis-imagreg/descrWriter"]}], "XMP-dc:Description": "XXPP2 with black border"}, {"coords": [[2166.1818181818176, 1387.61212121216], [6473.430303030307, 1425.2848484848491], [6460.872727272732, 4633.745454545458], [2078.278787878788, 4602.35151515152], [2090.8363636363633, 4300.9696969697015]]}}

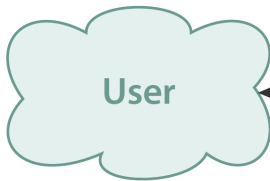

GRAPHIS

GRAPHIS structure

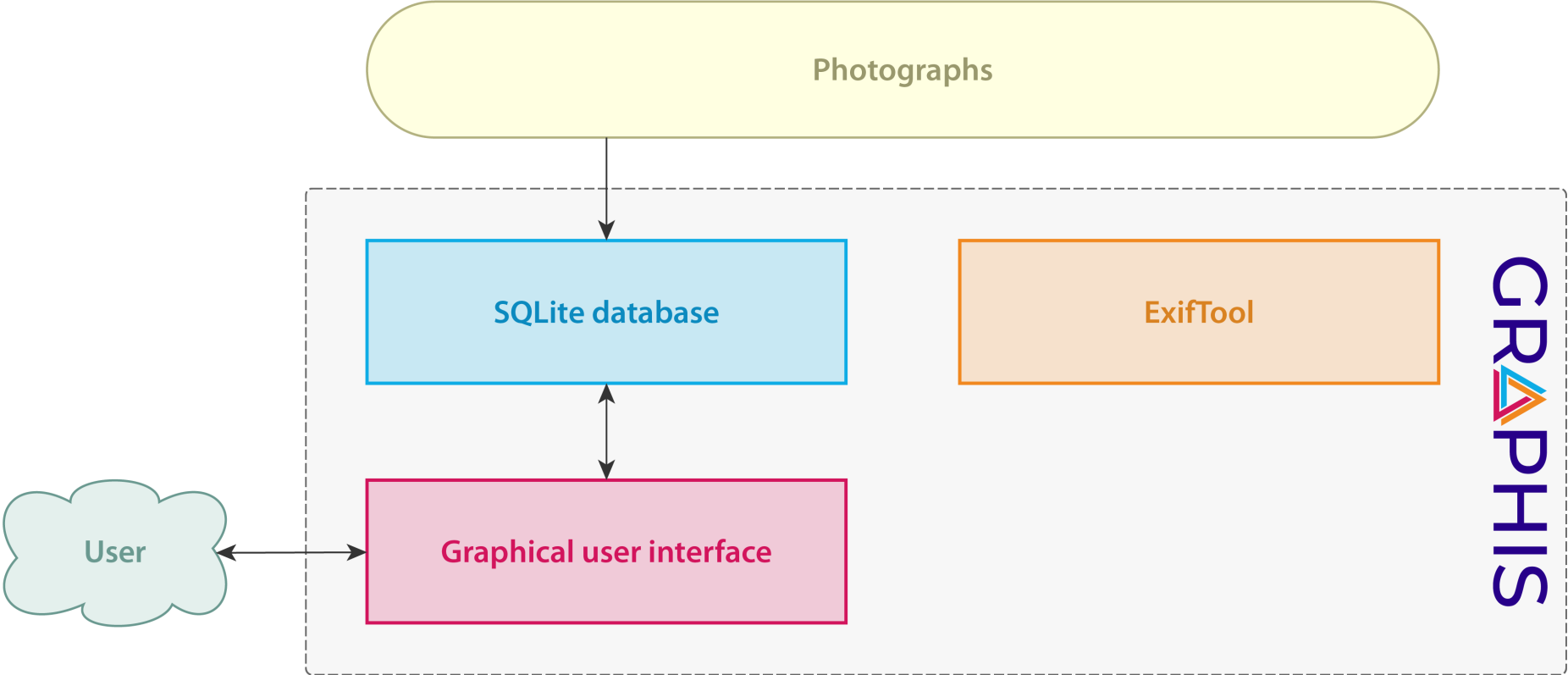

GRAPHIS structure

ExifTool by Phil Harvey

Read, Write and Edit Meta Information!

Also available --> [Utility to fix Nikon NEF images corrupted by Nikon software](#)

Note: If exiftool.org goes down, it is because of the crappy DreamHost web hosting which disables an "url" tag. See <http://exiftool.sourceforge.net/>

Installing	Tag Names	Re
------------	-----------	----

[Download Version 12.63 \(5.0 MB\) - June 8, 2023](#)

ExifTool is a platform-independent [Perl library](#) plus a [command-line application](#) for reading, writing [EXIF](#), [GPS](#), [IPTC](#), [XMP](#), [JFIF](#), [GeoTIFF](#), [ICG Profile](#), [Photoshop IRB](#), [FlashPix](#), [AFCP](#) and [ID3](#), [Lyrics3](#), [a Leaf](#), [Minolta/Konica-Minolta](#), [Motorola](#), [Nikon](#), [Nintendo](#), [Olympus/Epson](#), [Panasonic/Leica](#), [Pentax/Asah](#)

ExifTool is also available as a **stand-alone Windows executable** and a **MacOS package**: *(Note that the above)*

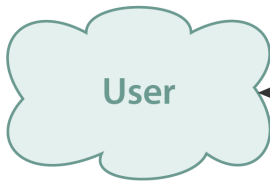

GRAPHIS

GRAPHIS structure

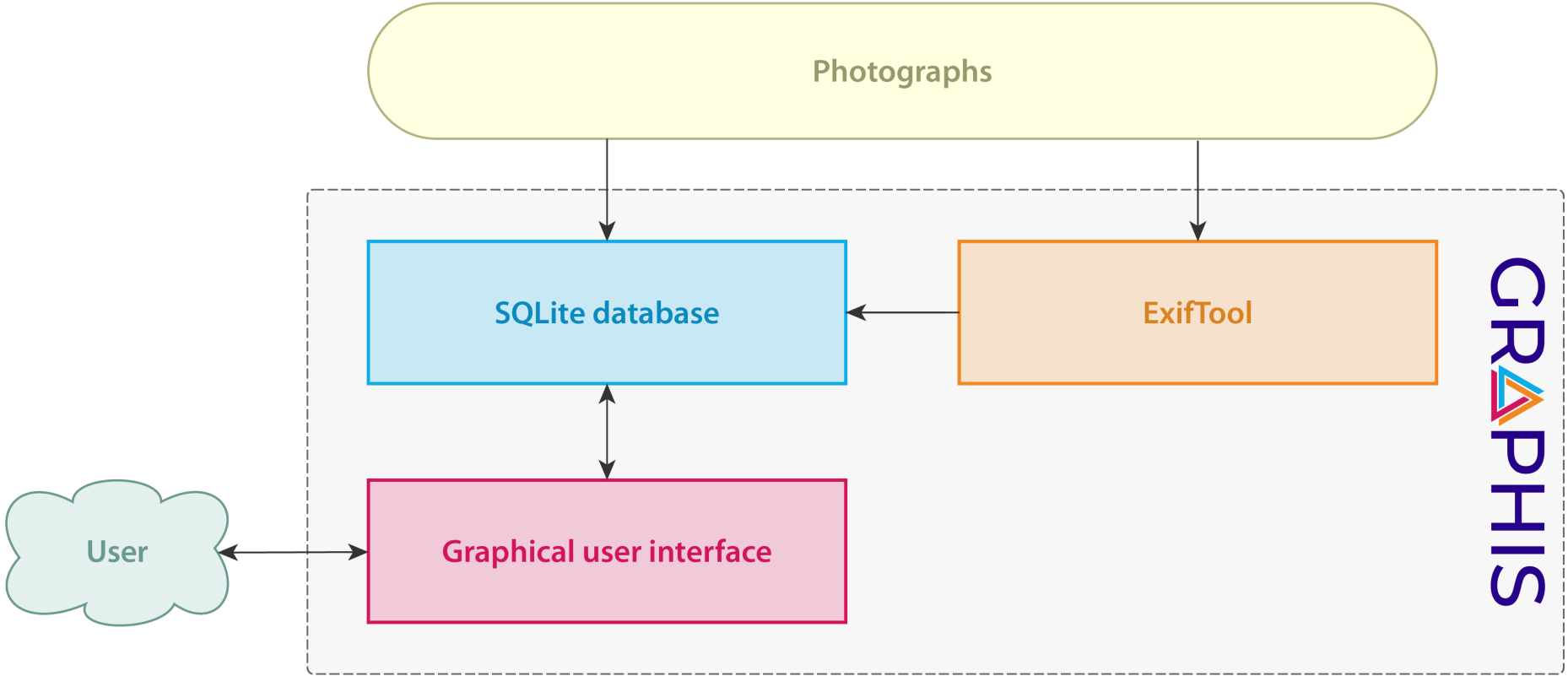

GRAPHIS structure

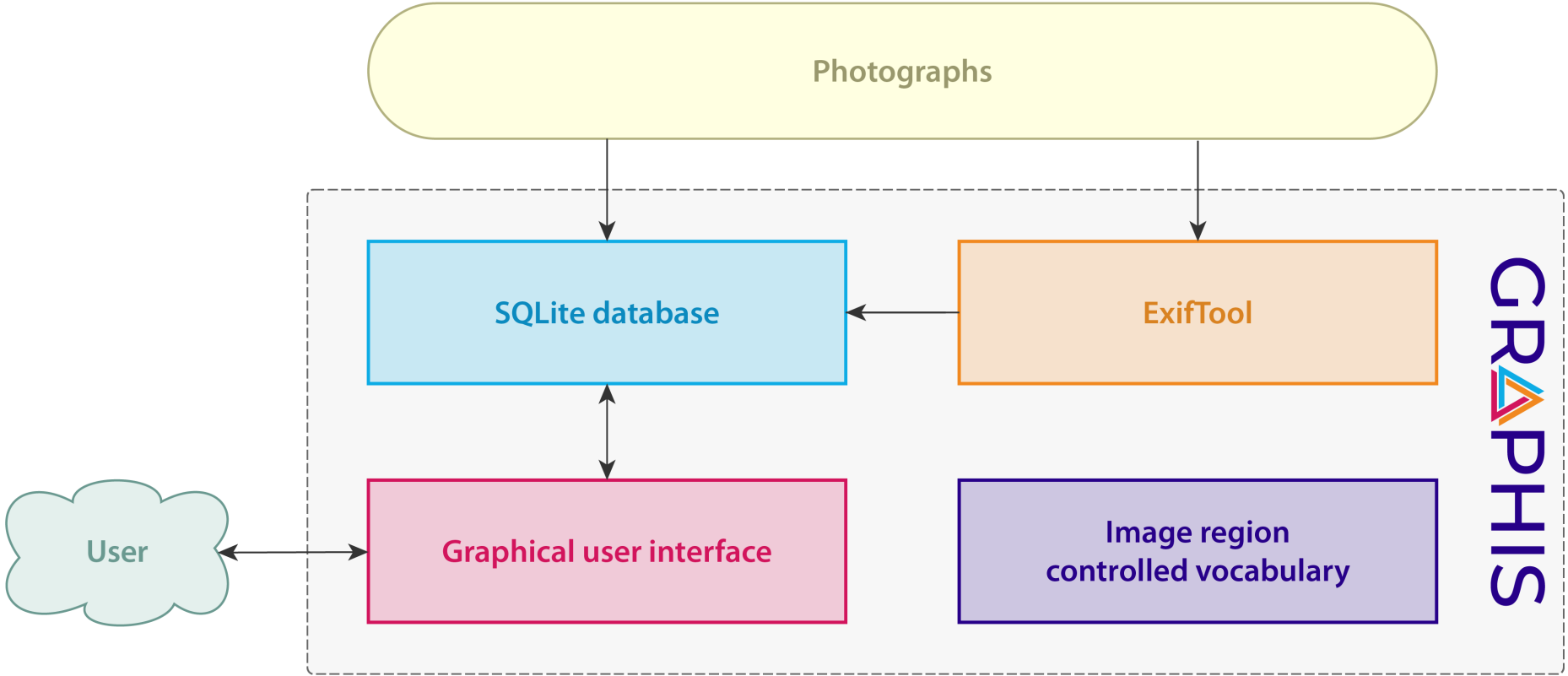

GRAPHIS structure

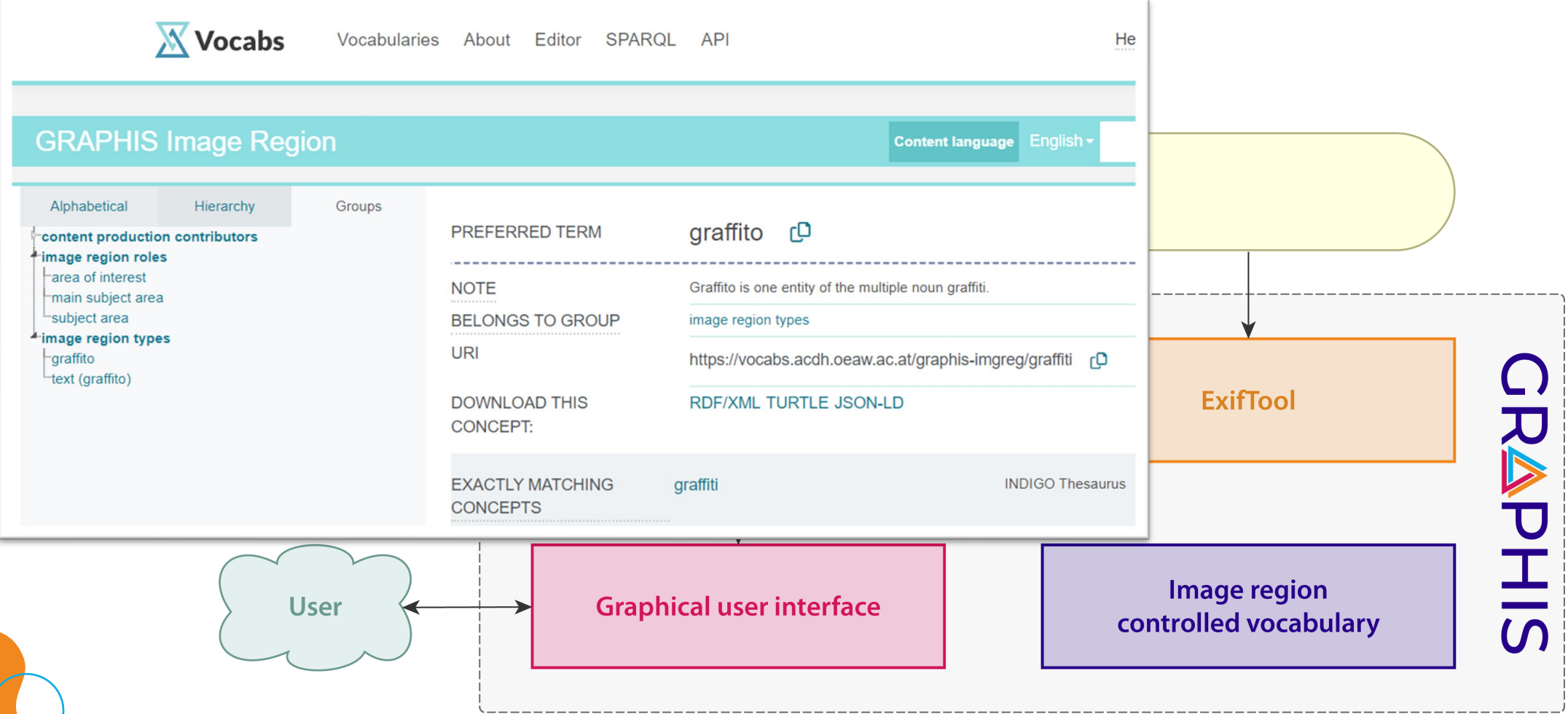

GRAPHIS structure

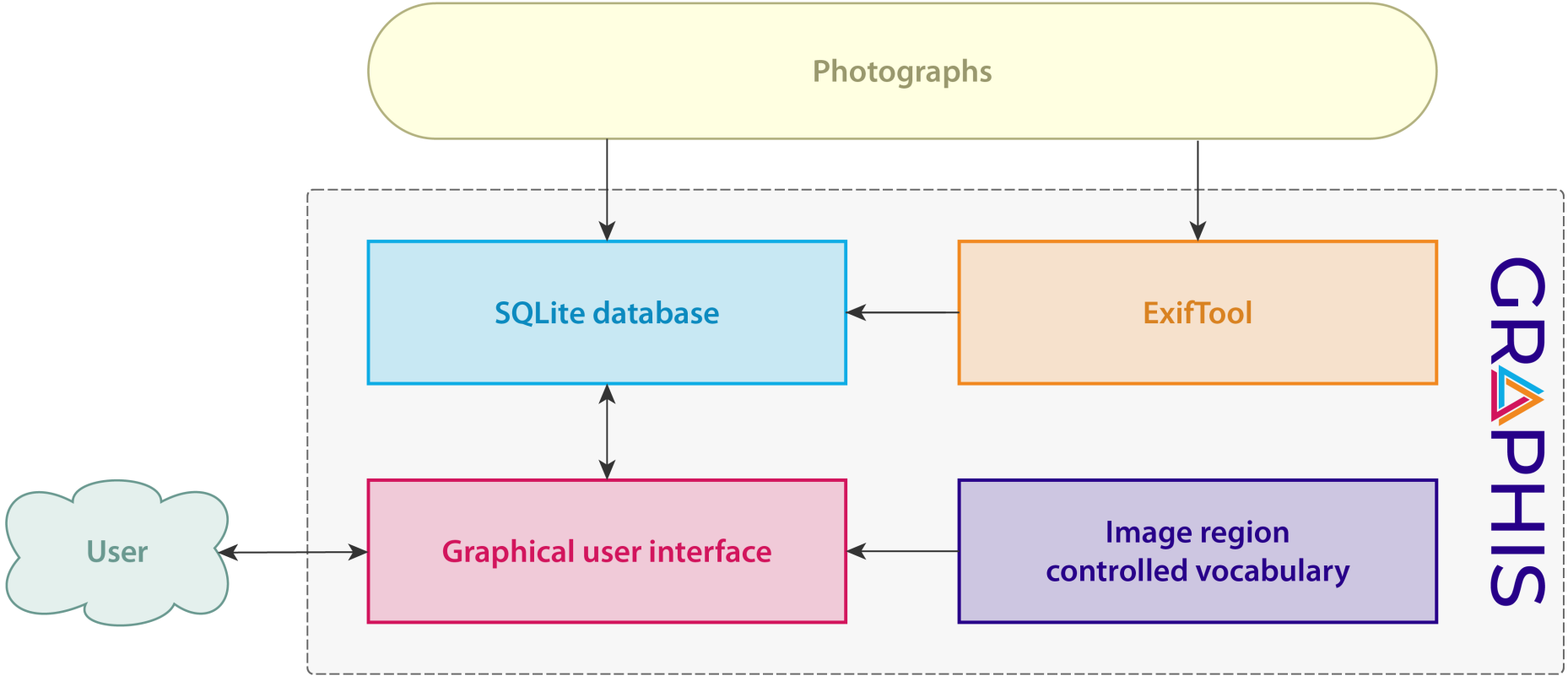

GRAPHIS structure

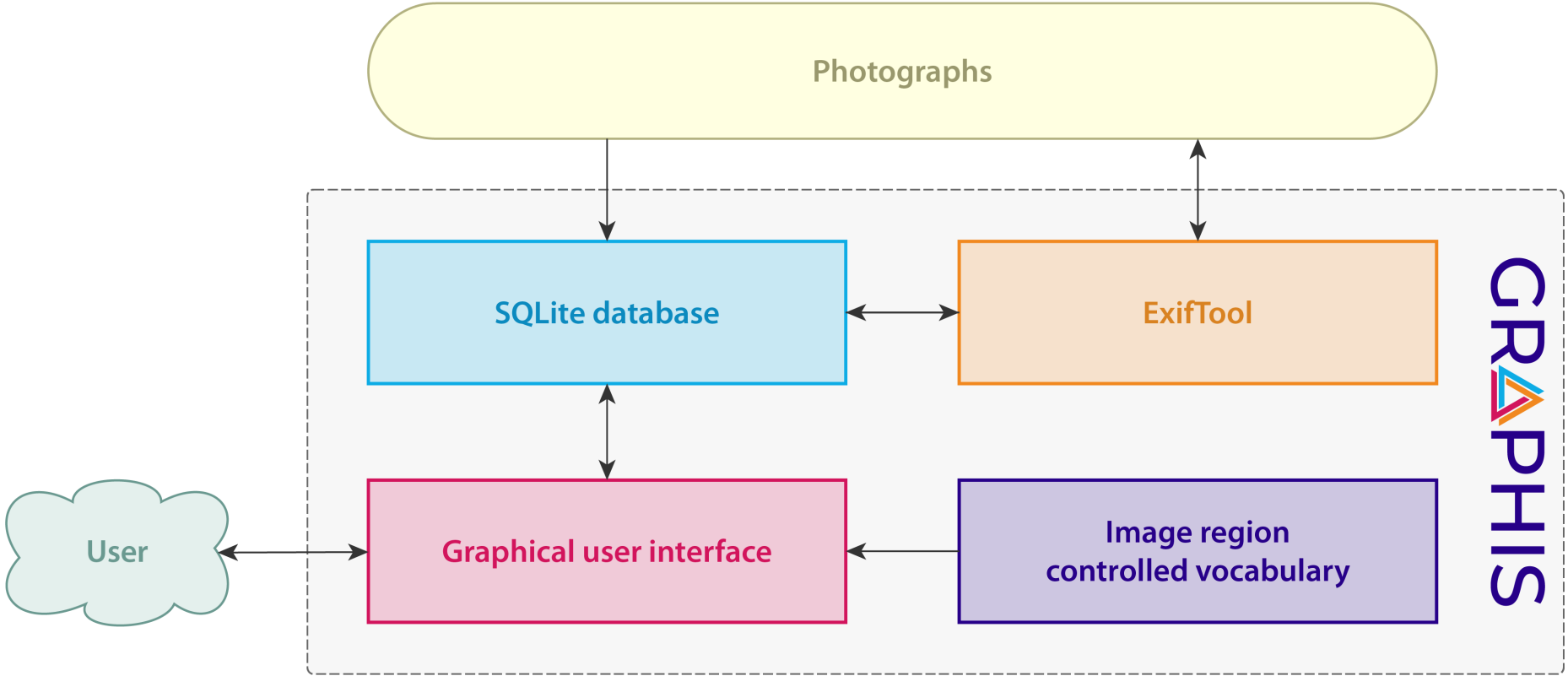

GRAPHIS structure

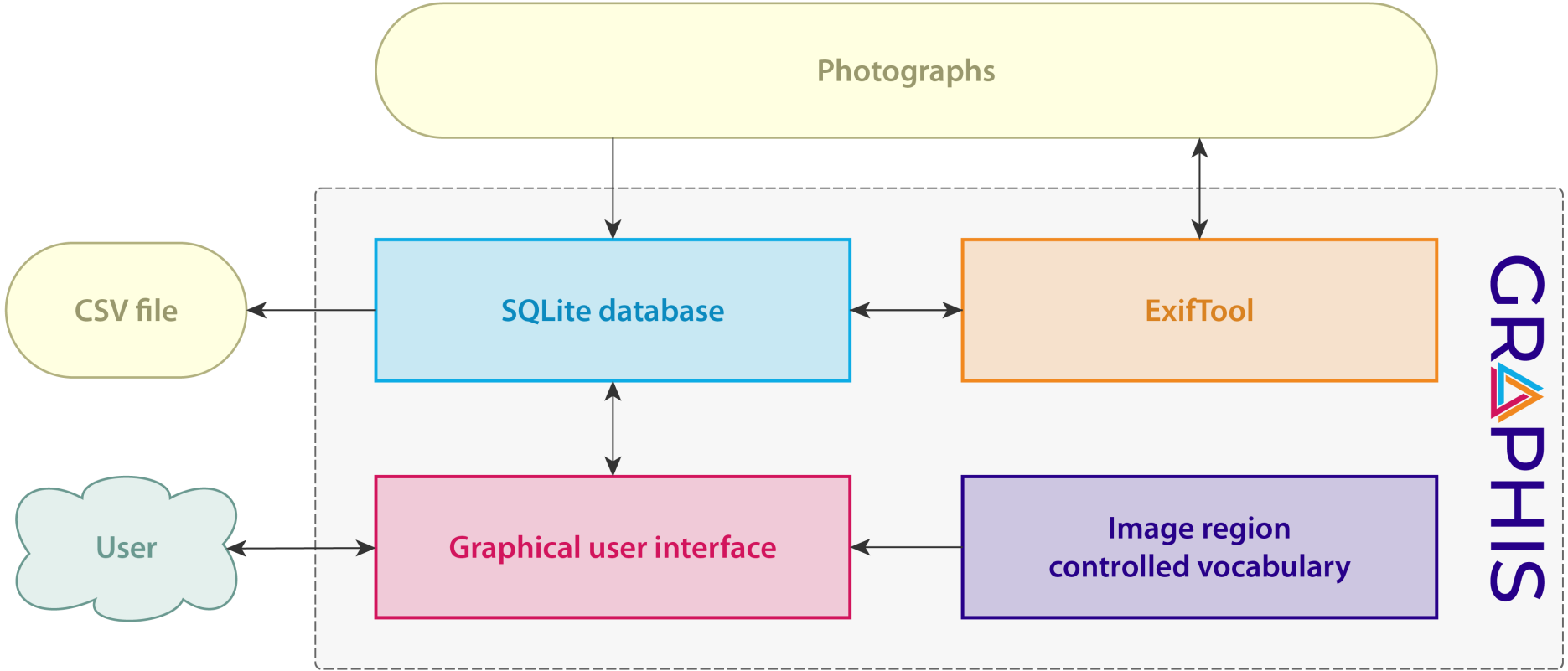

GRAPHIS

open source | free

<https://github.com/GraffitiProjectINDIGO/GRAPHIS>

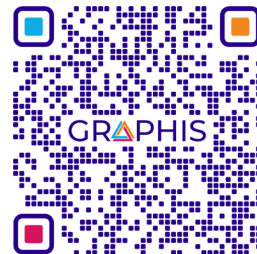

GRAPHIS demo

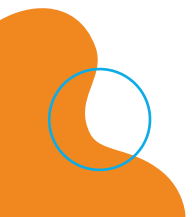



INDIGO

core division

real graffiti
physical resource

derivatives
digital resources

digital photos

polygons

orthophotographs

textured 3D models

metadata

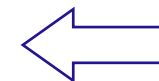

metadata



INDIGO

core division

real graffiti
physical resource

derivatives
digital resources

polygons



FIVE **purposes**

real graffito
physical resource

derivatives
digital resources

polygons



FIVE **purposes**

real graffito
physical resource

derivatives
digital resources

graffito text

polygons





FIVE **purposes**

real graffiti
physical resource

derivatives
digital resources

graffito text

polygons

graffito outline





FIVE purposes

real graffiti
physical resource

derivatives
digital resources

graffito text

polygons

graffito outline

orthophotos

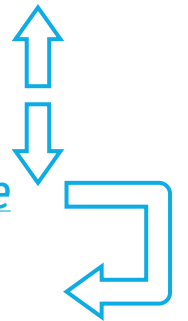

FIVE purposes

real graffito
physical resource

derivatives
digital resources

transcription

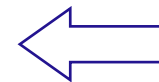

graffito text

polygons

graffito outline

orthophotos



FIVE purposes

real graffiti
physical resource

transcription

dimensions
area & perimeter

derivatives
digital resources

graffito text

polygons

graffito outline

orthophotos

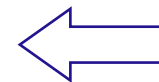
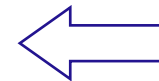

FIVE

purposes

real graffiti
physical resource

transcription
colours
dimensions
area & perimeter

derivatives
digital resources

graffito text
polygons
graffito outline
orthophotos

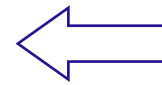
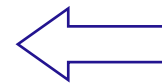

FIVE

purposes

real graffiti
physical resource

transcription
colours
dimensions
area & perimeter
temporality

derivatives
digital resources

graffito text
polygons
graffito outline
orthophotos

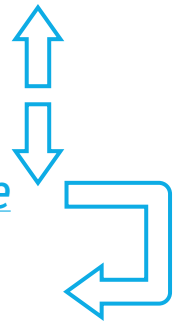
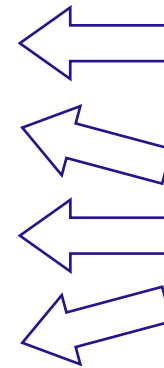

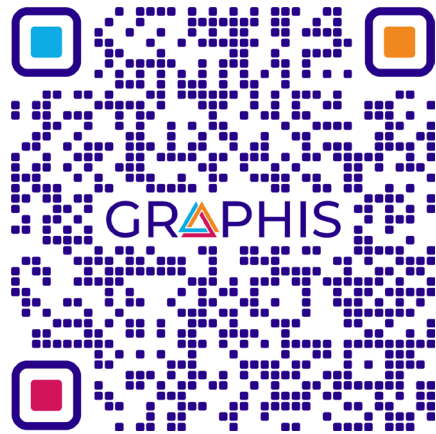

Martin Wieser
Geert Verhoeven
Massimiliano Carloni

projectindigo.eu

The INDIGO graffiti project is funded by the Heritage Science Austria programme of the Austrian Academy of Sciences (ÖAW)

