

Data-Based Estimation of the Dynamic Reliability and Performance Indicator of an Industrial Manufacturing System



Ondo Boniface, Nasso Toumba Richard, Ombété Tsimi Giscard, Kombé Timothée, Elé Pierre

Abstract: *The aim is to develop a more simple and effective method's performance and dynamic reliability assessment for complex industrial systems. By using the operating data of the industrial system characterized by a strong desynchronization and applying to it prediction algorithms of artificial intelligence applied to the time series, the model will have learned from the behavior of the complex manufacturing system allowing the operator or decision-maker to better orientate the maintenance, production, and quality policies. Furthermore, we propose this approach to avoid tedious mathematical methods related to dynamic reliability calculations and performance evaluation to make forecasts of the company's operation over a long period by identifying future bottlenecks in the system's behavior. The low-performance indicators and irrelevant reliability presented by many third-generation industries are due to the lack of efficient and simple tools for reliability assessment taking into account the dynamic aspect of the different elements of the production chain, maintenance department, production department, and quality department. We propose to develop a model that will abstract from conventional, complex, and inefficient mathematical methods for systems subject to combinatorial explosion problems in the manufacturing industry.*

Keywords: *Dynamic Reliability, Performance Indicators, Complex Industrial System, Long Short-Term Memory (LSTM) Architecture.*

I. INTRODUCTION

Manufacturing industries are looking for a simple and efficient method to investigate the dynamic aspect of reliability and performance of systems that are becoming increasingly complex due to desynchronization, redundancies, and scaling factors. Several methods are proposed, including formulas and mathematical laws of

dependability [1-7]. But these mathematical methods, taking into account the architecture and the nature of the equipment, are often very complicated to put into practice. For this reason, in this paper, we propose a new method to study the prediction of failures and performances of a complex industrial system by analyzing the operating data during the different times of operation and shutdown of the system based on artificial intelligence and the NFE60-182 standard [6-9].

II. LITERATURE REVIEW

The manufacturing industry is a challenging environment due to its structure, the complex nature of the equipment, and the coexistence of technologies. Determining reliability, performance, or setting up maintenance planning remain challenges. The work published in [10] uses MTBF and MTTR data to estimate the performance of a production system. To better plan maintenance and operational costs, [1] presents in its scientific work a resilience-based approach to optimize maintenance costs. [8] To further understand the depth of the challenges, [11] emphasizes in its published work the role of reliability engineering in the design, manufacture, maintenance, and replacement of industrial products. The work of [2] demonstrates that the nature of industrial manufacturing systems is becoming increasingly complex and requires more appropriate analysis tools. Finally, the scientific work of [12] shows how, from the raw data collected on an electrical network, one can make an analysis of the reliability of this network. In this paper, we present a method for evaluating the performance and reliability of a manufacturing system based on reliability and performance indicators.

Manuscript received on 26 February 2023 | Revised Manuscript received on 07 March 2023 | Manuscript Accepted on 15 April 2023 | Manuscript published on 30 April 2023.

*Correspondence Author(s)

Ondo Boniface*, Laboratory of Technology and Applied Sciences, University of Douala, Cameroon. Email: bonitoondo@gmail.com, ORCID ID: <https://orcid.org/0009-0000-7441-0334>

Nasso Toumba Richard, Laboratory of Technology and Applied Sciences, University of Douala, Cameroon. Email: richardnassoutoumba4@gmail.com, ORCID ID: <https://orcid.org/0009-0006-7596-1860>

Ombété Tsimi Giscard, Laboratory of Technology and Applied Sciences, University of Douala, Cameroon. Email: tsimidaniel@gmail.com, ORCID: <https://orcid.org/0009-0002-8304-3710>

Kombé Timothée, Laboratory of Technology and Applied Sciences, University of Douala, Cameroon.

Elé Pierre, Laboratory of Technology and Applied Sciences, University of Douala, Cameroon.

© The Authors. Published by Blue Eyes Intelligence Engineering and Sciences Publication (BEIESP). This is an open access article under the CC-BY-NC-ND license <http://creativecommons.org/licenses/by-nc-nd/4.0/>

Table-I: Raw Data from The Company

	MTBF	MTTR	Availability rate	Quality rate	Performance rate	Operational availability	Efficiency	OEE
Date								
10-01-2020	1.022727	0.09375	0.916031	0.999945	0.849316	0.833333	0.419866	0.707725
11-01-2020	0.906061	0.125	0.878766	0.996354	0.634082	0.906061	0.245143	0.572422
12-01-2020	0.909091	0	1	0.991782	0.962481	1	0.372879	0.954571
13-01-2020	0.666667	0	1	0.999376	1.040984	0.77193	0.218543	0.803065
14-01-2020	0.818182	0	1	0.998513	0.907254	1	0.286634	0.905905
...
30-08-2022	1.257576	0	1	0.999474	0.516729	1.627451	0.44652	0.840508
31-08-2022	1.309091	0.025	0.981261	0.998528	0.525615	1.2	0.463505	0.62981
01-09-2022	1.384848	0.06875	0.952704	0.999434	0.62924	1.523333	0.570431	0.958
02-09-2022	1.325758	0.052083	0.962199	0.999287	0.44242	1.715686	0.387728	0.758513

Table-II: Statistiqu Data

	MTBF	MTTR	Availability rate	Quality rate	Performance rate	Operational availability	Efficiency	OEE
Count	968	968	968	968	968	968	968	968
mean	1.124507	0.085518	0.932277	0.997132	0.641775	1.341891	0.427439	0.734369
std	0.272046	0.123836	0.092307	0.030736	0.204375	0.949126	0.148262	0.140678
min	0.257576	0	0.66108	0.525425	0.103099	0.520833	0.030538	0.34956
25%	1.040909	0	0.900836	0.998321	0.517361	0.946667	0.353109	0.629714
50%	1.198485	0.03125	0.973409	0.998941	0.634082	1.178551	0.459429	0.749897
75%	1.289394	0.108333	1	0.999434	0.761801	1.391304	0.545714	0.844952

III. PROPOSED METHODOLOGY

A. Description of Data Collection

The data was collected daily for a period of 31 months: Quality rate (number of good products, number of completed products), performance rate (deviation from rate), average uptime, and average technical repair time. The data was collected from a production system with an in-line configuration consisting of seven pieces of equipment: the decoder, washer, filler, tester, labeler, packer, and coder. These data are described in Tables I and II.

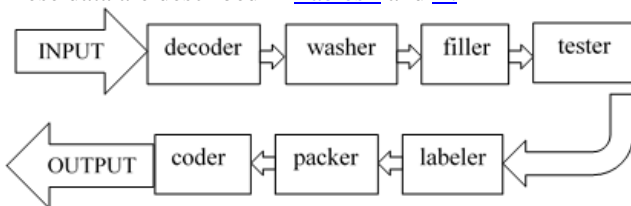

Fig. 1. Equipment Description Diagram



Fig. 2. Overview Image of The Equipment

$$OEE = \frac{\text{Number of good pieces}}{\text{Number of theoretically feasible pieces}} \tag{1}$$

$$\text{Efficiency} = \text{Quality Rate} \times \text{Availability Rate} \times \text{Performance Rate} \tag{2}$$

$$MTTR = \frac{\text{Intervention time}}{\text{Number of failures}} \tag{3}$$

$$MTBF = \frac{\text{Operating time}}{\text{Number of maintenance operations}} \tag{4}$$

$$\text{Operational availability} = \frac{\text{Operating time}}{\text{Required time}} \tag{5}$$

MTBF: Mean Time Between Failure
 MTTR: Mean Time To Repair
 OEE: Overall Equipment Effectiveness

B. Data Processing

An exploratory data analysis through a seasonal decomposition in trend seasonality and residual has been done before processing the data. The exponential weighted moving average smoothing technic was implemented to reduce the impact of noise in the analysis of the system.



$$y_t = \beta \sum_{k=0}^{\infty} (1 - \beta)^k x_{t-k} \tag{6}$$

$y(t)$: Being the linear combination of previous observations

$\beta \in]0,1[$: Degree of mixing parameter value, in this case

$\beta = 0.1$

$\alpha_k = \beta(1 - \beta)^k$: As coefficient the variance being

$$var(y_t) = \frac{\beta}{2 - \beta} \sigma^2 \tag{7}$$

For every step at the date

$t + N > t$

The following smoothing formula is obtained:

$$x^*_{t+N} = \beta \sum_{k=0}^{\infty} (1 - \beta)^k x_{t-k} \tag{8}$$

And the updated formula of the smoothing formula is :

The Following Curves Represents the Filtered Operational Data.

$$x^*_{t+1} = \beta x_t + (1 - \beta)x^*_t \tag{9}$$

Table-II is a statistical table of raw data (unfiltered data). According to the NFE60-182 standard efficient operation, the OEE must be greater than 85% [6,7]. From this table, 75% of the operating time, the Overall Equipment Efficiency is less than 85%. It means that plant operates 75% of the time in Jogg mode. In addition, the plant has an average good operating time of less than 1 hour and 30 minutes for the operating time. The Availability rate has a standard deviation of 0.09. Meaning that most of the values are around its mean of 0.932277. The raw data curves, smoothed by an exponential weighted moving average, are presented in the following section in Figures 3, 4, 5, 6, 7, 8, 9.

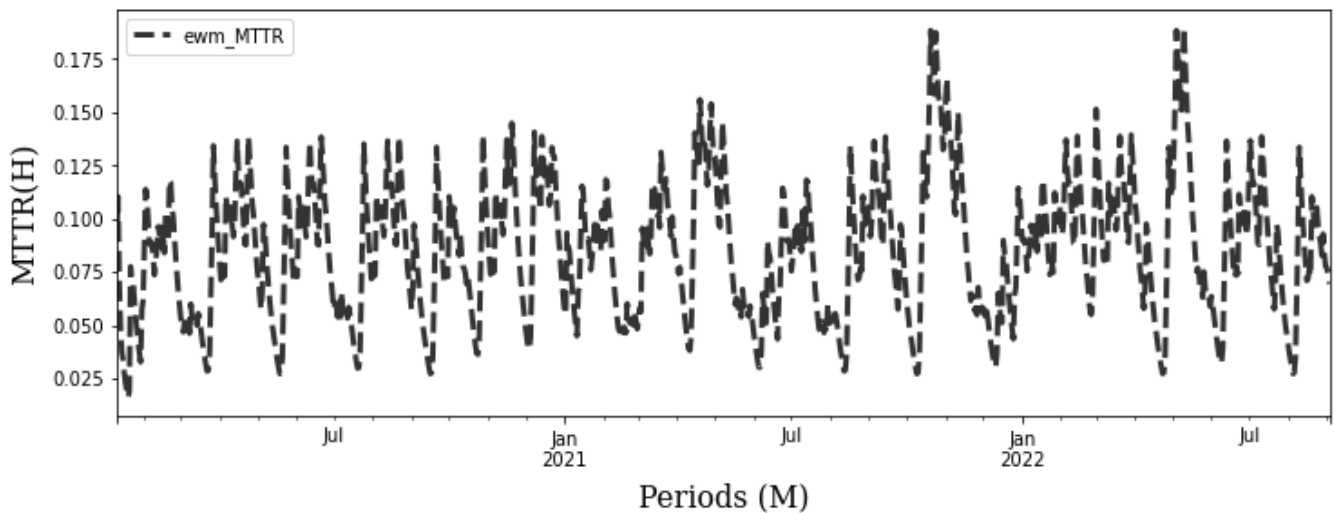

Fig. 3. MTTR

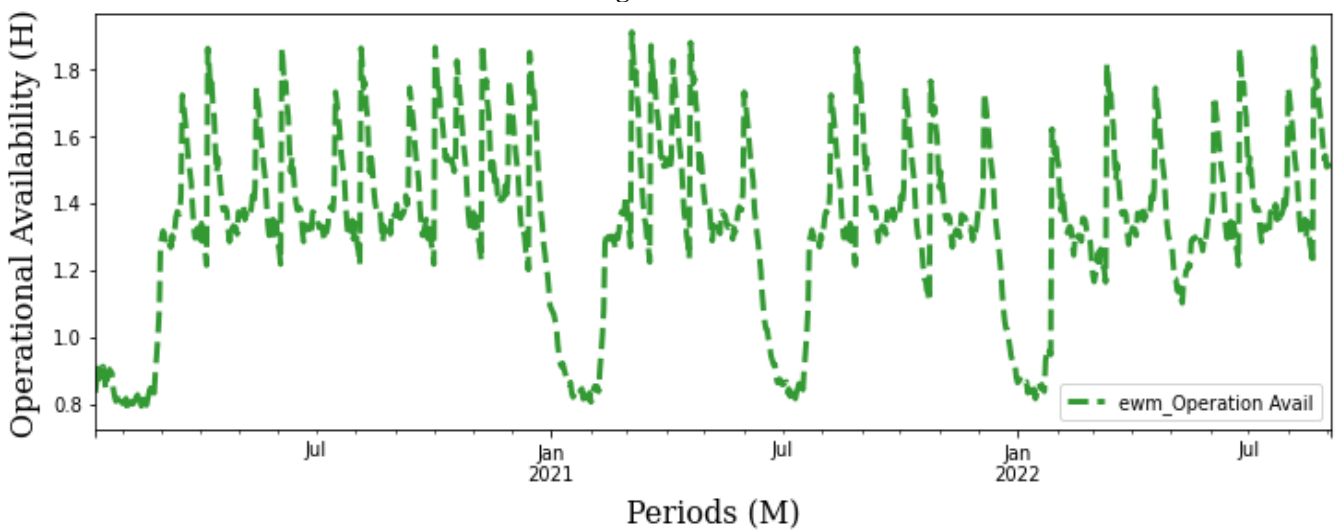

Fig. 4. Operational Availability

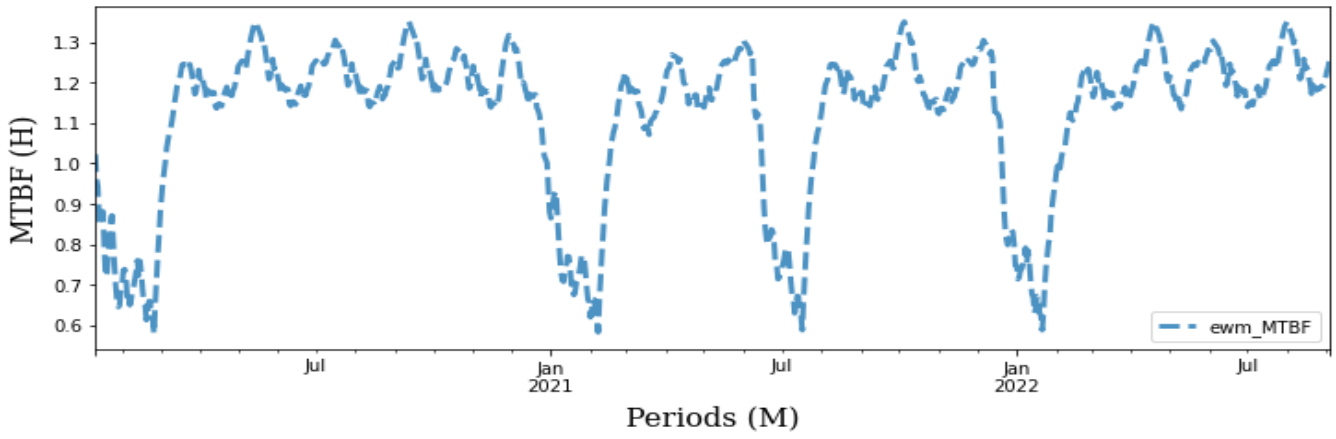

Fig. 5. MTBF

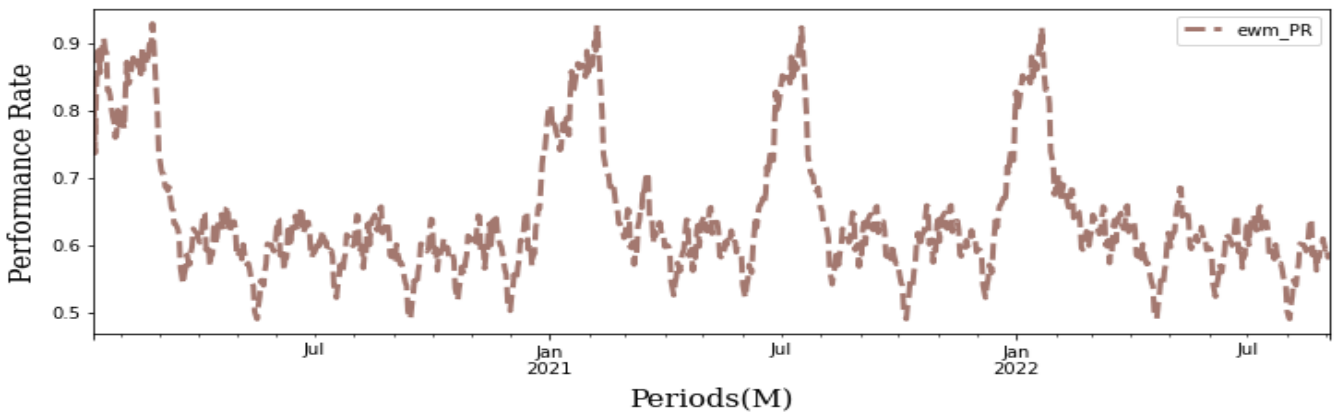

Fig. 6. Performance Rate

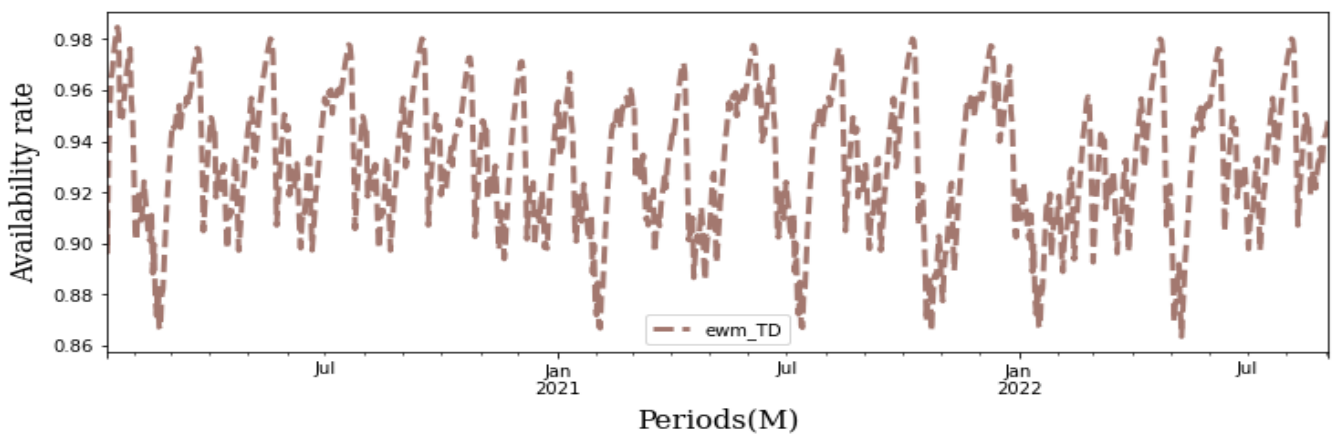

Fig. 7. Availability Rate

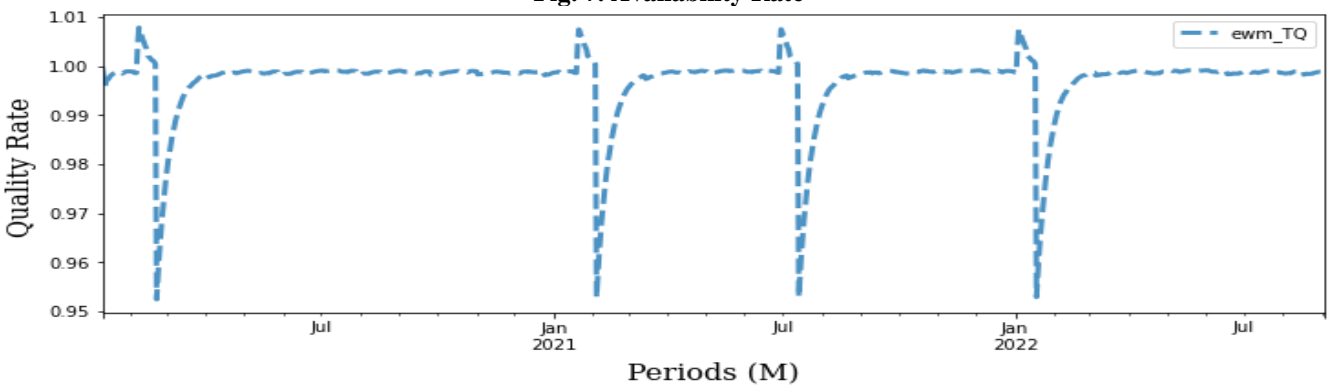

Fig. 8. Quality Rate

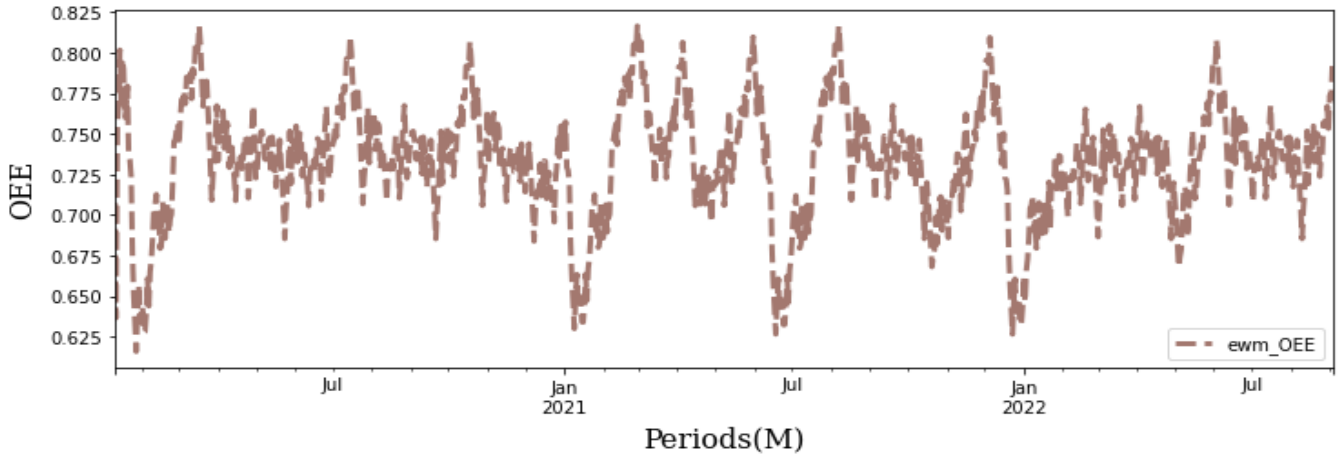

Fig. 9. OEE

C. Data Prediction

The data is fed into an architecture consisting of an LSTM as input, two intermediate layers (an LSTM layer and a Dense layer), and a Dense layer as output. The trained model has made it possible to make accurate predictions of reliability and performance indicators over six months with the precision given in Table-III, which makes it possible to evaluate the production system in advance, identify bottlenecks and anticipate a better management policy for the company [3, 5, 13].

- $f(t) \in \mathbb{R}^h$ forget gate's activation
- $i(t) \in \mathbb{R}^h$ input gate's activation vector
- $o(t) \in \mathbb{R}^h$ output gate's activation vector
- $c(t) \in \mathbb{R}^h$ current entry vector
- $h(t), y(t) \in \mathbb{R}^h$ hidden state or output vector
- $C(t) \in \mathbb{R}^h$ all state vector
- σ sigmoid function
- w_h weights matrix
- b_h bias vector
- \otimes Hadamard product

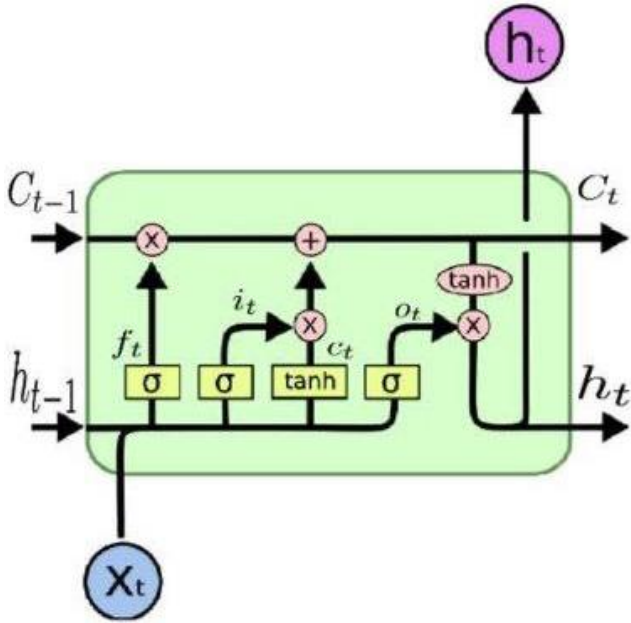

Fig. 10. LSTM node Structure

$$f(t) = \sigma(w_{xf}^T X(t) + w_{hf}^T h(t-1) + b_f) \tag{10}$$

$$i(t) = \sigma(w_{xi}^T X(t) + w_{hi}^T h(t-1) + b_i) \tag{11}$$

$$c(t) = \tanh(w_{xc}^T X(t) + w_{hc}^T h(t-1) + b_c) \tag{12}$$

$$o(t) = \sigma(w_{xo}^T X(t) + w_{ho}^T h(t-1) + b_o) \tag{13}$$

$$C(t) = f(t) \otimes C(t-1) + i(t) \otimes c(t) \tag{14}$$

$$y(t) = h(t) = o(t) \otimes \tanh(C(t)) \tag{15}$$

$$X(t) \in \mathbb{R}^d \text{ input vector}$$

IV. RESULT AND DISCUSSION

Table-III: Model Performance Indicators

INDICATORS	MAE	MAPE	MDAPE
OEE	0.01	1.36%	1.11%
Availability rate	0.01	0.70%	0.62%

$$MAPE = \frac{1}{N} \sum_{i=1}^N \left| \frac{y_i - \hat{y}_i}{y_i} \right| \tag{16}$$

$$MAE = \frac{1}{N} \sum_{i=1}^N |y_i - \hat{y}_i| \tag{17}$$

$$MDAPE = \text{Median} \left(\frac{y_i - \hat{y}_i}{y_i} \right) \times 100 \tag{18}$$

\hat{y}_i predicted value

y_i Actual value

The median of all absolute percentage errors between the prediction and actual values of respectively the availability rate and OEE are respectively 0.62% and 1.1%. It shows how fast and accurate our model has learnt the patterns of the systems from January 2020 to February 2022 to predict for the next 6 months the states of the brewery industry in terms of availability and the efficient use of resources of the company (OEE).



The average difference between the actual values and the forecast values of the metric assessing the real use of the resources is very good on the set period of time of study according of the industry standards.

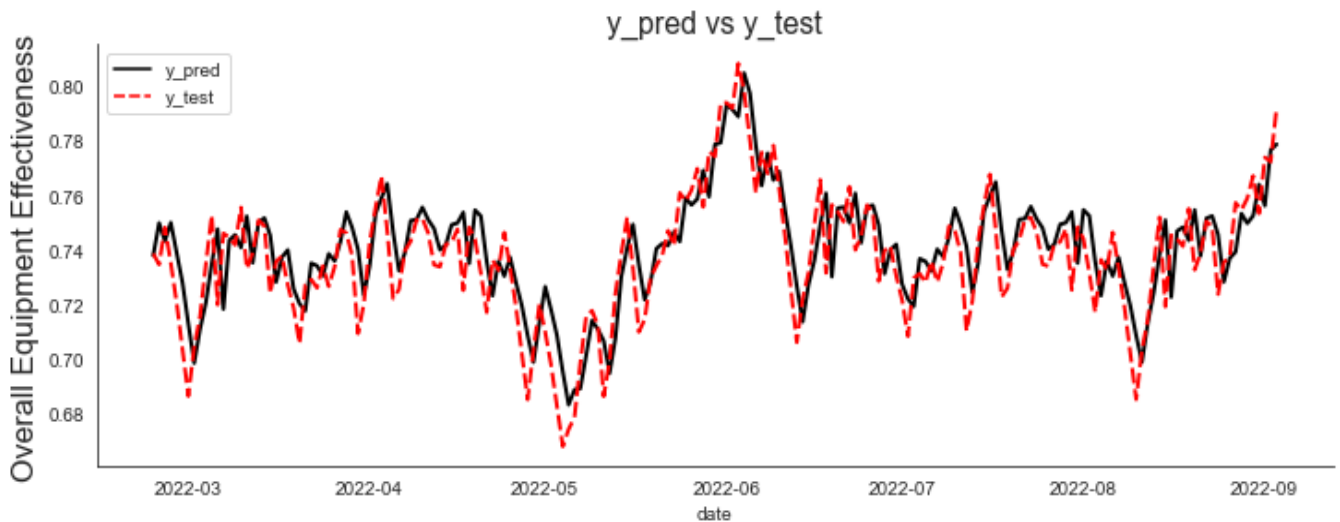

Fig. 11. Prédiction vs Test Curves

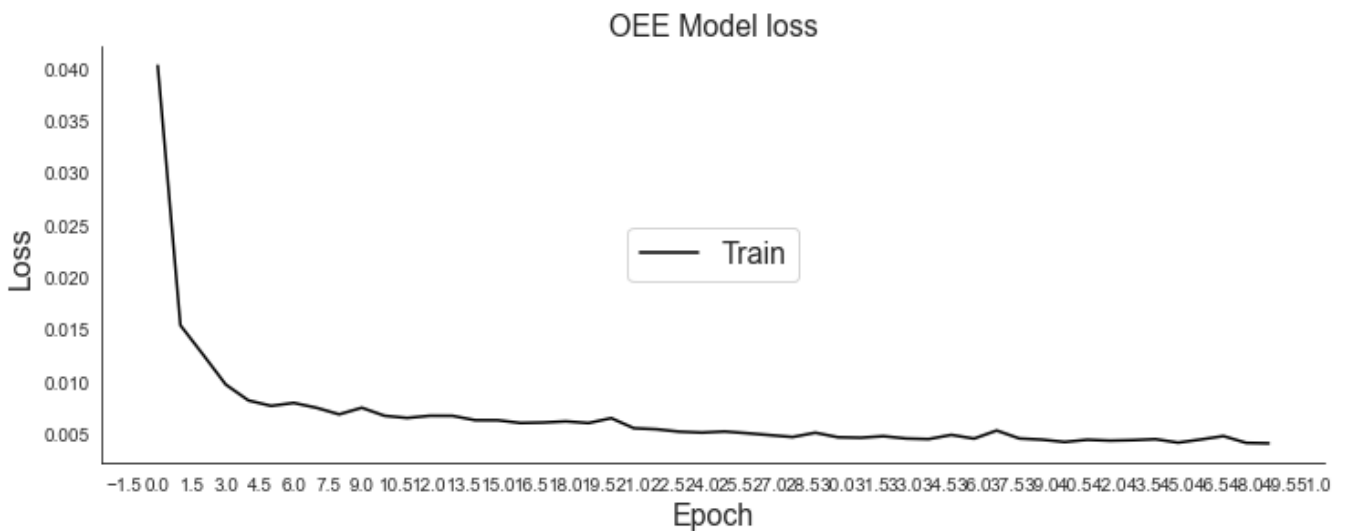

Fig.12. Learning Curve of the OEE

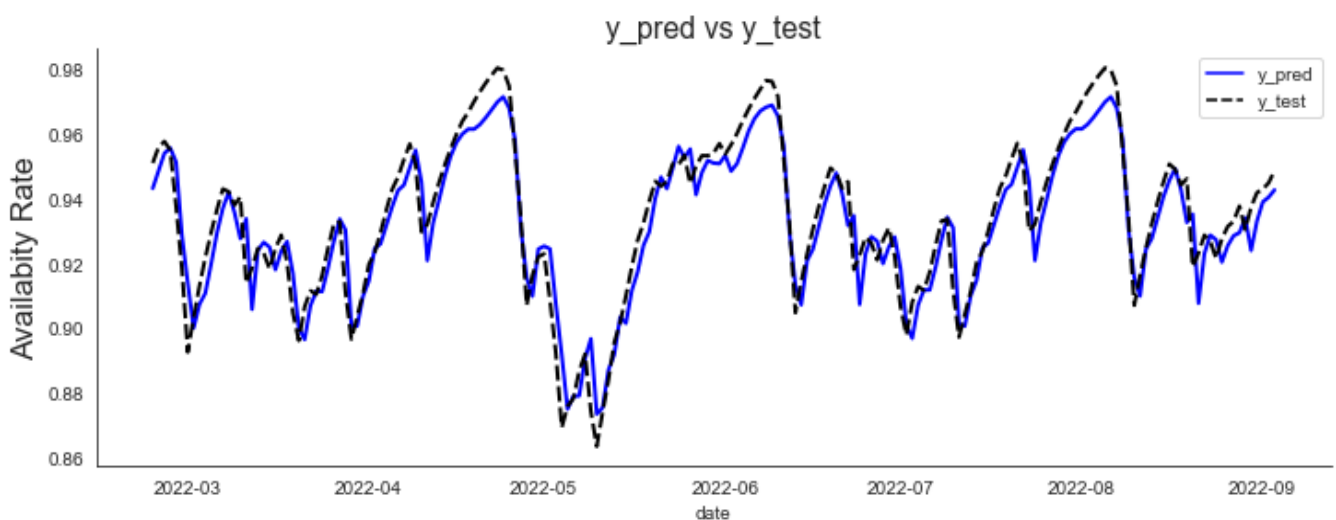

Fig. 13. Prediction vs Test Curves of the Availability Rate



Fig. 14. Learning Curve of the Availability Rate

V. CONCLUSION

Complex manufacturing systems use very complex mathematical models to assess metrics such as availability, reliability and OEE. The method proposed in this article based on operational data and applied to a brewery industry performs very well and in a simple manner. It can be used to determine the dynamic reliability and performance of the brewery production system to improve maintenance policy, anticipate repairs, improve efficiency, identify bottlenecks and predict system behavior in the future years.

DECLARATION

Funding/ Grants/ Financial Support	No, I did not receive.
Conflicts of Interest/ Competing Interests	No conflicts of interest to the best of our knowledge.
Ethical Approval and Consent to Participate	No, the article does not require ethical approval and consent to participate with evidence.
Availability of Data and Material/ Data Access Statement	Yes, It is relevant. The data upon request.
Authors Contributions	The first three authors processed the data, developed the model, and analyzed the results under the supervision of the last two authors. And are responsible for any statements made in this article.

REFERENCES

- H. Sun, M. Yang, and H. Wang, "Resilience-based approach to maintenance asset and operational cost planning," *Process Safety and Environmental Protection*, vol. 162, pp. 987-997, 2022. [CrossRef]
- S. Sharma, "Fuzzy reliability analysis of repairable industrial systems using soft-computing based hybridized techniques," *Applied Soft Computing*, vol. 24, pp. 264-276, 2014. [CrossRef]
- D. Libes, S. Shin, and J. Woo, "Considerations and recommendations for data availability for data analytics for manufacturing," in *2015 IEEE International Conference on Big Data (Big Data)*, 2015, pp. 68-75. [CrossRef]
- H. Garg, "Reliability, availability and maintainability analysis of industrial systems using PSO and fuzzy methodology," *Mapan*, vol. 29, pp. 115-129, 2014. [CrossRef]
- H. Garg and S. Sharma, "A two-phase approach for reliability and maintainability analysis of an industrial system," *International Journal*

- of Reliability, Quality and Safety Engineering, vol. 19, p. 1250013, 2012. [CrossRef]
- T. Kombé, "Modélisation de la propagation des fautes dans les systèmes de production," *INSA de Lyon*, 2011.
- A. Villemeur, "Sureté de fonctionnement des systèmes industriels: fiabilité-facteurs humains, informatisation," 1988.
- T. Wuest, D. Weimer, C. Irgens, and K.-D. Thoben, "Machine learning in manufacturing: advantages, challenges, and applications," *Production & Manufacturing Research*, vol. 4, pp. 23-45, 2016. [CrossRef]
- H. Garg, M. Rani, and S. Sharma, "An approach for analyzing the reliability of industrial systems using soft-computing based technique," *Expert systems with Applications*, vol. 41, pp. 489-501, 2014. [CrossRef]
- P. Alavian, Y. Eun, K. Liu, S. M. Meerkov, and L. Zhang, "The (α X, β X)-precise estimates of production systems performance metrics," *International Journal of Production Research*, vol. 60, pp. 2230-2253, 2022. [CrossRef]
- S. Li, Z. Chen, Q. Liu, W. Shi, and K. Li, "Modeling and analysis of performance degradation data for reliability assessment: A review," *IEEE Access*, vol. 8, pp. 74648-74678, 2020. [CrossRef]
- M. Azeem, A. Haleem, S. Bahl, M. Javaid, R. Suman, and D. Nandan, "Big data applications to take up major challenges across manufacturing industries: A brief review," *Materials Today: Proceedings*, vol. 49, pp. 339-348, 2022. [CrossRef]
- W. Fang, Y. Guo, W. Liao, K. Ramani, and S. Huang, "Big data driven jobs remaining time prediction in discrete manufacturing system: a deep learning-based approach," *International Journal of Production Research*, vol. 58, pp. 2751-2766, 2020. [CrossRef]

AUTHORS PROFILE



Ondo Boniface is a doctoral student at the laboratory of technology and applied sciences of the University of Douala. He obtained his master of sciences at university of Poitier France. He is currently an assistant professor at the University of Science and Technology of Masuku in Gabon.



Nasso Toumba Richard is a holder of a bachelor's in physics from the University of Ngaoundere, a master of Engineering in electrical engineering with a concentration in electronics and information science from the University of Douala, and a Master of science in computer engineering and information science from the laboratory of technology and applied science of the Postgraduate School of pure and Applied science of the University of Douala. He is also a holder of a Deep learning TensorFlow professional developer certificate from the Deep learning. AI. organization.





Ombété Tsimi Giscard holds a bachelor's degree in physics from the University of Yaoundé 1, a master of engineering in electronics from the University of Douala, and a master's of science in electrical engineering with a concentration in power electronics from the Postgraduate school for pure and applied science of the University of Douala.



Kombé Timothée He is an associate professor in Automation and operation safety at the University of Douala. He leads a large research team, supervises several doctoral and master's theses in engineering sciences, and is a consultant in several manufacturing plants in Cameroon and Central Africa. He did his Master's degree in at the National Advanced School of Engineering, Yaoundé (Cameroon), MSc in Radio & Television Code Unesco 2307 at the State University of Telecommunications of St. Petersburg (St. Petersburg) and a Ph.D. thesis at INSA of LYON (France). He has expertise in the following areas OEE Performance Indicators, PLC Implementation and Programming, Reliability, Maintenance, Availability, reliability, Operational safety and Remote Sensing.



Elé Pierre He is a full professor of Electrical Engineering and Telecommunications at the National Advanced School of Engineering in Yaoundé 1 and holds a Ph.D. in Engineering Sciences (Lyon 1, 1992), engineering degree from INSA-Lyon and a master's degree in engineering science from the University of Yaoundé. He is the author of several scientific publications (books and articles) in various fields. Today, he leads a large research team at the University of Yaoundé 1 and Douala, supervises several doctoral and master's theses in engineering sciences, and teaches in several engineering schools in Cameroon and Africa.

Disclaimer/Publisher's Note: The statements, opinions and data contained in all publications are solely those of the individual author(s) and contributor(s) and not of the Blue Eyes Intelligence Engineering and Sciences Publication (BEIESP)/ journal and/or the editor(s). The Blue Eyes Intelligence Engineering and Sciences Publication (BEIESP) and/or the editor(s) disclaim responsibility for any injury to people or property resulting from any ideas, methods, instructions or products referred to in the content.