

# Water injection control modelling by using model-based calibration

Khairul Khusairi bin Kamaludin<sup>1</sup>, Aman Mohd Ihsan Mamat<sup>1</sup>, Zulkifli Mohamed<sup>1</sup>, Wan Saiful-Islam Wan Salim<sup>2</sup>

<sup>1</sup>Faculty of Mechanical Engineering, Universiti Teknologi MARA, Shah Alam, Selangor, Malaysia

<sup>2</sup>Faculty of Mechanical Engineering and Manufacturing, Universiti Tun Hussein Onn, Johor, Malaysia

## Article Info

### Article history:

Received Dec 30, 2021

Revised Sep 26, 2022

Accepted Oct 17, 2022

### Keywords:

Model-based calibration

Spark ignition engine

Water injection

## ABSTRACT

This study presents the development of water injection system for turbocharged spark ignition engine. The water injection control system is built for turbocharged spark ignition (SI) engine where water was injected at the intake port just before the throttle body. The data was collected from the simulation through the GT-Power software to determine the optimized injection output for the engine. Single-stage statistical engine responses and boundary models were established by using Model-Based Calibration (MBC) Toolbox. Control system was built using Simulink and simulation tests were conducted based on the speed and throttle position as the variables. The highest value of brake torque achieved in the GT-Power simulation was taken as the base value to determine the injection amount. The mean value of the predicted injection was recorded at 12.29 g/s while the variance of the predicted injection to the optimized injection was below 1%. The control system was simulated with the set predicted injection and the standard deviation of the predicted injection was 1.18. The control system simulation recorded a low percentage of 0.04% variance to the optimized injection with the pulse width modulation signal. The control system is ideal to be constructed and tested on actual engine test bed.

*This is an open access article under the [CC BY-SA](https://creativecommons.org/licenses/by-sa/4.0/) license.*



## Corresponding Author:

Khairul Khusairi bin Kamaludin

Faculty of Mechanical Engineering, Universiti Teknologi MARA

Shah Alam, Selangor, Malaysia

Email: khairulkhusairi@gmail.com

## 1. INTRODUCTION

The automotive industry has evolved through the years with a higher demand for fuel efficiency. Therefore, manufacturers have been actively producing small capacity turbocharged engine to compensate the needs for fuel efficiency while producing enough power and torque. Water injection has been used as an internal cooling system especially for forced induction spark ignition engines [1]. Higher intake pressure increases the temperature of the engine process which requires cooling to prevent detonation. As a result, more oxygen enters the combustion chamber and the combustion process becomes more efficient [2], [3]. Water injection is proven to increase the engine performance especially for forced induction engines [4]–[7]. Among the most common engine characteristics to be positively impacted are the improvement of brake torque and decrease of emissions in the engine [8]. Water injection is proven to be the most effective engine knocking reduction media [6], [9], [10]. Lanzafame [11] reported that improvement in the anti-detonation by using water injection. Water injection is proven to lower the engine knocking index due to lower in-cylinder pressure. Water is the best heat absorption medium that helps to lower the temperature of the engine process. The lower in-cylinder temperature causes the large latent heat during the water evaporation process [12].

Water evaporation leads to a decrease of in-cylinder temperature and pressure because of the heat absorption energy that is higher than the expansion work [13]. This knocking tendency reduction affects the fuel consumption relatively. Brake specific fuel consumption (BSFC) is reportedly reduced to 22% with the addition of water injection to the engine process [10]. Specific fuel consumptions are also reduced from 6% to 12% by advancing the spark with a wide range of engine speed operation [14]. The advantages of water injection have made it possible for the industry to equip engines with the best intake cooling system.

The advanced system in the automotive industry plays a big role in the control system. Most of the control systems in commercial engines are controlled by a mapping system that changes based on different variables. This has made the calibration works become more complicated and time-consuming. Thus, the conventional calibration and optimization technique could not sustain the high industrial demands. On the other hand, strict emissions regulations have made the automotive industry become more vigilant towards the improvements. The model-based calibration (MBC) technique improves engine calibration by saving cost and time. For example, nowadays, there are too many engine sensors to control the efficiency of the engine process due to strict legislations. The optimized method to do calibration works is mostly done using a model-based calibration optimization that offers significant advantages in reducing the time and effort required to obtain engine calibrations [15]. An actual engine calibration requires a dynamometer test in real-time but with the model-based calibration, the input, output, and variables can be built by a predictive engine model that is based on equation-based methods. A fully developed, steady state base engine can be tested in every condition by using the model-based calibration modelling [16].

In the experimentation of the water injection for the engine process, there are a few options of the injection method can be use. Determining fuel ratio and air pressure is the easiest way to introduce water into the engine process. Berni *et al.* [10] tested water and methanol injection system at downsized direct injection engine by using water injection ratio based on fuel injected. Injection ratio is set by percentage based on the mixture of air and fuel at stoichiometry. Ratio of water injection is the most common way being tested. Bozza *et al.* [17], [18] has tested two different methods of water injection, one is using ratio and the other when the knock signal was detected. Water injection mostly tested to eliminate knocking tendency in engine operation. There are no control systems using mapping to inject water into the engine system.

The objectives of water injection control are to determine the amount of water to be added to the engine system. Thus, if this purpose is fulfilled, then the usage of water injection control system is complete. The basic components of control system are input, process, and output. In this case, the output for water injection system is the injection, but the input may vary. Busuttill and Farrugia [19] provided the control system input data based on air pressure from the intake air pressure to determine the injection of the water into the intake manifold. Stoichiometric data can also be the input for the water injection system. The ratio between injected water quantity and stoichiometric fuel mass can also be considered as the point of injection [20]. The output of the system would be water injector. Most tests placed the injector at the intake manifold [4], [7], [21]. The input data are the engine load or throttle position and engine speed. To control the amount of injected water, the usage of mapping needs to be adopted due to the differences in the amount of water needed at every point of the engine process system.

## 2. METHODOLOGY

### 2.1. Data acquisition

The data collected was based on the simulation of a CamPro CFE 1.6L turbocharged engine. The engine was modelled in the GT-Power software based on the model developed by Ismail *et al.* [22]. The engine model was validated by comparing the data to the published engine data. The model showed an output of the engine torque with squares data residuals of 99%. The data comparison of the engine model and the published industrial data is shown in Figure 1. Figure 2 illustrates the engine that was equipped with 2 water injectors and the water amount tested was set from 1 g/s to 15 g/s. In all experiments, simulation runs with different engine speed between 1,000 rpm and 6,500 rpm with intervals of 500 rpm. Other variables set in this simulation is the throttle position. Throttle position is set from 10% to 100% with intervals of 10%.

### 2.2. Statistical modelling

In this paper, the calibration had a single stage model with 2 input data. The first input data was engine speed, and the second input data was the throttle position. Based on the process determining the amount of injection using GT-Power, only a linear model was needed. For a single stage model, the boundary model was the convex hull as it fits the input. The one-stage model that was established in the MBC Toolbox was a local input model. The local model gave a curve fitting for the local variable. Figure 3 shows the one-stage statistical model used in this experiment. The statistical model uses automatic relevance determination (ARD) squared exponential as a basis of calculation to fit the model. The equation of the model is:

$$k(x_i, x_j | \theta) = \sigma_f^2 \exp \left[ -\frac{1}{2} \sum_{m=1}^d \frac{(x_{im} - x_{jm})^2}{\sigma_m^2} \right]$$

To connect the data, this model used the Gaussian process modelling to connect all injection points. This method was based on the probability to predict the point where there are no data given. This has trained the model to predict the point and build the response surface. The predicted injection was not the same as the optimized injection, but it will relate to the point aside.

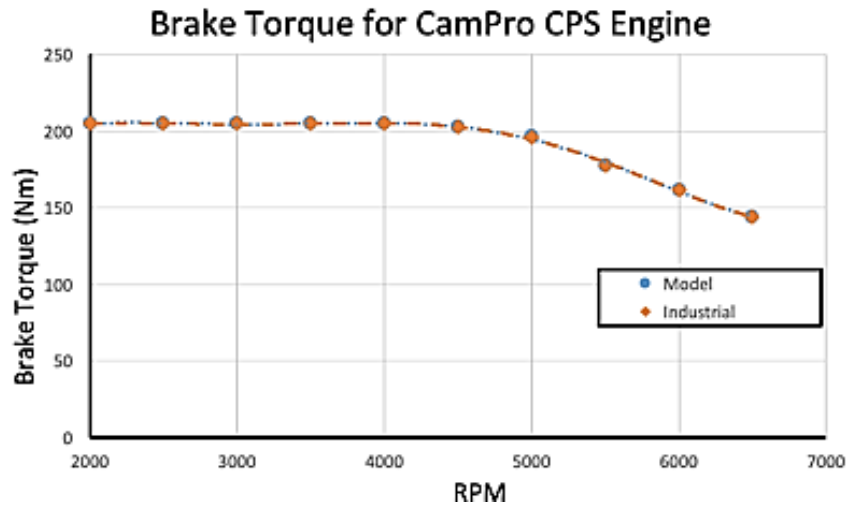

Figure 1. Torque data comparisons of engine model and Industrial Proton 1.6L CamPro CFE data

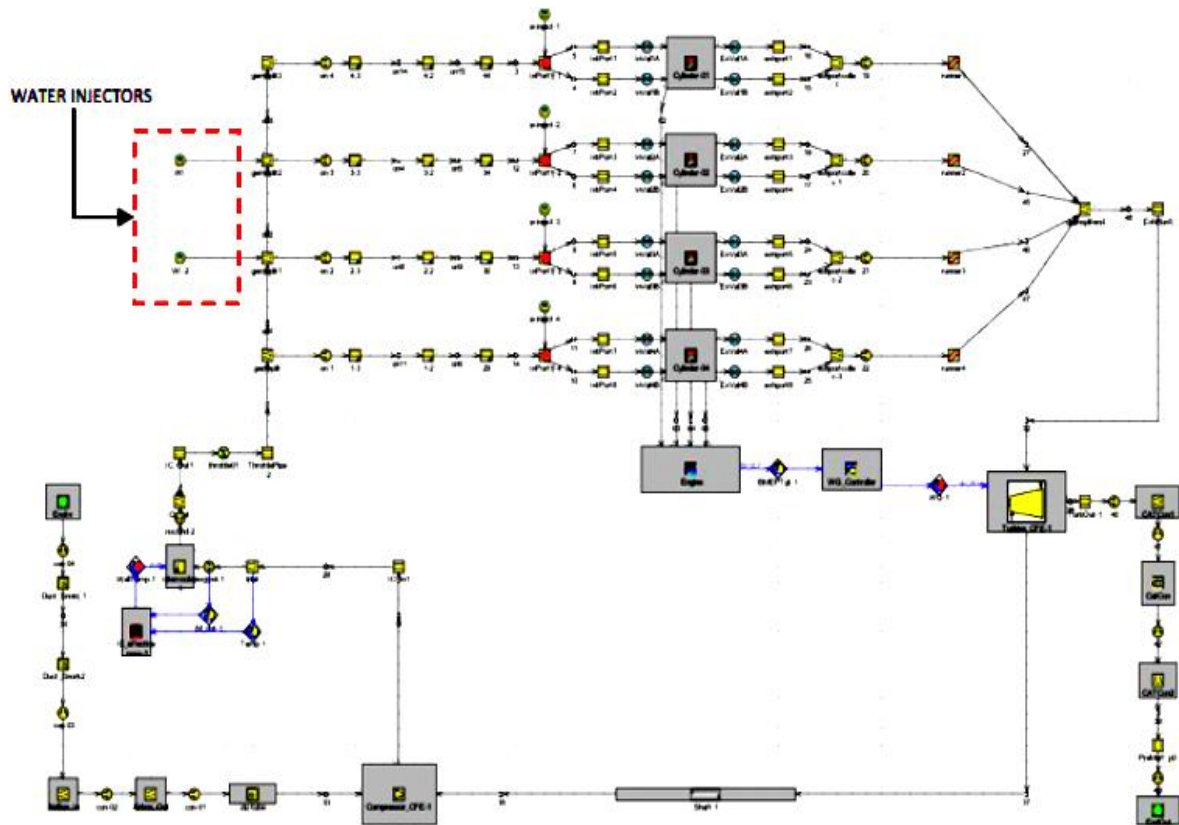

Figure 2. Proton 1.6L CamPro CFE engine model with water injection

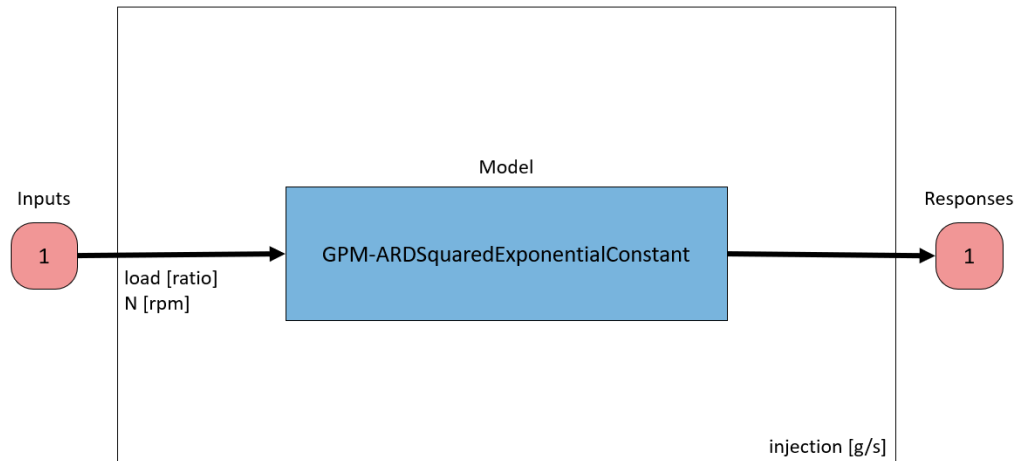

Figure 3. Water injection system single stage model

### 2.3. Water injection control system simulation

The control system for water injection was built in Simulink after the statistical model had been determined. This system must include both input signals which are speed and throttle position. The speed signal had to be built to make sure that the model responds to the speed change in simulation. The decoder for the speed system must be constructed first. For the throttle position the signal was based on the voltage to trigger the opening degree of the throttle. The signal was between 0.5 V for a complete shut throttle to 4.5 V for a wide-open throttle. The response received based on the model was gram per second but in the actual run the system provided the output of pulse width modulation (PWM). From gram per second, calculation was done to convert to the injection time to provide the opening time for the injector. In this project, the injector size was 1,800 cc per minute or 30 cc per second. When the conversion was complete then, the signal was digitalized to generate the PWM signal. At this point, the system was complete and needed to be validated. The experiment was based on the change of the voltage signal for throttle position from 0.5 V to 4.5 V with the interval of 0.5 V to simulate the different throttle openings. The speed was kept as constant, but the experiment was done at every speed from 3,500 rpm to 6,500 rpm.

## 3. RESULTS AND DISCUSSION

### 3.1. Water injection rate optimization

The water injection rate was taken based on the highest torque achieved on every throttle position and speed. These data provide the amount of optimized water to be injected. This injection rate is based on GT-Power simulation. In the simulation the injectors were set to injects water vapor [20]. The amount of injection rate is set to the desired value of 1 g/s to 15 g/s. Simulation is then run with a different speed [7]. The value of the optimized injection rate is recorded based on the highest torque achieved for every speed in the GT-Power simulation.

Figure 4 shows the torque achieved by the engine in GT-Power simulation. At 40% throttle position, the highest torque achieved was 232 Nm at 3,500 rpm with the injection rate of 11 g/s. The optimized injection rate at 40% throttle position were at 11 g/s and 12 g/s. At 60% throttle position, the highest torque achieved was 234 Nm at 3,500 rpm with the injection rate of 12 g/s. The optimized injection rate at 60% throttle position were at 12 g/s and 13 g/s. At 80% throttle position, the highest torque achieved was 235 Nm at 3,500 rpm with the injection rate of 13 g/s. The optimized injection rate at 80% throttle position were at 13 g/s and 14 g/s. At wide open throttle, the highest torque achieved was 236 Nm at 3,500 rpm with the injection rate of 13 g/s. The optimized injection rate at wide open throttle were at 13 g/s and 14 g/s. The highest torque achieved was taken as an injection point to build a mapping.

In model-based calibrations the most commonly used modelling technique is by using polynomials and radial basis function (RBF) network. Friedrich *et al.* [23] built engine test plans with 50 data points in total, containing 35 optimal and 15 space filling points which were measured at a four-stroke single cylinder engine test bench. By using the Gaussian process model, it was proven that model-based engine outputs were statistically better than the conventional system [23]. In this modelling, there are 49 optimized data points adapted from the experiment in GT-Power earlier as shown in Table 1. These data were used as the injection output for the setup of system.

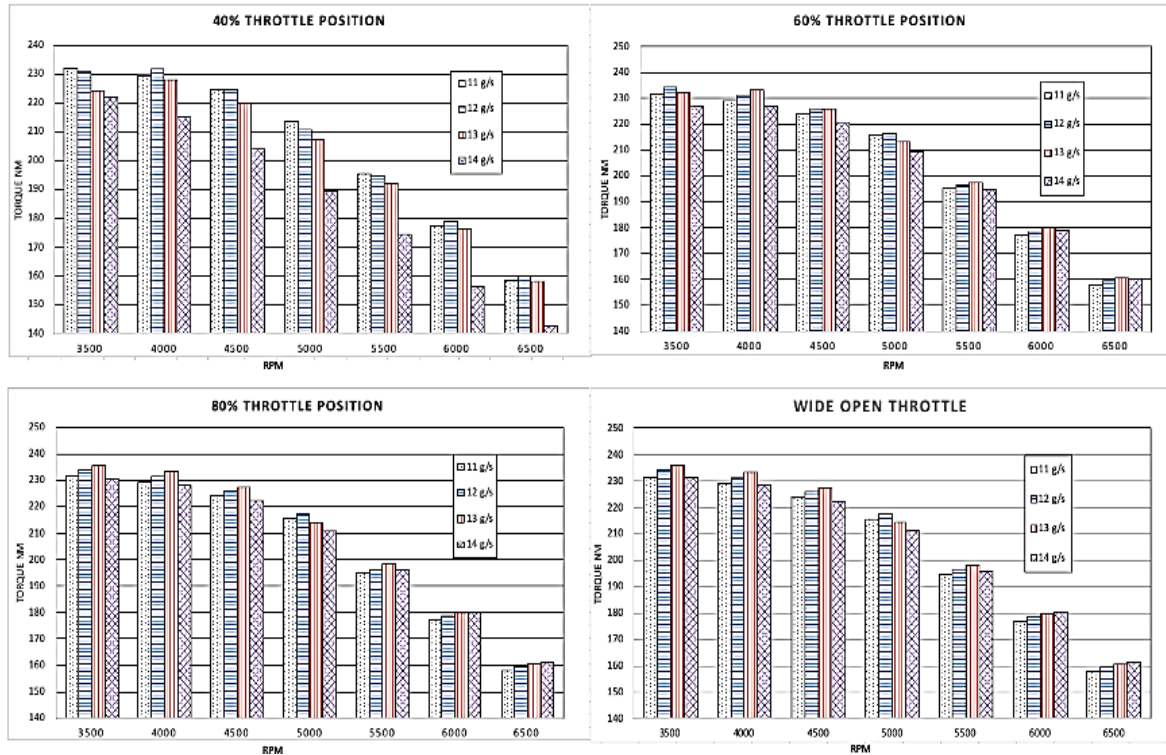

Figure 4. Brake torque data comparisons of different throttle position and water injection rate

Table 1. Optimized water injection based on throttle position and engine speed in GT-Power

Throttle	3500	4000	4500	5000	5500	6000	6500
40%	11	12	12	11	11	12	12
50%	12	13	12	11	12	13	13
50%	12	13	12	12	13	13	13
70%	13	13	13	12	13	13	14
80%	13	13	13	12	13	14	14
90%	13	13	13	12	13	14	14
100%	13	13	13	12	13	14	14

### 3.2. Statistical modelling

Based on the Gaussian process model’s construction of the response surface in Figure 5, the response was built to accommodate the injection. The basic response surface created a shape that connected all the injection points. This triggered the predicted injection which was use in the actual test plant. In addition, Figure 6 shows the plot of the predicted injection versus the optimized injection rate for the GT-Power data. Based on Figure 6 it is difficult to identify the distribution of the collected data. Therefore, probability plotting was essential to display the data distribution.

Figure 7 shows the probability of the injection plot to studentized residuals to present whether the data set was normally distributed or having outliers This figure also has been presented by Friedrich *et al.* [23]. This was achieved by dividing the data with the standard deviation. From the figure, several outliers were discovered but the trend line is still linear. This data is shown in the summary in Table 2. The minimum predicted injection shows +0.03 g/s from the optimized injection which is an increment of 0.33% from the actual optimized injection. The maximum predicted injection shows +0.1 g/s from the optimized injection which is an increment of 0.71% from the actual optimized injection. This shows that the model has a significantly precise analysis of the data with below 1% variance. The mean value for the predicted injection and the actual optimized injection has the same value of 12.29 g/s. The standard deviations for both injections are recorded at 1.18 for predicted injection and 1.22 for optimized injection. The square root of the variance is at 1 g/s from the mean value. This indicates that the deviation of the data spread from the mean value is low. The Gaussian process model has proven that the data for the predicted injection model is as close as the optimized injection model. With this data the model is good enough to plot 2D and 3D predicted injection points.

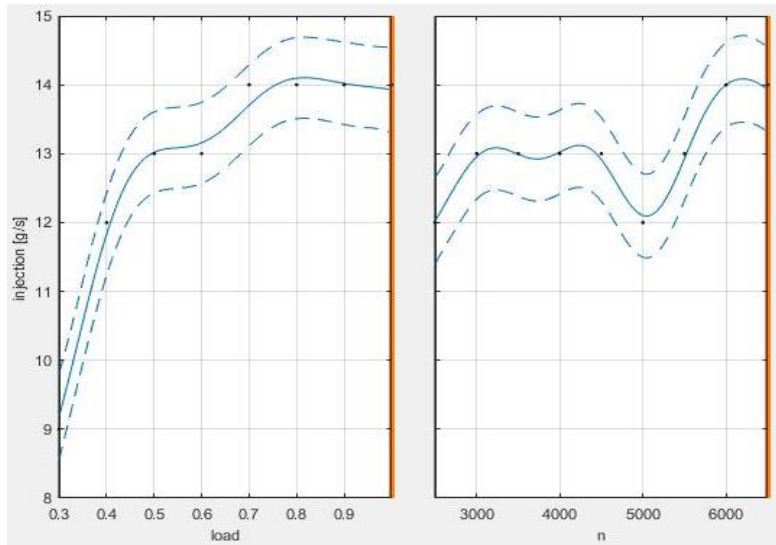

Figure 5. Response model for water injection based on engine load and engine speed

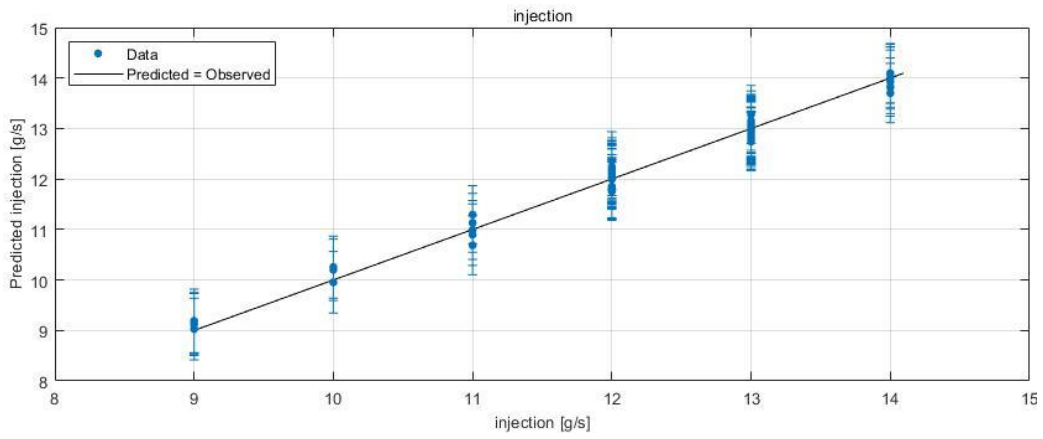

Figure 6. Predicted injection plot based on optimized injection

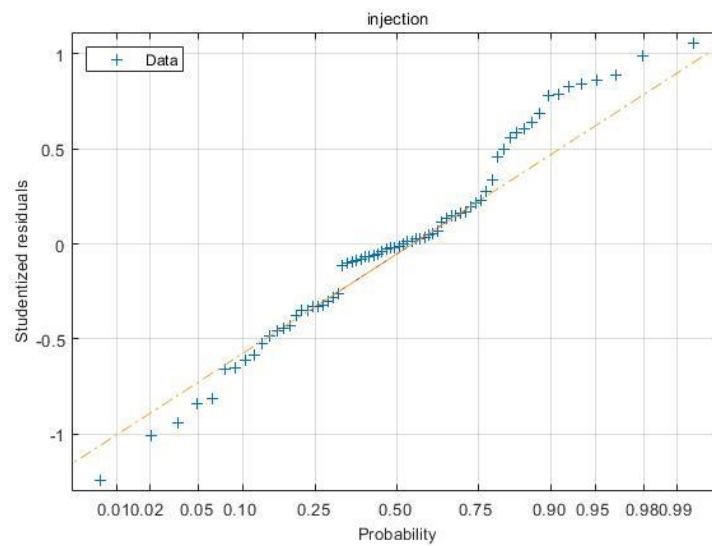

Figure 7. Probability of the injection versus studentized residuals

Table 2. Statistic summary of the water injection model

Variable	Unit	Min	Max	Mean	Std. Dev.
Predicted Injection	g/s	9.03	14.10	12.29	1.18
n	rpm	2,500	6,500	4,500	1,300.05
Load	ratio	0.3	1	0.65	0.23
Injection	g/s	9	14	12.29	1.22
Predicted Injection	g/s	9.03	14.10	12.29	1.18

The response surface or the mapping of the predicted injection is based on 2 variables which are throttle position or load and engine speed. Both variables are separated into two 2D plot as shown in Figure 8. After calculating the predicted injection, it has been found that there is not much difference in terms of injection point from the optimized injection. The predicted injection point is more scattered to cover the joint area to provide a smooth surface in the 3D plot. Figure 9 shows the plotting of the predicted injection. This plotting is the combination of both 2D plot for throttle opening and engine speed. The plot is then generated to produce the surface response in Figure 10. The surface response shows the smooth transition at every predicted injection point.

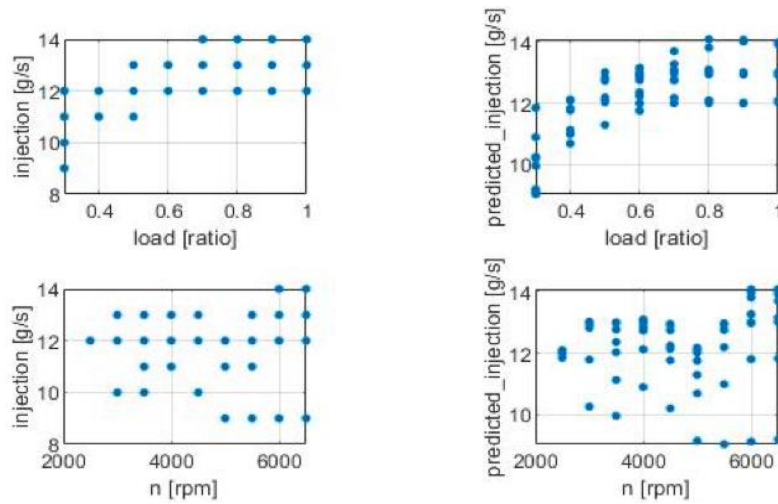

Figure 8. 2D plot for optimized injection and predicted injection based on statistic model

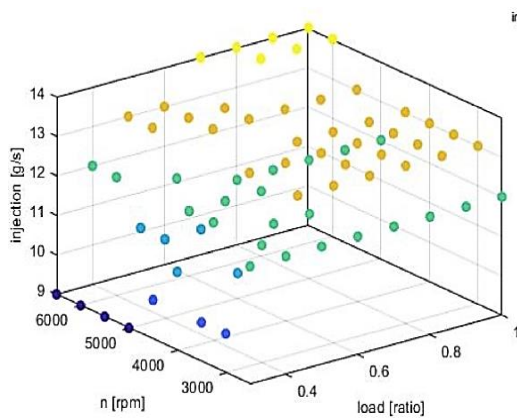

Figure 9. 3D plot for optimized injection

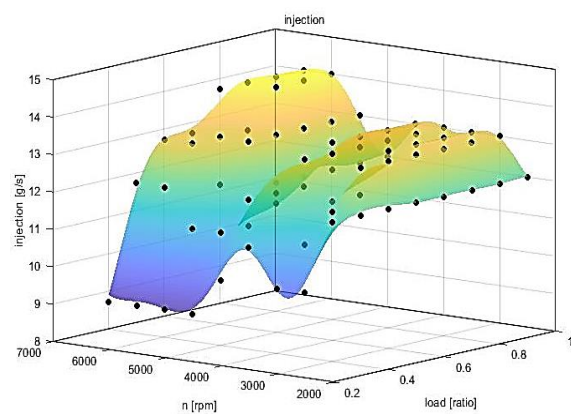

Figure 10. 3D plot for final response surface

In model-based calibrations, single stage models and two stage models are used to fit statistical data to develop response surface [24]. In engine development, the response surface or mapping task involves producing tables and models, which define an engine’s operating characteristics. Complicated engines with multiple continuous variable systems or stratified direct injection become increasingly difficult and

time-consuming to characterise [25]. Model-based calibration tools have been assisting engineers in calibrating engines and generating optimized engine management system data for the purpose of engine testing using simulations. The accurate use of simulation techniques as an integrated part of vehicle calibration can already be foreseen as data measurement and statistical modelling will provide a simple calibration task [26].

**3.3. Water injection control modelling**

The control modelling was constructed based on the method plan while the water injection modelling was based on the statistically calculated surface response. The objective of the control modelling is to validate the response from the constructed model. Based on Figure 11, the two input models which are throttle position and engine speed need to be replicated based on the actual condition of the engine. During the simulation, the engine speed variables was fixed, and throttle positions based on the set voltage in Figure 12. For engine speed, the encoder to replicate the engine speed calculator was built based on the ignition switches. The timing of the ignition was calculated, and the switch was doubled because one ignition point between two rotations.

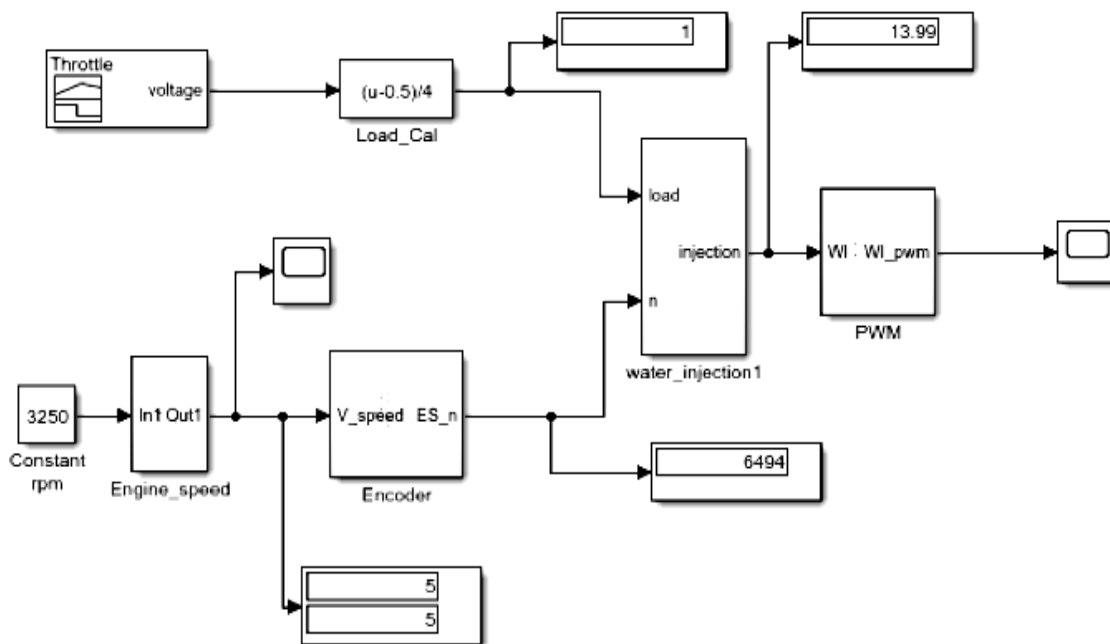

Figure 11. Water injection control modelling

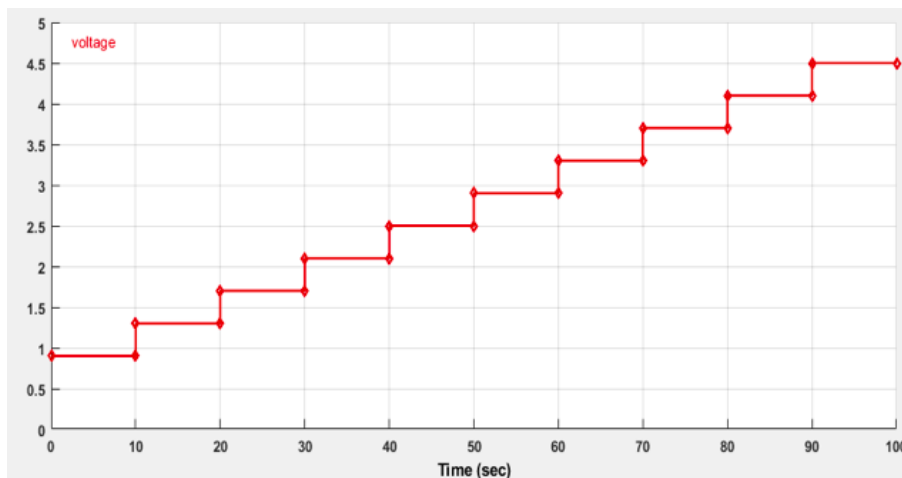

Figure 12. Throttle position voltage signal simulation



The output response was based on PWM. The pulse signal is shown in Figure 12 and for the first 10 seconds, the voltage was set at 0.9 V which indicated the opening of the throttle at 10%. This means that the injection should not be triggered, and the model is following the calculated injection timing which shows how accurate the model is. Then, for the next 10 seconds the voltage was set at 1.8 V, which indicated a low opening at 20% and the PWM signal also low which is shown only as a straight line because the opening signal is at 30% based on the calculation of the predicted injection.

During the actual simulation, the PWM signal was fully recorded. Table 3 and Figure 13 shows the recorded simulation injection reading at 4,500 rpm and 5,500 rpm. The signal varied around 0.01 and 0.02 based on 4,500 rpm and 5,500 rpm data collected. The overall reading recorded a small variance of 0.04% to the optimized injection needed. The output signal showed that the system operated well with the changes of input data which were throttle opening or load and engine speed. The control system simulation results validated the construction and test of the actual engine testing.

Table 3. Simulation PWM signal recorded at 4500 rpm and 5500 rpm

Throttle	Speed (rpm)	Injection	Simulation Injection	Throttle	Speed (rpm)	Injection	Simulation Injection
30%	4,500	10	10.20	30%	5,500	9	9.03
40%	4,500	12	11.77	40%	5,500	11	10.99
50%	4,500	12	12.14	50%	5,500	12	12.19
60%	4,500	12	12.25	60%	5,500	13	12.76
70%	4,500	13	12.75	70%	5,500	13	12.98
80%	4,500	13	12.96	80%	5,500	13	12.95
90%	4,500	13	12.94	90%	5,500	13	12.97
100%	4,500	13	12.91	100%	5,500	13	12.93

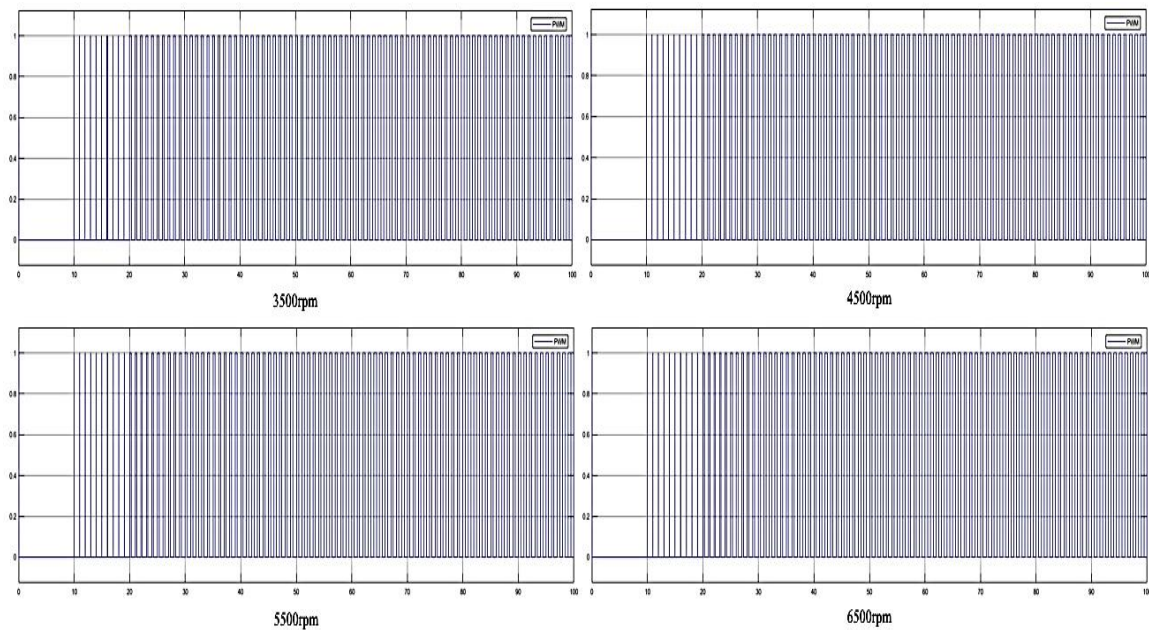

Figure 13. PWM signal output for injector

#### 4. CONCLUSION

This paper describes the water injection control modelling using GT-Power, MBC Toolbox and Simulink. The development of the response surface for the control output is critical as the response surface provided a smooth transition while the system runs. The response surface set the predicted injection with a low standard deviation of 1.18 compared to the optimized injection with 1.22 standard deviation. The variance of the predicted injection was below 1% which shows that the predicted injection control is adapting the given optimized injection. The predicted injection control system simulation was validated by the optimized injection to prove that the surface response model accurately followed the injection needed in the system. The simulation provided the control system with various variables to justify the systems adaptability to the engine process. The small variances were recorded while accommodating to the simulation process.

The signal precisely followed the injection mapping set by the controller. In order to evaluate the control system in the actual environment, a test on an actual engine test bed was being scheduled. The engine testing was planned at a steady state condition part load and full load conditions with engine speed and throttle position variables. The system was tested and also the improvement of the engine performance was recorded and compared to the result in the GT-Power model.

## ACKNOWLEDGEMENTS

The authors would like to acknowledge Universiti Tun Hussien Onn Malaysia (UTHM) for providing the support and sharing on GT-Power simulation software. The authors would also like to thank Universiti Teknologi MARA (UiTM) for its financial funding under grants awards 600-IRMI/MYRA 5/3/BESTARI (014/2017).



## REFERENCES

- [1] J. Westling and H. Subasic, "Effects and models of water injection in an SI engine." DiVA, pp. 1–57, 2018.
- [2] S. Zhu *et al.*, "A review of water injection applied on the internal combustion engine," *Energy Conversion and Management*, vol. 184, pp. 139–158, Mar. 2019, doi: 10.1016/j.enconman.2019.01.042.
- [3] S. Falfari, G. M. Bianchi, G. Cazzoli, C. Forte, and S. Negro, "Basics on water injection process for gasoline engines," *Energy Procedia*, vol. 148, pp. 50–57, Aug. 2018, doi: 10.1016/j.egypro.2018.08.018.
- [4] X. Tauzia, A. Maiboom, and S. R. Shah, "Experimental study of inlet manifold water injection on combustion and emissions of an automotive direct injection Diesel engine," *Energy*, vol. 35, no. 9, pp. 3628–3639, Sep. 2010, doi: 10.1016/j.energy.2010.05.007.
- [5] B. Tesfa, R. Mishra, F. Gu, and A. D. Ball, "Water injection effects on the performance and emission characteristics of a CI engine operating with biodiesel," *Renewable Energy*, vol. 37, no. 1, pp. 333–344, Jan. 2012, doi: 10.1016/j.renene.2011.06.035.
- [6] A. Boretti, "Water injection in directly injected turbocharged spark ignition engines," *Applied Thermal Engineering*, vol. 52, no. 1, pp. 62–68, Apr. 2013, doi: 10.1016/j.applthermaleng.2012.11.016.
- [7] K. K. Kamaludin, A. M. I. Mamat, and Z. Mohamed, "Engine characteristics analysis of turbocharged spark ignition engine with water injection charge air cooling," *Journal of Advanced Research in Fluid Mechanics and Thermal Sciences*, vol. 68, no. 1, pp. 133–142, Mar. 2020, doi: 10.37934/arfmts.68.1.133142.
- [8] C. H. Ling and M. A. Abas, "One-dimensional simulation using port water injection for a spark ignition engine," *International Journal of Automotive and Mechanical Engineering*, vol. 15, no. 4, pp. 5803–5814, Dec. 2018, doi: 10.15282/ijame.15.4.2018.7.0444.
- [9] V. De Bellis, F. Bozza, L. Teodosio, and G. Valentino, "Experimental and numerical study of the water injection to improve the fuel economy of a small size turbocharged si engine," *SAE International Journal of Engines*, vol. 10, no. 2, Mar. 2017, doi: 10.4271/2017-01-0540.
- [10] F. Berni, S. Breda, M. Lugli, and G. Cantore, "A Numerical investigation on the potentials of water injection to increase knock resistance and reduce fuel consumption in highly downsized GDI engines," *Energy Procedia*, vol. 81, pp. 826–835, Dec. 2015, doi: 10.1016/j.egypro.2015.12.091.
- [11] R. Lanzafame, "Water injection effects in a single-cylinder CFR engine," *SAE Technical Paper Series*, Mar. 1999, doi: 10.4271/1999-01-0568.
- [12] R. Zhao, W. Li, W. Zhuge, Y. Zhang, and Y. Yin, "Numerical study on steam injection in a turbocompound diesel engine for waste heat recovery," *Applied Energy*, vol. 185, pp. 506–518, Jan. 2017, doi: 10.1016/j.apenergy.2016.10.135.
- [13] C. Wang *et al.*, "Experimental study on knock suppression of spark-ignition engine fuelled with kerosene via water injection," *Applied Energy*, vol. 242, pp. 248–259, May 2019, doi: 10.1016/j.apenergy.2019.03.123.
- [14] C. Tornatore, D. Siano, L. Marchitto, A. Iacobacci, G. Valentino, and F. Bozza, "Water injection: a technology to improve performance and emissions of downsized turbocharged spark ignited engines," *SAE International Journal of Engines*, vol. 10, no. 5, pp. 2017-24-0062, Sep. 2017, doi: 10.4271/2017-24-0062.
- [15] C. Atkinson and G. Mott, "Dynamic model-based calibration optimization: an introduction and application to diesel engines," *SAE Technical Paper Series*, Apr. 2005, doi: 10.4271/2005-01-0026.
- [16] J. P. Styron, "Using model-based calibration toolbox multimodels for cycle-optimized diesel calibration," *MathWorks Automotive Conference*, 2008.
- [17] F. Bozza, V. De Bellis, L. Teodosio, D. Tufano, and E. Malfi, "Techniques for CO<sub>2</sub> emission reduction over a WLTC. A numerical comparison of increased compression ratio, cooled EGR and water injection," *SAE Technical Paper Series*, May 2018, doi: 10.4271/2018-37-0008.
- [18] F. Bozza, V. De Bellis, P. Giannattasio, L. Teodosio, and L. Marchitto, "Extension and validation of a 1D model applied to the analysis of a water injected turbocharged spark ignited engine at high loads and over a WLTP driving cycle," *SAE International Journal of Engines*, vol. 10, no. 4, Sep. 2017, doi: 10.4271/2017-24-0014.
- [19] D. Busuttill and M. Farrugia, "Experimental investigation on the effect of injecting water to the air to fuel mixture in a spark ignition engine," *MM Science Journal*, vol. 2015, no. 1, pp. 585–590, Mar. 2015, doi: 10.17973/MMSJ.2015\_03\_201510.
- [20] N. Cavina, N. Rojo, A. Businaro, A. Brusa, E. Corti, and M. De Cesare, "Investigation of water injection effects on combustion characteristics of a GDI TC engine," *SAE International Journal of Engines*, vol. 10, no. 4, Sep. 2017, doi: 10.4271/2017-24-0052.
- [21] D. Busuttill, G. Camilleri, and M. Farrugia, "Mechatronics for water injection in SI engine," in *Proceedings of the 16th International Conference on Mechatronics-Mechatronika 2014*, Dec. 2014, pp. 308–313, doi: 10.1109/MECHATRONIKA.2014.7018276.
- [22] M. I. Ismail, A. Costall, R. Martinez-Botas, and S. Rajoo, "Turbocharger matching method for reducing residual concentration in a turbocharged gasoline engine," *SAE Technical Paper Series*, Apr. 2015, doi: 10.4271/2015-01-1278.
- [23] C. Friedrich, M. Auer, and G. Stiesch, "Model based calibration techniques for medium speed engine optimization: investigations on common modeling approaches for modeling of selected steady state engine outputs," *SAE International Journal of Engines*, vol. 9, no. 4, Oct. 2016, doi: 10.4271/2016-01-2156.
- [24] M. Guerrier and P. Cawsey, "The development of model based methodologies for gasoline IC engine calibration," *SAE Technical Paper Series*, Mar. 2004, doi: 10.4271/2004-01-1466.



- [25] G. Lumsden, C. Browett, J. Taylor, and G. Kennedy, "Mapping complex engines," *SAE Technical Paper Series*, Mar. 2004, doi: 10.4271/2004-01-0038.
- [26] A. Schlosser, B. Kinoo, W. Salber, S. Werner, and N. Ademes, "Accelerated powertrain development through model based calibration," *SAE Technical Paper Series*, Apr. 2006, doi: 10.4271/2006-01-0858.

## BIOGRAPHIES OF AUTHORS





**Khairul Khusairi bin Kamaludin**    is a senior lecturer at German-Malaysian Institute and currently a Ph.D. candidate at Universiti Teknologi MARA. He holds Bachelor of Engineering in Metallurgical Engineering from Universiti Malaysia Perlis and Master of Engineering Management from the Universiti Teknologi MARA, Malaysia. He is working on some research in engine process and engine management system. His research interest includes internal combustion engine, engine management system, thermodynamics, and fluid mechanics. He can be contacted at khairulkhusairi@gmail.com.





**Aman Mohd Ihsan bin Mamat**    is an assoc. prof. at the Department of Mechanical Engineering, Universiti Teknologi MARA, Shah Alam, Selangor, Malaysia. He holds Bachelor of Engineering in mechanical engineering from Universiti Teknologi Malaysia, a Master Specialized (Technique Aeronautique et Space) from Ecole Nationale de la Superiuer et de l'Space, France, and a Ph.D. in mechanical engineering from Imperial College London, UK. His research interests include thermofluidic and energy, thermal engineering, wind turbine design and fluid mechanics. He can be contacted at amanihsan@uitm.edu.my.



**Zulkifli bin Mohamed**    is an assoc. prof. at the Department of Mechanical Engineering, Universiti Teknologi MARA, Shah Alam, Selangor, Malaysia. He holds Bachelor of Engineering in mechanical engineering from Universiti Teknologi MARA, Master of Engineering in Mechanical Engineering from Universiti Teknologi Malaysia, and Ph.D. from University of Toyama, Japan. His research interests include mechatronics, intelligent system, robotics, and industrial automations. He can be contacted at zulkifli127@uitm.edu.my.



**Wan Saiful-Islam Wan Salim**    is an assoc. prof. at the Department of Mechanical Engineering, Universiti Tun Hussein Onn Malaysia, Johor, Malaysia. He holds Bachelor of Engineering in mechanical engineering from Universiti Sains Malaysia, Master of Engineering in mechanical engineering from Universiti Sains Malaysia, and Ph.D. in from Imperial College, London, England. His research interests include thermodynamics and heat transfer. He can be contacted at wsaiful@uthm.edu.my.