

FACING THE CHALLENGES OF AIRCRAFT ICING

Christoph Deiler

DLR – German Aerospace Center, Institute of Flight Systems, Braunschweig

Hamburg Aerospace Lecture Series, 2022-10-20

<https://doi.org/10.5281/zenodo.7275215>



Facing the Challenges of Aircraft Icing

Dr.-Ing. Christoph Deiler, Institute of Flight Systems, German Aerospace Center (DLR)

Date: Thursday, 20 October 2022, 18:00 CET

Online: <https://purl.org/profscholz/zoom/2022-10-20>

Icing can have hazardous effects on airplane performance characteristics. It can also be a limiting factor for the safe flight envelope. Icing-induced change of the aircraft's dynamic behavior and potential premature stall raise the need for pilot situational awareness and an adaptation of any aircraft control strategy. During the last decades, various accidents worldwide have shown the severity of icing related degradations as well as pilots' difficulties to cope with changes in aircraft behavior. One major cause for these accidents was that with rising air traffic, aircraft were increasingly operated in certain icing conditions containing supercooled large water droplets (SLD) against which current aircraft were not protected.



The presentation will introduce the phenomenon of aircraft icing and highlight the peculiarities related to SLD in aviation, also with regards to the regulations. Changes of aircraft characteristics, flight dynamics and handling qualities will be discussed. Countermeasures and detection technologies are key to safe aircraft operation in these hazardous conditions. An overview of anti-ice and de-icing systems as well as detailed information on recent research activities on robust and reliable ice detection will be given.

Overview



- Motivation
- Phenomenon of Aircraft Icing
- Regulatory Aspects
- Aircraft Ice Accretion: Locations and Impact
- Ice Detection and Protection
- Aircraft Icing Prediction and Investigation
- (Inter-)National Research and Demands

Berlin-Schönefeld, February 15, 2013

Investigation Report BFU CX001-13:

- 3 minutes descent through icing clouds (moderate) between 3000 ft and 1400 ft
- no deicing activated
- “flight crew did not notice the ice accretion”
- ground impact during landing with severe aircraft damage



Credit: BFU, Interim Report BFU CX001-13

- No casualties
- Similar accident with 3 casualties on December 08, 2014 in Gaithersburg, MD, USA



Ice accretion on wing leading edge

- Different forms of ice accretion on wing and horizontal tail
- Wing: 4 cm wide concave, mainly clear ice accretion → building typical horns

The Problem with Airplane Icing

- Hazardous effects of ice accumulations caused various accidents in the past despite the availability of countermeasures (anti-ice, deice)
- Resulting effects related to type and location of corresponding ice accretion, which have dependency on, e.g., atmospheric conditions, flight condition, aircraft geometry, ...



Credit: BFU, Interim Report BFU CX001-13

- App. O to CS-25 issued to address Supercooled Large Droplets (SLD) (in addition to App. C)
- Better understanding and prediction of icing impact on aircraft characteristics

Severity of Icing Conditions



FAA Aeronautical Information Manual (AIM) Guidelines for PIREPs related to airframe icing

Level	Conditions	Action
Trace	Ice becomes noticeable, less than 0.6 cm per hour on the outer wing	The pilot should consider exiting the icing conditions before they become worse .
Light	Ice accumulation requires occasional cycling of deicing systems, 0.6 to 2.5 cm per hour on the unprotected part of the outer wing	The pilot should consider exiting the icing condition.
Moderate	Ice accumulation requires frequent cycling of deicing systems, 2.5 to 7.5 cm per hour on the unprotected part of the outer wing	The pilot should consider exiting the icing condition as soon as possible .
Severe	Ice protection systems fail to remove the accumulation, above 7.5 cm per hour on the unprotected part of the outer wing	Immediate exit is required.

Adapted from FAA Aeronautical Information Manual (May 19, 2022), 7-1-19:PIREPs Relating to Airframe Icing https://www.faa.gov/air_traffic/publications/atpubs/aim_html/chap7_section_1.html#NX47K11a1sher

- Severity part of forecast and pilot reports (subjective assessment)
- Severity is aircraft-dependent: low accumulation rate can have severe impact
- Not directly linked to SLDs, severe icing might be different

Wing Ice Formation - Typical Shapes

■ Rime Ice:

- milky, containing air inclusions
- covers the surface, follows its shape
- typically at lower temperatures with lower ice density



Credit: DLR (T. Hauf)

■ Glaze Ice:

- transparent and very hard
- building typical horns
- typically at higher temperatures with high ice density



Credit: BFU, Interim Report BFU CX001-13

■ Mixed Ice: combination of rime and glaze

Wing Ice Formation

Supercooled Large Droplets (SLDs)

- Supercooled **Large** Droplets: above $50\ \mu\text{m}$
- Run-back ice:
 - impinging water not freezing instantly
 - cold water running along surface freezing downstream
- Beak-ice:
 - water impingement behind the leading edge
 - likely for thermally protected leading edges due to, e.g.
 - water freezing behind protected areas (run-back ice)
 - water evaporating on leading edges (no ice accretion)

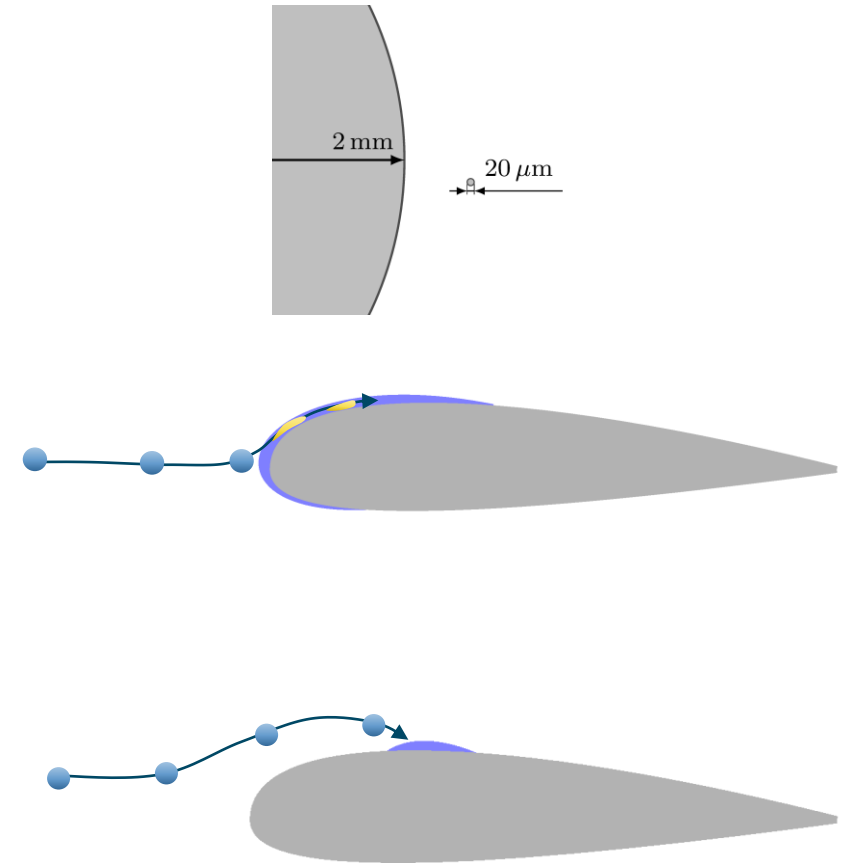

Supercooled Large Droplets (> 50 μ m)

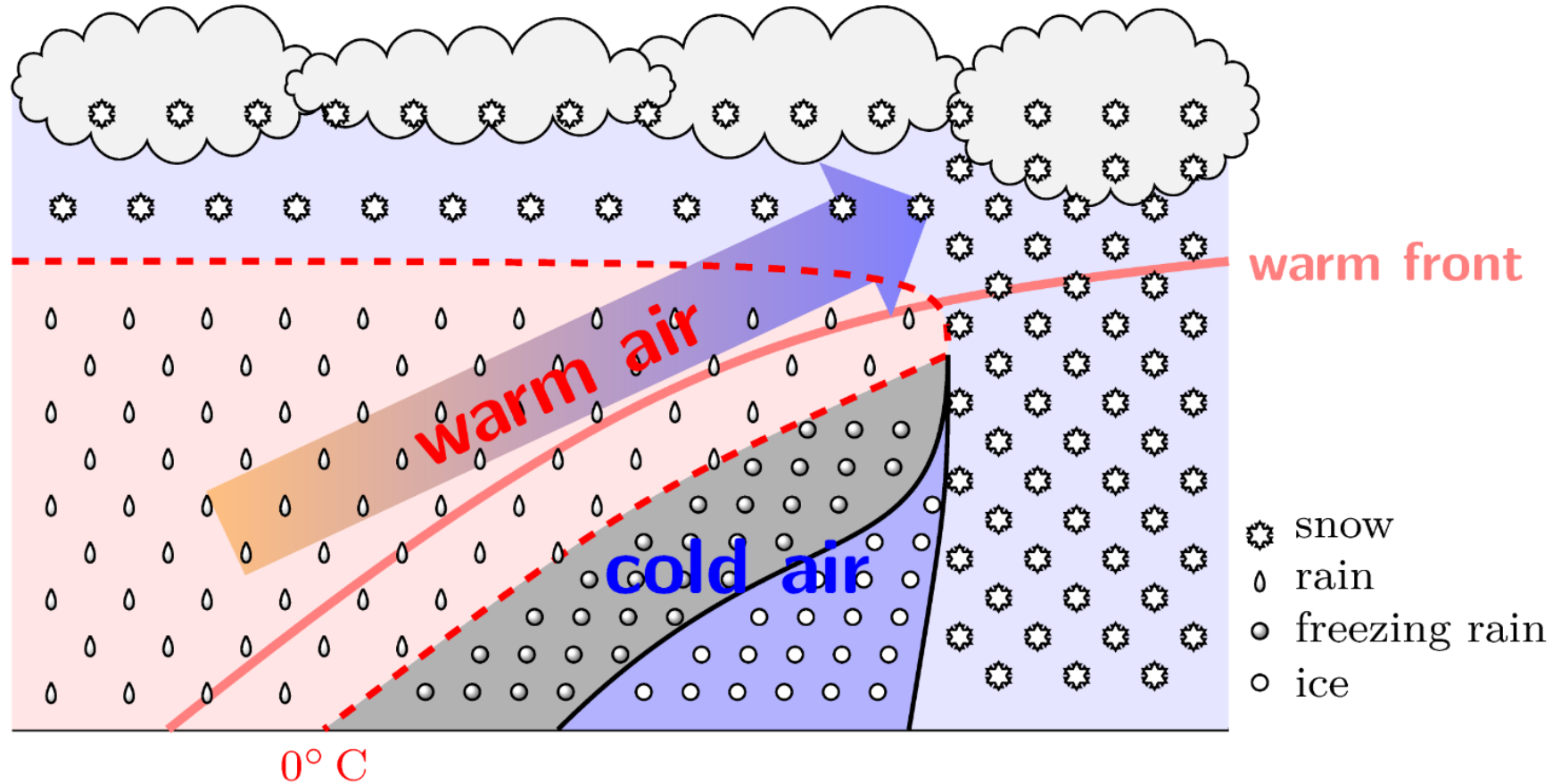

- High reaching clouds containing snow, which is melting in the warm air to large drops
- Part of large droplets falling down being supercooled in cold air
- Without nucleus for crystallization, SLD from freezing drizzle or freezing rain

Effect of Ice Accretion on Airplane Aerodynamics

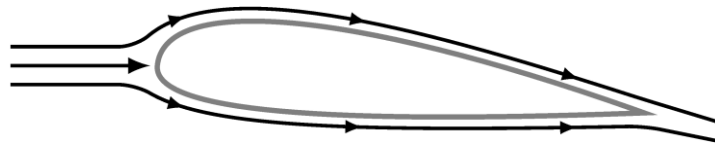

clean airfoil with attached flow
at medium angle of attack

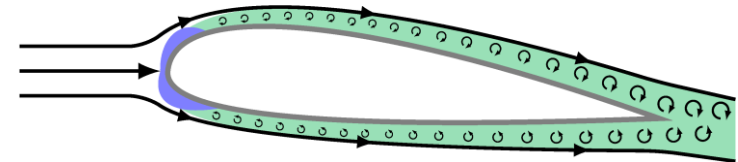

iced airfoil with disturbed flow
at medium angle of attack

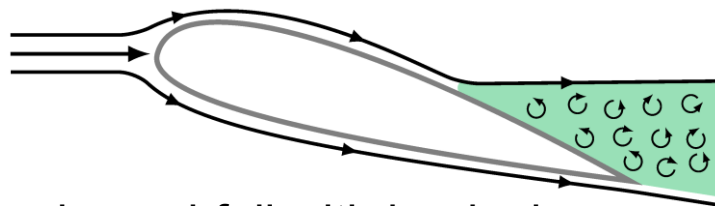

clean airfoil with beginning
trailing edge flow separation at
high angle of attack

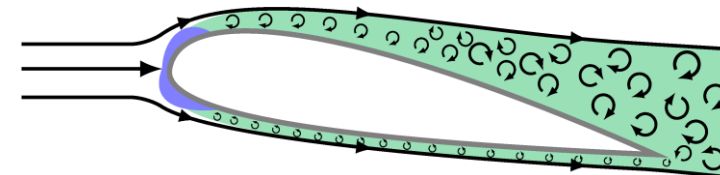

iced airfoil with detached flow
at higher angle of attack

- Significant disturbance of flow around airfoil
- Premature, sudden stall behavior with complete flow detachment
- Specific effects strongly correlated to form of ice accretion

Introduction of Appendix O to Certification Requirements



- Roselawn (IN, USA) fatal accident 1994:
 - Crash of American Eagle / Simmons Airlines flight 4184 (ATR 72-200) after encountering SLD icing conditions
 - Loss of control with flight control reversal due to SLD ice accretion behind protected areas
- Several additional accidents related to SLD ice afterwards, mainly for commuter class aircraft with reversible flight controls
- Existing certification requirements not sufficient anymore: Appendix C not covering all relevant icing conditions



Definition of Appendix O (CS-25)

CS 25.1420 Supercooled large drop icing conditions (AMC 25.1420)



(a) If certification for flight in icing conditions is sought, in addition to the requirements of CS 25.1419, the aeroplane must be capable of operating in accordance with sub-paragraphs (a)(1), (a)(2), or (a)(3) of this paragraph.

(1) **Operating safely after encountering the icing conditions** defined in Appendix O:

- (i) The aeroplane must have a means to **detect that it is operating in Appendix O icing conditions**; and
- (ii) Following detection of Appendix O icing conditions, the aeroplane must be **capable of operating safely while exiting all icing conditions**.

(2) **Operating safely in a portion of the icing conditions** defined in Appendix O as selected by the applicant.

- (i) The aeroplane must have a means to **detect that it is operating in conditions that exceed the selected portion of Appendix O icing conditions**; and
- (ii) Following detection, the aeroplane must be **capable of operating safely while exiting all icing conditions**.

(3) **Operating safely in the icing conditions defined in Appendix O**.

(b) To establish that the aeroplane can operate safely as required in sub-paragraph (a) of this paragraph, an applicant must show through analysis that the ice protection for the various components of the aeroplane is adequate, taking into account the various aeroplane operational configurations...

- Specific regulations pose challenges to aircraft ice protection, ice detection and operations.
- No sensor technologies commercially available fulfill the above given requirements, whether full App. O detection or reliable portion detection.

Definition of Appendix O

Difference Between CS-25 and FAA 14 CFR Part 25



CS-25:

(a) If certification for flight in icing conditions is sought, in addition to the requirements of CS 25.1419, **the aeroplane** must be capable of operating in accordance with sub-paragraphs (a)(1), (a)(2), or (a)(3) of this paragraph.

FAA 14 CFR Part 25:

(a) If certification for flight in icing conditions is sought, in addition to the requirements of § 25.1419, **an airplane with a maximum takeoff weight less than 60,000 pounds or with reversible flight controls** must be capable of operating in accordance with paragraphs (a)(1), (2), or (3), of this section

- Restriction to smaller aircraft (e.g. commuter types) or reversible flight controls reasonable for certification: main occurrences for SLD-related accidents with these types

Appendix C & O Meteorology

continuous maximum (stratiform clouds)
atmospheric icing conditions liquid water
content vs mean effective drop diameter

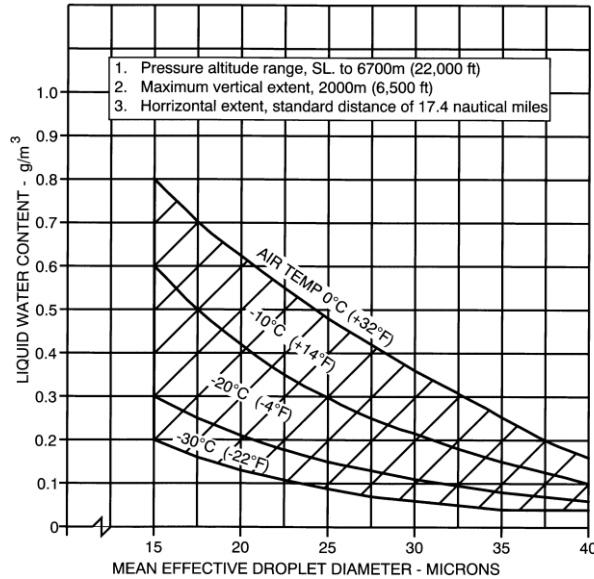

CS-25 BOOK 1 (CS-25 Amendment 21, Annex to ED Decision 2018/005/R), Appendix C, Figure 1

Appendix O, Freezing Drizzle, Liquid Water Content

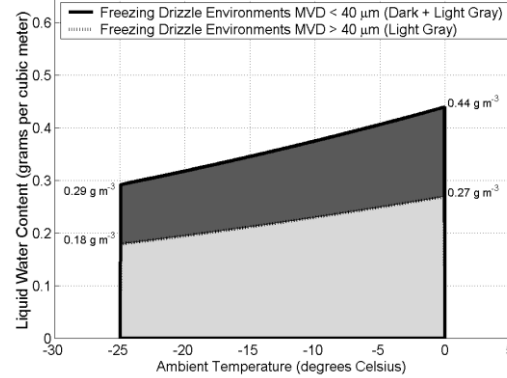

Appendix O, Freezing Rain, Liquid Water Content

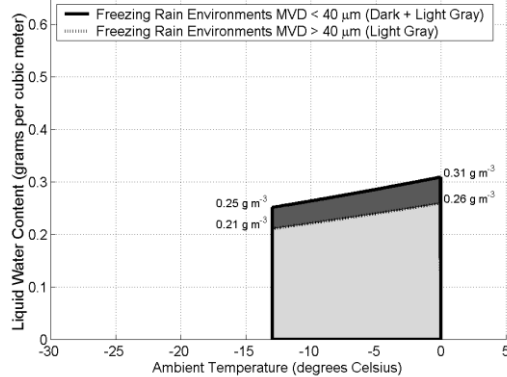

Appendix O, Freezing Drizzle, Drop Diameter Distribution

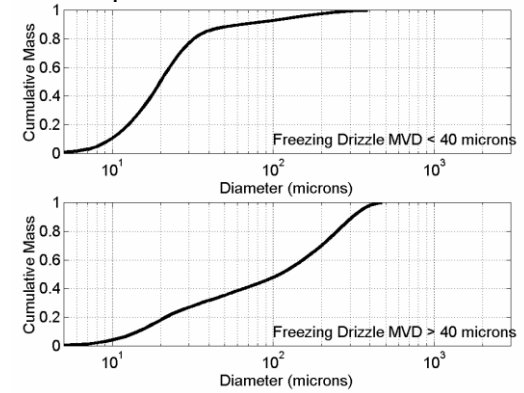

Appendix O, Freezing Rain, Drop Diameter Distribution

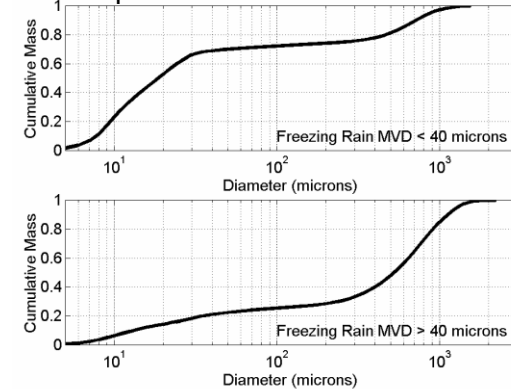

CS-25 BOOK 1 (CS-25 Amendment 21, Annex to ED Decision 2018/005/R), Appendix O, Figure 1 & 2

CS-25 BOOK 1 (CS-25 Amendment 21, Annex to ED Decision 2018/005/R), Appendix O, Figure 4 & 5

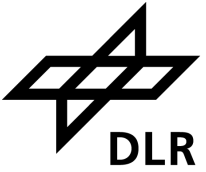

- Appendix O covers a much larger portion of atmospheric icing conditions than Appendix C
- But: Appendix O conditions are very rare and for some parts even more unlikely to occur

Airplane Icing Effects

Accretion on all surfaces facing the inflow, e.g.

- wings (leading edges)
- horizontal and vertical tail (leading edges)
- nose and windshield
- engine intakes (or propellers)
- sensor probes
- control surfaces

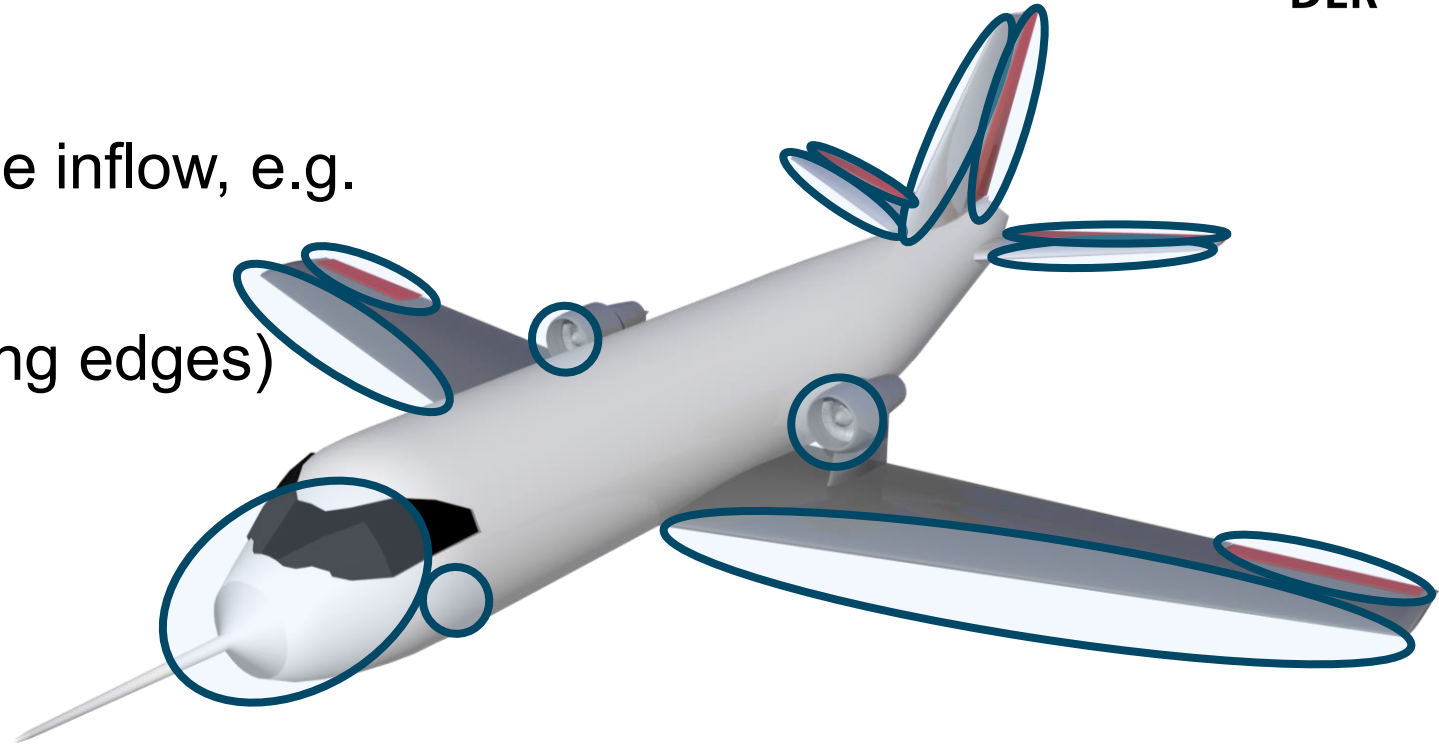

- Different effects of ice accretion on aircraft characteristics reaching from **performance degradation to change of dynamics and loss of control** or essential **structural damage**
- **Increase** of aircraft **weight** through ice accretion: mainly relevant for smaller aircraft

Effect of Ice Accretion on Airplane Aerodynamics

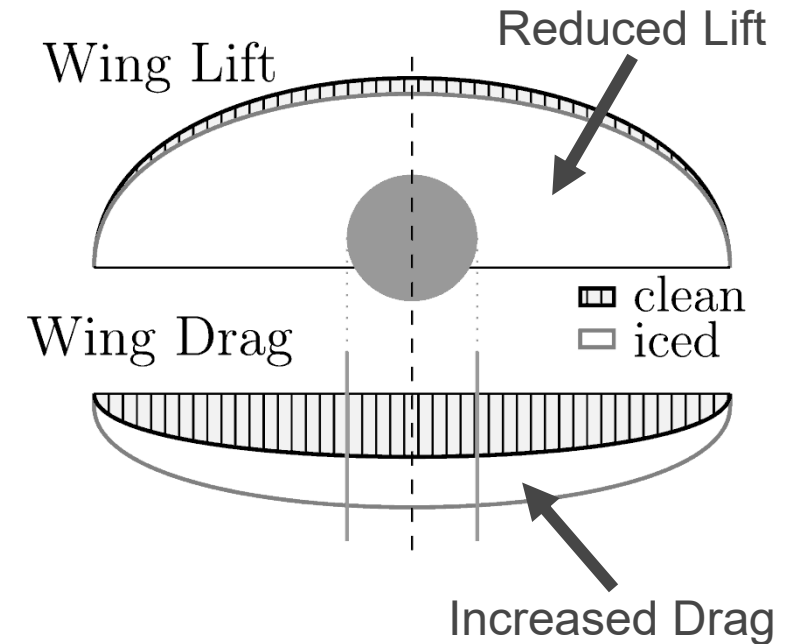
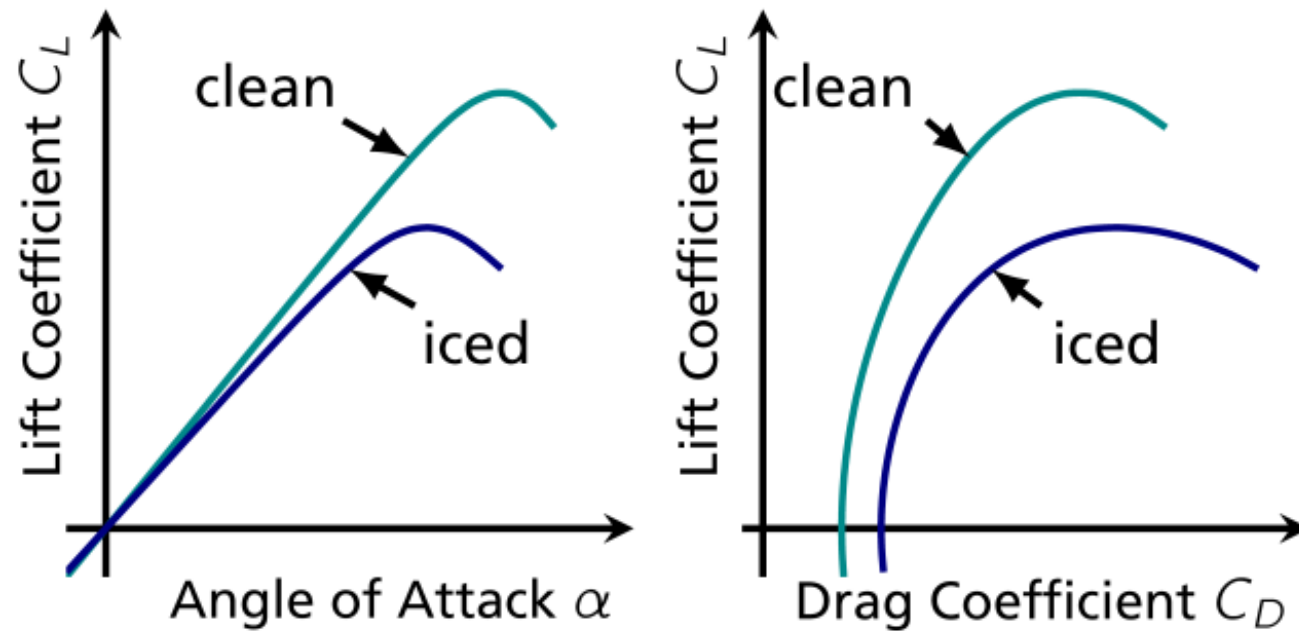

- Significant drag increase: change of surface roughness and curvature, and lift-induced drag
- Reduction of maximum angle of attack \rightarrow maximum lift decrease
- Change in lift curve slope

Ice Formation on Lifting Surfaces Wings, Horizontal and Vertical Tail

- Degradation of aircraft flight performance
- Wing and/or fuselage ice accretion cause significant change in L/D
 - additional thrust required to maintain flight condition
 - reduced climb performance
- Wing ice (may) cause reduced max. angle of attack
→ premature stall
- Horizontal and vertical tail ice can lead to changes in aircraft dynamics and controllability



Credit: BFU, Interim Report BFU CX001-13

- Flight performance degradation mainly affects the range, endurance and therefore the aircraft's operational envelope

Ice Formation on Lifting Surfaces Wings, Horizontal and Vertical Tail (continued)

- Change of airfoil aerodynamic performance, wing or tail lift distribution, and control surface effectiveness (worst case: reversal)
- Asymmetric ice distributions can lead to sudden loss of control due to, e.g.
 - Non-uniform ice accretion and local stronger aerodynamic degradation
→ local flow separation on wing
 - Local ice shedding leading to asymmetric lift distribution

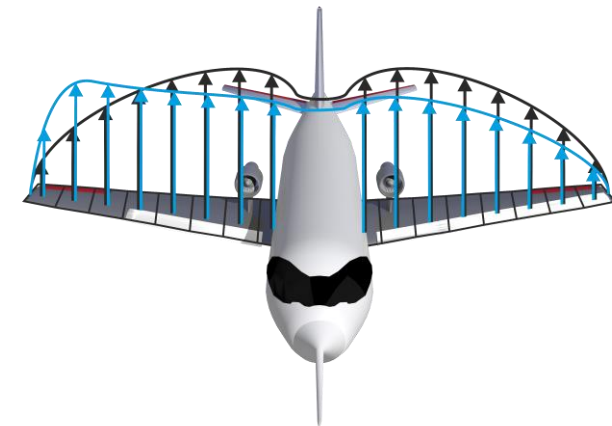
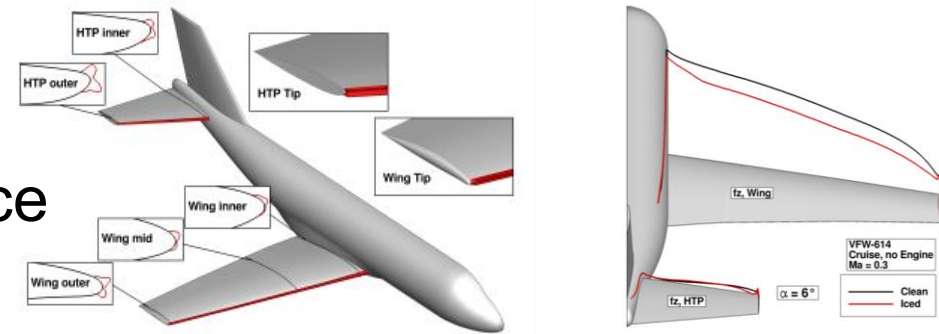

- Wing and horizontal tail ice accretion most important safety issue for airplanes
→ major focus for ice protection

Ice Formation on Aircraft Nose and Windshield

NASA Twin Otter:

Post-flight image of ice contamination as a result of encountering **Supercooled Large Droplet (SLD)** conditions (near Parkersburg, WV.)



Credit: NASA (GRC), general permission for usage for educational and informational purposes (NASA Media Usage Guidelines), https://www.nasa.gov/sites/default/files/thumbnails/image/36_anti_icing_technology.jpg

- Parasite drag increase due to (large) ice formation changing flow around aircraft fuselage
- Windshield ice can reduce outside view drastically
- Iced wipers functionless

Ice Formation on Engine Intakes or Propellers

- Propeller ice accretion causing, e.g.
 - reduced thrust
 - propeller vibrations
 - damage on fuselage when shedding
- Engine inlet ice accretion causing, e.g.
 - fan blade damage when shedding
 - flameout



Public Domain,
<https://commons.wikimedia.org/wiki/File:Isbildung.JPG>



CC BY-SA 4.0, Olivier Cleynen,
[https://commons.wikimedia.org/wiki/File:Icing_on_the_inlet_of_a_CFM56_turbofan_engine_\(2\).jpg](https://commons.wikimedia.org/wiki/File:Icing_on_the_inlet_of_a_CFM56_turbofan_engine_(2).jpg), Zoom

- Minor impact on aircraft flight performance and control but flight safety, maintenance and operational lifetime

Ice Formation on Sensor Probes

Angle of Attack Vane



Credit: DLR (C. Raab)

XL Airways Germany Flight 888T
(Airbus A320) accident near Perpignan:
frozen AoA vane (2008)

Pitot / Total Pressure Probe



Credit: DLR (C. Raab)

Air France Flight 447 (Airbus A330)
accident over Atlantic Ocean: blocked
pitot probe due to icing (2009)

Static Pressure Port



Credit: DLR (C. Raab)

- Air data probes highly relevant for safe operations and reliable avionic functions
- Probes and vanes heated for ice protection

Current Means of Ice Detection

Remote Detection / Forecast

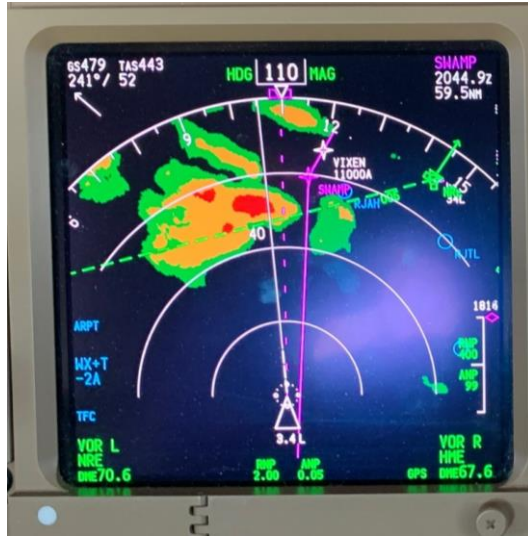

Credit: Felix Gottwald, B777 weather radar, private photo with dedicated permission to use

In-Situ Detection



Credit: CC BY 4.0, Julian Herzog, zoom from https://commons.wikimedia.org/wiki/File:Qatar_Airways_Boeing_787_Dreamliner_A7-BCD_PAS_2013_03_ice_detector.jpg

Visual Cues



Credit: NASA (GRC), general permission for usage for educational and informational purposes (NASA Media Usage Guidelines), https://www.nasa.gov/sites/default/files/thumbnails/image/36_anti_icing_technology.jpg



Credit: DLR

Experience



Credit: DLR

- **Detection** of potential icing conditions, atmospheric conditions prone to icing, ice accretion on indication surfaces, abnormal aircraft behavior
- **No detection** of specific conditions (C or O), location and severity of ice accretion, degradation of aircraft capabilities

Aircraft Ice Protection - Typical Ice Control Methods



Location of Ice	Method of Control
Leading edge of the wing	Thermal pneumatic, thermal electric, chemical, and pneumatic (deice)
Leading edges of vertical and horizontal stabilizers	Thermal pneumatic, thermal electric, and pneumatic (deice)
Windshield, windows	Thermal pneumatic, thermal electric, and chemical
Heater and engine air inlets	Thermal pneumatic and thermal electric
Pitot and static air data sensors	Thermal electric
Propeller blade leading edge and spinner	Thermal electric and chemical

U.S. Department of Transportation, FEDERAL AVIATION ADMINISTRATION (FAA),
Aviation Maintenance Technician Handbook– Airframe, Volume 2, (FAA-H-8083-31A), p. 15-4

- Ice protection and countermeasures dependent on aircraft size and overall system design
- General aviation and small transport aircraft using mainly pneumatic or chemical deicing
- Large transport aircraft using mainly thermal deice and anti-ice

Thermal Wing (& Engine) Anti-Ice / Deice

- Bleed air from jet engines blown through the airframe structure heating the surfaces
- Electro-thermal: heating elements inside the airframe structure instead of bleed air (e.g. B787)

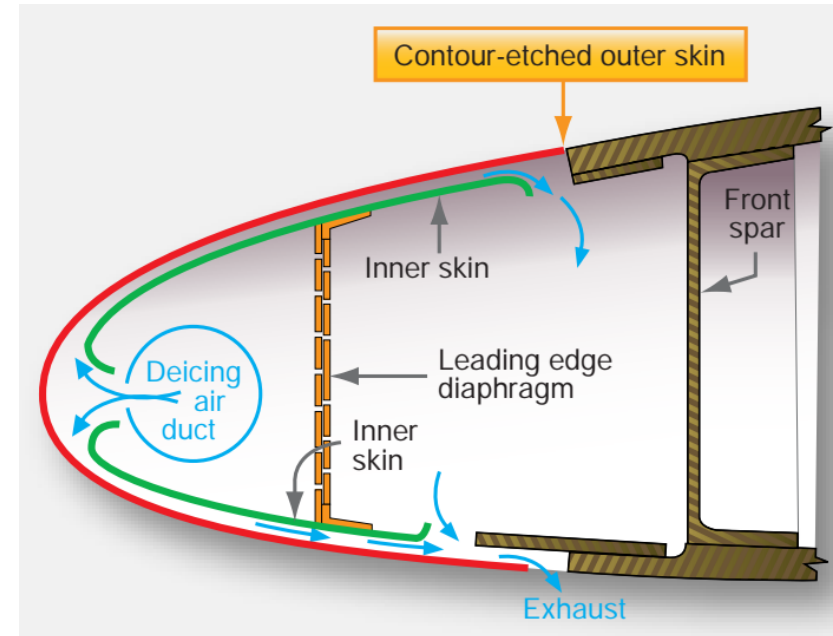

U.S. Department of Transportation, FEDERAL AVIATION ADMINISTRATION (FAA), Aviation Maintenance Technician Handbook– Airframe, Volume 2, (FAA-H-8083-31A), p. 15-5, Fig. 15-8

- Relatively high energy consumption for protecting the airframe from ice accretion when using bleed air, which reduces the jet engine's efficiency
- Electro-thermal systems with reduced energy consumption compared to bleed air systems, but the need to provide sufficient electrical power

Thermal Wing Anti-Ice / Deice (continued)



Credit: DLR (C. Raab)



Credit: DLR (C. Raab)

- Thermal anti-ice system on leading edge / slats (DLR's Falcon 2000LX ISTAR)

Pneumatic Wing Deicing Boots

- Rubber boots on, e.g., wing leading edge to mechanically remove ice accretion
- Deflation causes ice detachment and the airflow removes the ice

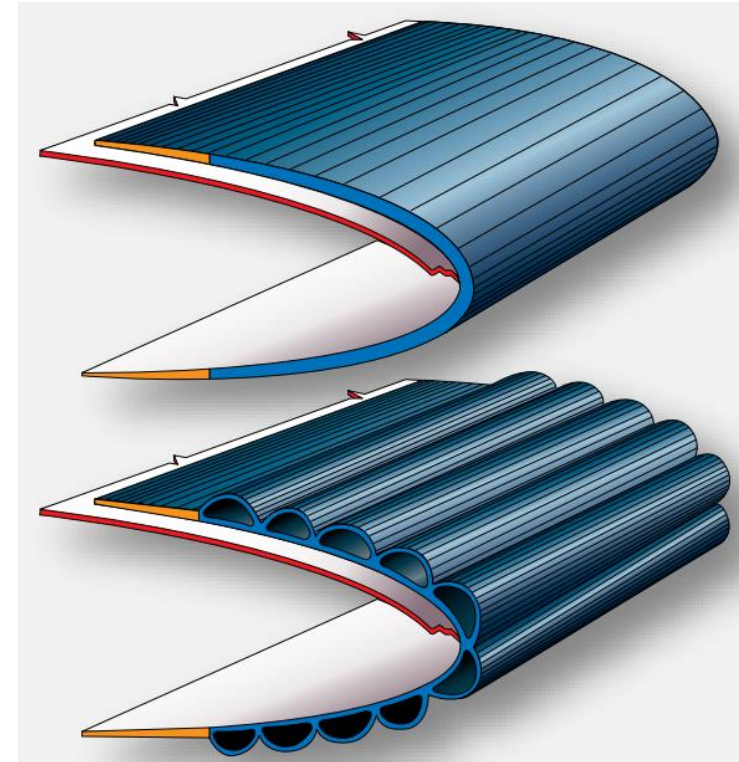

U.S. Department of Transportation, FEDERAL AVIATION ADMINISTRATION (FAA), Aviation Maintenance Technician Handbook– Airframe, Volume 2, (FAA-H-8083-31A), p. 15-13, Fig. 15-17

- Low to moderate energy consumption for protecting the airframe from ice accretion
- Cyclic deflation requires sufficient ice on the protected surface to be removed
→ slushy ice not being removed but building a shell around deflated boots (theoretically)

Pneumatic Wing Deicing Boots (continued)



Credit: SAFIRE (SENS4ICE Project)

- Example of pneumatic boots on ATR-42 320

Chemical Anti-Ice / Deice

Special fluid pressed through porous distributor panels causing

- detachment of wing ice → blow off
- prevention of ice formation on the airframe (anti-ice)

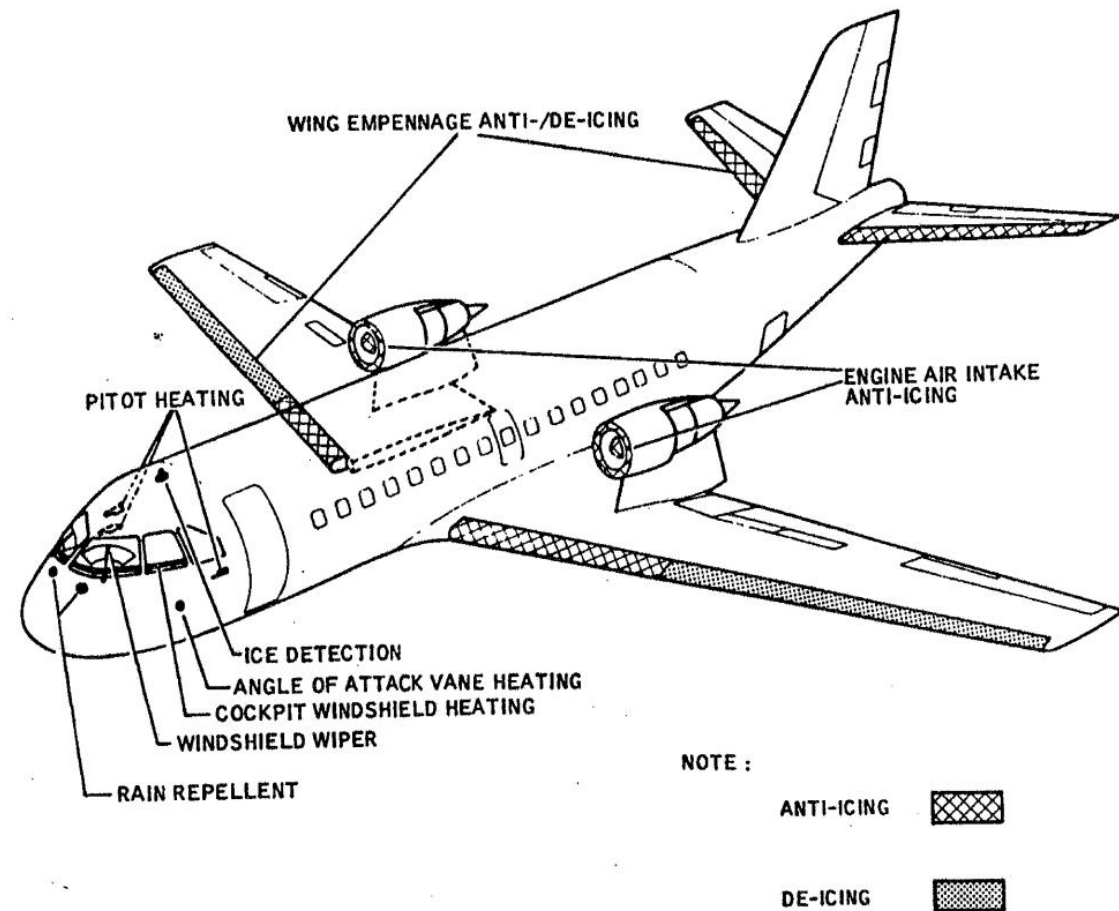

- Limited time of operation, e.g. only 1.5 hours of continuous operation for VFW 614

Chemical Anti-Ice / Deice (continued)



ATTAS horizontal tail leading edge face

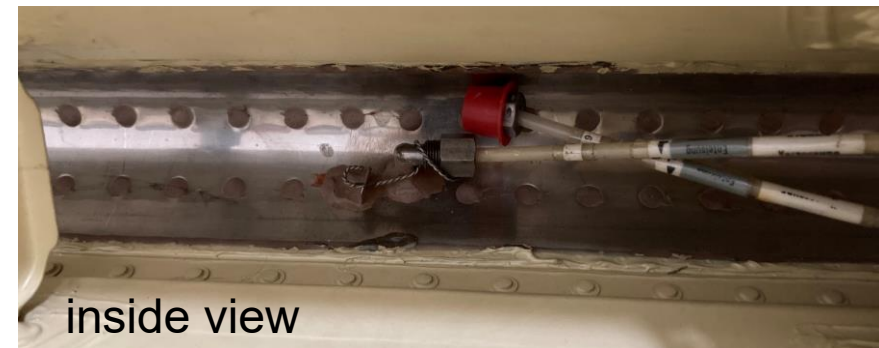

inside view

- Porous distributor panels only on leading edge faces, fluid transported with flow along the wing or horizontal tail

Further Countermeasures for In-Flight Icing

- **Electro Impulse De-Icing (EIDI):**
mechanical detachment of ice accretion in the airframe surface using distributed small electric actuators
- **Low Frequency De-Icing (LFDI):**
vibrating structure at resonance frequencies causing skin deformation leading to ice detachment
- **Icephobic coatings:**
airframe surface coating reducing the adhesion between ice and airframe

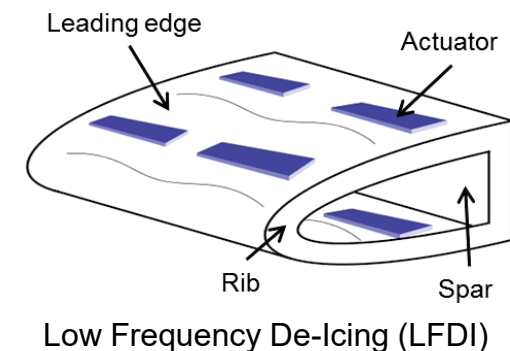
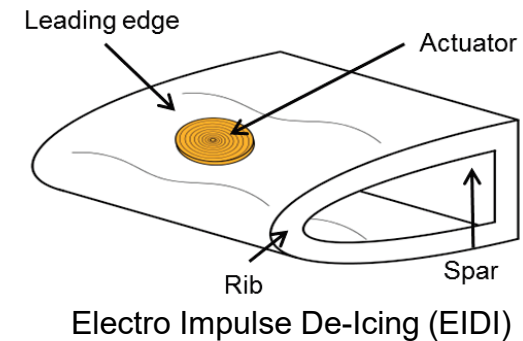

Challenges with SLD Icing

- Impingement behind the leading edge

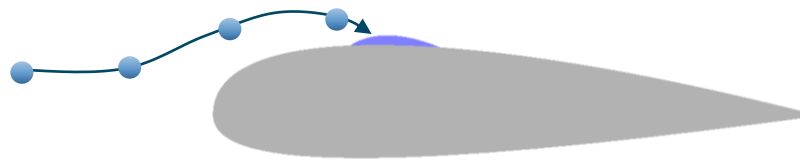

- Supercooled water running downstream



Credit: DLR (C. Raab)

- Ice accretion behind protected areas preventing safe flight through SLD icing conditions
- Challenges for full SLD ice certification with existing protection systems

Ground Deicing

- Hot fluid (55°C - 80°C for type I) used for ice/snow removal
- 4 different fluid types with specific characteristics
 - Type I: low viscosity, short holdover time
 - Type II, IV: higher viscosity, longer holdover time, higher T/O speeds
 - Type III: compromise between I and II
- Strong deicing capabilities but only short time ice protection (type I)
- Holdover Time (HOT) between 1 and (up to) 22 minutes (type I fluids)



Credit: public domain, Sgt. Steve Cortez, U.S. military, Department of Defense, https://commons.wikimedia.org/wiki/File:A_U.S._Army_C-37B_aircraft_transporting_Army_Chief_of_Staff_Gen._Raymond_T._Odierno,_gets_de-iced_before_it_departs_Joint_Base_Elmendorf-Richardson,_Alaska.jpg

- Ground deicing provides only short-time ice protection for taxi and take-off
- No replacement for countermeasures installed on aircraft
- Negative environmental impact

Excursion: Numerical Simulation of Ice Accretion

— Clean Airfoil — APP.C
 - - FZDZ < 40 - - FZRA < 40
 — FZDZ > 40 - - FZRA > 40

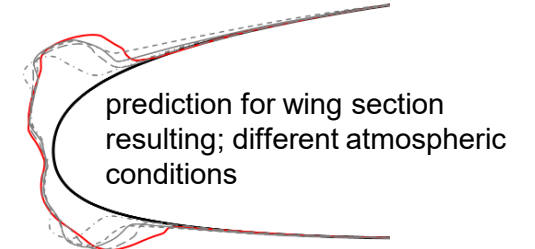

Deiler et al. (2019) Facing the Challenges of Supercooled Large Droplet Icing: Results of a Flight Test Based Joint DLR-Embraer Research Project. SAE International Conference on Icing of Aircraft, Engines, and Structures, 17-21 Jun 2019, Minneapolis, MN, USA. doi: 10.4271/2019-01-1988

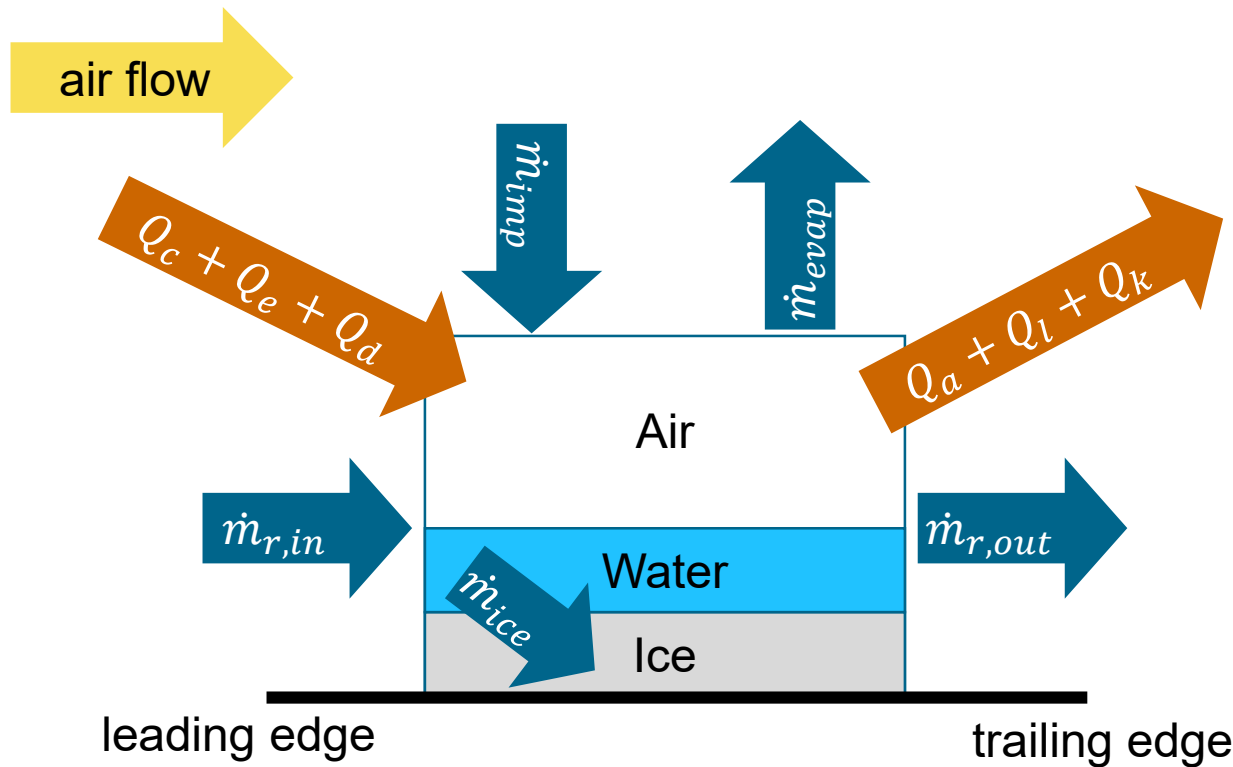

Water Flow

$\dot{m}_{r,in}$: water running in
 $\dot{m}_{r,out}$: water running out
 \dot{m}_{ice} : water freezing to ice
 \dot{m}_{imp} : drops impinging
 \dot{m}_{evap} : water evaporating

Loosing Energy

Q_c : convective heat transfer at the water surface
 Q_e : evaporative heat loss
 Q_d : cooling by incoming drops

Gaining Energy

Q_a : aerodynamic heating
 Q_l : latent heat
 Q_k : kinetic energy of incoming drops

- Simulation code based on Messinger model: energy (and mass) balance
- Very difficult to formulate for 3D cases and SLDs, still subject to ongoing research
- Wide use of, e.g., NASA's Lewice

Icing Wind Tunnels

- Different facilities worldwide
- Reproduction of atmospheric icing conditions
- Wide application for App. C conditions, ongoing modifications and developments for SLDs / App. O
- Limited capabilities for
 - variety of icing conditions (in combination with, e.g., speed)
 - experiment size (depending on facility)
 - experiment duration



Credit: TU Braunschweig

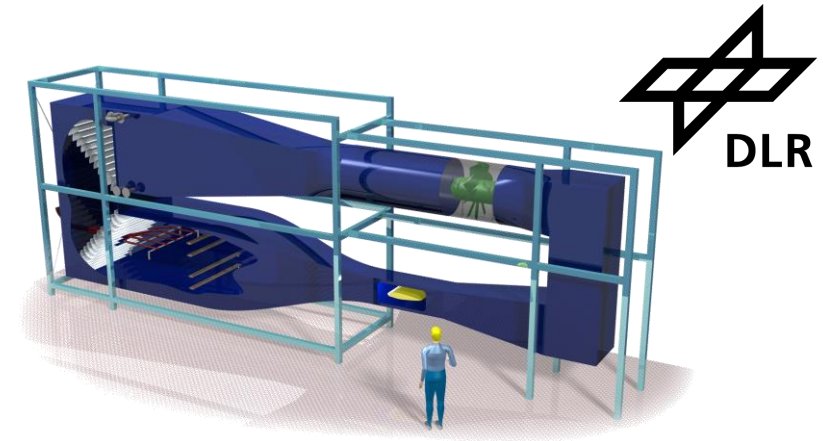

Credit: TU Braunschweig

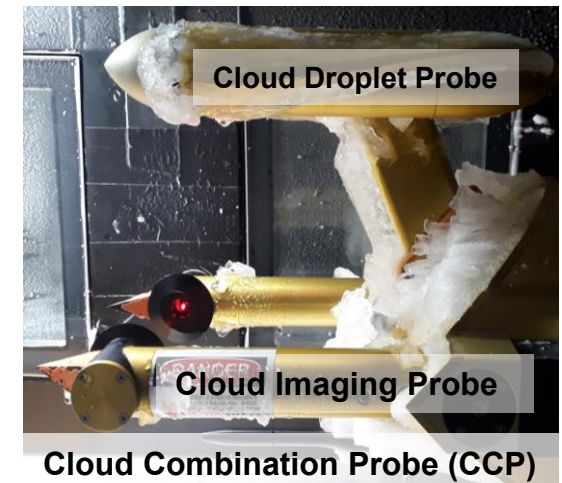

Credit: DLR

- High benefit for experimental validation of simulation
- Real environment testing capabilities
- No replacement for flight test on aircraft system level

Flight Test with Artificial Ice Shapes



- Ice shapes resulting from numerical calculation or wind tunnel testing manufactured and applied to flight test aircraft
 - Critical parts can be kept free of “ice”
 - Test of ice configurations resulting from very rare icing conditions (e.g. parts of App. O)
 - Alternative to natural icing condition flight test and often only option for testing
-
- Artificial ice flight test part of certification programs
 - Reliable source to reveal aircraft characteristics for certain icing conditions/configurations

DLR@Uni Project SuLaDI

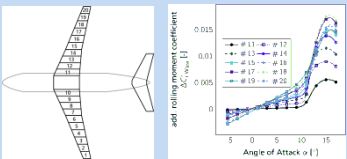
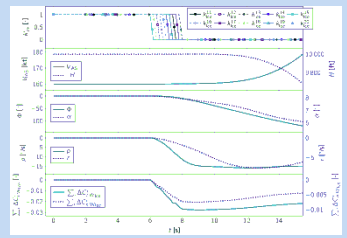
Flight Dynamics & Control



Icing Wind Tunnel



Electro Impulse De-Icing

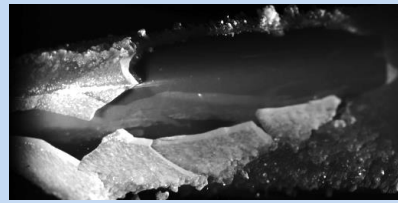

Low Frequency De-Icing

**AVES
(Air Vehicle Simulator)**

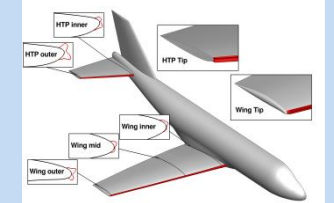
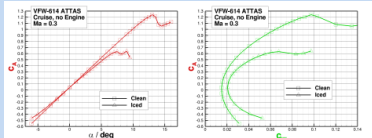

CFD Results

SuLaDI Supercooled Large Droplets Icing



Flight Guidance



**DLR - Embraer
Research Cooperation**

- HGF funded 5 year project (2011-2016)
- Budget ~ 5 Million €
- 8 partners in Braunschweig (4 TUBS, 4 DLR)
- Dedicated support for PhD candidates and young researchers

Credit: SuLaDI project, DLR & TU Braunschweig, DLR/Embraer

Modelling of Icing Effects

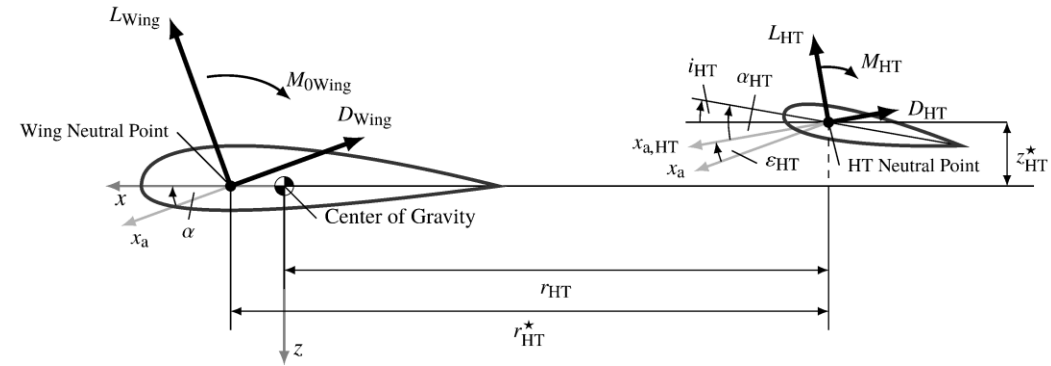

Basic aircraft model formulation:

- longitudinal aerodynamics → two-point model formulation
- lateral aerodynamics → nonlinear derivative model

Iced aircraft model extension:

- Δ -model coefficients analytically derived from basic model
- linear parameter extension:

$$P = (1 + k_p) P_{\text{base}} + d_p = P_{\text{base}} + \Delta P_{\text{ice}}$$

$$C_{(\cdot)}(P) = \left(C_{(\cdot)}(P_{\text{base}}) \right)_{\text{base}} + \Delta \left(C_{(\cdot)}(P_{\text{base}} + \Delta P_{\text{ice}}) \right)_{\text{ice}}$$

- strip model formulation for wing and horizontal tail

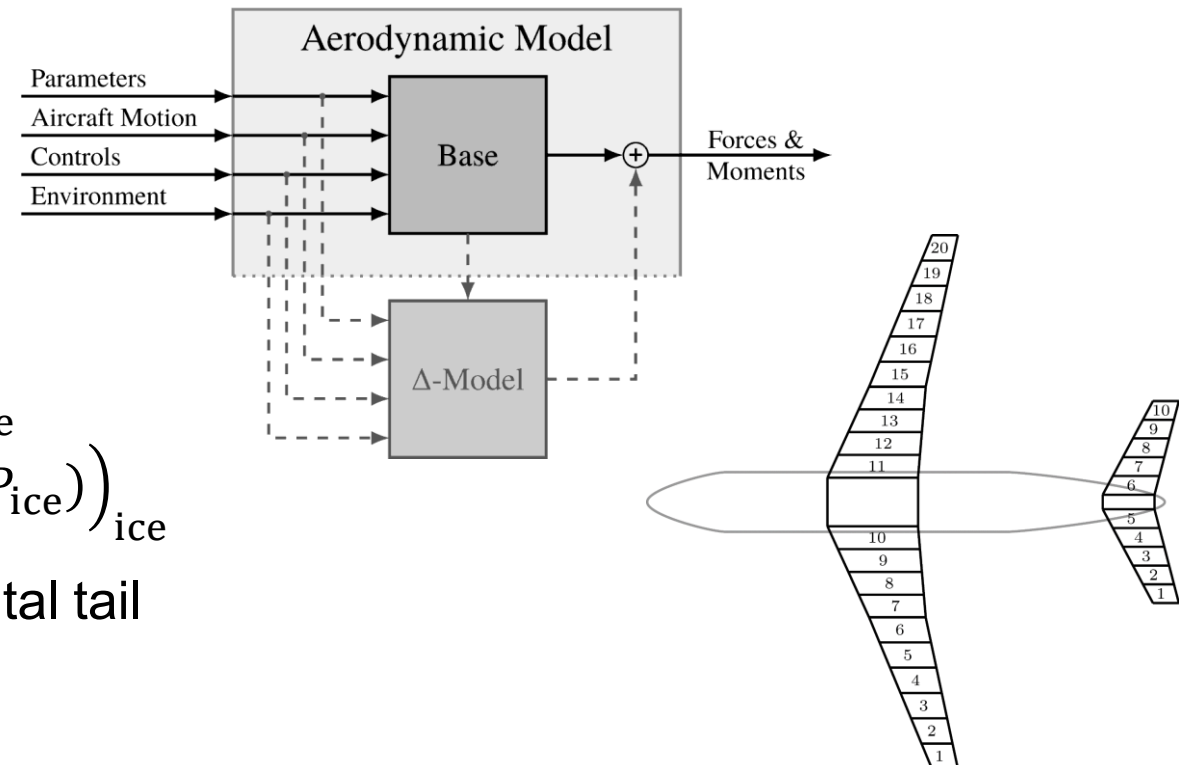

Example of Ice-Induced Limitations of Aircraft Aerodynamics (App. C & O)

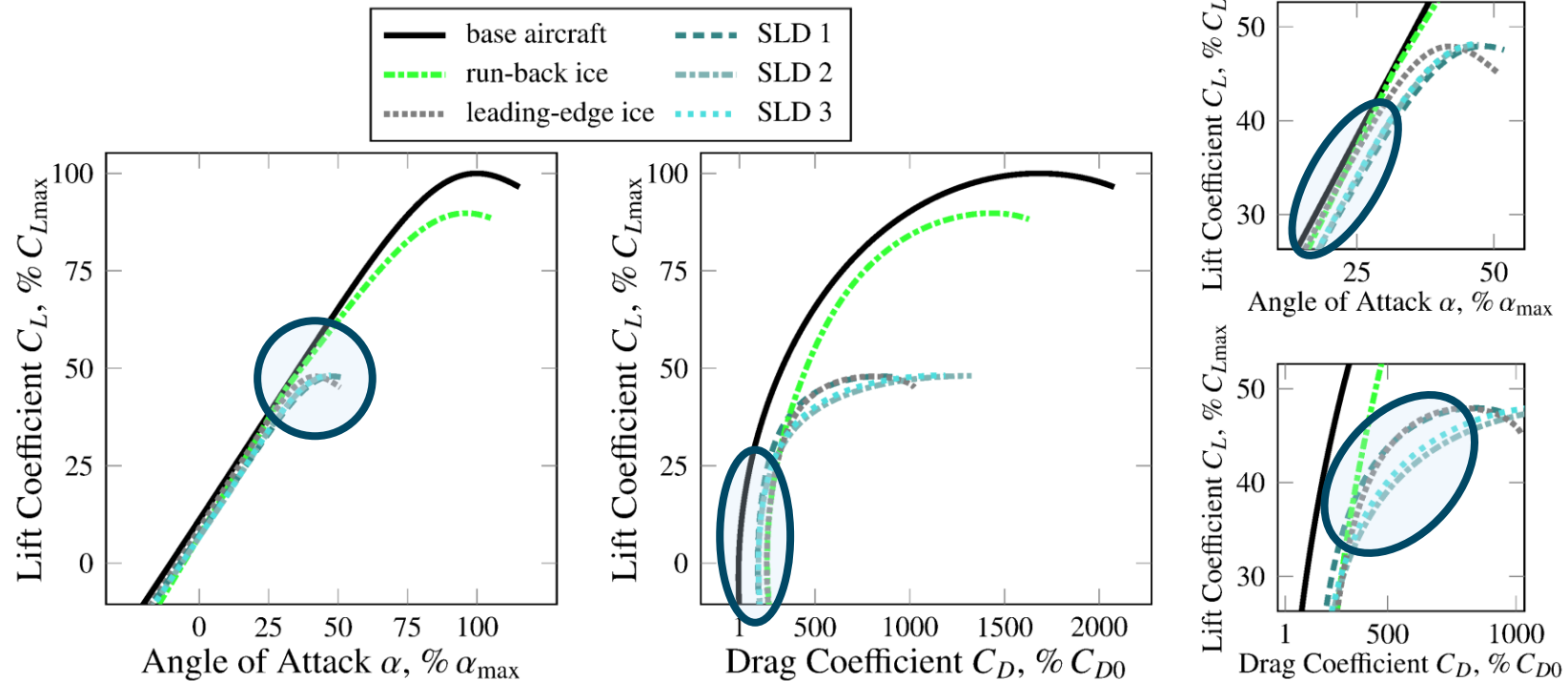

run-back ice case



leading-edge ice case



SLD-ice case



- SLD 1, 2 and 3: different ice shape configurations (on Phenom 300 prototype)
- SLD-ice configurations show similar reduction of max. AoA as leading-edge ice case
→ no unique characteristic related to location of ice accretion
- Comparable increase of zero-lift drag

Christoph Deiler (2021), Flight Characteristics with Different Supercooled Large Droplet Ice Configurations. The Aeronautical Journal. Cambridge University Press. doi: 10.1017/aer.2021.98

Example of Ice-Induced Limitations of Aircraft Flight Performance: Change of Thrust-to-Weight Ratio (App. C & O)

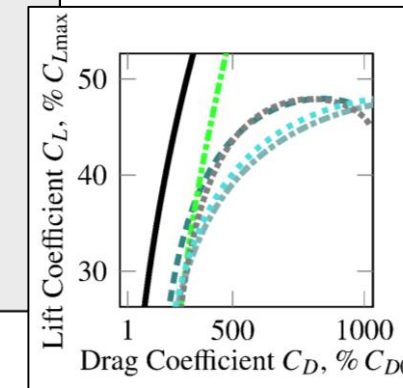
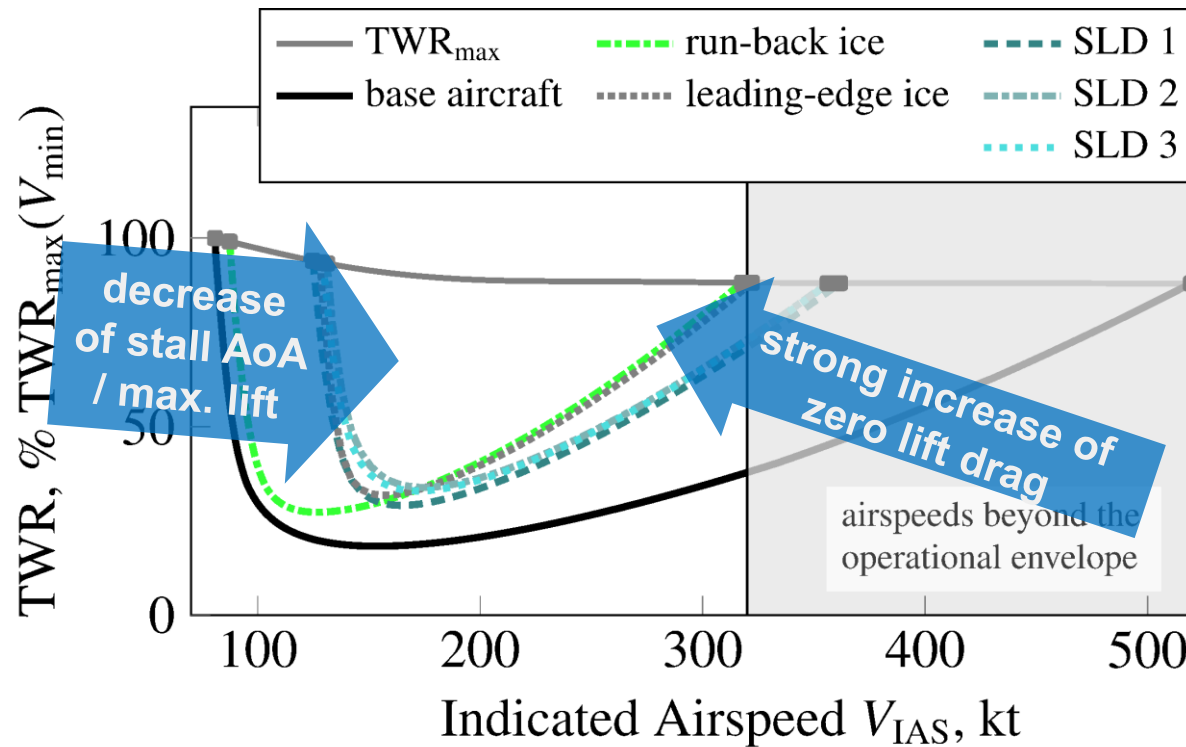
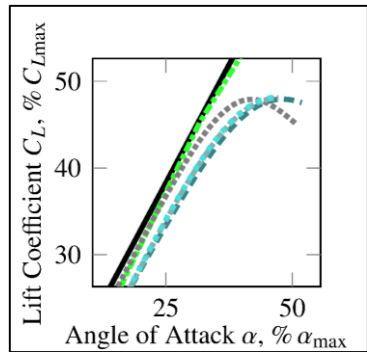

run-back ice case

schematic illustration

leading-edge ice case

schematic illustration

SLD-ice case

schematic illustration

- Significant difference of aerodynamic impact directly affecting flight performance
- Nonlinear models identified from flight test data, trimmed and evaluated

Example of Ice-Induced Changes of Aircraft Flight Dynamics: Exemplary Change of Root Locations (App. C&O)

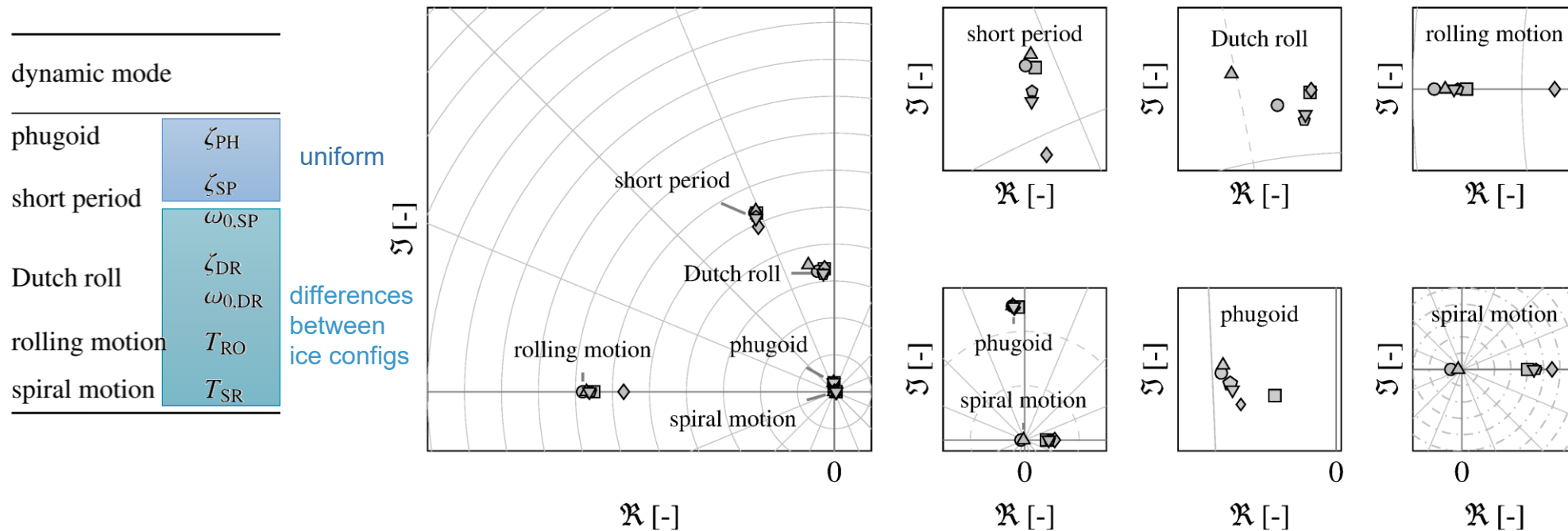
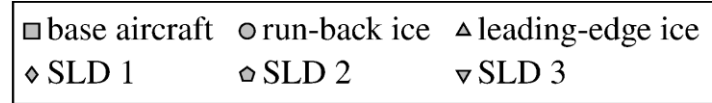

run-back ice case

schematic illustration

leading-edge ice case

schematic illustration

SLD-ice case

schematic illustration

- Nonlinear models identified from flight test data, trimmed and evaluated
- No significant effect on handling qualities (symmetric case)

Example of Ice Shedding Effects on Aircraft (Aero-)Dynamics

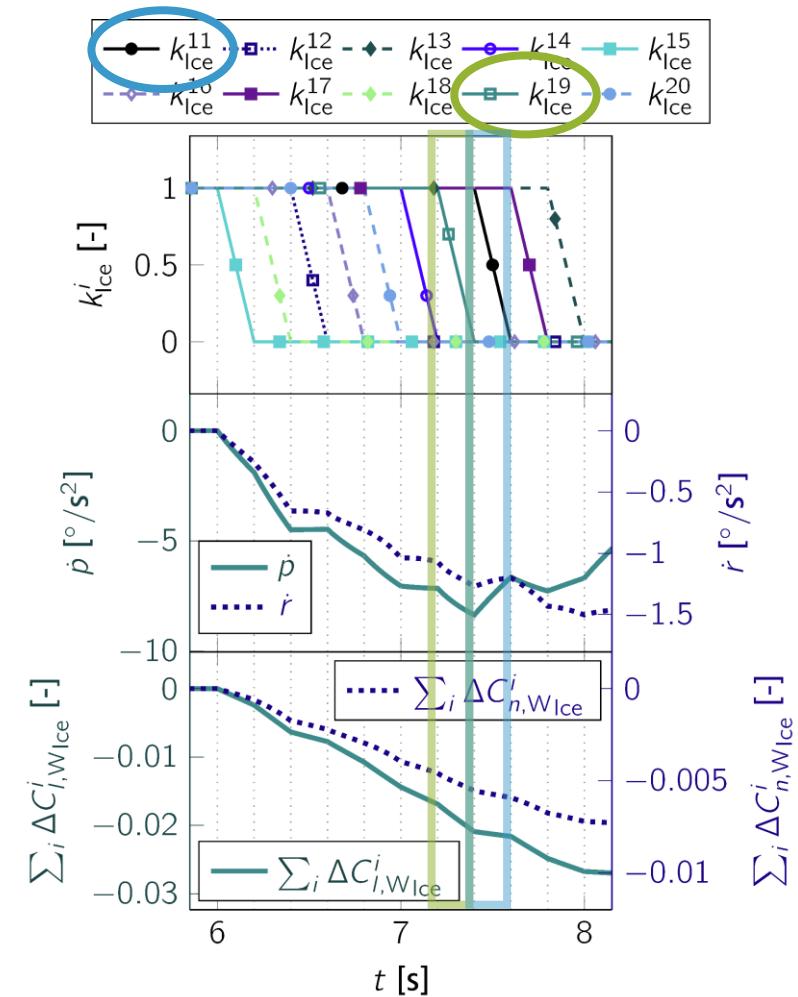
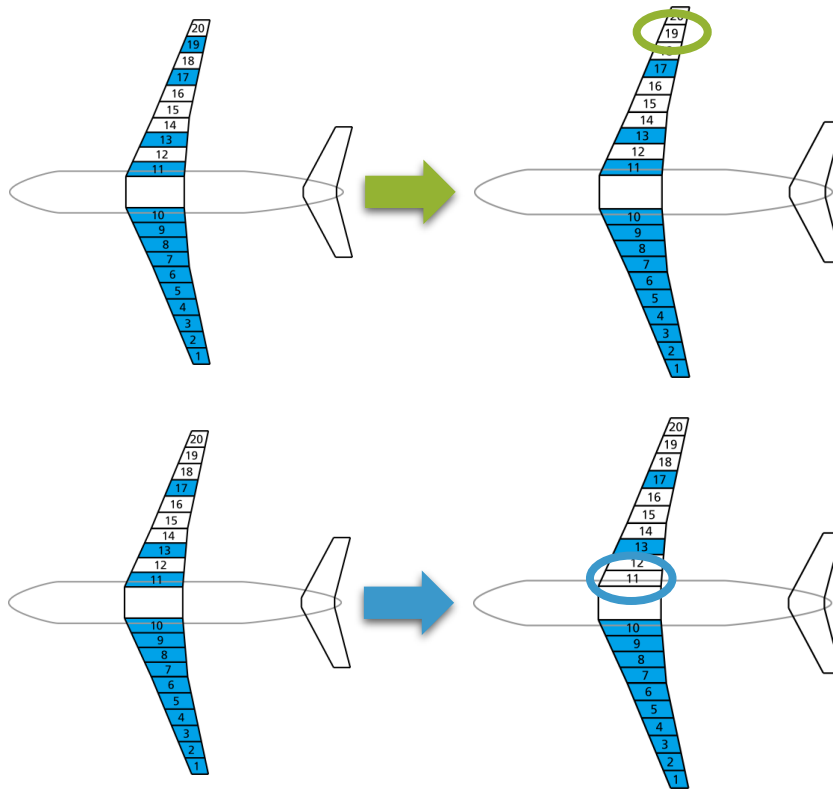
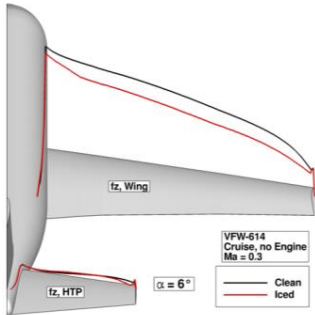

- Additional moments during right wing deicing with random pattern
- Individual strip influence, no aerodynamic interaction considered
→ presumably worsening effects

Deiler, C., Kilian, T. Dynamic aircraft simulation model covering local icing effects. *CEAS Aeronaut J* 9, 429–444 (2018). <https://doi.org/10.1007/s13272-018-0291-6>

Performance-Based Ice Detection

Performance Reference

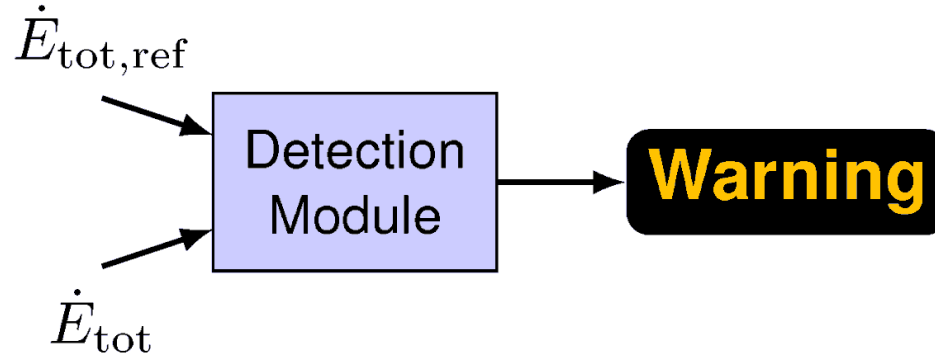

Is the filtered equivalent additional drag above the detection threshold?

Performance State

$$\dot{E}_{\text{tot}} = V_{\text{TAS}} \cdot \dot{V}_{\text{TAS}} \cdot m_{\text{AC}} + \frac{1}{2} \cdot V_{\text{TAS}}^2 \cdot \dot{m}_{\text{AC}} + g \cdot \dot{H} \cdot m_{\text{AC}} + g \cdot H \cdot \dot{m}_{\text{AC}}$$

Equivalent additional drag:

$$\Delta C_{\tilde{D}} \approx \frac{\dot{E}_{\text{tot,ref}} - \dot{E}_{\text{tot}}}{V_{\text{TAS}} \cdot \bar{q} \cdot S_{\text{Wing}}}$$

- Detection of icing with no excitation (steady-state flight): slow accretion of ice and slow restoration of original performance

Horizon 2020 Project SENS4ICE

SENSors and certifiable hybrid architectures for safer aviation in ICing Environment

- SENS4ICE fills the gap of SLD icing detection (App. O)
 - Technology development, test, validation & maturation
→ TRL 5 of hybrid system at the end of SENS4ICE
 - Technology demonstration in relevant icing conditions: testing facilities & flight test
→ SENS4ICE will provide large database of icing conditions
 - Close cooperation with regulation authorities for development of new certifiable hybrid ice detection system
→ SENS4ICE will provide an acceptable means of compliance
- **SENS4ICE contributes to increase aviation safety in SLD icing conditions**

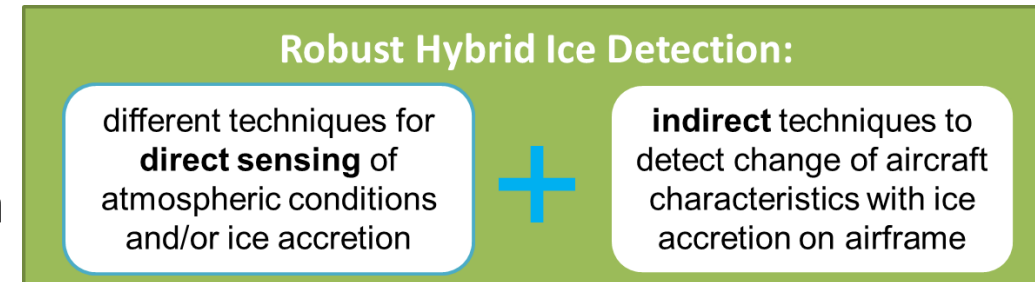

- JAN 2019 – DEC 2023
- 11.9 M€ including 6.6 M€ EU contribution
- Coordinator DLR + 16 project partners
- #sens4iceproject on LinkedIn
- <https://www.sens4ice-project.eu>

SENS4ICE Timeline

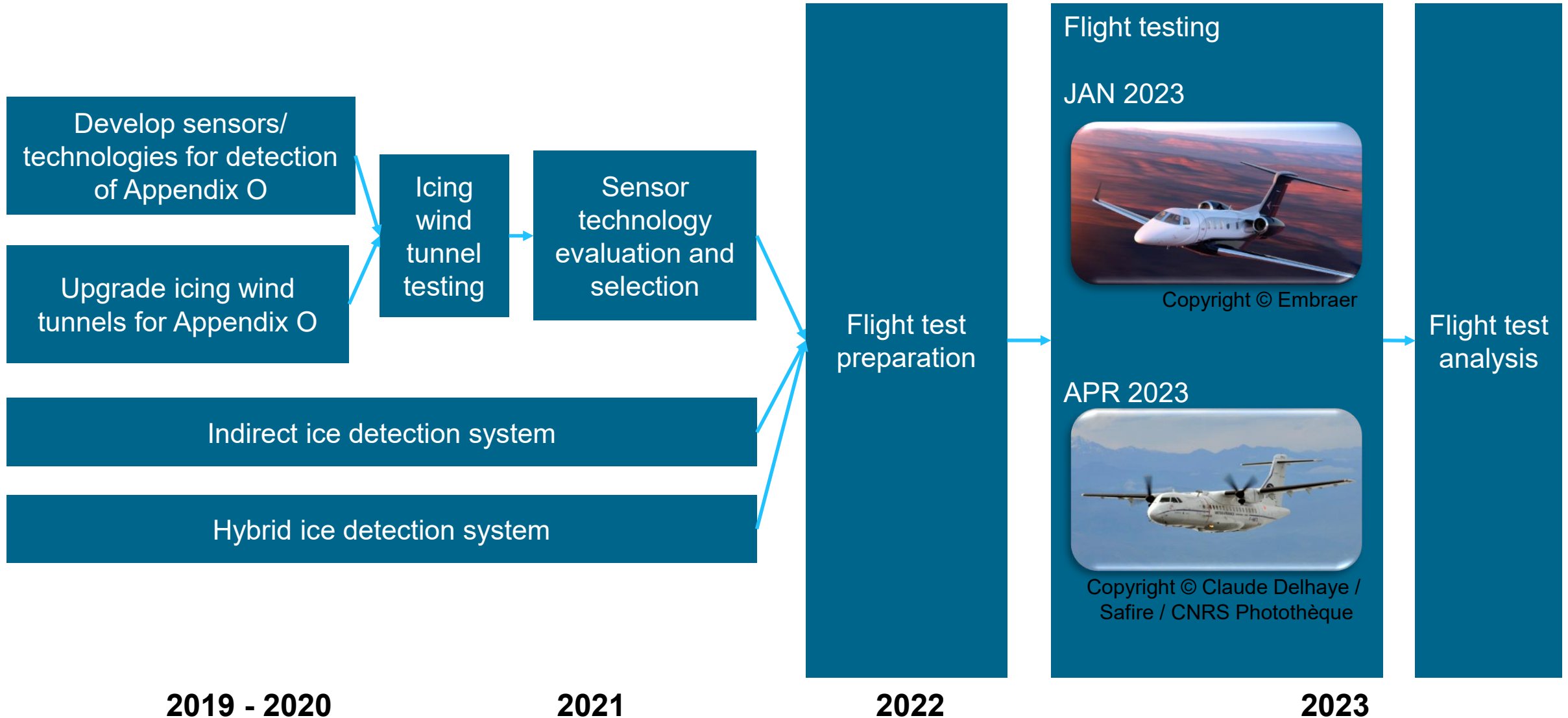

SENS4ICE Layered Safety Concept for Liquid Water Icing

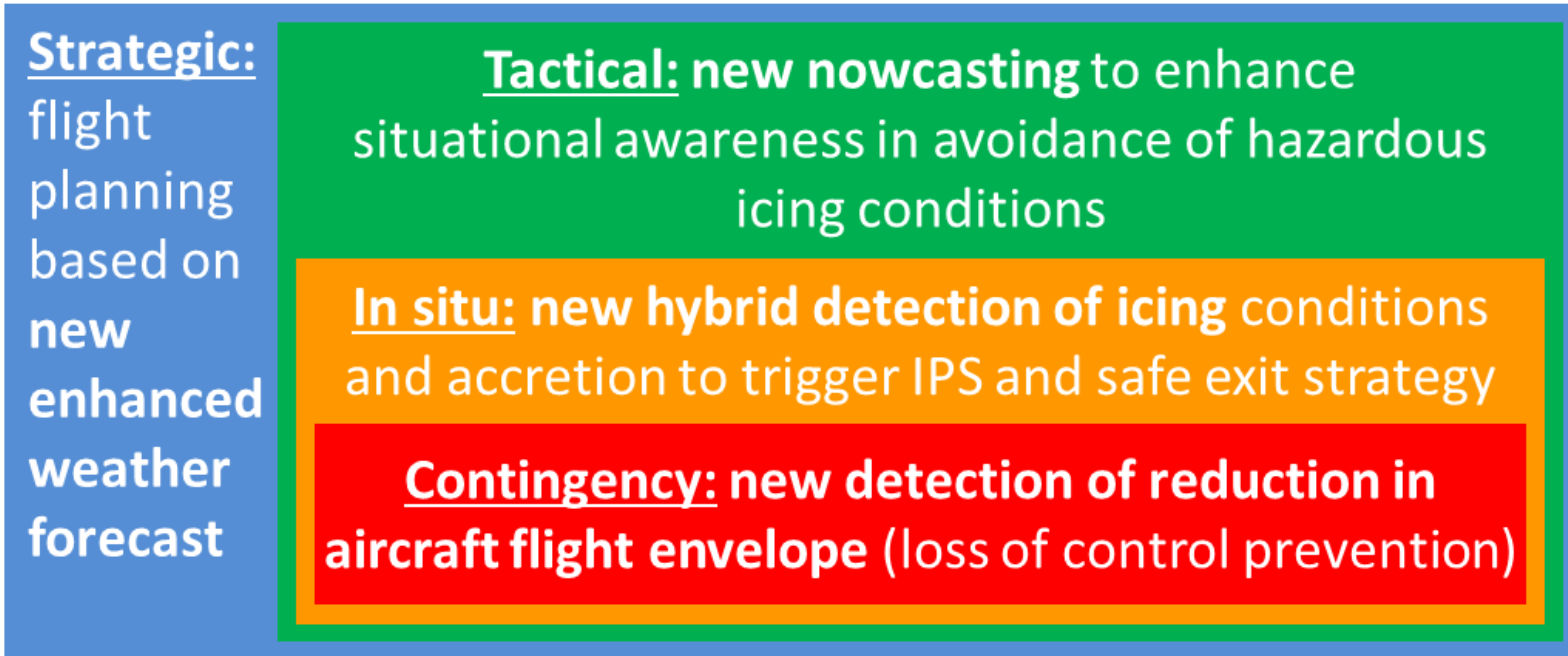

- Significant safety improvements provided by the SENS4ICE ice detection architecture especially for SLD icing conditions
- Enabler for more targeted use of energy-consuming anti-ice systems

Hybrid Ice Detection System



Credit: Embraer

Direct Sensors: focus on the environment

- Median volume diameter (MVD)
- Liquid water content (LWC)
- Air temperature
- Ice accretion rate (IAR)

Indirect System: focus on aircraft characteristics

- Engine parameters
- Aerodynamic parameters
- Inertial data
- Aircraft configuration, ...



- The mix of different informations in the hybrid approach creates additional value in terms of **reliability and accuracy**

SENS4ICE Sensor Technologies for Direct Sensing of Atmospheric Icing Conditions or Ice Accretion Detection (1)



Copyrights: © Honeywell

Honeywell: Short Range Particulate (SRP)



Copyrights: © Collins Aerospace

Collins Aerospace: Collins Ice Detection System (IDS)

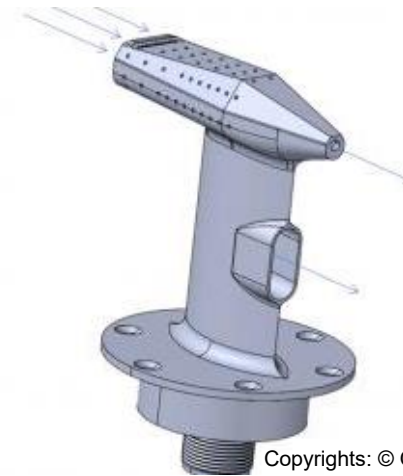

Copyrights: © ONERA

French Aerospace Lab (ONERA): Atmospheric Hydrometeor Detector based on Electrostatics (AHDEL)

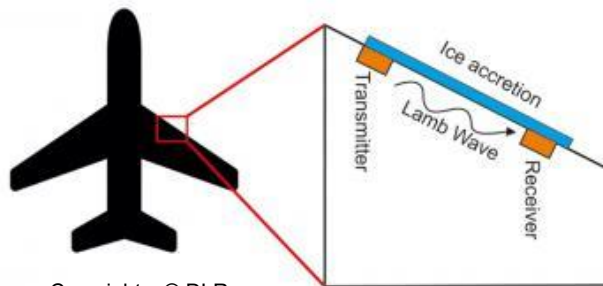

Copyrights: © DLR

DLR: Local Ice Layer Detector (LILD)



Copyrights: © ONERA

French Aerospace Lab (ONERA): AMPERA

This project has received funding from the European Union's Horizon 2020 research and innovation programme under grant agreement No 824253.

SENS4ICE Sensor Technologies for Direct Sensing of Atmospheric Icing Conditions or Ice Accretion Detection (2)



SAFRAN: Appendix O Discriminator (AOD)

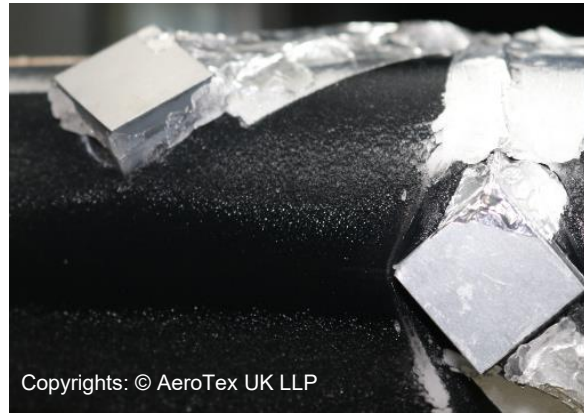

AeroTex UK: Atmospheric Icing Patch (AIP)



INTA: Fiber Optic Bragg (FOD)



SAFRAN: Primary in-Flight Icing Detection System (PFIDS)

DLR: Nevzorov Probe and Backscatter Cloud Probe with Polarization Detection (BCPD)

https://www.sens4ice-project.eu/sites/sens4ice/files/media/2021-11/SENS4ICE_SAE%20AC-9C%20Meeting_AIP-Atmospheric%20Icing%20Patches_ATX_October%202021.1.pdf
<https://zenodo.org/record/5521011#.YVQqR32xWUk>

Indirect Ice Detection System (IIDS) in SENS4ICE

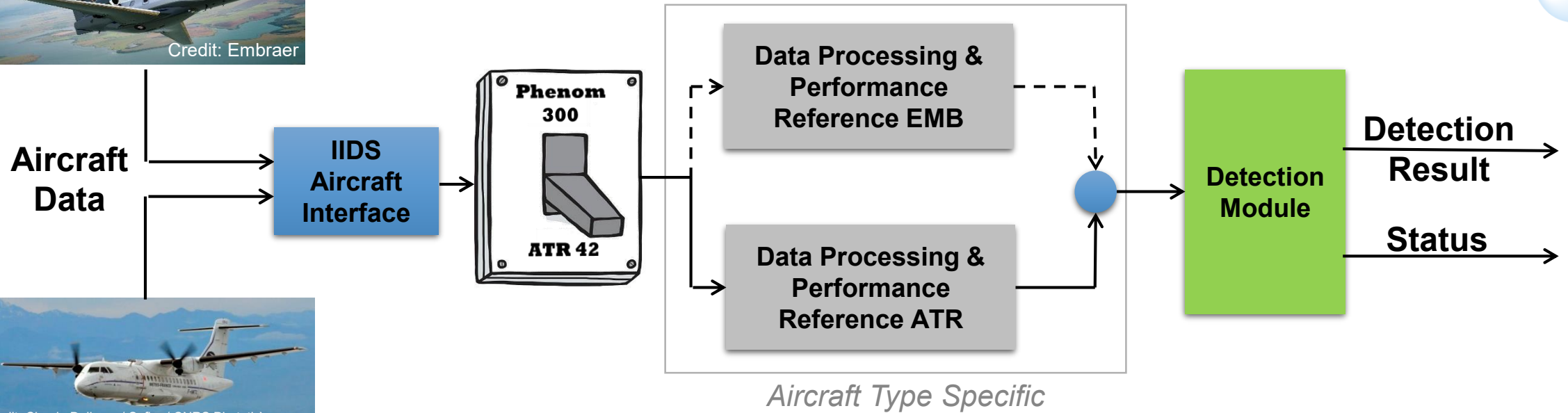

- Designed to easily cope with specific aircraft requirements and characteristics, e.g., configuration, propulsion system, avionics, operational requirements
- Retrofittable and high potential for smaller aircraft

IIDS System Performance Requirements: Conflicting Demands

Response Time

- early detection of abnormal aircraft characteristics
- early activation of countermeasures
- alert prior to any hazardous effects



Accuracy & Reliability

- false alarm prevention
- high reliability of detection
- situational awareness increase
- base for automatic system response

- System design based on ice accretion effects on performance: continuous change without high-frequency changes
- Appropriate filtering and threshold definition representing a balanced compromise

Example of IIDS Validation Results (App. C Flight Test Data)

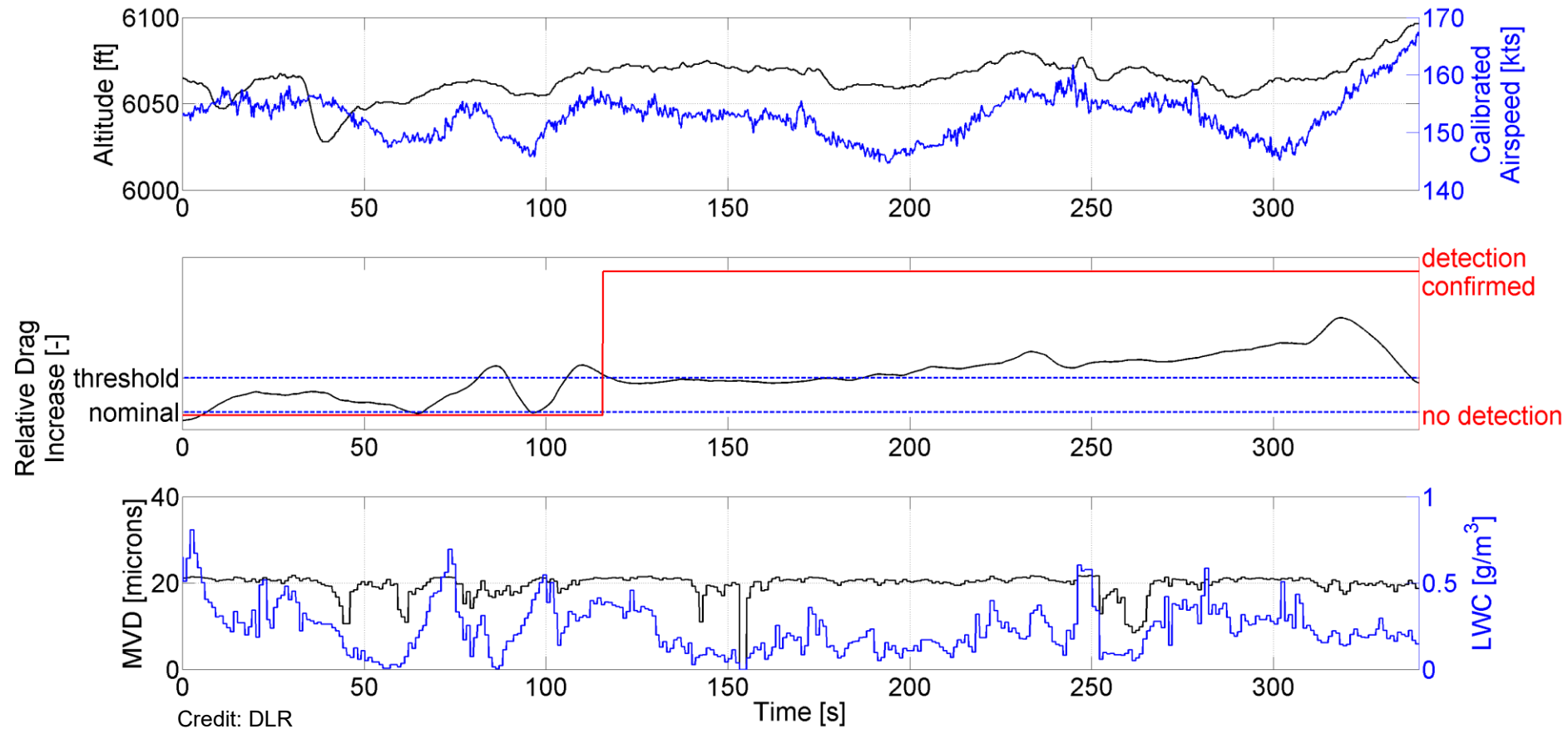

- Indirect ice detection results based on pre-existing natural icing flight test data exhibiting relative drag increase above detection threshold [Embraer flight test data]

Further Novel Research Applications: Small Aerial Vehicle Configurations



- Different requirements for small aerial vehicles than for large transport aircraft
- Complex sensor technologies or protection measures not applicable (e.g., weight, size, energy consumption)
- Shift of impact severity: weight increase, propeller icing, vehicle dynamics
- Icing management highly important for long endurance missions of smaller vehicles in harsh environments, e.g. search, surveillance, or urgent medication delivery in remote locations

- New field for icing research
- Tailoring of application of icing detection technologies and countermeasures for UAV

Summary



- Icing hazard to aviation generally under control
- SLD icing conditions very rare but dangerous and create new challenges for aircraft certification
- New specific needs for reliable ice detection
- Challenges for ice management on new aircraft configuration like smaller size UAVs



Topic: Facing the Challenges of Aircraft Icing

Date: 20.10.2022

Series: Hamburg Aerospace Lectures

Autor: Christoph Deiler (christoph.deiler@dlr.de)

Institute: Institute of Flight Systems

Credits:

BFU, (Interim) Report BFU CX001-13; NASA (GRC); FAA (FAA-H-8083-31A); SAFIRE (SENS4ICE Project); Embraer; Claude Delhayé / Safire / CNRS Photothèque; ATR72 (CC BY-SA 3.0, https://commons.wikimedia.org/wiki/File:American_Eagle_ATR-72_at_Joplin_Regional_Airport.JPG), Propeller Ice (public Domain, <https://commons.wikimedia.org/wiki/File:Isbildning.JPG>), Engine Ice (CC BY-SA 4.0, Olivier Cleynen, [https://commons.wikimedia.org/wiki/File:Icing_on_the_inlet_of_a_CFM56_turbofan_engine_\(2\).jpg](https://commons.wikimedia.org/wiki/File:Icing_on_the_inlet_of_a_CFM56_turbofan_engine_(2).jpg), Zoom), Ground De-Icing (public domain, Sgt. Steve Cortez, U.S. military, Department of Defense, https://commons.wikimedia.org/wiki/File:A_U.S._Army_C-37B_aircraft_transporting_Army_Chief_of_Staff_Gen._Raymond_T._Odierno,_gets_de-iced_before_it_departs_Joint_Base_Elmendorf-Richardson,_Alaska.jpg), B777 weather radar (Felix Gottwald, private photo with dedicated permission to use), Ice Detector B787 (CC BY 4.0, Julian Herzog, https://commons.wikimedia.org/wiki/File:Qatar_Airways_Boeing_787_Dreamliner_A7-BCD_PAS_2013_03_ice_detector.jpg), SESN4ICE Ice Detection Technologies (copyrights by Honeywell, Collins Aerospace, ONERA, AeroTex UK, SAFRAN, INTA and DLR)

remaining pictures „DLR (CC BY-NC-ND 3.0)“