



Multidisciplinary Design and Optimization of Regional Jet Retrofitting Activity

M. Mandorino¹, P. Della Vecchia², S. Corcione³, F. Nicolosi⁴ and V. Trifari⁵

University di Napoli Federico II, Naples, 80125, Italy

G. Cerino⁶

Leonardo Aircraft Division, Pomigliano D'Arco (NA), Italy

M. Fioriti⁷ and C. Cabaleiro⁸

Politecnico di Torino, Turin, Italy

T. Lefebvre⁹

ONERA/DTIS, Université de Toulouse, Toulouse, France

D. Charbonnier¹⁰

CFS Engineering SA, Lausanne, Switzerland

Z. Wang¹¹ and D.M.J. Peeters¹²

Delft University of Technology, Delft, 2629 HS, The Netherlands

A retrofit analysis on a 90 passengers regional jet aircraft is performed through a multidisciplinary collaborative aircraft design and optimization highlighting the impact on costs and performance. Two different activities are accounted for selecting the best aircraft retrofit solution: a re-engining operation that allows to substitute a conventional power-plant platform with advanced geared turbofan and an on-board-systems architecture modernization, considering different levels of electrification. Besides the variables that are directly dependent from these activities, also scenario variables are considered during the optimization such as the fuel price, the fleet size and the years of utilization of the upgraded systems. The optimization is led by impacts of the retrofitting process on emissions, capital

¹ PhD student, Department of Industrial Engineering, massimo.mandorino@unina.it

² Assistant Professor, Department of Industrial Engineering, AIAA regular member, pierluigi.dellavecchia@unina.it

³ Assistant Professor, Department of Industrial Engineering, salvatore.corcione@unina.it

⁴ Associate Professor, Department of Industrial Engineering, AIAA regular member, fabrizio.nicolosi@unina.it

⁵ Post-doc, Department of Industrial Engineering, vittorio.trifari@unina.it

⁶ Engineer, giovanni.cerino@leonardocompany.com

⁷ Assistant Professor, Department of Mechanical and Aerospace Engineering, AIAA Member, marco.fioriti@polito.it

⁸ PhD student, Department of Mechanical and Aerospace Engineering, carlos.cabaleiro@polito.it

⁹ Research Scientist, ONERA/DTIS, Université de Toulouse, Thierry.Lefebvre@onera.fr

¹⁰ Engineer, dominique.charbonnier@cfse.ch

¹¹ Post-doc, Aerospace Structures and Computational Mechanics, Z.Wang-16@tudelft.nl

¹² Assistant Professor, Aerospace Structures and Computational Mechanics, AIAA regular member, D.M.J.Peeters@tudelft.nl

costs and saving costs, computed at industrial level. Overall aircraft design competences (aerodynamics, masses, performance, noise, and emissions) have been computed increasing the level of fidelity and reliability. The whole process is implemented in the framework of the AGILE 4.0 research project in a collaborative remote multidisciplinary approach. Results show that the engine retrofitting can be a profitable solution for both manufacturers and airlines. Conversely, the on-board-system electrification seems to be not convenient in a retrofitting process due to the high capital costs. Depending on the operative scenario, involved stakeholders can properly orient their decision on a retrofitting strategy.

I. Nomenclature

AC	=	Application Case
AEA	=	All Electric Aircraft
BPR	=	By-Pass Ratio
CAS	=	Calibrated Air Speed
CEI	=	Cumulative Emission Index
CFD	=	Computational Fluid Dynamics
DOE	=	Design of Experiment
FL	=	Flight Level
LFL	=	Landing Field Length
MDAO	=	Multidisciplinary Design Analysis and Optimization
MEA	=	More Electric Aircraft
MTOW	=	Maximum Take-Off Weight
MOEW	=	Maximum Operating Empty Weight
OBS	=	On-Board System
OEM	=	Original Equipment Manufacturer
RSM	=	Response Surface Model
SAR	=	Specific Air Range
T_0	=	Take-off maximum thrust
TOFL	=	Take-off Field Length
XDSM	=	Extended Design Structure Matrix

II. Introduction

The aeronautical industry is continuously in search of innovative solutions to face the challenge arisen by new government regulations, competitors, constraints, and customer needs. An example can be represented by the founding of government-funded programs which aim to reduce the air transport environmental impact also seeking to improve passengers' satisfaction, cost efficiency, safety, and security [1]. Usually, these targets must be achieved with deadlines that are tight with respect to typical aircraft renovation. Indeed, for almost all aircraft categories, the characteristic range of time required to introduce a new product in the market is approximately 20 years. For instance, considering the 151-210 passengers' group, the last aircraft model release occurred in 2016 (A321neo), a renovation with respect to this seat category is expected in 15 or 20 years [2]. Under this condition, an airline company will operate for many years with the same aircraft model without the possibility to enhance its performance. This is the reason why during the last decades, solutions such as aircraft retrofit or the upgrade of some components, has been spreading along aircraft manufacturers: market potential for retrofitting activity have continuously grown, generating different opportunities. As a matter of fact, the most significant OEMs such as Embraer, Airbus and Boeing opted for retrofit or model upgrade solution for what concerns the E2-Family, the A320Neo and the 737MAX deliveries, spending around 6 years to accomplish design, manufacturing, and certification phases before starting the deliveries [3]. RETROFIT project [4] and IATA Aircraft Technology Roadmap [2] provide lists of the most attractive retrofitting activities available nowadays and in the following years, ranging from engine, aerodynamic, avionics and so on. The overall analysis presented in this paper are performed in the framework of the AGILE4.0 research project [5], where collaborative multidisciplinary aircraft design and optimization are carried out involving not-only the aircraft design domain (typically considered during the conceptual aircraft design) but also industrial domains, such as manufacturing, supply chain, maintenance, and certification. This kind of approach allows to optimally exploit both industrial experts' knowledge and AGILE 4.0 technologies, employed as "means of compliance" to demonstrate the

impact of a complex retrofitting process on a regional jet platform. The paper structure is the following: in section III the multidisciplinary analysis workflow (MDAO) is presented, introducing the reference aircraft and the retrofitting activity. Then, the main collaborative workflow with the related disciplinary competences are introduced. In section IV results are discussed: the problem statement, the trade-off analysis on multiple scenarios and finally constrained surrogate-based multi-objective optimization results are presented. Finally, the conclusions are presented.

III. Collaborative MDAO definition

A. Scenario and reference aircraft

The reference aircraft is a 90 passengers' regional-jet with a design range of 1890 nm, whose main characteristics are summarized in Table 1. The aircraft is comparable to the Embraer E-175, equipped with two turbofan engines like the CF34-8E¹ and conventional On-Board Systems (OBS). Two retrofitting packages are applied to the reference aircraft (see Figure 1).

- Engine upgrade. Installation of a high BPR geared turbofan engine with improved performance in terms of fuel consumption, noise, emissions, and maintenance. The new engines, designed within the AGILE 4.0 project, have an advanced architecture (like Pratt & Whitney PW1000G series) and a BPR between 9 and 15.
- OBS architecture electrification. More electric and all electric (MEA/AEA) configuration are considered, resulting in hydraulic and pneumatic system removal. This activity will lead to an improvement in weight, fuel efficiency, maintenance, and costs.



Figure 1: AGILE 4.0 AC 6 Aircraft, Engines and OBS highlighted

Table 1: AGILE 4.0 AC6 Aircraft main characteristics

Aircraft	Characteristics
Wing Area	81.40 m ²
Wingspan	27.19 m
Design Mission	1890nm + 100nm + 5% reserve
Typical Mission	720 nm
MTOW	39058.50 kg
MOEW	23444.70 kg
Payload mass	9180.00 kg
Fuel mass*	6433.80 kg
Engine BPR	5.4
T ₀	78200 N
OBS	Conventional
Cruise (FL360)	M = 0.78
Climb CAS	113.2 m/s
Descent CAS	128.6 m/s
TOFL (ISA, s.l, MTOW)	1500 m
LFL (ISA, s.l, MTOW)	1400 m

*Design Mission

¹ <https://www.geaviation.com/sites/default/files/datasheet-CF34-8E.pdf>, General Electric CF34-8E, accessed 16/06/2021

The retrofit of existing heritage fleets may depend on operative scenarios. In the present context, two examples of scenarios are considered: scenario 1, where more restrictive and severe regulations may occur and scenario 2, where an increment of fuel price can happen. For both scenarios the sequence of events, driven by the scenario itself, starts from the airliner's need to retrofit its fleet. The complexity of scenario involves different stakeholders (airliner, OEM, suppliers, certification authority, passengers), and at least three systems (the aircraft as whole, the engine and the OBS architecture). The airliner will refer to the aircraft OEM to reduce emissions, improving fuel consumption without costs penalty. The investment in retrofitting must be carefully evaluated, considering acquisition costs for equipment (engines and OBS) but also engineering costs, certification, and maintenance. In addition, the profitability of airlines and OEM should be guaranteed. The retrofitting operations are mainly carried out by OEM and its suppliers. Once retrofitted, the aircraft can be reentered in service only after the necessary certification process. The benefits should be appreciated from operators (the airlines) as well as by passengers and society in terms of comfort and reduced emissions.

B. Multidisciplinary workflow

The impact of a retrofitting activity on performance and costs is accounted through the wide range of disciplinary competences as shown in Figure 2 XDSM diagram. The tools executed in the workflow are here explained. To save computational time and guarantee higher level of fidelity, several competences are integrated as surrogate models.

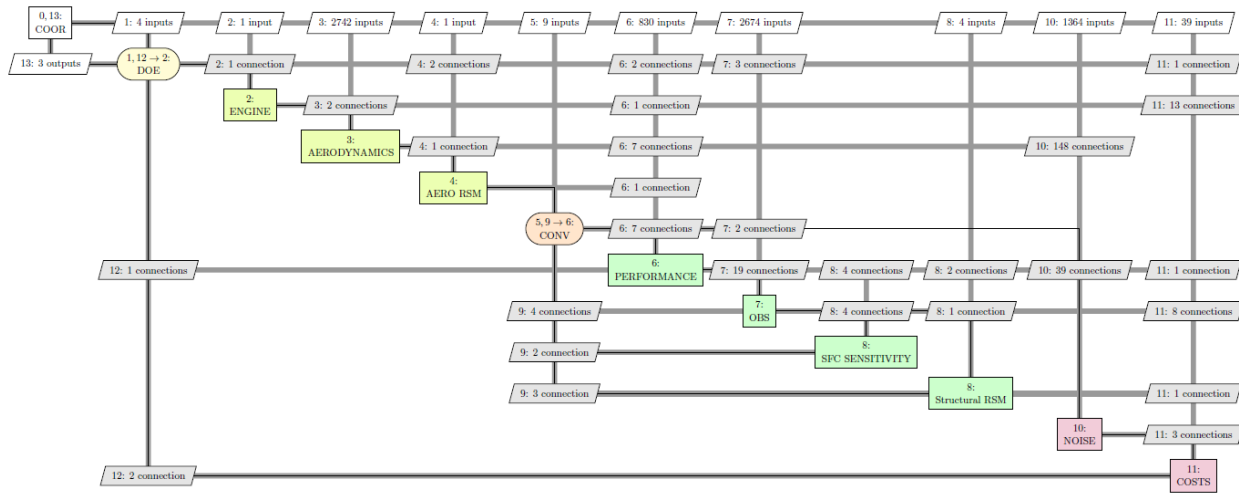

Figure 2: XDSM diagram: converged DOE

1. Engine.

The engine module is a surrogate-based tool. The main input of this tool is the engine BPR. From that, it provides the main engine characteristics such as: i) Thrust and Fuel Flow as function of Mach number, altitude, ratings for five different mission phases; ii) engine and pylon masses; iii) nacelle dimensions iv) engine list price; v) engine noise deck, expressed as 1/3 octave band in a polar arc. The engine performance data are based on GASTurb 11² engine modeler, from which 4 different engine BPR (5.4, 9, 12, 15) are generated with the same top-level engine requirements; the engine acquisition price and noise deck are based on semiempirical and statistical correlations.

2. Aerodynamics and Aero RSM.

The aerodynamic branch compute calculations for both low-speed and high-speed conditions. The main outputs are the drag polar for different flight conditions (take-off, climb, cruise, landing), the lift coefficient trend, also in stall condition, and the pitching moment coefficients. The tool account also for engine geometry and position, received as input. In this manner, the aerodynamic impact of different engine BPR and location is considered. A RSM has been developed to account for high fidelity results in high-speed condition, CFD analysis have been computed in cruise condition for different engine position with engine on and off, to account for both pylon and installed engine effect on drag coefficient, for the wing-body configuration (as shown in Figure 3). The RSM relies on a database of 90 points obtained thanks to a Latin Hypercube Sampling (LHS) approach. Figure 4 presents the results of a validation test, comparing the predictions of the RSM for CL and CD with validation database computed at BPR = 12 and nominal

² <https://www.gasturb.de/> GasTurb, accessed 22/04/2022

nacelle location. In the targeted range of CL, around 0.45, the predicted values are in line with the computations. The remaining tool capabilities are based on semiempirical approaches. High-fidelity results have been validated through [6].

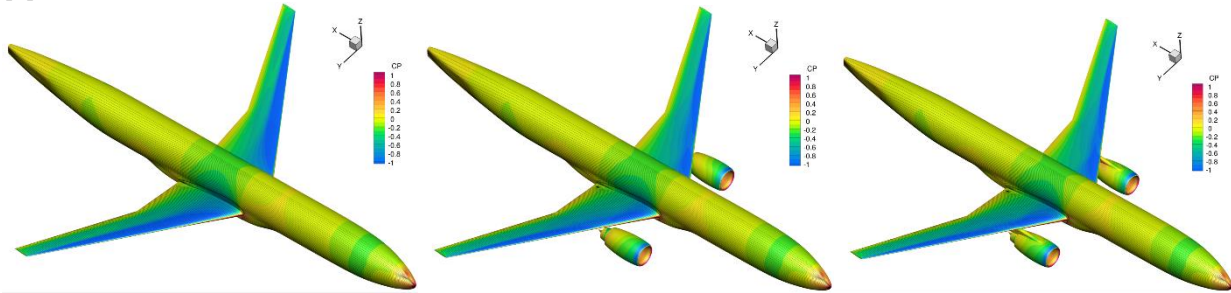

Figure 3: RANS CFD analyses, Cruise condition

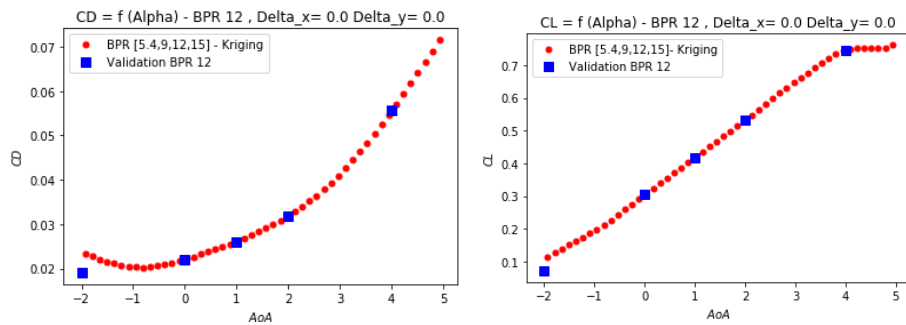

Figure 4: RSM validation – BPR 12

3. On-board-system and SFC sensitivity.

The OBS discipline named *ASTRID* [7] sizes the overall on-board-system. It is based on semiempirical and physics-based models. Starting from the typical loads for the OBS such as hinge moments, hot/cold air required, avionics functions, and others, the single user subsystem has been designed. Then, considering the loads coming from the user subsystems and any possible synergies, the power supply systems (i.e. hydraulic, pneumatic and electric power and distribution systems) have been defined. The design process is showed in Figure 5.

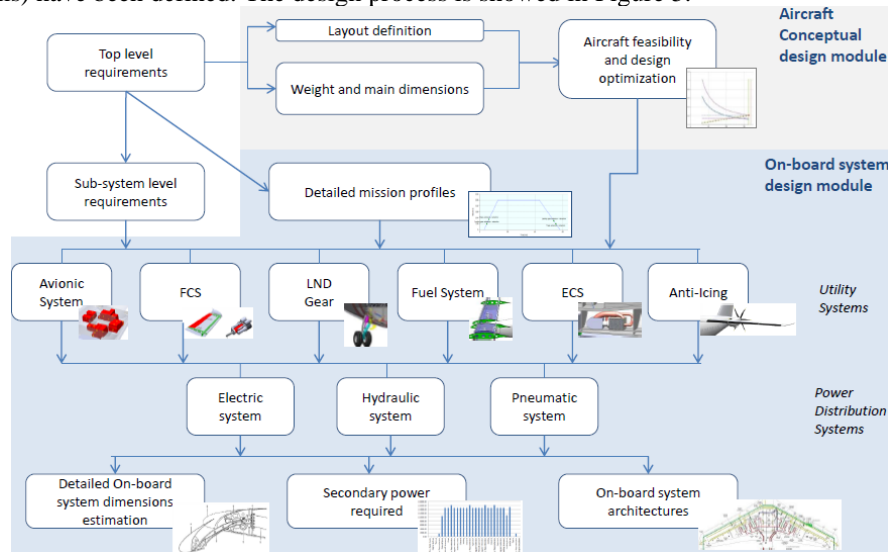

Figure 5: ASTRID OBS design process [7]

ASTRID is sensible to systems architecture and technologies used. Four different OBS architectures have been modelled, named: i) C (conventional) ii) MEA1 (more electric aircraft 1) iii) MEA2 (more electric aircraft 2) and iv) AEA (all electric aircraft). A description of these architectures can be found in [8] and [9]. The tool provides the masses and the hydraulic, pneumatic, and electric power required by each system during the different phases of the mission profile. It also computes the secondary power computation (power-off-takes) in order to account for their impact on engine fuel flow. The OBS power-off-takes are taken into account in the SFC sensitivity tool. The tool is based on different engine decks for different engine categories. SFC sensitivity tool is capable of differentiate the effect on engine SFC when due to mechanical off-takes or bleed air requirements. In this way, the tool rightly account for the conventional and electrified OBS architectures and their different effect on engine SFC.

4. Performance & Mission.

This tool computes ground and in-flight performance using a simulation-based approach. The overall mission profile, performance, fuel consumption, flight time and gaseous emissions are computed. The discipline receives as input engine thrust and fuel flow as function of Mach number, altitude, and ratings to compute the mission performance [10] [11].

5. Structural RSM.

The structural competence is based on a surrogate model based on a DOE high-fidelity structural analyses. Indeed, engine replacement may lead to a modification of fuel stored in the wing, and so the necessity to reinforce the wing structure. The wing structural weight is computed by PROTEUS, a tool developed by Delft University of Technology [12]. This tool allows the wing structural mass minimization using aeroelastic tailoring. The wing skins and spars are divided into 10 spanwise sections, of which each spanwise section of skins is further split into 2 chordwise sections. This results in a total of 60 design sections and 540 design variables. For design constraints, the aeroelastic instability, angle-of-attack, strength failure, buckling loads and laminate feasibility are considered during the optimization. The load case considers only the static load corresponding to a cruise flight condition at maximum load factor. The wing structural model is the same for all the DOE points, as that shown in Figure 6. A RSM has been developed to reduce the workflow computational time. The RSM relies on a database of 56 points obtained thanks to a Latin Hypercube Sampling (LHS) approach. This tool minimizes the wing mass by tuning lamination parameters and thicknesses while making sure aeroelastic stability, angle-of-attack, strength, and buckling constraints are satisfied.

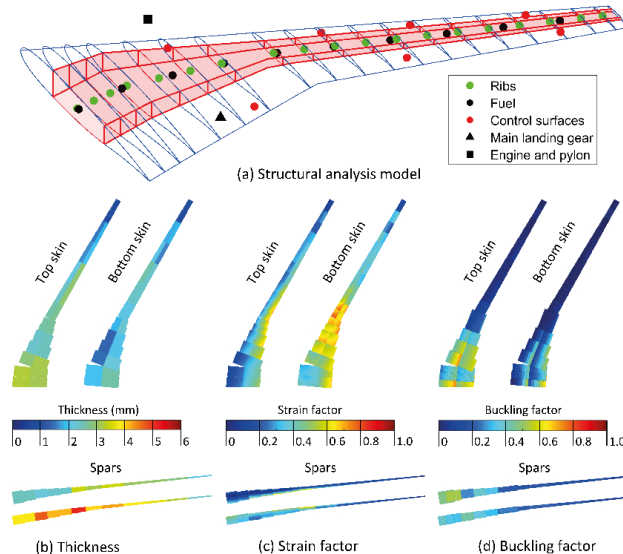

Figure 6: PROTEUS wing analysis model and an example of wing sizing result

6. Noise.

The noise competence computes the emission of noise at the certification points accordingly to the FAR36 and ICAO Annex 16 [13, 14]. It also provides the noise margin from the certification limits. Moreover, the tool is also capable to generate a noise footprint for landing and take-off on a georeferenced map, accordingly to a selected airport. The method is based on a semiempirical approaches based on ESDU methodology (see also [15]).

7. Costs.

Through the cost's competence, recurring and not recurring costs, the aircraft price and the direct operative costs are evaluated. The tool is based on semiempirical approaches proposed by Kimoto et al. [16] and Association of European Airlines method [17]. Moreover, an additional methodology has been developed to estimate development, operation

and equipment costs associated to a retrofitting activity. Also, the savings costs (part of direct operating costs) coming from fuel consumption reduction, maintenance costs and emission taxes are computed. The approach can be considered as a quantitative bottom-up method which needs of high-level of knowledge coming from industrial experience. Selecting a retrofitting package, all the activities and associated costs and revenues are computed. The executable workflow is shown in . The collaborative remote execution is enabled by leveraging on technologies used in the AGILE4.0 project as RCE [18] and BRICS [19]. CPACS is used as the common language to describe the system under analysis and facilitates data exchange [20]. Disciplinary competences are locally executed, and results automatically exchanged among distributed teams of expert. The time needed for single aircraft converged points is about 15 minutes. A DOE of 108 points was run for a total of 27 hours.

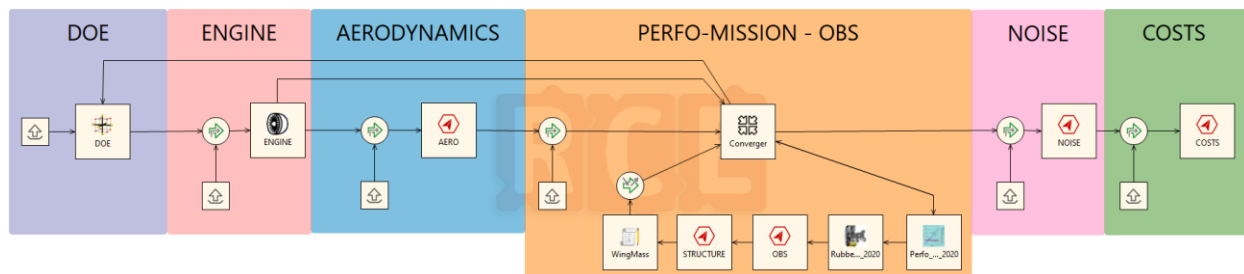

Figure 7: Executable workflow: converged DOE

IV. Optimization problem statement and results

To reduce the optimization computational time, surrogate based constrained optimizations have been performed based on the DOE results obtained through the executable workflow previously described in Sec. III. In this section the optimization problems set-up, the scenarios evaluation and main results are explained. Firstly, the DOE results are introduced according to two different operative scenarios. Finally, two different optimizations (with 2 and 4 objectives) are presented.

A. Variables, objective and constraints

The main optimization variables selected have been already presented in Sec. II, the Engine BPR and the OBS architecture. These variables mostly affect the aircraft performance in the present retrofitting process. The fuel consumption, the aerodynamic characteristics, the aircraft weights, the gaseous and noise emissions and the costs are all influenced by these two variables. Since the engine weight and size varies with the BPR, the original engine position could not fit the best aerodynamic, balance and clearance performance. For this reason, other two variables, the X and Z location of the engine have been introduced, as shown in Figure 8. The engine displacement along the wingspan (Y location) and engine tilt angle have been not considered as further variables.

In a retrofitting process other variables may depend on the operative scenario in which the aircraft retrofitting activity happens: *a)* the first one is the fleet size to be retrofitted. Increasing the number of aircraft, the development costs, production costs and equipment costs of the OEM can be reduced, with a decrement of capital costs to be sustained by the airliners; *b)* In addition, an airliner can decide to retrofit its aircraft at different stage of their life. Increasing the time frame using an improved aircraft, decrease the operating costs; *c)* a third variable may be the fuel price: it is straightforward that increasing the fuel price, decreasing the operating costs; *d)* the airport taxes mainly related to noise and emissions depend on time and geography location. Increasing the taxes may significate decreasing the operating costs for retrofitted aircraft; *e)* finally, according to the engine and OBS suppliers, the retrofitted aircraft will require less maintenance costs. Due to the straightforward effects of these five items on capital costs and operating costs, they have been not directly considered as optimization problem variables, but they are rather considered as parameters: different scenarios can be assumed just varying each parameter, achieving different solutions.

To summarize, in Table 2 the list of the optimization variables is presented. For each variable, the category to which it belongs and the boundaries are indicated. Table 3 summarizes the optimization parameters described above. Figure 8 shows the X and Z nacelle positions, where the baseline coordinates are presented.

The solution of the aircraft upgrade must be acceptable and profitable for both the airliner and the manufacturer. The new platform must operate at least at the same airport than previously, without any raise in terms of taxes due to the aircraft weight. In addition, due to the increasing restrictions in regulation, the airliner will require a solution with a reduction in emissions. These airliner requirements are considered as a constraint for the optimization solution, compared to the baseline aircraft performance. In Table 4 the list of the optimization constraints is presented.

Table 2: Optimization variables

Variable	Type	Range
Engine BPR	Continuous	9 ÷ 15
X/Cloc Engine	Continuous	-0.98 ÷ -0.80
Z/Cloc Engine	Continuous	-0.39 ÷ -0.21
OBS architecture	Categorical	CONV, MEA1, MEA2, AEA

Table 3: Scenarios parameters

Parameter	Category	Range
Fleet dimensions	Continuous	100 ÷ 700
Fuel price	Continuous	50 ÷ 150 \$/barrel
Emissions taxes	Continuous	-
Maintenance Cost	Continuous	0 ÷ -25 %
Years of utilization after retrofiting	Continuous	0 ÷ Aircraft entire life

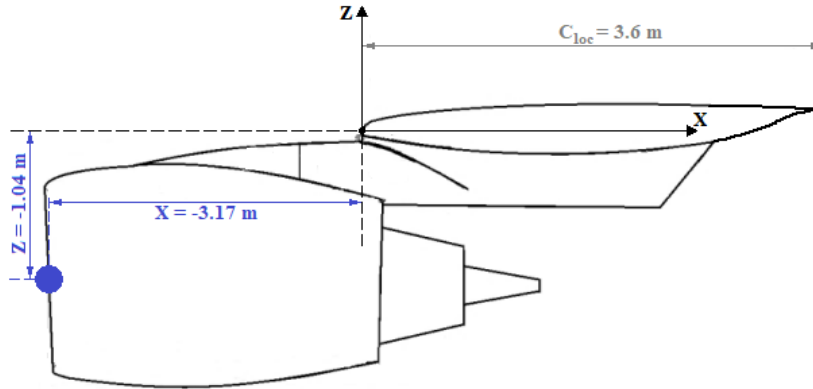
**Figure 8: X and Z axis and baseline position considered for engine attachment point****Table 4: Optimization constraints**

Constraints	Baseline value
WTO	≤ 39058.50 Kg
Landing distance	≤ 1400 m
Take-off distance	≤ 1500 m
Cumulative noise (ICAO Annex 16 – Ch 16)	≤ 269.6 – 6 EPNLdB

The objectives of the optimization problem can be defined with four different items, following explained.

8. Costs – Savings

This objective is composed by the difference between two economical items. The first one consists in capital costs sustained by the manufacturer to retrofit the aircraft. This item represents the sum of development, operations, and equipment costs that must be afforded to undertake the retrofiting activity. Certainly, these costs increase by considering a higher number or more expensive components to be upgraded. For these costs, a learning curve factor and an agreement between the aircraft OEM and the equipment's supplier is applied, depending on the number of aircraft to be retrofitted. The second item consists in *operative savings*. This item represents the sum of the savings due to fuel consumption, maintenance and emission taxes reduction achieved with respect to the baseline aircraft during typical aircraft mission. The operative savings are directly influenced by scenario considered and the aircraft performance.

9. Cumulative emission index (CEI)

This index represents the level of emissions in terms of air and noise. The index is built up as a weighted sum of three emissions, expressed in non-dimensional unit, as illustrated in eq. (1).

$$CEI = W_1 \frac{NOX + CO}{NOX_B + CO_B} + W_2 \frac{CO_2}{CO_{2B}} + W_3 \frac{CNoise}{CNoise_B} \quad (1)$$

NO_x, CO, and CO₂ represent respectively the amount of these pollutants generated during the entire typical mission. CNoise indicates the cumulative noise accordingly regulation [21]. The subscript “B” indicates the baseline aircraft, without any upgrade. Basically, this index provides the amount of emission. A CEI value equal to 1 means same emissions level of the baseline. Lower than one means emissions reduction. For the following results, all the weights have been assumed equal among them (W₁, W₂ and W₃ = 1/3).

10. Max SAR

This objective represents the maximum specific air range achievable in cruise condition and weight. It is computed for all possible cruise flight conditions. This item is representative of the aircraft performance in terms of flight efficiency and fuel consumption.

11. Maximum take-off weight

This objective represents the aircraft maximum take-off weight. It is computed through an iterative convergence process which involves the tool described in Sec. III. This item directly influences the aircraft performances and the airport taxes which must be afforded by the airline company.

B. DOE and scenario results

The results achieved executing the DOE workflow are presented in Figure 9 and Figure 10 for two different scenarios. They consist of 108 configurations, obtained combining the variables presented in Table 2 (engine BPR, OBS architecture and engine positions). Two different scenarios have been considered by modifying the parameters illustrated in Table 5. The first one represents a situation in which the fuel price is relatively low, and the innovation in terms of maintenance operations and aircraft total life are moderately increased. By consequence, a retrofitting activity is undertaken by an airline company most likely if its fleet is numerous. The second scenario represent a different situation, in which the price of the fuel is increased, and the renovation generated in terms of maintenance operations and aircraft total life are increased. In this case, a smaller fleet can be profitable. A summary of both scenarios is presented in Table 5.

The engine BPR and OBS architecture that define each solution have an influence on costs, savings, and emissions. Indeed, a higher BPR and OBS level of electrification lead to an increase in operations and equipment retrofitting costs. At the same time, this rise also brings to a significant reduction in maintenance costs and fuel consumption which means a reduction in emissions, taxes, and fuel expense. In addition, a higher engine BPR results into a fall in noise emission and taxes. However, an increasing level of OBS electrification leads to a reduction on development costs. Engine position affects the aircraft fuel consumption because of the difference in drag due to each configuration. This effect has an influence on air emissions and on savings.

As it is possible to see in Figure 9, in the first scenario the difference between retrofitting cost and saving is almost never negative, it means that the aircraft retrofitting is not economically remunerative. However, a great reduction in terms of noise and air emission can be achieved with all the OBS architecture considered. Of course, the higher the level of electrification is, the lower will be the emission index obtained.

In scenario number 2 the difference between retrofitting costs and savings becomes negative for a huge number of points, as shown in Figure 10. It means that in this case the aircraft upgrade is convenient in terms of both emission and economic benefits. In addition, the OBS electrification may become more and more convenient, due to both fuel consumption reduction and maintenance improvement.

Depending on the scenarios, the trade-off proposed is automatically modifiable and should be coupled with an OEM business to provide the optimal retrofitting strategy.

Table 5: Operative scenarios considered

Parameter	Scenario 1 Value	Scenario 2 Value
Fleet dimension	700	500
Fuel price ³	73 \$/barrel (June 2021)	100 \$/barrel (April 2022)
Emissions taxes ⁴	Frankfurt 2021-2022	Frankfurt 2021-2022
Maintenance Cost	-5% Engine, -10% Engine + OBS	-8% Engine, -12% Engine + OBS
Years of utilization after retrofitting	12 years	13 years

³ <https://www.iata.org/en/publications/economics/fuel-monitor/>, IATA Jet Fuel Price Monitor, accessed 22/04/2022

⁴ <https://www.fraport.com/en/business-areas/operations/airport-charges.html>, Frankfurt Airport Charges, accessed 22/04/2022

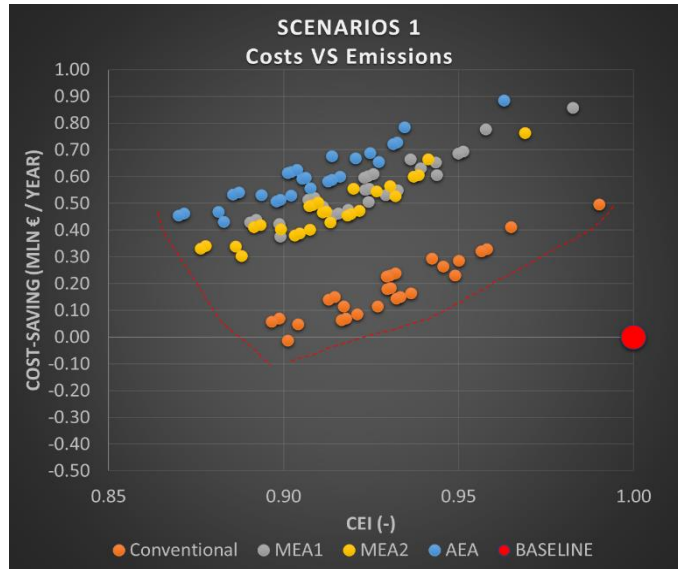

Figure 9: DOE workflow results. Scenario 1 (Table 5). 2506 flight per year and a manufacturer profit margin of 7% are considered

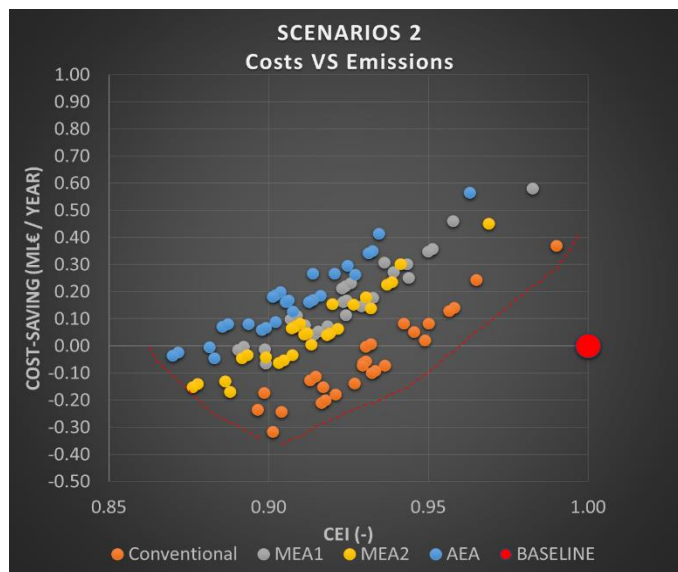

Figure 10: DOE workflow results. Scenario 2 (Table 5). 2506 flights per year and a manufacturer profit margin of 7% are considered

C. Optimization results

The optimization problem results here presented refer to scenario number 1 of Table 5. A surrogate-based constrained multi-objective optimization is performed, including several disciplines at different level of fidelity. This has been possible thanks to the RSM generated, which allowed to compute in a few seconds data that usually require hours of computations.

The optimization tool used has been the JPAD Optimizer based on MOEA Framework⁵, which is directly implemented in JPAD library [10] [22]. The MOEA Framework is a free and open-source Java library for developing and experimenting with multi-objective evolutionary algorithms (MOEAs) and other general-purpose optimization

⁵ <http://moeaframework.org/>, MOEA Framework, accessed 22/04/2022

algorithms. Several algorithms are provided out-of-the-box, including genetic algorithms, particle swarm etc. Here the ε -NSGAI algorithm is used. ε -NSGA-II is an extension of NSGA-II that uses an ε -dominance archive and randomized restart to enhance search and find a diverse set of Pareto optimal solutions. Full details of this algorithm are given in [23].

Table 6: Optimization problem definition; objectives, constraints and variables

	2 Objective Optimization		4 Objective Optimization	
Objective functions:	<i>Minimize:</i> $f_1 = \text{Costs} - \text{Savings}$ $f_2 = \text{MTOW}$	<i>Minimize:</i> $f_1 = \text{Costs} - \text{Savings}$ <i>Maximize:</i> $f_2 = \text{Max SAR}$	<i>Minimize:</i> $f_1 = \text{Costs} - \text{Savings}$ $f_2 = \text{CEI}$	<i>Minimize:</i> $f_1 = \text{Costs} - \text{Savings}$ $f_2 = \text{MTOW}$ $f_3 = \text{CEI}$ <i>Maximize:</i> $f_4 = \text{Max SAR}$
Constraints:	<i>w. r. t:</i> $\text{MTOW} \leq 39058.50 \text{ kg}$ $\text{TOFL} \leq 1500 \text{ m}$ $\text{LNFL} \leq 1400 \text{ m}$ $\text{Cumulative noise} \leq 263.6 \text{ dB}$			
Variables:	<i>by varying:</i> $9.0 < \text{BPR} < 15.0$ $-0.98 < X/C_{loc} < -0.80$ $-0.39 < Z/C_{loc} < -0.21$ $\text{OBS} \in [\text{CONVENTIONAL}, \text{MEA1}, \text{MEA2}, \text{AEA}]$			

Four different optimizations have been executed. The first three are bi-objective optimization: indeed, the difference between costs and savings has been considered as optimization objective in couple with all the remaining three objectives (MTOW, SAR and CEI). The fourth optimization concerns a multi-objective optimization which include all the mentioned objectives together. In Table 6 a summary of the four performed optimizations properties is illustrated. Figure 11, Figure 12 and Figure 13 show the corresponding results comparing DOE points, bi-objective and four-objective optimizations. As it is possible to see, the optimization algorithm always found a pareto front from which an optimum solution can be selected by the designer. For instance, the point with minimum difference between costs and savings is always an optimum point in terms of economical profit. However, it is not the best solution in terms of other variables. Indeed, to achieve a low value of the costs, several solutions which lead to significant benefits in terms of emission, SAR and weight may be discarded. The same happens for the points which allow to obtain the maximum benefits with respect to the other variables. Furthermore, the best points found by the bi-objective optimization almost always belongs to the ones found by the multi-objective optimization. This second set of points is wider because it represents a combination of optimum points of a higher number of variables (yellow x respect blue circle). Table 7 summarizes the main optimization results for the scenario 1 (Table 5), selecting two optimized points of the pareto fronts shown in Figure 11, Figure 12 and Figure 13. These points have been deliberately selected as opposite solutions. As it can be highlighted, the best longitudinal engine position is always the same ($X/C_{loc} = -0.8$), meaning that an engine X/C_{loc} position closer to the wing leading edge should be selected. Conversely the engine height position (Z/C_{loc}) assumes different best solution as function of engine BPR: as higher is the BPR, as lower should be the engine position respect to the wing leading edge. This is due to an aerodynamic effect related to the engine-pylon-wing interference. The engine BPR and the OBS architecture may be selected exactly in a opposite direction, depending on the performance objective to be maximized: BPR = 9.0 with conventional OBS and BPR = 15.0 with AEA OBS architecture. A lower BPR and level of electrification (i.e. state of the art technologies) allows to reduce the retrofitting costs, allowing a moderate performance improvements. By the contrast, increasing the level of retrofitting (advanced engine and overall OBS electrification, beyond the state of the art) can drastically improve the overall performance (i.e. SAR and CEI), increasing the retrofitting costs. As example, considering a higher BPR and level of electrification, emissions reduce (CEI passes from 1 to 0.78), MTOW slightly decreases (around -3.1% with respect to the baseline), and SAR increases (around + 25% with respect to the baseline). By the consequence costs minus savings increases up to 0.44 Mln € per year.

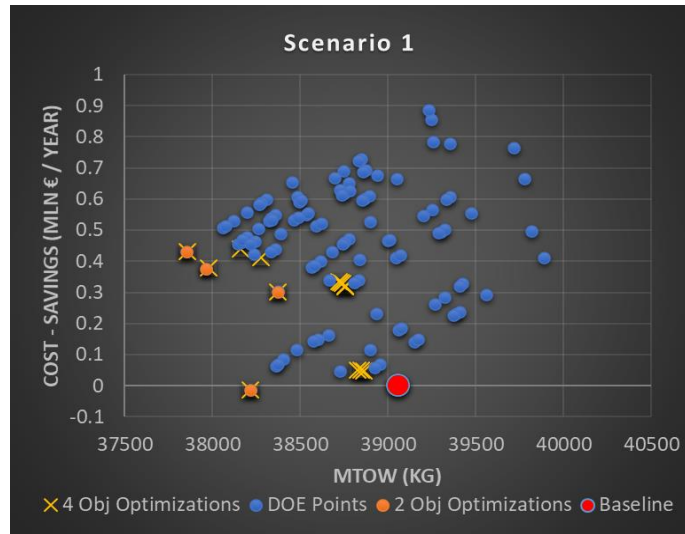

Figure 11: Optimization results: Cost-Savings Vs WTO, scenario 1 (Table 5). 2, 4 objectives and DOE points.

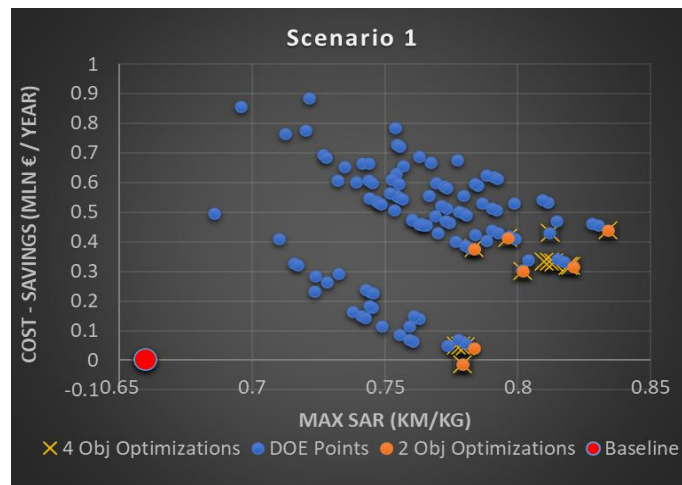

Figure 12: Optimization results: Cost-Savings Vs maximum SAR, scenario 1 (Table 5). 2, 4 objectives and DOE points.

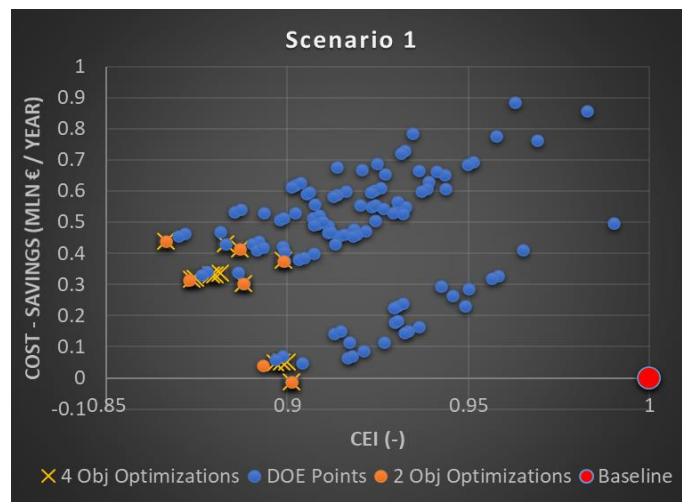

Figure 13: Optimization results: Cost-Savings Vs CEI, scenario 1 (Table 5). 2, 4 objectives and DOE points.

Table 7: Optimum point variables and objectives obtained, scenario 1 (Table 5). Points with opposite position in pareto fronts are indicated. The objective for which an optimum is reached in indicated in green. Objectives not included in the optimization are indicated in grey.

ID	Variables				Objectives			
	BPR	X/C _{loc}	Z/Cl _{loc}	OBS	WTO (Kg)	Max SAR (Km/Kg)	CEI (-)	Cost-Savings (Mln €/year)
<i>Baseline</i>	5.4	-0.88	-0.29	CONV	39058.50	0.66	1.00	0.00
2 Obj. Optimization Cost – Savings Vs WTO	9.0	-0.80	-0.29	AEA	37850.54	0.81	0.88	0.43
2 Obj. Optimization Cost – Savings Vs WTO (or Max SAR)	9.0	-0.80	-0.29	CONV	38214.38	0.78	0.90	-0.014
2 Obj. Optimization Cost – Savings Vs Max SAR	15.0	-0.80	-0.33	AEA	38187.00	0.83	0.87	0.44
2 Obj. Optimization Cost – Savings Vs Max CEI	9.0	-0.80	-0.29	CONV	38214.38	0.78	0.90	-0.014
2 Obj. Optimization Cost – Savings Vs Max CEI	15.0	-0.80	-0.33	AEA	38186.15	0.83	0.87	0.44
4 Obj. Optimization	9.0	-0.80	-0.29	AEA	37850.54	0.81	0.88	0.43
4 Obj. Optimization	13.42	-0.80	-0.31	CONV	38828.41	0.78	0.90	0.05
4 Obj. Optimization	9.0	-0.80	-0.29	CONV	38214.38	0.78	0.90	-0.014
4 Obj. Optimization	15.0	-0.80	-0.33	AEA	38187.00	0.83	0.87	0.44
4 Obj. Optimization	9.0	-0.80	-0.29	CONV	38214.38	0.78	0.90	-0.014
4 Obj. Optimization	15.0	-0.80	-0.33	AEA	38186.15	0.83	0.87	0.44

V. Conclusion

The AGILE 4.0 technologies have been applied to define the retrofitting strategy of 90 passengers' regional jet aircraft. Multiple system layers (the aircraft, the engine and the OBS architecture) have been considered, evaluating the impact of retrofitting on performance and costs at industrial level. Depending on the scenario considered, the stakeholders may coherently select the best retrofitting strategy.

Considering a conservative scenario, with a fuel price of 73US\$ per barrel, more than 700 aircraft should be retrofitted with only an engine replacement to provide a profitable machine for the airliner (without the OBS electrification). Conversely, considering a fuel price increment (i.e. 100US\$/barrel), may become convenient to retrofit also the OBS, shifting the breakeven points (costs – savings lower than zero) to a reduced number of retrofitted aircraft, lower than 500. The proposed strategy can support a business model and the decision-making phase to properly select the best retrofitting strategy. Depending on the contingent scenario, the optimization process has been set-up, highlighting the optimized solution. Again, in a conservative scenario (low fuel price, low maintenance improvement and nowadays airport taxes), the optimized solution is to retrofit only the engine adopting a BPR not higher than 9, properly selecting the engine position. Conversely, in a scenario with higher fuel price, higher maintenance improvement and/or airport taxes increment, may be convenient to increase the engine BPR higher than 13, with also OBS electrification.

The retrofitting strategy strongly depend on the scenario where the action is undertaken by OEM and Airlines.

Acknowledgments

The research presented in this paper has been performed in the framework of the AGILE 4.0 project (Towards Cyber-physical Collaborative Aircraft Development) and has received funding from the European Union Horizon 2020 Programme under grant agreement n° 815122.

References

- [1] "Strategic Research Innovation Agenda," ACARE Advisory Council for Aviation Research and Innovation in Europe, 2017.
- [2] "Aircraft Technology Roadmap to 2050," IATA International Air Transport Association , 2018.
- [3] "Embraer E-Jets E2 Building on Success," AirInsight, 2016.

- [4] E. Baalbergen, "D 2.5 - RETROFIT Report on Technology Inventory - Reduced Emissions of Transport aircraft Operations by Fleetwise Implementation of new Technology," 2011.
- [5] P. D. Ciampa, G. La Rocca and B. & Nagel, "A mbse approach to mdao systems for the development of complex products," *AIAA Aviation 2020 Forum*, p. 3150.
- [6] T. Stankowski, D. MacManus, M. Robinson and C. Sheaf, "Aerodynamic effects of propulsion integration for high bypass ratio engines," *Journal of Aircraft*, vol. 54, no. 6, pp. 2270-2284, 2017.
- [7] S. Chiesa, G. A. Di Meo, M. Fioriti, G. Medici and N. Viola, "ASTRID—aircraft on board systems sizing and trade-off analysis in initial design," in *Research and Education in Aircraft Design—READ 2012*, 2012.
- [8] P. Della Vecchia, L. Stingo, F. Nicolosi, A. De Marco, G. Cerino and P. D. e. a. Ciampa, "Advanced turboprop multidisciplinary design and optimization within agile project," in *2018 Aviation Technology, Integration, and Operations Conference*, 2018.
- [9] M. Fioriti, L. Boggero, P. S. Prakasha, A. Mirzoyan, B. Aigner and K. Anisimov, "Multidisciplinary aircraft integration within a collaborative and distributed design framework using the AGILE paradigm," *Progress in Aerospace Sciences*, vol. 119, p. 100648, 2020.
- [10] F. Nicolosi, A. De Marco, L. Attanasio and D. V. P., "Development of a Java-Based Framework for Aircraft Preliminary Design and Optimization," *Journal of Aerospace Information System*, vol. 13, p. 234–242, 2016,.
- [11] V. Trifari, "Development of a Multi-Disciplinary Analysis and Optimization framework and applications for innovative efficient regional aircraft," Phd, University of Naples Federico II, Department of Industrial Engineering, University of Naples Federico II, Naples, Italy., 2020.
- [12] N. P. M. Werter and R. De Breuker, "A novel dynamic aeroelastic framework for aeroelastic tailoring and structural optimisation," *Composite Structures*, pp. 369-386, 2016.
- [13] ICAO, "ICAO annex 16 —Environmental protection. Volume I—," *International Standards and Recommended Practices*, 2008.
- [14] FAR, "Part 36 - Noise Standards: Aircraft type and airworthiness certification," *US Government Printing Office*, 2005.
- [15] C. Casale, T. Polito, V. Trifari, M. Di Stasio, P. Della Vecchia, F. Nicolosi and F. & Marulo, "Implementation of a Noise Prediction Software for Civil Aircraft Applications," *Proceedings of the 25th International Congress of the Italian Association of Aeronautics and Astronautics (AIDAA)*, pp. 9-12, 2019.
- [16] M. N. Beltramo, D. L. Trapp, B. W. Kimoto and D. P. & Marsh, "Parametric study of transport aircraft systems cost and weight.," *Tech. Rep. NASA CR 151970, Science Application*, 1977.
- [17] AEA, "Short medium range aircraft: AEA requirements," *Association of European Airlines*, 1989.
- [18] P. D. Ciampa, E. Moerland, D. Seider, E. Baalbergen, R. Lombardi and R. D'Ippolito, "A collaborative architecture supporting AGILE design of complex aeronautics products," in *18th AIAA/ISSMO Multidisciplinary Analysis and Optimization Conference*, 2017.
- [19] E. Baalbergen, W. Lammen, N. Noskov, P. D. Ciampa and E. Moerland, "Integrated collaboration capabilities for competitive aircraft design," in *MATEC Web of Conferences*, 2018.
- [20] M. Alder, E. Moerland, J. Jepsen and B. Nagel, "Recent Advances in Establishing a Common Language for Aircraft Design with CPACS," in *Aerospace Europe Conference*, 2020.
- [21] "Environmental protection, volume i – aircraft noise, international standards," International Civil Aviation Organization, 2008.
- [22] V. Trifari, M. Ruocco, V. Cusati, F. Nicolosi and A. De Marco, "Java framework for parametric aircraft design - Ground performance," *Aircraft Engineering and Aerospace Technology*, vol. 89, no. 4, pp. 559-608, 2017.
- [23] J. B. Kollat and P. M. and Reed, "Comparison of Multi-Objective Evolutionary Algorithms for Long-Term Monitoring Design," *Advances in Water Resources*, vol. 29, no. 6, pp. 792-807, 2006.