



Multidisciplinary design of a more electric regional aircraft including certification constraints

M. Fioriti¹ and C. Cabaleiro.²
Politecnico di Torino, Turin, Italy

T. Lefebvre³
ONERA, Toulouse, France

P. Della Vecchia⁴ and M. Mandorino⁵
Università di Napoli Federico II, Naples, Italy

S. Liscouët-Hanke⁶ and A. Jeyaraj⁷
Concordia University, Montreal, Canada

G. Donelli⁸
DLR, Hamburg, Germany

A. Jungo⁹
CFSE, Lausanne, Switzerland

The use of electrified on-board systems is increasingly more required to reduce aircraft complexity, polluting emissions, and its life cycle cost. However, the more and all-electric aircraft configurations are still uncommon in the civil aviation context and their certifiability has yet to be proven in some aircraft segments. The aim of the present paper is to define a multidisciplinary design problem which includes some disciplines pertaining to the certification domain. In particular, the study is focused on the preliminary design of a 19 passengers small regional turboprop aircraft. Different on-board systems architectures with increasing electrification levels are considered. These architectures imply the use of bleedless technologies including electrified ice protection and environmental control systems. The use of electric actuators for secondary surfaces and landing gear are also considered. The aircraft

¹ Assistant Professor, Department of Mechanical and Aerospace Engineering, AIAA Member, marco.fioriti@polito.it

² PhD student, Department of Mechanical and Aerospace Engineering, carlos.cabaleiro@polito.it

³ Senior Researcher, MDO department, Thierry.Lefebvre@onera.fr

⁴ Assistant Professor, Department of Aerospace Engineering, pierluigi.dellavecchia@unina.it

⁵ PhD student, Department of Aerospace Engineering, massimo.mandorino@unina.it

⁶ Associate Professor, Department of Mechanical, Industrial and Aerospace Engineering, susan.liscouet-hanke@concordia.ca

⁷ Assistant Professor, Department of Aerospace Engineering, andrew.jeyaraj@mail.concordia.ca

⁸ Researcher, Aircraft Design & System Integration, Institute of System Architectures in Aeronautics, giuseppa.donelli@dlr.de

⁹ Researcher, Aerospace Department, aidan.jungo@cfse.ch

design, which includes aerodynamic, structural, systems and propulsion domains, is then assessed by some certification disciplines. In particular, minimum performance, external noise and safety assessments are included in the workflow giving some insights on the aircraft certifiability. The results show a reduction of 3% of MTOM and 3% of fuel mass depending on the systems architecture selected. From the certification side, the design has proven to be certifiable and the margins with the certification constraint can be controlled to improve the overall design.

I. Nomenclature

AC	=	Application Case
AEA	=	All Electric Aircraft
ASSESS	=	Aircraft System Safety Assessment (tool)
C	=	Generic Consumer Element
CPACS	=	Common Parametric Aircraft Configuration Schema
D	=	Generic Distribution Element
DOE	=	Design of Experiment
Dv	=	Generic Device Element
ECS	=	Environmental Control System
EHSA	=	Electrohydraulic Servo Actuator
EMA	=	Electromechanical Actuator
EPNL	=	Effective Perceived Noise Level
ESDU	=	Engineering Sciences Data Unit
FCS	=	Flight Control System
ICAO	=	International Civil Aviation Organization
IPS	=	Ice Protection System
MDA	=	Multidisciplinary Design Analysis
MDAO	=	Multidisciplinary Design Analysis and Optimization
MEA	=	More Electric Aircraft
MLM	=	Maximum Landing Mass
MTOM	=	Maximum Take Off Mass
OBS	=	On-Board Systems
S	=	Generic Source Element
TLARs	=	Top Level Aircraft Requirements
TOFL	=	Take Off Field Length

II. Introduction

The current trend of on-board systems electrification is justified by several benefits in different domains. The use of More Electric Aircraft (MEA) and All-Electric Aircraft (AEA) systems architectures should reduce the fuel burnt, the maintenance effort and in some cases the aircraft mass (1) (2) (3). Therefore, the designers are increasingly considering MEA and AEA architectures to reach the future environmental requirements and to develop a more competitive product. However, the technologies behind MEA and AEA are quite new in some aeronautic segments and totally unknown in some others. In particular, the first concern for an aircraft manufacturer is the certifiability of these new architectures. Therefore, to correctly assess the systems electrification, disciplines pertaining to the certification domain should be considered from the first design phases. Otherwise, architectures with good overall performance could be chosen, during the design process, disregarding their possibility of actually being certified.

The paper deals with the assessment of different electrified systems architecture for a small regional aircraft including some considerations about their certifiability. Therefore, the definition of a Multidisciplinary Design Analysis (MDA), which includes some disciplines related to the aircraft certification process, is carried out. In particular, the proposed MDA includes the minimum performance, external noise, and safety assessments. The MDA also embraces all design disciplines needed for aircraft preliminary design with a particular focus on the design of the electrified systems. This could be considered a fairly novel approach considering the few examples available in literature (4) (5) and compared to the majority of multidisciplinary design focused on aero-structural problems (6) (7). The present work represents an Application Case (AC) carried out in the frame of the AGILE4.0 European research project (8) which is focused on reducing aircraft development cost and time introducing new technologies and novel design disciplines to

Multidisciplinary Design Analysis and Optimization (MDAO) problems such as aircraft certification, production and upgrade. The main technical objectives of the project are:

- Develop Technologies streamlining integration and collaboration in the supply chain;
- Develop solutions accelerating trade-off and decision making;
- A novel design and optimization Paradigm for complex systems;
- Implement a reconfigurable computational design environment.

The Application Case here discussed is developed in the scope of the “certification driven stream” which is a series of MDAO problems involving different aspects of aircraft certification. They will range from safety analysis of aircraft subsystems to the aircraft's continuous airworthiness and its maintainability. In this way, the aircraft certifiability will be increased from the first phases of the design, allowing a reduction of the development time and cost. As part of this stream, the integrated design of a small regional aircraft and its electrified systems is described in the present paper.

In section III, the reference aircraft and the different OBS architectures are described and increasing electrification levels are identified. In the same section, the basic design workflow and the tool involved are defined. Section IV contains the modeled certification process and the whole workflow. Finally, the conclusions have been drawn also highlighting the next expected developments.

III. MDA problem and Design process

A. Problem definition and reference aircraft

The main aim of the present MDA is to design and assess different electrified on-board systems for a small regional aircraft. The reference aircraft is a small twin turboprop, 19 passengers regional transport aircraft capable of 1500 km of maximum range. All the aircraft Top Level Aircraft Requirements (TLARs) are listed in Table 1. The Maximum Take Off Mass (MTOM) has been set up to be close to the maximum MTOM permitted by FAR23 and CS23. In this way, the designed aircraft can be analyzed using both Part23 and Part25 regulations to compare their different effects on aircraft and systems design.

Table 1. Reference aircraft TLARs

	Metric	Imperial
MTOM	≤ 8600 kg	≤ 19000 lb
PAX	≤19	≤19
Range	≤1500 km	≤800 nm
Speed	0.45 M	0.45 M
Ceiling	7600 m	25000 ft
TOFL	<800 m	< 2600 ft

Four different systems architectures, already defined in previous works (e.g., (9) and (10)), have been considered for the reference aircraft. Each architecture has a different electrification level.

For this aircraft category, the conventional architecture is depicted in Fig. 1(a). The Flight Control System (FCS) is mechanical for primary surfaces and hydraulically actuated secondary surfaces (i.e., flaps). Considering the aircraft dimensions and speed, this is considered the best compromise in terms of performance and cost. The Environmental Control System (ECS) is needed to pressurize the cabin and to control its internal temperature. The cabin pressurization is needed considering the ceiling altitude requirement. The ECS uses two standard 3-wheels Air Cycle Machine (ACM) pneumatically powered by the engine bleed system. The bleed air is also used to inflate and deflate the boots of the de-icing system that cover the leading edge of the wings and horizontal tailplane. An electrothermal de-icing system is considered for sensors, windscreens, propeller blades, engine intakes and the compensation horns of the movable control surfaces. The extraction/retraction, steering and braking of landing gears are hydraulically actuated. The conventional architecture needs a triple power system (i.e., pneumatic, hydraulic, and electric systems);

each of them is configured as a double lane. The electric system has two low voltage (i.e. 28 VDC) starter generators and two inverters to supply the 28 VDC and 115 VAC 400hz busses.

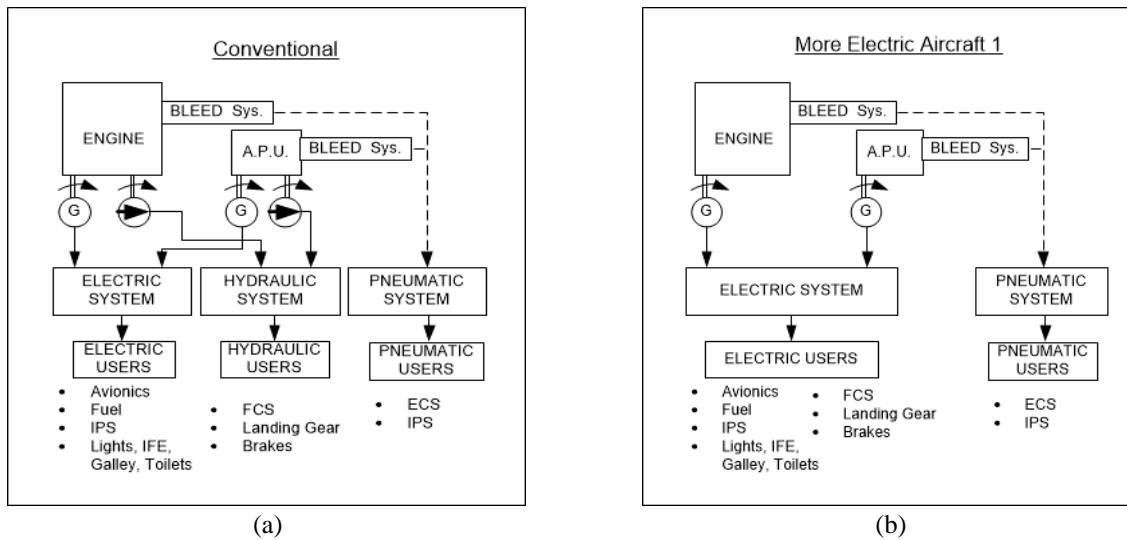


Fig. 1 Conventional (a) and more electric n.1 (b) OBS architectures.

The first more electric architecture (MEA1) (see Fig. 1(a)) is inspired by the last Airbus aircraft that used some electrical actuators replacing the hydraulic ones (11). In MEA1 all hydraulic system and users are removed. The flap and landing gear system hydraulic actuators are replaced by Electro Hydrostatic Actuators (EHA) supplied by a high voltage electric system. The electric system provides 270 VDC voltage by means of two starter generators. All-electric users are connected to a double lane 270 VDC bass. The Ice Protection System (IPS) and ECS are conventional and supplied by the pneumatic system using the engine bleed air.

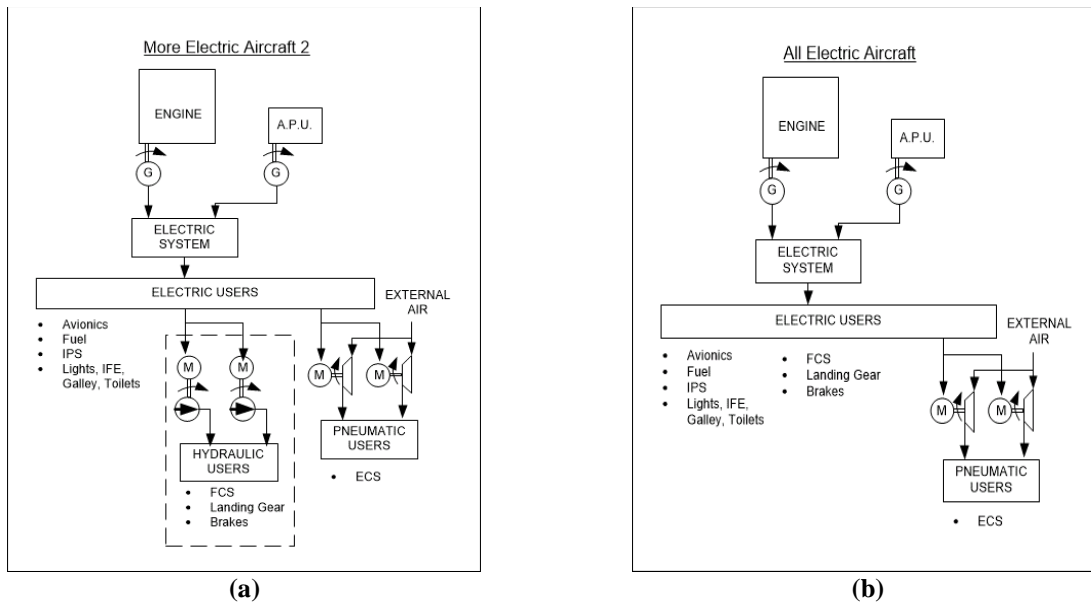


Fig. 2 More electric n.2 and all-electric OBS architectures.

The second more electric architecture (MEA2) (see Fig. 2(a)) is inspired by Boeing 787 transport aircraft. In this case, the IPS and ECS has been electrified (12). All parts of the airplane needing ice removal are equipped with electrothermal de-icing system. The ECS is supplied by external air compressed by two centrifugal compressors driven by electric motors. In this way, the pneumatic and engine bleed systems are removed. The actuation system for flap and landing gear is conventional (i.e. hydraulic). However, the hydraulic pumps are driven by electric motors instead being mechanically connected to the engine gearbox. The electric system generates high voltage current (270 VDC) by means of two starter generators.

The all-electric architecture is depicted in Fig. 2(b). It incorporates all electrified systems of MEA1 and MEA2 architecture. Therefore, the flap and landing gear actuators are electrical as well as the IPS and ECS systems. The pneumatic and hydraulic systems are completely removed. The high voltage electric system is the only system dedicated to power generation and distribution.

B. MDA workflow description

Starting only with the aircraft TLARs and the systems architecture schemes, the design workflow should be able to perform an aircraft conceptual design and subsequently the aircraft systems design. All disciplines affecting the systems or affected by the systems should be added to correctly assess the effectiveness of each architecture (13). The proposed design workflow is depicted in Fig. 3. It represents a small Design Of Experiments (DOE). In each experiment, a different systems architecture is considered together with an initial aircraft baseline defined by a conceptual design. Then, the MDA is performed, having the MTOM as a converging variable. Therefore, for each DOE point, a new aircraft design is carried out.

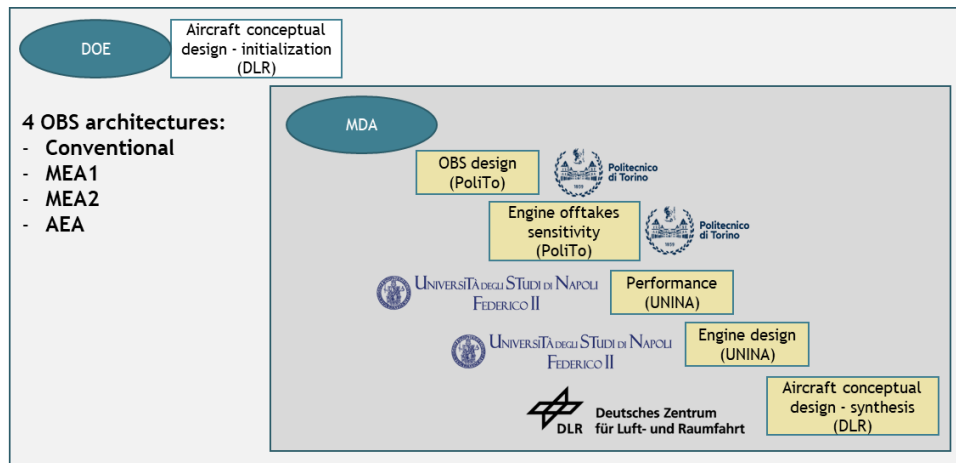


Fig. 3. Design workflow with the main design disciplines involved.

The tools (fully described in (13)) included in the workflows are:

- OpenAD (DLR). Overall aircraft conceptual design tool. Starting from aircraft TLARs, it is able to generate the aircraft geometry and define the main aircraft masses and their position. It is outside the MDA, and it is needed to provide all the necessary input to the other disciplinary tools.
- ASTRID (PoliTo). Aircraft systems design tool. All main user systems are designed by ASTRID including Avionics, FCS, landing gear, IPS, ECS, fuel system and all power systems (i.e. pneumatic, hydraulic, and electric systems). The tool is based on semi-empirical and physic-based algorithms and it is capable to design more electric and all electric architectures. The main results include systems masses, volumes and power required throughout the aircraft mission profile.

- Performance (UNINA). Aircraft performance calculation tool. Several aircraft performances are calculated including flight envelope, balanced field length, glide ratio, rate of climb, maximum ceiling, mission fuel, mission range and time.
- Engine (UNINA). Engine design tool. Based on scaled engine deck, it is able to calculate engine performance, main dimensions and mass.
- SFC_sensitivity (PoliTo). Engine performance tool. Based on scaled engine deck, this tool defines the new engine Specific Fuel Consumption (SFC) considering the systems power offtakes and bleed air requirements.

The proposed workflow has been integrated within RCE MDAO environment (14) using CPACS (15) as connecting file to transfer the information among the tools. CPACS stands for Common Parametric Aircraft Configuration Schema and is an open-source, XML-based common language for the exchange of product data.

IV. Modeled certification process

The certification process is a very complex task, and it involves several technical disciplines. Among those disciplines, the assessment of the minimum performance, the external noise and safety are considered in the present paper. The different systems architectures perform differently, having different mass and power offtakes. This could have an indirect effect on aircraft flight performance and external noise. Additionally, the systems architectures previously defined use different system components that are connected together in a different way. This could produce a direct effect on the safety performance of the systems. In Fig. 4 the complete workflow is depicted.

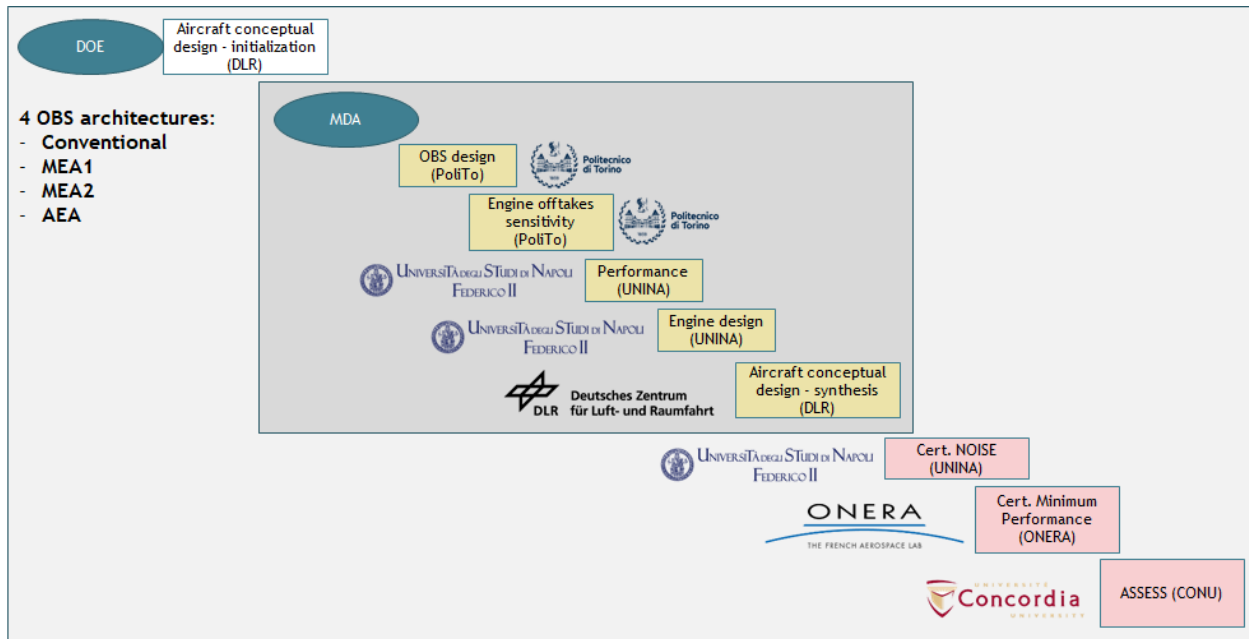


Fig. 4. Complete workflow with design and certification disciplines.

A. Minimum performance

In 2015, following different studies about innovative aircraft, ONERA started to investigate the impact of certification and operational constraints at early stages of the design processes. A Certification Constraints Module (CCM) (16) was developed in order to provide, within a MDAO process, a digital version of the regulatory texts. The primary goal of this module was to simplify the management and assessment of certification constraints during sizing

and optimization loops for conceptual/preliminary aircraft studies. The CCM relies on a generic approach that allows users to enter all relevant information regarding certification paragraphs according to a given category breakdown: Flight Conditions Setup, Dynamic Maneuvers and Exit Criteria. In the case of Performance constraints, no information must be given on control surfaces changes as the test is made on a steady flight condition and only one exit criteria can be identified. For dynamic assessments, the required control inputs to generate the aircraft moments are entered. Then, for the exit criteria, one or more parameters can be selected. The information is stored in an .XML file that contains all information associated to certification constraints and that are necessary for the computations.

Efforts concentrated on managing a very large number of parameters as well as defining reference values used in various sections. The proposed data model demonstrated its robustness and flexibility as different constraints of the CS 25 SUBPART B – FLIGHT (17) have been defined. The module was integrated in the common aircraft sizing tool FAST (Fixed-wing Aircraft Sizing Tool) (18) result of the collaboration in Aircraft Design between ONERA and ISAE-SUPAERO.

Regarding activities performed in the frame of AGILE4.0, several adaptations were conducted to achieve an operational integration in the CCM in the more electric regional aircraft MDO workflow.

First of all, the CCM inputs had to be modified in order to be compatible with the available information delivered by other design competences but also compatible with their format, namely CPACS. It allows storage of parametric definitions of aircraft geometries as well as results of analysis results of the individual design disciplines in a hierarchical structure that allows the consistent exchange of product data among Design Competences. The main provider of CCM’s inputs is UNINA Performance tool that deliver the required information in terms of aerodynamics performances (low-speed and clean configuration) and mission performances (mission path including altitudes, speeds and weights). Other required information is the engine deck performance that was also shared with UNINA Performance tool.

Once the compatibility achieved, the second step was to enrich the CCM with certification paragraphs of interest for the study. The identification and selection of such paragraphs was carried out collaboratively with Concordia University. Due to the specific TLARs of the more electric regional aircraft, certification paragraphs were selected both in FR-23 and FAR-25 documents. Fig. 5 and Fig. 6 summarize the subsections retained for the assessment of the aircraft. Information regarding configuration in terms of flap and landing gear characteristics, altitude and power setting are indicated, as well as a threshold for the climb gradient.

Subsection	Specifications/ Definitions/ Definitions	67c-1	67c-2	67c-3	67c-4	77c	
		(FAR 23.67)	(FAR 23.67)	(FAR 23.67)	(FAR 23.67)	(FAR 23.77)	
		Takeoff, landing gear extended	Takeoff, Landing gear retracted	Enroute	Discontinued approach	Balked Landing	
name	name of each phase	67_1	67_2	67_3	67_4	77	
cgr	climb gradient	two-engine airplanes	0	2	1.2	2.1	3.2
		three-engine airplanes	0.3	2.3	1.5	2.4	3.2
		four-engine airplanes	0.5	2.6	1.7	2.7	3.2
rc	rate of climb	None (not specified)	None (not specified)	None (not specified)	None (not specified)	None (not specified)	
config	configuration	landing gear, takeoff flaps	takeoff flaps	clean	approach flaps	landing flaps, landing gear	
v/vstall	phase speed over speed	None	None	1.2	1.5	1.3	
engines_inop	no. engines inoperative	1	1	1	1	0	
weight	ratio of weight during the condition to weight at takeoff	1	1	1	m/m_mtom	m/m_mtom	
T_env	temperature	T_env	T_env	T_env	T_env	T_env	
alt	altitude in ft	h_runway	h_runway + 400	h_runway + 1500	h_runway + 400	0	
pressure	pressure in psi	None (not specified)	None (not specified)	None (not specified)	None (not specified)	None (not specified)	
pwr_setting	throttle setting (0 – 1)	1	1	mcp_mto	1	1	

Fig. 5. FAR-23 paragraphs retained for the study

Considering both inputs from other design competences and information from certification paragraphs, the CCM was fully integrated into the workflow.

Subsection		111 (FAR 25.111 (OEI))	121 (FAR 25.121 (OEI)) (a)	121 (FAR 25.121 (OEI)) (b)	121 (FAR 25.121 (OEI)) (c)	119 (FAR 25.119 (AEO))	121 (FAR 25.121 (OEI))
Specifications/Definitions		initial climb segment	transition segment	second segment	enroute climb	landing climb	climb gradient with critical engine
name	name of each phase	111_initial	121_transition	121_second	121_enroute	119_landing	121_landing_oei
cgr	two-engine airplanes	1.2	0	2.4	1.2	3.2	2.1
	three-engine airplanes	1.5	0.3	2.7	1.5	3.2	2.4
	four-engine airplanes	1.7	0.5	3	1.7	3.2	2.7
rc	rate of climb	None (not specified)	None (not specified)	None (not specified)	None (not specified)	None (not specified)	None (not specified)
config	configuration	takeoff flaps only	takeoff flaps, landing gear	takeoff flaps only	clean	landing flaps, landing gear	approach flaps, landing gears
v/vstall	phase speed over speed	1.2	1.1	1.2	1.25	1.3	1.5
engines_inop	no. engines inoperative	1	1	1	1	0	1
weight	ratio of weight during the condition to weight at takeoff	1	1	1	1	m/m_mtom	m/m_mtom
T_env	temperature	T_env	T_env	T_env	T_env	T_env	T_env
alt	altitude in ft	h_runway	h_runway	h_runway + 35	h_runway + 400	h_runway + 50	h_runway + 50
pressure	pressure in psi	None (not specified)	None (not specified)	None (not specified)	None (not specified)	None (not specified)	None (not specified)
pwr_setting	throttle setting (0 - 1)	1	1	1	mcp_mto	1	1

Fig. 6. FAR-25 paragraphs retained for the study

B. External noise assessment

The Noise Tool is a MATLAB software developed by University of Naples able to estimate the noise generated by an aircraft in different flight conditions. Specifically, it evaluates the value of Effective Perceived Noise Level (EPNL) at the identification points provided by ICAO regulation. The program is based on the implementation of ESDU methodologies (semi-empirical approaches) for the airframe contribution, making appropriate modifications where necessary. Whereas for the engine noise, it uses an external database customizable by the user and eventually computed with ESDU method. The software can also evaluate the effects of atmospheric attenuation, ground reflection and shielding effects.

The main inputs required by the tool are:

- Aircraft main geometries,
- Engine Noise deck,
- Aircraft trajectories during takeoff and approach (if not provided, they are estimated through flight mechanics formulas).

The tool is able to estimate the noise certification margin for aircraft belonging to both CS23 and CS25 regulation categories.

CS-25. ICAO Annex 16 chapter 3.

The Noise tool performs noise calculations at the points foreseen by the certification: Approach, Flyover and Lateral (Fig. 7); for each of them the value of EPNL is estimated. The environmental conditions of the test will be listed in the following, and the specific conditions for each certification point will be described. All conditions are implemented in the software.

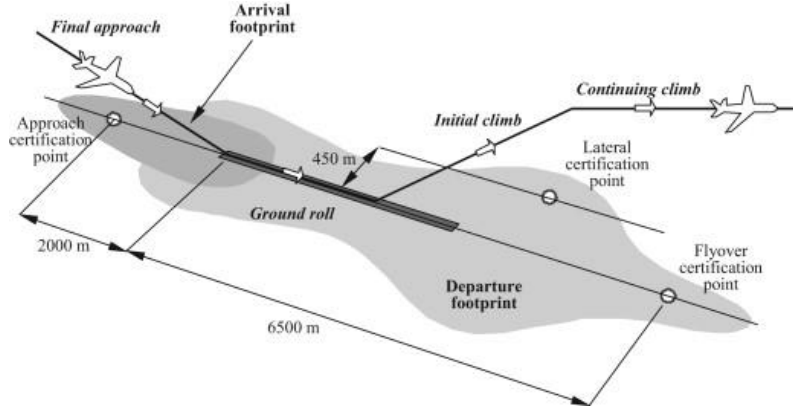


Fig. 7. ICAO/Annex 16/Chapter 3, measuring locations

The certification test must comply with the following environmental conditions:

- Sea level atmospheric pressure of 101.325 kPa.
- Ambient air temperature of 25°C.
- Relative humidity of 70%.
- Zero wind.

The certification test in Approach conditions must possess the following requisites:

- a) The measuring point must be positioned at 2000 m from the beginning of the landing strip.
- b) The approach trajectory must have a 3° degree approach angle.

The certification test in Flyover conditions must possess the following requisites:

- a) The measuring point must be positioned 6500 m away from the start of the take-off run.
- b) The thrust or power shall not be reduced below that required to maintain:
 1. a climb gradient of 4 %; or
 2. in the case of multi-engine aeroplanes, level flight with one engine inoperative.

The certification test in Flyover conditions must meet the following requirements:

- a) Maximum engine speed.
- b) The measurement is carried out on two sidelines positioned at 450 from the take-off runway.
- c) The reference EPNL value is the maximum value measured on the sideline.

CS-23. ICAO Annex 16 chapter 10.

The noise tool performs noise calculations in a single point provided by certification: Take-off; the reference flight path is illustrated in Fig. 8. The sound metric used for the noise computation is the maximum level of the A-weighted sound pressure of 20 µPa. The environmental conditions are the same indicated for CS-25 regulation.

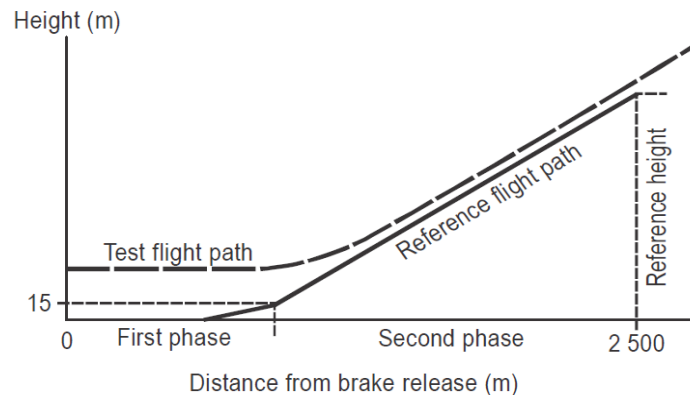


Fig. 8. ICAO/Annex 16/Chapter 10. Take-Off reference flight path

The certification test in take-off conditions must possess the following requisites:

- a) During the second phase the speed must be equal to the best rate of climb speed.
- b) The reference noise measurement point is the one on the extended centre line of the runway at a distance of 2 500 m from the start of take-off roll.

The tool is also capable of providing a georeferenced footprint during the certification phase described above.

C. Safety assessment

Safety Assessment is an important part of the certification process. For civil aircraft, the safety process is outlined by the SAE ARP4761 (19), and includes several steps traditionally done after the conceptual design and in a separate, manual process. To incorporate safety assessment into MDAO workflows, the Aircraft Systems Lab at Concordia

University develops a methodology and tool called ASSESS (which stands for Aircraft Systems Safety assessment), which involves several levels, covering the various aspects of aircraft and system safety assessment with increasing level of detail. In this paper, the ASSESS-L0 (level 0), the method for the first phase of the conceptual design is presented, with the focus on the integration within an MDAO framework.

ASSESS-L0 implements a heuristic approach based on rules stemming from observed and certified implementations of aircraft systems and samples the required redundancies in power allocation and distribution for aircraft systems, similar to work presented by (20) and (21). The objective of ASSESS-L0 is to filter a large design space of architectures for only feasible ones, from a safety and redundancy perspective. As such, ASSESS-L0 has different rules based on the aircraft certification category and the subsystem being considered. The novelty of ASSESS-L0 is to expand the rules and make them applicable to unconventional aircraft and system configurations. I.e., for more electrical aircraft systems, the rules ensure enough redundancy are implemented. The subsequent conceptual sizing estimation of the systems yields a meaningful weight and power demand.

Furthermore ASSESS-L0 uses a formulation of generic elements to represent the system architecture and the interconnections of its constituent components. This representation is generic enough to help identify key redundancies in power and control chains and serves as a platform upon which safety heuristics are evaluated. Typical elements such as Source, Distribution, Consumer and Device are used to represent power generation, distribution, consumption and passive elements respectively. These can have different manifestations at multiple levels of granularity. E.g a consumer element could be an entire subsystem such as the flight control system or more specific subcomponent such as an actuator.

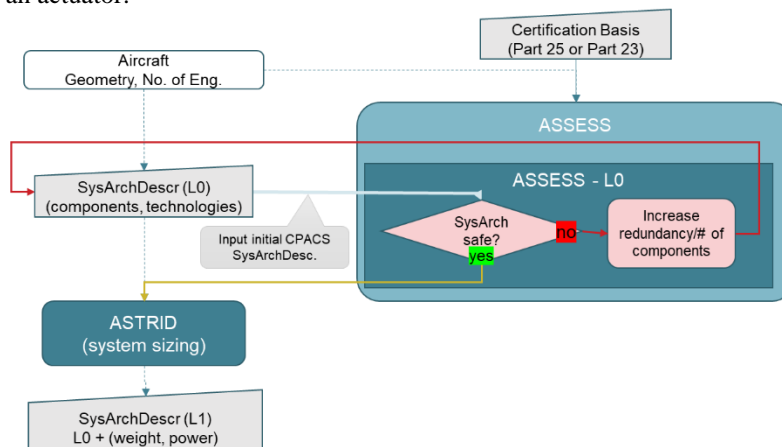


Fig. 9. ASSESS-L0 interaction with the MADO workflow: principle, inputs, outputs, and interaction

Fig 9 shows the interaction between ASSESS L0 tool and the system sizing tool ASTRID. Typically, a system architecture in the form of a CPACS file that outlines the aircraft type, certification basis, choice of technology, allocation of redundancies in power distribution and allocation of power distribution to individual power consuming components is provided to the ASSESS L0 module. The file is parsed and the system architecture can then either be evaluated using safety heuristics or be compared to an existing list of architectures that have been generated using safety rules. ASSESS L0 then determines if the given architecture complies with safety rules and if the architecture is non compliant, then the safety analyst must intervene to render additional redundancies. The architectures that pass are then provided in CPACS format to the subsystem sizing tool, ASTRID which then determines meaningful mass and power metrics that are then appended to the CPACS descriptor.

V. Results of the multidisciplinary analysis of the small turboprop aircraft

A. Multidisciplinary design analysis

Starting from the aircraft TLARs, OAD generates the aircraft geometry depicted in Fig. 10. The aircraft configuration is equivalent to similar aircraft already produced. The wing position has been analyzed to obtain static stability. The fuselage is elliptical, considering the need for pressurization. The aircraft is compliant with the initial requirements showing an MTOM of about 8.5 tons, a TOFL of 800m, a ceiling of 7620m and maximum range of 1200

km. The results of OAD are also confirmed and refined by the performance tool. The aircraft reaches (and slightly exceeds) the required speed at ceiling altitude. This is the design point for the propulsion system. For this reason, the aircraft outperform the takeoff field length requirement. Therefore, the engines could be flat rated for ground operation. Moreover, the speed requirement leads to a greater real ceiling altitude, as depicted. However, as for other aircraft (e.g., Beechcraft 1900d), the maximum ceiling is limited by the cabin pressurization at 7600m. This decreases the fuselage mass since there is no need for this kind of aircraft to fly at a higher altitude.



Fig. 10 Aircraft baseline as results of the MDA.

Table 2 lists the main masses of the different aircraft having a specific OBS architecture. The aircraft adopting the conventional architecture is the heaviest. The MEA1 systems architecture seems to give a greater benefit in terms of MTOM reduction for this aircraft category. The removal of the hydraulic system is the main advantage of this architecture. The aircraft employing the AEA has a greater systems mass due to the use of the electric ECS, which needs additional components. Fig. 11 shows the comparison, in percentage terms, between the main masses of the conventional aircraft with those of the electrified ones. It is worth noting that the aircraft employing the AEA architecture, despite not having the lowest MTOM, reaches the maximum save in fuel mass. This is due to both the effect of a lower MTOM and a more efficient ECS and IPS.

Table 2. Main masses of the aircraft with different OBS architecture

Masses [kg]	Conventional	MEA 1	MEA 2	AEA
MTOM	8620	8394	8511	8413
ZFM	7660	7454	7570	7482
OEM	5608	5402	5518	5430
Airframe	2356	2326	2342	2328
Mission Fuel	1063	1042	1043	1033
OBS mass	2101	1927	2028	1953

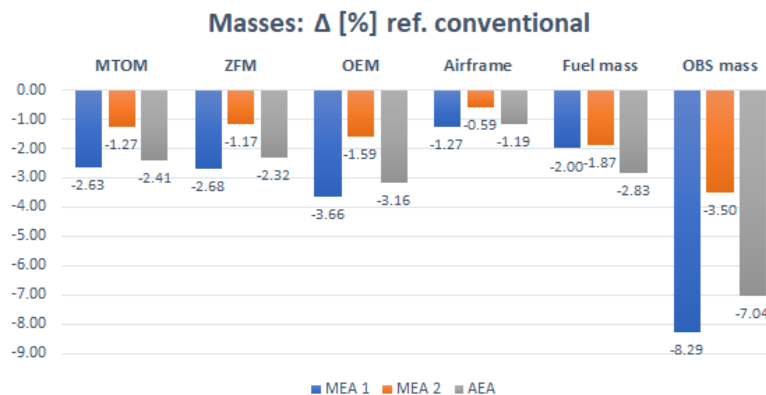


Fig. 11 Comparison between aircraft with different OBS architecture.

B. Verification of certification constraints and feedback to the design

i. Performance constraints

The CCM modules described in IV.B, was integrated into the workflow after the MDA loop in order to compute the performance certification margin of the different concepts. In the current state of the workflow, CCM outputs are mainly considered as quantities of interest to analyze but could be later used as constraints for the MDO problem associated with this study.

Four different aircraft were delivered by the MDA, each one corresponding to a specific choice of On-Board Systems (OBS) electrification level: conventional (CONV), more – electric 1 (MEA1), more electric 2 (MEA2) and All electric (AEA). The OBS architecture associated with each concept was presented in III.A in Fig. 1 and Fig. 2.

Fig. 12(a) and Fig. 12(b) present the results obtained in terms of climb gradient values for each concept for a subset of certification subsections. As a reminder, C67-C1, C67-C2 and C67-C3 correspond to FAR 23 climb phase with One Engine Inoperative (OEI). C111 and C121-a, C121-b and C121-c cover FAR 25 climb phase conditions with OEI. Similarly, C67- 4 and C121-d correspond to the approach phase.

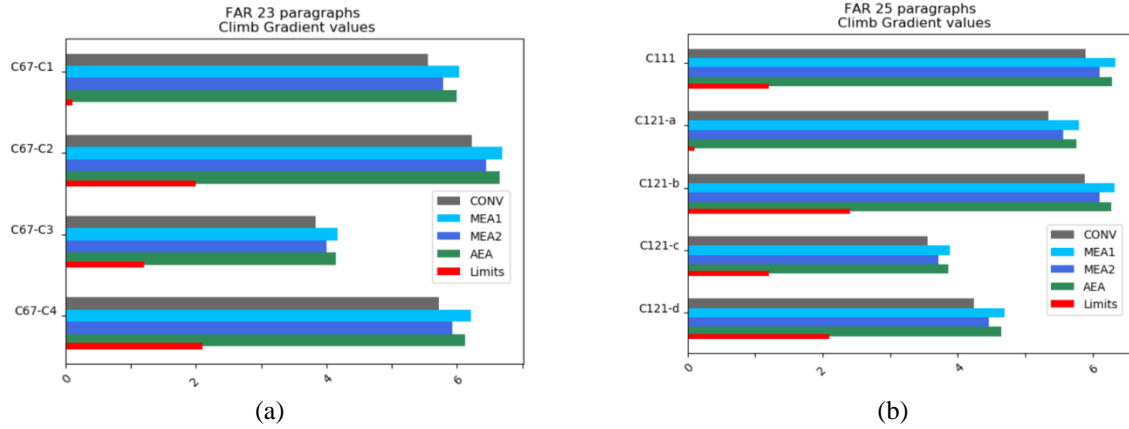


Fig. 12 : FAR-23 (a) and FAR-25 (b) performance on certification paragraphs.

First of all, all 4 concepts are compliant with the current selection of performance paragraphs, both for FAR 23 and FAR 25. Regarding the ranking, it is similar for all paragraphs with a higher margin for MAE1 and AEA, followed by MEA2 and CONV configurations. The differences are quite small between all 4 concepts what can be explained by the low differences between them. Actually, only the weights such as MTOM and MLM are different as geometries, engine and aerodynamic performances are similar. What appears more interesting to analyze is the high margin of all aircraft for all paragraphs: they all exhibit very good climb performances that cannot be explained by the aerodynamic capabilities as both drag and lift coefficients at low speed are quite standard. The reason for such margin lies in the choice of the engine that was selected to achieve high performance in cruise both in terms of speed and altitude. As a result, the engine is oversized for low speed/low altitude leading to this comfortable certification margins.

In order to take advantage of these climb capabilities, investigations are under study to reduce the low –speed aerodynamic characteristics of the aircraft in order to diminish the certification margin while gaining on weight and complexity on –for instance- the high lifting devices choice and characteristics.

ii. Noise constraints

Table 3 summarizes the main results obtained through noise tool computation considering CS-23 certification. For each level of On-board System electrification, the total noise level obtained during take-off condition is illustrated. In

addition, the limit imposed by the regulation and the corresponding margin are indicated, as required by CS-23 regulation. No one configuration overcame the limitation.

Table 3. Noise level and certification limit comparison. CS-23 regulation

System Architecture	Total noise level [dbA]	Certification Limit [dbA]	Certification Margin [dbA]
Conventional	74.1	88	13.9
MEA1	73.6	88	14.4
MEA2	73.8	88	14.2
AEA	73.6	88	14.4

Fig. 13 illustrates the contour of the total noise emitted by conventional configuration in a local reference frame, which center corresponds to the beginning of the runway. The footprint assumes a "shell" trend; the noise emissions increase by going inside the contour, the highest values is reached in the inner layer of plot.

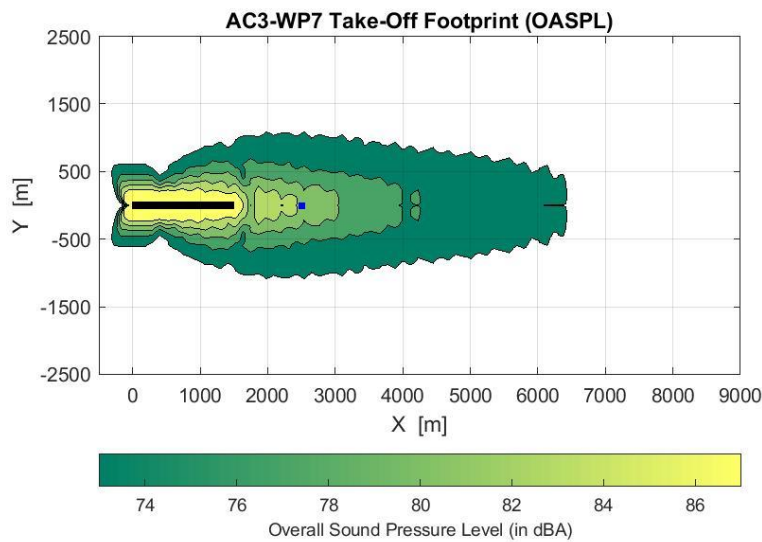


Fig. 13. Take-off footprint. Baseline aircraft. CS-23 regulation.

Table 4 and Fig. 14 show the noise results obtained considering CS-25 certification computation applied to conventional aircraft configuration. Take-off and approach phases are taken into account. Also, in this case, the certification limits are not exceeded.

Table 4. Total noise level and certification limit comparison. CS-25 regulation.

Certification point	Total noise level [dB]	Certification Limit [dB]	Certification Margin [dB]
Approach	91.9	98	6.1
Lateral	82.5	94	12.3
Flyover	76.1	89	12.9

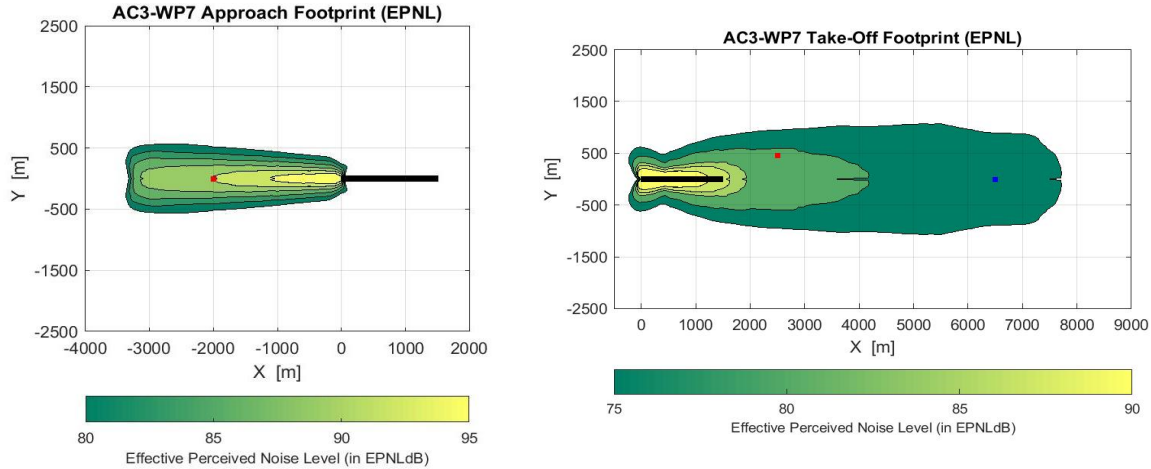


Fig. 14. Take-off and approach footprint. Baseline aircraft. CS-25 regulation.

iii. Safety assessment

This section presents the results of the ASSESS L0 module. Here, the architecture of a landing gear braking system is considered for the conventional and more electric-1 aircraft options. The landing gear braking system in this study uses a main gear configuration with one braking device per wheel (Dv). A constrained design space is generated by selecting the actuation technology employed in each case. An electrohydraulic servo actuator (EHSA) is used for the conventional system, and the more electric - 1 case uses an Electromechanical actuator (EMA). It is to be noted that in the case of electric braking, each braking unit is assumed to be comprised of four individual EMA's.

Figure 15 illustrates the process used to implement the safety heuristics in ASSESS L0. In this implementation, based on the choice of actuation technology, a design space of feasible architecture choices is created. This is done by first representing the system architecture using the generic elements and applying safety heuristics to constrain the connections between the Distribution (D) and Consumer (C) elements. Thus, the design space is reduced to a combination of Source (S) and Distribution (D) elements, and a complete list is populated for conventional and electrical landing gear options.

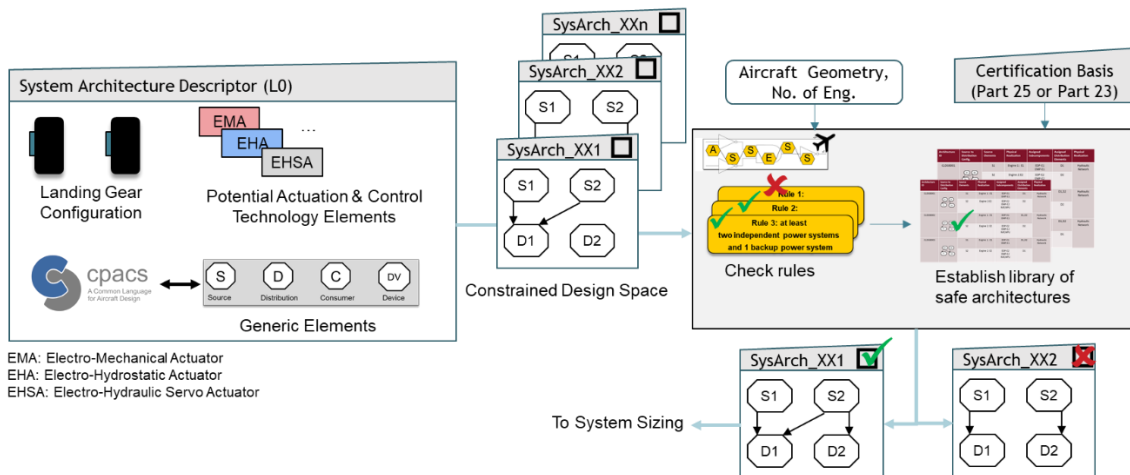


Fig. 15. Process of generating a constrained design space and filtering architectures based on safety heuristics in ASSESS L0

Overall, six architectures were generated for the conventional landing gear braking system and five for the more electric braking system, respectively. As shown in Table 5, six architectures were found to comply with the safety heuristics in the conventional landing gear braking system and four for the electric braking system, respectively. Table 5 presents typical cases of generated, feasible, and unfeasible architectures. Only the combinations arising from connections between the source (S) and distribution (D) elements need to be explored by constraining the connections between distribution elements and consumer elements. The link between Source (S) and Distribution (D) elements represents the power generation and distribution aspects that are allocated to landing gear braking.

Table 5: Results of the safety heuristics-based design space generation and filtering process

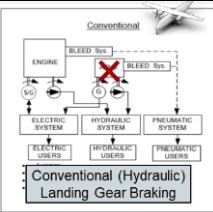
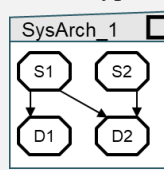
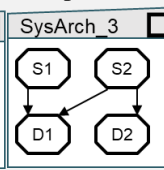
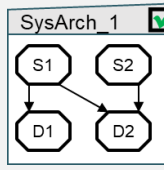
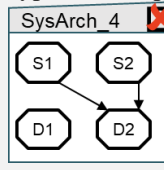
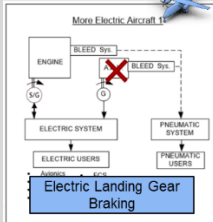
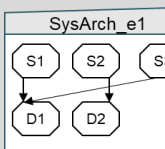
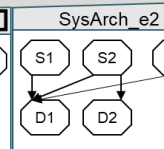
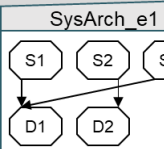
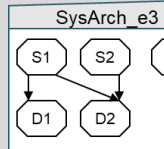
Option	No. of generated architectures	No. of feasible architectures	No. of unfeasible architectures
Conventional (Hydraulic Landing Gear Braking System)	6	4	2
	Typical Examples  	Typical Example 	Typical Example 
More Electric 1 (Fully Electric Landing Gear Braking System)	5	4	1
	Typical Examples  	Typical Example 	Typical Example 

Figure 16 shows the equivalent allocation schematic from the engine (the power source) to the individual hydraulic power distribution systems for one feasible and unfeasible architecture from Table 5. One of the safety rules requires the landing gear braking unit to be supplied with at least two independent sources of hydraulic power. This is achieved in SysArch_1, by the allocation of the Sources (here: engines) to the Distribution (here: hydraulic systems) as shown in Fig 16 a). However, in Figure 16 b), the braking unit is deprived of redundancy and is supplied by only one independent hydraulic system, thus violating the safety rules and deemed unfeasible.

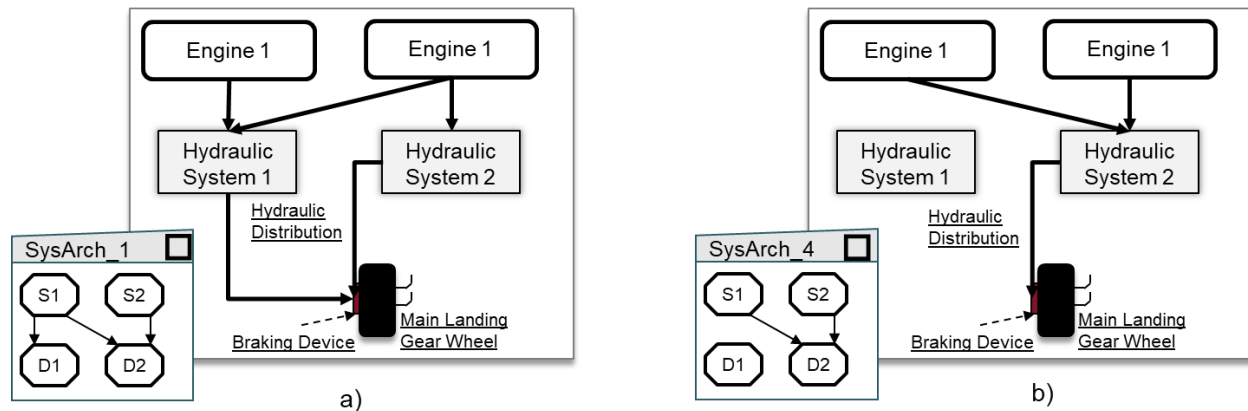


Fig. 16. Equivalent system schematics for ASSESS L0 representation using generic elements

Overall, the example on the braking system illustrates how ASSESS-L0 is used to filter an automatically generated design space. In the future, the ASSESS-L0 method will be expanded to the complete system architecture.

Conclusion

An MDA workflow that includes systems design and certification disciplines has been developed. To the design loop already analyzed and tested, new modules concerning certification disciplines have been added. The workflow is sensible to different systems architecture with increasing electrification level. The results from the design loop show a baseline aircraft quite in line with existing aircraft with same performance and masses. Increasing the electrification level of the OBS variations in terms of about 3% of MTOM are observed. In particular, the replacement of the hydraulic actuation system with the electrified one represents an important advantage in terms of mass reduction. When the electrification is applied to the ECS and IPS supporting the engine bleedless technology the reduction of fuel mass reach about 3%. However, the bleedless technologies and the related systems are a little heavier than the conventional one for this aircraft configuration. Therefore, the maximum OBS electrification level do not represent the maximum reduction of the aircraft MTOM.

The most innovative part of the work is related to the integration of some certification disciplines: external noise, minimum performance and OBS safety assessment. Even if they represent only a little part of the certification process, the main result is represented by the possibility to actually integrate them in a MDA. The results coming from the certification disciplines are in line with the expectations and with the design constraints already applied in the conceptual design phase. However, further studies will be carried out to optimize the design and to reduce the margin with the certification constraint reducing both the aircraft MTOM and its cost. Moreover, additional certification disciplines will be included in the workflow to cover a greater part of the certification process.

Acknowledgments

The research presented in this paper has been performed in the framework of the AGILE 4.0 project (Towards Cyber-physical Collaborative Aircraft Development) and has received funding from the European Union Horizon 2020 Programme under grant agreement n° 815122. The work performed by the Canadian partners is supported by the Natural Sciences and Engineering Research Council of Canada (NSERC), Grant Number CRDPJ 538897-19 and RGPIN/5515-2019, and the Consortium de recherche et d'innovation en aérospatiale au Québec (CRIAQ).

The authors would like to acknowledge Gala Licheva from Concordia University for her assistance with the identification and compilation of certification rules.

References

1. Berlowitz I. All/More Electric Aircraft Engine & Airframe Systems Implementation. In The 9th Israeli Symposium on Jet Engines and Gas Turbines; 2010.

2. Cronin MJ. All-Electric vs Conventional Aircraft: The Production/Operational Aspects. *Journal of Aircraft*. 1983; 20(6): p. 481-486.
3. Jones RI. The more electric aircraft—assessing the benefits. *Proceedings of the Institution of Mechanical Engineers, Part G: Journal of Aerospace Engineering*. 2002; 216(5): p. 259-269.
4. Chakraborty I, Mavris DN. An integrated approach to vehicle propulsion system, and subsystem sizing - Application to the all-electric aircraft. *Sage Journals*. 2010.
5. Xie J, Sarojini D, Cai Y, Corman JA, Mavris DN. Certification-Driven Platform for Multidisciplinary Design Space Exploration in Airframe Preliminary Design. *Journal of Aircraft*. 2021.
6. Sobieszczanski-Sobieski J. Multidisciplinary Design Optimization: An Emerging New Engineering Discipline. *Advances in Structural Optimization*. 1995;; p. 483-496.
7. Werner-Westphal C, Heinze W, Horst P. Multidisciplinary Integrated Preliminary Design Applied to Unconventional Aircraft Configuration. *Journal of Aircraft*. 2008; 45(2): p. 581-590.
8. partners A0. [Online]. [cited 2021 June. Available from: <https://www.agile4.eu/>.
9. Vecchia PD, Stingo L, Nicolosi F, De Marco A, Cerino G, Ciampa PD, et al. Advanced turboprop multidisciplinary design and optimization within agile project. In 2018 Aviation Technology, Integration, and Operations Conference; 2018: American Institute of Aeronautics and Astronautics Inc, AIAA.
10. Fioriti M, Boggero L, Prakasha PS, Mirzoyan A, Aigner B, Anisimov K. Multidisciplinary aircraft integration within a collaborative and distributed design framework using the AGILE paradigm. *Progress in Aerospace Sciences*. 2020 Nov 1.
11. van den Bossche D. The A380 flight control electrohydrostatic actuators, achievements and lessons learnt. In *ICAS*; 2006; Hamburg.
12. Sinnet M. 787 No-Bleed Systems: Saving Fuel and Enhancing Operational Efficiencies. *Aero Quarterly QTR_04 | 07*. 2007;; p. 06-11.
13. Fioriti M, Della Vecchia P, Donelli G. Effect of Progressive Integration of On-Board Systems Design Discipline in an MDA Framework for Aircraft Design with Different Level of Systems Electrification. *Aerospace*. 2022; 9(3).
14. Official RCE Webpage. [Online]. Available from: <http://rcenvironment.de/>.
15. Common Language for Aircraft Design. [Online].; 2019 [cited 2019 May. Available from: <http://cpacs.de>.
16. Schmollgruber P, BN, BJ, DS, GY, BE, & SA. Use of a certification constraints module for aircraft design activities. In 17th AIAA Aviation Technology, Integration, and Operations Conference; 2017; Denver, Colorado (USA). p. 3762.
17. EASA. EASA CS-25 Amendment 26. [Online].; 2021 [cited 2021 10 26. Available from: https://www.easa.europa.eu/sites/default/files/dfu/cs-25_amendment_26_0.pdf.
18. David C, DS, DS, SP, BE, & PBV. From FAST to FAST-OAD: An open source framework for rapid Overall Aircraft Design. In *IOP Conference Series: Materials Science and Engineering*; 2021. p. Vol. 1024, No. 1, p. 012062.
19. SAE International. ARP4761: Guidelines and Methods for Conducting the Safety Assessment Process on Civil Airborne Systems and Equipment. 1996..
20. Chakraborty. I MD. Heuristic definition, evaluation, and impact decomposition of aircraft subsystem architectures. In 16th AIAA Aviation Technology, Integration, and Operations Conference; 2016: American Institute of Aeronautics and Astronautics Inc, AIAA.
21. Lampl. T WTM. Preliminary design of advanced flight control system architectures for commercial transport aircraft. *CEAS Aeronautical Journal*. 2019.