

## Modeling and analysis of energy losses under transient conditions in induction motors

Ayman Y. Al-Rawashdeh<sup>1</sup>, Ali Dalabeeh<sup>1</sup>, Ashraf Samarah<sup>2</sup>, Abdallah Ershoud Al-Zyoud<sup>1</sup>, Khalaf Y. Alzyoud<sup>1</sup>

<sup>1</sup>Department of Electrical Engineering, Faculty of Engineering Technology, Al-Balqa Applied University, Amman, Jordan

<sup>2</sup>Department of Electrical Engineering, Faculty of Engineering, Al-Balqa Applied University, Al-Salt, Jordan

### Article Info

#### Article history:

Received Dec 28, 2020

Revised Mar 12, 2022

Accepted Mar 24, 2022

#### Keywords:

Energy losses

Induction motor

Multi-step voltage control

Simulation

Soft starting

Starting current

### ABSTRACT

The present study is mainly concerned with solving the problems associated with energy losses resulting from starting transient conditions. In the present study, the possibilities of decreasing starting transient condition energy losses are investigated. Additionally, a comparison of the energy losses using different starting methods is also conducted. In this work, a complete description for deriving the equations used to calculate energy losses, mathematical analysis of the energy losses, the models of the different methods in this work were simulated using MATLAB/Simulink; and the results of energy losses and the dynamic characteristics are provided. Simulation results showed that the minimum starting energy losses were accomplished by soft starting method, in which the starting current could be reduced to the minimum value.

*This is an open access article under the [CC BY-SA](https://creativecommons.org/licenses/by-sa/4.0/) license.*

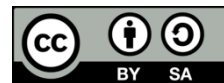

### Corresponding Author:

Ayman Y. Al-Rawashdeh

Department of Electrical Engineering, Faculty of Engineering Technology, Al-Balqa Applied University

11134 Marka, Amman, Jordan

Email: dr.ayman.rawashdeh@bau.edu.jo

## 1. INTRODUCTION

Energy conversion, in induction motors (IM), is obtained by the induced current in the rotor windings produced by electromagnetic induction [1]. The IM has three operation modes: generator, motor and electromagnetic brake and it is well known that the each of IM current, torque, slip and speed vary according to the load connected to the motor [2], [3]. The rotor speed is zero at starting time. A very large starting current is generated in the rotor windings causing the motor stator current to increase 7 to 10 times the rated current value. The value of the starting current should be limited since too large starting current will cause many adverse effects. Reducing the stator winding supply voltage when the motor starts is the common way to reduce the starting current. However, it should be noted that reducing power supply voltage in order to decrease the starting current, will also reduce the starting torque even further, which will affect the starting performance of the motor. With increasing the motor speed, the speed of the stator's rotating magnetic field is reduced, and the current in the rotor windings is also reduced, so when the motor reaches its rated speed, the stator winding current is reduced to a smaller value; reaching its rated current value [4], [5]. Due to the high starting current in the IM, the windings of the motor can be burned due to overheating, especially if the load is heavy; the IM isn't capable of reaching its rated speed in a short time window, another scenario is that the motor will rotate forward and reverse, which will cause overheat of the motor windings, and then the motor windings will burn due to overheating [6]–[8].

The second main problem in IM caused by high starting current is the high energy losses during the starting process the energy losses however, are proportional to the square of the starting current. Especially

that many IMs that are used in industry apply the operation mode of “start-stop” regimes like lifts and pumps [9], [10]. It should be noted that in developing countries, like Jordan, Industry cannot afford the high energy costs correlated with reducing the starting energy of IM [11]–[16]. There are several methods to reduce energy losses in IM such as: rotor design (RD), frequency control (FC), resistance of the rotor (RR), soft starter (SS) and voltage steps control (VSC) [17], [18]. In the last method, the step wise raise in the applied voltage during the starting process will reduce the energy losses, and the observed decrease in energy losses will greatly depend on the number of steps for voltage rising steps [19]. In the current work, two methods will be investigated and compared not only for decreasing the energy losses of IM, but also compared to the previously applied methods used for decreasing energy losses for separately excited DC motors [20]–[23]. These two methods include soft starting and multi-step voltage rising methods.

## 2. RESEARCH METHOD

The analysis of energy losses at the starting of IM without load [24], [25]:

$$T_L = 0$$

$$T_m - T_L = J \frac{d\omega_m}{dt}$$

$$S = \frac{\omega_0 - \omega_m}{\omega_0}$$

$$\omega = \omega_0(1 - S) \text{ and } d\omega = -\omega_0 \frac{ds}{dt}$$

which may be written as (1):

$$dt = -\frac{J\omega_0 ds}{T} \quad (1)$$

where,  $T$  is motor torque [n.m],  $T_L$  is load torque [n.m],  $J$  is moment of inertia [Kg/m<sup>2</sup>],  $\omega_m$  is mechanical angular velocity [rad/s],  $\omega_0$  is synchronous angular velocity [rad/s], and  $S$  is slip of motor. The energy losses in machine are calculated by applying:

$$\Delta A_{str} = \text{Stator Losses} + \text{Rotor Losses} + \text{Mechanical Losses} + \text{Iron Losses}$$

where,  $P_{stator\ losses} = 3 * I_1^2 * R_1$  and  $P_{rotor\ losses} = 3 * I_2^2 * R_2$ . The iron and mechanical losses will be neglected due to their small values.

$$\Delta A_{str} = \int_0^{t_{str}} ((3 * I_1^2 * R_1) + (3 * I_2^2 * R_2)) dt \quad (2)$$

The influence of the no-load current can be neglected, and then:

$$(I_1 = I_{nL} + I_2) \text{ and finally } (I_1 = I_2)$$

$$\Delta A_{str} = \int_0^{t_{str}} (3 * I_2^2 * (R_1 + R_2)) dt \quad (3)$$

$$\Delta A_{str} = \int_0^{t_{str}} \left( 3 * I_2^2 * R_2 \left( 1 + \frac{R_1}{R_2} \right) \right) dt \quad (4)$$

Substituting (1) in (4) gives (5).

$$\Delta A_{str} = \int_0^{t_{str}} \left( 3 * I_2^2 * R_2 \left( 1 + \frac{R_1}{R_2} \right) \right) \left( -\frac{J\omega_0 ds}{T} \right) \quad (5)$$

The equations used for determining power losses are:

$$P_{conv} = T * \omega_m$$

$$(1 - S)P_{a.gap} = T * (1 - S)\omega_0 \quad (6)$$

$$P_{a.gap} = 3 * I_2^2 * \frac{R_2}{S} \quad (7)$$

as shown in (6) and (7) give:

$$3 * I_2^2 * R_2 = T * \omega_0 * S \quad (8)$$

as shown in (5) and (8) give:

$$\Delta A_{str} = - \int_{S_{in}}^{S_{yn}} \left( J\omega_0^2 + JW\omega_0^2 \frac{R_1}{R_2} \right) s. ds \quad (9)$$

which may be written as (10):

$$\Delta A_{str} = \int_{S_{yn}}^{S_{in}} \left( J\omega_0^2 + J\omega_0^2 \frac{R_1}{R_2} \right) s. ds \quad (10)$$

where  $\Delta A_{str}$ : total starting losses;  $I_1$ : stator current;  $I_2$ : rotor current;  $R_1$ : stator resistance;  $R_2$ : rotor resistance;  $P_{RLS}$ : power losses in rotor through the slip power. When the motor starts-up from standstill ( $S_{in}=1$ ), to the synchronous speed ( $S_{yn}=0$ ).

$$\Delta A_{str} = \int_0^1 \left( J\omega_0^2 + J\omega_0^2 \frac{R_1}{R_2} \right) s. ds \quad (11)$$

After integration, (11) will be as:

$$\Delta A_{str} = \left( J\omega_0^2 + J\omega_0^2 \frac{R_1}{R_2} \right) * \left( \frac{s^2}{2} \right), \quad [1 \text{ to } 0] \quad (12)$$

$$2 \Delta A_{str} = \frac{1}{2} \left( J\omega_0^2 + J\omega_0^2 \frac{R_1}{R_2} \right) \quad (13)$$

where,  $\frac{1}{2} J\omega_0^2$  is the losses in the rotor circuit and  $\frac{1}{2} J\omega_0^2 \frac{R_1}{R_2}$  is the losses in stator circuit.

Here it is very important to notice that the kinetic energy stored in moving parts of the machine is equal to the machines' rotor winding energy loss. From the above analysis of energy loss equations, it is clear that the stator electrical losses in transient condition depend on the resistance of the rotor circuit. With the stator resistance invariable. This shows that the increase in rotor resistance causes a decrease in stator electrical losses,  $\Delta A_{str} \propto \frac{1}{R_2}$ .

### 3. RESULTS AND DISCUSSION

MATLAB/Simulink is a very useful tool for simulating and modeling IM and predicting their dynamic behavior. In this model the IM, power supply, equations and results of energy starting losses are presented in special blocks of Simulink library. This model is suitable to simulate different methods of starting and helps to conclude which one of them is the best this paper investigates the direct, multi-step, and soft starting methods.

#### 3.1. Voltage variation law

Using MATLAB/Simulink different models of induction motor are studied to investigate the energy losses in this motor, these models differ from each other just in the method of supplying voltage. In the first case voltage is supplied directly, in the second case it is supplied in multi-step rising method and in the last one it is supplied with linear rising method. In this paper is presented the last one model but the results of losses of each model is presented down in Tables 1, 2 and 3.

Figure 1 show the MATLAB/Simulink simulation of an alternating current (AC) motor model during a linear rising voltage. Figure 2 show the MATLAB/Simulink simulation results of the voltage-current power supply of an AC motor during a linear rising voltage. Figures 3 and 4 show the relationship of the induced torque and the motor speed of an AC motor during a linear rising voltage, as obtained by the simulation of the MATLAB/Simulink program. Simulation results clearly indicated that the starting current could be controlled to a value that minimizes the losses in the motor by using linear rising voltage starting

method. The results showed that after a transient condition period, the torque and the speed of the motor were close to the rated values, and the speed was changing smoothly.

Table 1. The starting current at different voltage control method

Normal starting	With multi step raising voltage	With linear raising voltage	Steady stat current, A
Voltage source, V	Starting current, A	Starting current, A	Starting current, A
A		27.6	7.4
400	61.12	26.2	6.8
380	58.00	16.5	4.3
240	36.60	15.3	3.9
220	33.50	13.7	3.5

Table 2. The electrical losses resulting from the starting current

Voltage source, V	Direct starting losses, kW	Multi-step rising losses, W	Linear rising losses, W
400	3.2	1000.0	252.0
380	2.8	964.0	226.6
240	1.8	382.5	89.9
220	1.5	328.9	74.8
200	1.3	263.7	63.0

Table 3. The electrical losses resulting from resistance control

	At $R1=0.5968 \Omega, R2=0.6258 \Omega$	
psl=1327.0	psrl=679.5	Pssl=648.0
psl=1657.0	At $R1=0.9 \Omega, R2=0.6258 \Omega$ psrl=679.5	Pssl=977.2
psl=1982.0	At $R1=1.2 \Omega, R2=0.6258 \Omega$ psrl=679.5	Pssl=1303.0
psl=1130.0	At $R1=0.5968 \Omega, R2=0.9 \Omega$ psrl=679.5	Pssl=450.0
psl=1017.0	At $R1=0.5968 \Omega, R2=1.2 \Omega$ psrl=679.5	Pssl=337.9

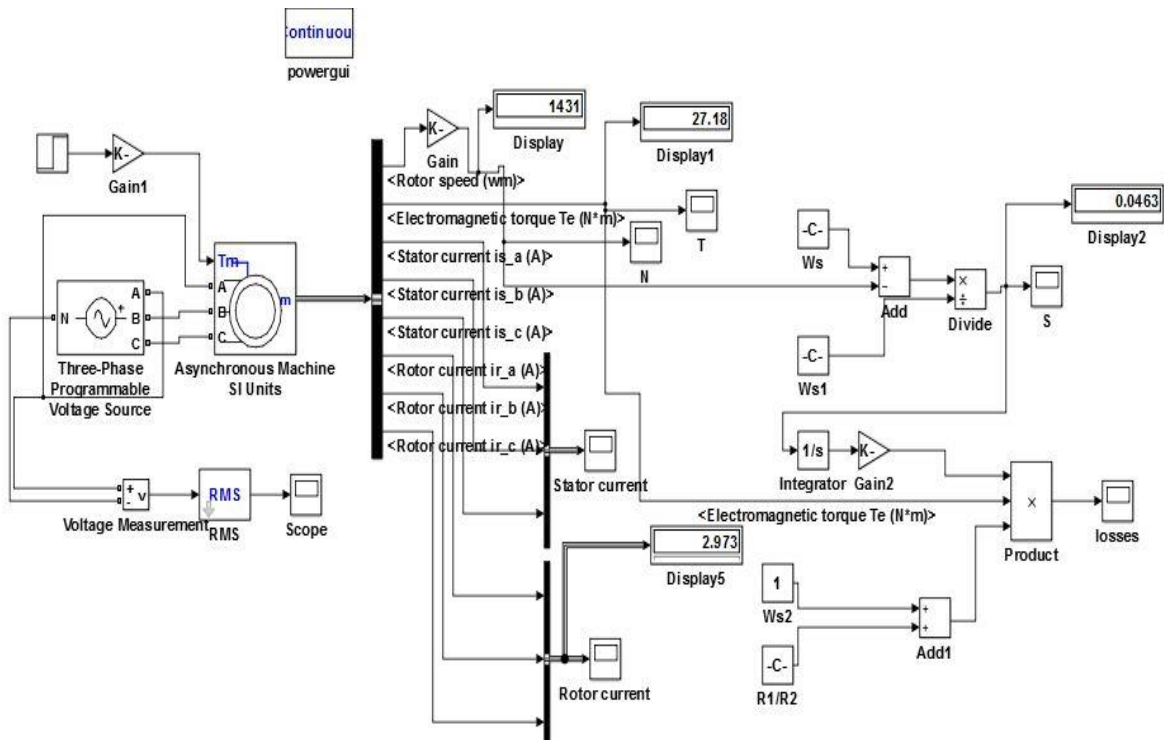

Figure 1. Soft starting Simulink model

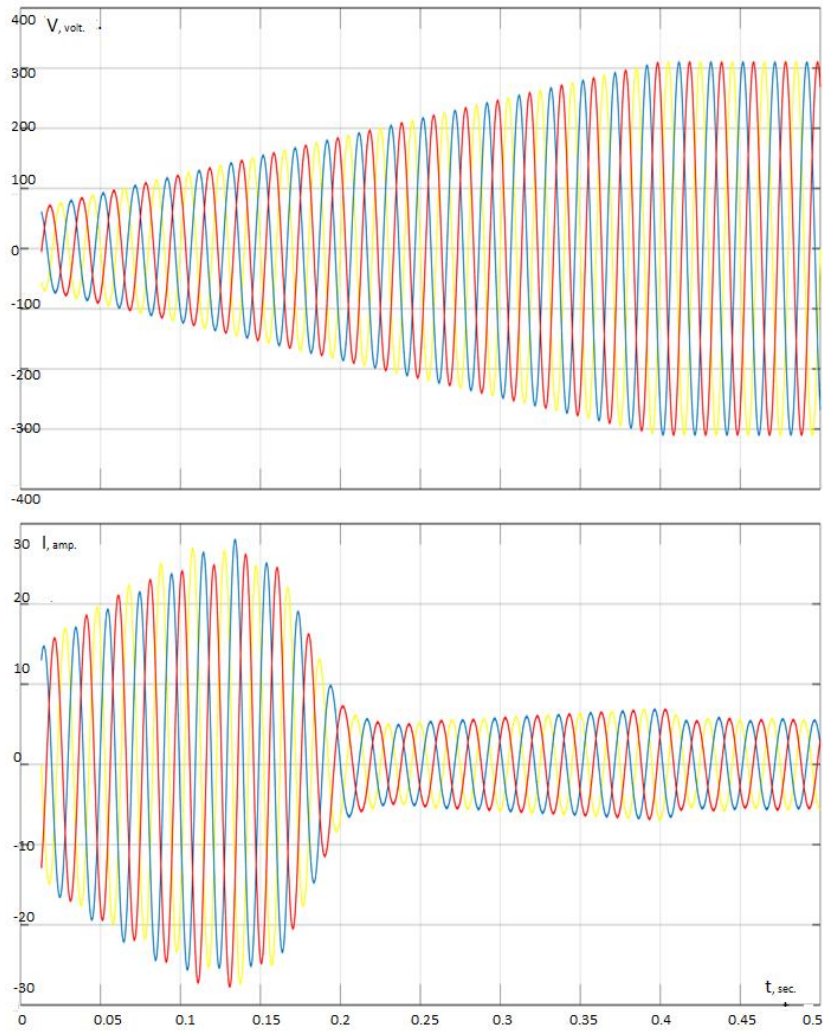

Figure 2. Soft starter, (voltage-current) characteristic

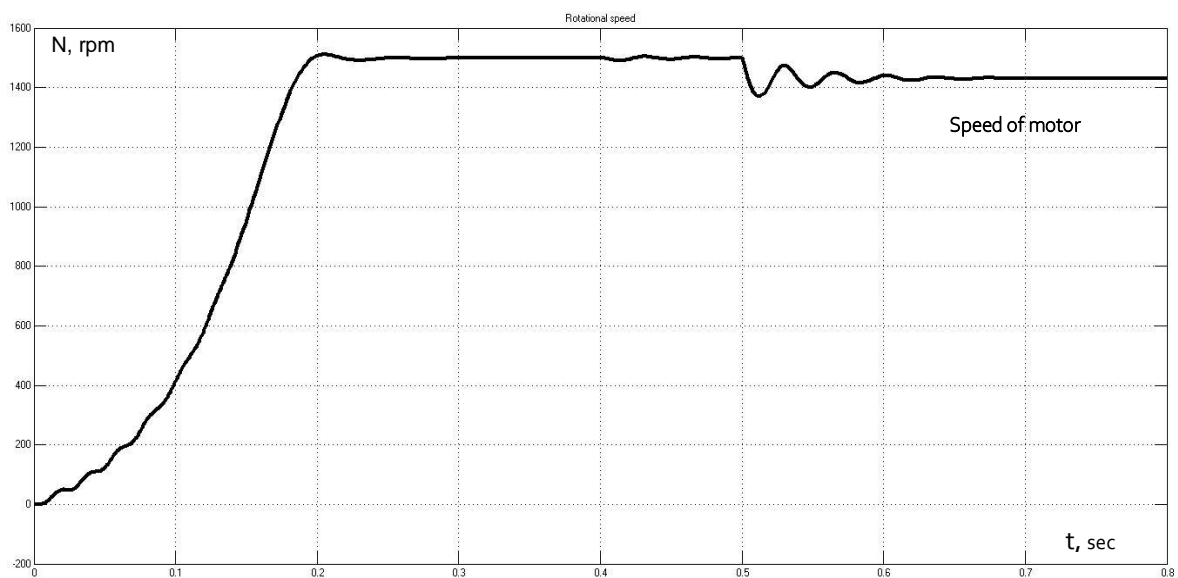

Figure 3. Soft starter, mechanical speed characteristic

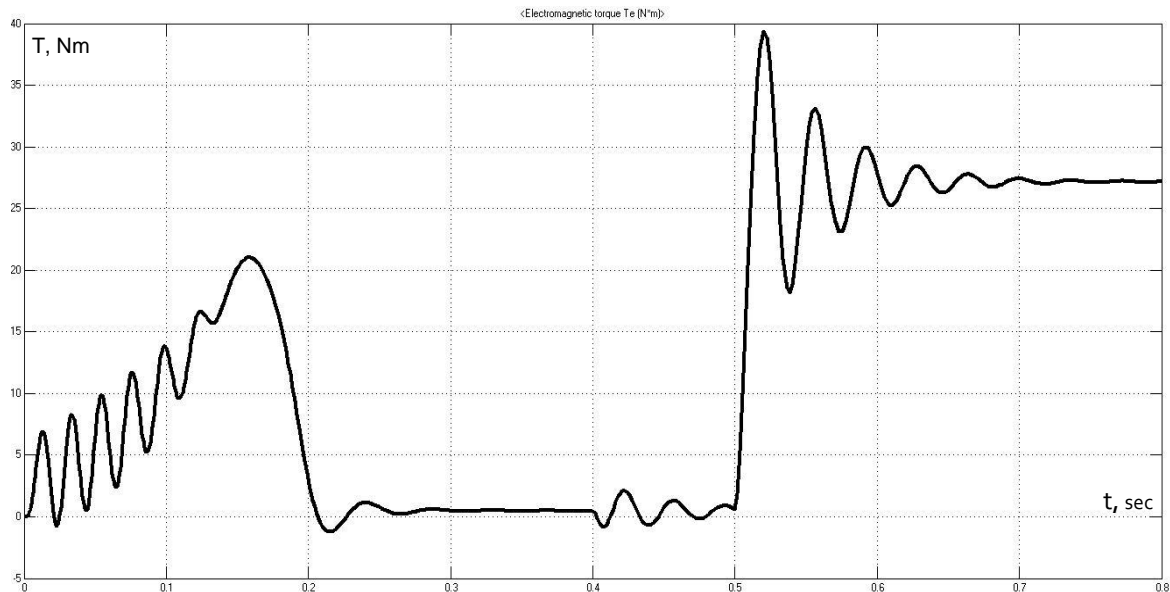

Figure 4. Soft starter, torque characteristic

#### 4. RESULTS OF ENERGY LOSS SIMULATION MODELS

##### 4.1. Starting current at different voltage control method

Table 1 shows the electrical losses of starting current by using different starting methods, direct starting, multi-step voltage law and soft starter-linear rising voltage law as a function of firing angle. From the Table 1 it is seen that the best way to decrease the starting current is by using the soft starting by which the voltage is supplied in a linear rising method. It is also seen that maximum currents are obtained in a direct starting method.

##### 4.2. Stator copper loss at a different voltage control method

As shown in the Table 2, the electrical losses resulting from the starting current will decrease. It was found from the results that the starting current decreases greatly using the soft starter-linear rising voltage law-, as changing the firing angle with time makes the current increase in a smoother manner until it reaches its rated value. It is also seen that the maximum energy losses are obtained in a direct starting method in which the rated voltage is supplied directly in one step.

##### 4.3. Results of resistance control simulation model

Table 3 shows the investigation and results of the electrical losses and their proportionality with resistors R1 and R2 and has showed the effect of using this method to reduce the electrical losses where, Pssl-steady state losses; prl-rotor windings losses and psl-stator windings losses. It is noticed from the previous results and the above equations that the electrical losses are directly proportional to R1 and inversely proportional to R2. The equations clarified that the resistors R1 and R2 did not affect the electrical losses in the rotor and displayed the inaccuracy of using this method to reduce the electrical losses, since it discards the effects of changing resistors on the speed of a rotor. However, it should be mentioned that this discard was governed by the fact that it affected the stability of motor running, knowing that the speed affects the value of electrical losses as shown in the equations.

#### 5. CONCLUSION





From the used methods to reduce electrical starting transient conditions losses, minimum losses were achieved by using Smooth starter-linear rising voltage law, the second in order in efficiency was the control method of multi-step voltage rising and the least efficient was the direct starting method. And finally, the method of stator and rotor inserting resistors was found to be useless in reducing transient condition losses. The reason the smooth starter is the best method to be used is that the voltage feeds the motor gradually, which causes the motor to take off with a small starting current, so the losses resulting from the transient states decrease significantly.

## REFERENCES

- [1] A. Y. Al-rawashdeh, "Losses reduction of induction motors operating below the nominal load," *International Journal of Electrical and Computer Sciences IJECS-IJENS*, vol. 2, no. 04, pp. 1–5, 2017.
- [2] O. Barbarawi, A. Al-Rawashdeh, and G. Qaryouti, "Simulink modelling of the transient cases of three phase induction motors," *International Journal of Electrical and Computer Sciences IJECS-IJENS*, vol. 17, no. 4, pp. 6–15, 2017.
- [3] A. Y. Al-Rawashdeh, "Investigation of an induction wound rotor motor to work as a synchronous generator," *Engineering, Technology and Applied Science Research*, vol. 9, no. 2, pp. 4071–4074, Apr. 2019, doi: 10.48084/etasr.2606.
- [4] S. Rachev, C. V. A. Drugarin, K. Karakoulidis, I. Dimitrov, and L. Dimitrov, "Study of energy losses in high-voltage induction motor electric drive," *"Eftimie Murgu" Reșița Anul XXIII*, pp. 273–282, 2016.
- [5] O. Dobzhanskyi and R. Gouws, "Study on energy losses in industrial sector caused by low actual efficiency of induction motors," in *2014 International Conference on the Eleventh industrial and Commercial Use of Energy*, Aug. 2014, pp. 1–5, doi: 10.1109/ICUE.2014.6904188.
- [6] R. Abdelati and M. F. Mimouni, "Loss minimization of induction motors in a transient regime," *Electric Power Components and Systems*, vol. 48, no. 9–10, pp. 969–988, Jun. 2020, doi: 10.1080/15325008.2020.1825547.
- [7] Y. Huangfu, S. Wang, J. Qiu, H. Zhang, G. Wang, and J. Zhu, "Transient performance analysis of induction motor using field-circuit coupled finite-element method," *IEEE Transactions on Magnetics*, vol. 50, no. 2, pp. 873–876, Feb. 2014, doi: 10.1109/TMAG.2013.2281314.
- [8] S. N. Vukosavic and E. Levi, "A method for transient torque response improvement in optimum efficiency induction motor drives," *IEEE Transactions on Energy Conversion*, vol. 18, no. 4, pp. 484–493, Dec. 2003, doi: 10.1109/TEC.2003.816599.
- [9] R. Abdelati and M. Faouzi Mimouni, "Analytical solution of optimized energy consumption of induction motor operating in transient regime," *European Journal of Control*, vol. 17, no. 4, pp. 397–411, Jan. 2011, doi: 10.3166/ejc.17.397-411.
- [10] B. Basak, "Transient behaviour of three phase induction motor under supply interruption of one phase during starting," *Indain Institute of Technology*, pp. 259–262, 2002.
- [11] E. Abeer Hawatmeh, M. AbuZalata, and A. AL-Rawashdeh, "Reduction of losses at the start-up of DC motor using the voltage amplitude variation law," *Research Journal of Applied Sciences, Engineering and Technology*, vol. 11, no. 2, pp. 190–197, Sep. 2015, doi: 10.19026/rjaset.11.1707.
- [12] A. Al-Rawashdeh, "Simulation and analysis of the possibilities of traction electric motor," *Indonesian Journal of Electrical Engineering and Computer Science (IJECS)*, vol. 14, no. 1, pp. 51–58, Apr. 2019, doi: 10.11591/ijeecs.v14.i1.pp51-58.
- [13] K. L. Shi, T. F. Chan, Y. K. Wong, and S. L. Ho, "Modelling and simulation of the three-phase induction motor using Simulink," *The International Journal of Electrical Engineering and Education*, vol. 36, no. 2, pp. 163–172, Apr. 1999, doi: 10.7227/IJEEE.36.2.6.
- [14] M. Ikeda and T. Hiya, "Simulation studies of the transients of squirrel-cage induction motors," *IEEE Transactions on Energy Conversion*, vol. 22, no. 2, pp. 233–239, Jun. 2007, doi: 10.1109/TEC.2006.874203.
- [15] S. Wade, M. W. Dunnigan, and B. W. Williams, "Modeling and simulation of induction machine vector control with rotor resistance identification," *IEEE Trans. on Power Electronics*, vol. 12, no. 3, pp. 495–506, 1997, doi: 10.1109/63.575677.
- [16] K. S. Sandhu and V. Pahwa, "Simulation study of three-phase induction motor with variations in moment of inertia," *Journal of Engineering and Applied Sciences*, vol. 4, no. 6, pp. 72–77, 2009.
- [17] S. Gupta and S. Wadhvani, "Dynamic modeling of induction motor using rotor rotating reference frame," *International Journal of Advanced Research in Electrical Electronics and Instrumentation Engineering*, vol. 3, no. 6, pp. 10132–10140, 2014.
- [18] P. H. K. Patel, "Steady state and transient performance analysis of three phase induction machine using MATLAB simulations," *RESEARCH PAPER International Journal of Recent Trends in Engineering*, vol. 1, no. 3, pp. 266–270, 2009.
- [19] M. A. Abdel-Halim, M. A. Badr, and A. I. Alolah, "Smooth starting of slip ring induction motors," *IEEE Transactions on Energy Conversion*, vol. 12, no. 4, pp. 317–322, 1997, doi: 10.1109/60.638867.
- [20] O. Al-barbarawi and G. M. Qaryouti, "Implementation simulink modeling to analysis the transient cases and torque speed characteristic in a three phase induction motors," *Indonesian Journal of Electrical Engineering and Computer Science (IJECS)*, vol. 16, no. 3, pp. 1077–1087, Dec. 2019, doi: 10.11591/ijeecs.v16.i3.pp1077-1087.
- [21] A. N. Abdullah and M. H. Ali, "Direct torque control of IM using PID controller," *International Journal of Electrical and Computer Engineering (IJECE)*, vol. 10, no. 1, pp. 617–625, Feb. 2020, doi: 10.11591/ijece.v10i1.pp617-625.
- [22] A. J. Ali, L. A. Khalaf, and A. H. Ahmed, "Modeling and simulation of a 3- $\phi$  induction motor based on two types of WFA," *International Journal of Electrical and Computer Engineering (IJECE)*, vol. 11, no. 2, pp. 1105–1113, Apr. 2021, doi: 10.11591/ijece.v11i2.pp1105-1113.
- [23] B. Chetate and A. Kheldoun, "A method of minimizing the power losses in an induction motor with a squirrel-cage with vector control," *Electrical Technology Russia*, no. 4, pp. 154–165, 2004.
- [24] A. Kheldoun and B. Chetate, "Model based minimisation of power loss in vector control induction motor," in *2nd International Symposium on Electrical, Electronic and Computer Engineering and Exhibition*, 2004, pp. 112–117.
- [25] D. Mehdi and S. Lassaad, "Losses minimisation in an induction motor," in *2009 3rd International Conference on Signals, Circuits and Systems (SCS)*, Nov. 2009, pp. 1–6, doi: 10.1109/ICSCS.2009.5412525.



## BIOGRAPHIES OF AUTHORS



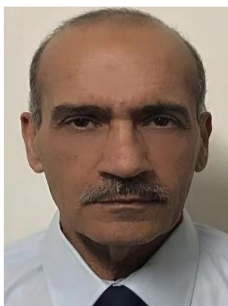

**Ayman Y. Al-Rawashdeh**     Mechatronics Engineering was born on 01 January 1970 in Jordan. He obtained his Diploma degree in 1995 and PhD degree in 2008 in the field of Mechatronics Engineering. Currently, Dr. Al-Rawashdeh is an Associate Professor at the Department of Electrical Engineering, Faculty of Engineering Technology, Al-Balqa Applied University, Jordan. His main research interests include renewable energy, drive system analysis and simulations. He can be contacted at email: Dr.ayman.rawashdeh@bau.edu.jo.







**Ali Dalabeeh**    obtained his bachelor's degree in electrical power engineering in 1981 from Aleppo University/Engineering College/Syria, and in 1988, he received his Ph. D in electrical engineering from Moscow Power Institute. He is currently an Associate Professor at the Department of Electrical Engineering, Faculty of Engineering Technology, Al-Balqa Applied University, Jordan. Renewable energy, energy efficiency, and deregulation in electrical power systems are among his research interests. He can be contacted at email: alidalabeeh@bau.edu.jo.





**Ashraf Samarah**    was born in Irbid, Jordan, on September 29, 1980. He received B.Sc. degree in 2003, M.Sc. degree in Communications and Electronic engineering with honors from Jordan University of Science and Technology (JUST) in 2003, and a Ph.D. degree in Electrical Energy Engineering, from the University of Siegen, Siegen, Germany, in 2012, respectively. He has worked in the area of photovoltaic energy systems and electrical signals during the last ten years. He can be contacted at email: samarah@bau.edu.jo.



**Abdallah Ershoud Al-Zyoud**    is an Associate Professor at the Department of Electrical Engineering, Faculty of Engineering Technology, Al-Balqa Applied University, Jordan. He received his Ph.D in Electrical Power Engineering from Kiev Polytechnic Institute, 1992. His research interests include renewable energy and power system protection. He can be contacted at email: alzyoud\_a@bau.edu.jo.



**Khalaf Y. Al Zyoud**    High Voltage Engineering and Transformers. He graduated in 1998 from Technical University of Lodz- Poland. He is currently an Associate Professor at the Department of Electrical Engineering, Faculty of Engineering Technology, Al-Balqa Applied University, Jordan. His main researches interests include power transformers and high voltage engineering and their Diagnoses. He can be contacted at email: kalaf.zyoud@bau.edu.jo.