

## Design and simulation of DC distributed power supply with power balance control technique

Uthen Kamnarn<sup>1</sup>, Jedsada Yodwong<sup>2</sup>, Pratch Piyawongwisal<sup>3</sup>, Pakawadee Wutthiwai<sup>1</sup>, Anon Namin<sup>1</sup>, Phatiphat Thounthong<sup>4</sup>, Nouredine Takorabet<sup>5</sup>

<sup>1</sup>Department of Electrical Engineering, Rajamangala University of Technology Lanna, Chiang Mai, Thailand

<sup>2</sup>mu Space and Advanced Technology Company Limited, Bangkok, Thailand

<sup>3</sup>Department of Computer Engineering, Rajamangala University of Technology Lanna, Chiang Mai, Thailand

<sup>4</sup>Renewable Energy Research Centre (RERC), Department of Teacher Training in Electrical Engineering, Faculty of Technical Education, King Mongkut's University of Technology North Bangkok, Bangkok, Thailand

<sup>5</sup>Groupe de Recherche en Energie Electrique de Nancy, Université de Lorraine, Nancy, France

### Article Info

#### Article history:

Received Aug 28, 2021

Revised Jan 31, 2022

Accepted Feb 7, 2022

#### Keywords:

DC distributed power supply  
Power balance control  
Technique average small-signal  
method  
MATLAB/Simulink  
simulation

### ABSTRACT

This paper presents the analysis, design and simulation of DC distributed power supply controlled with power and energy balance control technique. The proposed system consists of 5 connection structures of DC to DC converters which are parallel, cascade, source splitting, load splitting, and stack. The system mathematical model is analyzed by the average small-signal method. The proposed power balance control technique is used in the instance where the main sources supply the load of the system. The energy balance control technique is used in the case that the load at the 24 V and 12 V bus is backed up with a battery. The DC Distributed system is simulated by MATLAB/Simulink. The system has 1 kW power rating and contains 6 voltage bus with voltage ratings of 380, 100, 60, 48, 24, and 12 V. The simulation results show that, with the proposed power balance design and control technique, the system provides good dynamic responses and stability. In addition, the proposed technique simplifies the parameter design of the PI controller and solves the basic control limitations of the DC to DC converter.

*This is an open access article under the [CC BY-SA](https://creativecommons.org/licenses/by-sa/4.0/) license.*



### Corresponding Author:

Uthen Kamnarn

Department of Electrical Engineering, Rajamangala University of Technology Lanna  
128 Huay Kaew Road, Tambon Chang Phueak, Muang, Chiang Mai 50300, Thailand

Email: Uthen@rmutl.ac.th

## 1. INTRODUCTION

From the 1960s, semiconductor technology development started and led to the development of power electronics converters (PECs), which improved the efficiency of DC power systems. As new technologies continue to emerge, power electronic converters have been continuously improved in terms of efficiency, reliability, cost, and size, to the point where DC distribution systems now demonstrate better efficiency than AC distribution systems [1]. For this reason, many facilities nowadays are designed to be more adequate for DC distribution systems, where many organizations accepted distributed bus voltage rating is 380 Vdc attributable to high efficiency, reasonable cost, and high reliability [2]. Numerous industry standards such as eMerge Alliance, the International Electrotechnical Commission (IEC), the Society of Cable Telecommunications Engineers (SCTE), the Alliance for Telecommunications Industry Solutions (ATIS), Underwriters Laboratories (UL), the formation of the International Telegraph Union-Telecommunication Standardization Sector (ITU-T), European Telecommunications Standards Institute

(ETSI), the National Electrical Manufacturers Association (NEMA), and the National Electrical Code (NEC) have been working on standards related to 380 Vdc and a few industry standards are under development and some have already been established. Companies such as ABB Ltd., Emerson Electric Co., Hewlett-Packard Development Company (HP), Starline Inc., Schneider Electric Company, and GVA Lighting Inc., have started manufacturing appliances that are compatible with DC distribution systems with 380 Vdc distributed power bus and gaining popularity among telecom and data centers, and could also be used for commercial or residential buildings on a larger scale in the future [3]. In such systems, the control method of the converter circuit is crucial in ensuring stability, performance, reliability, and good response. Recent works suggested that effective control design can be achieved using current mode control and voltage mode control. However, such controls have downsides in terms of stability, performance, design complexity, including limitations caused by the non-minimum phase issue [4]–[7]. To overcome these limitations, various control techniques have been researched and developed [8]–[20] however, these control techniques are complicated in design and implementation. To solve the problems, the power balance control technique and energy balance control technique, which produce simpler control design and better performance compared to the regular voltage and current mode control, have been developed [21]–[25].

This paper aims to design, analyze and simulate the DC distribution system in all possible connection structures (i.e., parallel, cascade, source splitting, load splitting, and stack) using power and energy balance control techniques to improve the performance of systems that are connected in various voltage bus structures in DC distribution systems. The proposed system has a total power rating of 1 kW and contains 6 voltage buses with voltage ratings of 380, 100, 60, 48, 24, and 12 V. The simulation is done with MATLAB/Simulink.

## 2. METHOD

The proposed DC distributed system shown in Figure 1 consists of 3 main parts: flyback #1-5, buck #1-4, and a bidirectional converter. The power balance equation of the system is:

$$\sum_{i=1}^{N=3} [V_{in_i} I_{L_N} k_{B_N}] = \left\{ [I_{o_{1,2}} (V_{o_1} + V_{o_2})] + V_{o_3} I_{o_3} \right\} - P_{load_1} = V_{in_{4,5}} (I_{L_4} k_{B_4} + I_{L_5} k_{B_5}) = [V_{o_{4,5}} (I_{o_4} + I_{o_5})] - P_{load_2}$$

$$= V_{in_{6,7,8}} (I_{L_6} k_{B_6} + I_{L_7} k_{B_7} + I_{L_8} k_{B_8}) = (V_{o_6} I_{o_6} - P_{load_6}) + (V_{o_7} I_{o_7} - P_{load_7}) + (V_{o_8} I_{o_8} - P_{load_8}) \quad (1)$$

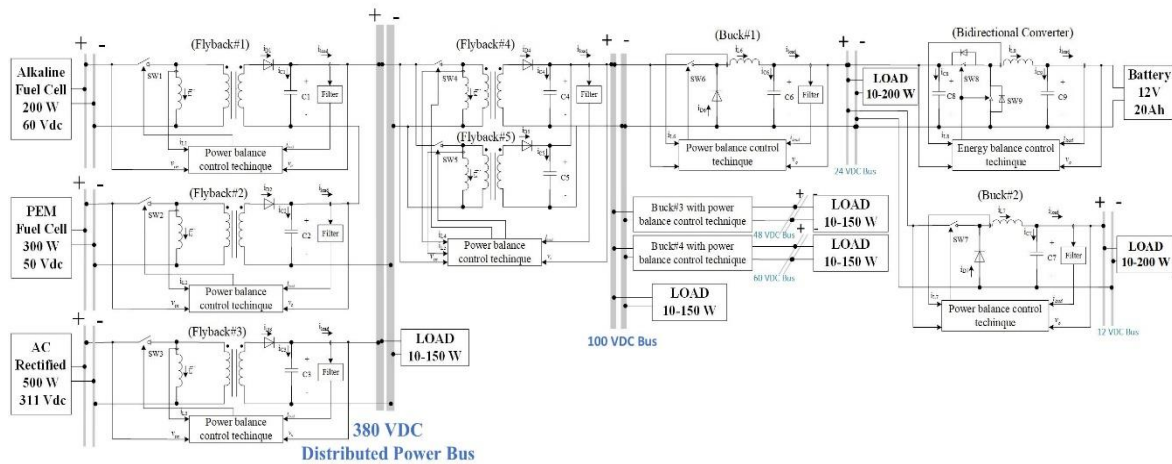

Figure 1. The proposed 1 kW distribution system

### 2.1. Design consideration

The systems with power balance control technique are shown in Figures 2 (a)-(c) shows the bidirectional converter designed to work in continuous current mode (CCM). The inductance value of buck converter is:

$$L_{min} = \frac{(1-D)R}{2f_{sw}} \quad (2)$$

where  $L_{\min}$  is the minimum inductance value,  $D$  is the duty cycle,  $R$  is the output impedance,  $f_{sw}$  is switching frequency.  $\Delta V_o$  is output voltage ripple. The capacitance value for the output capacitor of a buck converter is:

$$C = \frac{1-D}{8L(\Delta V_o/V_o) f_{sw}^2} \tag{3}$$

For the flyback converter, the minimum inductance is:

$$L_{\min} = \left( \frac{(1-D)^2 R}{2f_{sw}} \right) \left( \frac{N_1}{N_2} \right)^2 \tag{4}$$

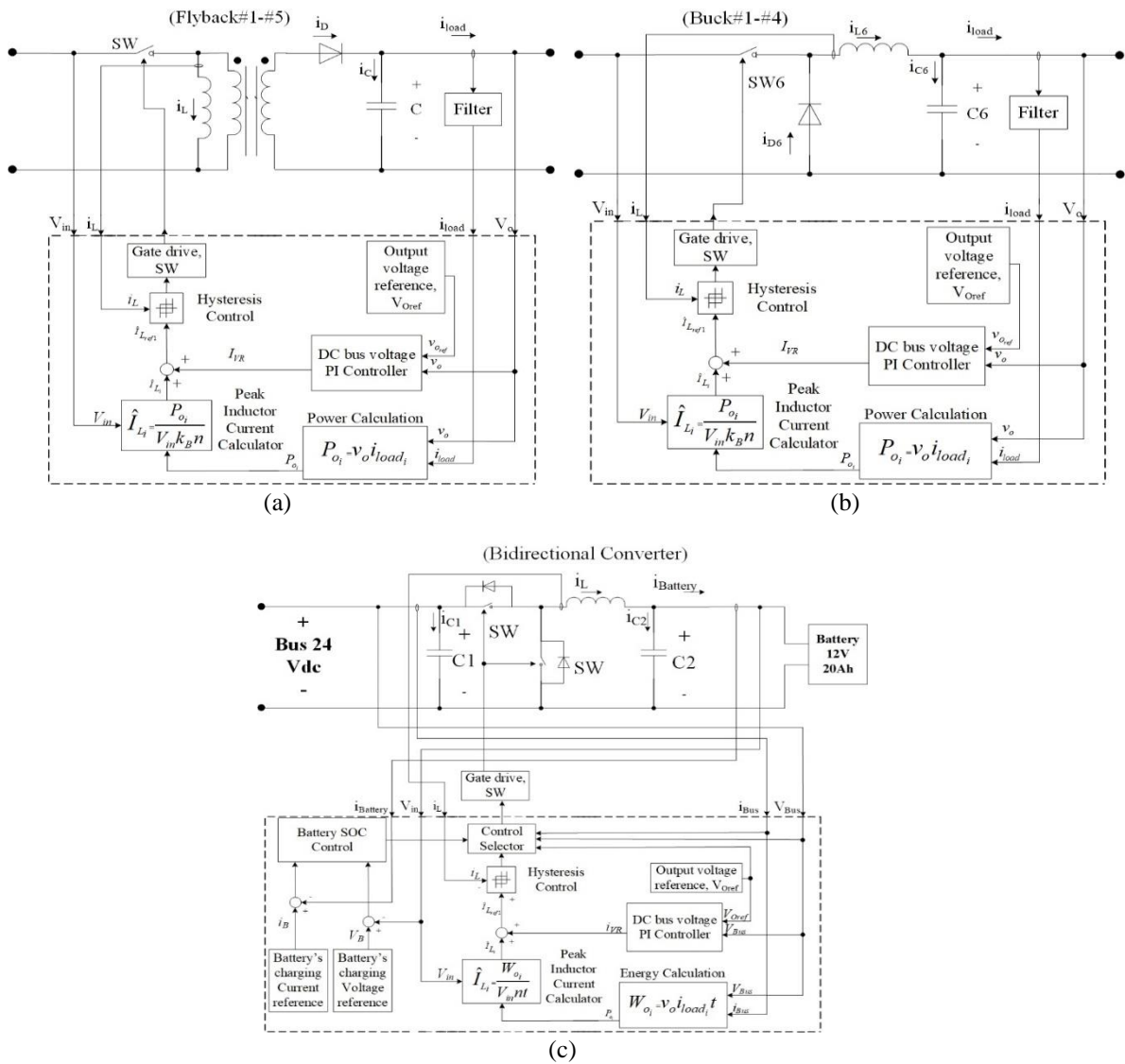

Figure 2. Converters with power balance control technique (a) flyback converter, (b) buck converter, and (c) bidirectional converter

The output capacitance of the flyback converter is:

$$C = \frac{D}{R \cdot f_{sw} \left( \frac{\Delta V_o}{V_o} \right)} \tag{5}$$

The mathematical model of the modules in the system has been derived to simulate and study the dynamic response obtained from MATLAB/Simulink, as well as to analyze the compatibility for connecting the modules in all proposed connection structures in the DC distributed power supply. If  $u = 1$  is the ON state of the switching,  $u = 0$  is the OFF state of the switching, and  $1 - u = \bar{u}$ , the inductor current equation of the flyback converter is:

$$i_L(s) = \frac{1}{sL} \left[ uV_{in}(s) - \bar{u}V_o(s) \left( \frac{N_1}{N_2} \right) \right] \quad (6)$$

The output capacitor voltage equation of the flyback converter is:

$$V_C(s) = \frac{1}{sC} \left[ \bar{u}I_L(s) \left( \frac{N_1}{N_2} \right) - I_R(s) \right] \quad (7)$$

The inductor current equation of the buck converter is:

$$I_L(s) = \frac{1}{sL} [uV_{in}(s) - V_o(s)] \quad (8)$$

The output capacitor voltage equation of the buck converter is:

$$V_C(s) = \frac{1}{sC} [I_L(s) - I_R(s)] \quad (9)$$

## 2.2. Average small signal analysis

The proposed system control technique is based on the idea of power balance, which states that the input and output power of the system is equal. Suppose that the system is lossless, thus, the average small-signal model of the power balance equations of buck and flyback converters can be obtained as follows:

For load splitting, and normal structure:

$$V_{in} k_B I_L = \sum_{i=1} V_{o_i} I_{o_i} \quad (10)$$

For source splitting, and paralleling:

$$\sum_{i=1} V_{in_i} k_{B_i} I_{L_i} = \frac{V_o I_{load}}{N} \quad (11)$$

where  $V_{in}$  is the input voltage,  $V_o$  is the output voltage,  $I_L$  is inductor current,  $I_{load}$  is load current,  $N$  is a number of output bus parallel-connected modules, and  $k_B$  is the duty cycle, which is considered as loop gain.

From the power balance equations, the reference inductor current equation can be determined by the inductor current calculator.  $i_{PBC}$  is the inductor current that is calculated based on load current, output voltage, input voltage, and the number of paralleled modules  $N$ . The peak value of  $i_{PBC}$  can be derived as:

$$i_{PBC} k_B V_{in} = \frac{V_o i_{load}}{N} \quad (12)$$

where  $i_{L_{ref}}$  is the value of the inductor current,  $i_{VR}$  is the correcting signal of the PI controller,  $i_{PBC}$  is the peak value of the inductor reference current. The peak value of the inductor current is:

$$i_{L_{ref}} = i_{PBC} + i_{VR} \quad (13)$$

The dynamic equation of the output voltage is:

$$\sum_{i=1}^N i_{Li} = C \frac{dv_o}{dt} + i_{load} \tag{14}$$

Performing the perturbations and small-signal approximation in (10) to (14) yields:

$$G_{V_{in}} = \frac{k_B n I_{ref}}{V_o}, G_k = \frac{k_B n V_{in}}{V_o}, G_z = \frac{I_o}{V_o k_B n}, F_{load} = \frac{V_o}{k_B n V_{in}}, F_{V_o} = \frac{I_{load}}{k_B n V_{in}}, F_{V_{in}} = \frac{V_o I_{load}}{V_{in}^2}$$

The output current, the peak value of the inductor reference current, and output inductance can be expressed as:

$$\tilde{i}_o = G_{V_{in}} \tilde{v}_{in} + G_k \tilde{i}_{ref} - G_z \tilde{v}_o \tag{15}$$

$$\tilde{i}_{PBC} = +F_{load} \tilde{i}_{load} - F_{V_o} \tilde{v}_o + F_{V_{in}} \tilde{v}_{in} \tag{16}$$

$$Z_L(S) = \frac{1}{CS} = \frac{\tilde{v}_o}{\tilde{i}_o - \tilde{i}_{load}} \tag{17}$$

From (15) to (17) and the output voltage equation can be written as a block diagram as shown in Figure 3. From Figure 3, applying Mason's gain method, the output voltage loop can be shown in Figure 4. The power balance control technique consisted of an inductor current calculation block and PI controller. The output voltage will be compared with the desired reference voltage. The inductor current calculation block computes the reference input current. Then, the error signal will be compensated by the proposed PI controller. Then, the output summation signal will be compared with the input inductor current. Finally, the result command signal will be processed by pulse width modulation (PWM) or hysteresis current control, generating the signal to the gate drive circuit to control the switch. The proposed control technique can be simply implemented by analog and digital circuits.

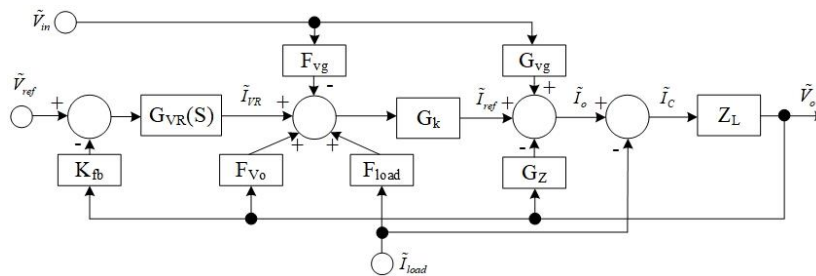

Figure 3. Block diagram of a converter in the proposed system with power balance control technique

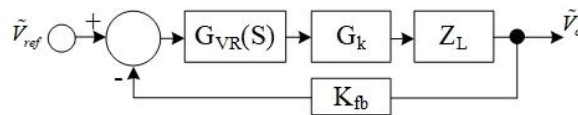

Figure 4. Block diagram of the output voltage loop

Where  $G_{VR}$  is the PI controller and  $k_{fb}$  is the feedback gain, the output voltage can be expressed as:

$$\frac{\tilde{V}_o}{\tilde{V}_{ref}} = \frac{G_{VR} k_B n V_{in}}{V_o C S + G_{VR} k_B n V_{in} k_{fb}} \tag{18}$$

The open-loop transfer function (OLTF) of the output voltage can be expressed as:

$$OLTF = \frac{V_{in} k_{fb}}{V_o CS} \tag{19}$$

### 2.3. Control strategy

The control strategy requires a feedback compensation process to regulate the output voltage over the output load variation and input voltage. The frequency gain and location of the zero must be selected for the compensation network, the steady-state error of the output voltage should also be as small as possible. From the proposed system output voltage transfer functions can investigate using Bode diagrams to get the desired frequency and phase shift. The equation of PI controller for voltage regulation is:

$$G_{VR}(s) = K_c + \frac{\omega_z}{S} \tag{20}$$

Figures 5 and 6 show the Bode diagrams of the proposed system’s output voltage, the PI controllers, and open-loop transfer functions. Each part has about 85-90 degrees of phase margin, enough to stabilize the system.

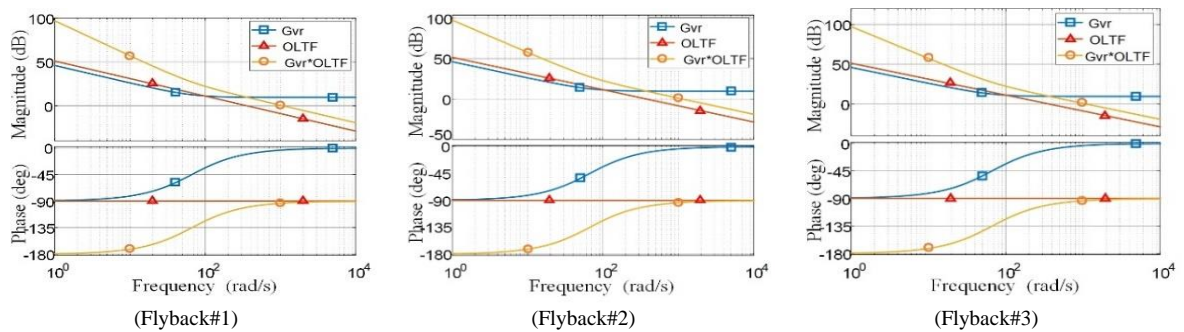

Figure 5. Bode diagrams of the proposed systems (380 Vdc bus)

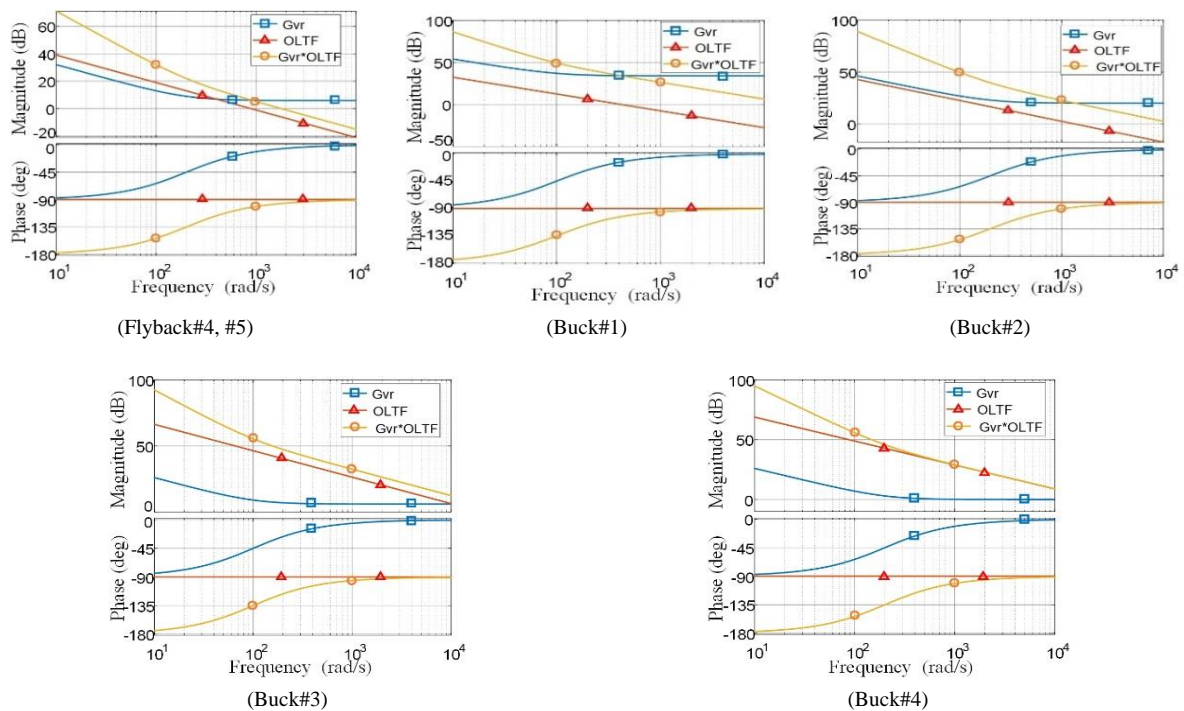

Figure 6. Bode diagrams of the proposed systems (100, 60, 48, 24, and 12 Vdc bus)

### 3. RESULTS AND DISCUSSION

Figure 7 shows the simulation results of the proposed system. The transient response effectiveness of the system is investigated by MATLAB/Simulink to verify the control algorithm and evaluate the performance of the system, using the calculated specification shown in Table 1. Figure 7 (a) shows the responses of bus voltage and load current at the 380 V, 100 V, 60 V, 48 V, 24 V, and 12 V bus. Figure 7 (b) shows the state of charge, current, and voltage of the battery. From 0-0.1s, the system initialization starts and has full load at 100% as designed. At 0.1s, a sudden step down of the system's load from 100% (1 kW) to 10% (100 W) occurs. At 0.2s, a sudden step up of the system's load from 10% (100 W) to 100% (1 kW) occurs. Then, at 0.3s, a sudden cut off of the system main sources occurs, then the bidirectional converter with energy balance control technique connected to the battery maintains the stability of the voltage at the 24 V and 12 V bus. Then, at 0.4s and 0.5s are sudden step down from 100% (400 W) to 10% (40 W) and step up from 10% (40 W) to 100% (400 W) of the load. The simulation results demonstrated the stability, reliability, and fast dynamic responses of the systems with the proposed control technique.

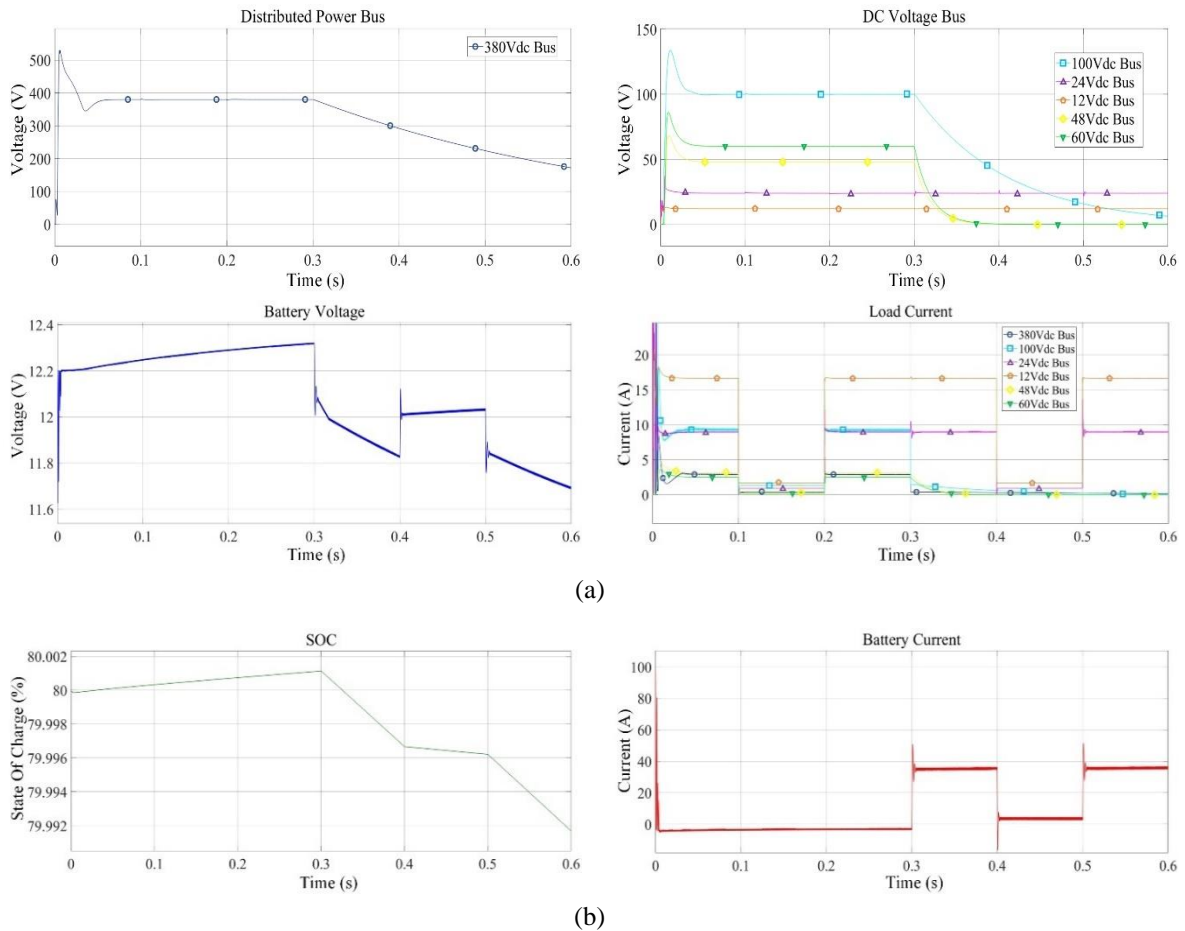

Figure 7. Simulation results (a) bus voltage and current and (b) battery state of charge (SOC), current, and voltage

Table 1. Design results

Parameter	Value							
	Flyback#1	Flyback#2	Flyback#3	Flyback#4-5	Buck#1	Buck#2	Buck#3	Buck#4
Input voltage, $V_{in}$	60 V	50 V	311 V	380 V	100 V	24 V	100 V	100 V
Output voltage	200 V	180 V	380 V	100 V	24 V	12 V	48 V	60 V
Inductance	666 $\mu$ H	479 $\mu$ H	9.14 mH	195.90 $\mu$ H	136.80 $\mu$ H	25.5 $\mu$ H	3.8 mH	4.5 mH
Output capacitance	480 $\mu$ F	600 $\mu$ F	150 $\mu$ F	1600 $\mu$ F	800 $\mu$ F	1200 $\mu$ F	1300 $\mu$ F	800 $\mu$ F
Output voltage ripple	0.5 %	0.5 %	0.5 %	0.5 %	0.5 %	0.5 %	0.5 %	0.5 %
Switching frequency	20 kHz	20 kHz	20 kHz	20 kHz	20 kHz	20 kHz	20 kHz	20 kHz
Total output power	200 W	300 W	500 W	850 W	400 W	200 W	150 W	150 W
$K_C, \omega_z$ of the PI controller	8, 800	8, 800	8, 800	4, 400	50, 5000	10, 2000	4, 400	4, 400

#### 4. CONCLUSION

This work presents the design and simulation of distributed power supply in DC architecture with power and energy balance control technique for the proposed 1 kW distribution system that contains 6 voltage bus with voltage ratings of 380, 100, 60, 48, 24, and 12 V, consisted of 5 connection structures. The proposed average small-signal analysis and control technique is able to simplify the parameters design of the PI controller and solve the basic control limitations of the DC-to-DC converters. The system has been simulated by MATLAB/Simulink in various scenarios including normal operation with full load, operation with sudden load change including step down from 100% to 10% at 0.1s and 0.4s. Step up from 10% to 100% at 0.2s and 0.5s. And in the event that the main sources stopped supplying power to the system at 0.3s, the battery started to supply the energy to maintain the 24 V and 12 Vdc bus voltage with the energy balance control technique. The simulation results demonstrate stable system stability and dynamic response. The proposed technique can also reduce the size of the output capacitor due to the reduction of output voltage ripple in the steady state, resulting in the increase of the power density of the system. The results from this work can be applied to DC distribution systems that are likely to become prevalent in the future.

#### ACKNOWLEDGEMENTS

This work was supported in part by an International Research Partnership “Electrical Engineering – Thai French Research Center (EE-TFRC)” under the project framework of the Lorraine Université d'Excellence (LUE) in cooperation between Université de Lorraine and King Mongkut's University of Technology North Bangkok and in part by the National Research Council of Thailand (NRCT) under Senior Research Scholar Program under Grant No. N42A640328, and in part by National Science, Research and Innovation Fund (NSRF) under King Mongkut's University of Technology North Bangkok under Grant no. KMUTNB-FF-65-20.

#### REFERENCES





- [1] V. A. Prabhala, B. P. Baddipadiga, P. Fajri and M. Ferdowsi, “An Overview of Direct Current Distribution System Architectures & Benefits,” *Energies*, doi: 11. 2463. 10.3390/en11092463.
- [2] V. A. K. Prabhala, B. P. Baddipadiga and M. Ferdowsi, “DC distribution systems—An overview,” in *Proc. IEEE Int. Conf. Renewable Energy Research and Application (ICRERA)*, Milwaukee, WI, USA, Oct. 2014.
- [3] Sonia Moussa, Manel Jebali-Ben Ghorbal, Ilhem Slama-Belkhdja, “Bus voltage level choice for standalone residential DC nanogrid,” *Sustainable Cities and Society*, Vol. 46, 2019.
- [4] T. Dragičević *et al.*, “DC Microgrids—Part I: A Review of Control Strategies and Stabilization Techniques,” in *IEEE Transactions on Power Electronics*, vol. 31, no. 7, pp. 4876-4891, July 2016, doi: 10.1109/TPEL.2015.2478859.
- [5] L. Xu and D. Chen, “Control and Operation of a DC Microgrid With Variable Generation and Energy Storage,” in *IEEE Transactions on Power Delivery*, vol. 26, no. 4, pp. 2513-2522, Oct. 2011, doi: 10.1109/TPWRD.2011.2158456.
- [6] T. Kawakami, “Power Balance Mode Control for Boost-Type DC-DC Converter,” in *Control Theory in Engineering, IntechOpen*, 2018, doi: 10.5772/intechopen.82787.
- [7] A. Davoudi, and J. Jatskevich, “Realization of Parasitics in State-Space Average-Value Modeling of PWM DC-DC Converters,” *IEEE Trans. Power Electronics*, vol. 21, no. 4, pp. 1142-1147, July 2006.
- [8] V. A. K. Prabhala *et al.*, “A DC-DC Converter With High Voltage Gain and Two Input Boost Stages,” in *IEEE Transactions on Power Electronics*, vol. 31, no. 6, pp. 4206-4215, June 2016, doi: 10.1109/TPEL.2015.2476377.
- [9] M. Z. Zulkifli *et al.*, “Simple control scheme buck-boost DC-DC converter for standalone PV application system,” *Pow. Elec. & Dri. Syst. (IJPEDS)*, vol. 10, no. 2, pp. 1090-1101, June 2019, doi: 10.11591/ijpeds.v10.i2.pp1090-1101.
- [10] H. K. Khleaf, A. K. Nahar, and A. S. Jabbar, “Intelligent control of DC-DC converter based on PID-neural network,” *Int. J. Pow. Elec. & Dri. Syst. (IJPEDS)*, vol. 10, no. 4, pp. 2254-2262, Dec. 2019, doi: 10.11591/ijpeds.v10.i4.pp2254-2262.
- [11] S. Narasimha, Surender Reddy Salkuti., “Design and operation of closed-loop triple-deck buck-boost converter with high gain soft switching,” *Int. J. Pow. Elec. & Dri. Syst.*, vol. 11, no. 1, pp. 523-529, Mar. 2020, doi: 10.11591/ijpeds.v11.i1.pp523-529.
- [12] Aseem K. and S. Kumar S., “Closed loop control of DC-DC converters using PID and FOPID controllers,” *Int. J. Pow. Elec. & Dri. Syst. (IJPEDS)*, vol. 11, no.3, pp. 1323-1332, Sep. 2020, doi: 10.11591/ijpeds.v11.i3.pp1323-1332.
- [13] H. Kakigano, Y. Miura and T. Ise, “Distribution Voltage Control for DC Microgrids Using Fuzzy Control and Gain-Scheduling Technique,” *IEEE Trans. on Power Electronics*, vol. 28, no. 5, pp. 2246-2258, May 2013, doi: 10.1109/TPEL.2012.2217353.
- [14] F. Zhang and Y. Yan, “Novel Forward-Flyback Hybrid Bidirectional DC-DC Converter,” in *IEEE Transactions on Industrial Electronics*, vol. 56, no. 5, pp. 1578-1584, May 2009, doi: 10.1109/TIE.2008.2009561.
- [15] S. Pugliese *et al.*, “A New Voltage Balancing Technique for a Three-Stage Modular Smart Transformer Interfacing a DC Multibus,” *IEEE Trans. on Power Electronics*, vol. 34, no. 3, pp. 2829-2840, March 2019, doi: 10.1109/TPEL.2018.2840961.
- [16] R. Wai, C. Lin and B. Chen, “High-Efficiency DC-DC Converter With Two Input Power Sources,” *IEEE Trans. on Power Electronics*, vol. 27, no. 4, pp. 1862-1875, April 2012, doi: 10.1109/TPEL.2011.2170222.
- [17] B. Tamyurek and B. Kirimer, “An Interleaved High-Power Flyback Inverter for Photovoltaic Applications,” in *IEEE Transactions on Power Electronics*, vol. 30, no. 6, pp. 3228-3241, June 2015, doi: 10.1109/TPEL.2014.2332503.
- [18] D. Sattianadan *et al.*, “Investigation of low voltage DC microgrid using sliding mode control,” *International Journal of Power Electronics and Drive Systems (IJPEDS)*, Vol.11, No.4, pp. 2030-2037, Dec. 2020, doi: 10.11591/ijpeds.v11.i4.pp2030-2037
- [19] H. Ma Almgotir *et al.*, “Harmonics elimination for DC/DC power supply based on piezoelectric filters,” *Int. J. Pow. Elec. & Dri. Syst. (IJPEDS)*, Vol.12, No.1, pp. 356-363, Mar. 2021, doi: 10.11591/ijpeds.v12.i1.pp356-363
- [20] T. H. Chen, W. L. Lin and C. M. Liaw, “Dynamic modeling and controller design of flyback converter,” in *IEEE Transactions on Aerospace and Electronic Systems*, vol. 35, no. 4, pp. 1230-1239, Oct. 1999, doi: 10.1109/7.805441.







- [21] J. Yodwong and U. Kamnarn, "Analysis and Design of Distributed Power Supply in DC Architecture for Residential with Power Balance Control Technique," in *Proc. SICE Annual Conf. 2020*, Chiang Mai, Thailand, 2020, pp. 786-791.
- [22] U. Kamnarn and V. Chunkag, "Paralleling three-phase AC to DC converter using CUK rectifier modules based on power balance control technique," *Power Electronics*, IET2010, vol. 3, no. 4, pp. 511–524, 2010.
- [23] U. Kamnarn, V. Chunkag, and Y. Kanthaphayao, "The Parallel Operation Control of a Modular AC to DC Converter via Serial Communication Bus," *IEEJ Trans. on Electrical and Electronic Engineering*, vol. 8, no. 1, pp. 78-86, 2013.
- [24] U. Kamnarn, V. Chunkag, "Power balance control technique of the modular three-phase ac to dc converter with fast transient response," *ScienceDirect*, vol. 77, no. 12, pp. 1585-1594, Oct. 2007.
- [25] U. Kamnarn and V. Chunkag, "Analysis and design of a Parallel CUK Power Factor Correction Circuit Based on Power Balance Control Technique," *IEEJ Trans. Industry Applications*, vol. 126, no. 5, pp. 533-540, 2006.

## BIOGRAPHIES OF AUTHORS







**Uthen Kamnarn**     is an Assoc. Prof. in the Department of Electrical Engineering, Rajamangala University of Technology Lanna (RMUTL), Chiang Mai, Thailand. He received the B.Eng. in Electrical Engineering from the Rajamangala Institute of Technology (RIT), Thanyaburi, Pathum Thani, Thailand, in 1996, his M.Eng. and Ph.D. in Electrical Engineering from King Mongkut's Institute of Technology North Bangkok (KMITNB), Thailand, in 2002 and 2007, respectively. His main research interests include the field of power electronic circuits and control, power factor correction, distributed power systems, and harmonics on power systems. He can be contacted at email: [Uthen@rmutl.ac.th](mailto:Uthen@rmutl.ac.th) [be\\_](mailto:be_).







**Jedsada Yodwong**     is a power electronics engineer at mu Space Corp., Bangkok, Thailand. He received the B.Eng. and M.Eng. degrees in Electrical Engineering from Rajamangala University of Technology Lanna, Chiang Mai, Thailand, in 2017 and 2020, respectively. His research interests include the field of power electronics and control systems, DC power distribution systems, power converters, inverters, analog and digital control, electric drives, electric vehicles, and Satellite power systems. He can be contacted by email at: [Jedsada\\_yodwong@hotmail.com](mailto:Jedsada_yodwong@hotmail.com).





**Pratch Piyawongwisal**     is a lecturer in the Department of Computer Engineering, Rajamangala University of Technology Lanna (RMUTL), Chiang Mai, Thailand. He received his B.S. in Computer Engineering from University of Illinois at Urbana-Champaign (UIUC) in 2012 and M.S. in Computer Science from Carnegie Mellon University (CMU) in 2014. His main research interest is in machine learning and its applications to computer vision, natural language processing, as well as control systems. He can be contacted by email at: [pratch@rmutl.ac.th](mailto:pratch@rmutl.ac.th).





**Pakawadee Wutthiwai**     is a research officer in Faculty of Engineering of Rajamangala University of Technology Lanna (RMUTL), She studies for a master's degree in the Department of Electrical Engineering, Rajamangala University of Technology Lanna (RMUTL), Chiang Mai, Thailand. She received a B.Eng in Electrical Engineering from Rajamangala University of Technology Lanna, Chiang Mai, Thailand, in 2019. She was an exchange student at KOREATECH to study Power Electronics application. Her research interests include the field of power electronics and control systems. She can be contacted at email: [pakawadee.wu@gmail.com](mailto:pakawadee.wu@gmail.com).





**Anon Namin**    is an Asst. Prof. in the Department of Electrical Engineering, Rajamangala University of Technology Lanna (RMUTL), Chiang Rai, Thailand. He received a B.Sc.Ind.Ed. in Electrical Engineering from King Mongkut's Institute of Technology Thonburi, Bangkok, Thailand, in 1996. His M.Sc.Ind.Ed. in Electrical Engineering and Ph.D. in Energy Technology are finished from King Mongkut's Institute of Technology Thonburi (KMUTT), Thailand, in 2002 and 2013, respectively. His main research interests include the field of power electronic circuits and control, inductive wireless power transfer, wireless EV charging, solar simulator, and photovoltaic characterization. He can be contacted at email: [anamin@rmutl.ac.th](mailto:anamin@rmutl.ac.th).



**Phatiphat Thounthong**    (Senior Member, IEEE) was born in Phatthalung, Thailand, on December 29, 1974. He received the B.S. and M.E. degrees in electrical engineering from King Mongkut's Institute of Technology North Bangkok (KMITNB), Bangkok, Thailand, in 1996 and 2001, respectively, the Ph.D. degree in electrical engineering from Institut National Polytechnique de Lorraine (INPL), Nancy-Lorraine, France, in 2005, and the Habilitation à Diriger la Recherche (HDR) from Université de Lorraine, Nancy-Lorraine, France in 2020. Since 2012, he has been a Full Professor in the Department of Teacher Training in Electrical Engineering, King Mongkut's University of Technology North Bangkok. He is the author of 231 scientific papers (including 21 papers in IEEE Transactions/Magazines) published in Scopus with citations = 4,746 times and h-index= 34. His current research interests include power electronics, electric drives, electric vehicles, electrical devices (fuel cells, photovoltaic, wind turbine, batteries, and supercapacitors), nonlinear controls, and observers.. He can be contacted at email: [phatiphat.t@fte.kmutnb.ac.th](mailto:phatiphat.t@fte.kmutnb.ac.th).



**Noureddine Takorabet**    (Member, IEEE) was born in Algiers, Algeria, on May 23, 1969. He received Engineer Diploma from Ecole Nationale Polytechnique of Algiers (Algeria) in 1993. He received a Master of Science from Université Henri Poincaré (Nancy-France) in 1994 and a Ph.D. from Institut National Polytechnique de Lorraine in 1996 (Nancy-France). Since 1997, he has been an Associate Professor at ENSEM (Electricity and Mechanics School of Engineers), and from 2010, he has been a Full Professor at Université de Lorraine (ENSEM) in Electrical Engineering. He is Director of the research center GREEN: Group of Research in Electrical Engineering of Nancy. The main teaching activities deal with electrical machines, electromagnetics, numerical simulation and mathematics. His main research activities are focused on electromagnetic modeling of magnetic devices, electrical machines and transformers. He can be contacted at email: [noureddine.takorabet@univ-lorraine.fr](mailto:noureddine.takorabet@univ-lorraine.fr).