

# RGB LED Bulbs for Communication, Harvesting and Sensing

Muhammad Sarmad Mir  
*IMDEA Networks Institute*  
*Universidad Carlos III de Madrid*  
 Madrid, Spain  
 sarmad.mir@imdea.org

Behnaz Majlesein  
*LightBee S.L.*  
 Las Palmas de Gran Canaria, Spain  
 behnaz.majlesein101@alu.ulpgc.es

Borja Genoves Guzman  
*IMDEA Networks Institute*  
 Madrid, Spain  
 borja.genoves@imdea.org

Julio Rufo  
*LightBee S.L.*  
 Las Palmas de Gran Canaria, Spain  
 jrufo@lightbeecorp.com

Domenico Giustiniano  
*IMDEA Networks Institute*  
 Madrid, Spain  
 domenico.giustiniano@imdea.org

**Abstract**—RGB LED bulbs have entered the market as a promising alternative to traditional phosphor coating LEDs to meet illumination standards. In this paper, we introduce and propose solutions to address the challenges of RGB LED lighting for the Internet of Things applications, performing communication, harvesting energy and sensing tasks. Through experiments, we demonstrate that we can use RGB LEDs for multiple tasks. We can achieve a bandwidth in the order of 50 kHz and distances of around 3.5 m using commercial RGB LED bulbs as transceivers, without using any dedicated photodetector. RGB LED links are composed of three main colours, and we show that red is the best colour both for communicating to another receiving RGB LED bulb, as well as for harvesting with a solar cell; green and blue can instead be exploited for standard-compliant lighting and/or sensing purposes. We evaluate the system in two proof of concepts and provide insights for operating RGB LEDs for multiple tasks.

**Index Terms**—Visible light communication, RGB LED bulb, harvesting, sensing

## I. INTRODUCTION

Visible light communication (VLC) is paving its way as an enabling technology for Internet-of-Things (IoT) devices due to its energy efficiency, pervasive lighting infrastructure and support for a larger bandwidth. With the advancement in light-emitting diodes (LEDs) technology, the global market for VLC is booming worldwide with a projection of USD 111.9 billion by 2027 [1]. VLC is not only emerging as a complementary technology to solve the spectrum crunch problem in radio frequencies (RF), but it can also be applied in novel IoT applications [2]–[4].

Traditionally, white LEDs with phosphor coating are used for illumination and communication. However, white LEDs do not provide any control on colour hue, which is an important factor in applications such as smart homes (eye comfort) and greenhouses (plant growing). To address these limitations, red, green and blue (RGB) LED bulbs have been explored as an alternative to meet illumination standards, with products in the market such as Philips Hue Lighting for adjusting colour

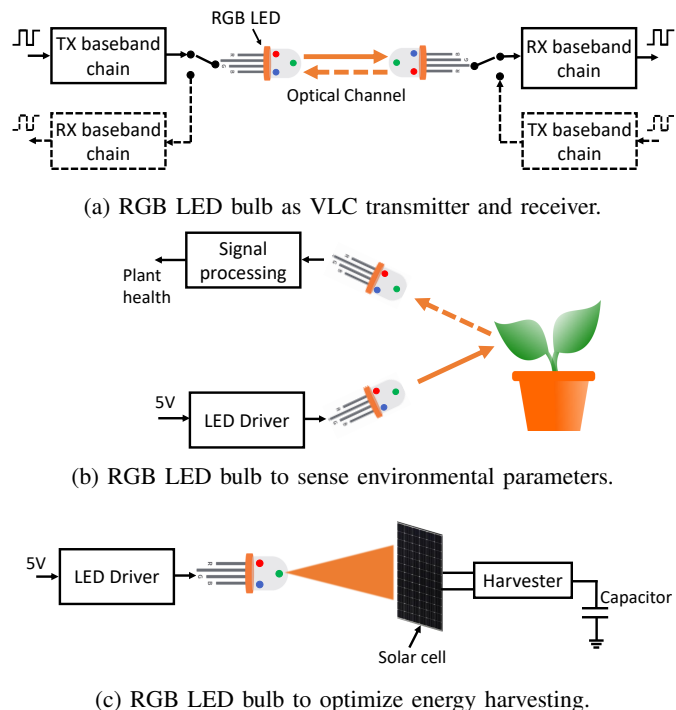

Fig. 1: Representation of scenarios to employ RGB LED for communication, harvesting and sensing, the three main research problems addressed in this paper.

hue [5]. RGB LEDs consist of three chips enclosed in a single packaging to emit RGB colours. RGB LEDs offer individual control of each chip to produce a large subset of colours and allow for modulation schemes transmitting data simultaneous on different communication channels.

We envision that RGB LEDs will become pervasively deployed thanks to their high reconfigurability. However, their cost is still higher than traditional white phosphor LEDs, which could limit the market penetration. For this reason, users need to perceive that the added value of RGB LEDs is

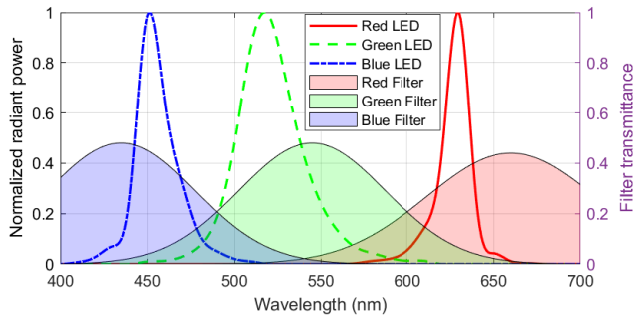

Fig. 2: Emission spectra of LED Cree XLamp MCE and transmittance of filters DBT660, DBT545 and DBT435.

sufficiently higher than traditional light sources to justify the investments. We address this problem by investigating how RGB LEDs can be used for other applications to foster their adoption, as shown in Fig. 1.

Traditionally, photodiodes (PDs) are used for sensing. However, their band covers the full visible spectrum as well as part of infrared. Fig. 2 shows a typical spectral power density of an RGB LED [6], also used in our experiments, and the transmittance spectra of three band-pass filter glasses [7] that could be used on top of a PD. The use of optical filters, which are not narrow band, may lead to an important inter-colour interference at the receiver, making it difficult to distinguish the colour source for each received data.

On the contrary, the use of RGB LED as a receiver can mitigate this problem as they have a lower detection bandwidth without the need of using extra devices and filters. In our study, we experimentally show that, similar to single LEDs [8], commercial RGB LED bulbs that are designed for artificial illumination can be used as a light-sensing device in a narrow band of wavelengths close to the band of emission. For instance, we show that the green chip of RGB LEDs is sensitive to frequencies in the visible green band. This makes them suitable both for multi-band communication from RGB LEDs to RGB LEDs (cf. Fig. 1a), and for environment sensing measuring the light reflected from the intended object (cf. Fig. 1b). Besides, these solutions are low-cost, as there is no need for any dedicated photodetectors. The knowledge of sensed light, e.g. detecting the presence of sunlight, can further allow reconfiguring the colours of RGB LEDs while transmitting, for optimized energy harvesting of solar cells embedded in IoT devices (cf. Fig. 1c).

This paper shows the joint performance in communication, harvesting and sensing of RGB LEDs, addressing the challenges, and presenting quantitative experiments that help to understand which applications are viable with today's RGB LEDs. Our contributions are listed in what follows:

- We provide insights for configuring commercial RGB LEDs for transmitting the desired colours, which is critical to optimize communication, harvesting and sensing;
- We design a receiver for sensing light with RGB LEDs, that overcomes their low responsivity (i.e., generated current per optical received power, measured in A/W);

- We present numerical results for communication bandwidth and responsivity, where RGB LED is used at the transceiver, and we show the potential of each colour;
- We study best wavelengths emitted by RGB LED bulbs for harvesting;
- Traditional solutions for stress detection in plants are very costly, and we present a low-cost solution for sensing the health of a plant with RGB LEDs in a smart home environment.

Our experiments show the following results:

- In communication, red colour of RGB LED bulbs both as transmitter and as a receiver (red-to-red) shows the best performance in terms of path loss and data rate, with communication link of about 3.5 meters;
- Our studies show that, harvesting using solar cells, red colours performs best followed by blue and then green.
- Green and blue colours can be exploited for standard-compliant lighting and/or sensing purposes.

## II. CHALLENGES

The use of RGB LED bulbs for communication, harvesting and sensing present some challenges:

**Parameters of LED as receiver are not known:** Nowadays, LEDs are mainly designed for illumination, or even data transmission [9] but not for photo-detection. Besides, the LED used as receivers does not have proper optics to receive light, and their field of view (FOV) should be broad and independent of the photodetection area. However, due to being photosensitive devices, they can perform as photodetectors [8]. Manufacturers do not provide information related to spectral sensitivity, FOV, and the effect of temperature on responsivity, which can affect the performance of RGB LEDs as a receiver.

**Limited bandwidth:** Complex modulation schemes are not affordable for IoT applications as we target in this paper due to being power-hungry. IoT scenarios typically require single-carrier and simple modulation schemes, such as On-Of-Keying (OOK). This limitation can be also mitigated by wavelength division multiplexing, paying special attention to inter-colour interference, both at transmitter and receiver spectra. Besides, using RGB LEDs for multiple purposes may result in conflicting requirements, and the modulation must be such that multiple applications can efficiently run concurrently.

**Energy harvesting:** Solar cells are typically optimized to harvest light from the sun, but they operate poorly with artificial light. However, artificial lights like RGB LEDs could be configured to approximately match the optical spectrum response of solar cells. This can be of help if the RGB LED can sense that there is not sufficient sunlight that can be harvested by the IoT device.

## III. DESIGN

The design of our VLC system has mainly three parts: i) fixed VLC transceiver, such as one or more light bulbs located on the ceiling that can adapt the hue based on the illumination requirements and can sense the environment; ii) mobile VLC transceiver, which could be IoT devices that could

	Transmitter (TX)			
	R	G	B	
LED 1 as RX	R	-3.52 (1.6)	-4.85 (1.5)	-22.23 (-)
	G	-32.55 (-)	-26.31 (-)	-10.95 (-)
	B	-32.19 (-)	-26.19 (-)	-20.50 (-)
LED 2 as RX	R	-6.02 (3.0)	-7.08 (2.9)	-23.02 (-)
	G	-42.34 (-)	-40.11 (-)	-40.08 (-)
	B	-24.36 (-)	-24.03 (-)	-14.11 (-)
LED 3 as RX	R	<b>0 (3.0)</b>	-16.43 (0.5)	-23.60 (-)
	G	-25.51 (-)	-23.82 (-)	-9.98 (0.4)
	B	-24.68 (-)	-24.36 (-)	-19.49 (-)

TABLE I: Comparison of LEDs as transmitter and receiver path loss and 3-dB bandwidth (the latter is shown in brackets in kHz; - means a very low bandwidth). The transmitter is set at constant electrical power of 1.75W (350mA, 5V) for all cases of R, G and B. The distance of 50 cm is maintained between the transmitter and receiver to measure the voltage in millivolts (normalized and converted to dB) at each chip of receiver LED.

be battery-free (e.g. through a solar cell) and sense different parameters that are communicated to fixed transceivers; iii) other objects in the environments, such as plants, that are sensed by the VLC transceivers. The design goals for our system focus on understanding the potential of RGB LEDs to perform communication, harvesting and sensing tasks, i.e.:

- Establish a bi-directional communication using RGB LEDs and explore its performance boundaries for indoor scenarios. This includes the design and prototyping of an end-to-end system;
- Explore lighting hue on the transmitter side to evaluate the harvesting performance. Multiple points of the chromaticity diagram are studied, with a total constant electrical power consumption for fair comparison;
- Evaluate possible scenarios where RGB LEDs can be exploited for sensing. As examples, we design an algorithm for the detection of sunlight to optimize energy harvesting on a mobile device, and we detect wavelength variations of received light for environmental tracking.

#### A. Comparison of commodity LEDs

There are several RGB LED types available in the market made by different manufacturers and classified mainly with their output lumens, colour, forward voltage ( $V_f$ ) and maximum drive current. Specifications of the LED related to communication and photo-detection such as frequency response or responsivity are not usually mentioned in the datasheet as the LEDs are mainly designed for the purpose of illumination. We study three commodity RGB LEDs; LED 1: Cree Xlamp XML [10]; LED 2: Osram opto LZ4 [11]; LED 3: Cree Xlamp MCE [6]. The LEDs have individually addressable connections for each RGB colour and also have a white LED to facilitate illumination in an indoor environment. The  $V_f$  is around 2.3 V (red), 3.4 V (green) and 3.2 V (blue), which make it convenient to power up and control the LEDs with low-cost controllers for modulation. The goal is to test the communication performance of LEDs, and select the best one for our study. In

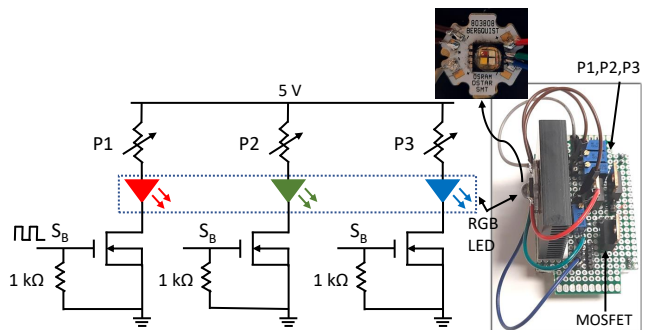

Fig. 3: Schematics and breadboard design for the transmitter.

the experiment, we send a tone signal maintaining a constant electrical power of 1.75 W, and measure the voltage at the LED receiver with Saleae logic analyser [12] for all 27 combinations of three RGB LEDs.

Results are shown in Table I, where we show both path loss and bandwidth (3-dB bandwidth values are shown in brackets). The best combination is the red-to-red link for LED 3, while other combination performances vary depending on the chip manufacturer. Note that the combination of the same LED colour at transmitter and receiver does not always provide the best performance, due to spectra mismatching in transmission and reception. Next, the bandwidth of each combination of three LEDs was measured by feeding the transmitter with a sine wave and changing its frequency. Then we measure the path loss at the receiver. The results show that around 3 kHz of bandwidth is obtained with a red-to-red combination and LED model 2 and 3, whereas we get a lower or even negligible bandwidth for the rest of the combinations. Once demonstrated all combination performances, from this point on, unless otherwise specified, we perform the experiments with a red-to-red combination of LED 3. Next, we design dedicated circuitry for the various operations of RGB LEDs.

#### B. Transmitter circuit design

We propose a simple and low-cost MOSFET based switching circuit to modulate RGB LED as shown in Fig. 3. MOSFET offers low resistance in the conduction state that reduces the power consumption and allows to handle larger current through the LED. The potentiometers P1, P2 and P3 control the current in each individual LED red, green and blue, respectively. The input signal to the LED driver circuit is generated using the Analog discovery II waveform generator [13].

#### C. Receiver circuit design for communication

The schematics for RGB LED based VLC receiver is shown in Fig. 4. The signal received at the LED is not very sharp, it is vulnerable to noise from indoor luminaries and it degrades steeply as we increase the transmission frequency or range of communication. As a first stage, we configure the LED in zero bias. At zero bias, the LED exhibits zero leakage (dark) current, which is ideal as the responsivity of LEDs as a receiver is low. We then amplify the signal with a low-noise Trans-Impedance-Amplifier (TIA). The TIA amplifier affects the bandwidth of the system considerably, as shown in the

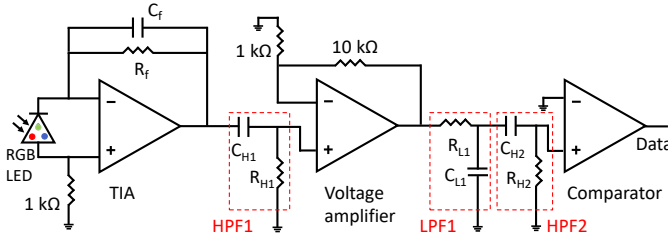

Fig. 4: Reception chain with RGB LED as a receiver.

next section. Thus the decision of feedback resistance value  $R_f$  affects the system performance and it must be optimized. The capacitor  $C_f$  helps to improve the stability of TIA.

As the next stage, a high-pass filter (HPF1) is used to filter out the DC component and noise from indoor luminaries. The cut-off frequency of the filter is set to 200 Hz with resistor  $R_{H1}$  and capacitor  $C_{H1}$ . After this, a non-inverting voltage amplifier (VA) with a gain of 10 is added to amplify the receiver signal in order to compensate for any channel loss. This stage also makes the received signal compatible with the comparator in the next stage to convert the analog signal into digital. A low-pass (LPF1) and high-pass (HPF2) filters can be added before the comparator to band limit the signal. LPF helps to remove high-frequency noise due to amplifier overshoots, and improves the signal-to-noise ratio. HPF2 helps to remove the DC bias introduced by the voltage amplifier and average the signal on the ground. As the last stage, a low-power comparator is used to digitize the data. Single TI-TLC272 op-amp [14] is used for both TIA and VA due to its low cost and high precision. For comparator, ST-TS881 [15] is used which features ultra-low power consumption and low noise.

#### D. Receiver circuit design for sensing

In addition to the VLC receiver, RGB LED bulbs can work to detect the presence of sunlight and the health of a plant. The sun emits electromagnetic (EM) radiations in a broad EM spectrum with most irradiance in the ultraviolet, visible and infrared regions. The broad-spectrum can generate more current in RGB LED as compared to indoor lighting. This effect can be utilized to detect the presence of sunlight and hence optimize the harvesting of energy on mobile devices. Similarly, the color of the plant changes due to disease and drought. When the plant is illuminated with RGB LED, the reflected spectrum varies with the state of the plant. This effect can also be detected with RGB LED as a receiver. In this configuration, the signal does not change significantly over a short time period, so variations are detected by averaging the received signal over a longer period. As the RGB LEDs generate very low output current (usually in the order of nA), a voltage follower amplifier (VFA) or simply a high resistance in parallel can be used to drive the analog-to-digital converter of a microcontroller unit (MCU) as shown in Fig. 5. VFA has a unity voltage gain and it draws minimal current from the LED.

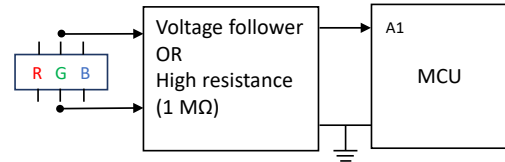

Fig. 5: Design for detecting sunlight and health of plant using RGB LED. Output of each LED colour is measured to detect variation in light due to broad spectrum of sunlight and change of plant color in disease or drought.

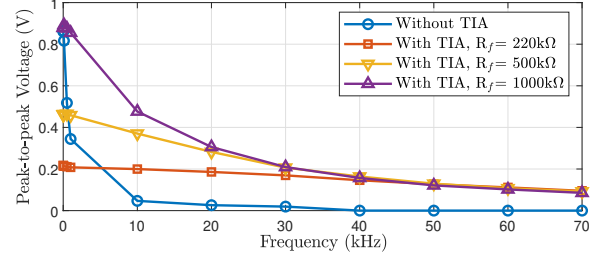

Fig. 6: Experimental performance of peak-to-peak voltage of a communication link at a distance of 50 cm when a red LED is performed both as transmitter and a receiver, for different feedback resistance of a TIA.

## IV. EVALUATION

### A. Communication

TIA design has an important effect on the receiver performance. The feedback resistance  $R_f$  sets the gain of the received signal as represented in Fig. 6. The larger  $R_f$ , the stronger the received signal is, which is represented as peak-to-peak signal voltage. In Fig. 7 we evaluate the end-to-end system performance by means of bit error rate (BER) versus distance between transmitter and receiver. We plot BER results for  $R_f = 1000 k\Omega$ . Note that very good results are obtained for an OOK rate of 1 kHz and 10 kHz but the performance degrades at larger distances. Moreover, the system shows good robustness to sunlight interference of 600 lux due to HPF1, with a slight decrease in performance observed due to the shot noise from sunlight.

**Insight #1 (I1):** *Red-to-red LED communication is the best performing in comparison to any other colour combination.* We can achieve more than 2.5 m at 20 kb/s while around 1.25 m at 100 kb/s. For this reason, we dedicate red LED for communication purposes in Fig. 11, where we represent a potential realization of a modulation scheme using RGB LEDs for all the envisioned applications.

### B. Energy Harvesting

The emission spectrum of a light source influences notably the amount of power harvested by a solar cell. We have configured an RGB LED bulb for feeding each colour chipset with a specific current. To do a fair comparison, the total current fed to RGB LED is set to 350 mA, allocated to each colour in portions of 50 mA, and leading to 36 possible combinations of transmitted colours represented in Fig. 8a. Then, on the receiver side we place a solar cell ‘SLMD121H04L’.

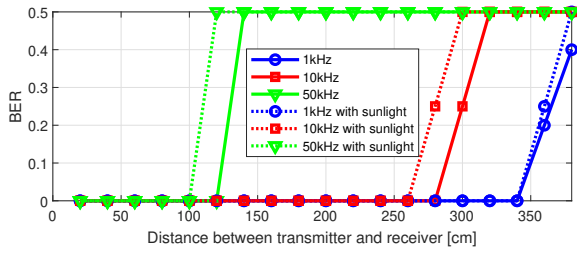
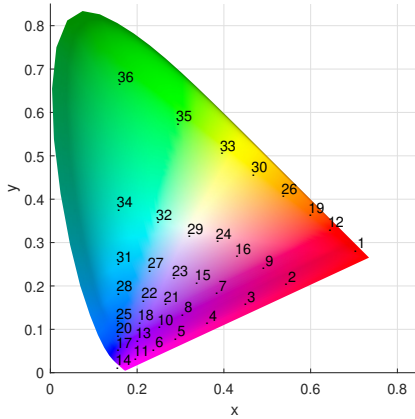
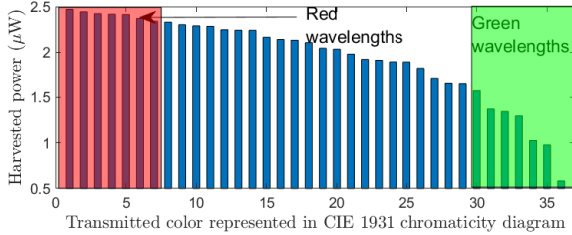

Fig. 7: BER versus distance from transmitter to receiver. Generally, the larger the distance, the larger the BER. Good results are obtained for 3.5 m, which is enough for indoor scenarios. A sunlight illuminance of 600 lux decreases slightly the performance.



(a) CIE 1931 colour space chromaticity diagram with corresponding 36 RGB combinations tested in this paper.



(b) Power harvested when different combinations of RGB hue are configured at the transmitter.

Fig. 8: The study shows effect of different wavelengths (RGB combinations) on energy harvesting using 2xSLMD121H04L solar cells and BQ25570 harvester. The red colour shows best results followed by blue and green.

We analyze experimentally all possible combinations of colours. The results are shown in Fig. 8b, where we show that almost  $2.5 \mu\text{W}$  is harvested when illuminated with red colour, and it decreases dramatically when illuminating with green wavelengths. However, acceptable results are obtained with a great number of combinations, which provides very valuable flexibility when the user may change the hue for additional purposes such as smart home activities or greenhouse conditions.

**Insight #2 (I2):** *Transmitting red wavelengths are the most efficient ones for energy harvesting purposes.* In Fig. 11 we

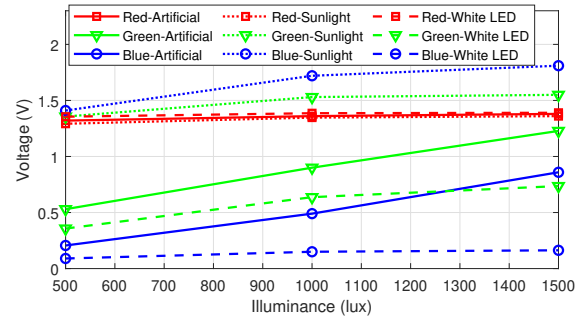

Fig. 9: Usage of an RGB LED to detect the sunlight. Higher voltage is generated with blue and green LEDs when sunlight is received, in comparison with results when artificial light (fluorescent lighting) and white light (phosphor-coated LED) are received.

increase the red signal average for boosting harvesting when no sunlight is received.

### C. Sensing

RGB LED generates current at each LED chip depending on the intensity and wavelength of the incident electromagnetic radiation. This property makes it be a suitable and low-cost solution to many applications that involve sensing with variations in wavelength. Two prospective solutions with proof of concept are presented in this paper.

The first study is performed to evaluate the effect of sunlight on the generation of photo-current in RGB LED as compared to fluorescent light and white LED. The illuminance is fixed to 500, 1000 and 1500 lux in all cases and voltage is measured at the output of each chip of RGB LED. It is noticed that the voltage generated in LEDs due to sunlight varies at different times of the day as sunlight's spectral composition varies across the day [16]. The average values are plotted in Fig. 9. In the figure, we can see a clear increase in voltage of green and blue LED when exposed to sunlight. The reason is that the spectrum of sunlight has a large magnitude in the ultraviolet region, which causes the increase in voltage with the green and blue LED. The detection of sunlight can succour the optimization of energy harvesting, especially for IoT devices. In the case of detected sunlight, RGB LED can adjust the hue to prioritize communication or power-hungry tasks.

Another important application of RGB LED is to sense the health of a plant. The colour of plant leaves changes in case of drought or disease. We exploit this colour variation to detect the health of a plant. A fresh plant is taken and illuminated with RGB LED and white light. The plant is left to dry for 8 days. The change in colour of leaves is presented in Fig. 10a. The voltage measurements are taken at the output of RGB LEDs on daily basis. Some combinations show a higher difference in voltage than others in a span of 8 days. The voltage at the output of receiver LEDs for best colour combinations is plotted in Fig. 10b. We can notice a voltage change of 0.51 (red-red), 0.46 (green-red), 0.39 (blue to green), and 0.037 V (white-green) from day 1 to day 8. The voltage

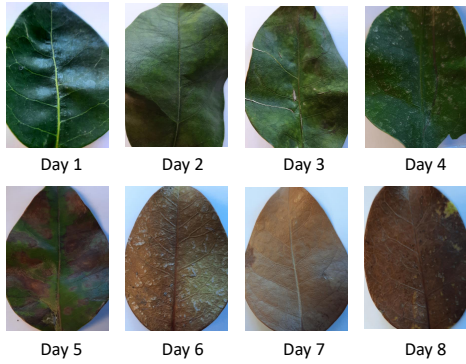

(a) Change in leaf colour from day 1 to day 8.

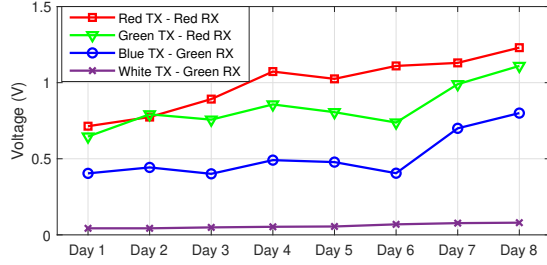

(b) Response of red, green and blue LED as receiver from day 1 to day 8 when plant is illuminated with white, red, blue and green light.

Fig. 10: RGB LED for sensing the health of the plant.

difference is detectable with a simple threshold circuit using op-amp to identify the health of a plant. This may open the door to multiple sensing applications for environment tracking.

**Insight #3 (I3):** Blue LED receives larger differences when sunlight or artificial lights are received. It is followed by a green LED. In Fig. 11, when blue and green LEDs are OFF, they are exploited for sunlight sensing, which helps adapting transmission parameters for harvesting energy. For instance, we increase the red signal average for boosting harvesting when no sunlight is received.

**Insight #4 (I4):** For plant sensing (reflections), we observe more variance when red LED is used for transmission and reception, though the usage of green transmission and red reception also shows good performance. Since transmission of red LED is used for data transmission, we see and represent in Fig. 11 the usage of green transmission and red reception as a good candidate for plant sensing.

**Insight #5 (I5):** As noted in [17], blue light matches the melanopic spectrum of a human eye, which affects the hormone melatonin and, consequently, increases stress and cardiac rhythm. Following blue LED measurements, it is desirable to reduce the blue light emission in the evening and night, see Fig. 11. Note that blue LED can be ON while the red LED is used as a receiver for data and sensing, because blue wavelengths are not received by red LED (see Table I).

**Insight #6 (I6):** Simultaneous data reception and sensing can be performed. As I4 indicates, we employ a green LED as a transmitter for plant sensing, while a red LED as a receiver for both communication and sensing. Indeed, communication data are extracted by looking at short-term signal variations

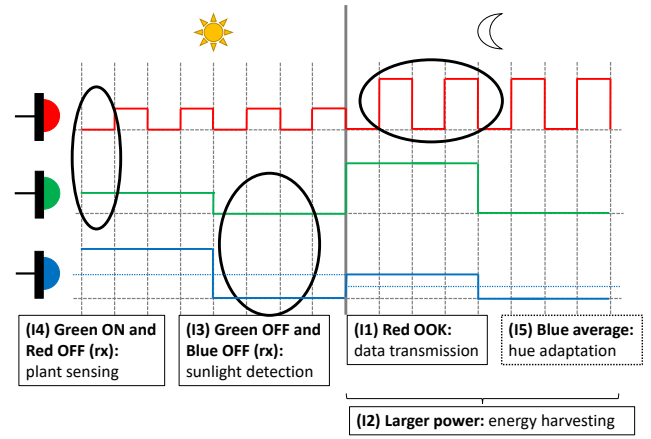

Fig. 11: Representation of insights from experiments.

(on-off-keying) while sensing data are detected at long-term by averaging the received signal over multiple readings.

## V. RELATED WORK

In the 1990s, Miyazaki *et al.* [18] incepted the idea to use LED as a photo-detector. Since then, the use of LEDs as both transmitter and receiver has been demonstrated using single low-power 5mm LEDs used as indicator [19]–[23]. LEDs used as an indicator are very directional and can not be used for illumination purposes of indoor environments [19]. In [23] and [21], the authors proposed a low-cost solution achieving a throughput of 870 b/s and 2.4 kb/s at the range of 90 cm and 18 cm, respectively. Data rates of 1 Mb/s and 10 Mb/s are demonstrated in [22] and [24] by using complex modulation techniques and condenser lenses but again with low communication range of 20 cm and 30 cm, respectively. A common problem in these systems is the use of low-power 5mm pin LED for communication which makes their solutions difficult to scale. On the contrary, our solution utilizes a simpler hardware design, ideal for IoT applications, and a high-power RGB LED that can be used in several applications.

Again for 5mm indicator LEDs, in [25], the responsivity (measured in A/W) at different reverse bias voltages considering green and blue LEDs as transmitters were investigated. They proved that the maximum responsivity was obtained when green and red colour LED are used as transmitter and receiver, respectively. Furthermore, the responsivity of the LED as receiver improved at a reverse bias voltage of 25 V. However, this entails a much higher consumption than the operation at no current bias as used in this work. LEDs as transmitter and receiver are sensitive to temperature variations, which produces a wavelength variation in the emitted power spectrum and spectral response [26]. Therefore, LEDs must be carefully studied when used as photo-sensitive receivers, as they may be excited at different wavelengths than their homologous transmitters. RGB LEDs used for illumination can also be used for high-speed communication with orthogonal frequency-division multiplexing (OFDM) schemes [27], [28]. However, these schemes require dedicated photodetectors,

optical filters and expensive receiver circuitry. Besides, the energy consumption can not be handled by IoT devices.

Apart from communication, the light hue also affects the harvesting capabilities of solar cells [29]. A significant improvement in harvesting efficiency can be achieved by illuminating the dye-sensitized solar cell with RGB LEDs [30]. Moreover, RGB sensors, but not LEDs, have been studied to sense different environmental parameters such as the health of the plants [31], [32] in smart homes or greenhouses. None of these prior works has investigated the usage of RGB LED bulbs for communication, and sensing in resource-constrained IoT applications. Besides, the studies concerning harvesting with RGB LEDs are performed with a specific type of solar cells optimized for artificial illumination (dye-sensitized), while in our work we conduct the study with more traditional silicon-based solar cells which could be used both outdoors and indoors. Finally, we take a holistic approach where we investigate how different applications can coexist using RGB LED bulbs.

## VI. CONCLUSION

We have shown that RGB LED bulbs have the potential for being used beyond illumination and communication in IoT applications. Our work has been supported by experimental studies, and we have concluded the paper presenting a possible operation of RGB LED bulbs to guarantee the coexistence of multiple applications. This, in turn, can allow increasing the added value perceived by users purchasing RGB LED bulbs and accelerate their market adoption.

## ACKNOWLEDGMENT

This work has been funded by the European Union's Horizon 2020 research and innovation programme under the Marie Skłodowska Curie grant agreement ENLIGHTEN No. 814215. Besides, this work has been partially funded by MCIN/AEI/10.13039/501100011033 thanks to the grant FJC2019-039541-I obtained by the author B. G. Guzmán.

## REFERENCES

- [1] G. I. A. Inc, *Visible Light Communication - Global Market Trajectory & Analytics*. Global Industry Analysts, Inc, 2021.
- [2] M. S. Mir, B. G. Guzman, A. Varshney, and D. Giustiniano, *PassiveLiFi: Rethinking LiFi for Low-Power and Long Range RF Backscatter*. New York, NY, USA: ACM, 2021, p. 697–709.
- [3] A. Varshney, A. Soleiman, L. Mottola, and T. Voigt, "Battery-free visible light sensing," in *Proc. of the 4th ACM Workshop on Visible Light Communication Systems*, ser. VLCS '17. New York, NY, USA: ACM, 2017, p. 3–8.
- [4] A. Galisteo, A. Varshney, and D. Giustiniano, "Two to tango: Hybrid light and backscatter networks for next billion devices," in *Proc. of the 18th International Conference on Mobile Systems, Applications, and Services*, ser. MobiSys '20. New York, NY, USA: ACM, 2020, p. 80–93.
- [5] P. H. smart lights, [www.philips-hue.com/en-in](http://www.philips-hue.com/en-in), Accessed: 2021-10-15.
- [6] Cree MCE, <https://cree-led.com/media/documents/XLampMCE.pdf>, Accessed: 2021-10-15.
- [7] Fuzhe, [http://www.fulaser.com/html/en/product/Glass\\_lens/](http://www.fulaser.com/html/en/product/Glass_lens/), Accessed: 2021-10-15.
- [8] M. S. Mir, B. Majlese, B. G. Guzman, J. Rufo, and D. Giustiniano, "LED-to-LED Based VLC Systems: Developments and Open Problems," in *Proc. of the Workshop on Internet of Lights*, ser. IoL '21. New York, NY, USA: ACM, 2021, p. 1–6.
- [9] Y. Tanaka, T. Komine, S. Harayuma, and M. Nakagawa, "Indoor visible communication utilizing plural white leds as lighting," in *12th IEEE International Symposium on Personal, Indoor and Mobile Radio Communications*, 2001.
- [10] CreeXML, [https://cree-led.com/media/documents/XLampXML\\_Color.pdf](https://cree-led.com/media/documents/XLampXML_Color.pdf), Accessed: 2021-10-15.
- [11] Osram LZ4, <https://www.digikey.es/product-detail/en/osram-sylvania-inc/LZ4-60MD09-0000/LZ4-60MD09-0000-ND/4970117>, Accessed: 2021-10-15.
- [12] Saleae Logic Analyser, <https://www.saleae.com/>, Accessed: 2021-10-15.
- [13] Digilent AD2, <https://digilent.com/reference/test-and-measurement/analog-discovery-2/>, Accessed: 2022-01-15.
- [14] "TI TLC272," <https://www.ti.com/lit/ds/symlink/tlc272.pdf>, Accessed: 2021-10-15.
- [15] "STMicroelectronics TS881," <https://www.st.com/en/amplifiers-and-comparators/ts881.html>, Accessed: 2021-10-15.
- [16] R. Hut, A. Scheper, and S. Daan, "Can the circadian system of a diurnal and a nocturnal rodent entrain to ultraviolet light?" *Journal of comparative physiology a-Sensory neural and behavioral physiology*, vol. 186, no. 7-8, pp. 707–715, 2000.
- [17] D. Giustiniano, "Position: Health effects in led-based communication systems and possible mitigations," in *Proc. of the 4th ACM Workshop on Visible Light Communication Systems*, ser. VLCS '17. New York, NY, USA: ACM, 2017, p. 27–28.
- [18] E. Miyazaki, S. Itami, and T. Araki, "Using a light-emitting diode as a high-speed, wavelength selective photodetector," *Review of Scientific Instruments*, vol. 69, no. 1, p. 3759, 1998.
- [19] Q. Wang, D. Giustiniano, and M. Zuñiga, "In light and in darkness, in motion and in stillness: A reliable and adaptive receiver for internet of lights," *IEEE J. Sel. Areas Commun.*, vol. 36, no. 1, pp. 149–161, 2018.
- [20] Q. Wang, D. Giustiniano, and O. Gnawali, "Low-Cost, Flexible and Open Platform for Visible Light Communication Networks," in *Proc. of the 2nd International Workshop on Hot Topics in Wireless*, ser. HotWireless '15. New York, NY, USA: ACM, 2015, p. 31–35.
- [21] S. Li, A. Pandharipande, and F. M. J. Willems, "Two-Way Visible Light Communication and Illumination With LEDs," *IEEE Trans. Commun.*, vol. 65, no. 2, pp. 740–750, 2017.
- [22] F. A. Dahri, F. A. Umrani, A. Baqai, and H. B. Mangrio, "Design and implementation of LED-LED indoor visible light communication system," *Physical Communication*, vol. 38, p. 100981, 2020.
- [23] D. Giustiniano, N. O. Tippenhauer, and S. Mangold, "Low-complexity Visible Light Networking with LED-to-LED communication," in *2012 IFIP Wireless Days*, 2012, pp. 1–8.
- [24] S. Liang, S. Li, Q. Pan, and Z. Xu, "Self-powered Weak Light LED-LED Communications," in *2019 15th International Conference on Telecommunications (ConTEL)*, 2019, pp. 1–5.
- [25] M. Galal, W. P. Ng, R. Binns, and A. Abd El Aziz, "Characterization of RGB LEDs as Emitter and Photodetector for LED-to-LED Communication," in *2020 12th International Symposium on Comm. Systems, Networks and Digital Signal Processing*. IEEE, 2020, pp. 1–6.
- [26] D. Moreno, J. Rufo, V. Guerra, B. Rabadan, and R. Perez-Jimenez, "Optical Multispectral Camera Communications Using LED Spectral Emission Variations," *IEEE Photon. Technol. Lett.*, vol. 33, no. 12, pp. 591–594, 2021.
- [27] H. Chun, S. Rajbhandari, G. Faulkner, D. Tsonev, H. Haas, and D. O'Brien, "Demonstration of a Bi-directional visible light communication with an overall sum-rate of 110 Mb/s using LEDs as emitter and detector," in *2014 IEEE Photonics Conference*, 2014.
- [28] H. Jung and S. Kim, "A Full-Duplex LED-to-LED Visible Light Communication System," *Electronics*, vol. 9, no. 10, p. 1713, 2020.
- [29] Y. Li, N. Grabham, S. P. Beeby, and M. Tudor, "The effect of the type of illumination on the energy harvesting performance of solar cells," *Solar Energy*, vol. 111, pp. 21–29, 2015.
- [30] Y.-N. Liu, M. Khairuddin, Y.-J. Liu, Y.-C. Chen, H.-Y. Ma, and H.-Y. Lee, "Enhancement of light energy harvesting capability of dye-sensitized solar cells through use of pulse width modulated RGB-LED lamps," *Optik*, vol. 178, pp. 271–278, 2019.
- [31] M. Brambilla, E. Romano, M. Buccheri, M. Cutini, P. Toscano, S. Cacini, D. Massa, S. Ferri, D. Monarca, M. Fedrizzi, G. Burchi, and C. Bisaglia, "Application of a low-cost RGB sensor to detect basil (*Ocimum basilicum* L.) nutritional status at pilot scale level," *Precision Agriculture*, vol. 22, 06 2021.
- [32] A. V. Zubler and J.-Y. Yoon, "Proximal methods for plant stress detection using optical sensors and machine learning," *Biosensors*, vol. 10, no. 12, p. 193, 2020.