

Restoration circuits for low power reduce swing of 6T and 8T SRAM cell with improved read and write margins

Ram Murti Rawat, Vinod Kumar

Department of Computer Science and Engineering, Delhi Technological University, Delhi, India

Article Info

Article history:

Received Mar 4, 2021

Revised May 12, 2021

Accepted Jun 4, 2021

Keywords:

Dual node voltage
Low power SRAM
Read noise margin
Swing restoration
Write noise margin

ABSTRACT

This article clarifies about the variables that influence the static noise margin (SNM) of a static random-access memory. Track down the improved stability of proposed 8T SRAM cell which is superior to conventional 6T SRAM cell utilizing Swing Restored circuit with voltages Q and QB bar are peruse and Compose activity. This SRAM cell strategy on the circuit or engineering level is needed to improve read static noise margin (RSNM), write static noise margin (WSNM) and hold static noise margin (HSNM). This article relative investigation of conventional 6T, standard 8T and proposed 8T SRAM cells with improved stability and static noise margin is finished for 180 nm CMOS innovation. This paper is coordinated as follows: Introduction in area 1, The 6T SRAM cell are portrayed in segment 2. In area 3, proposed 8T SRAM cell is portrayed. In area 4, standard 8T SRAM cell. Segment 5 incorporates the simulation and results which give examination of different boundaries of 6T and 8T SRAM cells and segment 6 conclusions.

This is an open access article under the [CC BY-SA](https://creativecommons.org/licenses/by-sa/4.0/) license.



Corresponding Author:

Ram Murti Rawat
Department of Computer Science and Engineering
Delhi Technological University
Shahbad Daulatpur, Bawana Road, Delhi-110042
Email: rammurtirawat@dtu.ac.in

1. INTRODUCTION

The scaling of semiconductor process technologies has been continuing for more than five decades. Advancements in process technologies are the fuel that has been moving the semiconductor industry [1]. In response to growing customer demand for enhanced performance and functionality at reduced cost, a new process technology generation has been introduced by the semiconductor industry every two to three years during the past four decades [2]. Memory is used widely in all electrical systems: mainframes, microcomputers and cellular phones, etc [3]. The growing demand of portable battery-operated systems has made energy efficient processors a necessity [4]. The performance of these devices is limited by the size, weight and lifetime of batteries. Serious reliability problems, increased design costs and battery-operated applications prompted the IC design community to look more aggressively for new approaches and methodologies that produce more power-efficient designs, which means significant reductions in power consumption for the same level of performance [5]. Memory circuits form an integral part of every system design as dynamic RAMs, static RAMs, ferroelectric RAMs, ROMs or flash memories, significantly contributing to the system level power consumption [6]. Reducing the power dissipation in memories can significantly improve the system power- efficiency, performance, reliability and overall costs [7]. RAMs have experienced a very rapid development of low-power low-voltage memory design during recent years due to an increased demand for notebooks, laptops, hand-held communication devices and IC memory cards [8]. There are various approaches that are adopted to reduce power dissipation, like design of circuits with

power supply voltage scaling, power gating and drowsy method [9]. Lower power supply voltage reduces the dynamic power in quadratic fashion and leakage power in exponential way. But power supply voltage scaling results in reduced noise margin. Many SRAM arrays are based on minimizing the active capacitance and reducing the swing voltage. In sub-100nm region leakage currents are mainly due to gate leakage and sub threshold leakage current [10]. High dielectric constant gate technology decreases the gate leakage current. Forward body biasing methods and dual V_t techniques are used to reduce sub threshold leakage current. In sub threshold SRAMs power supply voltage (V_{DD}) is lower than the transistor threshold voltage (V_t) and the sub threshold leakage current is the operating current [11].

With the far and wide utilization of battery-fueled applications in the course of recent years, for example, convenient cell phones and clinical gadgets that can be introduced, low force execution has become a difficult issue related with framework on-chip (SOC) plan [12]. Nonetheless, irregular admittance to low power (SRAM) memory can be effectively accomplished with delicate soc power on the grounds that sram extraordinarily influences the complete soc power since an enormous piece of the soc region remains. What's more, we can adequately accomplish power decrease by lessening working force because of force reliance on working voltage [13]. Be that as it may, the adverse consequence of the limit voltage (v_{th}) power contrast is considerably more critical for low working limit. it ought to be noticed that the variety of the sram cell is firmly influenced by v_{th} , recollecting that it is comprised of little semiconductors for mass mix. what's more, there is a compromise between understanding heartiness and composing abilities in the standard 6T sram cell. Anyway, the accomplishment of satisfactory understanding strength and dynamic writing in a low-thickness locale is a significant test.

Examination of the affectability of the memory of a memory utilizing a low-power sram limit develop. Static irregular arbitrary access memory soundness within the sight of dc clamor is estimated by static commotion edge (SNM). The measure of sound energy needed in the yield hubs to obscure the condition of cells called static sound qualities. Can be recognized utilizing the force move highlight (vtc) of two coordinated sram cell inverters [14]. Figure 1 gave beneath the sram semiconductor cell conspire for six vertical sound line reenactment. voltages v_n sources are sound sources in the hubs of a cell state [15].

The SRAM cell utilizes across-gathered inverters that keep a steady condition, and their yield hubs store information put away in a cell. Nonetheless, as the volume of voltages V_N expands, cell security crumbles because of changes in hub voltages. Static clamor edge estimates the reasonable levels of these commotion hindrances and hence the capacity of these converters to keep up their position where there is noise. Getting the consequence of various circuit boundaries in SNM cell 6T and 8T SRAM planned with 180 nm CMOS innovation is the principal motivation behind this paper. When the static clamor edge of the SRAM cell is in working mode, figure out how to work, and record execution. We can get the static commotion edge of the SRAM cell by designing the voltage move (VTC) highlights of the two incorporated inverters. The VTC of one of the interpreters is being examined along the line $y = x$ to shape a "butterfly bend." The SNM is close to a little square that can be embedded inside the "eye" of the diagram, as demonstated in Figure 2 [16].

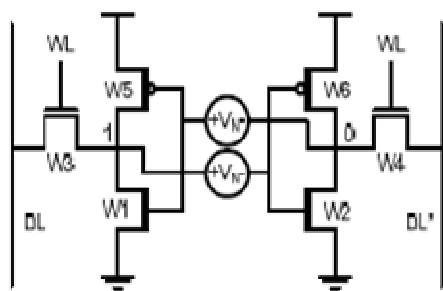

Figure 1. Schematic of a 6T SRAM cell with noise voltage sources for measuring SNM [15].

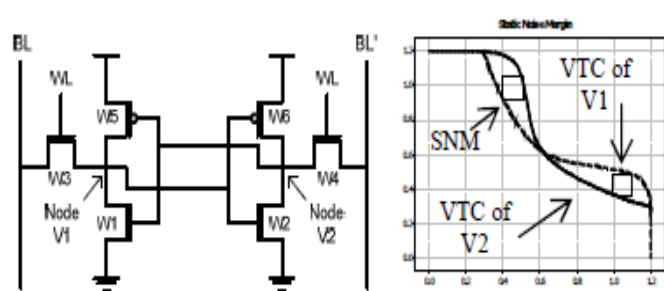

Figure 2. Schematic of a 6T SRAM bit cell and SNM the side of the largest square fitted inside the graph [16].

2. CONVENTIONAL 6T SRAM CELL

In a run of the 6T SRAM cell, information stockpiling hubs are straightforwardly gotten to through trans-semiconductors with restricted admittance while understanding activity and information can store compose undertakings, as demonstrated in Figure 3. As you read, the hub stockpiling esteems reach between the matched inverter sets and the composing capacity for information stockpiling at hub voltages and more

modest lines. BL and BLB are slender lines and WL are name line. Access semiconductors or pass semiconductors are constrained by the WL (line of words) to make perusing and composing activities work. Touch lines fill in as info hubs. During learning measure, little lines communicate information from SRAM cells to a sound enhancer. In fact, the base length of the semiconductors is 180 nm CMOS [17].

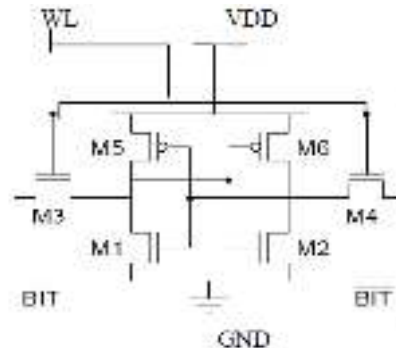

Figure 3. Conventional 6T SRAM cell [17]

3. PROPOSED 8T SRAM CELL

This is proposed for the 8T SRAM cell to shape a standard 6T SRAM and two incorporated PMOS semiconductors associated with node voltages, consequently decreasing the vibration and ideal solidness got utilizing coordinated PMOS. Figure 4 hub estimations with a recovery circuit perform grasping, perusing and composing capacities and different boundaries like deferral, soundness is utilized and are analyzed between the standard low force 6T SRAM and the plan of the 8T SRAM cells. These similar outcomes uncover that perusing, composing and catching the presentation of the proposed 8T SRAM cell mode is superior to the standard 6T SRAM cell. This is because of the way that a high static commotion limit is acquired which guarantees great composing capacity and learns the security of the little cell [18]

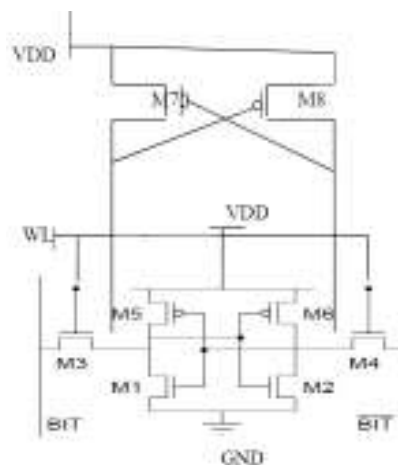

Figure 4. Proposed 8T SRAM cell [18].

4. STANDARD 8T SRAM CELL

The standard 8T SRAM cell is appeared in Figure 5. That is clear in the request for perusing and composing utilize an alternate word rundown and lower line. The record that the standard 8T SRAM cell utilizes persistent learning programs which lessens the reduction in the quantity of dainty lines. That an average 8T SRAM cell is profoundly gainful redesign read static noise margin (RSNM), for example, hold static noise margin (HSNM) for a standard 6T SRAM cell with equivalent compose time, access time, and line of composing [19].

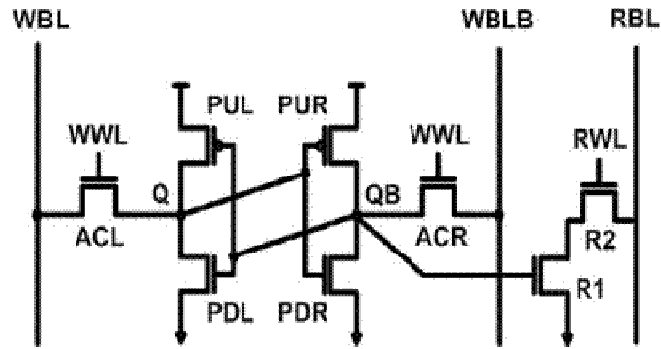

Figure 5. Standard 8T SRAM cell [19].

5. SIMULATION AND RESULTS

The investigation of the proposed 8T SRAM cell in inflexibility examines, dependability learning, security composing is avoided from this part. These outcomes are tried with customary 6T SRAM cells and standard 8T SRAM cells. The circuit is characterized by receiving 180 nm CMOS Innovation with a force supply of 1.2 voltage.

5.1. Hold stability

Static commotion edge (SNM) is the most well-known technique for estimating the solidness of a grasp of the cell [20], [21]. Strength adjustment is resolved when the SRAM cell is in the standing firm on situation. Rather than holding the word lines it is killed, so the cell is pulled out of flimsy lines. SNM characterizes the most complete uncontrolled sound in stockrooms prior to examining cell substance. Figures 6, 7 and 8 show the static clamor location of standard 6T sound, the proposed 8T and 8T SRAM cells individually.

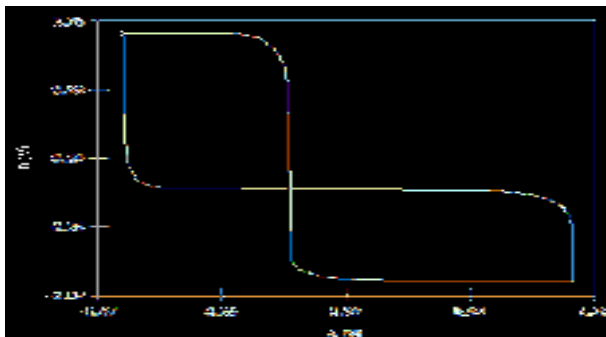

Figure 6. HSNM conventional 6T SRAM cell

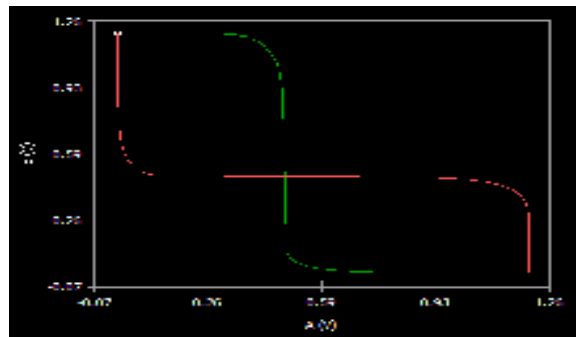

Figure 7. HSNM proposed 8T SRAM cell

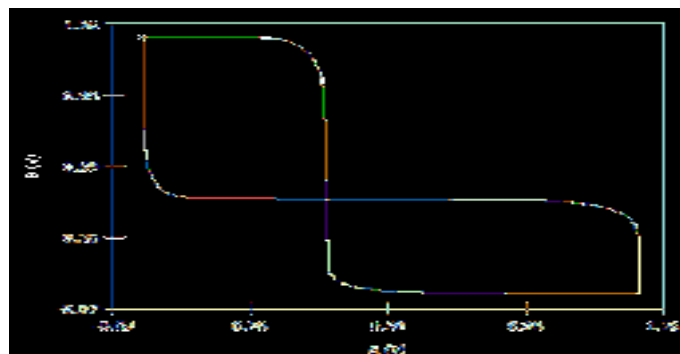

Figure 8. HSNM standard 8T SRAM cell

5.2. Read stability

Learning force is estimated by perusing the read static noise margin (RSNM) in the SRAM cell. Inside suggested 8T SRAM cell for gathering spatial isolation, we better discover RSNM relative 6T SRAM and standard 8T SRAM cells. Figures 9, 10, and 11 depict the examination security of the standard 6T SRAM, the proposed 8T, and the 8T SRAM cells individually [22], [23].

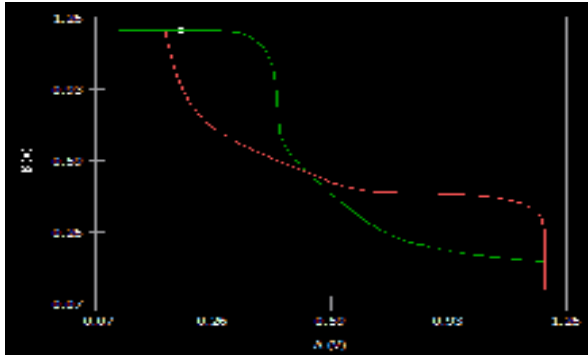

Figure 9. RSNM conventional 6T SRAM cell

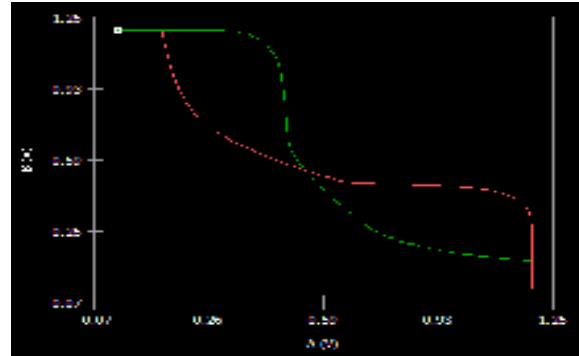

Figure 10. RSNM proposed 8T SRAM cell

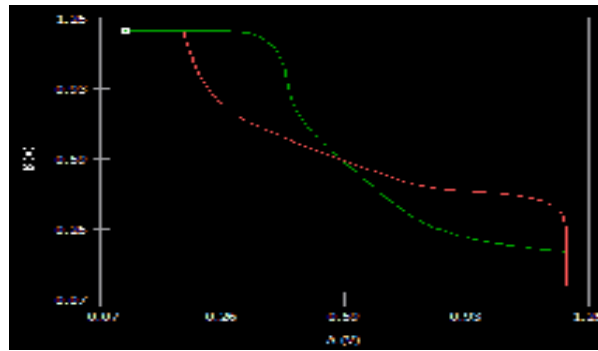

Figure 11. RSNM standard 8T SRAM cell

Static noise margin (SNM) is the most common approach to measure hold stability of the cell. Hold stability is calculated when the SRAM cell is in hold state. In hold state the word lines are off, so the cell is totally disconnected from the bit lines. SNM defines the largest noise that can be imposed to the storage nodes before flipping the content of the cell. Table 1 shows the hold static noise margin of 6T and Proposed 8T SRAM cells respectively.

The read stability is measured by read static noise margin (RSNM) in SRAM Cell. In the proposed 8T SRAM cell due to storing nodes isolation we get better RSNM comparable to conventional 6T SRAM cell. Table 1 represents the read stability of 6T and proposed 8T SRAM cells respectively.

Table 1. Comparison of hold SNM and read SNM

CELLs	Read SNM (in volts)	Hold SNM (in volts)
Conventional 6T SRAM	0.0711	0.125
Proposed 8T SRAM	0.1000	0.125
Standard 8TSRAM	0.0999	0.125

5.3. Write ability

Composing security is constrained by the write static noise margin (WSNM). In the prescribed 8T SRAM cell because of spatial assortment, we improve WSNM like standard 6T SRAM and receive 8T SRAM cells. The Figures 12, 13, and 14 address the ordinary strength of the standard 6T SRAM, directed 8T, and standard 8T SRAM cells separately [24].

Write trip point (WTP): - Standard 6T cells, 8T norm and proposed 8T SRAM record the development point of the cell composing limit. It shows how troublesome it is in cell stockpiling. The voltage-line voltage is moved from 0 to Vdd, just as cell test, when the Q and QB bar communicates its substance are caught. The measure of spot line voltage in the intersection space of in the inward capacity spaces of the Q and QB bar addresses the place of the composing trip [25], [26].

The write stability is measured by write static noise margin (WSNM). In the proposed 8T SRAM cell due to storing nodes isolation we get better WSNM comparable to conventional 6T SRAM cell. Table 2 represent the write stability of 6T SRAM and proposed 8T SRAM cells respectively.

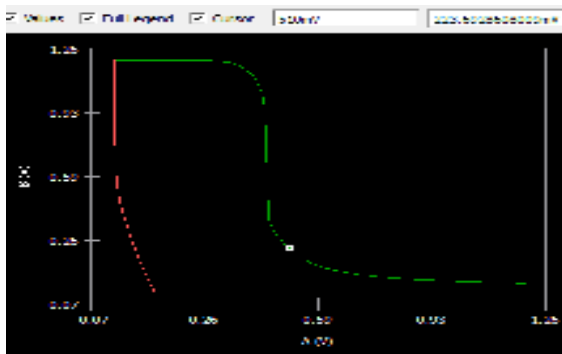

Figure 12. Proposed 8T SRAM cell WTP

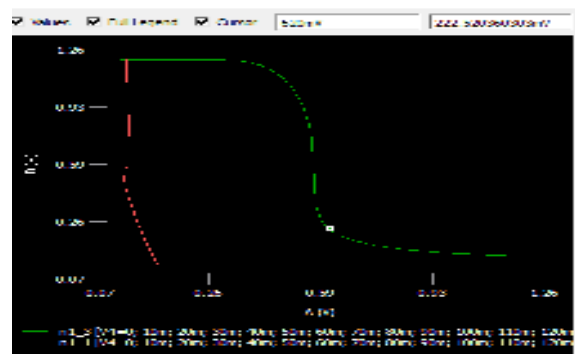

Figure 13. Proposed 8T SRAM cell WTP

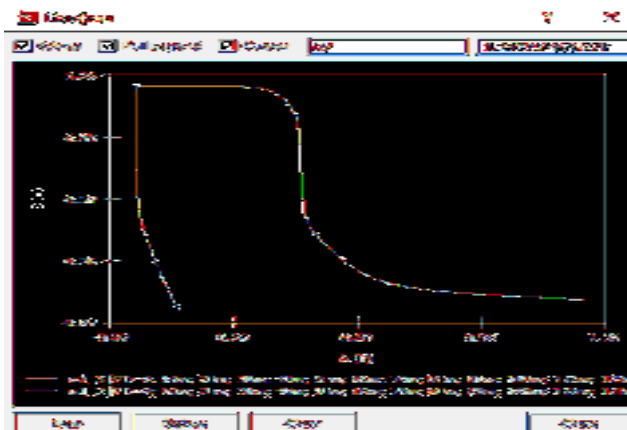

Figure 14. Standard 8T SRAM cell WTP

Table 2. Comparison for write trip point of 6T SRAM and standard 8T and proposed 8T SRAM cells

CELLs	Write trip point (WTP)
Conventional 6T SRAM	675mv
Proposed 8T SRAM	900mv
Standard 8T SRAM	726mv

6. CONCLUSION

SRAM low force cell and swing restoration voltages are the charging locale. Irregular memory dissemination techniques were introduced in this paper. This paper breaks down investigations with an examination of conventional 6T, proposed 8T and standard 8T SRAM cells in 180 nm CMOS Innovation. This proposed 8T SRAM cell performs DC examination. Hold, peruse and compose exercises. DC HOLD, READ examination and WRITE execution of the proposed almost negligible difference proposed 8T SRAM cell is superior to standard 6T SRAM and standard 8T SRAM cells. This end is appropriate for low force utilization in the SRAM cell and is proposed for 8T SRAM cell recording capacity to deal with power is better then for standard 6T SRAM and standard 8T SRAM cells and for higher rates for the proposed 8T SRAM cell.

REFERENCES

- [1] J.M. Rabies, Digital integrated circuits, *Prentice Hall*, (1996).
- [2] K. Itch, VLSI Memory Chip Design, *Springer-Verlag*, NY, 2001.
- [3] K. Roy and S.C. Prasad., Low-Power CMOS VLSI Circuit Design, *John Wiley and Sons*, 2000.
- [4] Sedra, A.S., Sedra, D.E.A.S. and Smith, K.C., "Microelectronic Circuit," chapter 15, 6th edition, New York: Oxford University Press, 1998. ISBN: 9780198089131.
- [5] Wai-Kai-Chen, "Memory, Microprocessor and ASIC," *CRC Press*, 2003. ISBN-10: 0849317371.
- [6] Tegze P. Haraszti, "CMOS Memory Circuits," *Kluwer Publication*, 2002.
- [7] Harris, D. and Harris, S.L., "Digital Design and Computer Architecture," Morgan Kaufmann, 2010.
- [8] A. S. Sedra, K. C. Smith, "Microelectronic circuits," Fourth Edition, New York: Oxford, 1988. ISBN-10: 0195338839.
- [9] S.M. Kang and Leblebici, CMOS Digital Integrated circuits, Analysis and Design, Second Edition, Mc Graw-Hill, 1999. ISBN-10: 0072460539
- [10] E. Sicard, and S. B. Dhia, "Advanced CMOS Cell Design," *INSA Electronic Engineering School of Toulouse, France*, 1998.
- [11] R. L., Geiger, P. E. Allen, and N. R. Strader, "VLSI Design Techniques for Analog and Digital Circuits," *McGraw-Hill Publishing Company*, 1990.
- [12] R. Jacob Baker, Harry W. Li, David E. Boyce, "CMOS Circuit Design, Layout and Simulation," *Wiley, A John Wiley & Sons, Inc., Publication*, 2019. ISBN-10: 0780334167.
- [13] B. H. Calhoun, J. F. Ryan, S. Khanna, M. Putic, J. Lach, "Flexible Circuits and Architectures for Ultralow Power," in *Proceedings of the IEEE*, 2010, vol. 98, no. 2, pp. 267-282.
- [14] E. Seevinck, F. J. List, J. Lohstroh, "Static-noise margin analysis of MOS SRAM cells," in *IEEE Journal of Solid-State Circuits*, vol. 22, no. 5, pp. 748-754, Oct. 1987.
- [15] B. H. Calhoun, A. P. Chandrakasan, "Static noise margin variation for sub-threshold SRAM in 65-nm CMOS," in *IEEE Journal of Solid-State Circuits*, vol. 41, no. 7, pp. 1673-1679, July 2006.
- [16] A. Pavlov, Manoj sachdev, "CMOS SRAM Circuit Design and parametric Test in Nano-scaled Technologies," *Springer 2008*. DOI: 10.1007/978-1-4020-8363-1.
- [17] G. Torrens et al., "A 65-nm Reliable 6T CMOS SRAM Cell with Minimum Size Transistors," *IEEE Transactions on Emerging Topics in Computing*, vol. 7, no. 3, pp. 447-455, 2017.
- [18] R. M. Rawat, "A Novel Low power and Swing Restoration SRAM Logic Circuit Technique," *International Journal of Engineering and Technical Research*, vol. 7, no. 2, pp. 316-318, 2018.
- [19] Moradi, F., Tohidi, M., Zeinali, B. and Madsen, J.K., "8T-SRAM Cell with improved read and write margins in 65 nm CMOS Technology," *IFIP/IEEE International Conference on Very Large Scale*, pp. 95-109, 2014.
- [20] Nayak, D., Acharya, D. P. and Mahapatra, K., "A read disturbance free differential read SRAM cell for low power and reliable cache in embedded processor," *International Journal of Electronics Communication*, vol. 74, pp. 192-197, 2017.
- [21] Wang, X., Zhang, Y., Lu, C. and Mao, Z., "Power efficient SRAM design with integrated bit line charge pump," *AEU International Journal of Electronics Communication*, vol. 70, no. 10, pp. 1395-402, 2016.
- [22] Chang, M. F., Chang, S. W., Chou, P. W., & Wu, W. C., "A 130 mv SRAM with expanded write and read margins for subthreshold applications," *IEEE J Solid-State Circuits*, vol. 46, no. 2, pp. 520-529, 2010.
- [23] Wen, L., Li, Z., & Li, Y., "Single-ended, Robust 8T SRAM cell for low-voltage operation," *Microelectronic Journal*, vol. 44, no. 8, pp.718-728, 2013.
- [24] X. Wang, C. Lu, and Z. Mao, "Charge Recycling 8T SRAM Design for Low Voltage Robust Operation," *AEU-International Journal of Electronics Communication*, vol. 70, no. 1, pp. 25-32, 2016.
- [25] N. Verma, and A. P. Chandrakasan, "A 256 kb 65 nm 8T subthreshold SRAM employing sense-amplifier redundancy," *IEEE J Solid-State Circuits*, vol. 43, no. 1, pp. 141-149, 2008.
- [26] P. D. Kumar, R. K. Kushwaha, P. Karuppanan, "Design and Analysis of low power Sram," thesis report, Advances in VLSI, Communication, and Signal Processing, pp. 41-56, 2020.