



Grant Agreement No. 875052  
Start Date: 01/01/2020 (48 Months)

***Deliverable No. [2.2]***  
**[Requirements table and use case description]**

Due Date: [31/12/2021]  
Submitted On: [28/12/2021]

Coordinator	University of Pavia (UNIPV)
Deliverable Lead Partner	Prof. Mor Peleg [UH] + Valentina Ganicheva (Bitsens)
Contributing Partners	UH, IBM, BIT, PUT, ICS MAUGERI, NKI, Deontics, AIMAC, UPM, UNIPV
Contact	Prof. Silvana Quaglini
Email	<a href="mailto:silvana.quaglini@unipv.it">silvana.quaglini@unipv.it</a>
Website	<a href="http://www.capable-project.eu">www.capable-project.eu</a>

Deliverable Type		
R	Document, report	[X]
Dissemination Level		
PU	Public	[X]
CO	Confidential (Consortium members including Commission Services)	
CI	Classified Information (Commission Decision 2015/444/EC)	

# Table of Contents

- 1.. Executive Summary..... 5
- 2.. Literature review ..... 6
- 3.. CAPABLE Concept..... 6
- 4.. Patient requirements ..... 7
  - 4.1. Methodologies..... 7
    - 4.1.1. NKI and ICSM interviews ..... 7
    - 4.1.2. Periodic Patient interviews with AIMAC and UNIPV - Methods..... 9
    - 4.1.3. Covid-19 Questionnaires for patients (Laura)..... 10
    - 4.1.4. Agile prototyping ..... 11
  - 4.2. Patient Interview Results (Laura+ Itzke + Viola) ..... 11
    - 4.2.1. Initial interview results ..... 11
    - 4.2.2. NKI interview Results (Itzke) ..... 12
    - 4.2.3. ICSM interview Results (Viola - Valentina)..... 17
    - 4.2.4. Results of Periodic Patient interviews with AIMAC and UNIPV (Laura) ..... 19
    - 4.2.5. Covid-19 Interview Results (Laura) ..... 23
    - 4.2.6. Integrated User Needs (UNIPV) ..... 34
  - 4.3. Data analysis from AIMAC forum (Enea) ..... 35
    - 4.3.1. Quantitative analyses of the AIMAC forum messages..... 35
    - 4.3.2. Question detector ..... 35
    - 4.3.3. Keyword extraction and classification ..... 36
    - 4.3.4. Manual classification..... 36
    - 4.3.5. Neural network with simple embedding..... 37
    - 4.3.6. Neural network with word2vect..... 37
    - 4.3.7. SVM sentences classifier ..... 37
    - 4.3.8. Qualitative analysis of the AIMAC forum messages..... 38
    - 4.3.9. Message authorship..... 39
    - 4.3.10. Disease phase ..... 39
    - 4.3.11. Message motivation..... 39
    - 4.3.12. Examples of messages..... 41
  - 4.4. User models and scenarios (Nicole) ..... 43
    - 4.4.1. Personas (Nicole)..... 43
    - 4.4.2. M12 & M18 Demo Scenario (Nicole) ..... 43
    - 4.4.3. Other Scenarios (based on the extended CAPABLE proposal) - Nicole ..... 46
  - 4.5. Digital intervention strategy ..... 46
    - 4.5.1. Recommendations from guidelines ..... 46
    - 4.5.2. Validated educational materials (Mor)..... 47
    - 4.5.3. Capsules approach (Mor) ..... 47
    - 4.5.4. Patient model (Mor) ..... 48
  - 4.6. Content of the Coaching system and messages ..... 49
  - 4.7. Use Case Diagram ..... 50
  - 4.8. Non-functional Requirements (UPM) ..... 130
- 5.. Clinical requirements (Annelies + Mimma)..... 133
  - 5.1. Clinical requirement collection in NKI ..... 134
  - 5.2. Clinical requirement collection in ICS Maugeri (Viola)..... 135
  - 5.3. Results of Clinical Requirement Collection at NKI (Itske) ..... 135
    - 5.3.1. Current situation and supportive care needs..... 135

- 5.3.2. Intended way of use and user needs ..... 136
- 5.3.3. Input data need to come from the patient app..... 136
- 5.3.4. Information presentation needs ..... 136
- 5.3.5. Clinical decision support and alerting needs..... 137
- 5.3.6. Communication needs ..... 137
- 5.3.7. General/additional needs ..... 137
- 5.4. Results of Clinical Requirement Collection at ICS Maugeri (Viola)..... 137
- 5.5. Integrated Clinical needs (Itske) ..... 145
- 5.6. Guidelines selection (Lucia OK) ..... 146
- 5.7. Clinical data to be collected by the CAPABLE system (Lucia) ..... 147
- 5.8. Clinical workflows and scenarios for Clinician Users (TF2) ..... 148
  - 5.8.1. Personas (Enea) ..... 148
  - 5.8.2. Demonstration Scenario (Enea) ..... 148
  - 5.8.3. Other Scenarios (based on the extended CAPABLE proposal) ..... 149
- 5.9. Use Case Diagram and functional requirements..... 150
- 5.10. Non-functional Requirements (Annelies+ Manuel) ..... 213
- 5.11. Barriers to Market (Manuel)..... 217
- 6.. Overall capable architecture ..... 220
  - 6.1. CAPABLE Sequence Diagrams ..... 221
  - 6.2. Data Platform ..... 223
  - 6.3. Case manager..... 226
  - 6.4. KDOM ..... 232
  - 6.5. Frontend server component..... 240
  - 6.6. Patient’s application..... 243
  - 6.7. Clinician’s Dashboard ..... 246
  - 6.8. Sensors..... 248
  - 6.9. PROforma CIG Engine and Knowledge Base ..... 251
  - 6.10. Multimorbidity Controller..... 254
  - 6.11. Virtual Coach..... 256
  - 6.12. System Integration and Security ..... 264
- 7.. Data representation (Ronald)..... 267
  - 7.1. Data representation requirements ..... 267
  - 7.2. Data storage representation requirements..... 268
  - 7.3. Data exchange representation requirements ..... 269
  - 7.4. Metadata requirements ..... 270
  - 7.5. Data Platform Considerations..... 270
    - Observational Medical Outcomes Partnership (OMOP) ..... 270
    - Fast Healthcare Interoperability Resources (FHIR) ..... 271
    - Transformation between OMOP CDM and HL7 FHIR..... 274
- 8.. AI Data processing and analysis ..... 275
  - 8.1. Overview of the AI prediction component ..... 275
  - 8.2. Specific Aims and Methods of the AI predictive component ..... 276
  - 8.3. Requirements for the predictive component and its usage ..... 277
  - 8.4. Descriptive Statistics for Retrospective Data Sets ..... 278
  - 8.5. Risks for completing the component successfully..... 283
- 9.. References ..... 284
- 10.. Appendices ..... 286
  - 10.1. Abbreviations List and Glossary ..... 286

10.2.	Interview Questionnaires .....	288
10.2.1.	Semi-structured patient interview guide.....	288
10.2.2.	Semi-structured healthcare professional focus group guide .....	290
10.2.3.	Patient Questionnaire used in ICS MAUGERI .....	292
10.2.4.	Patient Interview Guide ICS MAUGERI .....	295
10.2.5.	Covid questionnaire.....	297
10.3.	QUESTIONS FOR CLINICIAN’S INTERVIEW .....	302
	OPTION 1 (synchronous interaction)	305
	OPTION 2 (asynchronous interaction)	306
	OPTION 3	306

## 1.. Executive Summary

---

The aim of this deliverable is to define the requirements of the CAPABLE system. These requirements include clinical requirements regarding the clinical scope of decision-support and its content (knowledge base), patient and clinician user needs, and technical system requirements for the different system components. Following our iterative development approach for the CAPABLE system, this document presents the functional and non-functional requirements. This document opens with a literature review (Section 2, corresponding to Task T2.1) that we have performed to identify the state of the art of data-science-based methods and systems for supporting the quality of life of cancer patients, starting with data collection and data integration methods, and continuing to machine-learning based prediction models and patient coaching systems. The literature review allowed us to identify best practices that we plan to adopt in the CAPABLE system, as well as open challenges, many of which we plan to address.

Going from the state of the art to our own CAPABLE system, in Section 3 we present the overall system architecture, along with the different components of the system. In addition to this structural description of the system, we also provide a workflow presenting the process of care supported by the CAPABLE system, from patient enrollment and initial setup of the physician-facing dashboard and patient-facing mobile app, to the on-going services provided by the systems to these users, including patient monitoring and decision-support.

The following chapters present a description of the methods that we used to collect different requirements, as well as the requirements themselves. Section 4 presents patient requirements (Task T2.1) and Section 5 – clinical requirements (Task T2.3), relating to the needs of the clinicians as well as selection of clinical practice guidelines, monitoring data to be collected by patients at home, and certification/barriers to market. Section 6 (corresponding to Task T2.6) starts with a set of Sequence Diagrams that specify how the system components interact with each other in order to achieve the M12 DEMO Scenario.

Then we present all functional and non-functional requirements of the different system components (Data integration components [Case Manager, Data Platform, and the Knowledge-Data Ontology Mapper (KDOM)], decision-support [Computer-interpretable Guideline (CIG) Execution Engine and Knowledge Base, Multimorbidity Controller, Coaching System – all three rely on the existing decision model of the PROforma formalism], user interfaces [Patient APP GUI, Doctor APP GUI], sensors) as well as security/privacy). Section 7 presents the Technical requirements for data representation, integration, quality and exchange (corresponding to Task T2.4). Section 8 presents the Technical requirements for the AI data processing and analysis methods (corresponding to Task T2.5), including predictive model and knowledge discovery (pattern detection). Technical detailed requirements for security and privacy will be formulated in WP4.

WP2 continued to meet in Year2 to complete the requirement formulation. Issues that were elaborated in Year2 include defining the structure and content of the pdf summary for the general practitioners [Section 4, Req. 5.3.1, p. 73], additional requirements related to security by design [Section 6.12], and the final choice of phones and sensors [Section 6.8]. Based on feedback from the M12 demo from all stakeholders and on the 1st technical review, we added one requirement (Req 4.5, page 70) and we elaborated the user interface screens and for all requirements related to the clinicians' app and the patients' app (sections 4.7 and 5.9).

## 2.. Literature review

According to task T2.1 a thorough review of the literature has been performed. We have analyzed scientific publications related to monitoring cancer patients in their home environment via sensors and self-reporting: what data is collected, what are the techniques used to collect data, and other relevant aspects.

The literature review article that originated from this task was published:

Parimbelli E, Wilk S, Cornet R, Sniatala P, Sniatala K, Glaser SL, Fraterman I, Boekhout AH, Ottaviano M, Peleg M. A Review of AI and Data Science Support for Cancer Management. Artificial Intelligence in Medicine. 2021 May 24:102111.

## 3.. CAPABLE Concept

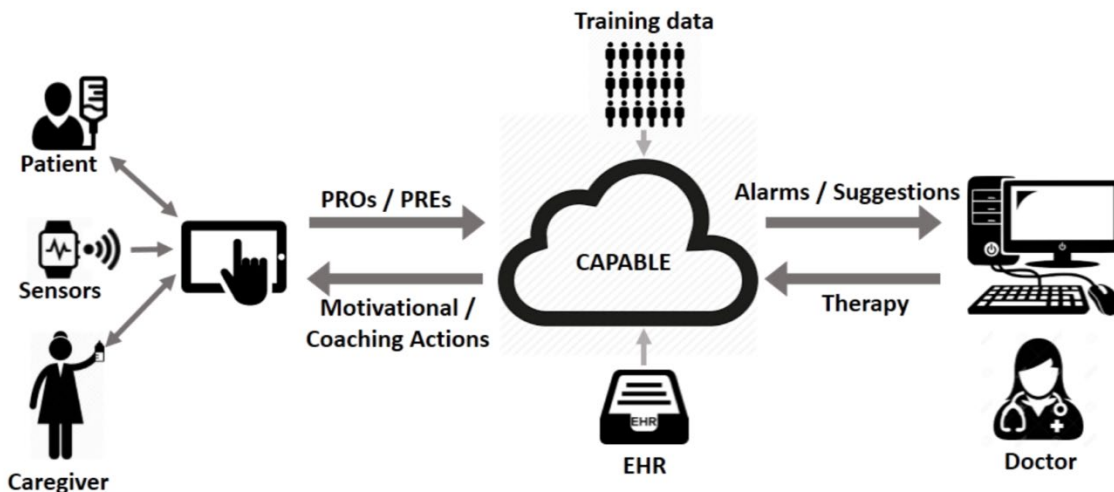


Figure 1. The CAPABLE Concept

To accomplish this task, the CAPABLE “cloud” includes many system components. These are presented in Section 7.

To complement the structural view of the CAPABLE system, Figure 2 presents the workflow of services that CAPABLE provides to patients and their care providers, from the moment of enrollment.

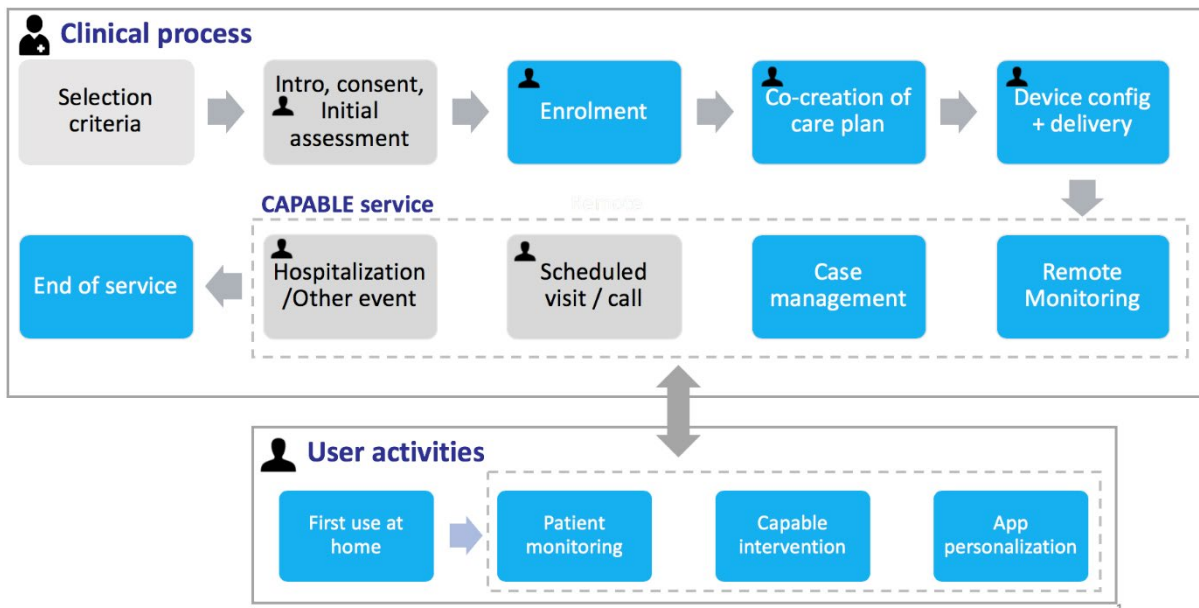


Figure 2. The CAPABLE Workflow model

## 4.. Patient requirements

Patient requirements were collected from three main resources: i) mining AIMAC’s repository containing thousands of cancer patients’ requests and needs, as well as more than 70 thousand messages within its Forum; ii) eliciting patient requirements by interviewing patients and clinicians; iii) drawing ideas from our past experience in developing clinical decision-support systems during the past 30 years as well as from the Literature Review.

The requirements gathered from AIMAC’s repository focus on eliciting patients’ (a) priorities, expectations, wishes, and needs (e.g., communication needs with the healthcare team, which medical services need improvement, need for educational tools, need for decision support), (b) barriers and facilitators related to compliance to therapy, and (c) treatment perception and satisfaction, including, but not limited to ethical and cultural factors, patients’ rights, etc.

Structured and informal interviews were used to both validate the automatically inferred needs and to acquire specific information not available in those sources, such as the intention to use the CAPABLE system.

### 4.1. Methodologies

We combined several methods to elicit requirements for patient users of the CAPABLE system.

- User Centered and participatory design + Qualitative research methods
- Agile prototyping, including psychological approaches combined with validated educational content

These are detailed in the next subsections.

#### 4.1.1. NKI and ICSM interviews

We followed a user-centered and participatory design, causing the intended users of CAPABLE to take active part in defining requirements for the app (Brenner et al., 2016). Qualitative research methods were used to assess the needs and requirements for developing a web-based application as

a decision support system for healthcare professionals and a mobile application as a coaching and support system for patients. Following user-centered design methods and qualitative research methods, we helped the patient think about concrete situations that s/he experienced in order to get more accurate information as compared to that gathered by general questions (Brenner et al., 2016, Mummah et al., 2016). A purposive sampling strategy was used to include a maximum variation of patients (Harding, 2013). Eligible patients were requested to participate in an interview and asked to participate by their healthcare professional. The research team kept track of the patient inclusion, provided patient information letters, and written informed consent was obtained. All interviews were audio-recorded and were done through phone or personally.

To maximize variation in the patient population, we included patients in different paths of treatment:

- Patients with high risk melanoma during ICIs treatment
- Patients with high risk melanoma during follow up after treatment
- Patients with advanced melanoma during ICIs treatment
- Patients with advanced melanoma during follow up after treatment

We strived to interview at least two patients per category so the total patient group consists of a minimum of 8 patients. In total, we interviewed 8 patients but more will be interviewed.

At ICSM we interviewed so far 33 patients in treatment for metastatic renal cell carcinoma (mRCC), our target group for testing the app, and 4 patients affected by other metastatic tumors. These last few patients are under similar conditions and belong to the same age group of the patients with mRCC. In total we interviewed 37 patients.

Semi-structured interviews were performed to collect data, until data saturation was reached. These interviews were based on an inductive research design but will be categorized based on what is known in literature (Harding, 2013). The interview started with collecting data on the current (clinical) situation of the patient. This also included questions on how a patient is feeling on a good or bad day, or the unmet needs of patients during their treatment. After this we explained the features of the CAPABLE app. The questions regarding the content of this app were categorized in two domains, namely (1) acceptability and preferences towards the CAPABLE app, and (2) supportive care and information needs of the patients during and after treatment (Lubberding et al., 2015). To elicit requirements for features of an app that could support their wellbeing, questions were asked about perceived usefulness and user acceptance of the proposed technology. These questions follow the TAM-Technology Acceptance Model (Davis et al., 1989), which is one of the most widely-used models for evaluation of user acceptance of technology. We also tried to elicit from patients' own ideas for needed functionality, according to the principles of user-centered design. Within the (unmet) supportive care and information needs we asked about different subjects according to a systematic review of Wang et al. (Wang et al., 2018).

A list of open interview questions (interview questionnaires – Appendix 10.2.1 for NKI and Appendix 10.2.3 for ICSM & Appendix 10.2.4 for the Patient Interview Guide of ICSM) was used to aid the structure of the interviews. Different sub questions were used throughout the interview to reach saturation of information (Rincon et al., 2017). Interviews took around 45 minutes of patients' time.

The study was approved by the Institutional Review Boards of the NKI and ICSM.



## 4.1.2. Periodic Patient interviews with AIMAC and UNIPV - Methods

---

The clear identification of a process that generates benefits for the patient and his caregiver is a precondition for the creation of a system – operating through an app - that is able to improve the patient's care path. In designing an innovative service, it is essential to keep track of the user's experience to verify its usefulness and giving them back a final product that is accessible, effective and engaging.

“But what is in an experience? Psychologically, an experience emerges from the integration of perception, action, motivation, and cognition into an inseparable, meaningful whole. The intimate relation between those single concepts is reflected by, for example, Russell's (2003) model of emotions, which stresses the importance of cognitive processes, such as self-observation, attribution, and categorization, for the experience of emotions. And most action theories (e.g., Kaptelinin & Nardi, 2006; Carver & Scheier, 1989) assume close links between actions, thoughts and emotions. An experience is a story, emerging from the dialogue of a person with her or his world through action" (Hassenzahl 2010, pp. 8). An experience is subjective, holistic, situated, dynamic, and worthwhile.”

Kotler (2016) explains the importance of a person-centered model in order to design services that are effective. A deep empathy must be established with those whom the service is being designed for. This requires immersing oneself in their lives by understanding their needs and motivations, but also knowing, through them, their parents, neighbors, children, colleagues or strangers who make up the daily community in which they live. This is a precondition when building a person-centered product. There is no limit to creativity, you can generate many ideas and build different prototypes, always sharing every single choice with the people you are designing for and so often coming up with truly innovative ideas.

With this approach it is possible to know in advance if the proposed solution will be successful, since the people to whom the new product or service is about to be proposed are the same people who have been involved during the initial stages of the project.

According to the definition given by the ISO 13407 standard, then revised in 2010 by ISO 9241-2102, a person-centered design aims to create useful and usable systems by focusing on the users, their needs and requirements, applying the principles of ergonomics and usability; its goal is to improve efficiency and effectiveness, increase people's well-being, user satisfaction, accessibility and sustainability.

The **ISO standard** has identified four work phases in which this design is divided:

1. understand the context of use;
2. specify user requirements;
3. create design solutions adhering to the collected requirements;
4. evaluate and improve solutions.

In order to reach an optimal solution capable of responding to the user's needs, an iterative process was put into action. This was repeated several times, at each final evaluation, before moving on to the implementation phase.

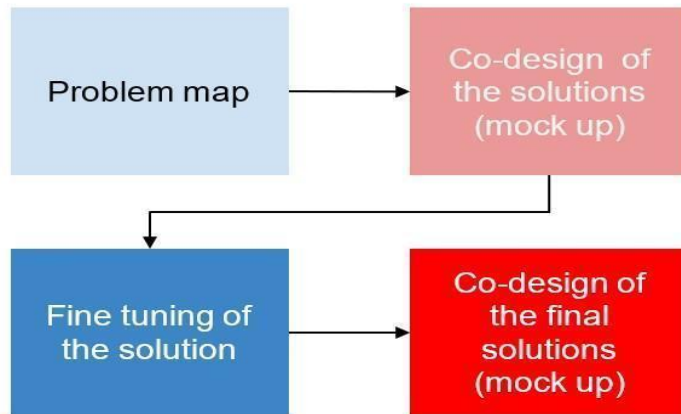
In the most recent literature, the first two phases are considered simultaneously as a discovery phase that revolves around the designer's observation and immersion in the context and problems of the people for whom it has been designed. Once gathered enough information to solve the problem, solutions will be generated. The ideation phase then begins, in which space is left for creativity to interpret the data collected. The third and final phase is about prototyping, in which ideas, based on real feedback from people, are transformed into tangible projects.

In this first phase of the project, the working group coordinated by Aimac formed by expert patients (**Francesca Tracò** and **Elisabetta Iannelli**) and designers (**Silvana Quaglini**, **Nicole**

Veggiotti, Lucia Sacchi from UNIPV, Manuel Ottaviano from UPM) reconstructed the context and investigated the user requirements (patient and caregiver) by simulating the different phases of the care path.

The working group investigated the problems together. Taking for granted that the users do not have the solutions, but are capable to describe and explain their problems, the group worked iteratively on the process which consisted in:

1. Co-construction of the problem map and related hierarchy
2. Generation of possible solutions, through the development of possible mockups
3. Problem reworking
4. Fine tuning of the solution.



### Patient experience design lab

As per **HCD (Human Centred Design)**, alongside the qualitative and quantitative investigations on patients, a laboratory was set up with the specific aim of mapping problems and identifying the needs of patients and caregivers. The meetings were held on a weekly basis between April and September 2020. The workshops have been attended by:

Laura Del Campo and Nicola Di Flora (*Aimac*) as workshop leaders, Francesca Traclò and Elisabetta Iannelli as expert patients (*Aimac*), Gabriella Masiello and Paola Gabanelli as psychologists (*Aimac and ICSM, respectively*), Silvana Quaglini, Nicole Veggiotti, Lucia Sacchi (*UNIPV*), Manuel Ottaviano (*UPM*).

The goal of the workshops was to understand patients’ preferences to inform the app developers in order to implement the functionalities consequently.

The established path followed the patient journey, identifying their problems and possible needs in each phase. Section 4.2.4 presents the main results found in the mockups created for the final output of the co-design laboratory.

## 4.1.3. Covid-19 Questionnaires for patients

The questionnaire (see Appendix 10.2.5) was developed with the aim of investigating the relationship between cancer patients and technology. The lockdown period represented an opportunity to understand, in a situation of clear need, which needs the patients were able to respond to with technology and which other needs remained unmet.

In this sense, the questionnaire retraces the daily experience of care, asking the patient how he used the technology, and investigates the feelings associated with the lockdown period, trying to understand to what extent the technology has been useful and what feelings are associated with its use.

## 4.1.4. Agile prototyping

---

Our informatics team (UNIPV, UH, UPM, PUT, BIT) used Agile software development methods (Lucassen 2016) that advocate rapid software development in which requirements are gathered, software is developed rapidly in small iterations, and are then tested and further improved. The team that develops the software includes developers and potential users -- an approach known as participatory design (Lerouge 2018).

In order to draw from relevant psychological theories (e.g., trans-theoretical model (Norcross 2011), mindfulness, resilience), which are important features in our proposed app, we used the IDEAS (Integrate, Design, Assess, and Share) framework of strategies for the development of more effective digital interventions to change health behavior (Mummah 2016, Peleg 2018).

Another guiding principle was that all examples presented to patients, and all recommendations provided to patients regarding physical, mental and social wellbeing should be evidence-based and all content should be validated by clinicians.

Following these methods, we developed user-interface (UI) mockups that capture the features that we think should be in the app. The ideas for the mockups were based on our previous experience in developing such apps and on the Literature Survey.

The mockups were iteratively developed. They were evaluated by the patient participants using a post-interview questionnaire (See Section 10.2.3 for the questionnaire and Section 10.2.4 for the Guide for delivering the questionnaire) that assessed the perceived usefulness of different features of the system by rating them on a 5-Likert scale. These dimensions of the assessment were inspired by the TAM questionnaire (Abu-Dalbough 2013). As in (Peleg 2018), they considered the perceived usefulness and perceived usability of the future app.

In addition, patient focus groups evaluated ideas and designs for the mockups (Section 4.1.2).

## 4.2. Patient Interview Results

### 4.2.1. Initial interview results

---

A first study with four patients and one caregiver was performed during the kickoff meeting in Rome, January 20-21, 2020. Its purpose was to evaluate the perceived usefulness of a novel feature of the CAPABLE system: mental and social wellbeing “capsules” - see Section 4.5.3. The interviews confirmed that this was perceived as an important feature for patients. We did not collect numerical ratings of system features in those initial questionnaires. The questions asked were those presented in Section 10.2.3.

These interviews resulted in confirmation of 40 system features which we have ideated, as well as several new features ideated by patients (e.g., a screening functionality to assess the patient’s starting point in terms of fitness, nutrition, emotional, social and physical wellbeing to allow tracking of progress; a non-functional requirement of paying attention to phrasing of recommendations and providing graphics that accompany instructions). Features that we had ideated and were confirmed included: patient reporting, tracking and visualization and summarization of progress, gamification to motivate adherence to behavioral change recommendations, reminders and scheduling, mental and social “capsules” recommendations, providing patient education, clinical recommendations, and allowing communication with clinicians.

## 4.2.2. NKI interview Results

---

### 4.2.2.1 Patient characteristics

NKI's interviewed patient population consists of 13 high-risk and advanced melanoma patients receiving immune-checkpoint inhibition (ICI's), also known as immunotherapy. There are two different immune-checkpoint inhibitors, namely; anti-PD1 antibodies (nivolumab, pembrolizumab), and anti-CTLA4 antibodies (ipilimumab). ICI's are currently given as anti-PD1 monotherapy or anti-PD1/anti-CTLA4 combination therapy. Unfortunately, ICIs come with a lot of immune-related adverse events (irAEs). Therefore, this specific patient population has treatment- and disease-specific needs, and are reported by both healthcare professionals (HCP)'s as patients themselves.

#### 4.2.2.1.1. Patient characteristics retrieved from HCP interviews

Reported by the HCP's, not all melanoma patients can be considered as "one". Differences are present in disease processes throughout different melanoma stages. Information needs and the interpretation of quality of life are therefore patient specific, personal and can differ a lot. Medical complaints can be reported due to illness and side effects of treatment, but can also be due to psychological and physical state. A general experience from the HCP's is that the patient does not have enough time with a doctor during an outpatient visit to report all complaints.

Considering the psychosocial state of this specific patient group, there are a few problems arising. Few patients sometimes completely recover from cancer after immunotherapy, after having started a palliative-intended treatment. These patients experience a hard time with accepting, picking up, and finding balance in their new 'normal' life. More generally, patients experience anxiety, panic and uncertainty surrounding their diagnosis, possible recurrence, progression of disease and death but can also feel guilty towards their environment due to the cancer and can experience sadness due to losses on physical and social level (for example work). The greatest reduction in quality of life is seen in the social and physical field.

#### 4.2.2.1.2. Patient characteristics retrieved from patient interviews

Patient group is heterogeneous when it comes to sex, age, therapy, status after/during therapy and side effects. Furthermore, patients all had a high education level. This patient sample therefore reflects the general melanoma patient population.

Negative impact on quality of life differed between all the patients that were interviewed. More consensus was reached in the definition of a "good" quality of life, than the factors impairing it. This again points out the personal view on quality of life. Below some impairments are listed, mentioned throughout different interviews:

- ❖ Losing activities that gave joy, due to treatment/disease
- ❖ Having to quit work
- ❖ Medication disturbing the small moments of happiness (coffee)
- ❖ Insecurity about the near and long-term future
- ❖ Side effects of treatment impact physical and mental state (especially when noticed too late)
- ❖ Negative relationship with doctor
- ❖ Unclear communication from hospital

Lastly, one impairing factor that was mentioned across almost all interviews was the current COVID-19 situation. Since this was mentioned in almost all interviews, we should not underestimate the impact of this situation on cancer patients.

In general, patients were happy with the provided care in the hospital and the relationship with their HCP. Patients feel safe and trusted with their HCP. Also, HCPs reacted quickly to complaints or questions raised by the patient. However, patients also mentioned that they experience doctors being too busy and replacing a lot of work with the nurse practitioner, while patients sometimes have the need to talk to the actual treating oncologist.

4.2.2.2. Patient app needs retrieved from HCP interviews

We have asked HCP’s on their opinion what content and requirements is needed for the patient app according to their experience. HCP’s were positive towards the patient app and think an active approach to the patient is effective. The app should actively ask about the psychosocial and work-related well-being of the patient. Patients should also be able to fill in their medical complaints without obligation. Another feature of the app can be the active offering of additional support.

4.2.2.2.1. General requirements according to HCPs

Since the app generates a certain amount of patient-reported data, HCP’s feel like patients want to see a graphical representation of their filled-in information and (generated) scores over time. This can help understanding and recalling how the patient has felt over a certain period. Furthermore, app developers should take in mind that the information that will be provided has to be evidence-based, the app should be user-friendly and easily accessible and the language use should be “simple”. When app usage is very low, push messages can be send as a reminder to increase app use.

4.2.2.2.2. Needed content according to HCPs

The needed content for the patient app according to HCP’s is presented in the table below and split in different sub-topics. Not all features desired by clinicians will be incorporated. The list of features that will be incorporated are in the Use Cases of Section 4.7.

Table 4.2 Needed content according to HCPs

<b>Information needs</b>
Acupuncture (but probably not allowed within our hospital)
Advice on other applications that patients can use
Conversations with children
Energy distribution
Finances and insurances
Fitness and exercising (why is exercising important during/after treatment)
Information about symptoms and side-effects
Information about treatment (insight and effect)
Lifestyle (nutrition/physical activity) and influence on social functioning (work,family,relationships)
Non-interactive information (websites)
Nutrition (supplements)
Phase specific information (when patient starts treatment, when having progressive disease or worsening, patient journey)
Physical activities
Podcasts (fellow patients, nutrition, sex and intimacy, etc.)
Relationships and communication
Sex and intimacy
Sleep
Social activities
Work
Communication needs
Information regarding contact persons of aid organizations
Contact with fellow patients
Patient associations

<b>Interventional needs</b>
Mindfulness
Creative therapy
Relaxation
Supportive/additional care needs
Making role of support consultant in AvL visible
Offer psychological support through app
Self-help when providing information
Certified referrals to additional care
Information about paramedical care providers (physiotherapist, lymphedema therapist, occupational therapist, rehabilitation doctor)
Information on psychosocial care at home (CareForCancer) and/or walk-in houses

4.2.2.2.3. Facilitators and barriers according to HCP’s

HCP’s were very positive towards the currently existing ideas regarding the patient app. They feel like the app is a valuable support for patients and the app is capable of better providing (personal) information needs. Digital self-reporting of patients is more consistent and instead of overloading the patient with several packages of information on paper, this app can bundle and provide concise information. To facilitate successful implementation and use of the app the doctors should be clearly motivated for the use of this app. Furthermore, the way this app is provided (easily accessible and clear platform) is key. Possible barriers for implementing this app is that HCP’s do not want to overload patients with too many questions, as well as asking about currently irrelevant medical complaints and symptoms. Another possible barrier can be the risk of patient isolation by providing digital contact only.

4.2.2.3. Patient needs retrieved from patient interviews

4.2.2.3.1. Current support and supportive care needs

Patients’ support systems differed; some patients received support from partners, friends or family, other patients received support from professionals (general practitioner, social workers), and other patients did not need any support. Again, the need for support and supportive care differs per patient. Mentioned in interviews, and also reflecting the outcomes of the HCP interview, doctors could have mentioned the option for referral to supportive care earlier. Miscommunications between doctors and patients about this manner occur. Chances for improving referral to supportive care are present.

4.2.2.3.2. Current internet/app use and needs for app use and support

Most interviewed patients make use of apps and the internet. The main use of internet and apps for the patients is for communication, games, and mostly mentioned, retrieval of information. Furthermore, some patients use smartwatches and use apps for looking into their personal data. Patients were generally very enthusiastic and open-minded for the use of an app and sensors during treatment. However, as mentioned by almost all the patients, the need for such an app should be without obligations and is depending on the period/phase and wellbeing of the patient. Patients should not be overloaded with information (especially not in the beginning) and should be able to pick the information they want at their own timing. Lastly, we should take the older population in mind that do not use apps on phones. Some patients liked the ideas of the app, but would only use this web-based.

4.2.2.3.3. Intended way of use and user needs

Patients differed in the way they would like to use such an app in the future. Most patients would like to use it for gathering information and as support (for quality of life). Nevertheless, patients

were also interested in using the app for monitoring personal data and symptoms. Furthermore, some patients see value in using it for medication reminders. Most patients acknowledge that this app is more accessible and low-key instead of calling to the hospital or asking HCP’s questions directly, and is therefore helpful. Patients mentioned different desired functionalities of the app. For example, the app can replace daily alarms by offering medication reminders in this app or have an agenda connected. Referral to supportive care should be available in the app. Lastly, the patient should be able to make notes in the app, for example as preparation to a consultation with a HCP. When it comes to a signaling function in an app, patients feel that an app is more proactive when handling symptoms of side effects. A few patients feel it is useful to monitor a list of symptoms, both for themselves as for the consultation with the HCP. Furthermore, the patient and HCP can act earlier on concerning symptoms. The patients wish feedback after entering complaints into the system, by either the system or the doctor. Entering data should not be mandatory, but a daily notification as a reminder can be given. Patients do not think the app will change the way they reach out to the hospital and some feel enough information is already provided by the hospital. However, patients see added value of the interventions and education/information in this app if it is evidence based and covering different disciplines.

#### 4.2.2.3.4. Information needs, remote patient monitoring needs and needs for other content

While information was available, almost all patients experienced unmet information needs. Patients would like to receive information about melanoma and immunotherapy. A majority of patients would like to have access to information regarding self-management (*i.e.* nutrition, physical activity, fatigue), managing work and cancer, and healthcare or supportive care services. Other, but less frequently mentioned information needs consisted of managing (cancer-related) anxiety, sleep problems, and informative statistical information regarding survival or treatment response.

When asking about adding possible interventions to an app, the majority of patients would like to see interventions concerning relaxation and mindfulness, such as yoga and creative therapies. Furthermore, some patients would like to have interventions regarding doing physical activities such as walking (which can be combined with relaxation interventions).

The majority of patients mentioned a high need for some form of peer support in an app. Two forms of peer support are described by these patients. Firstly, patients would like to read about experiences of fellow patients such as how to deal with certain side effects or what their experience was with experimental treatments. Secondly, some patients would like to be able to communicate with other patients, for example via a patient forum functionality.

More than half of patients see benefits in reporting symptoms and side effects via an eHealth application. The primary benefit of using such an application would be to receive feedback regarding symptom management from either the application itself or from their clinician. Patients expected their motivation to report symptoms would rapidly decline without receiving feedback. Less than half of patients were interested in using sensors during remote patient monitoring.

A complete overview of identified patient information and remote monitoring needs for eHealth applications is shown in the table below.

Need	Suggestions for content in order of importance*
Information and education (text-based)	Side effects

	<p>Nutrition</p> <p>Treatment</p> <p>Additional care options</p> <p>Physical activity</p> <p>Managing work and cancer</p> <p>Diagnosis</p> <p>Tips on managing anxiety and cancer-related rumination</p> <p>Medication</p> <p>General health and lifestyle tips</p> <p>Fatigue</p> <p>Prognosis, survival, statistics and clinical trials</p>
Interventions	<p>Mindfulness</p> <p>Relaxation</p> <p>Interventions for physical activity</p>
Peer support	<p>Experiences of fellow patients</p> <p>Contact with fellow patients (social forum/buddy system)</p>
Remote patient monitoring	<p>Symptom (adverse events) monitoring</p> <p>Use of sensors/wearables (to track sleep, steps, temperature, blood pressure etc.)</p>

HCP: healthcare professional

\*Majority of patients mentioned the need for evidence-based content

#### 4.2.2.3.5. Information presentation needs

Complying with the opinion of HCP’s patients also want to see concise information and would like a graphical presentation of their data. Different patients would like to have insight in their own data (from sensors or entered, like symptoms and questionnaires), presented in a graph over time. When presenting information to a patient as a function of the coaching system, this should also be summarized, but complete. A search function can be added to look for additional information, depending on the needs of the patient.

#### 4.2.2.3.6. General/additional needs

Throughout the interviews, the patients mentioned different general needs for the app. As mentioned before, some patients value the system to be available as a mobile app but also as a web-based tool. Furthermore, the app should be user friendly and different age groups should be taken



into account when designing this. The app should be up to date and not be a duplicate of already existing platforms. Patients stated to make use of the app dependent on the need of patients and to motivate patients for use it would be a requirement to receive feedback following data entry. Most patients expected the privacy to be well arranged upfront and did not have extra ideas on this matter. However, it is an important topic to be covered.

### 4.2.3. ICSM interview Results

ICSM is still in the process of interviewing patients. So far, we interviewed 37 patients between July and October 2020.

The patients were interviewed according to the methodology described in 10.2.3 and 10.2.4. The interviews were recorded and stored anonymously. Due to technical problems, 7 recordings were discarded. All the 37 patients filled in the pre-interview and the post-interview questionnaire (see 10.2.3). For this deliverable, we focused on the outcomes of these written answers. The written questionnaire is aimed to investigate the demographics of ICSM’s patients, if they use a phone, how they live their condition and if the app (shown as mockup) can appeal them. The results of the semi-structured interview will be analyzed at a later stage. Below, preliminary results are shown.

#### 4.2.3.1 Patient characteristics retrieved from patient interviews

We interviewed 37 patients, whose age ranged between 39 and 80 years (average 61 years). 27% female, 73% male, a big part of which is already retired (43%). All of them are currently on treatment. Most of them (89%) are affected by metastatic renal carcinoma, the others are metastatic cancer patients too.

ICSM’s patient population consists of people receiving immunotherapy (ipilimumab, nivolumab, atezolizumab) or antiangiogenic drugs (sunitinib, cabozantinib, pazopanib). The therapy can consist of a single drug or a combination of two or more drugs according to standard protocols or clinical trials.

84% of the patients live with their family, 16% lives alone. Ten out of 37 patients (27%) have a caregiver, who is also a member of the family. The 57% of the patients are still working, 43% are retired.

Most patients (89%) use smartphone apps or internet. The main use of internet and apps for the patients is for work (47%), entertainment (47%), retrieval of information (38%), communication (32%). Furthermore, 5 patients use smartwatches to track physical activity and lifestyle habits. During the interview, patients were asked four questions that required an answer on the 1-5 Likert scale. These are reported in Table 4.2.3.1.1.

Most of the interviewed patients are neutral on the burden that their clinical condition has on their quality of life. This could mean they are not able to quantify the impact of the disease on their quality of life, even if in the open part of the interview they often mention pain and discomfort as having a negative impact on their daily living.

The majority of the patients is positive on the use of an app that would support them on the management of treatment and adverse events.

Table 4.2.3.1.1 Patients’ answers regarding desirability of the app (intention to use)

	1- Strongly disagree	2- Disagree	3- Neither agree or disagree	4- Agree	5- Strongly agree	No answer
Being a cancer patient, my quality of Life (QoL) and my wellbeing is compromised	3	9	15	8	1	1

It is difficult for me to find ways to improve my QoL and wellbeing	3	15	12	6	1	0
I will probably use an app that would provide me information about coping with ADEs, problems sleeping, anxiety, diarrhea, etc.	3	5	3	18	8	0
I will probably use an app that provides me with information on the effects of drug use, degree of personal risk, and advise on developing mental resilience and ways to deal with stress crises, based on my personal and current situation data	3	4	1	19	10	0

Patients were asked to answer yes or no to the following question: “We are working to create an app to assist patients during the treatment of cancer. Would you use an app like this?”. Twenty-seven patients (73%) answered that they would use the app, 4 patients (11%) said that wouldn’t use the app, and 6 patients (16%) did not answer.

Table 4.2.3.1.2 shows a list of functionalities that were proposed to the patients, who were asked to rate them as highly desirable/desirable/not needed. All the listed features have been rated mostly desirable or highly desirable. In particular, educational material on the side effects and physical activity monitoring had the highest number of preferences. Functionalities related to emotional support are considered not needed for some of the interviewed patients. This can also be due to the fact that these patients are not used to take care of those aspects of their lives, especially through the use of a smartphone app.

Table 4.2.3.1.2 Evaluation by patients of proposed system functionalities

	1- Not needed	2- desirable	3- highly desirable	No answer
Educational material related to the condition	5	20	9	3
Educational material related to treatments and side effects	2	14	18	3
Support to manage emotional distress (anxiety, depression, stress)	9	16	10	2
Provide messages to promote positive thinking	11	18	6	2
Lifestyle change program to improve habits	7	18	10	2
Increase / control of physical activity	4	21	10	2
Improvement of sleep quality	8	17	10	2
Support in accepting the reduced QoL / physical disabilities induced by the cancer treatment	7	17	7	6
Support for pain management	6	14	14	3
Support for promoting adherence to treatment	5	16	12	4

Finally, we asked patients two further questions about the devices they are currently using and their preference regarding the possibility of installing the CAPABLE app on their smartphone or on

another phone. The answers to these questions can help app developers to evaluate different implementation strategies.

Nineteen patients have an Android smartphone, 11 have an iPhone, and 1 patient uses both systems. Of the remaining 6 patients, three don't have a smartphone, one did not reply, and 2 are not interested in the app.

Out of the 31 patients who are currently using a smartphone and who would be interested in downloading the app, 30 would prefer to download the app on their own phone, and only 1 would prefer a new phone. We also asked if, in case a new device with the CAPABLE app was anyway provided by the project, patients would prefer to keep using two phones (the personal and the CAPABLE one) or use the CAPABLE phone also for personal purposes. Fifteen patients would keep using their phones, whereas 14 would use only the CAPABLE phone. Two patients can't decide among the two options.

These answers underline that the preferred option would be to create an app able to run on the phones that the patients already have.

#### 4.2.3.2 Preliminary considerations on patient's interviews

During the interviews we showed to the patients the mockup of the CAPABLE app and most of them showed a general interest in it. They acknowledge the usefulness of the app, especially regarding the functionalities related to symptoms, vital signs, and reminders.

They consider the app already quite complete, with most of what is needed in their everyday use. ICSM patients are used to call our department in case of need, they have a good relationship with the healthcare providers, so we believe that the app will help them to feel more confident in tackling mild adverse effects of their treatment. This could potentially reduce the number of calls. They are enthusiastic about the fact that the healthcare providers can have an overview of their overall wellbeing over time, this will make them feel even more taken care of.

Another part that sparked the interest of the patients was the possibility to be in contact with the local doctors specialized in nutrition. Very few patients have severe nutritional issues but they are still curious to understand if there are ways to improve their health through food.

The mockup also reported a psychological questionnaire, whose answers were judged as not completely clear by the patients. In Italy, especially within the age group of our patients, psychological wellbeing is still not considered a priority. That can also explain why capsules (see Section 4.5.3) connected to mental wellbeing received lower rates with respect to clinical functionalities.

Instead, the capsules with a direct scope, like improving sleep or exercise more were generally considered useful (with differences connected to patients' personal health status).

## 4.2.4. Results of Periodic Patient interviews with AIMAC and UNIPV

---

### Patient's profiling during enrolment

Patients say that it's very important, during the first visit, to profile the patient not only from a clinical point of view (medical history) but also considering:

- Physical activity profile, in order to be able to design a personalized rehabilitation path and/or a physical activity plan useful for improving the therapeutic response and the quality of life.
- Psychological profile, also informing patients about the psychological support services within the hospital or offered by patients' associations (e.g. AIMAC is present at Maugeri with its volunteers)
- Nutritional profile, to offer patients with a dedicated nutritional plan alongside the therapies.

Moreover, it's important to investigate other issues potentially affecting the quality of life and overall well-being (such as sleep problems).

Patients complain that during the enrollment these aspects, in particular nutrition, are not taken in due consideration. Interviews with doctors confirm this observation, since the routine in both hospitals is to call the nutritionist or the physical therapist only when the oncologists think there is a severe problem (but in this way no prevention is done); about the psychological support, the oncologists simply advise patients about the possibility of that, since they are concerned that directly pushing a patient towards a psychological screening may be a critical action. In this area there is clearly an unsolved need, so there is room for possible development for CAPABLE. Since it's difficult to change the doctor's routine, due to lack of time and organisational pitfalls more than by negligence, we need to put particular attention to implement personalised educational material about those aspects. But, how to acquire patients' health literacy? Is there a risk to offend the patient by asking him what he knows and what he does not know? AIMAC patients say that if questions are done in a kind or playful way there is no such a risk. Thus, we can think about an app functionality that asks a set of questions and delivers a "passport" as a reward to a patient when he achieves a good score. As a matter of fact, it is very important for the patient to be aware of what he knows or doesn't know. CAPABLE could carry out an early education service on various issues related to the disease.

### **Different roles that could have access to the app**

We posed this question: *Is it important that the app is used only by the patient or also by her home caregiver(s)?* There are two types of situations that could justify an active role of the caregiver:

1. When the patient is sick and finds difficult using the app
2. In case the patient does not have the necessary digital skills.

The main observations that emerged are:

- too many actors are detrimental
- the patient must decide who is allowed to see the data
- the general practitioner (GP) could have an important role
- the information must be well-organized and easily accessible, for example designing effective and nice infographics of temporal trends

CAPABLE does not involve GPs by design, thus we have to figure out a simple way to address this issue. The simplest way is to have the functionality "report for GPs/other healthcare professionals": this could produce a PDF with a summary of patient data and trends (also with infographics) that the patient can send to his GP via email to be sent to the doctor. This means that app will provide an export functionality that will provide detailed information of the therapy, overall conditions and health status of the user along the use of the Capable service.

### **Other hints on the App functionalities**

1) we are worried about the possibility that patients forget to communicate, through the app, any change in their symptoms. We think that they are very likely to enter a symptom as soon as it arises, but it's less likely they will enter a symptom change or relief. Patients agree about this risk. A proposed solution is that, when a symptom is entered, once a day the app reminds them to update the information if any change occurred.

2) about reminders for pills: it is possible to remind patients to take medicines at the due times (i.e., a specific alert for each medicine), or it is possible to show patients, twice a day, a summary of the

“drugs of the day” and ask, in the evening summary, a general question about adherence. Most patients prefer the first solution

3) about the educational functionality, we asked if phrasing used in the AIMAC booklets is well-understandable by all patients, in such a way to use sentences reported in the booklets for the educational material of the CAPABLE app, and also to produce “tips of the day” that the app will show from time to time to patients. AIMAC patients confirmed that booklets have been developed for patients and caregivers, they are written in a simple way, while being based on scientific evidence. Up to now they did not receive any complaint on the booklet phrasing. So, the booklets can be used to extract the “tip of the day”. It can be shown in affirmative form (e.g. “Drinking at least 2 Liters of water a day is a good habit”) or in interrogative form (e.g. “Do you know why drinking at least 2 Liters of water is important?” and then click to read the answer), this way stimulating the patient’s curiosity. The affirmative form is adequate to intervene on a specific patient’s need, while the question is more appropriate for educational purposes.

Phrasing is also important when prompting the patient for symptoms reporting. We must go through the CTCAE classification of the adverse effects in order to

- Select the symptoms that can be entered by the patient (CTACE also includes toxicities that are only detectable through diagnostic tests)
- Detect the labels that are not well explained or that are too difficult to understand for patients and modify them accordingly

4) about the timing and the type of the tips to show to the patients, it’s worth noting that: patients in treatment who show treatment toxicity and patients who show disease recurrence are *very different patients*, and patients are particularly anxious when (a) control visits are approaching, (b) they are waiting for examination results, (c) the next therapy cycle is approaching Thus, in those periods they could benefit from mental well-being interventions.

### Sensors

We asked “Are patients already familiar with smartwatches? May any skin problem impair using them (skin rash could be common in those patients)?”. Patients answered that sensors are not that common and are expensive. This could be a barrier, more than skin problems. Usefulness of sensors should be emphasized during the enrolment phase. As a medium-long term objective, a smartwatch that has been demonstrated to improve health outcomes should be reimbursed by the national healthcare system (as now it is for the glucose sensors). This could highly increase the diffusion.

### The caregiver’s side

As mentioned, during enrollment, patients may agree that the caregiver shares the same app, in order to help them if needed (e.g. when the patient is too tired or too depressed or suffers from any other condition). The data entered by the caregiver are tagged as such, and this is highlighted in data visualization and taken into account in statistics, but for the generation of recommendations those data are considered as if they were entered by the patients.

In the future, we could think of different app functionalities for the patients and for the caregivers, also for allowing caregivers to have their own communication channel with the clinical staff.

As a matter of fact, it happens that (i) caregivers suffer from emotional and psychological problems, but they do not want patients to know as they don’t want to put additional burden on them and (ii) caregivers neglect their issues/business for caring for the patients.

On the contrary, a lot of information may be shared, for example about rights.

### Patients rewarding: CAPABLE as a learning experience

CAPABLE must represent an opportunity for patients to learn and to improve their behaviour in order to have a better quality of life. Through the capsules and other features, the app will help the patient to make choices about physical activity, nutrition and sleep habits.

Patients must understand that using the app is a plus for both them and their doctors (importance of the communication with the medical team). They must feel that on the other side of the app there is somebody who checks incoming data and takes actions to improve their health.

This understanding should increase patients' compliance with using the app, but we can also take some actions to increase this compliance. For example, we can reward patients "virtually", incrementing some scores when they are adherent with the system/doctors suggestions, or we also can reward them more concretely, for example by donating them the mobile phones and the sensors at the end of the study. This possibility will be discussed in the next year.

### **Additional important features for the app**

- links to fun / relaxing / distracting websites such as "radio from around the world", "fluid painting", etc.
- link to a selection of videos of physical activity
- link to a calendar with upcoming *group activities*, for example those organised by NEMO, an association working with cancer patients and organizing physical group activities and that is willing to collaborate with the project (<https://ne.mo.it/>)
- sleep advices

### **The homepage of the CAPABLE app**

Thinking of the learning experience that CAPABLE could activate, it is useful to provide an introduction that will be used for

- Informing the patient about the app peculiarities to better motivate him
- "marketing", i.e. clearly illustrate the CAPABLE app distinguishing features with respect to other similar applications (competitors)

### **PRESENTATION OF THE APP (text to be provided to patients through the app itself)**

The *CAPABLE* app will implement an overall intervention strategy for improving your wellbeing, both physical and mental. It will help you to increase your awareness about your condition, listen to your body and your emotions. This will help you to understand and cope with your needs, to become more proactive, more positive in facing your disease. Probably you will realise that some lifestyle and behaviour change may improve your wellbeing. The app will suggest some exercises, both physical and mental, to achieve your objectives. And it also will help you to assess your objectives and monitor their achievement.

The app is not only a means for reporting your symptoms to doctors (which is crucial indeed), but it will represent for you a real learning experience and something that will simplify your life. We give you some examples. When you go to the doctor for a visit, and the doctor asks you which symptoms you suffered from, you have to remember everything that happened since the last visit, and probably you miss something or do not report in the right detail. With CAPABLE you will enter symptoms as soon as they appear, and this represents two advantages, first reporting will be more accurate, and second your doctor will see what's happening to you through its application. Remember that symptoms type, severity, and duration are essential features for your doctor to understand how to interpret and manage them.

Moreover, when you will enter a symptom, the app will help you in recognizing its severity, not only through a trivial scale (like the usual "no, mild, moderate, severe") but with an explanation of what those labels mean for that specific symptom. The app will also give you suggestions about symptom management. This will be done in terms that you could easily understand, and this also will increase your awareness and ability to cope with symptoms, acting as a reassurance tool when the situation is not critical. No way it will replace your doctor, when something is wrong your doctor will be alerted.

The app will implement a multidisciplinary management of your disease, involving not only the oncologist, but also other professionals like the nutritionist, the psychologist, and physical activity experts. Thus, you will really learn how those aspects are strongly correlated, and how improving one of them will benefit all the other ones. For example, physical activity and/or mental relaxation could improve sleeping, a correct diet could improve coping with stomach and intestinal toxicity and so on.

### 4.2.5. Covid-19 Interview Results

The questionnaire designed by AIMAC was administered in digital form through the AIMAC website, [www.aimac.it](http://www.aimac.it). An Italian and an English version have been released. The questionnaire was promoted through social media as per the list below.

Facebook:

- Post FB 18/04 - 3.314 visualisations, 117 interactions, 17 like, 12 sharings
- Post FB 22/04 - 794 visualisations, 27 interactions, 9 like, 1 sharings
- Post FB 22/04 - 747 visualisations, 19 interactions, 9 like, 1 sharings
- Post FB 27/04 - 1.240 visualisations, 33 interactions, 6 like, 5 sharings
- Post FB 06/05 - 5.182 visualisations, 181 interactions, 9 like, 26 sharings
- Post FB 10/06 - 640 visualisations, 27 interactions, 9 like, 1 sharings

Twitter:

- Tweet 20/04 - 1.924 visualisations, 142 interactions, 15 retweet, 22 like
- Tweet 21/04 - 1.042 visualisations, 23 interactions, 7 retweet, 9 like
- Tweet 22/04 - 503 visualisations, 6 interactions, 2 retweet, 2 like
- Tweet 28/04 - 1.567 visualisations, 49 interactions, 10 retweet, 5 like
- Tweet 06/05 - 540 visualisations, 4 interactions, 2 retweet, 1 like

Linkedin:

- Post IN 20/04 - 242 visualisations, 6 interactions, 4 sharings, 12 like
- Post IN 28/04 - 242 visualisations, 7 interactions, 2 sharings, 6 like

There are 512 completed questionnaires, of which 85% are women and only 15% are men. The highest density is found in the 41-60 age class, which represents a population more used to being active on the network (Figure 4.2.5.1). Also in the research "Knowledge, use and attitude towards digital health tools among cancer patients) conducted in 2019 by the Mario Negri Institute in partnership with Aimac, a higher participation of women was observed, with 75% of participants of female gender.

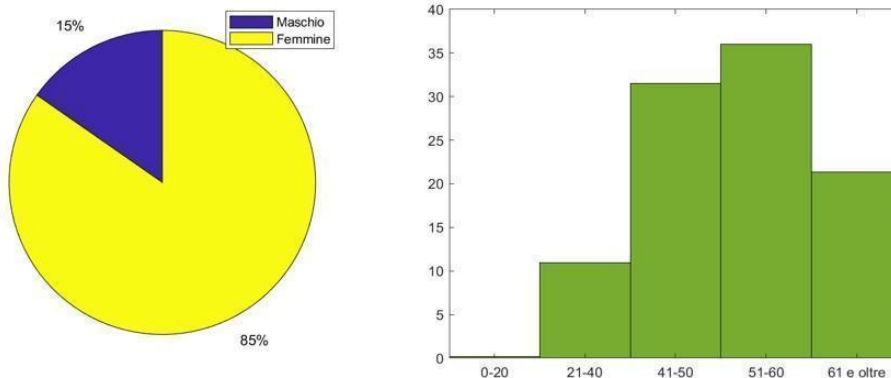
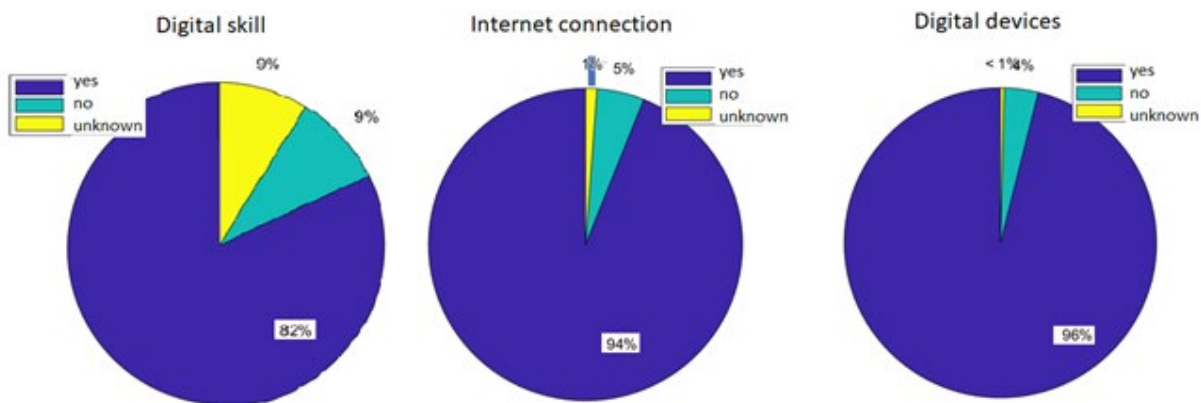


Figure 4.2.5.1 – Gender and age distribution of the respondents to the Covid questionnaire

The wider presence on social networks of women with breast cancer, as well as the greater number of this reference universe has led to a more than representative presence of this type of patient (67%).

We are therefore analyzing these data with the awareness that they cannot be fully representative of the entire population of cancer patients, nor of renal or melanoma cancer patients, but for the purposes of our investigation the information collected is useful for reconstructing the context and the map of the problems that CAPABLE could give answers to cancer patients.

96% of patients declare they have a device, 94% have an internet connection and 82% acknowledge that they have digital skills. This information coincides with what has already been discovered in the survey on the relationship with technology where 94% of respondents think it would be important for their data to be stored digitally. The research shows a high propensity of patients to use digital technology in all phases of the therapeutic process, as also emerged from this survey linked to the Covid experience. (Figure 4.2.5.2)



Let’s analyze the answers to the Covid questionnaire, and what are the main needs that patients manifested during the lockdown, needs that could be supported by the CAPABLE app. Patients report a clear need for support in nutritional choices, and to the question “would need nutritional advice” 67% answered affirmatively (partly occasionally and partly daily), while the remaining 32% said they do not need (Figure 4.2.5.3)

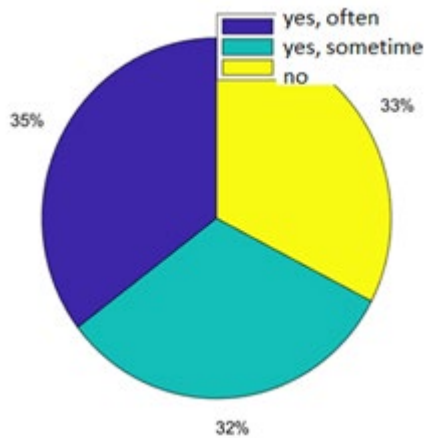
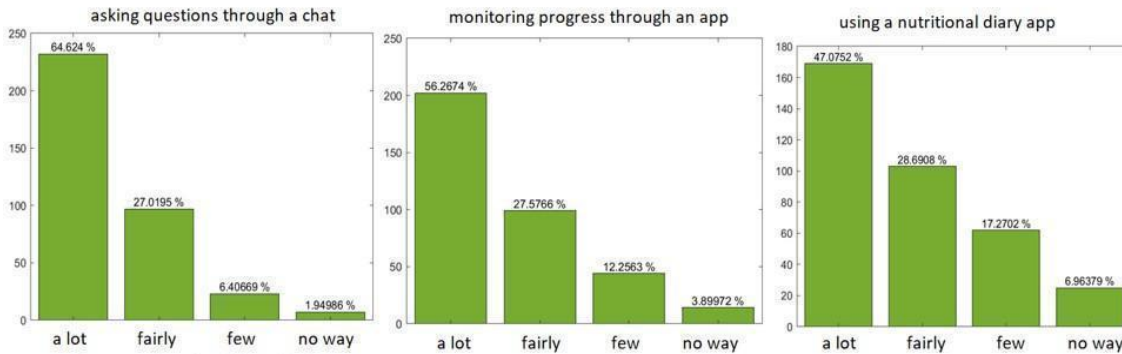


Figure 4.2.5.3 - Need for nutritional support

How to respond to this need is directly indicated by patients: 91% declare through an app; 89% would like advice to be given by a team, demonstrating how much patients are willing to introduce the use of technology into their paths, when it is capable of creating value. The same figure emerges from the research that Aimac carried out in 2018 within the European project INTENT,

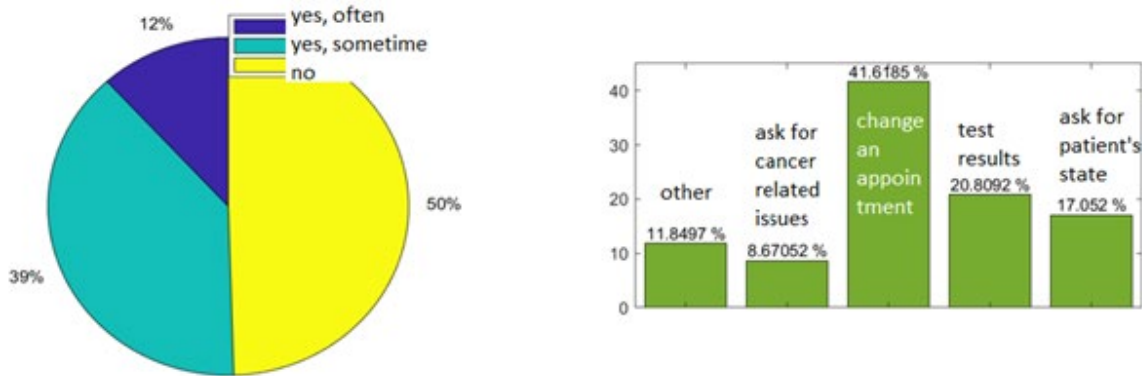


with the aim of understanding needs and possible responses in the care pathways of cancer patients. Also in that case, the availability to use digital technology within the care path emerged, especially when it comes to improving communication with the medical team and guaranteeing greater support to the patient in times of need, for example nutritional counseling, even via the internet when the need arises (**Figure 4.2.5.4**)



**Figure 4.2.5.4** – Patients preference for receiving nutritional information

Another question was about the contacts from the hospital. From the analysis of the questionnaire it emerges that 58% of patients were contacted by the hospital for the management of appointments, while just under 9% to respond to a need for support for treatment.



Just over half of the sample interviewed is overall satisfied with the communication with the care team, while the other half is not at all or not very satisfied. This question provokes an area of potential improvement and high potential for the creation of value for the patient and for the caregiver. The data underline in the Italian case a key area for improvement or coordination between the specialist and the local medicine since the involvement of the treating doctor is important in monitoring the cancer patient. The patients interviewed were considered quite dissatisfied with the remote support of the family doctor, as well as that of the specialists (48%) (**Figure 4.2.5.6**)



By the question “Thinking about the management of your disease, right now, how much you agree with the following statements:” an attempt was made to identify the patient needs and requirements during the particular period of the pandemic.

One question was about how to share information. 89.4% of patients find it useful ("Strongly Agree", "Fairly Agree") to share information such as side effects and clinical data through the app in order to receive some kind of feedback from the care team (Figure 4.2.5.7). This is a very important result for our project because it shows that a large majority of patients endorse the development of a monitoring app, and therefore it is reasonable to expect that adherence to the use of such an app will be high (naturally adherence depends (not only on the features offered, but on many other factors such as usability, graphic form, etc., which will be taken into due consideration during development).

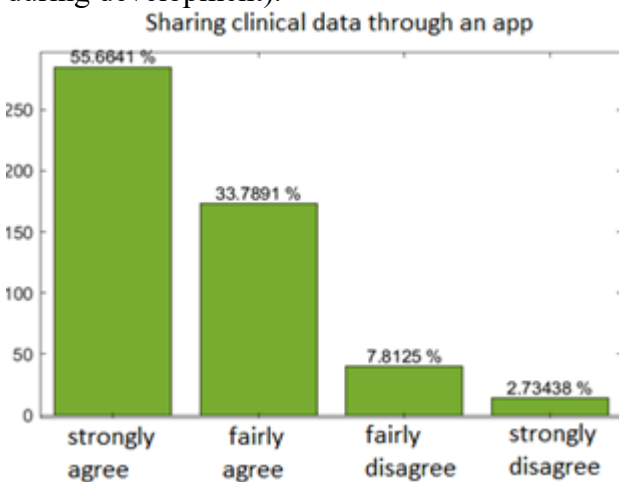
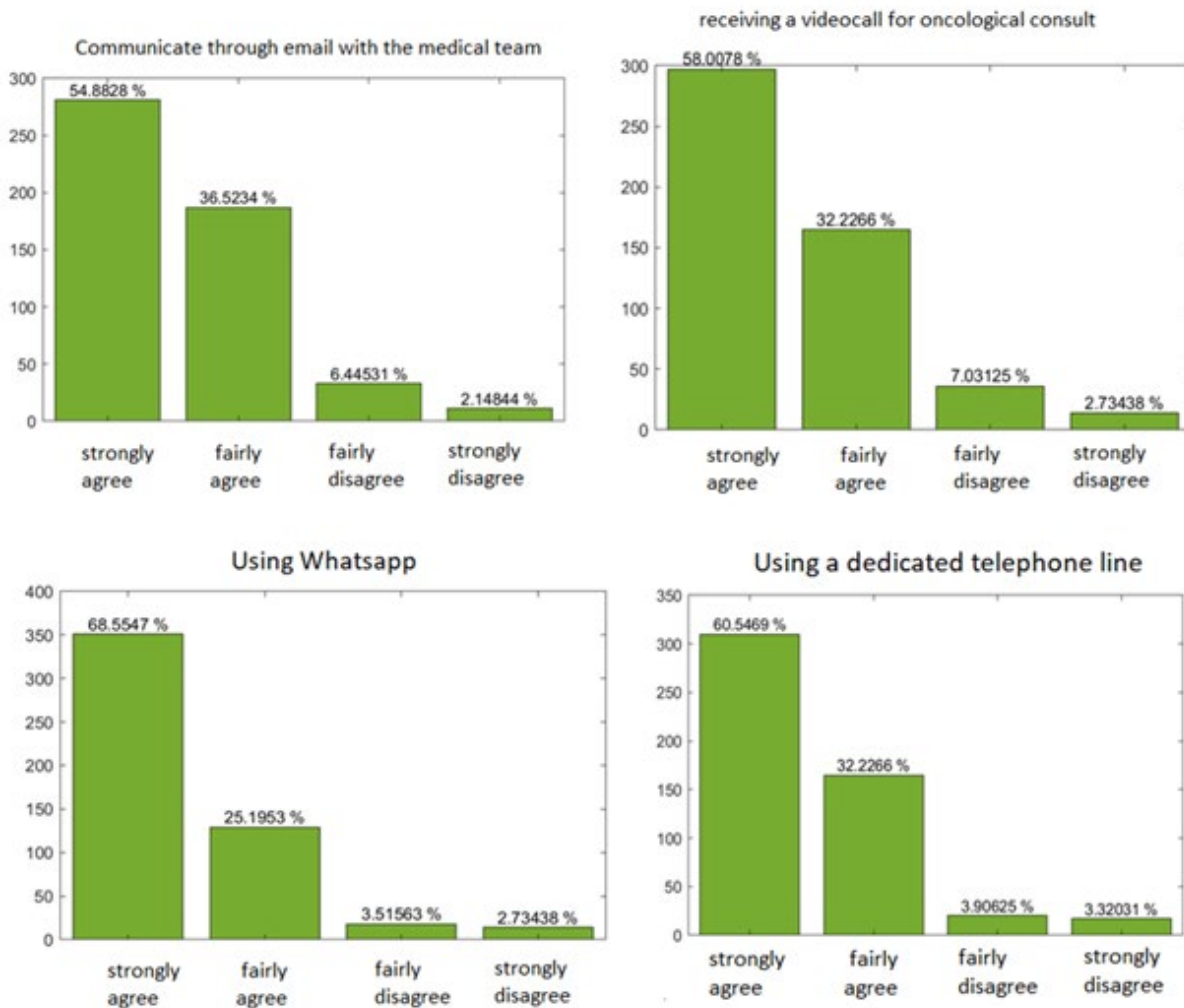


Figure 4.2.5.7 – The communication with an app is appreciated by most of patients

Other technologies are appreciated as well (Figure 4.2.5.8). 91% of patients found it useful to communicate via email with the medical team to request and receive information on the disease. The same figure is confirmed by the research carried out within the European project INTENT, which involved 5 European countries for more than 1300 patients interviewed.

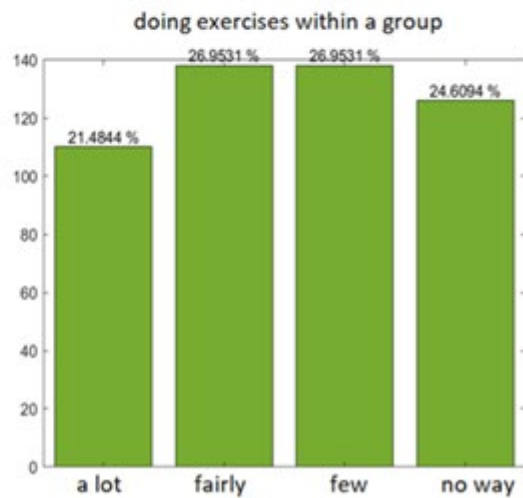
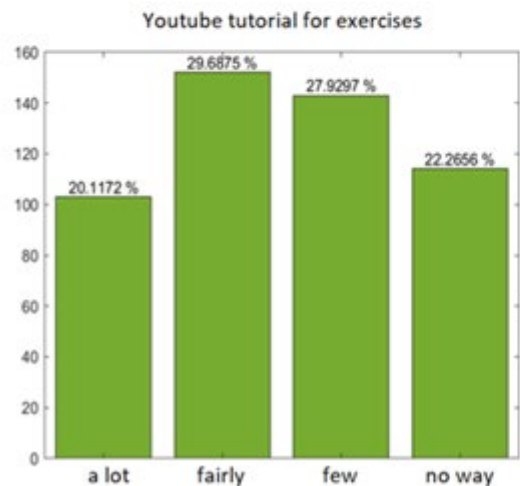
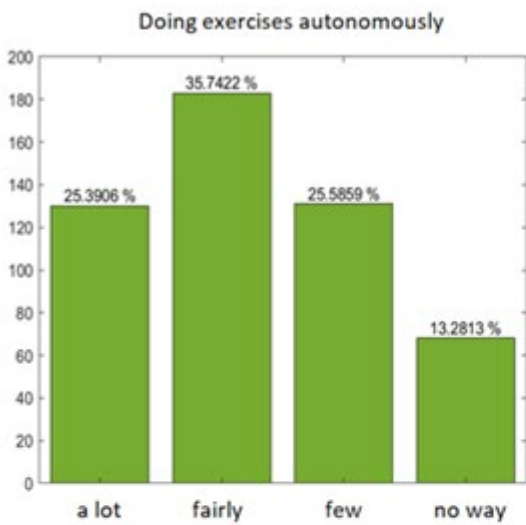
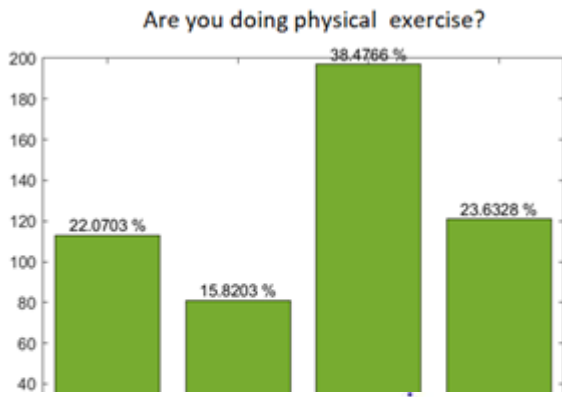
90.2% of patients found it useful to communicate and make video calls to receive oncological consultations at a distance. 93.75% of patients find useful to communicate with the team using Whatsapp (but we know this is not allowed in every country). 92.8% of patents find useful to have a dedicated telephone line. We can summarize by saying that the vast majority of patients agree on the use of communication technologies (whatever they are, including a dedicated app).



**Figure 4.2.5.8** - Patients’ preferences for different communication modalities

#### 4.2.5.1 Physical activity support

Physical activity is crucial for a good state of health, there are many studies that highlight the importance of movement not only to prevent but also to better deal with the disease during the therapeutic process. An app could also be very useful for motivating patients to carry out physical activities that may be prescribed by the doctor. The first step is to understand how much patients are willing to carry out physical activity independently. The answer to the question “Are you exercising? ”With a bar chart in Figure 4.2.5.9 from which it can be seen that 62.1146% practice sports only occasionally or never.



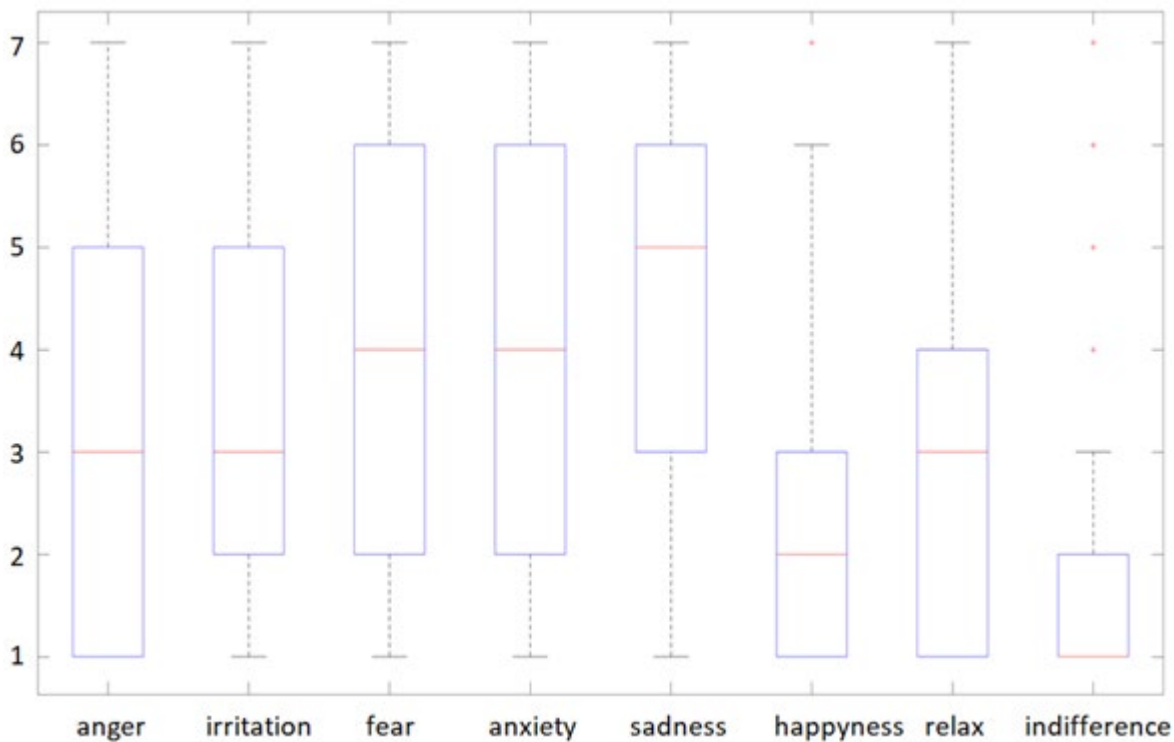
ily  
ery  
f an  
ation  
.  
ir  
ting

positive opinion for this for 46.4%.

#### 4.2.5.2 Psychological Support

In addition to the negative thought of having a serious illness such as a cancer, the therapy and the side effects can worsen the psychological situation of the patient. All this can be accentuated by the sense of loneliness and isolation in the period of the pandemic. We therefore tried to picture the psychological situation of the patient during this covid period.

The first aspect investigated was his state of mind and emotions. For this reason we used the answers to question 3 "What are the emotions / moods you feel most due to this situation?" in which a judgment from a minimum value (1) to a maximum value (7) can be expressed the various feelings / moods. A boxplot was created (see Figure 4.2.5.10) With all the feelings on the x axis.



**Figure 4.2.5.10** – The patients’ rating (on a 1-7 range) for different sentiments during the Covid-19 lockdown

Indifference is the least widespread feeling, i.e. most people feel that they have suffered some consequence (not necessarily negative, note that there are some high values also for joy and relaxation) to the situation of domestic closure imposed by Covid .

One of the reasons why patients may experience certain feelings more than others is the presence or absence of people living together. The answers to the question "These days, who are you living with at home?" to which it was possible to respond with more than one option. Observe the bar chart below:

Most live with someone, only 9,75275% said they lived alone. Also in this case, the information is relevant for Capable's purposes because it shows a growing segment that may need more support through an app precisely in absence of a close caregiver.

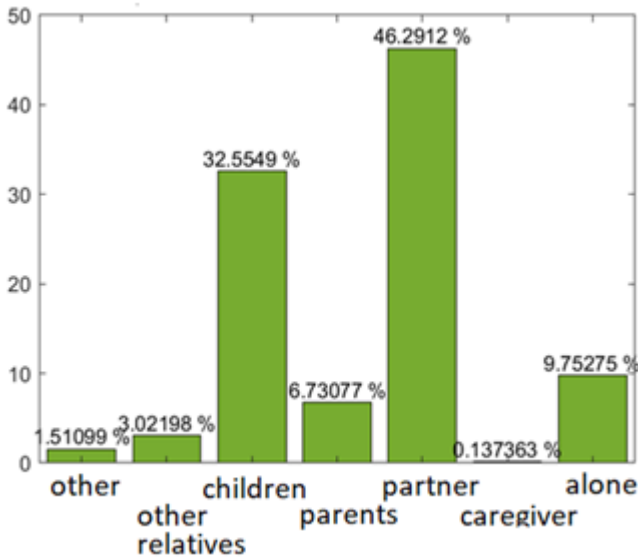


Figure 4.2.5.11 – With whom the patients live

The different judgments declared by the patients were analyzed according to living alone or not. As feelings / moods to be analyzed, anxiety, fear and sadness were chosen.

As for anxiety, the median assumes the value of 5 if the patient is alone against the 4 which instead assumes the case in which he is not alone. This means that the patient tends to be more anxious if he is alone at home. As specified above and precisely in this situation, having a device capable of monitoring the situation in close connection with the healthcare team is a tool to reduce anxiety, stress and thus improve the quality of life and the effectiveness of therapies. (Figure 4.2.5.12)

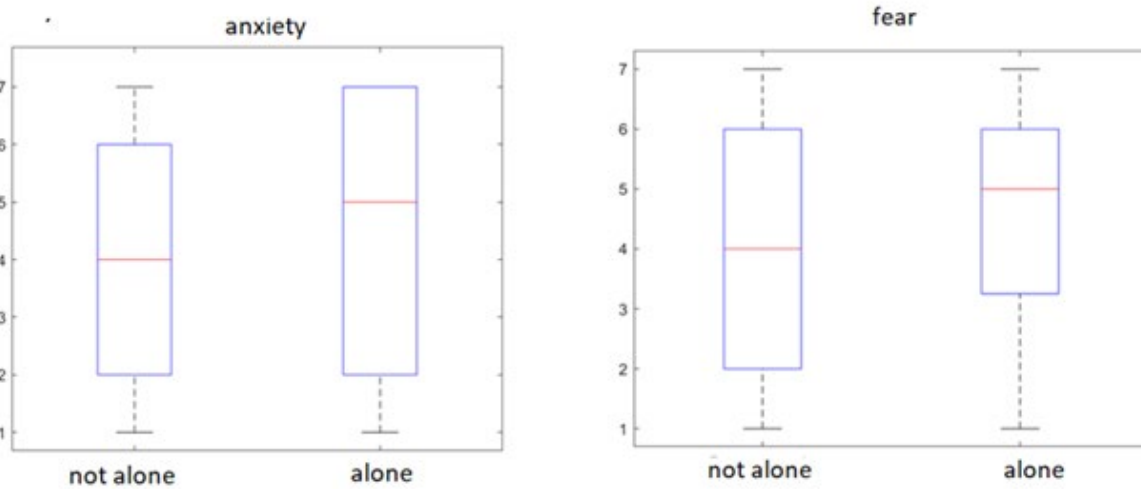


Figure 4.2.5.12 - Patients living alone seem to me more anxious and scared

The same median values are observed for fear, but the narrower interquartile range tells us that fear is even more felt than anxiety in patients who live alone. As for sadness, the medians in the two cases do not change but, the interquartile range changes if the patient is alone assumes a more marked amplitude, i.e. the patients do not generally express an homogeneous judgment between them, but the various judgments declared opens to the overall possibilities

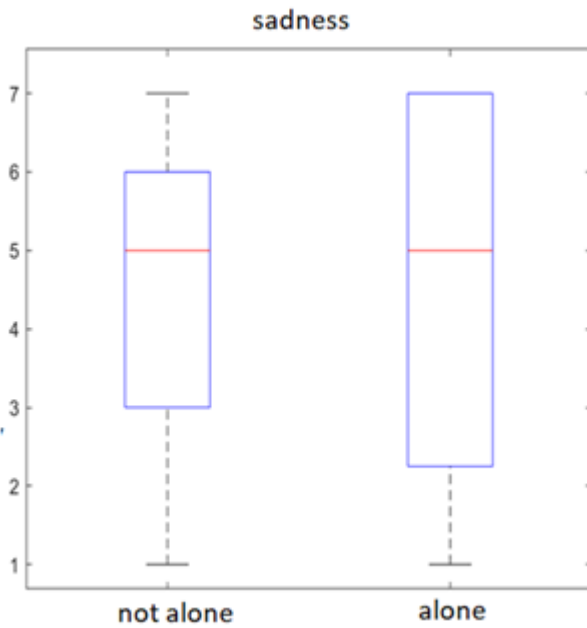


Figure 4.2.5.13 - Sadness is not different in patients living alone or not

To better understand the patient's situation, it is interesting to know how much free time he has during this pandemic period (see figure n.) and how he decides to occupy it (Figure 4.2.5.14), i.e. what types of activities he chooses.

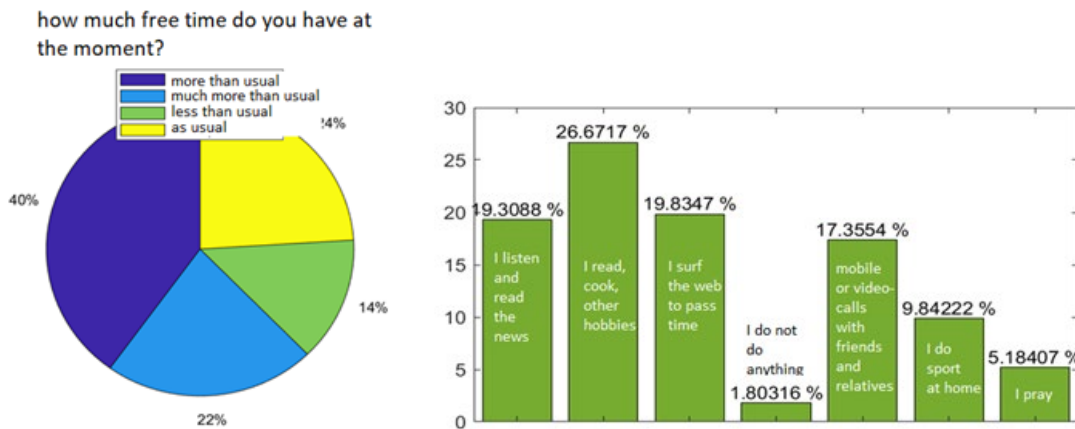


Figure 4.2.5.14 – Free time during the lockdown and how it is spent

Once the patient's feelings and anxieties have been defined, it was necessary to understand how patients managed them. The various side effects can also cause within the patients' different reactions. To do this, questions 8 and 11 were analyzed: (8) "How are you communicating / managing any side effects of therapy?" and (11) "How are you managing your fears and anxieties?" (Figure 4.2.5.15).

The most frequent answers were: "I looked for information on the web", "I asked the family doctor (GP)", "I did not suffer any side effects". Aside from those who had no side effects, about 23% of patients searched the information on the internet (Figure 4.2.5.15).

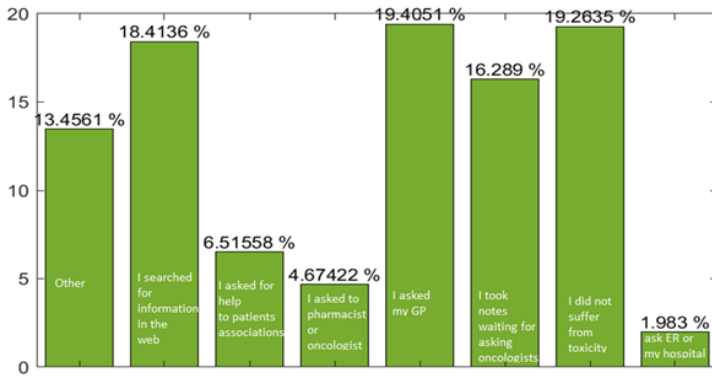


Figure 4.2.5.15 How patients cope with problems due to adverse events communication

The patient responds to his fears and anxieties by calling a friend or by writing on forums or social networks. (Figure 4.2.5.16)

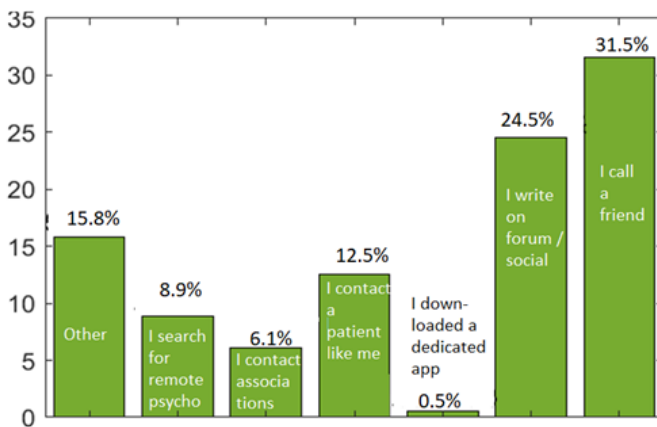


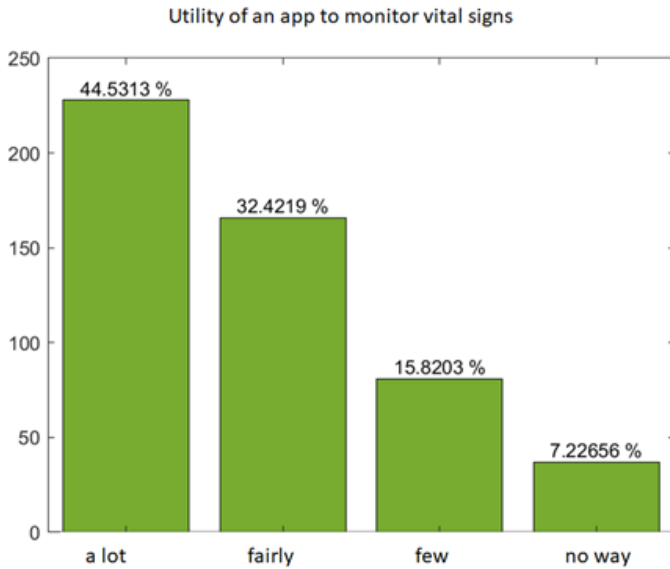
Figure 4.2.5.16 – How patients cope with their fears

#### 4.2.5.3 Therapeutic support

An important aspect of the CAPABLE app will be the features to support the patient in therapy, especially to improve adherence to the therapy itself.

The analysis of the answers of question 10 (Figure 4.2.5.17) “How much would an app for the recognition of vital parameters (pressure, fever, etc.) have been useful in this moment of forced stay?”. It showed that 76.9532% are willing to use the app to monitor some vital parameters, most of which could be monitored in real time through the latest generation smartwatches.

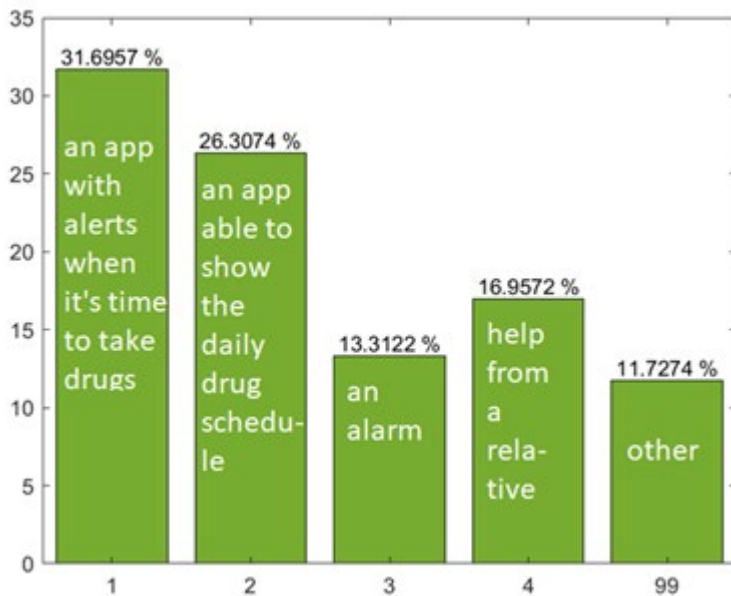




**Figure 4.2.1.17** – perceived usefulness of an app to monitor vital signs

In Figure 4.2.1.18 we can see the answers to the question "What could help you to correctly follow the drug therapy?", where the patient could choose between:

1. An app on a device (Smartphone, Tablet) that reminds me to take the drugs at the correct time
2. An app that summarizes all the drugs taken daily
3. An alarm clock
4. The collaboration of a family member or my caregiver
99. Other



**Figure 4.2.1.18** – Rating the app functionalities for helping with drugs

From the analysis of this diagram it can be seen that the answer with the highest number of consents is "An app on a device (Smartphone, Tablet) that reminds me to take the therapy at the correct time". This obviously will require a considerable implementation effort, considering that (i) sometimes the drug is prescribed for certain times of the day without specifying the exact time (after dinner, before breakfast, before bedtime, etc.); (ii) when there are many drugs to be taken, to avoid constant reminders from the app, they must be grouped by schedule; (iii) it will be necessary to implement the response options to the reminder ("ok, drug taken", "postpone", "I did not take the drug"). However, it is hoped that the implementing effort will be rewarded by greater adherence to therapy and therefore by a benefit to the patient's health.

## 4.2.6. Integrated User Needs

---

In this section, we summarize the main needs that have emerged during interviews with patients at the two hospitals and with AIMAC patients.

### Design of the app

During the interviews, we showed to the patients the mockup of the CAPABLE app. Most of the patients acknowledged the usefulness of the app, especially regarding the functionalities related to symptoms, vital signs, and reminders.

Some requirements explicitly addressed by the patient highlight that the app should be user friendly and that different age groups and different levels of technological skills should be taken into account when designing it. For example, some patients proposed large buttons, a low number of menus/options, and speech to text functionalities.

Patients would like to see concise information and would like a graphical presentation of their data (from sensors or entered, like symptoms and questionnaires).

### Profiling of the Patient

Besides clinical information, patients consider important also the following (note that most of the following requirements emerged also from the interviews with AIMAC patients, previously reported in this document):

- Physical activity profile
- Psychological profile, also informing patients about the psychological support services within the hospital or offered by patients' associations
- Nutritional profile
- Sleep problems

The CAPABLE system will take into account this information by creating a personal profile of the patient during the enrollment visit. The following interventions will be personalized according to such a profile.

### Home management of the disease - Monitoring treatment and adverse events

Patients were interested in using the app for monitoring personal data and symptoms. Patients want to report symptoms when they arise. Entering data should not be mandatory, but when a symptom occurs, they will be asked to enter updates daily, also to report on the end of the symptom episode. The patients feel that reporting symptoms will allow an earlier management of the adverse event. Several patients would like to receive therapy reminders from the app. Such reminders should include both cancer treatments and other therapies not related to cancer.

### CAPABLE as a Learning experience - Capsules and educational material

CAPABLE will represent an opportunity for patients to learn and to improve their behavior in order to have a better quality of life. The CAPABLE app will deliver such learning experience through the capsules and the educational features, which will enable patients to learn a better lifestyle, develop mindfulness, be able to listen to their body, and to better report symptoms and signs. Receiving educational material related to the management of adverse events and on nutrition is seen as very important, also from a set of patients who complain this type of material is not routinely delivered by healthcare professionals. Patients see as an added value the fact that the interventions and education/information are evidence-based and cover different disciplines. Moreover, the educational material can be personalized according to the patient profile. On the other hand, patients don't want to be overloaded with information (especially in early stages) and want to pick the information they want at their own timing.

### **Communication with healthcare providers**

The opinion of the patients regarding the communication with their healthcare providers is heterogeneous and depends on the clinical center and on their personal experience. For example, from interviews with AIMAC patients, only a half of them is overall satisfied with the communication with the care team, while the other half is not at all or not very satisfied. Independently on the level of satisfaction with the current ways of communication, most of the patients see the app as an easy way to improve such communication. Moreover, they consider the app more accessible than making a phone call to the hospital or directly asking a question to the physicians.

Patients think it is important that the healthcare providers can have an overview of their overall condition over time, even between visits. They also believe it is important to have feedback from the system, as this makes them feel that on the other side of the app there is somebody who checks incoming data and takes actions.

### **Nutritional support**

Nutritional advice emerged as an important need for most of the interviewed patients, both concerning healthy nutritional habits and interactions between food and treatment. Patients feel that these aspects are currently often overlooked during oncological visits. Interviews with doctors confirm this observation, since the routine in both hospitals is to call the nutritionist or the physical therapist only when the oncologists think there is a severe problem.

CAPABLE will bridge this gap both by supporting the patient with a dedicated monitoring of the nutritional status, providing specific educational material, and, importantly, offering a direct communication channel with the nutritionists.

### **Psychological support /supportive care**

Psychological support is not currently included in the standard workflow in the hospitals involved in the project. Even though a psychological service exists in both hospitals, the possibility of taking advantage of it is only mentioned to patients, but then it is left to personal initiative. This, especially for patients who do not consider psychological wellbeing as a priority, might result in a lack of intervention even for subjects who would instead need it.

CAPABLE will allow an early monitoring of the psychological condition of the patients through a set of simple questionnaires, which will be able to identify critical conditions and refer these to the specialists.

Since caregivers might also need emotional support to cope with the burden of their role, CAPABLE can be used as a way to provide such help.

## **4.3. Data analysis from AIMAC forum**

### **4.3.1. Quantitative analyses of the AIMAC forum messages**

---

Results of the preliminary analyses carried out on the AIMAC cancer patient forum have been already reported in a previous deliverable (D5.1). In the following we report on the follow-up activities aimed at eliciting patient requirements for the CAPABLE system, based on cancer patients' discussions on the AIMAC forum.

### **4.3.2. Question detector**

---

To find the doubts and the needs of the users of the AIMAC forum, the elaboration of the forum data focused on the detection of posts that contain questions.

Various tasks were carried over to address this problem. They are described in the following subsections.

### 4.3.3. Keyword extraction and classification

Definitions:

n-gram: a sequence of n lemmatized words, that appears in one or more posts. The value n can range from 1 (a single word) to any number.

Keyword: an n-gram that may express doubt or that have a great probability to appear in a question. A post that contain one or more keywords, is a good candidate as a question post, so the presence of keywords is used as a criterion to automatically select interesting messages for further elaboration.

The first step to use this criterion, is to extract the n-grams that appear more frequently in all messages. In our elaboration, n ranged from 1 to 5. The extraction procedure is applied on the lemmatized text and uses the Part-Of-Speech (POS) tags to automatically eliminate stop words such as articles. This procedure extracted a list of 79639 n-grams, divided as follows.

Table 4.3.3.1. Number of n-grams extracted

Type of n-gram	Number of extracted n-gram
1-gram (single word)	59683
2-gram	4971
3-gram	4993
4-gram	4995
5-gram	4997

The tools used to extract the n-gram are developed with the Python language ([www.python.org](http://www.python.org)) with the Scikit-learn framework [Pedregosa 2011].

The extracted n-grams have been manually classified to find keywords. From the original list of 79639 n-grams, a set of 1072 keyword has been selected. Using these keywords, a set of 50151 posts has been identified as messages that contains at least 1 keyword.

### 4.3.4. Manual classification

Using the keywords selected in the previous task, a set of 814 messages is selected for manual classification. The goal of this task is to label messages and sentences as question/not question in order to create an annotated dataset useful to train a classifier that automatically detects posts containing questions or doubts. The manual classification is composed of two steps:

- post classification: the label question/not question is applied to the entire post. During this phase, the human classifier writes a brief note about the post itself. The “role” (caregiver/patient) of the person who wrote the post is also recorded;
- sentence classification: the label question/not question is applied to each sentence of each post. The human classifier also writes a description of the question. In this phase, the human classifier checks the correctness of the subdivision into sentences of the post. This information is used to improve the sentence splitting procedure and to fix the subdivision of the posts.

The “role”, and the brief descriptions and notes recorded are not actually used, but they are recorded for further reference and may be used in later elaborations.

The results of this manual classification are the following.

Table 4.3.4.1 Number of posts’ classifications

N° of classified post:	814
N° of post classified as question:	388
N° of classified sentences:	9721
N° of sentences classified as question:	747

The dataset created with this manual classification is used to develop and train some classifiers that will be used to automatically detect other posts or sentences that contain questions or doubts.

The classifiers developed are the following:

1. fully connected neural network using a simple embedding of the keywords;
2. fully connected neural network using a word2vect model to encode the keywords;
3. SVM sentences classifier.

### 4.3.5. Neural network with simple embedding

---

The first developed classifier is a fully connected neural network consisting of 5 layers. The first 3 layers are composed of 536 (half the number of keyword) neurons each. The fourth layer is composed of 268 neurons (half of the previous layers' width). Each neuron in these layers, uses the ReLU activation function. The output layer has only one neuron that uses the sigmoid activation function since the network is a binary classifier. The neural network is developed using the Python language and the TensorFlow framework (<https://www.tensorflow.org/>). The input of this network is a vector with 1072 components, one for each keyword. The  $i$ -th component can be 1 if the post contains the  $i$ -th keyword and 0 otherwise.

This classifier achieves a 66.0% of accuracy with a 58.3% of recall and a 67.5% of precision. These scores are computed with a 10-fold cross-validation scheme.

### 4.3.6. Neural network with word2vect

---

Since the representation of the keywords in the first classifier is very simple, a second classifier is developed using as input the keyword representation obtained applying the word2vec [Mikolov 2013a and Mikolov 2013b] model to the keywords.

The word2vec model is trained with a large corpus of text (in our case the lemmatized text of all messages) and produces a vector space (the dimension of this space is a parameter, but typically it is set to hundreds of dimensions). Each word or  $n$ -gram is assigned to a vector in this space. These vectors are assigned such that words with similar context or meaning are represented with vectors close in space. The word2vec model is implemented with the Python language using the Gensim framework (<https://radimrehurek.com/gensim/index.html>). The model is trained to produce a vector space with 300 dimensions.

The first developed classifier is a fully connected neural network consisting of 4 layers. The first two are composed of 268 neurons with ReLU activation. The third layer is composed of 134 neurons with ReLU activation. The last layer is composed of one neuron with sigmoid activation function since the network is a binary classifier. The neural network is developed using the Python language and the TensorFlow framework.

This classifier achieves a 66.1% of accuracy with a 64.8% of recall and a 65.0% of precision. These scores are computed with a 10-fold cross-validation scheme.

### 4.3.7. SVM sentences classifier

---

A third classifier based on a Support Vector Machine (SVM) [Cortes 1995] is developed. This classifier operates only on single sentences and not on the entire message. This approach is chosen due to the great differences in the message length. This classifier uses the POS tag of each word of

the sentence. The classifier encodes the POS tags of each phrase counting the number of each tag type. The obtained vector is then fed through the SVM classifier, for the classification. The classifier is developed in Python language using the Scikit-learn framework.

This classifier achieves a 68.0% of accuracy with a 70.8% of recall and a 71.0% of precision. These scores are computed with a 5-fold cross-validation scheme.

This classifier is the most promising one, but it greatly suffers the unbalance in the dataset (only 747 questions out of 9721 classified sentences). To cope with this problem, more sentences must be classified to better train this model and improve its performance.

The following figure summarize the results obtained by the classifiers:

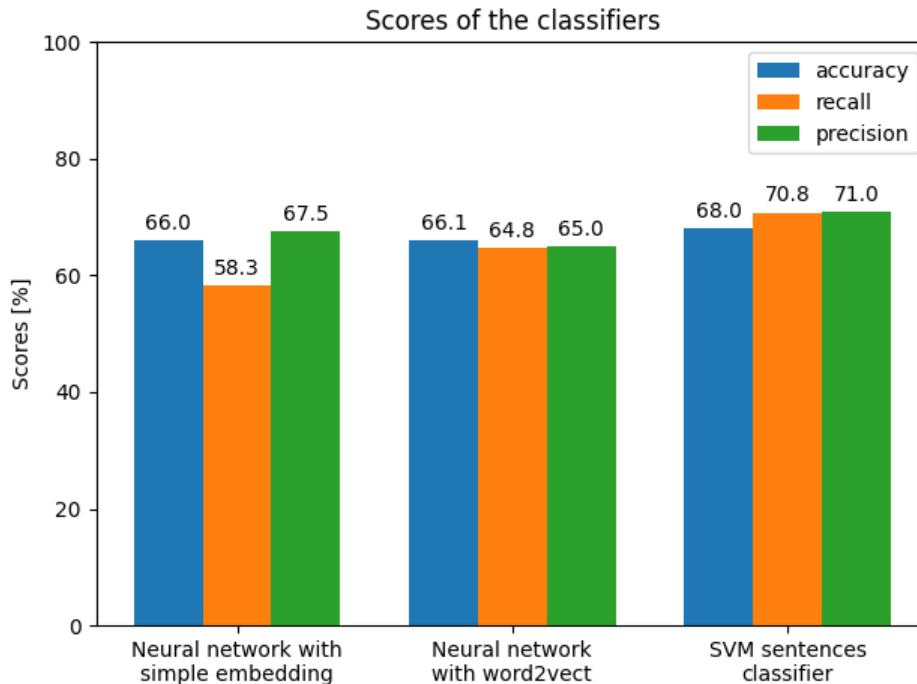


Figure 4.3.7: Performance of the classifiers

### 4.3.8. Qualitative analysis of the AIMAC forum messages

Eight hundred messages have been manually annotated in order (i) to perform a preliminary investigation about patients’ needs and (ii) to prepare a corpus of annotated text for subsequent supervised natural language processing (as explained in the previous section). In this section the preliminary investigation about patients’ needs will be described.

The annotations that are relevant to this analysis are

- Who is the author of the message
  - a patient
  - a patient’s relative/home caregiver
- The phase of the disease addressed by the message
  - pre-diagnostic (tests and visits to assess the cancer type and stage)
  - diagnostic (cancer just diagnosed)
  - treatment
  - post-treatment
  - terminal
  - after death
- The motivation for the message

- Request for objective/precise information (e.g., “is there a psychological service in the hospital X?” or “can somebody tell me information about risks related to red meat?”)
- Support to peers, e.g., messages to a patient to know his status (“Let me know how’s going” or positive messages)
- Communication of concern
- Rhetorical question/Outburst/experience sharing
- Complain

### 4.3.9. Message authorship

---

Most of the messages (77.8%) were posted by relatives (often the cancer patient’s spouse or sons). Patients were the authors of 21.5% of messages, and the remaining few messages (0.7%) were posted by healthcare personnel (nurses), complaining about their poor preparation for dealing with oncological patients. It is clear that home caregivers play a very important role and carry an enormous burden, and more often than patients they look for help and support within the forum. This finding calls for CAPABLE to target also caregivers.

### 4.3.10. Disease phase

---

For 120 messages we could not identify the phase of diseases when they were posted. Among the remaining ones, most of the messages (51%) were posted during the treatment phase, followed by post-treatment phase (16%), terminal phase (9.5%), “just-diagnosed” phase (9%), diagnostic phase (7%), after-death phase (6.6%). This result support<sup>7</sup> the CAPABLE objective, because the project targets patients that are undergoing home treatment, who seem to be the ones requiring more support.

### 4.3.11. Message motivation

---

The arguments addressed are very varied. The following table reports the most common ones. Some of them seem to be addressed by both patients and caregivers, other ones seem to be of most concern for one of the two groups.  
 Table 4.3.11.1 Topics of the messages and their frequency of occurrence in patient- and caregiver-authored posts

Table 4.3.11.1 Major message topics

category	Sub-category	Caregiver (%)	Patient (%)
Request for objective/precise information	Search for centers of excellence	2	12.5
	Asking help for interpreting medical reports	4.6	
	Specific question about the disease/treatment (1/3 of them about further possible treatments after the oncologist decided to stop the treatment)	8.0	12.3
	Specific request for psychological support	2	3
	Question about terminal phase	3.6	
Rethorical question/ Outburst/experience sharing	Experience sharing	17.4	30.7
	Outburst	25.0	7.7
Complain	Complain about the received care	4.0	10.7
Communication of concern	Anxiety for an incoming next test and for test results	3.6	6.1
Support to peers	Support to other patients/caregivers	17.8	12.3

The table shows that the AIMAC forum is exploited first of all as a relief valve, where people (mostly caregivers) vent their distress or (mostly patients) share their experience. In general, this could indicate a need for psychological or social support. As a matter of fact, 25% of caregiver messages are outburst messages and 30.7% of patient messages are about experience sharing. However, we are looking for the most frequent needs of patients and their caregivers. Thus, we notice that 20% of messages contain requests for information about the disease or about the therapies. In particular, messages show that caregivers do not resign themselves to the suspension of therapy for their relatives, because they do not fully understand the motivation for the therapy stop. Another important issue is, more evident for caregivers, looking for the best specialists able to treat a specific cancer type (centres of excellence). Other common topics are the side effects of treatments and psychological issues.

Interestingly, a non-negligible percentage of the forum users ask for help to interpret the medical reports, i.e., the test results and some technical phrasing. This is probably due to various reasons, such as scarce medical literacy of some patients/caregivers, lack of time for better informing them during the visits, or sometime a too hasty attitude shown by doctors. In any case, this calls for a careful introduction and exposition of educational material among the CAPABLE functionalities. Moreover, from the messages we realize that patients are anxious when they are waiting for the next visit and for test results. CAPABLE could deal with this issue by suggesting more relaxing exercises in those periods.

Among messages containing specific questions, we analysed in detail those reporting enquiries about nutrition. As a matter of fact, nutrition has been recognised as one of the major concerns for



cancer patients, as shown by statistics on the AIMAC questionnaires (both the generic questionnaire and the Covid-19 questionnaire).

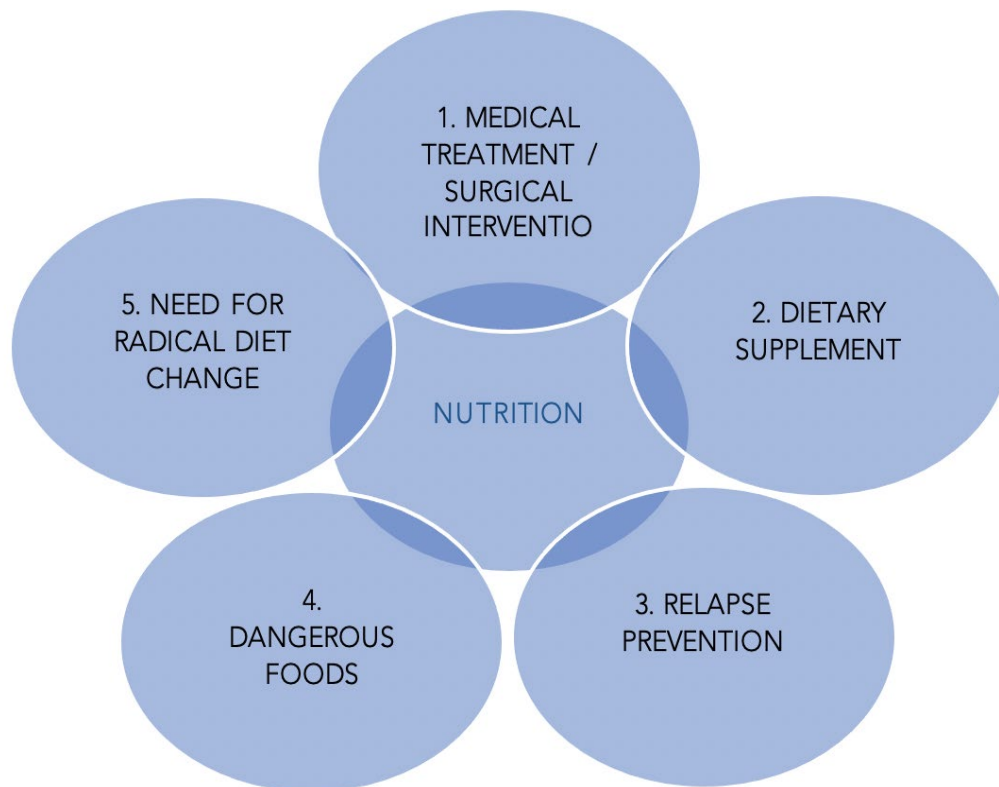


Figure 4.3.11– The different nutrition axes

### 4.3.12. Examples of messages

The following examples refer to the different dimensions shown in Figure 4.3.11:

- Messages related to treatment

“ I would like to know if anyone has drastically changed their diet (see articles of Prof. Berrino[1]) in order to prevent chemo-related damage” (young female just after the 1st chemo cycle)

“After surgery, was a specific diet recommended?” (spouse of a patient who underwent a resection)

“At the same time as chemotherapy, we also started with homeopathic treatments that we believe were very useful, and also a strict control of nutrition. If we had had the same care in food a few years ago perhaps we would not have reached this point now” (girl writing about her mother’s pancreatic cancer)

Those messages highlight non only the importance that patients give to nutrition, but also some misunderstanding and probably illusions. As a matter of fact, the scientific evidence about the nutrition role in cancer prevention is not so high. At the moment, the only association that has been scientifically demonstrated is between colorectal cancer and high consumption of red meat and processed meat. On the other hand, there is a lot of scientific evidence about the general benefits of a “healthy diet”. Thus, it is clear that improving diet habits can improve the quality of life also for cancer patients. On the contrary, it is not sensible to dramatically reduce or even eliminate some foods from a cancer patient’s diet, when this is not explicitly recommended by doctors for some reasons.

- Messages related to dietary supplements

“with my husband we removed the red meats and therefore also all the sausages and eggs he is eating a lot of vegetables, cereals and legumes ...no refined sugars ...but must he also remove all the cheeses? I ask because in spite of everything he is hungry and also very ...I try to make him large portions of everything he can eat but often in the middle of the afternoon he is still hungry ... Do your loved ones then take supplements?” (wife of a patient, no other information about the message author and the type of cancer)

“ we had to face the problem of diarrhea and sudden weight loss. We immediately after therapy use Yovis sachets 3 times before meals, then we modify the diet, eat unripe bananas, boiled potatoes, rice, corn (I know it all raises the blood sugar but they help control bowel activity) ... We also use aminotrophic supplement.”

Patients share personal experience about dietary supplements and do not ask doctors before taking them. This could be dangerous because some dietary supplements interfere with drug treatment.

- Messages related to relapse prevention

“To avoid relapse, as far as possible, I changed my diet: certainly since I got sick I felt the refusal towards meat ... I don't eat it anymore also because it's not good for you ... I try to limit sugar (I was told in the hospital that it is the fuel for cancer cells). I try to respect a diet rich in legumes, vegetarian dishes, fruit and I practice a lot of sport.” (27 years female affected by a lymphoma)  
This message highlights the risk for cancer patients to follow false recommendation related to “fake information”. The relationship between sugar consumption and development of cancer has not been demonstrated in humans (such a correlation has been shown for breast cancer in animals on a diet with very high sugar intake). Decreasing sugar consumption in our diet is highly recommended, but for preventing other diseases, while this patient seems to have the false expectation that limiting sugar could decrease her risk of relapse.

- Messages related to food considered dangerous

“I don't eat it anymore also because it's not good for you ... I try to limit sugar” (see the above point 2)

“I'm on a very strict diet that eliminates fats, fried foods, alcohol, spices, carbonated drinks, coffee, chocolate etc. I lose 15 kg in a few months (I weighed 91 kg in May, now I weigh 76 kg).” (patient with lymphoma, unknown age and gender)

These messages, in particular the last one, highlights risks that patients could take when adopting a “do-it-yourself” approach. As a matter of fact, while the patient seem to really improve his diet by avoiding a series of junk foods, it is certainly not recommended to loose so many kilos in few months, because cancer patients must face heavy treatment such as chemotherapy and losing weight could compromise the endurance of side effects.

- Messages related to a radical diet change

“I immediately practiced a vegan diet, losing 15-16 kg (from 67 to 51), and in certain moments it makes me sick to look at myself, like when I take a shower or get dressed.” (Woman affected by liver cancer)

“I started a vegan diet under the advice of a very competent friend” (Woman, 30 years old, cervix adenocarcinoma)

“I combined a low-calorie, no sugar-salt-dairy-meat macrobiotic diet, I dropped weight accordingly, from 70 to 62 kg., But I'm in strength and work.” (male, 61 years, inoperable multifocal hepatocellular carcinoma)

These messages reinforce the fact that patients must be supported in order to avoid inappropriate nutritional habits.

## 4.4. User models and scenarios

### 4.4.1. Personas

---

The scenario developed for the 1st CAPABLE Proof of Concept (PoC) demonstration, in the context of TF2, is centered on the persona of Maria Rossi. Maria is an Italian female cancer patient of age 74. Her weight at the time of the enrollment visit is 62, and her height 160cm (BMI 24.2). She has a Melanoma at stage IV.

Maria has no history of any relevant comorbidities including diabetes, hypertension, collagen vascular disease, irritable bowel syndrome and previous intestinal surgery. Also, she never smoked, and she has no history of alcohol abuse.

However, she is experiencing sleep problems as a side effect of her primary condition and treatment. Maria is currently treated with Nivolumab as a chemotherapeutic agent.

It is important to characterize Maria in all aspects of her life, understanding who shares daily life with her, understanding her education and her work occupation, analyzing her preferences in the environmental, musical, technological, sports and nutrition fields.

For this, in the presented scenario, it was assumed that Maria's schooling stopped at secondary middle school and that her literacy level is not particularly high. Not having a high level of literature, she would prefer that the application be provided in her native language. After completing her studies, Maria dedicated herself completely to work, working as a full-time worker for over forty years, and then retired permanently in 2008.

Maria is married with three children, of whom only one lives with her, while the others have long since left the house. The husband, Giulio, has the role of caregiver.

Maria leads a sedentary life; therefore, she does not practice regular physical activity, but if she has to practice it, she prefers walking. Maria would prefer to use the CAPABLE application through the smartphone.

### 4.4.2. M12 & M18 Demo Scenario

---

The scenario that will be used to demonstrate the 1st CAPABLE POC (M12 demo) is described in deliverable D4.1. It articulates over a period of 3 consecutive days, including day 0 (= time of enrollment in the CAPABLE system). Details about what is expected from different CAPABLE components are also provided along with the scenario, to show the involvement of CAPABLE system components in the enactment of specific portions of the scenario. This also ensures the integration with section 6 Overall CAPABLE architecture, which will describe the system components in more detail.

Another scenario is for the M18 demo. This scenario is divided into two phases. The first, prior to the first symptom reporting by the patient, involves the specification of Maria's preferred activities and the use of the Capsules section. The second part consists of some symptoms, reported by the patient, and the various actions that the system performs, in cooperation with the clinician, to solve them.

The two scenarios include parts that are driven by the Physician and some driven by the Patient. Tables 4.4.2.1 and 4.4.2.2 show the parts of the scenario related to the Patient. We also report the general requirements that are described in the use case diagram reported in Section 4.7, and the involved CAPABLE components described in Section 6.

Table 4.4.2.1 Patient Scenario of Maria for the M12 demo

	Patient	Reference to Use Case Diagram (Section 4.7)	Involved CAPABLE components (Section 6)
Day 0	The patient app is installed on the patient’s smartphone. The patient profile is filled in and the sleep Capsules is activated.	Req 5 (Preferences and Info) Req 4 (Capsules)	Physician App, Patient App, Virtual Coach, Physician DSS, Case Manager, Data Platform
Day 1	Maria uses the Patient App to report symptoms and she enters diarrhea grade 1. The Patient App asks for additional related symptoms and Maria reports none of them. Since mild diarrhea is detected, the patient app displays treatment recommendations that Maria can manage at home.	Req. 1.1 (Report on New Symptoms) Req. 1.2 (Follow-up of Symptoms) Req. 3.1 (Suggest Action)	Patient App, Virtual Coach, Physician DSS, Case Manager, Data Platform, GoCom, KDOM
Day 2	Maria is asked for an update on her condition, and reports that nothing has changed with respect to Day 1. She receives an educational tip about diarrhea management.	Req. 1.2 (Follow-up of Symptoms) Req. 3.2 (Motivational Feedback)	Patient App, Virtual Coach, Case Manager, Data Platform, KDOM
Day 3	Maria is asked for an update on her condition and reports diarrhea grade 2. Since she is on immunotherapy, diarrhea grade 2 is considered complicated, and she receives a recommendation to call her physician.	Req. 1.2 (Follow-up of Symptoms) Req. 3.1 (Suggest Action)	Physician App, Patient App, Virtual Coach, Physician DSS, Case Manager, Data Platform, KDOM

Table 4.4.2.2 Patient Scenario of Maria for the M18 demo

	Patient	Reference to Use Case Diagram (Section 4.7)	Involved CAPABLE components (Section 6)
Enrollment	Patient enrollment. The patient app is installed on the patient’s smartphone. The patient profile is filled in (in particular the patient select her hobbies)	Req 5 (Preferences and Info)	Physician App, Patient App, Virtual Coach, Physician DSS, Case Manager, Data Platform
After the visit	Consistent with the goals the patient have decided with the clinician and consistent with patients preferred activity, the	Req 4 (Capsules)	Physician App, Patient App, Virtual Coach, Physician DSS,

	system propose the capsule “walking”		Case Manager, Data Platform
The day after the visit	First execution of the Capsule	Req 4 (Capsules)	Patient App, Data Platform
Three days after the first execution of the capsule	The patient has not reported any events on the capsule and her daily steps, according to the sensors, are low. VC reminds the patient to execute the “walking”	Req. 3.2 (Motivational Feedback)	Patient App, Virtual Coach, Case Manager, Data Platform
Day 1	Maria uses the Patient App to report symptoms and she enters pruritus grade 1. Since pruritus can be a symptom of rash, the VC asks, through the Patient App, for rash, and the patient answers “no”. Since mild pruritus is detected, the patient app displays treatment recommendations that the patient can manage at home.	Req. 1.1 (Report on New Symptoms) Req. 1.2 (Follow-up of Symptoms) Req. 3.1 (Suggest Action)	Patient App, Virtual Coach, Physician DSS, Case Manager, Data Platform
Day 2	VC, through the patient app, asks Maria if she still has the symptom pruritus. The patient has pruritus again. The application takes Maria directly to the symptom reporting page for the pruritus symptom. Since pruritus can be a symptom of rash, the VC asks, through the Patient App, for rash reporting, and the patient reports rash. Since pruritus and rash are detected, the patient app displays treatment recommendations that the patient can manage at home and suggests contacting the doctor. Furthermore, since the guideline suggests that the patient should avoid sun exposure if she has a rash, and it’s summer, thanks to GoCom, the VC suggests to avoid outdoor activities, including the capsule “walking”	Req. 1.1 (Report on New Symptoms) Req. 1.2 (Follow-up of Symptoms) Req. 3.1 (Suggest Action)	Physician App, Patient App, Virtual Coach, Physician DSS, Case Manager, Data Platform, GoCom
Day 3	The app will remind the patient about the visit set by the clinician	Req. 2.2.2 (Daily plan)	Physician App, Patient App, Virtual Coach, Physician DSS, Case Manager, Data Platform
Day 4	The patient goes at the visit	-	-
Day 5	The new treatment (Oral antihistamines) is added to the	Req. 2.2.2 (Daily plan)	Physician App, Patient App,

	patient’s therapy on the daily plan section of the application		Virtual Coach, Physician DSS, Case Manager, Data Platform
Day 6	VC, through the patient app, asks Maria if she still has the symptom pruritus and rash. Her symptoms are solved.	Req. 1.2 (Follow-up of Symptoms)	Patient App, Virtual Coach, Case Manager, Data Platform

### 4.4.3. Other Scenarios (based on the extended CAPABLE proposal)

Simultaneously with, or later the scenario represented above (4.4.2 M12 Demonstrations Scenario), other possible situations may occur when the patient interfaces with the application.

Scenario 1:

Maria went through a bad period due to the side effects caused by drug treatment. The dashboard of capable shows a negative trend: it highlights the difficulty in sleeping, an increase in side effects and signs of depression. Maria goes to a visit to the oncologist to stop the treatment. During the visit, the oncologist chooses to use the part of the Capsules concerning sleep to improve the quality of Maria's sleep. Together with Maria, they decide to set the "Sleep Improvement" goal that the patient must follow, so Maria will have to use the capsules related to the topic to improve her condition. The signs of depression are managed directly by the psychologists, as they have warned by the application of the negative trend and have promptly organized an adequate psychological path.

Scenario 2:

During her first visit with the oncologist, the physician suggested Maria perform moderate physical activity. However, analyzing the data provided by the activity tracker, the virtual coach realizes that Maria is leading a sedentary lifestyle and therefore encourages her to move. In shared decision making, Maria and the oncologist estimate that 30 minutes walking in nature could be the best workout for her. Maria plans a time slot for this activity as an after lunch activity. The Virtual Coach senses whether she has had her walk and if she hasn't done so within 45 minutes of the end of the planned time slot, sends her a reminder for this activity.

Another help that the virtual coach can provide to Maria is motivation. The application not only provides suggestions on the type of exercise that may be most suitable for Maria but also explains to the patient the importance of physical activity for psychological well-being and to reduce side effects (as part of the education content).

## 4.5. Digital intervention strategy

### 4.5.1. Recommendations from guidelines

Decision support provided to clinicians is all based on clinical guidelines. The guidelines are represented in the PROforma CIG language in a goal-oriented manner. Representation in PROforma allows the Deontics DSS to produce patient-specific evidence-based recommendations by traversing the PROforma CIGs with the patient’s data. The goal-oriented modeling allows the GoCom multimorbidity component to detect and mitigate conflicts and present the potential option sets meeting the concurrent multimorbidity goals, allowing for automatically-generated explanations.

Section 5.6 presents information on the guidelines selected for CAPABLE.

## 4.5.2. Validated educational materials

---

All of the educational materials presented to patients via the Coaching System are validated and have been developed by trustworthy medical organizations. They include a Nutrition guideline developed by AIMAC, and sleep-related education developed by the Center for Clinical Interventions of the Government of Western Australia, Stanford Medical School, Cleveland Clinic, and WebMD.

Sleep-related education focuses on sleep information sheets, stimulus control and sleep hygiene, and cognitive restructuring (i.e., preventing thinking errors and misconceptions).

## 4.5.3. Capsules approach

---

In CAPABLE we aim to also improve the mental and social wellbeing of patients using virtual Capsules. Capsules contain short instructions for non-pharmacological evidence-based interventions that have been shown to improve the mental and social wellbeing of patients and other stress-related conditions such as sleep problems and fatigue. Clinical goals for our capsules' knowledge base, approved by patients and clinicians focus on sleep/fatigue improvement, acceptance and expression of the cancer journey, gratitude+positive thinking, and improving social connections. Many of the specific capsules have benefits through multiple goals. The patient can choose what goal s/he would like to improve and how many weekly doses for each goal, with 1-2 doses a day recommended. As usage data is gathered, the app could potentially use machine learning to suggest ideas that have helped similar patients and fit with the patient's preferences. Our capsule approach to improve your wellbeing is a non-pharmacological intervention that is based on changing your lifestyle, your psychosocial behavior (Cognitive Behavioral Therapy, CBT), your physical exercise routine and your nutrition. It is founded on evidence-based clinical trials that have repeatedly shown that such interventions have a very positive effect on a person's wellbeing, including its physical, emotional, and social aspects.

You may have heard the term CBT before. CBT focuses on challenging and changing unhelpful thoughts, beliefs, attitudes, and behaviors, improving emotional regulation, and the development of mental resilience and coping strategies. CBT can be practiced through different exercises. Our CBT capsules offer exercises that belong to three types: mindfulness, accepting and expressing the cancer journey, and positivity/gratitude capsules.

Specific capsules in our inventory belong to the area of cognitive behavioral therapy (CBT) and include:

For sleep and fatigue:

-Sleep restriction

-Interventions for relaxation training (Deep Breathing exercises, Imagery training (e.g., <https://www.webmd.com/cancer/qa/how-is-guided-imagery-done>), Tai Chi, Nature walks)

For accepting and expressing the cancer journey:

-Photo Voice, Garden Bowl

For improving social connections:

-Photo Collage, Photo Challenge

For gratitude and positivity:

- Gratitude letter, Expressing pride in yourself and your caregiver

Below provide examples for some of these capsules, belonging to different types.

[Mindfulness](#) is an approach, which helps your mind become at ease with your feelings and thoughts and allow you to focus on the here and now in your daily activities. Let's start with the body scan technique, as an example. Sit comfortably and listen to this [three-minute guided meditation](#), produced by UCLA's [Mindful Awareness Research Center](#).

**Expressing your cancer journey: PhotoVoice.** This is a photo that Trent took in his garden. He used to work in his garden but he is too fatigued nowadays. Instead, he sits in this favorite place of his, reading a magazine about Men’s Health and talks with his friends and support group about interesting information he read there. Trent realizes that, just two months ago, the photo he took for the photo voice showed a cemetery. How much he has grown!

**Happy times** - Visualizing other’s happiness can help you feel happy.

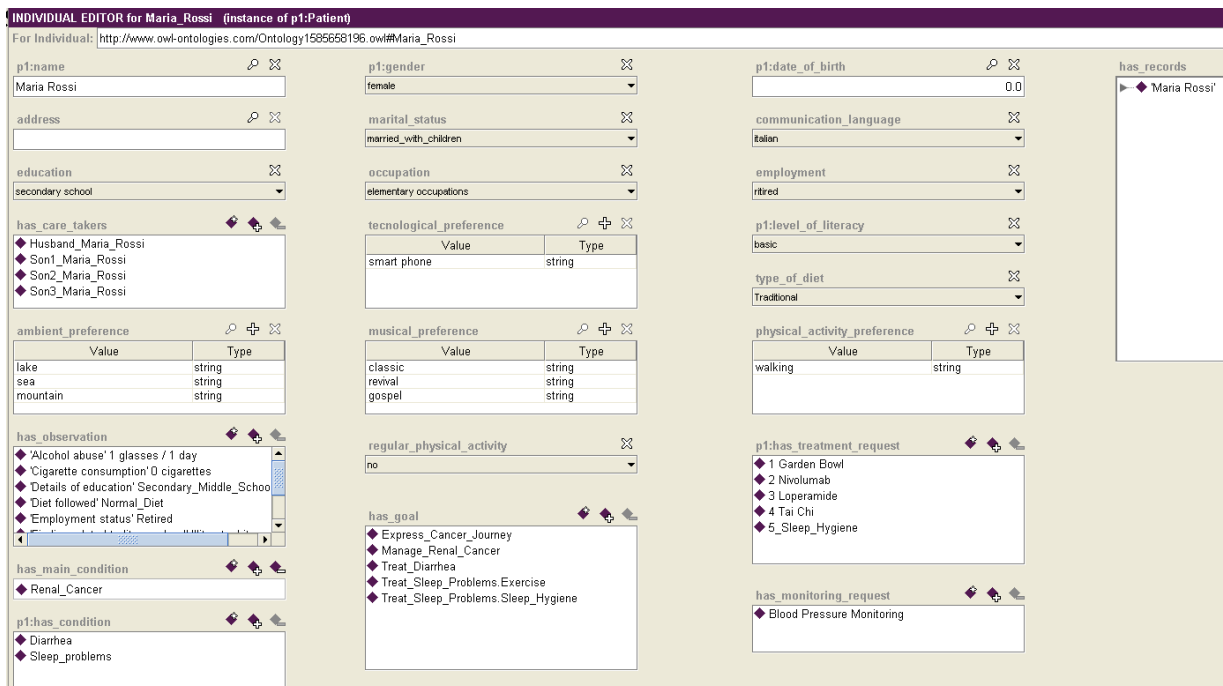
Think back on a time that you made someone else happy. How did s/he behave? What did s/he say? How did she look and sound?

Nothing comes to mind? Maybe think back on a time that someone else made you happy. What did you feel? Say? Look? Sound?

## 4.5.4. Patient model

The patient model of CAPABLE is an extension of the patient model developed for the MobiGuide project (Peleg 2017). It is specified in the Description Logics Web Ontology Language (OWL) using the Protégé tool. Figure 4.5.4 shows the extensions made for the purpose of personalizing the capsules recommendations. The extension includes specification of more psychosocial and demographic properties of the patient, in line with the recommendations of the Institute of Medicine (IOM 2015). These properties include occupation type, employment status, level of literacy. In addition, we added additional properties that may allow the personalization to be better aligned with the life style of the patient. Such properties include information about home caregivers, preferred diet, ambiance (e.g., sea, mountain, lake), musical preferences, and type of preferred physical activities. In addition, the treatment requests (to follow the terminology of the HL7 FHIR model) include wellbeing capsules.

Moreover, to allow the goal-based reasoning of the multimorbidity GoCom component, goals have been added into the ontology. Thus, each problem is matched with a clinical goal that represents the current active treatment of the patient for the problem. Figure 4.5.4 shows on the bottom the conditions, the root goals, and the treatments and monitoring requests.



The screenshot shows the 'INDIVIDUAL EDITOR for Maria\_Rossi' interface. It contains several sections for editing patient data:

- Basic Information:** p1:name (Maria Rossi), p1:gender (female), p1:date\_of\_birth (0.0).
- Address and Education:** address (empty), education (secondary school).
- Marital and Occupational Status:** marital\_status (married\_with\_children), occupation (elementary occupations).
- Preferences:** technological\_preference (smart phone: string), musical\_preference (classic, revival, gospel), physical\_activity\_preference (walking: string).
- Employment and Literacy:** employment (retired), p1:level\_of\_literacy (basic), type\_of\_diet (Traditional).
- Caregivers and Observations:** has\_care\_takers (Husband\_Maria\_Rossi, Son1\_Maria\_Rossi, Son2\_Maria\_Rossi, Son3\_Maria\_Rossi), has\_observation (Alcohol abuse, Cigarette consumption, Education details, Diet followed, Employment status).
- Goals and Conditions:** has\_goal (Express\_Cancer\_Journey, Manage\_Renal\_Cancer, Treat\_Diarrhea, Treat\_Sleep\_Problems.Exercise, Treat\_Sleep\_Problems.Sleep\_Hygiene), p1:has\_condition (Diarrhea, Sleep\_problems).
- Treatment and Monitoring:** p1:has\_treatment\_request (1 Garden Bowl, 2 Nivolumab, 3 Loperamide, 4 Tai Chi, 5 Sleep\_Hygiene), has\_monitoring\_request (Blood Pressure Monitoring).
- Records:** has\_records (Maria Rossi).

Figure 4.5.4. CAPABLE Patient Model for capsules personalization



## 4.6. Content of the Coaching system and messages

To create content for the Coaching system regarding fatigue and sleep problems, UH reviewed the literature about evidence-based non-pharmacological cognitive behavioral therapy interventions that could be delivered as “virtual capsules” that provide short cognitive behavioral restructuring and mindfulness exercises.

Textual descriptions were written by UH for the overall capsules approach and for each capsule, with citations to the clinical evidence. Instructions and instructional videos for the capsules were taken wherever possible from the evidence-based sources or from information sources published by recognized healthcare facilities or practitioners.

An ontology for the capsules was developed and integrated with the Patient Model described in Section 4.5. Figure 4.6 presents an individual capsule along with its properties. These properties help selecting a capsule that fits the patient according to the goal of the capsule (e.g., improving fatigue), time it takes to perform the capsule exercise, its physical effort, concentration level, and cost. An additional property specifies a question that can be sent to the patient in order to evaluate the patient’s perceived usefulness of that capsule for the goal selected (one capsule may be suitable for several goals, like managing fatigue, managing stress).

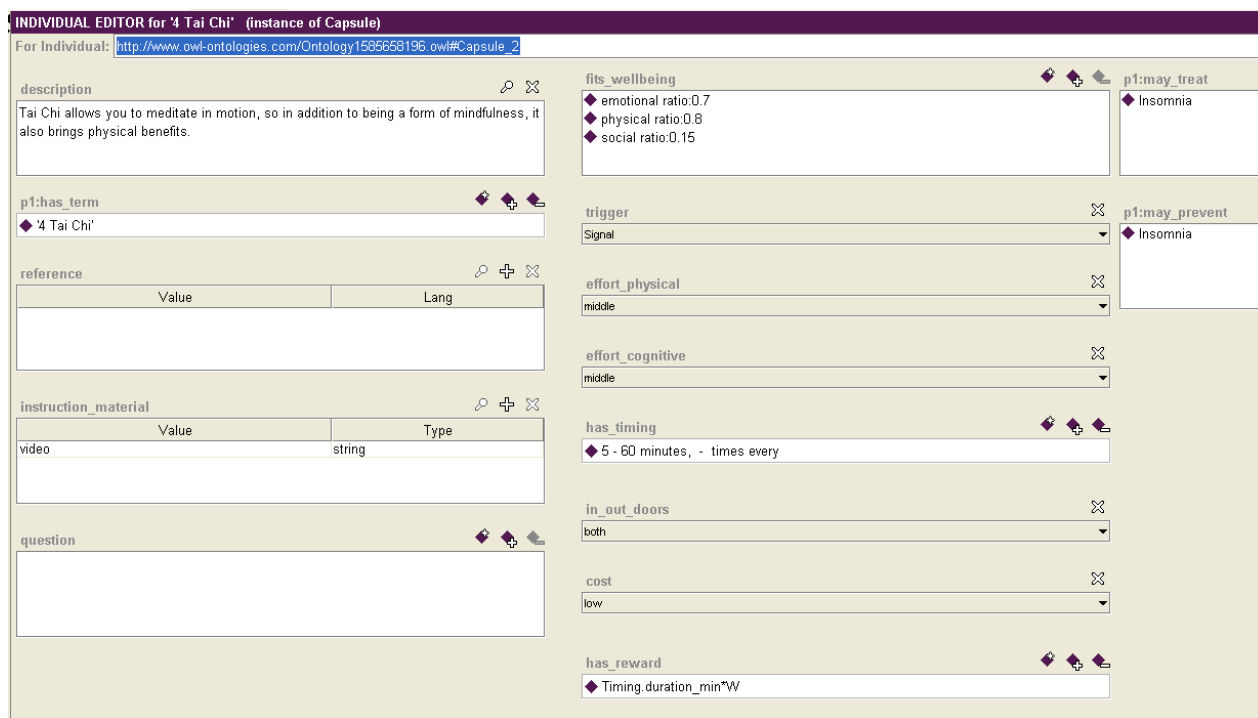


Figure 4.6 Tai chi capsule from the ontology developed by UH & UNIPV

Exercise recommendations were based on the World Health Organization’s recommendations for physical activity ([https://www.who.int/dietphysicalactivity/factsheet\\_olderadults/en/](https://www.who.int/dietphysicalactivity/factsheet_olderadults/en/)). UH then searched for instructional fitness videos for cancer patients that were developed by cancer medical centers and include aerobic, resistance, and balance exercises.

Malnutrition can in general compromise the health of an individual, but in cancer patients, can also seriously compromise the success and continuation of anticancer therapies, thus representing a true life threatening. Therefore, malnutrition must be recognized from the very beginning of a cancer patient's care path.

Moreover, it is very important, in the therapeutic path of a cancer patient, to have a continuous screening of the patient's nutritional status. However, it is equally important that the patient is educated on the topic of nutrition so that she/he is aware of the problem and pays more attention to

her/his nutritional status. Therefore, it was decided to include educational material on this argument in the application.

To create the educational contents, we relied on the AIMAC booklet that deals with this specific topic. It is important to highlight that in this document, as in all the other AIMAC booklets, only scientifically validated material is present. Moreover, the nutritionists of ICSM Maugeri furtherly validated those contents and slightly modified them in order to make them even more consistent with the latest research.

The issues addressed are very varied. The educational content addresses the importance of an adequate nutritional status in cancer patients, the importance of not neglecting weight loss, the definition of food and the various macronutrients of which the diet must be composed, the precautions to be taken during and after the therapy and several fake news that unfortunately are becoming popular on the topic. The educational content related to nutrition is divided into two parts, called the *static* part and the *dynamic* part. In the static part, there are contents with which the patient does not interact, but only learns some notions that can help him to have more awareness of his diet and nutrition. The static contents are the glossary (which for the Italian version is attributed to AIMAC - <https://www.aimac.it/informazioni-tumori/glossario> - while the English version is attributed to MacMillan - <https://www.macmillan.org.uk/cancer-information-and-support/a-z>) and texts that the patient can view. In the dynamic part, the patient can apply his knowledge, either previous or that he has learned from the static educational contents, to answer quizzes and discover “fake news” (myths). In this way, the patient self-assesses his knowledge on the subject and can learn further information on the topic of nutrition.

## 4.7. Use Case Diagram

---

The Capable patient system will be based on a Smartphone app and a commercial wearable sensor that users will receive in the hospital facilities after a process of assessment and co-design of the digital therapy. The functionality of the patient’s system can be depicted with the use case diagram of Figure 4.7 and it will provide the following macro functionalities:

- a. Tracking of the health status: the capable application will provide a wide tracking of the health status of the patient thanks to a system of symptoms reporting by the patient, the follow-up of the symptoms reported, the delivery of health questionnaires to the patient and the monitoring with a smartwatch device if possible.
- b. Management of the digital therapy: the user will be able to configure the reminders of the application related to the therapy and thanks to that configure a plan for each day and week in order to follow the therapy.
- c. System recommendation: the application will provide different contents to the patient. These contents will be reminders helping the patient to follow the therapy, motivational contents, suggested actions to improve the health status of patients and feedbacks about the activities performed by the patient.
- d. Digital intervention through Capsules: the digital interventions to the patient will be managed by the Capsules module. The capsules will be composed by goal setting, educational content, specific exercises and physical activity promotion.
- e. Management of system preferences: capable app will be customizable and configurable by the user in terms of privacy, timing and GDPR preferences.

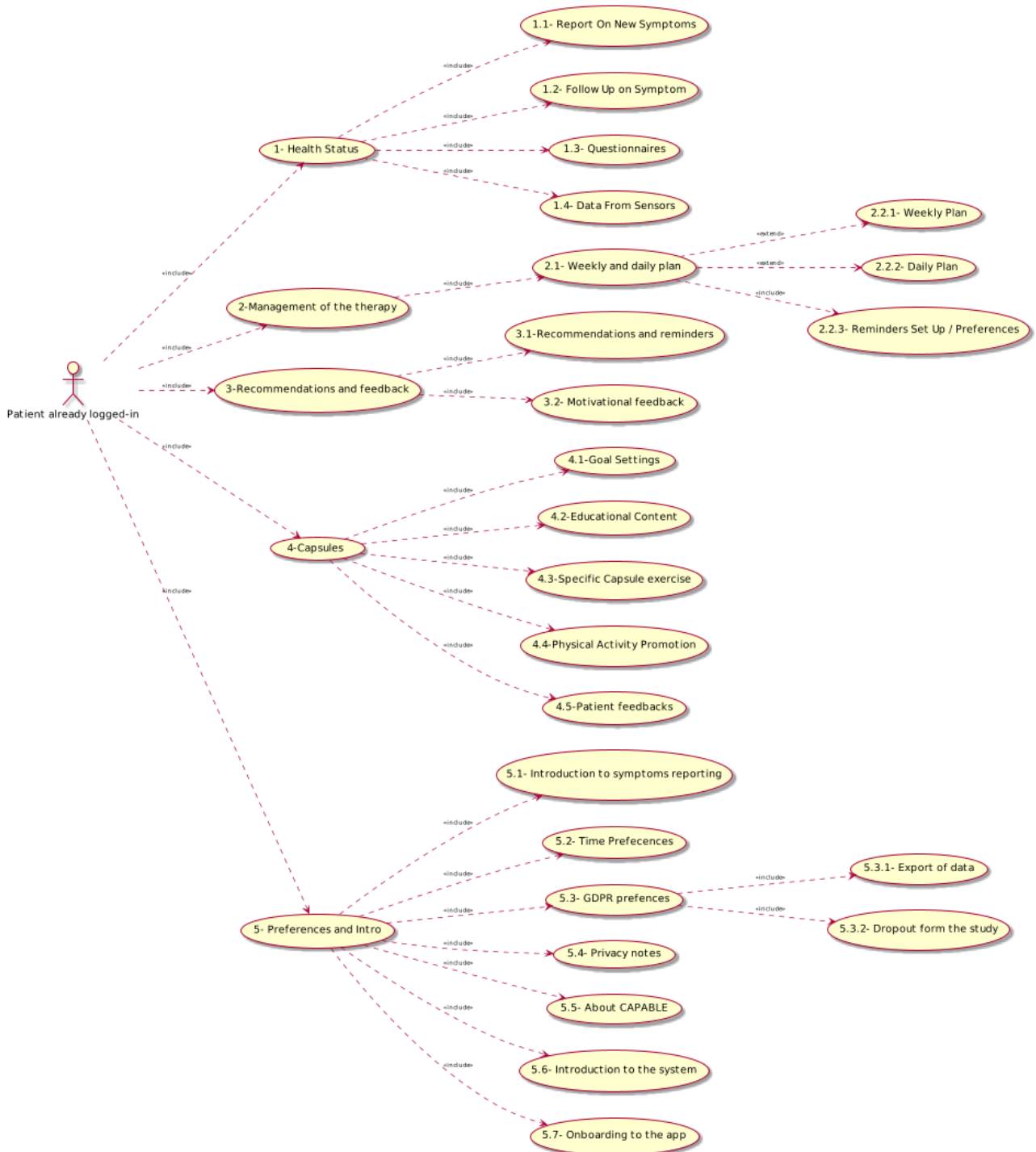


Figure 4.7 Use Case Diagram for the Patient Requirements

1. Health Status

- 1.1 Report on new symptoms
- 1.2 Follow-up on symptom
- 1.3 Questionnaire
- 1.4 Data from Sensors (Revise Trackers->Sensors)

2. Management of the therapy (Contract)

- 2.1 Weekly and daily plan (capsules, goals, treatments) - Overall plan
  - 2.2.1 Weekly Plan
  - 2.2.2 Daily Plan
  - 2.2.3 Reminders set up/preferences (option for each)

- 3. Recommendations and feedback
  - 3.1 Recommendations and reminders
  - 3.2 Motivational feedback
- 4. Capsules
  - 4.1 Goal setting
  - 4.2 Educational content
  - 4.3 Specific capsules exercise
  - 4.4 Physical activity promotion
  - 4.5 Patient providing feedback on whether they performed the capsule and whether it was helpful
- 5. Preferences and Intro
  - 5.1 Introduction to symptoms reporting
  - 5.2 Time preferences
  - 5.3 GDPR preferences
    - 5.3.1 Export of data
    - 5.3.2 Dropout from the study
  - 5.4 Privacy notes
  - 5.5 About CAPABLE
  - 5.6 Introduction to the system
  - 5.7 Onboarding to the app

Note that the requirements below address the Clinical Needs (CN) presented later in Section 5.5. These CN are highlighted in yellow in some of the requirement tables below.

Req. 1.1	Report on new symptoms
Description	<p>Standardized or validated questionnaires were not suitable for CAPABLE symptom reporting. The patient-reportable symptom descriptions follow a combination of Common Terminology Criteria for Adverse Events (CTCAE) grades and patient-friendly reporting as described in Patient Reported Outcome (PRO)-CTCAE outcomes. The sole use of the standardized CTCAE grades was not suitable for patient reporting, as CTCAE is aimed for reporting of adverse events by clinicians. PRO-CTCAE was not sufficient as the questions are utilized to measure symptoms in the last 7 days, while CAPABLE allows for daily reporting, at the moment that symptoms occur. Additionally, PRO-CTCAE does not include all symptoms that are reportable via CAPABLE.</p> <p>The goal of CAPABLE symptom self-reporting is not for patients to self-assess the actual CTCAE grade of their symptoms, but to inform the CAPABLE system and HCPs which advice to give. Therefore, we decided to adhere to this self-reporting flow, since there are not any standardized symptom reporting workflows that are completely fulfilling the existing needs of CAPABLE.</p> <p>The patient reports the symptom via a form, in the application. The application provides the visualization and description of the symptoms reported to the patient.</p>
Preconditions	The patient is logged.
Post Conditions	The app will show recommended content and feedback related to the reported symptom.

	The patient data is updated, the system records the new symptom and a follow-up is scheduled.
Course of action	<p>The user accesses reporting functionality through the Symptoms tab. Then, the user will introduce the symptom and the severity of the symptom guided by the app with a form. For each symptom, there will be several patient-friendly symptom descriptions that allow the patient to report on their symptom and situation.</p> <p>Some examples of the symptoms that will be included will be the following:</p> <ul style="list-style-type: none"> <li>• Very common: nausea, anorexia, diarrhea, abdominal pain, rash, pruritus, arthralgia, fatigues, vomiting, constipation, dyspnea, myalgia, headache</li> <li>• Common: dry skin, alopecia, blurred vision, cough, dizziness, and pain (pain in extremity, back pain)</li> <li>• Uncommon: pyrexia, dry mouth</li> </ul> <p>The reported conditions will be classified using SNOMED-CT.</p> <p>After the report of the symptom Capable app provides supportive feedback according to guidelines and best clinical practice for patient support.</p>
Alternate course A	The patient may report retrospectively on a symptom that has occurred in the past, by indicating the time of the symptom
Alternate course B	The application asks the patient how is going if there isn't reported symptoms and asks to report a new symptom if necessary.
Component dependency	Patient App, Virtual Coach, Data Platform
Planned delivery	M30
Responsible partners	BITSENS
Links to the mock-up	<p>Symptoms tab:  <a href="https://projects.invisionapp.com/share/Q6X4P6ATJD3#/screens/446221714">https://projects.invisionapp.com/share/Q6X4P6ATJD3#/screens/446221714</a></p> <p>Symptoms tab, UI design:</p> <ol style="list-style-type: none"> <li>1. <a href="https://projects.invisionapp.com/share/FE114K7TUBGA#/screens/453581099">https://projects.invisionapp.com/share/FE114K7TUBGA#/screens/453581099</a></li> <li>2. <a href="https://projects.invisionapp.com/share/FE114K7TUBGA#/screens/453581100">https://projects.invisionapp.com/share/FE114K7TUBGA#/screens/453581100</a></li> <li>3. <a href="https://projects.invisionapp.com/share/FE114K7TUBGA#/screens/453581101">https://projects.invisionapp.com/share/FE114K7TUBGA#/screens/453581101</a></li> <li>4. <a href="https://projects.invisionapp.com/share/FE114K7TUBGA#/screens/453642724">https://projects.invisionapp.com/share/FE114K7TUBGA#/screens/453642724</a></li> <li>5. <a href="https://projects.invisionapp.com/share/FE114K7TUBGA#/screens/453642725">https://projects.invisionapp.com/share/FE114K7TUBGA#/screens/453642725</a></li> <li>6. <a href="https://projects.invisionapp.com/share/FE114K7TUBGA#/screens/453642726">https://projects.invisionapp.com/share/FE114K7TUBGA#/screens/453642726</a></li> <li>7. <a href="https://projects.invisionapp.com/share/FE114K7TUBGA#/screens/453642728">https://projects.invisionapp.com/share/FE114K7TUBGA#/screens/453642728</a></li> </ol>

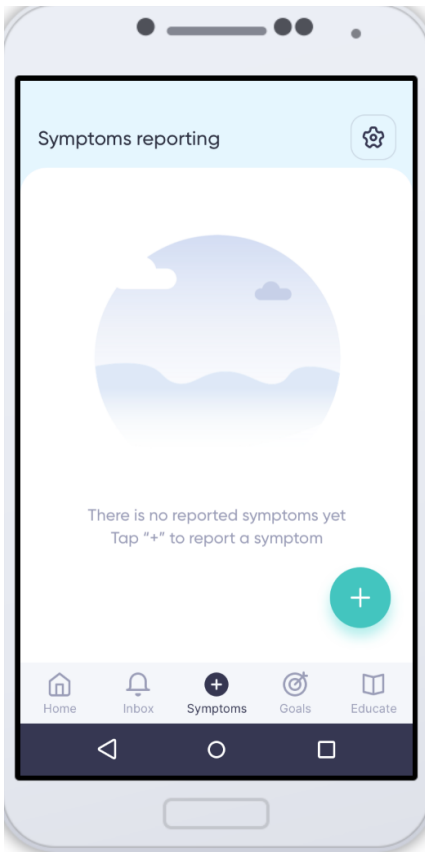


Figure 4.7.1 Symptoms tab - reporting on a new symptom - UI design.

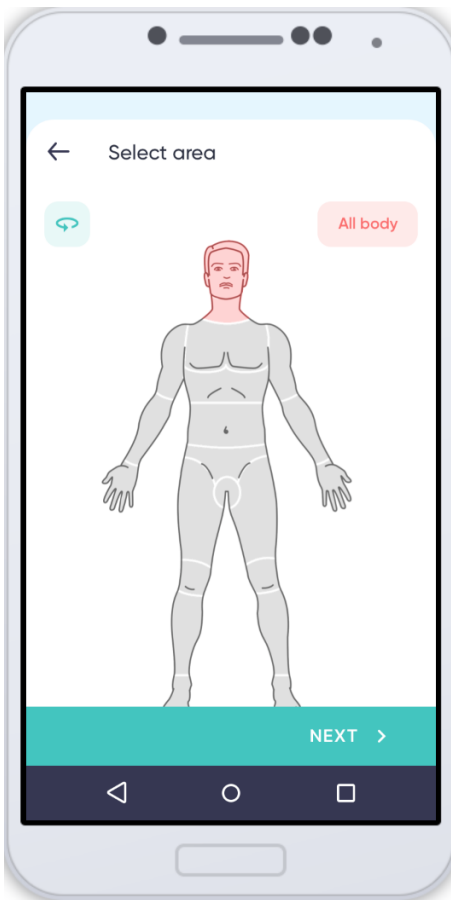


Figure 4.7.2 Symptoms tab - image of a human body; to indicate body part with a symptom, it's possible to turn it around, choose all the body and skip this step of a Symptom reporting flow - UI design.

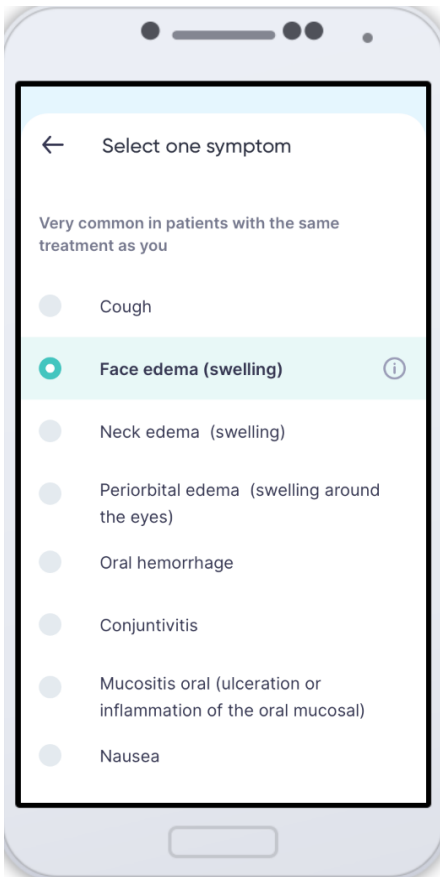


Figure 4.7.3 Symptoms tab - a list of Symptoms that can be reported by a Patient divided into groups by frequency - UI design.

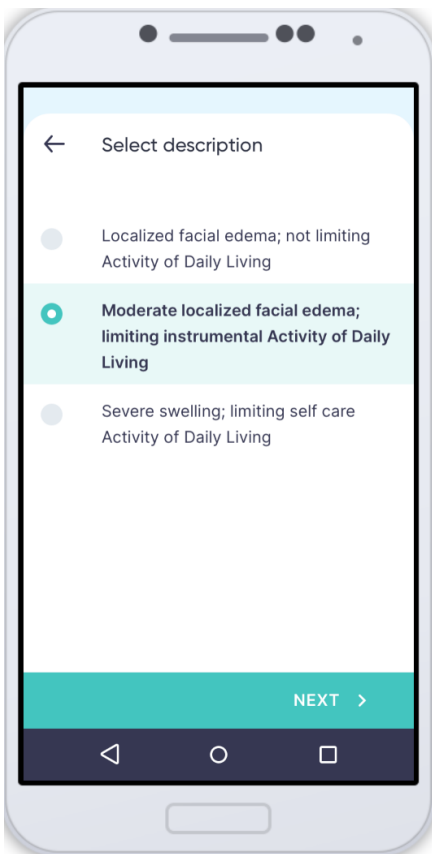


Figure 4.7.4 Symptoms tab - a list with the descriptions to a specific Symptom, grades of severity of a symptom - UI design.

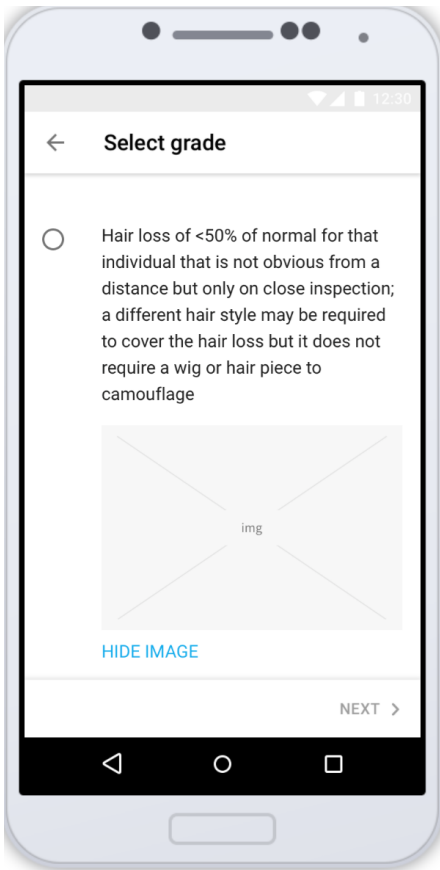


Figure 4.7.5 Symptoms tab - a list with the descriptions to a specific Symptom with the explanatory image

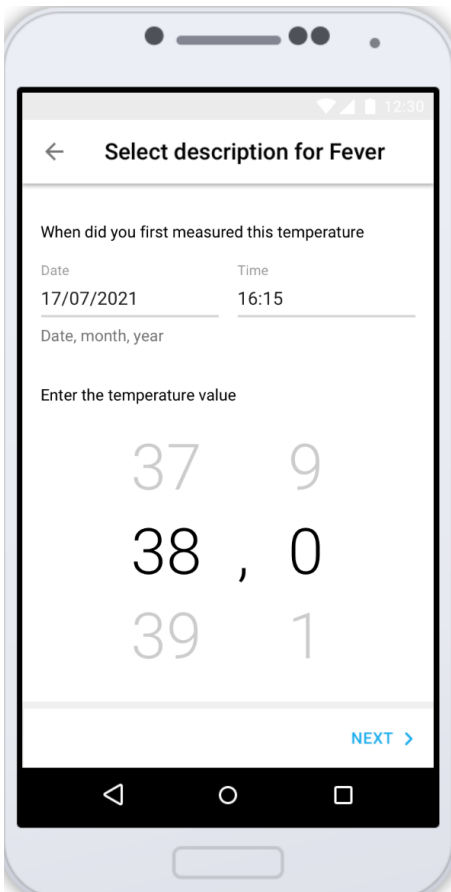




Figure 4.7.6 Symptoms tab - a list with the descriptions to a Fever with the possibility to indicate precise temperature.

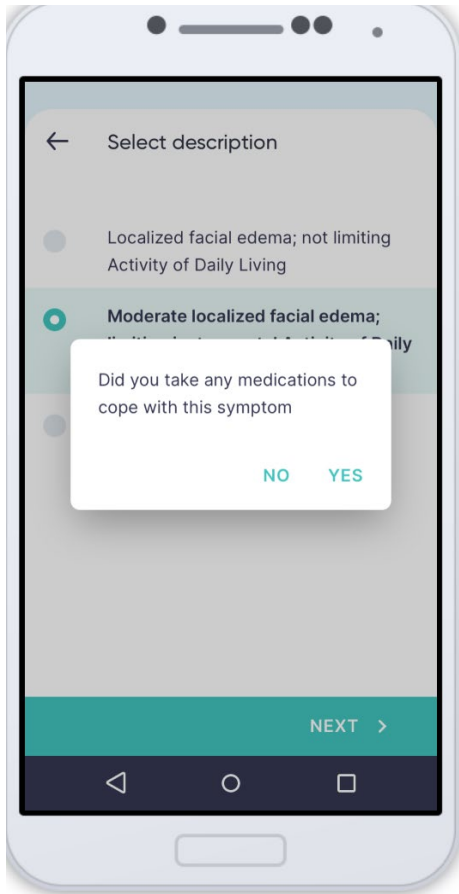


Figure 4.7.7 Symptoms tab - Medication intake due to a Symptom - UI Design.

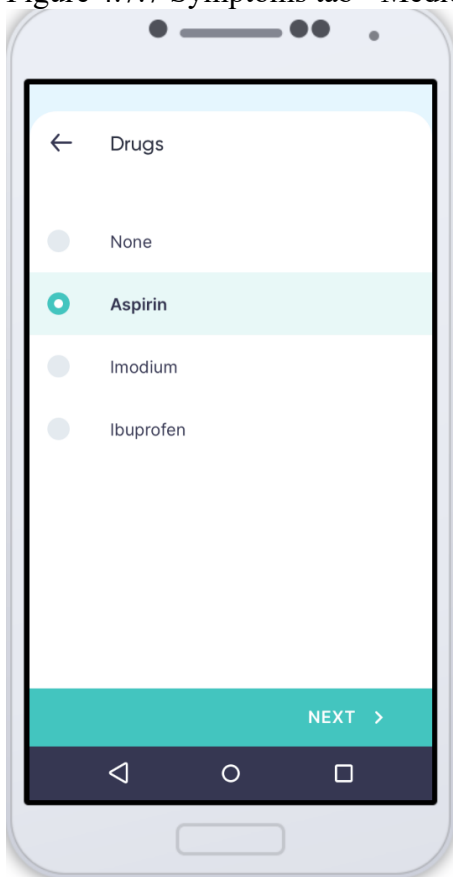


Figure 4.7.8 Symptoms tab - Medication intake due to a Symptom - UI Design.

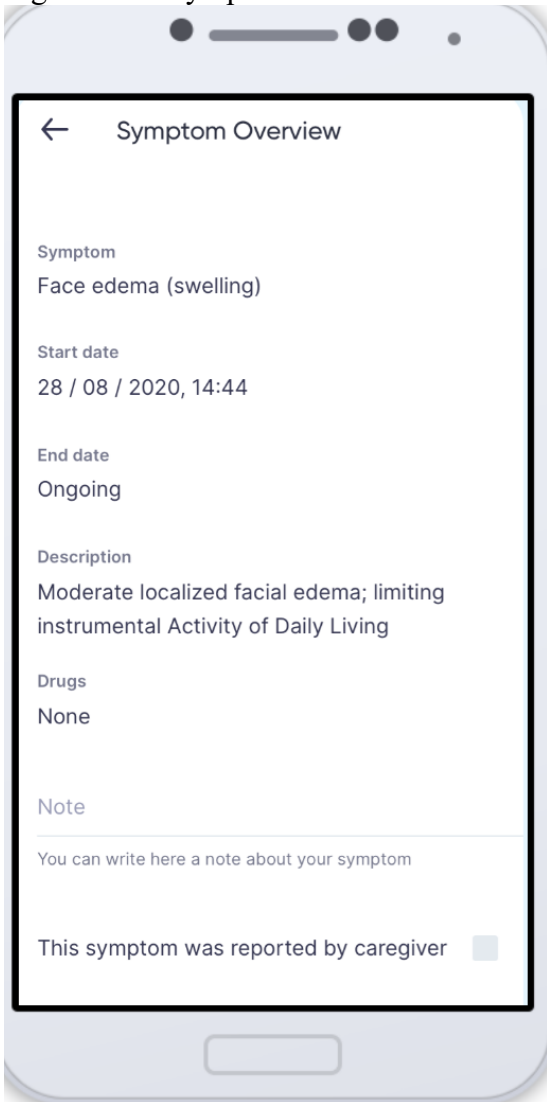


Figure 4.7.9 Symptom overview allows to put a note with a free text and a flag that shows a symptom is reported by a Caregiver - UI Design.

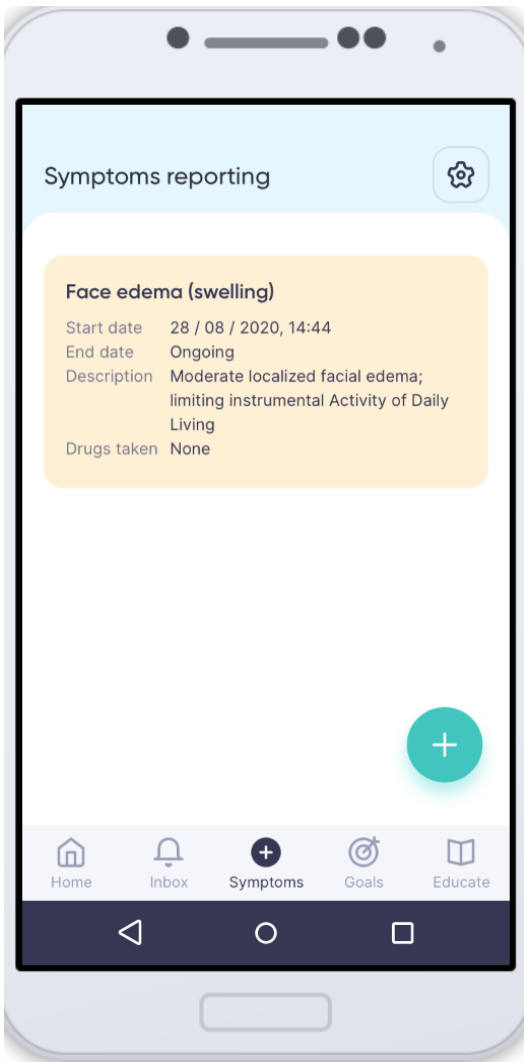


Figure 4.7.10 Symptoms tab - An example of a reported symptom - UI Design.

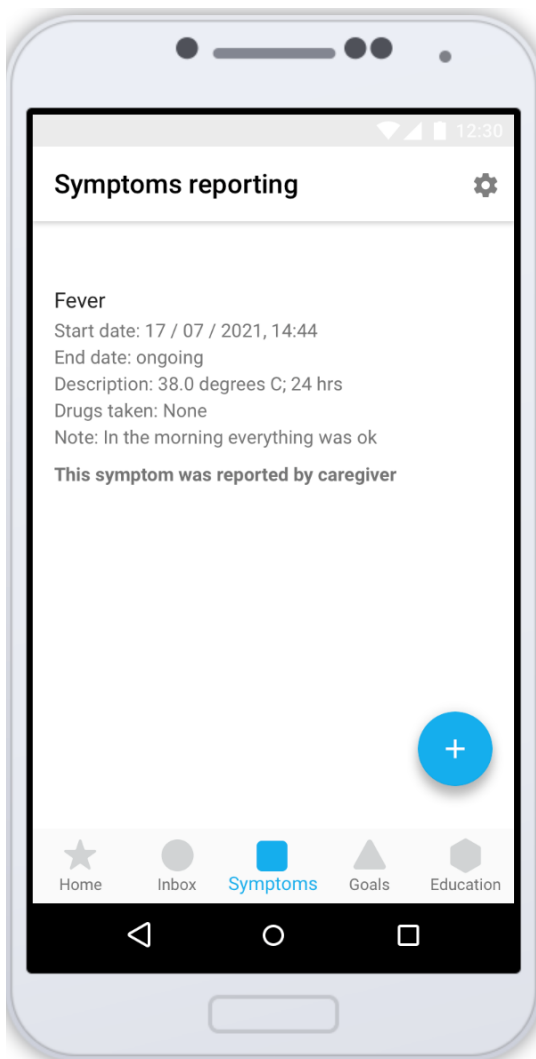


Figure 4.7.11 Symptoms tab - An example of a symptom reported by a caregiver.

Req. 1.2	Follow-up on symptom
Description	The app asks the patient about a symptom reported previously and whether the symptom persists. The app asks for more information or an additional symptom out of a closed list of relevant symptoms, as in Req. 1.1
Preconditions	The patient reported a symptom in the past
Post Conditions	If the symptom persists, show recommended content and feedback related to the symptom and continue performing the follow-up. If the symptom does not persist, the patient data is updated and the follow up of the symptom ends.
Course of action	The app generates a notification where the user is asked about the status of a symptom reported in the past. Here the user will be able to select if the symptom persists or not and if yes, the user will have to update the status of the symptom as in Req 1.1
Component dependency	Patient App, Virtual Coach, Data Platform

Planned delivery	M30
Responsible partners	BITSENS
Links to the mock-up	<p>Inbox tab, follow up on a symptom, request for an update:  <a href="https://projects.invisionapp.com/share/Q6X4P6ATJD3#/screens/449538423">https://projects.invisionapp.com/share/Q6X4P6ATJD3#/screens/449538423</a></p> <p>Inbox tab, follow up on a symptom, request for an update:  <a href="https://projects.invisionapp.com/share/Q6X4P6ATJD3#/screens/449538427">https://projects.invisionapp.com/share/Q6X4P6ATJD3#/screens/449538427</a></p>

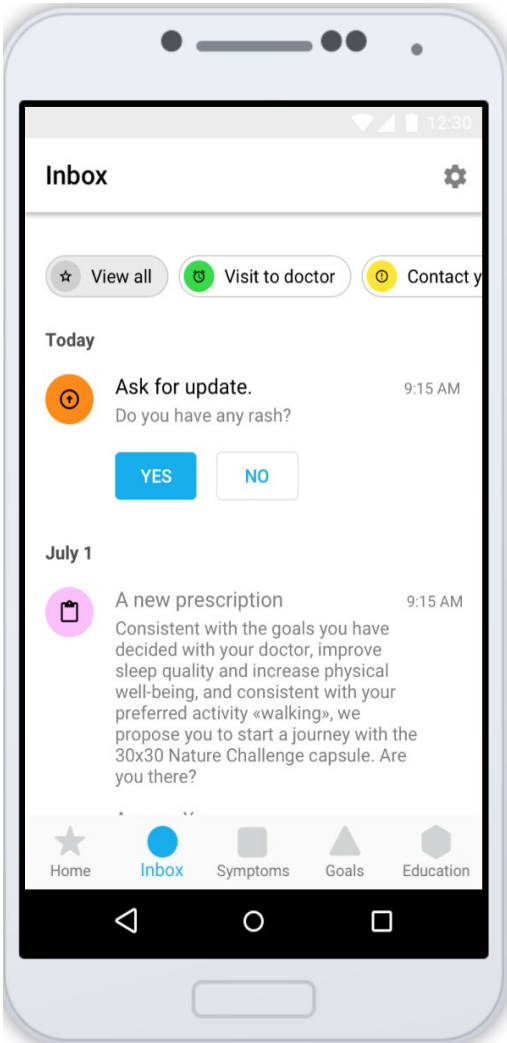


Figure 4.7.12 Inbox tab - Follow up on a Symptom.

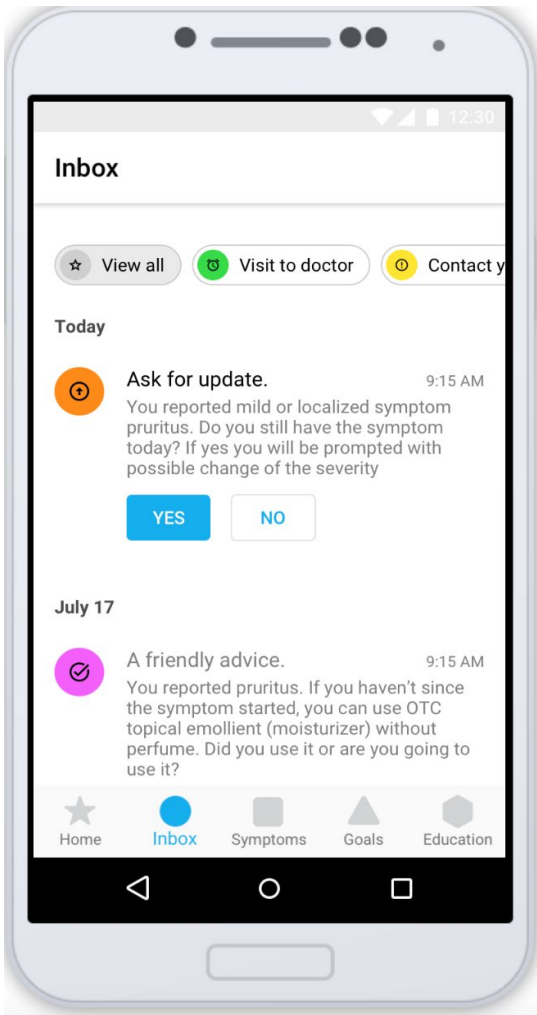


Figure 4.7.13 Inbox tab - Follow up on a Symptom.

Req. 1.3	Questionnaires (Itske)
Description	<p><b>Questionnaires for clinical use</b></p> <p>At enrolment, the patient meets several HCPs. The table below describes all questionnaires used to follow up on patients and which questionnaires will be implemented and used by CAPABLE. The questionnaire workflow differs for ICSM and NKI</p> <p>The patient will be able to report information about current (psychosocial) status through a GUI interface that will assist to fill the information using a simple and guided interaction with questions of the questionnaires defined in the clinical protocol.</p>
Preconditions	The patient is logged.
Post Conditions	The patient data is updated.
Course of action	<p>The user receives in his Inbox tab a notification to perform a Questionnaire. Also, a task to fill out a questionnaire is added to a Daily plan on the users Home tab. The user clicks on the questionnaire item that he/she wants to complete. The form automatically starts asking the different questions to answer and when the questionnaire is finished the app launches the report and recommendations based on the answers. The following table shows the different questionnaires that CAPABLE will include in the workflow.</p>

Code	Purpose	# questions	Frequency / Condition	Notes
HIG	How is it going? (Physically and emotionally)	2	Every 48hs without having interaction with CAPABLE, not having any ongoing symptoms. Slidebar (1 for physical and 1 for emotional)	
SYMP	Report type , intensity of symptoms	2 + other questions	On demand	
SYMP_FOLLOWUP	Follow up of previous reported symptoms	If symptom persists + grade + other questions	According to implemented guidelines	
MOOD	Mood thermometers	5	When user report low mood from HIG or periodically	
Psychological assessment*				
DEPR	PHQ9	9	According to the protocol in D7.1	
ANX	GAD7	7	According to the protocol in D7.1	
Nutritional assessment**				
MST	Malnutrition screening tool	2 (+1)	According to the protocol in D7.1	NKI: SNAQ  ICSM: MST
Other questionnaires				
ISI	Insomnia Severity Index***	7	According to the protocol in D7.1	
CBI****	Caregiver Burden Inventory	24	According to the protocol in D7.1	Only ICSM
FRS	Fatigue rating scale	10	According to the protocol in D7.1	Only ICSM
	Question about thoughts of death: In the last month, how much has your mind been focused on thoughts regarding the fear of illness and death? -Not at all -A little -Sometimes -Frequently -Very frequently	1	According to the protocol in D7.1	Only ICSM
	Question about sexual life: How have you perceived your sexual life in the last month? -Not satisfactory -Little satisfactory -Satisfactory -Inconstant	1	According to the protocol in D7.1	Only ICSM

	<table border="1" data-bbox="416 159 1315 226"> <tr> <td data-bbox="416 159 533 226"></td> <td data-bbox="533 159 820 226">-It is a sphere in which I am no longer interested</td> <td data-bbox="820 159 952 226"></td> <td data-bbox="952 159 1219 226"></td> <td data-bbox="1219 159 1315 226"></td> </tr> </table> <p><i>* Psychological assessment</i></p> <p>At the ICSM of Pavia, Italian patients enrolment is made by an oncologist, an engineer and a psychologist. A psychologist carries out the first psychological assessment during the visit. At the NKI, an oncologist and a health researcher (member of the CAPABLE research team) carry out the enrolment of Dutch patients. No psychologist is involved in the first psychological assessment, the patient will follow this workflow through CAPABLE. The following questionnaires are administered for psychological assessment according to proposal described in Deliverable 7.1:</p> <ul style="list-style-type: none"> <li>● Emotional thermometers. This tool is a simple rapid screening tool to detect and monitor emotional disorders in clinical practice. The questionnaire assesses distress, anxiety, depression, anger and the need for help.</li> <li>● Following the emotional thermometer: PHQ-9 questionnaire. This questionnaire assesses the presence of depression.</li> <li>● Following the emotional thermometer: GAD-7 (General Anxiety Disorder - 7) questionnaire. This questionnaire assesses the presence of anxiety.</li> </ul> <p>All questionnaires are validated and commonly used in clinical practice.</p> <p><i>**Nutritional assessment</i></p> <p>For nutritional information on the patient two questionnaires will be used.</p> <ul style="list-style-type: none"> <li>● Malnutrition screening tool (MST): In NKI this questionnaire is similar to/replaced by the SNAQ questionnaire (Short Nutritional Assessment Questionnaire), which assesses the same. The questionnaires estimate the risk of malnutrition in a quick and simple way.</li> </ul> <p>All questionnaires are validated and commonly used in clinical practice.</p> <p><i>*** Insomnia Severity Index: a questionnaire that consists of 7 questions to assess the severity of both nighttime and daytime components of insomnia.</i></p> <p><i>**** Caregiver Burden Inventory: a questionnaire to be given to a patient’s caregiver, which comprises 24 questions divided into five dimensions; time-dependence, developmental, physical, social and emotional burden.</i></p> <p>Follow-up of questionnaires and course of action is described in a workflow proposal written by ICSM and NKI and is added to D7.1.</p>		-It is a sphere in which I am no longer interested			
	-It is a sphere in which I am no longer interested					
<p>Alternate course A</p>	<p>A notification remembers the user to complete a questionnaire that is missing, or it is necessary for the follow up. In this notification the user will be able to postpone it or to complete the questionnaire. If the user clicks on the complete option, the form, automatically shown, starts asking the different questions to answer and when the questionnaire is finished the app launches the report and recommendations based on the</p>					



	answers.
Alternate course B	The user accesses from the home to Health Status module and selects the “questionnaires” option. Here the app shows a list of questionnaires and the item report. The user clicks on the report. Then a page with the report and charts about the information collected by the questionnaires is shown to the user.
Alternate course C	
Component dependency	Patient App, Virtual Coach, Data Platform
Planned delivery	M30
Responsible partners	BITSENS
Links to the mock-up	<p>Template of a questionnaire, PHQ-9:  <a href="https://projects.invisionapp.com/share/VB10JGM42A6U">https://projects.invisionapp.com/share/VB10JGM42A6U</a></p> <p>Template of a questionnaire, Insomnia Severity Index:  <a href="https://invis.io/2J11ZTNMTY9U">https://invis.io/2J11ZTNMTY9U</a></p> <p>Template of a questionnaire, Sleep facts:  <a href="https://invis.io/9411ZTO362B7">https://invis.io/9411ZTO362B7</a></p> <p>Template of a questionnaire, How are you feeling physically/emotionally:  <a href="https://projects.invisionapp.com/share/ZE1247EDNGU5#/screens">https://projects.invisionapp.com/share/ZE1247EDNGU5#/screens</a></p> <p>Template of a questionnaire, Mood thermometer:  <a href="https://projects.invisionapp.com/share/Q6X4P6ATJD3#/screens/461884695">https://projects.invisionapp.com/share/Q6X4P6ATJD3#/screens/461884695</a></p>

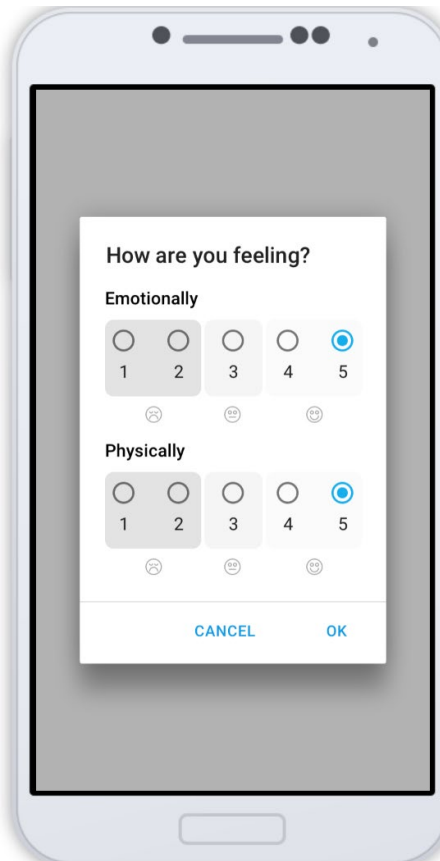


Figure 4.7.14 Example of pop-up notification with HIG questionnaire.

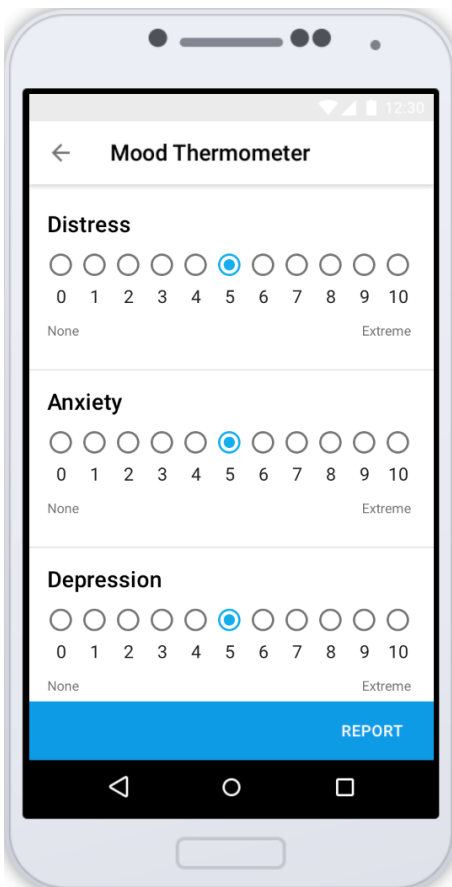


Figure 4.7.15 Mood Thermometer Questionnaire.

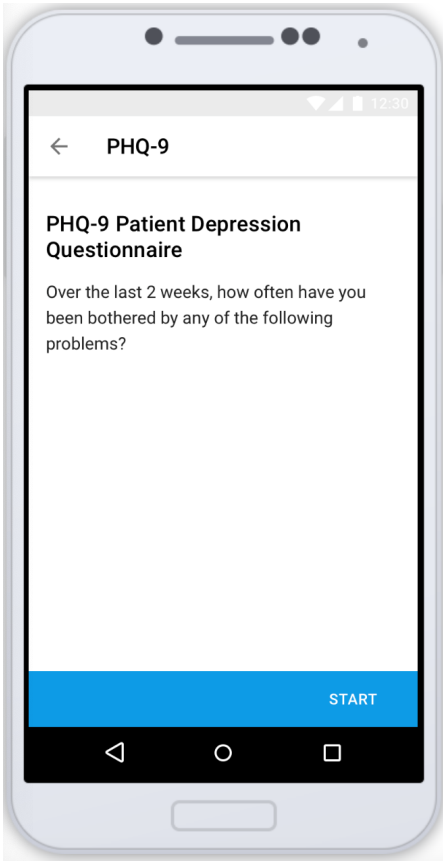


Figure 4.7.16 PHQ-9 Patient Depression Questionnaire

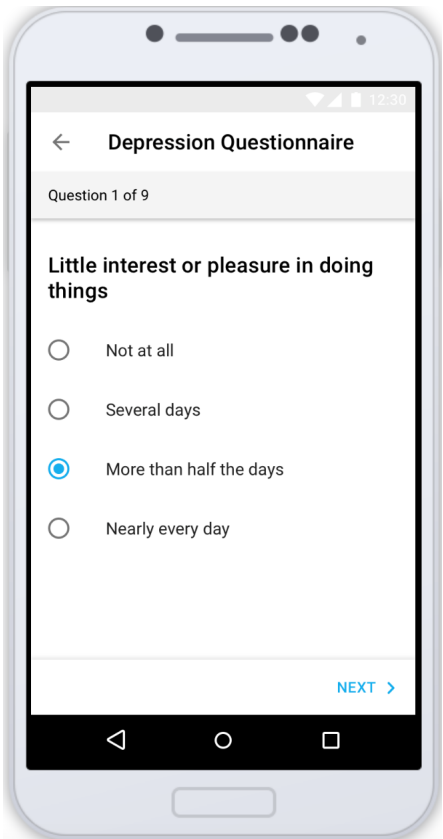


Figure 4.7.17 PHQ-9 Patient Depression Questionnaire in progress

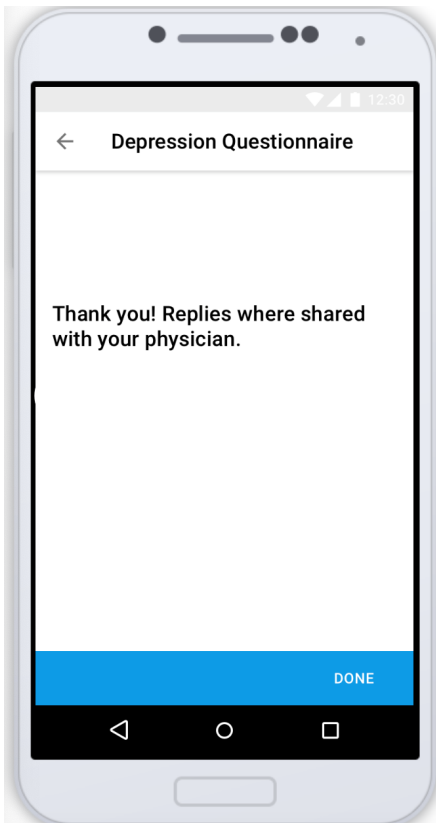


Figure 4.7.18 Result of the PHQ-9 Patient Depression Questionnaire

Req. 1.4	Data from sensors
Description	The patient will be able to use the smartwatch as a source of so-called lifestyle data (related to physical activity and sleep) for the app. For this purpose, the CAPABLE system will include a module for synchronization of data collected by the smartwatch and stored in the cloud with the Data Platform, so they can be accessible to other system components, including the PatientApp.
Preconditions	Collected smartwatch data have been stored in the Data Platform. The patient is logged in.
Post Conditions	-
Course of action	The patient switches to the <i>Home</i> tab and scrolls down to the <i>Lifestyle data</i> section. Here the application shows the data for the current day (today) together with the timestamp of the last synchronization with the cloud.
Alternate course A	
Alternate course B	
Alternate course C	

Component dependency	Patient App, Sensors, Data Platform
Planned delivery	M30
Responsible partners	BITSENS
Links to the mock-up	Home tab with Sensor information and Vital signs: <a href="https://projects.invisionapp.com/share/Q6X4P6ATJD3#/screens/429762925">https://projects.invisionapp.com/share/Q6X4P6ATJD3#/screens/429762925</a>

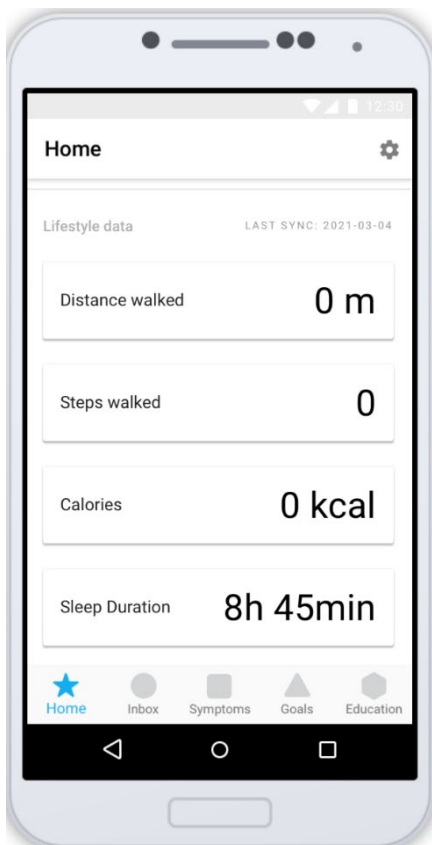


Figure 4.7.19 Home tab with the Data from connected Sensor and the last synchronisation date and time.

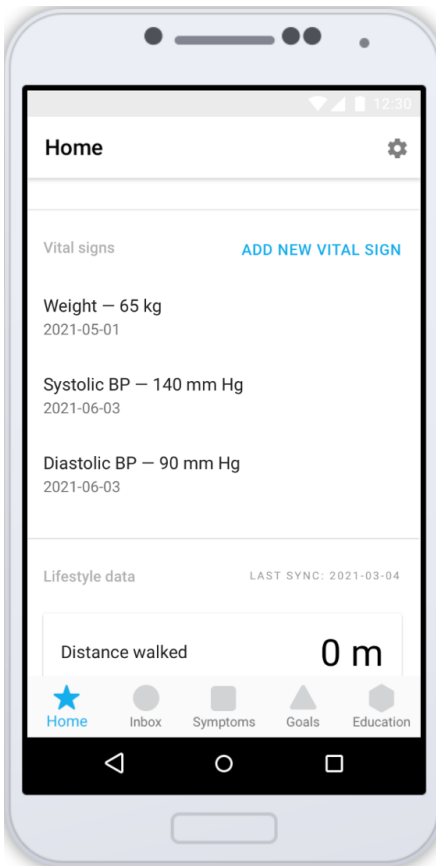


Figure 4.7.20 Home tab with the Vital signs – weight and blood pressure data entered manually by a Patient.

Req. 2.1	Overall plan								
Description	<p>The patient will be able to check the plan of reminders and actions that he/she should follow. For this purpose, the application will show the overall, weekly and Daily plan (therapeutic contract). Also, the patient will be able to configure the reminders of the app. By default, reminders will be active and the user will be able to enable/disable all the notifications in Settings. If the notifications are disabled the system should propose to the user to activate them.</p> <table border="1" data-bbox="416 1464 1350 2038"> <thead> <tr> <th data-bbox="416 1464 660 1509">Topic</th> <th data-bbox="660 1464 1350 1509">Contents of reminders</th> </tr> </thead> <tbody> <tr> <td data-bbox="416 1509 660 1653">Treatment management</td> <td data-bbox="660 1509 1350 1653"> <ul style="list-style-type: none"> <li>● Medication reminders</li> <li>● Prescription visualization</li> <li>● Recommendations on intake</li> </ul> </td> </tr> <tr> <td data-bbox="416 1653 660 1865">Side effect awareness</td> <td data-bbox="660 1653 1350 1865"> <ul style="list-style-type: none"> <li>● List of relevant side effects to be reported</li> <li>● Overall strategy of symptoms reporting</li> <li>● Feedbacks from DSS after reporting symptoms</li> <li>● Follow up or reported symptom</li> </ul> </td> </tr> <tr> <td data-bbox="416 1865 660 2038">Management of other problem</td> <td data-bbox="660 1865 1350 2038"> <ul style="list-style-type: none"> <li>● Emotional distress</li> <li>● Sleep problems</li> <li>● Sexual life</li> <li>● Weight management</li> <li>● Malnutrition</li> </ul> </td> </tr> </tbody> </table>	Topic	Contents of reminders	Treatment management	<ul style="list-style-type: none"> <li>● Medication reminders</li> <li>● Prescription visualization</li> <li>● Recommendations on intake</li> </ul>	Side effect awareness	<ul style="list-style-type: none"> <li>● List of relevant side effects to be reported</li> <li>● Overall strategy of symptoms reporting</li> <li>● Feedbacks from DSS after reporting symptoms</li> <li>● Follow up or reported symptom</li> </ul>	Management of other problem	<ul style="list-style-type: none"> <li>● Emotional distress</li> <li>● Sleep problems</li> <li>● Sexual life</li> <li>● Weight management</li> <li>● Malnutrition</li> </ul>
Topic	Contents of reminders								
Treatment management	<ul style="list-style-type: none"> <li>● Medication reminders</li> <li>● Prescription visualization</li> <li>● Recommendations on intake</li> </ul>								
Side effect awareness	<ul style="list-style-type: none"> <li>● List of relevant side effects to be reported</li> <li>● Overall strategy of symptoms reporting</li> <li>● Feedbacks from DSS after reporting symptoms</li> <li>● Follow up or reported symptom</li> </ul>								
Management of other problem	<ul style="list-style-type: none"> <li>● Emotional distress</li> <li>● Sleep problems</li> <li>● Sexual life</li> <li>● Weight management</li> <li>● Malnutrition</li> </ul>								

	<table border="1"> <tr> <td>Promotion of healthy habits</td> <td> <ul style="list-style-type: none"> <li>• Physical activity</li> <li>• Dietary habits</li> <li>• Stay positive</li> <li>• Keep social and active</li> </ul> </td> </tr> </table> <p>This requirement is related to two Clinical Needs (CN) mentioned in Section 5.5:          CN3: Provide digital tools to patients to foster adherence, and assist to face the daily problems of the cancer journey.          CN5: Foster interdepartmental collaborations to offer integrative services with Supportive Care Team and other specialists (e.g. nutritionists, clinical psychology, social services).</p>	Promotion of healthy habits	<ul style="list-style-type: none"> <li>• Physical activity</li> <li>• Dietary habits</li> <li>• Stay positive</li> <li>• Keep social and active</li> </ul>
Promotion of healthy habits	<ul style="list-style-type: none"> <li>• Physical activity</li> <li>• Dietary habits</li> <li>• Stay positive</li> <li>• Keep social and active</li> </ul>		
Preconditions	The patient is logged.		
Post Conditions	-		
Course of action	The user accesses from the home tab into Calendar. Here, the app shows the overall plan of the reminders (default configurations if it never changed) for the patients and here it is possible to change for only weekly or daily plans.		
Component dependency	Patient App, Virtual Coach, Data Platform		
Planned delivery	M30		
Responsible partners	BITSENS		
Links to the mock-up	Home tab, calendar view with monthly plan of actions/activities/prescriptions: <a href="https://projects.invisionapp.com/share/Q6X4P6ATJD3#/screens/461884687">https://projects.invisionapp.com/share/Q6X4P6ATJD3#/screens/461884687</a>		

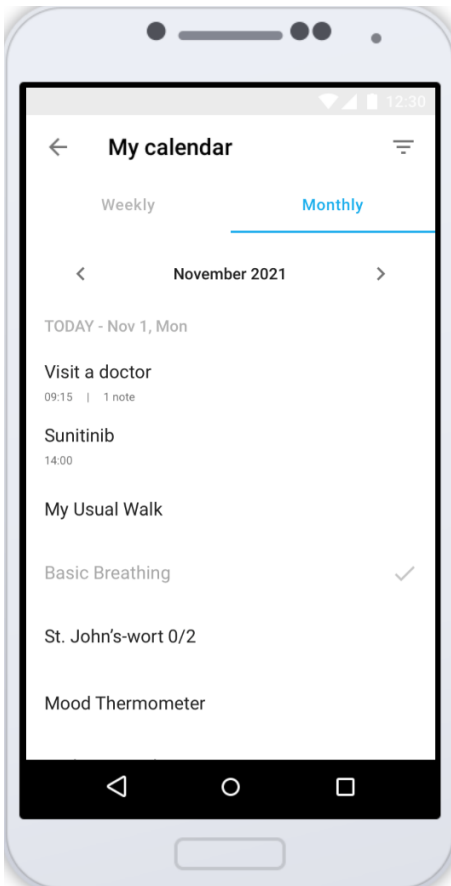


Figure 4.7.21 Home tab with an Overall monthly plan of patient’s activities - a report of all the activities to do during the month - Treatments, Goal activities, Questionnaires and Evaluation of Daily activities.

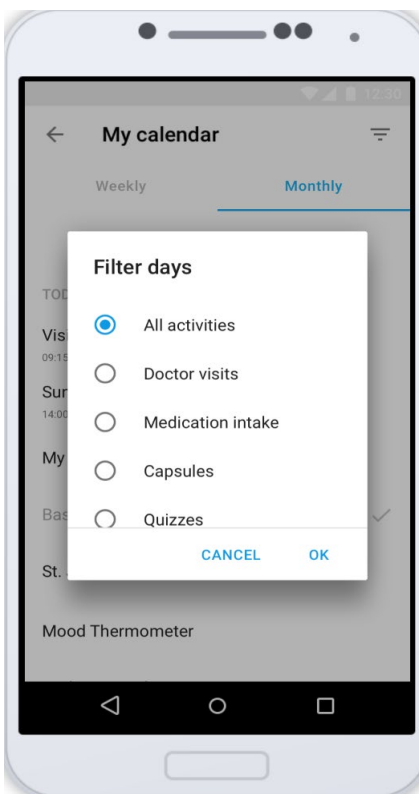


Figure 4.7.22 Home tab with an Overall monthly plan of patient’s activities - possibility to filter activities by type.



Req. 2.2.1	Weekly plan
Description	
Preconditions	The patient is logged.
Post Conditions	-
Course of action	The user accesses from the home tab into Calendar and selects the “Weekly plan” option in the overall plan. Here the app shows a report of all the activities to do during the week. This page shows the actions pending and the actions already done.
Alternate course A	
Alternate course B	
Alternate course C	
Component dependency	Patient App, Virtual Coach, Data Platform
Planned delivery	M30
Responsible partners	BITSENS
Links to the mock-up	Home tab, calendar view with weekly plan of actions/activities/prescriptions: <a href="https://projects.invisionapp.com/share/Q6X4P6ATJD3#/screens/461884686">https://projects.invisionapp.com/share/Q6X4P6ATJD3#/screens/461884686</a>

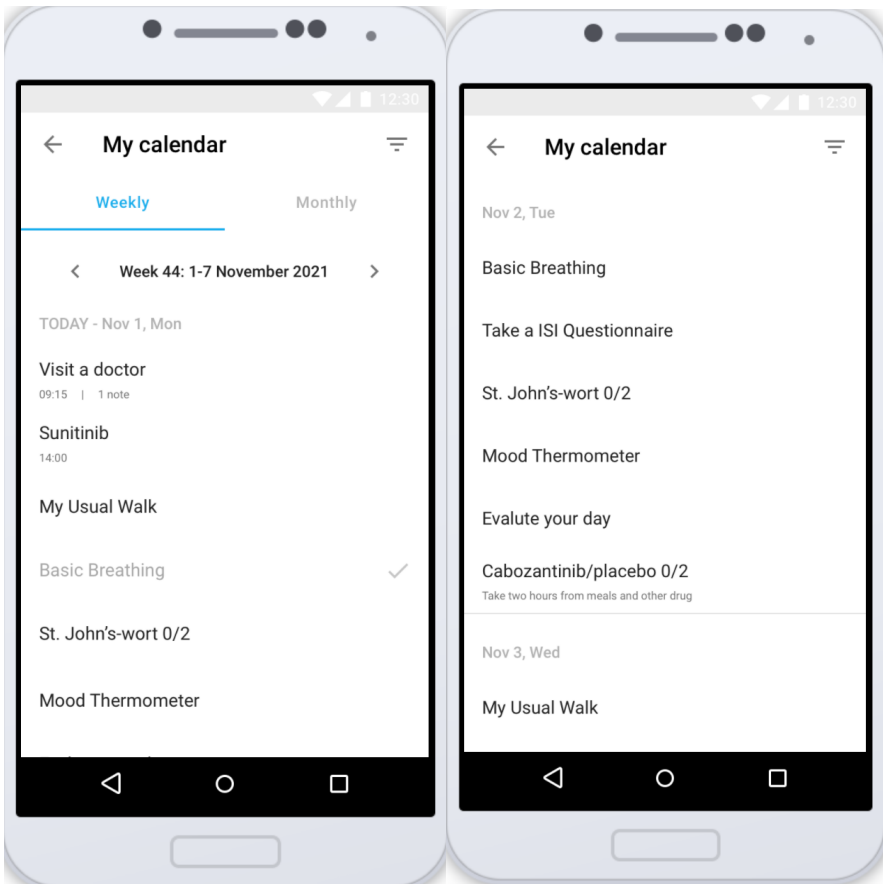


Figure 4.7.23 Home tab with a Weekly Plan - a report of all the activities to do during the week - Treatments, Reminders, Goal activities, Questionnaires and Evaluation of Daily activities.

Req. 2.2.2	Daily Plan
Description	The patient is presented with the daily plan, i.e., a list of different actions they are supposed to perform on the current day (today). The list may contain the following entries: treatments (drugs), wellbeing activities (capsules), reminders about scheduled visits, questionnaires to be completed, Mood thermometer and evaluations of daily activities.
Preconditions	The patient is logged.
Post Conditions	Completed actions are marked with a check mark and kept on the list to give the patient the sense of accomplishment. All updates are stored in Data Platform.
Course of action	<p>The patient switches to the <i>Home</i> tab. The app presents the list of activities planned for today (<i>Your plan for today</i>). If no actions have been planned, then the list is empty.</p> <p>Each list entry (action) is characterized by:</p> <ul style="list-style-type: none"> <li>the description of activity (e.g. “visit a doctor” or “evaluate your daily activities”),</li> <li>optional additional information that depends on the type of activity (e.g., for a scheduled visit it is the visit time and for a drug it is the reported administration time).</li> </ul> <p>After selecting an entry, the user is taken to an activity-specific screen where they can see the description of the activity, report its completion (providing additional information if required) or cancel it.</p>

	<p>The patient can report an activity - visit to doctor (for example) 24 hour in the past, but can report events in the future.</p> <p>In addition to the daily plan, the <i>Home</i> tab also displays current vital signs, lifestyle data collected by smartwatch sensors (see req. 1.4) and achievements collected so far (see req. 3.2).</p>
Component dependency	Patient App, Virtual Coach, Data Platform
Planned delivery	M30
Responsible partners	BITSENS
Links to the mock-up	<p>Home tab with no activities in Daily plan (when the app is activated for the first time):  <a href="https://projects.invisionapp.com/share/Q6X4P6ATJD3#/screens/450983260">https://projects.invisionapp.com/share/Q6X4P6ATJD3#/screens/450983260</a></p> <p>Home tab with daily plan and weekly overview - both options give possibility to report different type of activities:  <a href="https://projects.invisionapp.com/share/Q6X4P6ATJD3#/screens/429762925">https://projects.invisionapp.com/share/Q6X4P6ATJD3#/screens/429762925</a></p> <p>Report medication intake:  <a href="https://projects.invisionapp.com/share/Q6X4P6ATJD3#/screens/438341895">https://projects.invisionapp.com/share/Q6X4P6ATJD3#/screens/438341895</a></p> <p>Report medication intake (with a note from a Physician):  <a href="https://projects.invisionapp.com/share/Q6X4P6ATJD3#/screens/461945958">https://projects.invisionapp.com/share/Q6X4P6ATJD3#/screens/461945958</a></p>

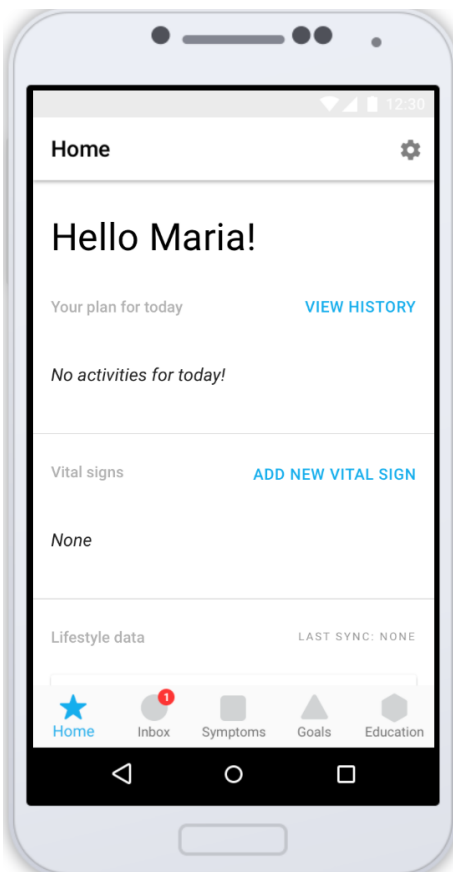


Figure 4.7.24 - Home tab with no activities in a Daily Plan.

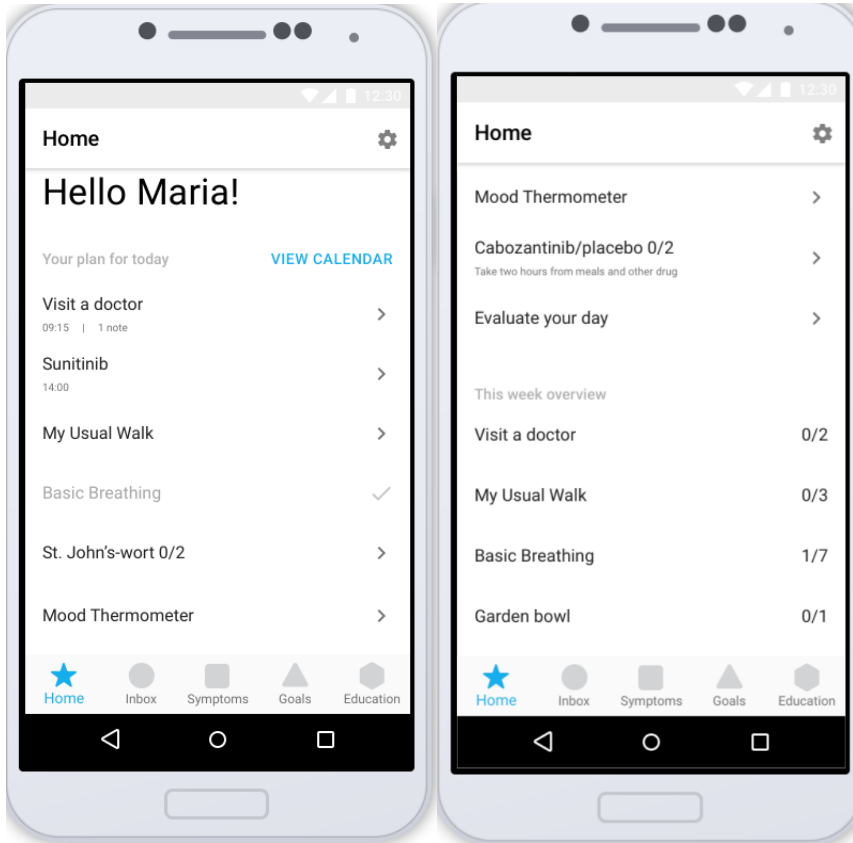


Figure 4.7.25 Home tab with a Daily Plan - a report of all the activities to do during the day - Visit a doctor with note, Treatments, Reminders, Goal activities, Questionnaires and Evaluation of Daily activities. Activity to perform Basic Breathing is marked as done. Week overview is presented below the Daily plan and shows the quantity of performed activities and the quantity of planned activities for a week. For example, My usual walk 0/3 means no usual walk was done yet during this week, but the plan is 3 walks. Basic Breathing 1/7 means 1 exercise out of 7 planned for this week is done.

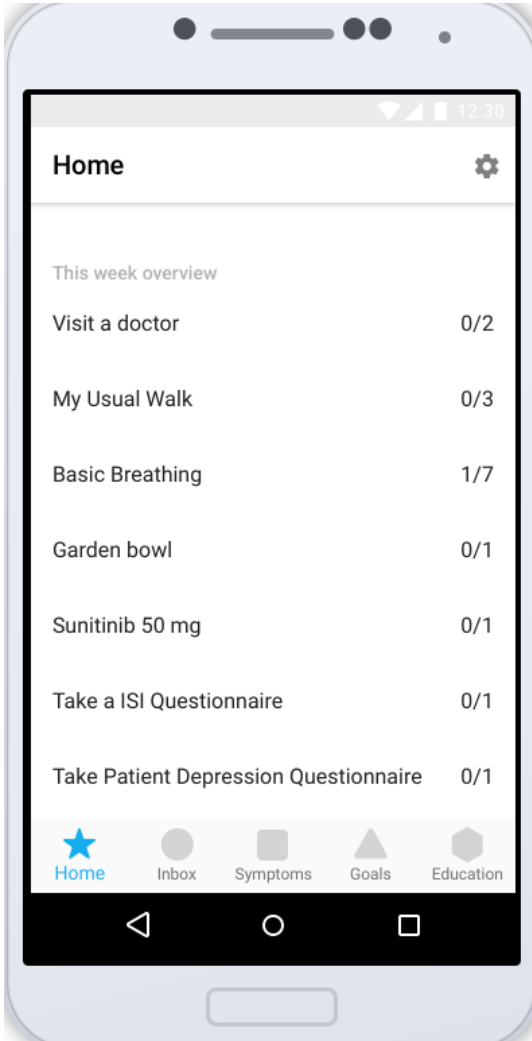


Figure 4.7.26 Home tab with a Weekly overview - a report of all prescribed activities showing the quantity of planned actions and already done actions. For example, for now one out of seven Basic Breathing exercises was done during this week.

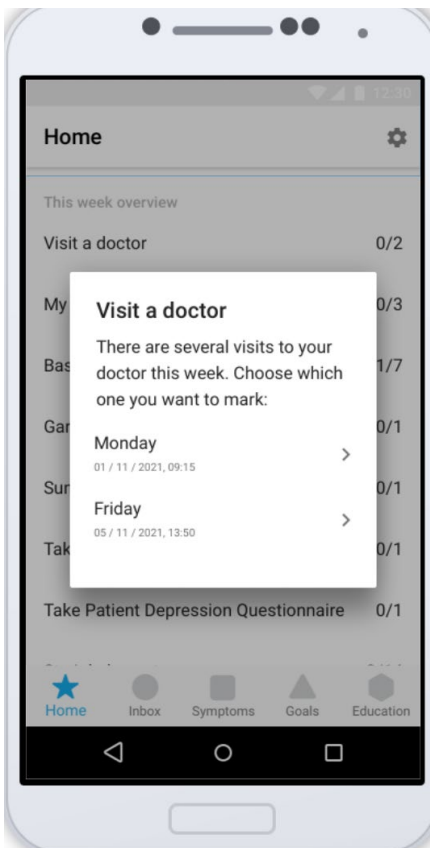


Figure 4.7.27 Home tab with a Weekly overview - a report of all prescribed activities showing the quantity of planned actions and already done actions. It is possible to report an activity through Weekly overview. In case there are more than one activity of that type planned for this week - there will be shown a pop-up with possible options to choose. For example, a patient has two planned visits. When he reports through Weekly overview he will choose the appropriate day and time to complete the activity.

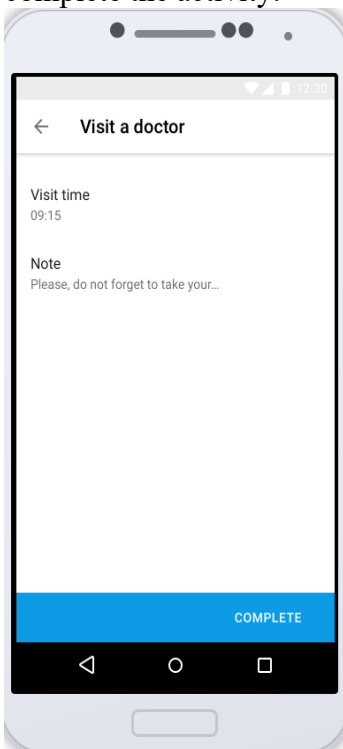


Figure 4.7.28 Home tab with a Daily Plan - a report for Visit a Doctor activity - displays visit time and a note posted by a Physician through a Physician's Dashboard if necessary.

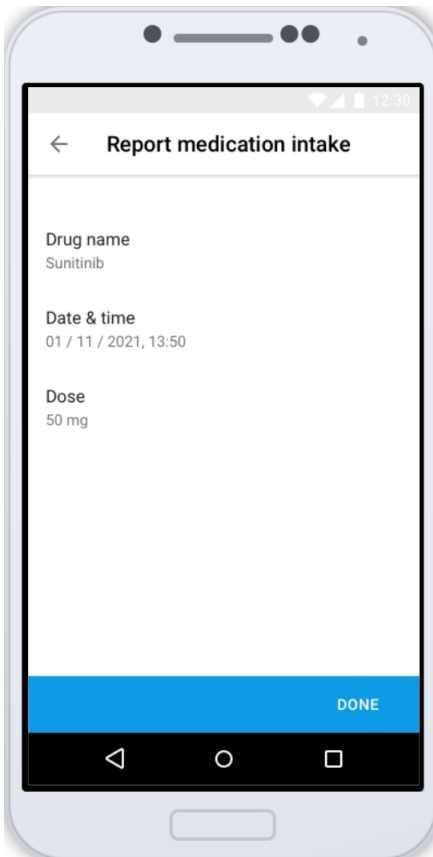


Figure 4.7.29 Home tab with a Daily Plan - a report for medication intake.

Req. 2.2.3	Reminders set up/preferences
Description	<p>The patient will be able to configure the reminders of the app. Unless the user declines notifications, then by default, some core reminders will be active, and the user will be able to disable them as wanted.</p> <p>There will be two possible configurations of the reminders:                      In a specific time frame, knowing the user routine (e.g. before going to bed). This requires some information from the user about usual wake up, sleep time.) This information will be gathered during Onboarding to the app and accessible through Settings/Notifications Setup.                      In a specific time (e.g. 13:27) When Capable proposes a new periodic action to the users (e.g. perform physical activity) the system should propose to the user a reminder. (Requirement 3.1)</p> <p>The configuration of the reminders will depend on the information gathered by the clinician about the patient (See Section 5.2, Req.1). With this information the reminders will be adapted to the preferences of the clinician and the needs of the patient.</p> <p>All other activities will be set up automatically by the CAPABLE System.</p>
Preconditions	The patient is logged.
Post Conditions	The patient receives a notification message that reminds him about some actions to be taken. Actions refers to health related actions (visits, medications) or suggested / planned activities
Course of action	The user accesses from the home to Daily plan or weekly overview and selects the item of the plan to configure. Here, the app shows the actual

	configuration/time of the reminder (default configurations if it never changed).
Alternate course A	
Alternate course B	
Alternate course C	
Component dependency	Patient App, Virtual Coach, Data Platform
Planned delivery	M30
Responsible partners	BITSENS
Links to the mock-up	Home tab with no activities in Daily plan (when the app is activated for the first time): <a href="https://projects.invisionapp.com/share/Q6X4P6ATJD3#/screens/450983260">https://projects.invisionapp.com/share/Q6X4P6ATJD3#/screens/450983260</a> Home tab with daily plan and weekly overview - both options give possibility to report different type of activities: <a href="https://projects.invisionapp.com/share/Q6X4P6ATJD3#/screens/429762925">https://projects.invisionapp.com/share/Q6X4P6ATJD3#/screens/429762925</a>

Req. 3.1	Recommendations and reminders
Description	<p>The patient is presented with the list of recommended actions and reminders for selected actions that are not part of the daily plan (see req. 2.2.2), such as symptom reports.</p> <p>Action recommendations and reminders are generated by the decision support components (Virtual Coach or Physician DSS). Recommended actions can be basic (a single step, e.g., a recommendation to contact a physician when changes to therapy are necessary) or complex (a sequence of basic actions, e.g., a capsule with an exercise or meditation program), and reminders are related to basic actions.</p> <p>Certain action recommendations and reminders require explicit confirmation by the patient (this requirement is specified as part of the action’s formal definition). Examples include initiating a capsule, starting treatment pre-approved by the physician (prescribed as needed), or symptom reporting. The patient is free to reject these actions -- this puts the patient in full control over the patient-oriented part of the system.</p>
Preconditions	The Virtual Coach or the Physician DSS has generated at least one action recommendation or reminder. The patient is logged in the app.
Post Conditions	If the action recommendation or reminder requires explicit confirmation, then the patient’s approval or rejection of the action is



	<p>stored. If the action is complex and it has been approved, basic actions will appear in weekly and daily plans (see req. 2.2.1 and 2.2.2).</p>
Course of action	<p>New recommendations and/or reminders are added to the list on the <i>Inbox</i> tab and a badge is added to the <i>Inbox</i> button to indicate their availability.</p> <p>The patient navigates to the <i>Inbox</i> tab and is presented with the list of new and existing (current or past) recommendations and reminders. The list is divided into sections corresponding to specific days sorted chronologically with the current day (today) on the top. Past reminders and recommendations are disabled and the patient cannot interact with them.</p> <p>Each entry in the list (recommendation or reminder) is characterized by:</p> <ul style="list-style-type: none"> <li>● type, i.e., “recommendation” or “symptom update”,</li> <li>● description with additional details,</li> <li>● optional buttons for confirming or rejecting the recommendation or reminder (if required). Confirming a recommendation related to symptom reporting results in taking the patient to the symptom reporting screen (see req. 1.2). A confirmed or rejected entry becomes inactive (the response cannot be changed).</li> </ul> <p>The list can be filtered by the entry type to limit the amount of displayed information.</p>
Alternate course A	
Component dependency	Patient App, Virtual Coach, Data Platform
Planned delivery	M30
Responsible partners	BITSENS
Links to the mock-up	<p>Home tab with daily plan and weekly overview - both options give possibility to report different type of activities:  <a href="https://projects.invisionapp.com/share/Q6X4P6ATJD3#/screens/429762925">https://projects.invisionapp.com/share/Q6X4P6ATJD3#/screens/429762925</a></p> <p>Different types of reminders and notifications in an Inbox:  <a href="https://projects.invisionapp.com/share/Q6X4P6ATJD3#/screens/449538435">https://projects.invisionapp.com/share/Q6X4P6ATJD3#/screens/449538435</a></p> <p>Visit a doctor reminder:</p> <ol style="list-style-type: none"> <li>1. <a href="https://projects.invisionapp.com/share/Q6X4P6ATJD3#/screens/452709636">https://projects.invisionapp.com/share/Q6X4P6ATJD3#/screens/452709636</a></li> <li>2. <a href="https://projects.invisionapp.com/share/Q6X4P6ATJD3#/screens/452709639">https://projects.invisionapp.com/share/Q6X4P6ATJD3#/screens/452709639</a></li> </ol> <p>Notification about prescribed medications:  <a href="https://projects.invisionapp.com/share/Q6X4P6ATJD3#/screens/452709641">https://projects.invisionapp.com/share/Q6X4P6ATJD3#/screens/452709641</a></p>

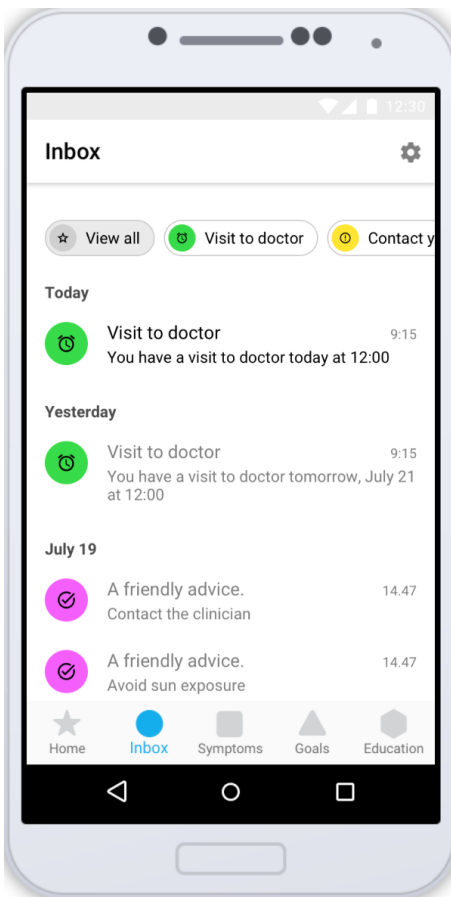


Figure 4.7.30 Types of reminders and notifications in an Inbox - example of a Visit to doctor notification on the visit day.

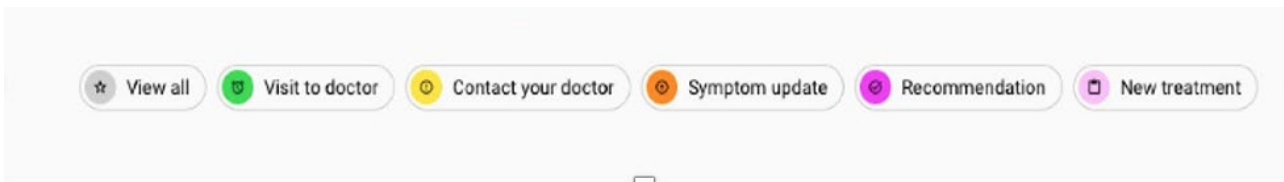


Figure 4.7.31 Types of reminders and notifications in an Inbox - Visit to doctor, contact your Doctor, Symptom update, Recommendation, New treatment, view all groups.

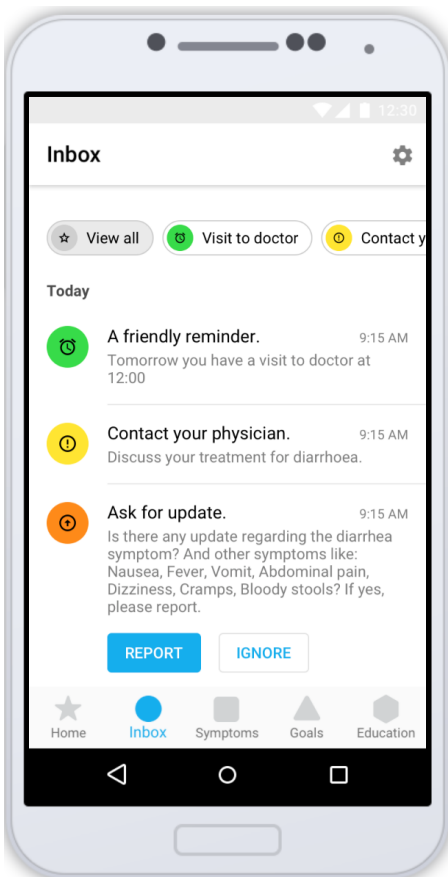


Figure 4.7.32 Inbox tab with different types of reminders and notifications.

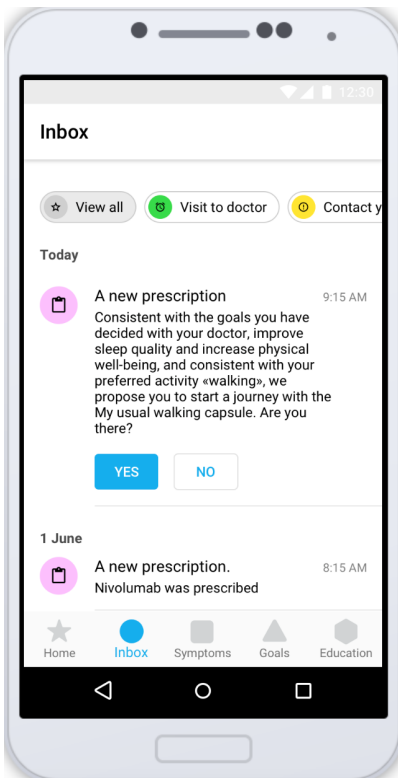


Figure 4.7.33 Types of reminders and notifications in an Inbox - example of a New treatment.

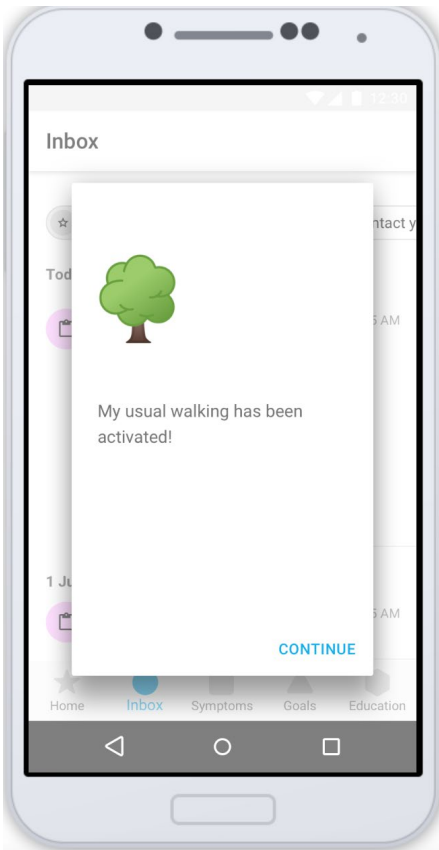


Figure 4.7.34 Types of reminders and notifications in an Inbox - example of a pop-up with a successful Capsule activation.

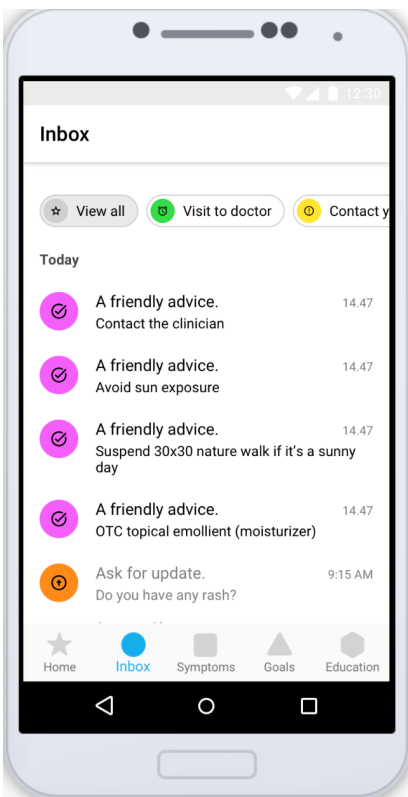


Figure 4.7.35 Types of reminders and notifications in an Inbox - example of recommendations on a reported symptom.

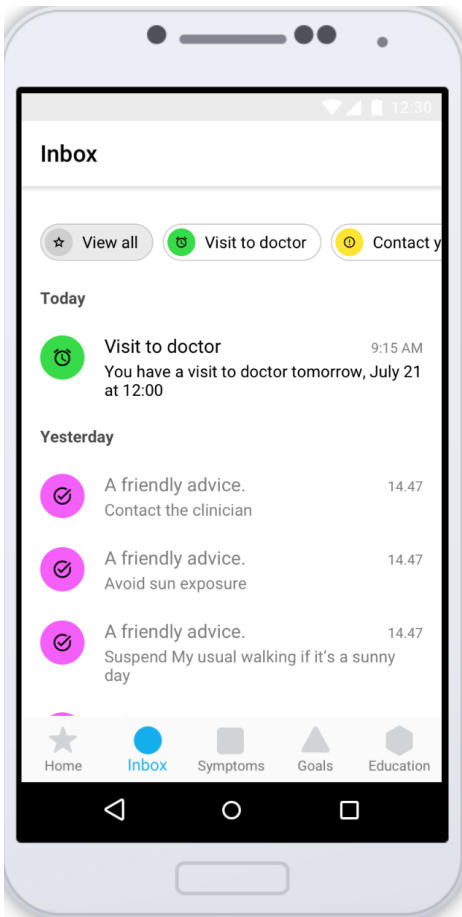


Figure 4.5.36 Types of reminders and notifications in an Inbox - example of a Visit to doctor notification the day before a visit.

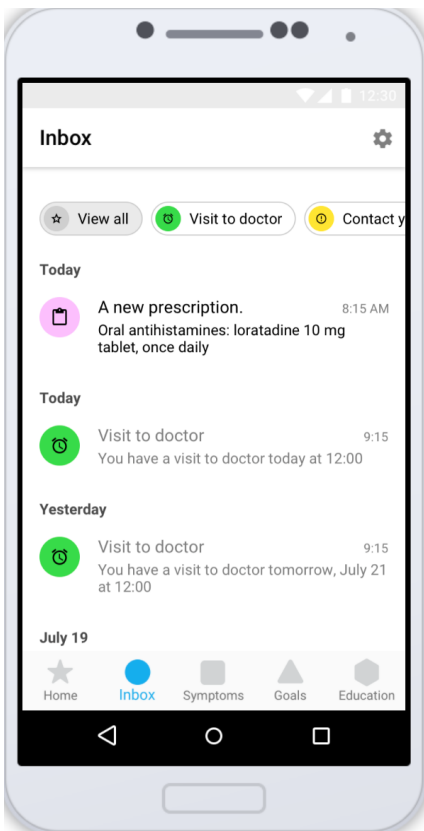


Figure 4.7.37 Types of reminders and notifications in an Inbox - example of a New treatment.

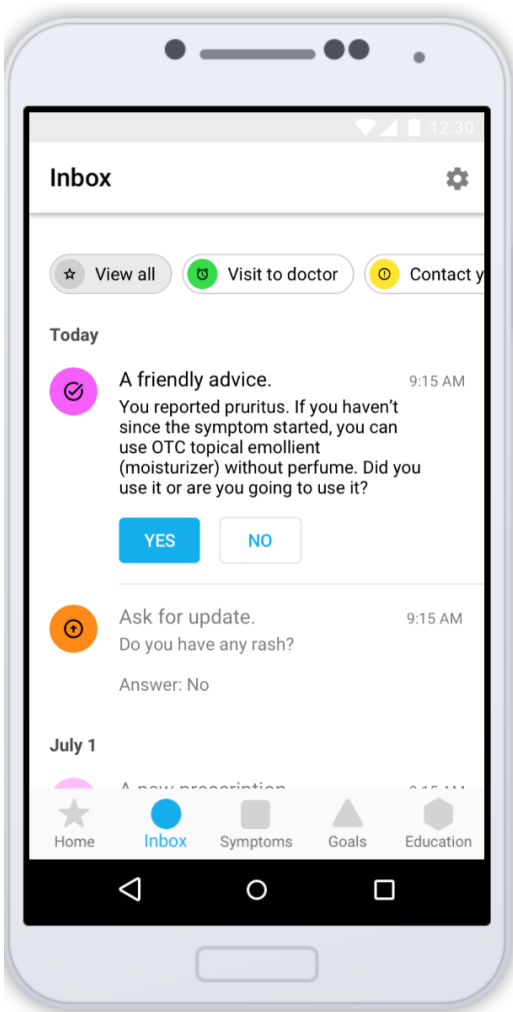


Figure 4.7.38 Types of reminders and notifications in an Inbox - example of a Recommendation on a reported symptom.

Req. 3.2	Motivational feedback
Description	<p>The app should encourage the patient to be more engaged with his health and wellbeing through the app via rewards and motivational feedback messages.</p> <p><i>HCP workflow:</i> The compliance to the virtual CAPSULES will be computed and sent to the CAPABLE Physicians dashboard. In ICSM, the psychologists will assess this and decide whether to show and discuss it with their patients. In NKI, psychologists are not involved in this workflow.</p>
Preconditions	
Post Conditions	
Course of action	<p>Additional feedback messages (kind messages) could compliment the patient for good behavior (engaging), could ask for his rating on the usefulness of proposed capsules he experienced.</p> <p>A reward system will be used such that the user will receive awards for his “good behavior”. For example, for performing the first prescribed virtual capsule, for performing a capsule for the 10th time, or for performing CAPSULES related to a specific goal for the 20th time.</p>

Alternate course A	
Alternate course B	
Alternate course C	
Component dependency	Patient App, Virtual Coach, Data Platform
Planned delivery	M30
Responsible partners	BITSENS
Links to the mock-up	Home tab with daily plan and weekly overview, sensor data, vital signs and achievements section: <a href="https://projects.invisionapp.com/share/Q6X4P6ATJD3#/screens/429762925">https://projects.invisionapp.com/share/Q6X4P6ATJD3#/screens/429762925</a>

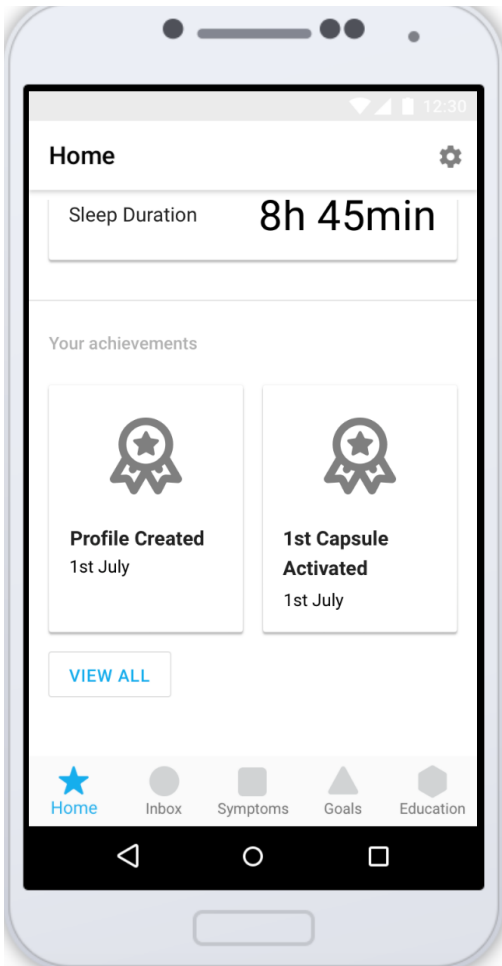


Figure 4.7.39 Home tab with the Patient's achievements (Motivational feedback).

Req. 4.1	Goal Settings
Description	The patient selects one or more goals among those that have been indicated for him by his clinicians during a visit: Physical Wellbeing, Sleep Improvement, Mental Wellbeing
Preconditions	Patient logged into the app and selected the Capsules functionality
Post Conditions	The patient is shown the capsules available for the selected goals
Course of action	<p>The patient is shown the available goals that are:</p> <ul style="list-style-type: none"> <li>● Physical activity</li> <li>● Sleep Improvement</li> <li>● Mental Wellbeing: <ul style="list-style-type: none"> <li>○ Accepting and expressing the cancer journey</li> </ul> </li> </ul> <p>The patient can select one or more goals. Once the goal is selected, the patient is shown the capsules available for that goal, and can select the ones to try, which are then activated.</p>
Component dependency	Patient App, Virtual Coach, Data Platform
Planned delivery	M30
Responsible partners	UOH, BITSSENS, PUT, UNIPV
Links to the mock-up	<p>Goals tab with all the capsules (activities) available to the Patient:  <a href="https://projects.invisionapp.com/share/Q6X4P6ATJD3#/screens/416146985">https://projects.invisionapp.com/share/Q6X4P6ATJD3#/screens/416146985</a>  Introduction to the Capsules section:  <a href="https://projects.invisionapp.com/share/Q6X4P6ATJD3#/screens/434096723">https://projects.invisionapp.com/share/Q6X4P6ATJD3#/screens/434096723</a></p>



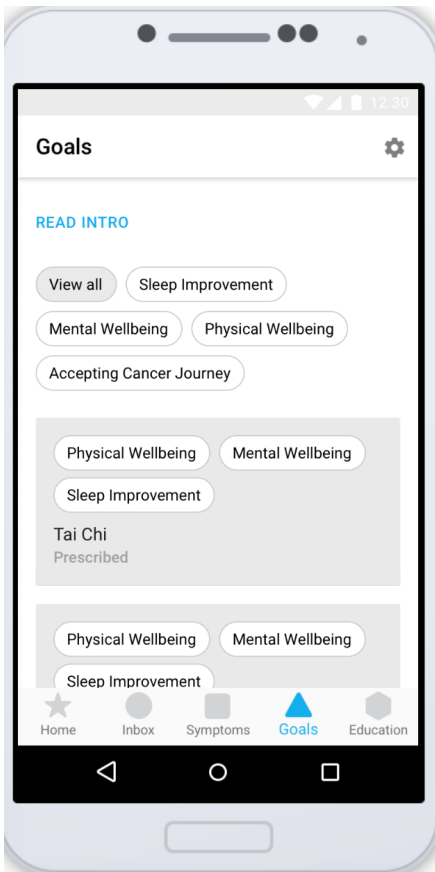


Figure 4.7.40 Goal tab - a Patient is shown the list of goals to achieve divided into groups and all correlated activities (that are called Virtual Capsules) that can be performed to achieve the Goal.

The following two screens show the Introduction to the capsules.

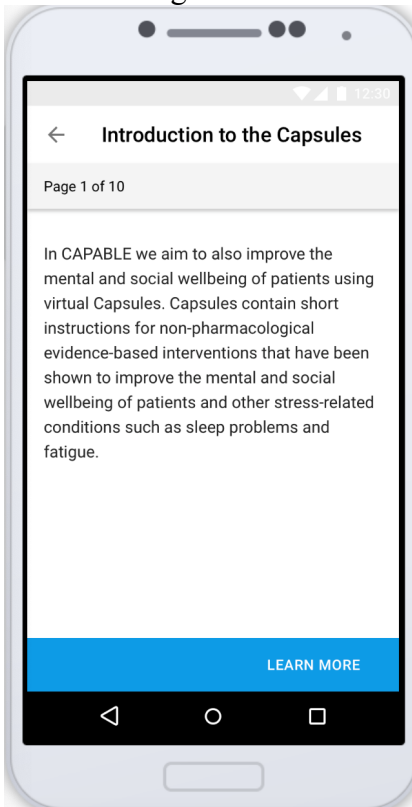


Figure 4.7.41 introduction to the Capsules.

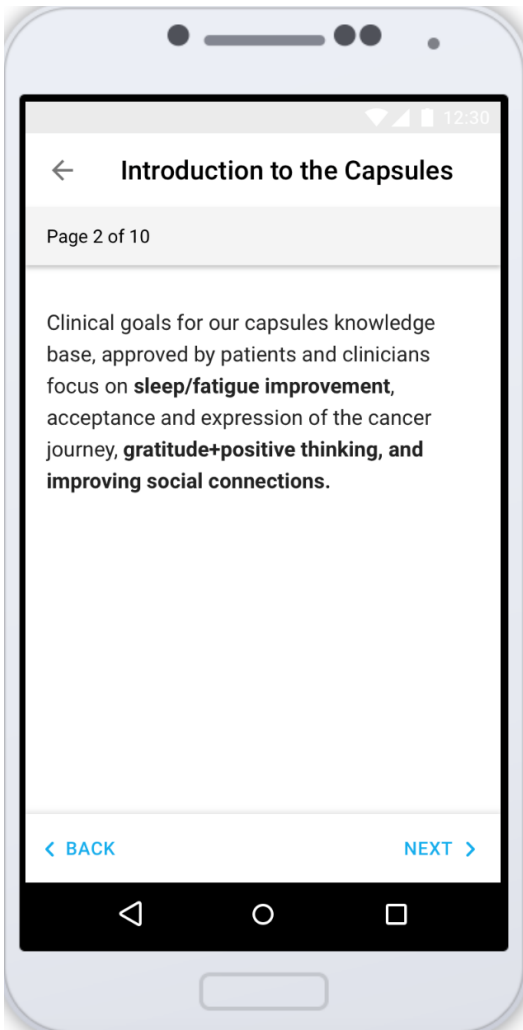


Figure 4.7.42 introduction to the Capsules – slide view and possibility to scroll slides.

Req. 4.2	Educational Contents
Description	<p>The patient selects the educational material they want to consult. The aim is to include educational material on the following topics:</p> <ul style="list-style-type: none"> <li>● Diagnosis</li> <li>● Treatment</li> <li>● AYA (adolescents &amp; young adults) care</li> <li>● Side-effects (chemotherapy/immunotherapy)</li> <li>● Peer support</li> <li>● Supportive care</li> <li>● Nutrition</li> <li>● Physical activity</li> <li>● Work &amp; cancer</li> <li>● CAPSULE goals</li> <li>● Other useful links</li> </ul>
Preconditions	Patient logged into the app
Post Conditions	The patient receives rewards as they progresses in learning

Course of action	There will be educational content in the application. The patient can access any information they are interested in. Each content is structured into a static and a dynamic part. The patient selects whether to access the static part (textual material in the educational part of the Patient App) or the dynamic part (quizzes) of the contents.
Alternate course A	In the static part, there are contents with which the patient does not interact, but only learns some notions that can help him to have more awareness on his/her condition.
Alternate course B	In the dynamic part, the patient can apply his knowledge, either previous or that he has learned from the static educational contents, to answer quizzes and discover fake news.
Alternate course C	
Component dependency	Virtual Coach, Patient app, Data Platform
Planned delivery	M30
Responsible partners	UOH, BITSSENS, PUT, UNIPV
Links to the mock-up	<p>Education tab with all the educational materials:  <a href="https://projects.invisionapp.com/share/Q6X4P6ATJD3#/screens/453185739">https://projects.invisionapp.com/share/Q6X4P6ATJD3#/screens/453185739</a></p> <p>Education tab, example of a Sleep Information section with one article marked as read with an icon:</p> <ol style="list-style-type: none"> <li><a href="https://projects.invisionapp.com/share/Q6X4P6ATJD3#/screens/417335518">https://projects.invisionapp.com/share/Q6X4P6ATJD3#/screens/417335518</a></li> <li><a href="https://projects.invisionapp.com/share/Q6X4P6ATJD3#/screens/417335519">https://projects.invisionapp.com/share/Q6X4P6ATJD3#/screens/417335519</a></li> </ol> <p>Education tab, example of an article with useful links:  <a href="https://projects.invisionapp.com/share/Q6X4P6ATJD3#/screens/454018431">https://projects.invisionapp.com/share/Q6X4P6ATJD3#/screens/454018431</a></p>

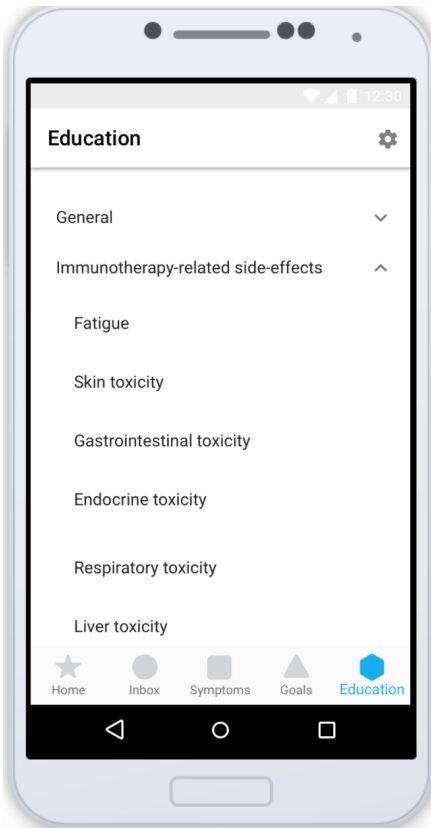


Figure 4.7.43 Education tab with all the educational content - information, facts, quizzes.

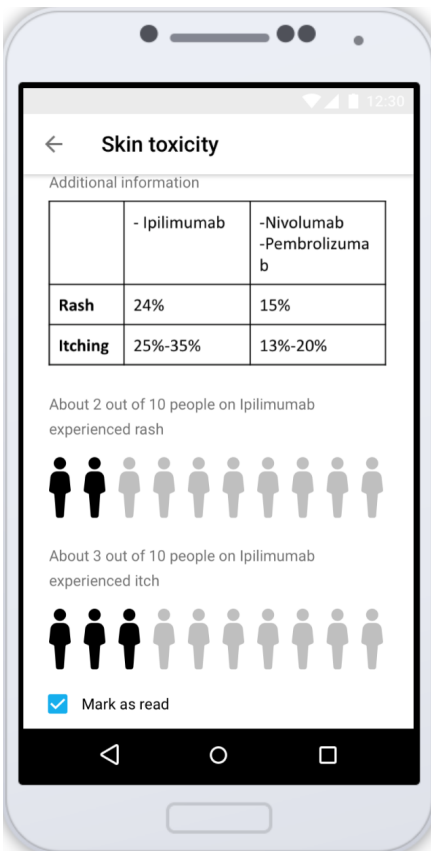


Figure 4.7.39 Education tab with the educational content about skin toxicity – check box to mark articles that are read already.

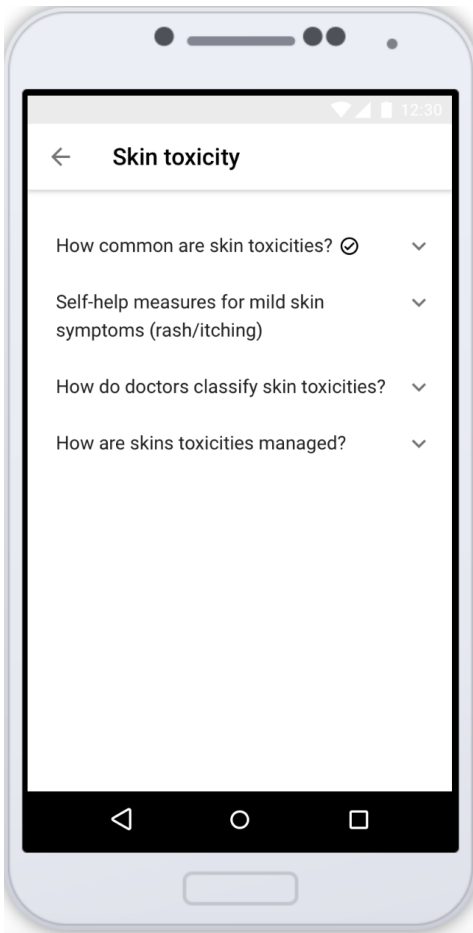


Figure 4.7.44 Education tab with all the educational content about skin toxicity – icon shows that the article is read.

Req. 4.3	Specific capsules exercise														
Description	The patient selects one of the capsules inherent to the goal he has chosen, he activates it and can start performing the specific exercise														
Preconditions	Patient logged into the app, selected the Capsules functionality, and enters one of the goals														
Post Conditions	The patient receives rewards for participating in capsule activities														
Course of action	For each goal there are several capsules. Some capsules can serve multiple goals. Capsule inventory:														
	<table border="1"> <thead> <tr> <th>Capsule</th> <th>Related goals</th> </tr> </thead> <tbody> <tr> <td>Breathing exercise (5 different types of exercise)</td> <td>Sleep Improvement</td> </tr> <tr> <td>Garden bowl</td> <td>Mental Wellbeing (Accepting and expressing the cancer journey)</td> </tr> <tr> <td>Imagery training</td> <td>Sleep Improvement</td> </tr> <tr> <td>Photo voice</td> <td>Mental Wellbeing (Accepting and expressing the cancer journey)</td> </tr> <tr> <td>Yoga</td> <td>Physical wellbeing, Sleep Improvement</td> </tr> <tr> <td>Tai Chi</td> <td>Physical wellbeing, Sleep Improvement</td> </tr> </tbody> </table>	Capsule	Related goals	Breathing exercise (5 different types of exercise)	Sleep Improvement	Garden bowl	Mental Wellbeing (Accepting and expressing the cancer journey)	Imagery training	Sleep Improvement	Photo voice	Mental Wellbeing (Accepting and expressing the cancer journey)	Yoga	Physical wellbeing, Sleep Improvement	Tai Chi	Physical wellbeing, Sleep Improvement
	Capsule	Related goals													
	Breathing exercise (5 different types of exercise)	Sleep Improvement													
	Garden bowl	Mental Wellbeing (Accepting and expressing the cancer journey)													
	Imagery training	Sleep Improvement													
	Photo voice	Mental Wellbeing (Accepting and expressing the cancer journey)													
	Yoga	Physical wellbeing, Sleep Improvement													
Tai Chi	Physical wellbeing, Sleep Improvement														

	Vase of gratitude	Mental Wellbeing (Gratitude and positivity)
	Physical Activity Promotion	Physical wellbeing
	My Usual Walk	Physical wellbeing
Component dependency	Patient App, Virtual Coach, Data Platform	
Planned delivery	M30	
Responsible partners	UOH, BITSSENS, PUT, UNIPV	
Links to the mock-up	<p>Goals tab - <a href="https://projects.invisionapp.com/share/Q6X4P6ATJD3#/screens/416146985">https://projects.invisionapp.com/share/Q6X4P6ATJD3#/screens/416146985</a></p> <p>Tai Chi - <a href="https://projects.invisionapp.com/share/Q6X4P6ATJD3#/screens/454012861">https://projects.invisionapp.com/share/Q6X4P6ATJD3#/screens/454012861</a></p> <p>Yoga - <a href="https://projects.invisionapp.com/share/Q6X4P6ATJD3#/screens/460386803">https://projects.invisionapp.com/share/Q6X4P6ATJD3#/screens/460386803</a></p> <p>My usual walk - <a href="https://projects.invisionapp.com/share/Q6X4P6ATJD3#/screens/450976658">https://projects.invisionapp.com/share/Q6X4P6ATJD3#/screens/450976658</a></p> <p>Basic Breathing - <a href="https://projects.invisionapp.com/share/Q6X4P6ATJD3#/screens/452337134">https://projects.invisionapp.com/share/Q6X4P6ATJD3#/screens/452337134</a></p> <p>Breath Focus - <a href="https://projects.invisionapp.com/share/Q6X4P6ATJD3#/screens/452339821">https://projects.invisionapp.com/share/Q6X4P6ATJD3#/screens/452339821</a></p> <p>Equal time for breathing in and out - <a href="https://projects.invisionapp.com/share/Q6X4P6ATJD3#/screens/452341334">https://projects.invisionapp.com/share/Q6X4P6ATJD3#/screens/452341334</a></p> <p>Progressive Muscle Relaxation – <a href="https://projects.invisionapp.com/share/Q6X4P6ATJD3#/screens/452342821">https://projects.invisionapp.com/share/Q6X4P6ATJD3#/screens/452342821</a></p> <p>Modified Lion’s Breath - <a href="https://projects.invisionapp.com/share/Q6X4P6ATJD3#/screens/452343379">https://projects.invisionapp.com/share/Q6X4P6ATJD3#/screens/452343379</a></p> <p>Imagery Training - <a href="https://projects.invisionapp.com/share/Q6X4P6ATJD3#/screens/417335516">https://projects.invisionapp.com/share/Q6X4P6ATJD3#/screens/417335516</a></p> <p>Garden Bowl - <a href="https://projects.invisionapp.com/share/Q6X4P6ATJD3#/screens/438332713">https://projects.invisionapp.com/share/Q6X4P6ATJD3#/screens/438332713</a></p> <p>PhotoVoice - <a href="https://projects.invisionapp.com/share/Q6X4P6ATJD3#/screens/454433387">https://projects.invisionapp.com/share/Q6X4P6ATJD3#/screens/454433387</a></p> <p>Vase of gratitude - <a href="https://projects.invisionapp.com/share/Q6X4P6ATJD3#/screens/454439356">https://projects.invisionapp.com/share/Q6X4P6ATJD3#/screens/454439356</a></p>	

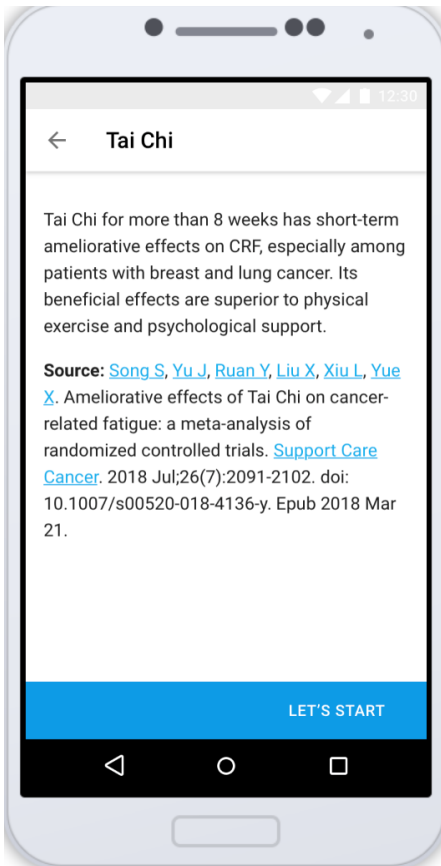


Figure 4.7.45 Tai Chi - Example of the Capsule activities. Introduction to the activity.

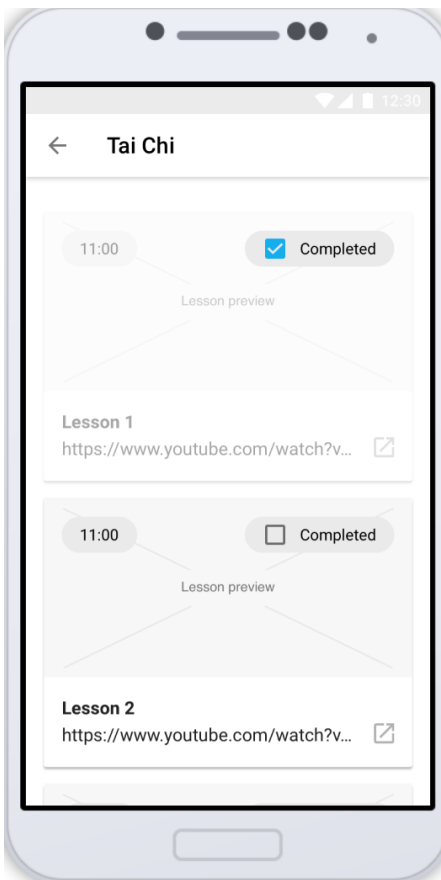


Figure 4.7.46 Tai Chi - Example of the Capsule activities. Provides Link to a video for performing 5 minutes of Tai Chi exercise. There is a selection from 7 recorded lessons

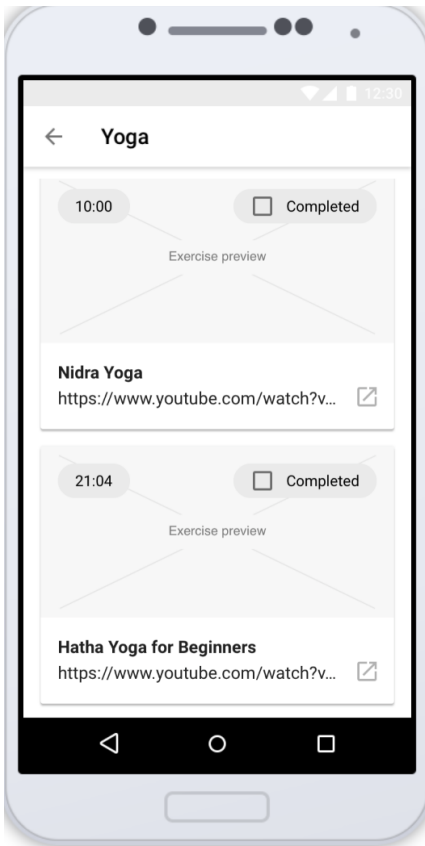


Figure 4.7.47 Yoga - Example of the Capsule activities. Provides Link to a video. There is a selection from 2 recorded lessons of Hatha and Nidra Yoga.

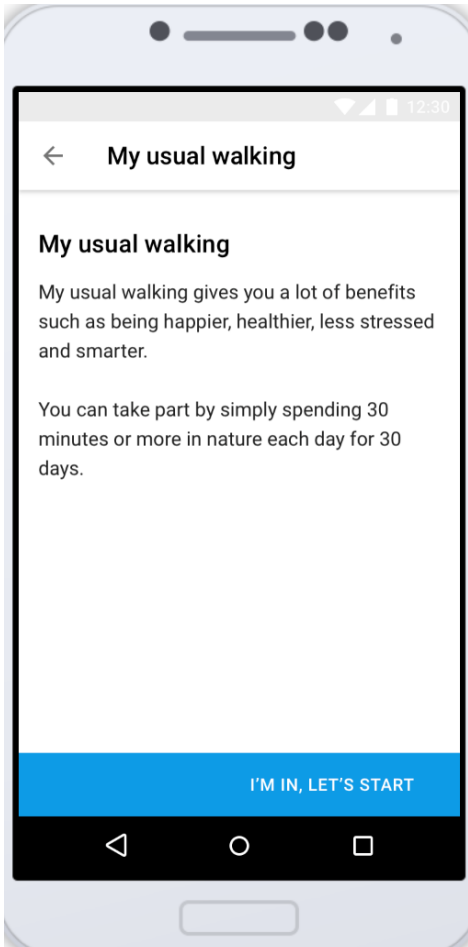


Figure 4.7.48 My usual walking - Example of the Capsule activities. Introduction to the activity.



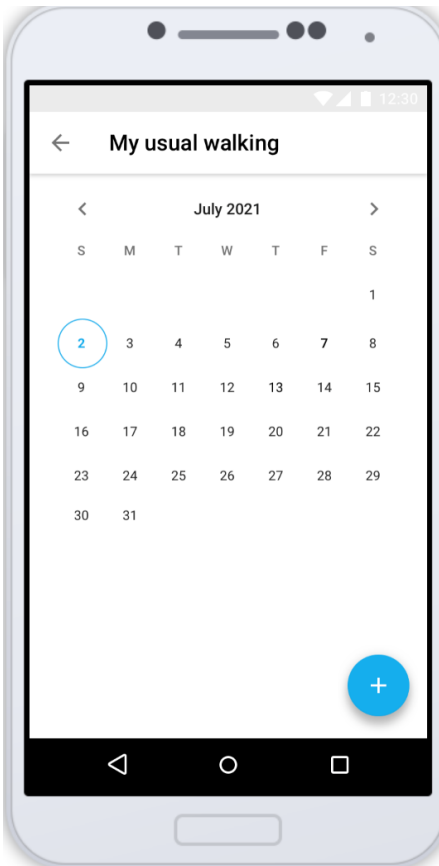


Figure 4.7.49 My usual walking - Calendar view to report the activity on a specific day.

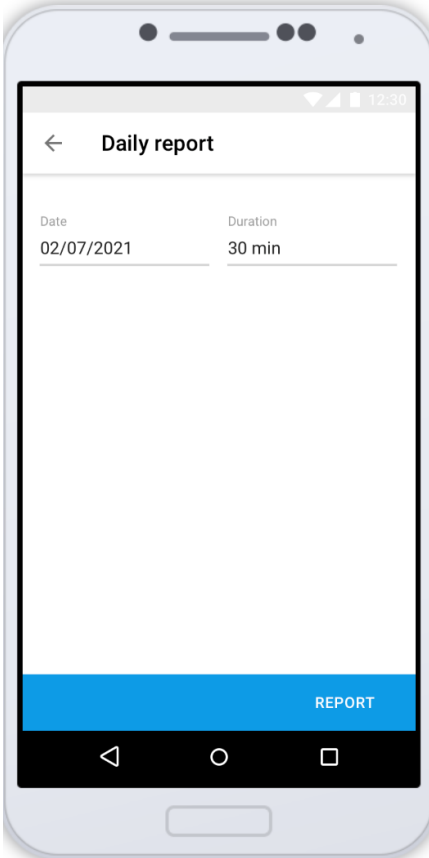


Figure 4.7.50 My usual walking - Calendar view to report the activity on a specific day and indicate walk duration.

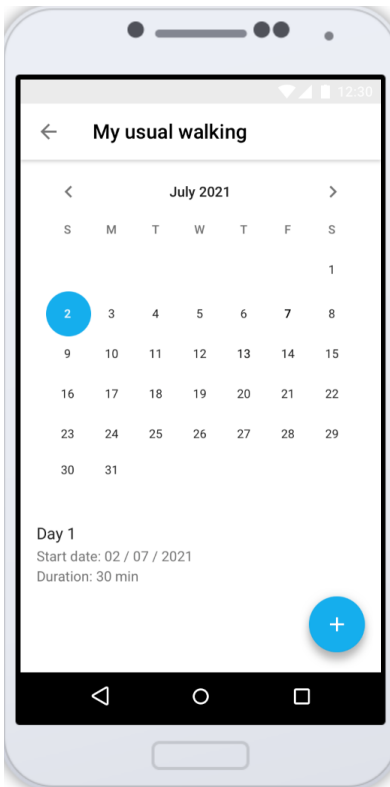


Figure 4.7.51 My usual walking - Calendar view twitch all the reported walking activities.

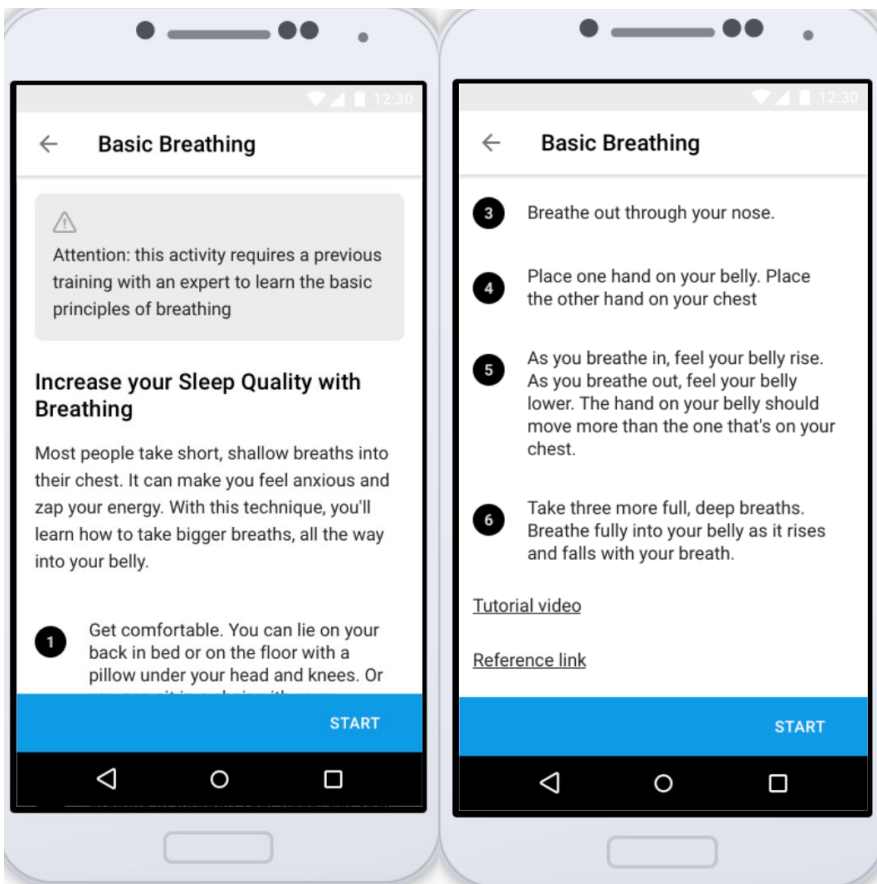


Figure 4.7.52 Basic Breathing - Example of the Capsule activities. Introduction to the activity. All 5 Breathing Exercises have the same structure - disclaimer, activity description, link to a tutorial, references.

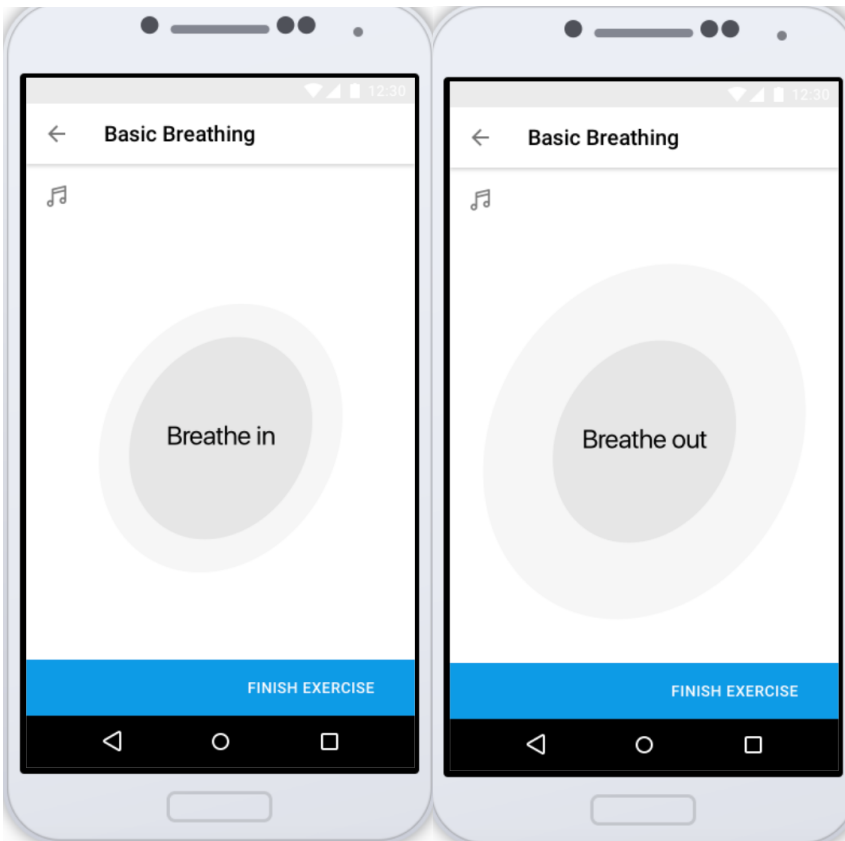


Figure 4.7.53 Basic Breathing - Example of the Capsule activities.

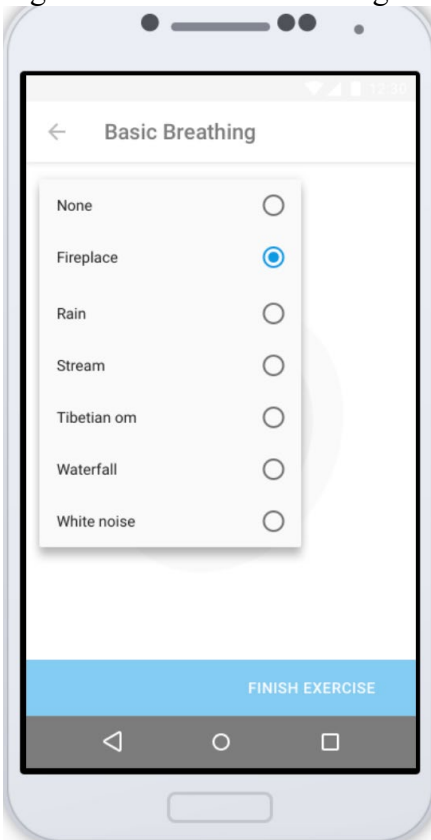


Figure 4.7.54 Basic Breathing - Example of the Capsule activities - Possibility to choose background sounds.

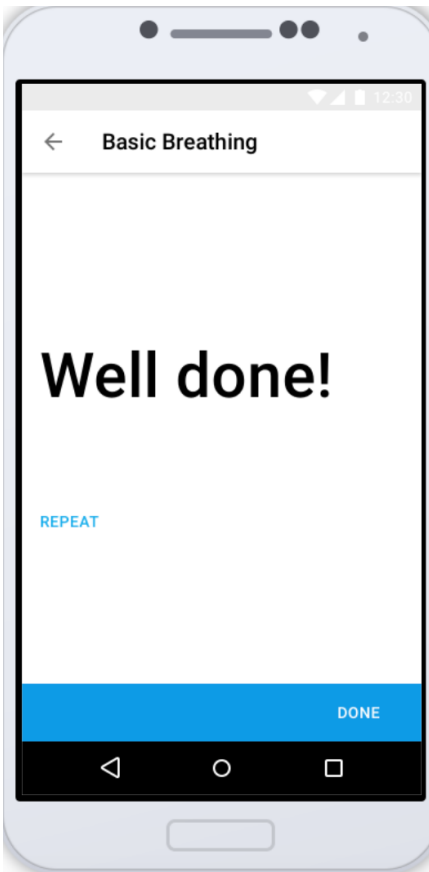


Figure 4.7.55 Basic Breathing - Example of the Capsule activities - Possibility to repeat or close the activity after completing with motivational quote.



Figure 4.7.56 Imagery - Example of the Capsule activities

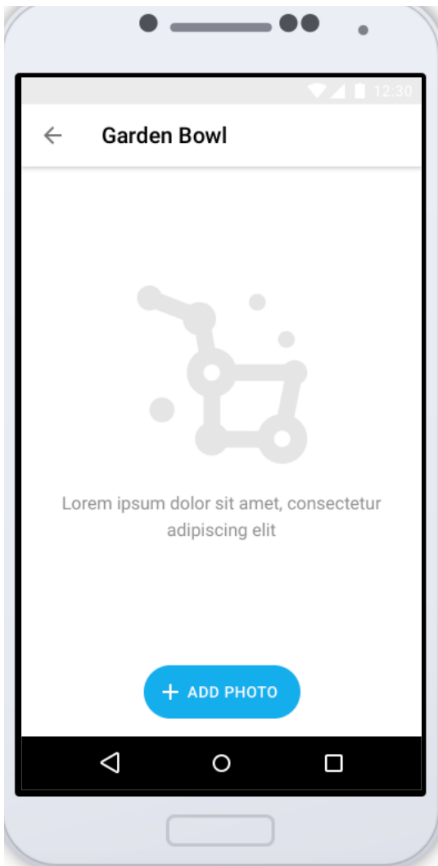


Figure 4.7.57 Garden Bowl - Example of the Capsule activities

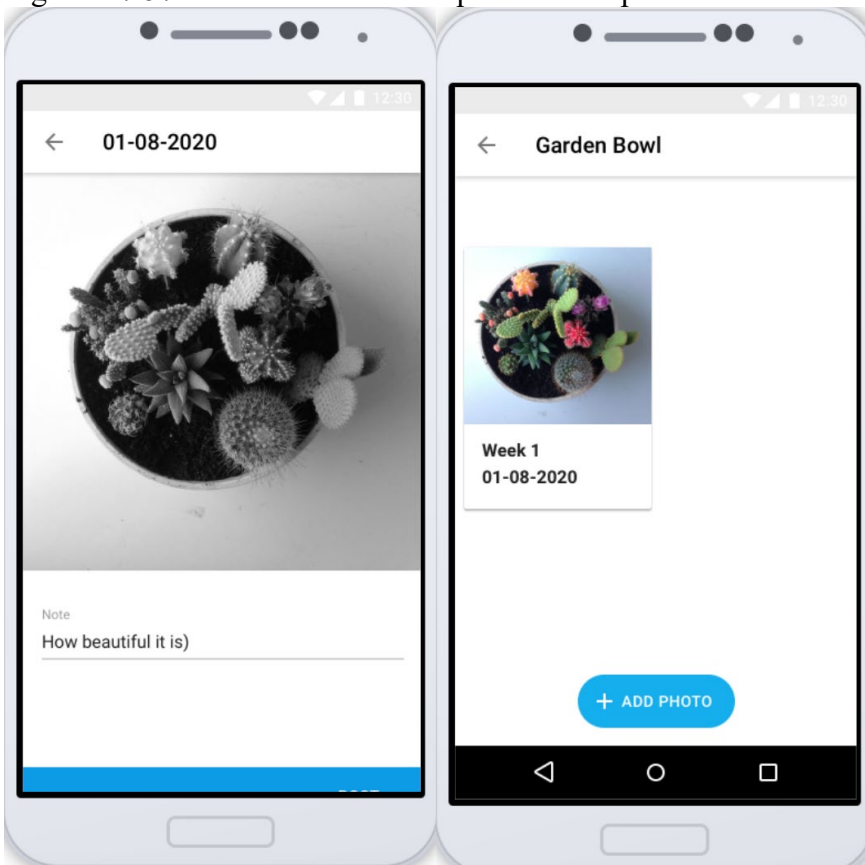


Figure 4.7.58 Garden Bowl - Example of the Capsule activities - possibility to make a photo of a growing plant, leave a note.



Figure 4.7.59 Photo Voice - Example of the Capsule activities

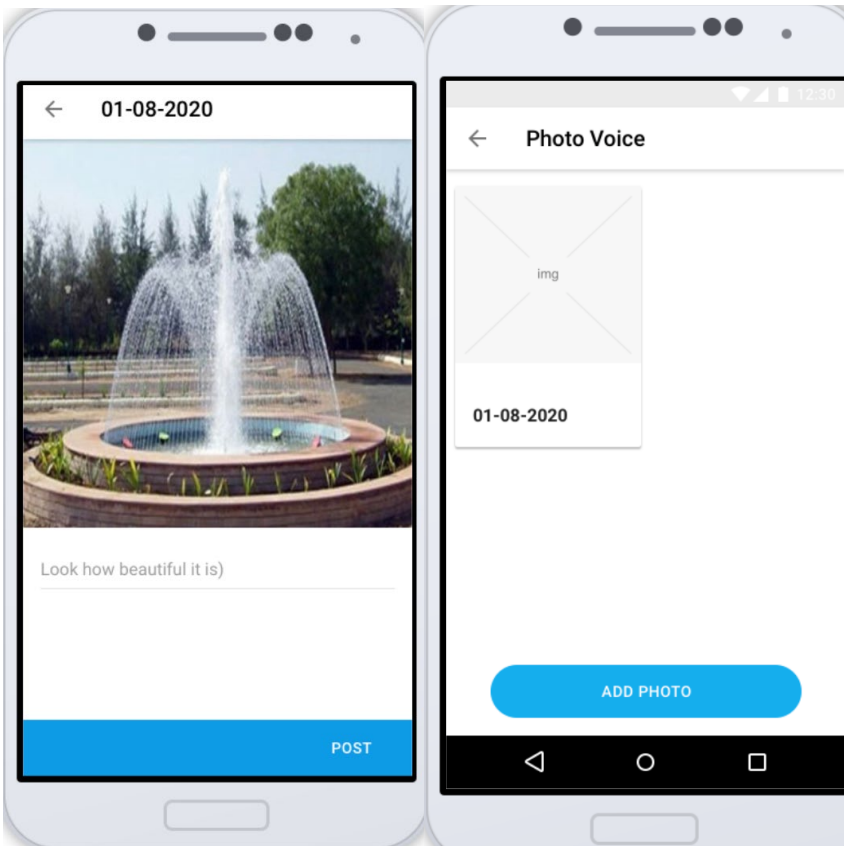


Figure 4.7.60 Photo Voice - Example of the Capsule activities

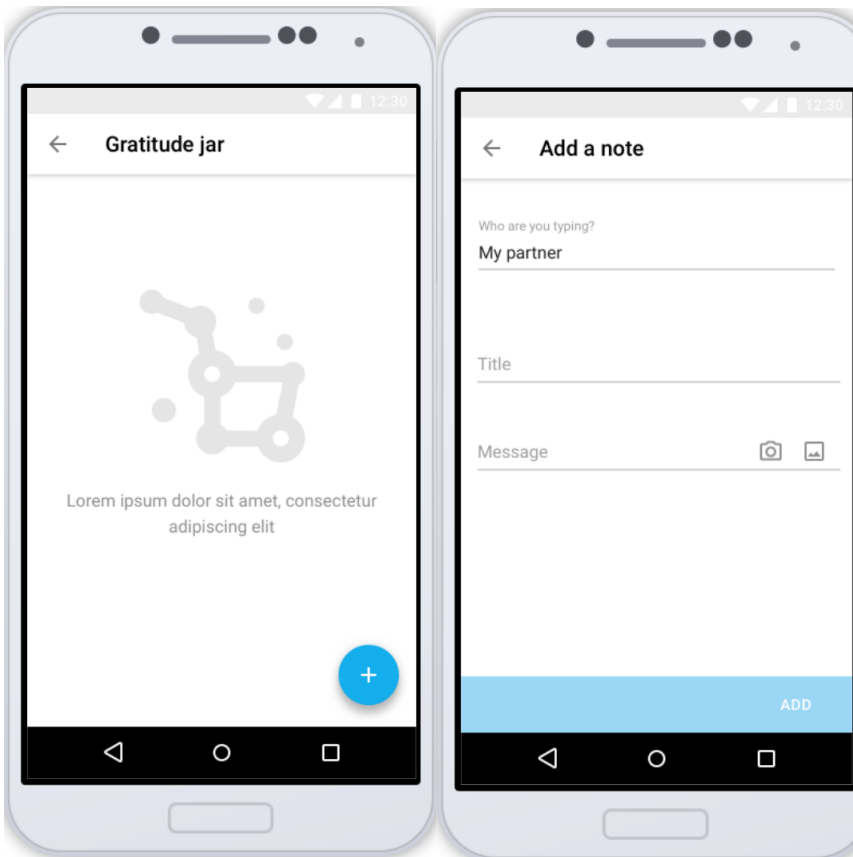


Figure 4.7.61 Gratitude jar - Example of the Capsule activities

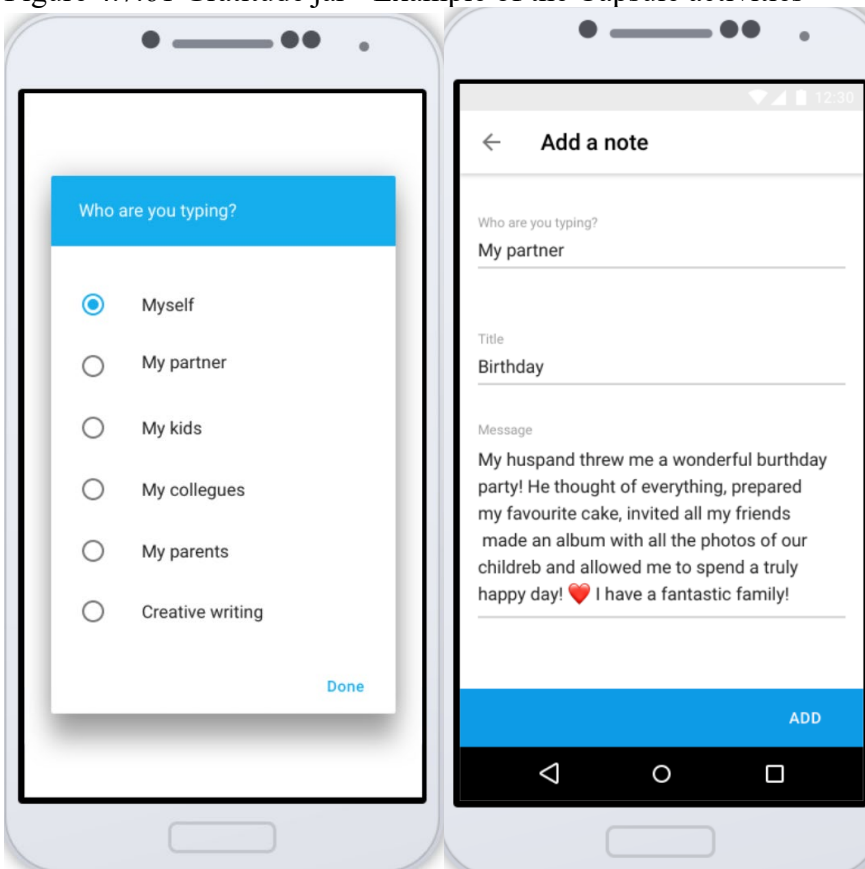


Figure 4.7.62 Gratitude jar - Example of the Capsule activities - possibility to choose who are you typing.

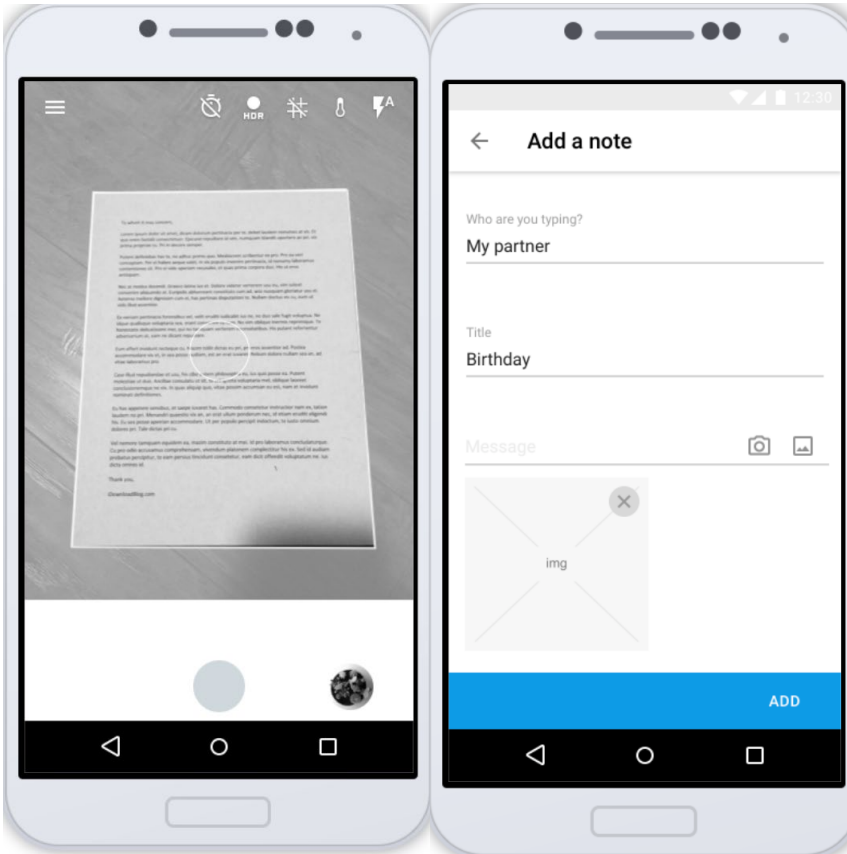


Figure 4.7.63 Gratitude jar - Example of the Capsule activities - possibility to make a photo of a written note if a patient has problems with typing a message.

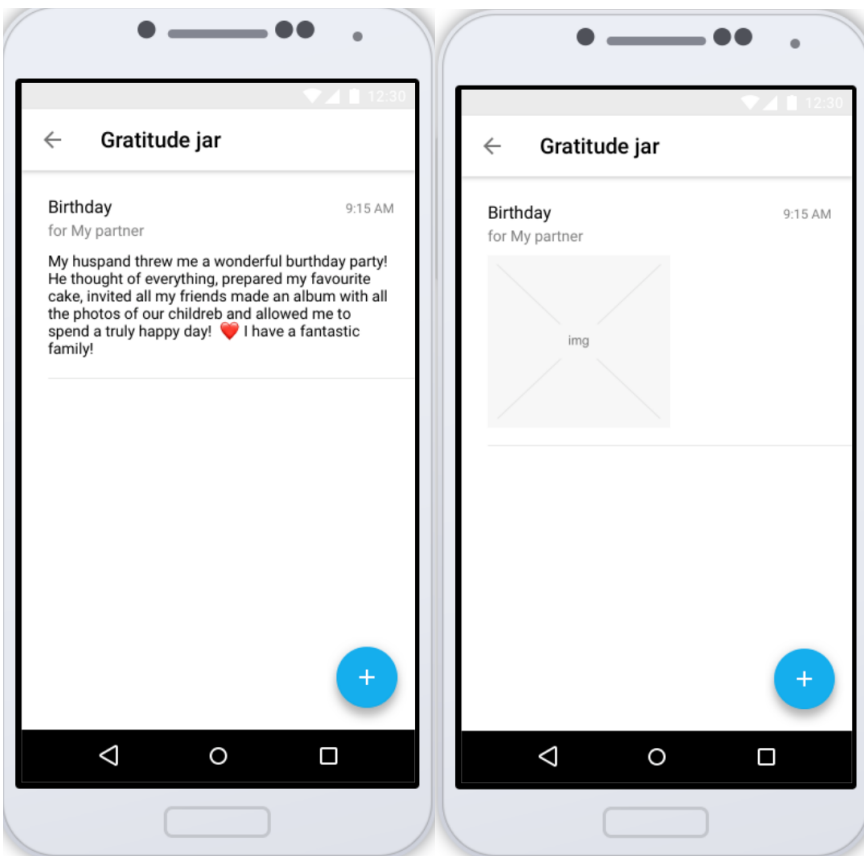


Figure 4.7.64 Gratitude jar - Example of the Capsule activities - these notes will be available only to a Patient.



Req. 4.4	Physical activity promotion
Description	<p>The patient is encouraged to perform physical activity using capsules. This follows recommendations from the World Health Organization: <a href="https://www.who.int/teams/health-promotion/physical-activity/physical-activity-and-older-adults">https://www.who.int/teams/health-promotion/physical-activity/physical-activity-and-older-adults</a></p> <p>Capsules will include ideas for exercises (e.g., walking in nature 30 minutes daily for a month), and videos that demonstrate them. Examples include:            Tai Chi: <a href="https://www.youtube.com/watch?v=cEOS2zoyQw4">https://www.youtube.com/watch?v=cEOS2zoyQw4</a>            Easy Yoga: <a href="https://www.youtube.com/watch?v=uH2N2gmjhl0">https://www.youtube.com/watch?v=uH2N2gmjhl0</a>            Strengthening and stretching exercises, aerobic exercises, balance exercises:  <a href="https://www.youtube.com/watch?v=xtKvHBGx0VM">https://www.youtube.com/watch?v=xtKvHBGx0VM</a> - from Mass General Hospital  <a href="https://www.youtube.com/watch?v=Mz7xTMTUIpU">https://www.youtube.com/watch?v=Mz7xTMTUIpU</a>  <a href="https://www.youtube.com/watch?v=LjDeex6uvLI">https://www.youtube.com/watch?v=LjDeex6uvLI</a> - from MD Anderson Cancer Center  <a href="https://www.youtube.com/watch?v=cc435ONdnFY">https://www.youtube.com/watch?v=cc435ONdnFY</a>  <a href="https://www.youtube.com/watch?v=pNBAIGdelO0">https://www.youtube.com/watch?v=pNBAIGdelO0</a> from Memorial Sloan Kettering</p>
Preconditions	<p>Patient that has an activated goal of physical activity, which specifies the recommended type of activities (e.g., walking, Tai Chi, Yoga, strengthening and stretching exercises, aerobic exercises, balance exercises), intensity and frequency. The patient logged into the app, selected the Capsules functionality, and enters the goal Physical wellbeing.</p>
Post Conditions	<p>Data related to the performed activity stored and made available for the physician app</p>
Course of action	<p>The patient selects the appropriate capsule and performs the proposed exercise.</p>
Component dependency	<p>Patient App, Virtual Coach, Data Platform</p>
Planned delivery	<p>M30</p>
Responsible partners	<p>UOH, BITSSENS, PUT, UNIPV</p>
Links to the mock-up	<p>Physical activity promotion:  <a href="https://projects.invisionapp.com/share/Q6X4P6ATJD3#/screens/454012863">https://projects.invisionapp.com/share/Q6X4P6ATJD3#/screens/454012863</a></p>

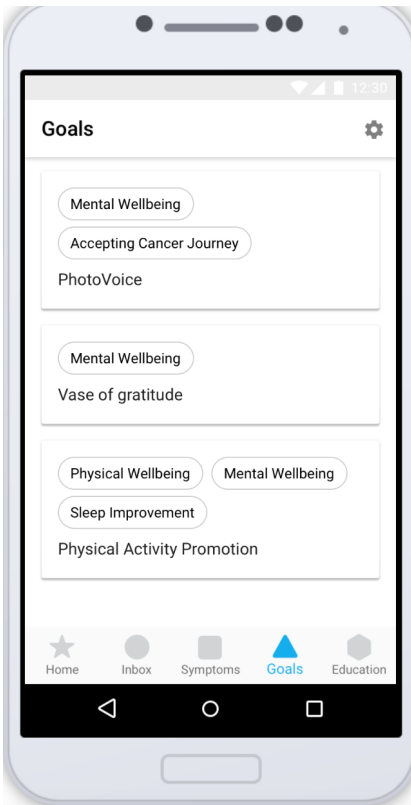


Figure 4.7.65 Goals tab - Physical activity promotion activity (called Capsule)

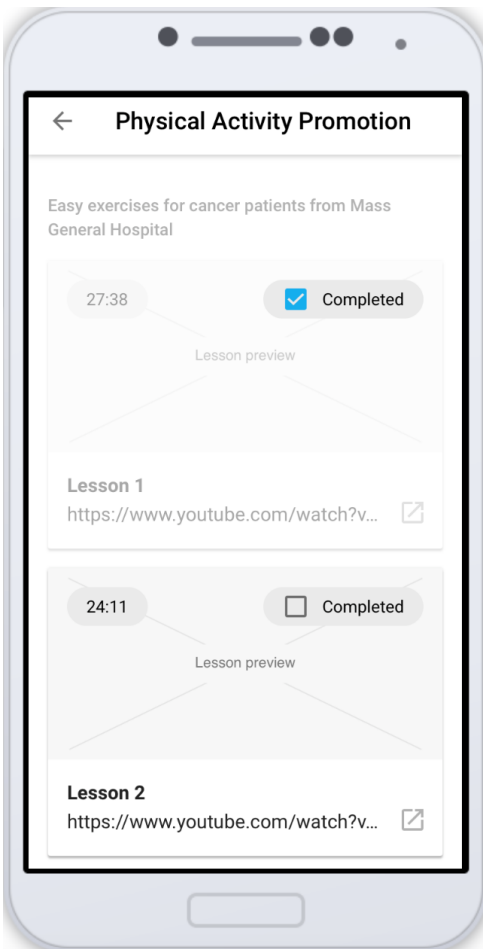


Figure 4.7.66 Goals tab - Structure of a Physical activity promotion activity (called Capsule)

Req. 4.5	Patient providing feedback on whether the performed activity was helpful
Description	A patient may provide feedback on performed non-treatment activities from their daily plan. This feedback captures how the patient likes a given activity.
Preconditions	At least one non-treatment activity has been scheduled for the patient as part of his/her daily plan and the patient performed at least one of such activities. The patient is logged in.
Post Conditions	Feedback on performed activities is stored in the Data Platform.
Course of action	The patient goes to the <i>Home</i> tab and selects the <i>Evaluate your daily activities</i> item in the daily plan. In response, the patient is presented a screen with the list of non-treatment activities from the plan. The patient can evaluate how they like each of the performed activities using a 5-item Likert scale where 1 means “don’t like it at all” and 5 -- “like it a lot”.
Component dependency	Patient App, Virtual Coach, Physician DSS, Data Platform
Planned delivery	M30
Responsible partners	UOH, BITSSENS, PUT, UNIPV
Links to the mock-up	Home tab with a Daily plan of activities that include Evaluate your daily activities section: <a href="https://projects.invisionapp.com/share/Q6X4P6ATJD3#/screens/429762925">https://projects.invisionapp.com/share/Q6X4P6ATJD3#/screens/429762925</a>

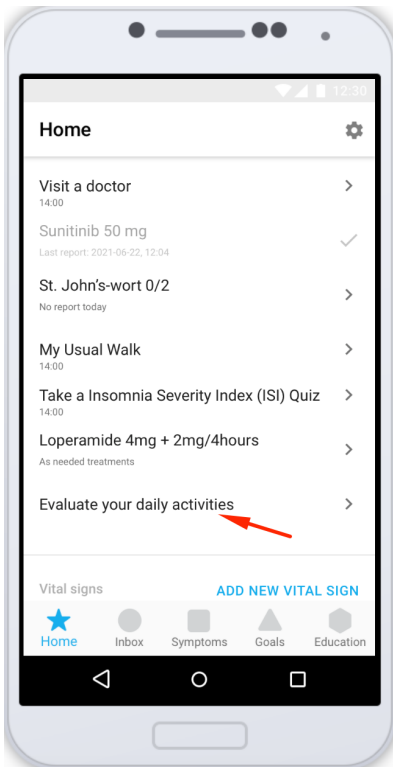


Figure 4.7.67 Home tab - Possibility to evaluate prescribed activities each day through the link in a Daily plan.

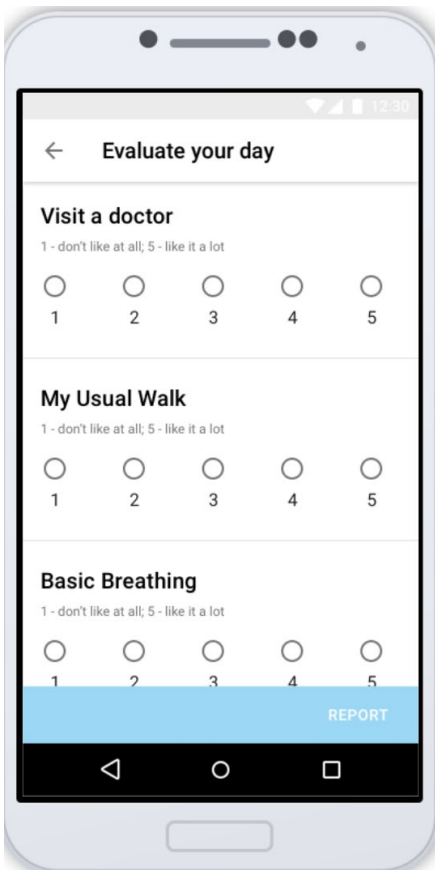


Figure 4.7.68 Home tab - Evaluate your daily activities functionality allows a user to evaluate all prescribed activities that are in his schedule for that specific day.

Req. 5	Preferences and Info
Description	Visualization of the preferences and information that the patient can set and visualize. the detailed description of each preference is defined in the specific requirement table (5.1-5.6)
Preconditions	Patient logged into the app
Post Conditions	The section that allows the patient to set specific preferences and visualize info about the project and the app is shown.
Course of action	According to the use case structure, the patient can enter: Introduction to symptoms reporting (5.1) time preferences (5.2) GDPR preferences (5.3) privacy notes (5.4), information about capable (5.5) introduction to the app (5.6)
Component dependency	Patient App, Data Platform
Planned delivery	M30

Responsible partners	BITSSENS, UNIPV
Links to the mock-up	<p>Home tab with Settings section on the right top corner of the screen:  <a href="https://projects.invisionapp.com/share/Q6X4P6ATJD3#/screens/429762925">https://projects.invisionapp.com/share/Q6X4P6ATJD3#/screens/429762925</a></p> <p>Home tab with Settings, Patient profile with hobbies, contact information, caregiver information and change password functionality:  <a href="https://projects.invisionapp.com/share/Q6X4P6ATJD3#/screens/434357462">https://projects.invisionapp.com/share/Q6X4P6ATJD3#/screens/434357462</a></p> <p>Home tab with Settings, Connected Devices section:  <a href="https://projects.invisionapp.com/share/Q6X4P6ATJD3#/screens/461197487">https://projects.invisionapp.com/share/Q6X4P6ATJD3#/screens/461197487</a></p> <p>Home tab with Settings, Questionnaire results section:  <a href="https://projects.invisionapp.com/share/Q6X4P6ATJD3#/screens/460891401">https://projects.invisionapp.com/share/Q6X4P6ATJD3#/screens/460891401</a></p>

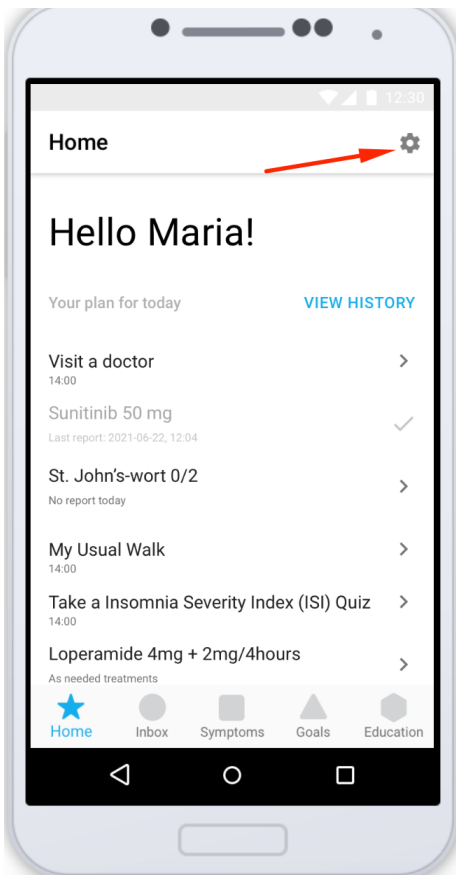


Figure 4.7.69 Home tab - Settings section where all preferences, settings and general information is held.

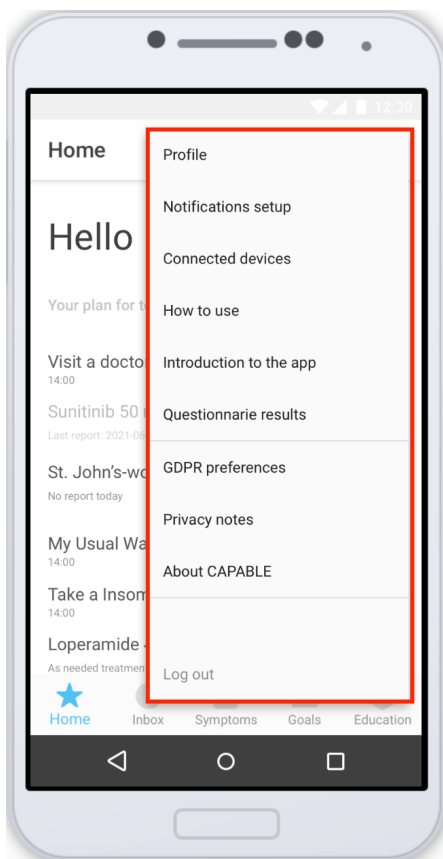


Figure 4.7.70 Home tab - Settings section and its content

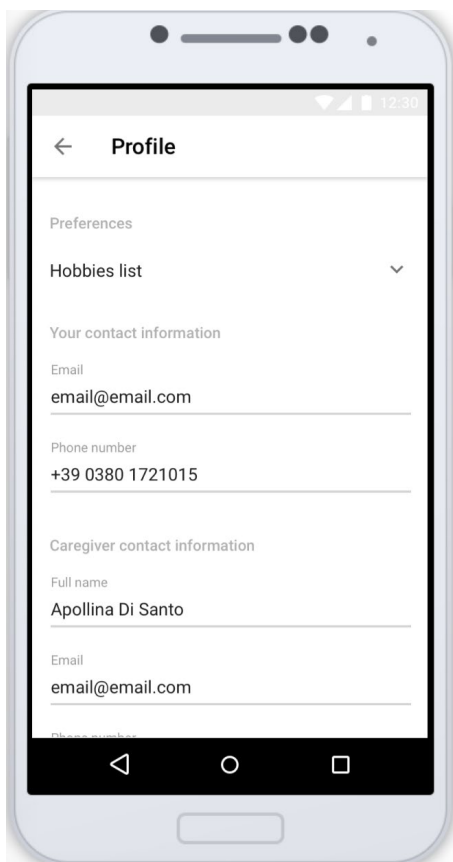


Figure 4.7.71 Home tab - Settings section -Patient profile with possibility to change or update hobbies information, change or update contact information and caregiver information^ change password.

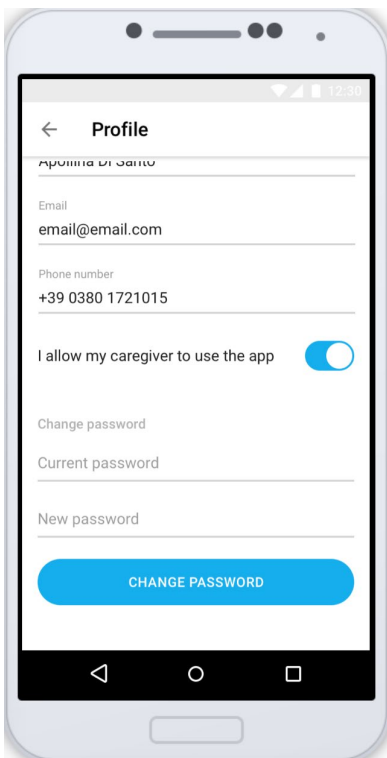


Figure 4.7.72 Home tab - Settings section -Patient profile with possibility to change or update hobbies information, change or update contact information and caregiver information^ change password.

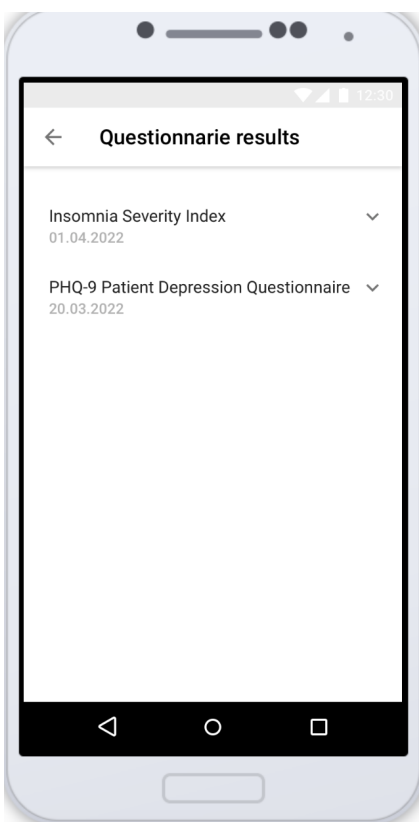


Figure 4.7.73 Home tab - Settings section – Questionnaire results where the patient can view the results of the Questionnaires that he/she already performed. Only in a read mode without changing.

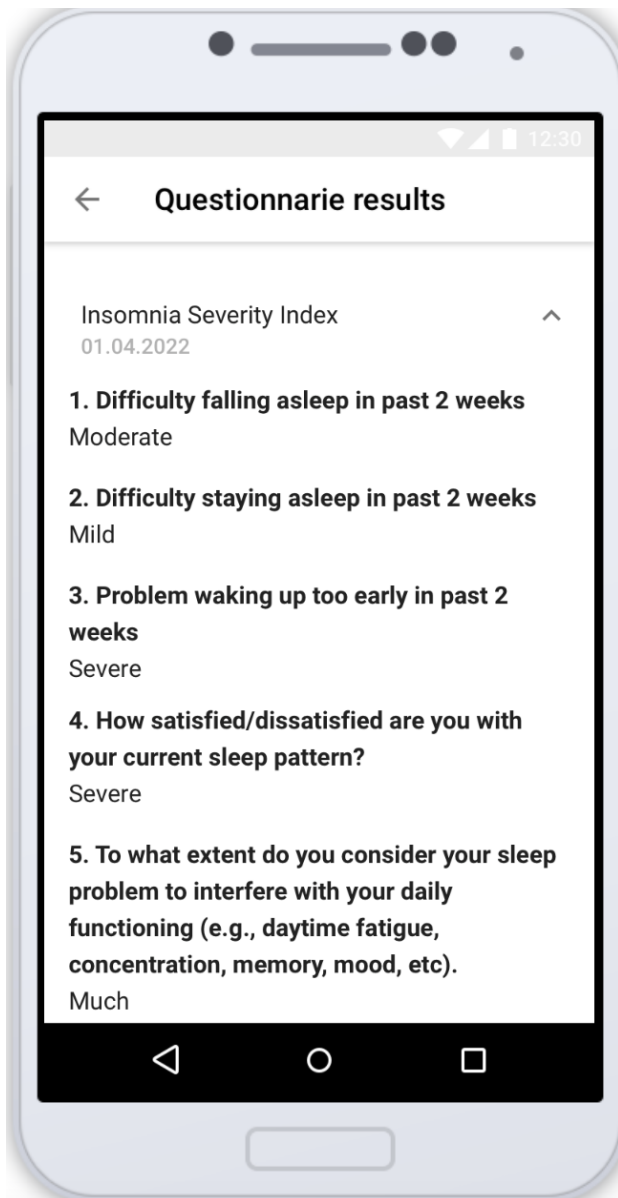


Figure 4.7.74 Home tab - Settings section – Questionnaire results where the patient can view the results of the Questionnaires that he/she already performed. Only in a read mode without changing.



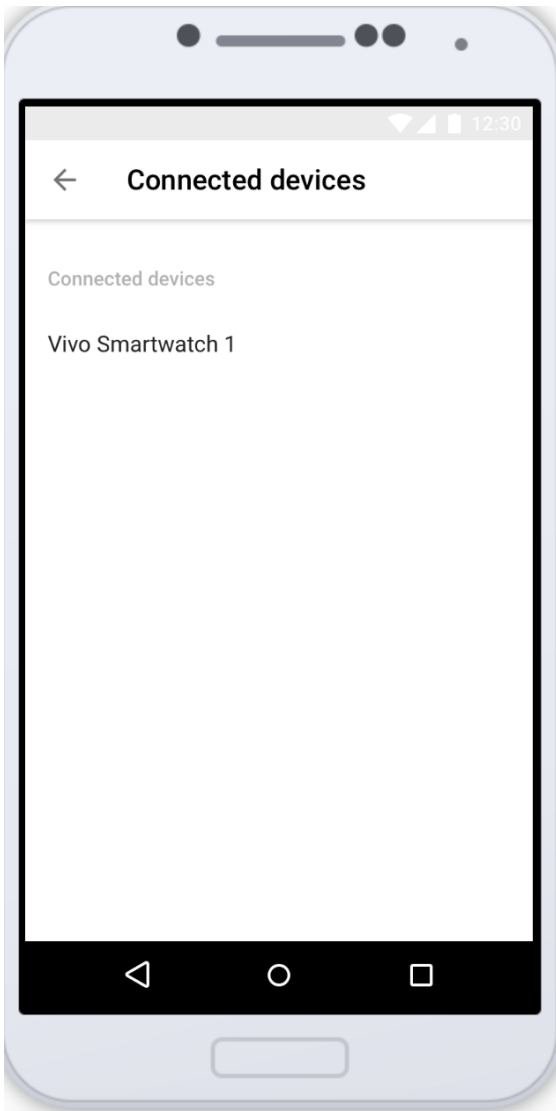


Figure 4.7.75 Home tab - Settings section – Connected devices - textual info specifying connected Sensor. No id or serial number information as this information to be added to a physician’s Dashboard during enrollment of a specific patient.

Req. 5.1	Introduction to symptoms reporting
Description	Visualization of information about symptoms reporting.
Preconditions	Patient logged into the app.
Post Conditions	The section that allows the patient to learn how to report new symptoms is shown.
Course of action	<p>Instructions for entering a new symptom are shown.                      The steps are the following:</p> <ol style="list-style-type: none"> <li>1. click on the add button (+)</li> <li>2. select, if needed, a body part related to the symptom</li> <li>3. select the symptom from a list</li> <li>4. insert the severity level</li> <li>5. modify, if necessary, the start date in the summary (current day is the default value)</li> <li>6. modify, if necessary, the end date in the summary</li> <li>7. Declare if the symptom was reported by caregiver (if needed)</li> </ol>

Component dependency	Patient App, Data Platform
Planned delivery	M30
Responsible partners	BITSENS, UNIPV
Links to the mock-up	Symptom reporting tab: <a href="https://projects.invisionapp.com/share/Q6X4P6ATJD3#/screens/446221715">https://projects.invisionapp.com/share/Q6X4P6ATJD3#/screens/446221715</a>

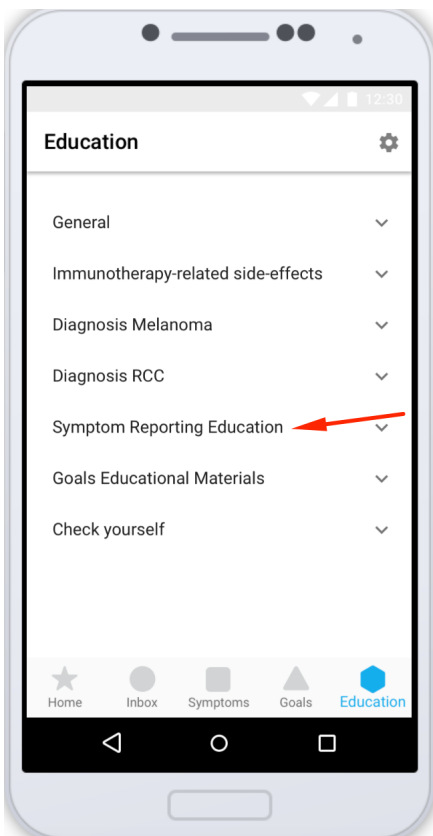


Figure 4.7.76 Home tab - Settings section – Symptom Reporting Education – educational materials explaining how to report a symptom through the app.

Req. 5.2	Time preferences
Description	Setting of time preferences
Preconditions	Patient logged into the app,
Post Conditions	Time preferences set and stored in the data platform
Course of action	The patient can view and enter his/her preferences by specifying the time he/she usually wakes up, the time of breakfast, lunch and dinner and the time he/she goes to bed. This allows the system to better identify the time slots in which to send or not to send recommendations to the patient.
Alternate course A	The patient can select the time-span in which he/she prefers to receive the reminders from the app.

Component dependency	Patient App, Data Platform
Planned delivery	M30
Responsible partners	BITSENS, UNIPV
Links to the mock-up	Home tab with Settings, Notification setup section: <a href="https://projects.invisionapp.com/share/Q6X4P6ATJD3#/screens/460939732">https://projects.invisionapp.com/share/Q6X4P6ATJD3#/screens/460939732</a>

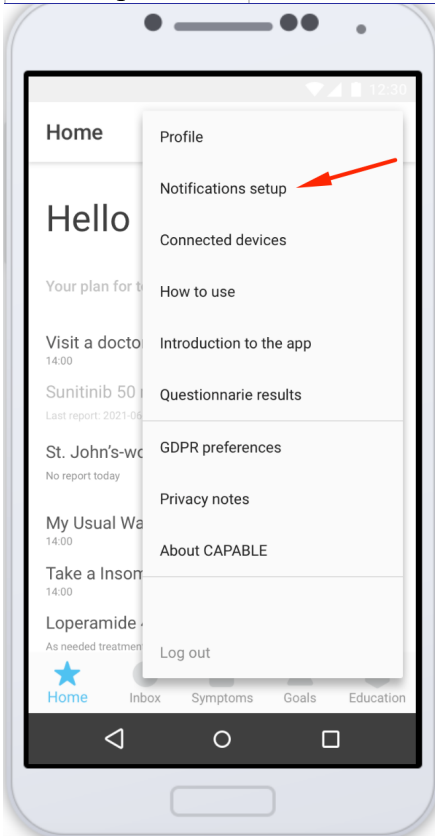


Figure 4.7.77 Home tab - Settings section – Notification setup – section where patients can change/update time preferences when they would like to receive notifications and enable/disable the notifications.

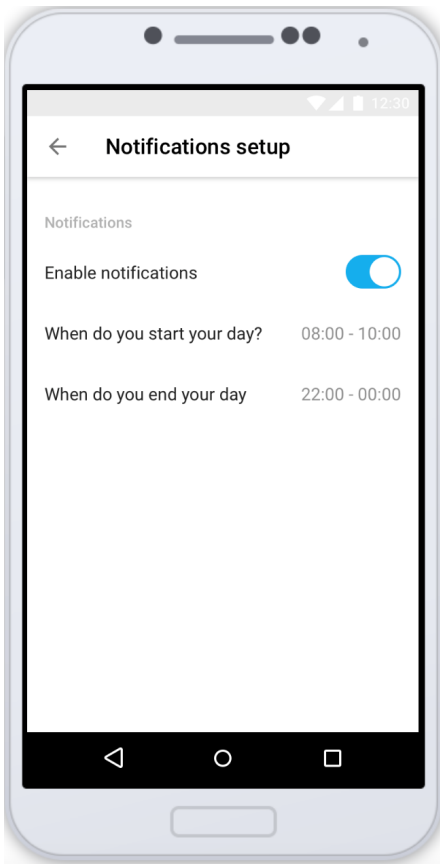


Figure 4.7.78 Home tab - Settings section – Notification setup – section where patients can change/update time preferences when they would like to receive notifications and enable/disable the notifications.

Req. 5.3	GDPR preferences
Description	Setting of GDPR preferences
Preconditions	Patient logged into the app,
Post Conditions	GDPR preferences set and stored in the data platform
Course of action	The patient can view the GDPR preferences
Alternate course A	According to the use case structure, the patient can enter: export of data (5.3.1) and dropout from the study (5.3.2)
Component dependency	Patient App, Data Platform
Planned delivery	M30
Responsible partners	BITSENS, UNIPV
Links to the mock-up	Home tab with Settings, GDPR section: <a href="https://projects.invisionapp.com/share/Q6X4P6ATJD3#/screens/438332705">https://projects.invisionapp.com/share/Q6X4P6ATJD3#/screens/438332705</a>

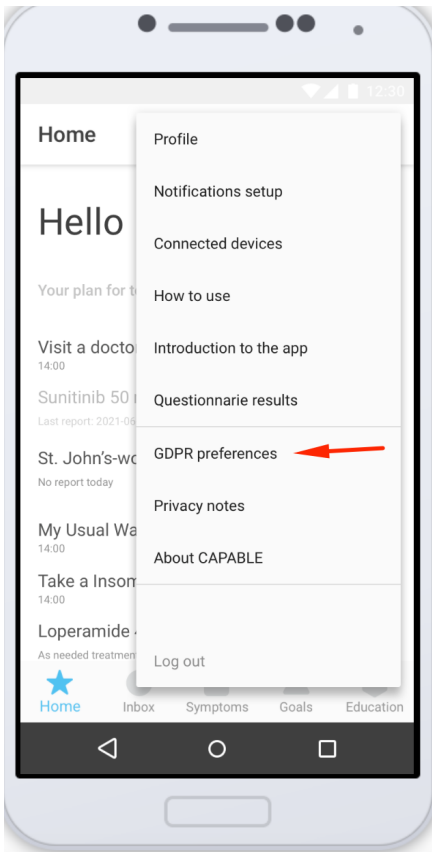


Figure 4.7.79 Home tab - GDPR preferences section



Figure 4.7.80 Home tab - GDPR preferences section where GDPR information will be placed as soon as it is ready. Here, also the instructions and contact points that the patient will have to use to request to drop out from the study will be included.

Req. 5.3.1	Export of data
Description	Functionality for exporting CAPABLE patient data.
Preconditions	Patient logged into the app.
Post Conditions	Exported data available for patients.
Course of action	<p>The patient can export his/her CAPABLE data related to current clinical goals, symptoms, questionnaires data, CAPSULES and sensors - in order to share them with other stakeholders e.g., GP.</p> <ul style="list-style-type: none"> <li>• Data on entered symptoms (exactly as the patient entered this into the system, e.g. patient-friendly terms, no CTCAE grading) can be added to the PDF. Furthermore, actions on recommendations provided by the system to the patient can be logged in the PDF as well. This can be set for a certain time-frame.</li> <li>• Filled in questionnaires can be added to the PDF, shown by the question and the answer the patient gave to this. No scores or clinical interpretation should be added to this, as this might distress a patient. Sorting can be done on questionnaire name and/or filling-in date.</li> <li>• CAPSULES compliance by patients can be reported in the PDF export as per how many times a CAPSULE was used.</li> <li>• Sensor data: a visualization over time of data coming from sensors (e.g. step counter) and vital signs can be shown in the PDF for a certain set time-frame.</li> </ul>
Component dependency	Patient App, Data Platform
Planned delivery	M30
Responsible partners	BITSENS, UNIPV
Links to the mock-up	No link is applicable, PDF file depends on the sections of information that will be chosen for export.

Req. 5.3.2	Dropout from the study
Description	The patient is instructed on how to drop out from the study
Preconditions	Patient logged into the app
Post Conditions	
Course of action	The patient, according to GDPR regulation, can request to dropout from the CAPABLE study. Instructions are provided as a text in this page of the app. Figure 4.7.79 - 4.7.80
Component dependency	Patient App
Planned delivery	M30
Responsible partners	BITSENS, UNIPV

Links to the mock-up	Home tab with Settings, GDPR section: <a href="https://projects.invisionapp.com/share/Q6X4P6ATJD3#/screens/438332705">https://projects.invisionapp.com/share/Q6X4P6ATJD3#/screens/438332705</a>
Req. 5.4	Privacy notes
Description	Visualization of the privacy notes
Preconditions	Patient logged into the app.
Post Conditions	Privacy notes are shown to the patient
Course of action	<p>Patient can access the privacy notes that will contain information about:</p> <ul style="list-style-type: none"> <li>• The types of personal data processed by the app</li> <li>• Lawful basis for processing personal data.</li> <li>• Data subject rights</li> </ul>
Component dependency	Patient App
Planned delivery	M30
Responsible partners	BITSENS, UNIPV
Links to the mock-up	Home tab with Settings, Privacy notes section: <a href="https://projects.invisionapp.com/share/Q6X4P6ATJD3#/screens/438332706">https://projects.invisionapp.com/share/Q6X4P6ATJD3#/screens/438332706</a>

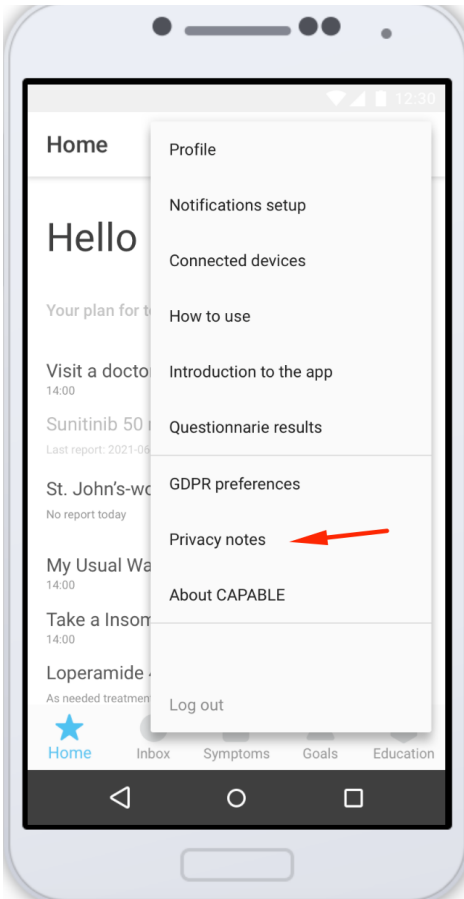


Figure 4.7.81 Home tab - Privacy notes section

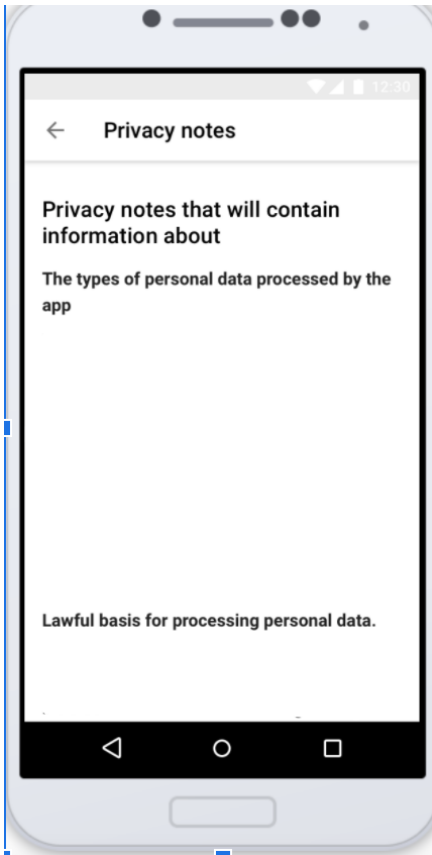


Figure 4.7.82 Home tab - Privacy notes section where Privacy information will be placed as soon it is ready. Here we will include the privacy information that we are developing in WP7 (it will be ready when we finish preparing the DPIA)

Req. 5.5	About CAPABLE
Description	Visualization of information about the CAPABLE project
Preconditions	Patient logged into the app,
Post Conditions	The section that allows the patient to see information about the CAPABLE project is shown
Course of action	The patient can see information about the CAPABLE project and in particular the project partners, the project aims and solutions and the link to the CAPABLE site.
Component dependency	Patient App, Data Platform
Planned delivery	M30
Responsible partners	BITSENS, UNIPV
Links to the mock-up	Home tab with Settings, About CAPABLE section: <a href="https://projects.invisionapp.com/share/Q6X4P6ATJD3#/screens/438332707">https://projects.invisionapp.com/share/Q6X4P6ATJD3#/screens/438332707</a> About the project information given during Patient Onboarding process: <a href="https://projects.invisionapp.com/share/Q6X4P6ATJD3#/screens/450983255">https://projects.invisionapp.com/share/Q6X4P6ATJD3#/screens/450983255</a>



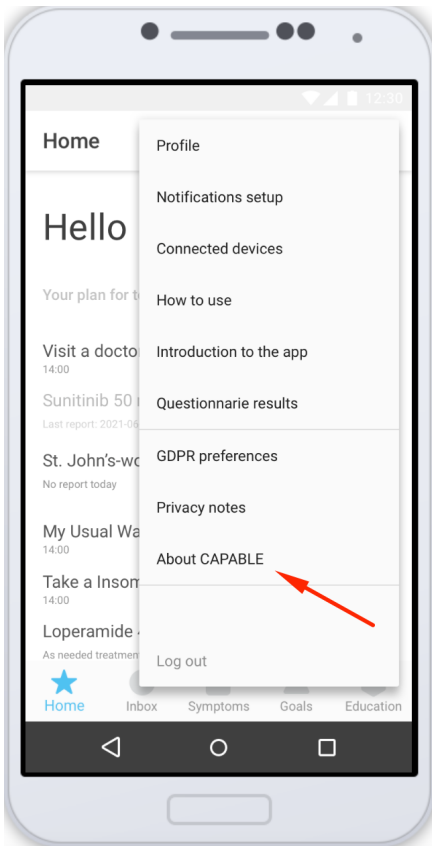


Figure 4.7.83 Home tab - About CAPABLE section

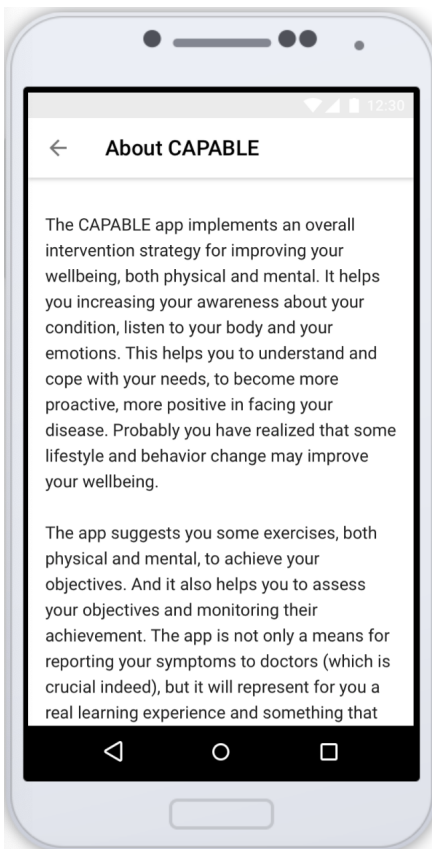


Figure 4.7.84 Home tab - About CAPABLE section

Req. 5.6	Introduction to the app
Description	Visualization of information about the app
Preconditions	Patient logged into the app,
Post Conditions	The section that allows the patient to see information about the app is shown
Course of action	The patient can view a section that shows the version of the app and describes the different features installed and the navigation mode.
Alternate course C	
Component dependency	Patient App, Data Platform
Planned delivery	M30
Responsible partners	BITSENS, UNIPV
Links to the mock-up	Home tab with Settings, Introduction to the app section: <a href="https://projects.invisionapp.com/share/Q6X4P6ATJD3#/screens/429762925">https://projects.invisionapp.com/share/Q6X4P6ATJD3#/screens/429762925</a> Introduction to the app information given during Patient Onboarding process: <a href="https://projects.invisionapp.com/share/Q6X4P6ATJD3#/screens/450983249">https://projects.invisionapp.com/share/Q6X4P6ATJD3#/screens/450983249</a>

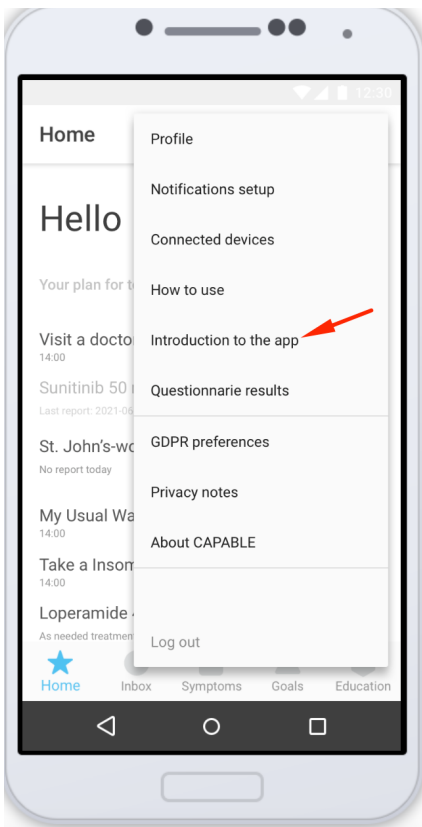


Figure 4.7.85 Home tab - Introduction to the app

Req. 5.7	App onboarding
Description	Onboarding is the process of helping new users understand and experience how the app is going to help them achieve their goal,
Preconditions	Patient logged into the app,
Post Conditions	The section allows the patient to get first answers about the CAPABLE project, and collect major preferences of the user.
Course of action	Log into the system then the patient is led through several screens with basic information about the project, then preferences are collected. The onboarding process is finished with a motivational quote.
Component dependency	Patient App, Data Platform
Planned delivery	M30
Responsible partners	BITSENS
Links to the mock-up	<p>Log in scree, UI Design:  <a href="https://projects.invisionapp.com/share/QZ120ATVU8AH#/screens">https://projects.invisionapp.com/share/QZ120ATVU8AH#/screens</a>            Onboarding to the app flow:  <a href="https://projects.invisionapp.com/share/Q6X4P6ATJD3#/screens/450983248_intro_-_1">https://projects.invisionapp.com/share/Q6X4P6ATJD3#/screens/450983248_intro_-_1</a>            Forget password functionality flow:</p> <ol style="list-style-type: none"> <li>1. <a href="https://projects.invisionapp.com/share/Q6X4P6ATJD3#/screens/462155913">https://projects.invisionapp.com/share/Q6X4P6ATJD3#/screens/462155913</a></li> <li>2. <a href="https://projects.invisionapp.com/share/Q6X4P6ATJD3#/screens/462155914">https://projects.invisionapp.com/share/Q6X4P6ATJD3#/screens/462155914</a></li> <li>1. <a href="https://projects.invisionapp.com/share/Q6X4P6ATJD3#/screens/462155915">https://projects.invisionapp.com/share/Q6X4P6ATJD3#/screens/462155915</a></li> <li>2. <a href="https://projects.invisionapp.com/share/Q6X4P6ATJD3#/screens/462155916">https://projects.invisionapp.com/share/Q6X4P6ATJD3#/screens/462155916</a></li> <li>3. <a href="https://projects.invisionapp.com/share/Q6X4P6ATJD3#/screens/462155918">https://projects.invisionapp.com/share/Q6X4P6ATJD3#/screens/462155918</a></li> <li>4. <a href="https://projects.invisionapp.com/share/Q6X4P6ATJD3#/screens/462155919">https://projects.invisionapp.com/share/Q6X4P6ATJD3#/screens/462155919</a></li> </ol>

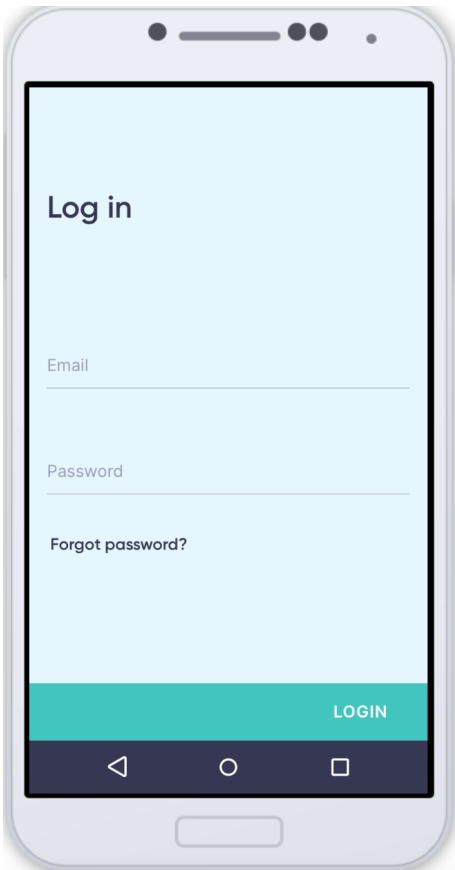


Figure 4.7.86 Onboarding - Log in screen

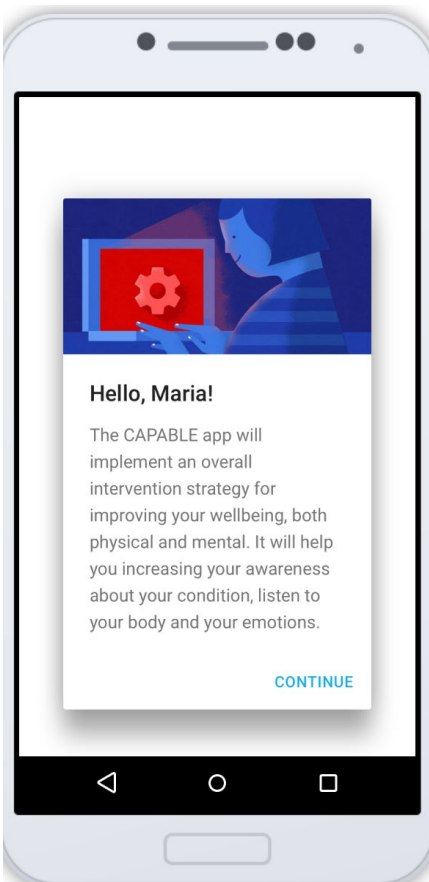


Figure 4.7.87 Onboarding - Introduction of a CAPABLE System to a Patient.

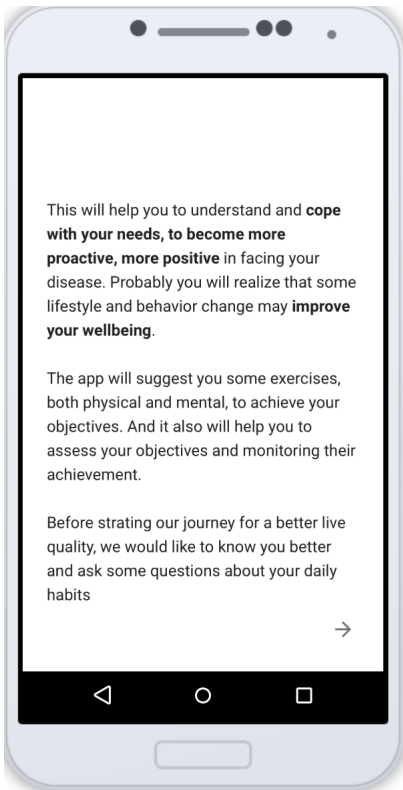


Figure 4.7.88 Onboarding - Introduction of a CAPABLE System to a Patient.

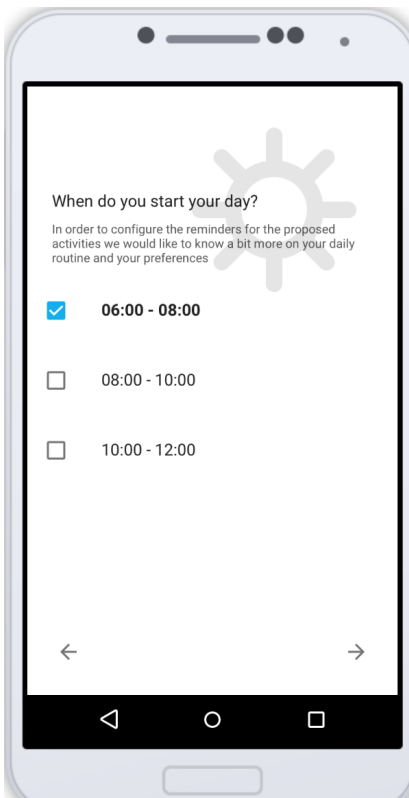


Figure 4.7.89 Onboarding - Patient's preferences and hobbies.

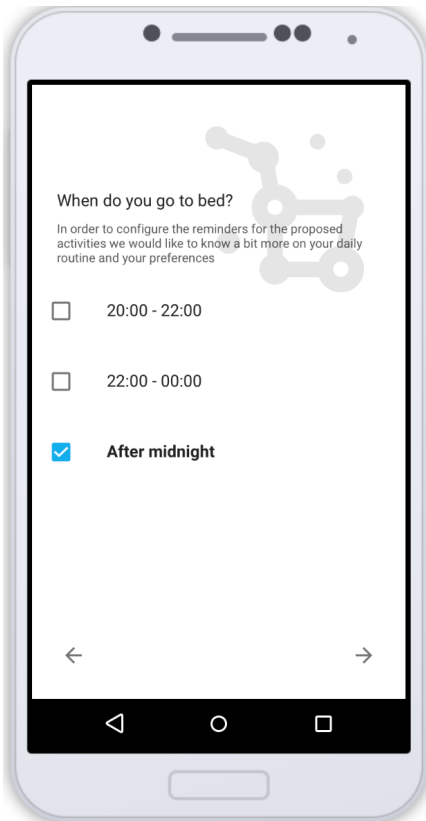


Figure 4.7.90 Onboarding - Patient's preferences and hobbies.

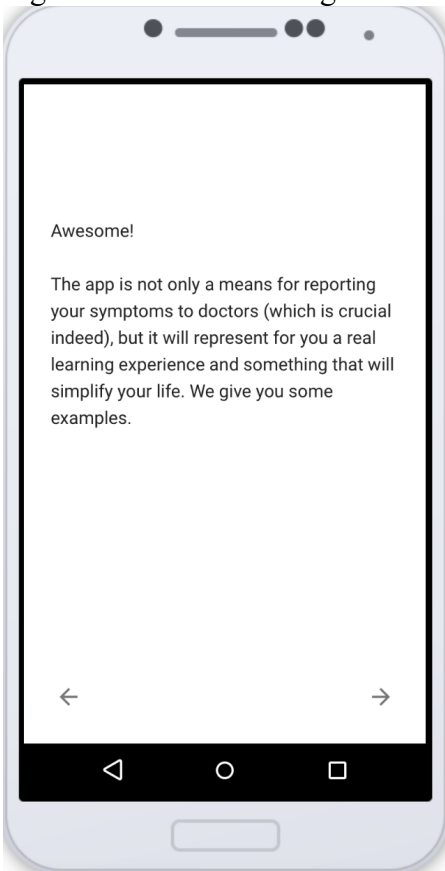


Figure 4.7.91 Onboarding – feature description.

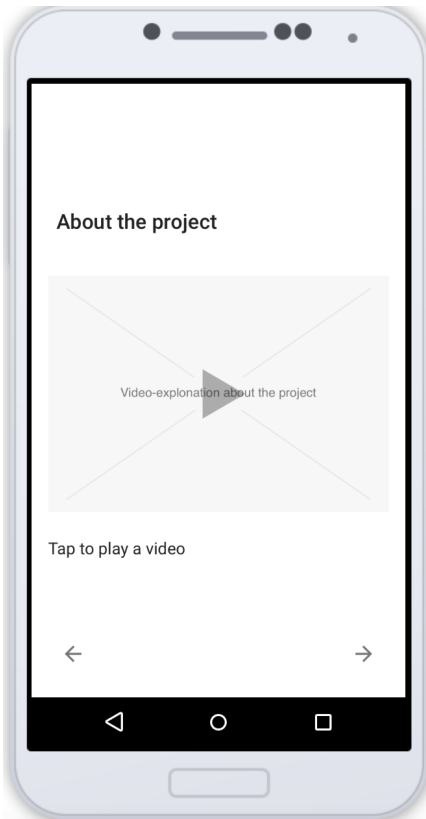


Figure 4.7.92 Onboarding – video presentation of the CAPABLE project

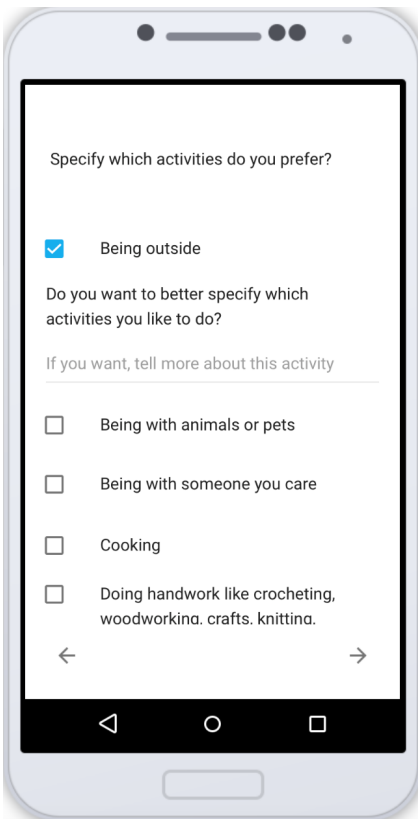


Figure 4.7.93 Onboarding – List of preferences and hobbies that are collected from a user. A user can specify each hobby. Can be updated in future through Settings – Patient profile

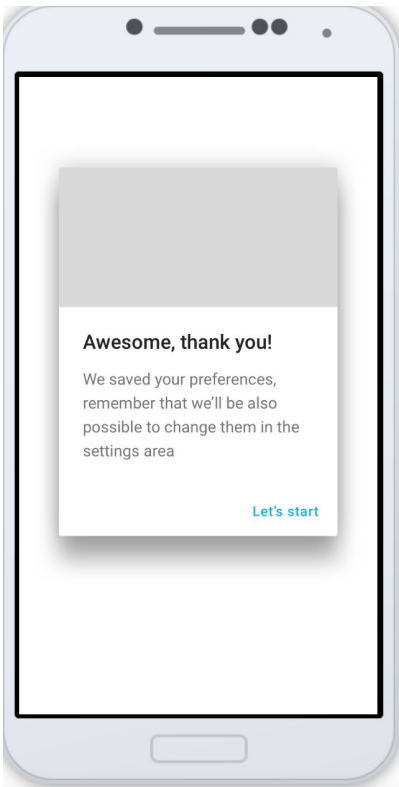


Figure 4.7.94 Onboarding – motivational quote after finishing onboarding process.

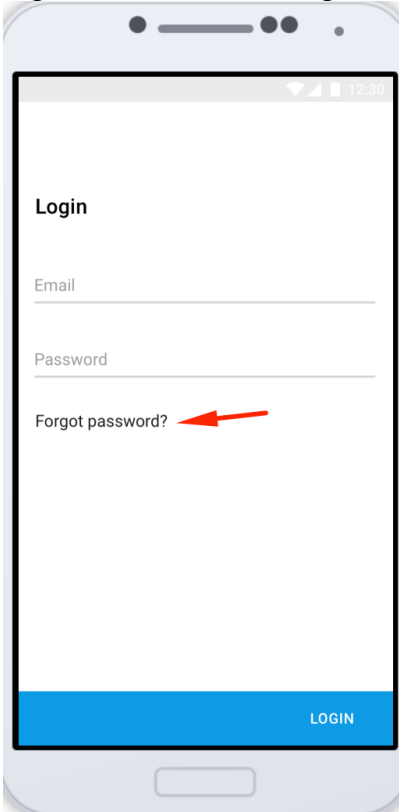


Figure 4.7.95 Forget password functionality flow - Log in screen.



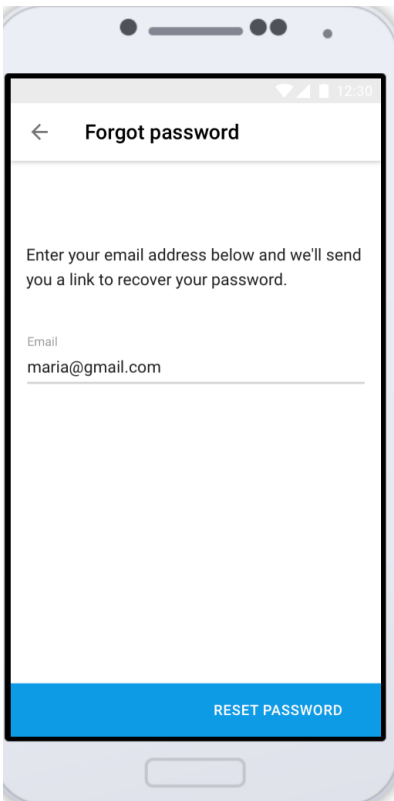


Figure 4.7.96 Forgot password functionality flow - request for the registered email to send a recovery link.

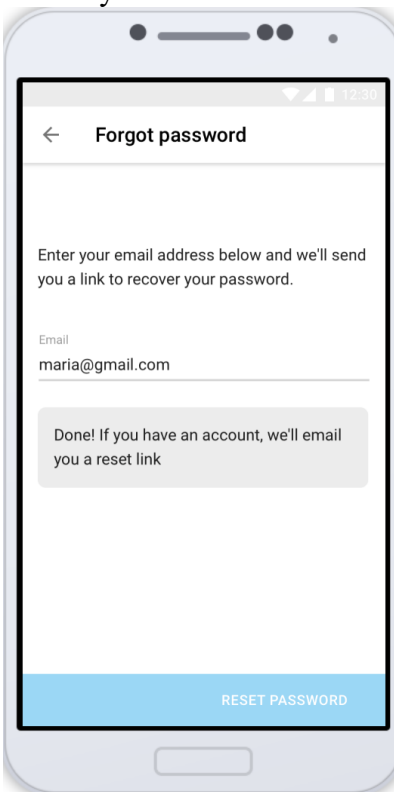


Figure 4.7.97 Forgot password functionality flow - a recovery link has been sent.

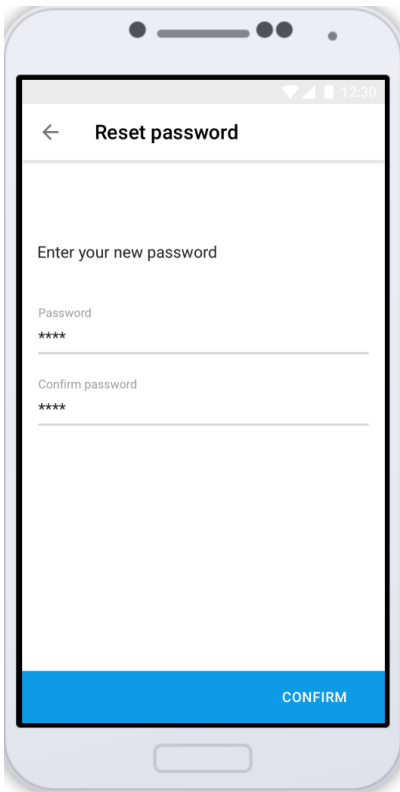


Figure 4.7.98 Forget password functionality flow - update password screen.

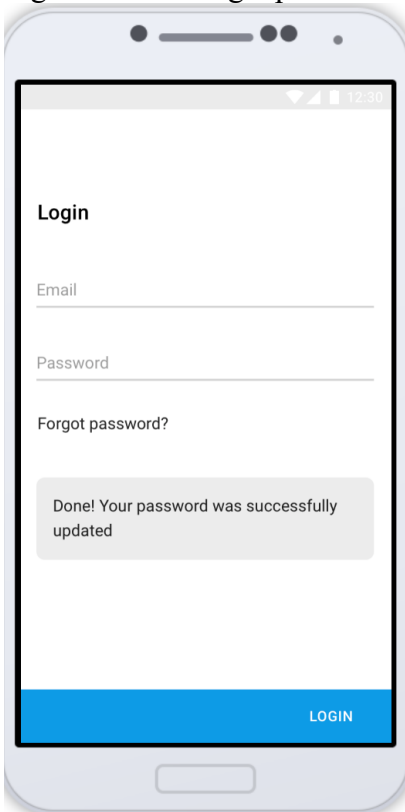


Figure 4.7.99 Forget password functionality flow - confirmation of a successful password change.

## 4.8. Non-functional Requirements

A Non-functional requirement is a requirement that specifies criteria that can be used to judge the operation of a system, rather than specific behaviors. For the Capable App (for patients and for

providers), it is necessary to define these requirements to ensure the quality attributes of the system that affect run-time behavior, system design and user experience. Defining these kinds of requirements is a key task for the development of medical applications to not be considered as a critical system, normally defined as those systems whose failure could negatively impact in health and safety of the public.

Table 4.8 shows the non-functional requirements defined for the CAPABLE Patient App taking into account the technical and clinical aspects of the project and the system.

Table 4.8. Non-functional requirement for the Patient App

Requirement	Description	CAPABLE Patient App
Conceptual Integrity	The system must provide consistency and coherence of the overall design. This includes the way that components or modules are designed, as well as factors such as coding style and variable naming.	Capable will design the app in an iterative way and always supervised by different technical experts to ensure a proper structure and design of the different modules that affect to the application.
Maintainability	The system must have the ability to change in an easy way facing these changes with the minimum impact in the components and functionalities. Also, fixing errors will have to be done with the minimum impact.	Capable will adopt monitoring frameworks (e.g. fabric.io). It will be applied a log system to help the developer team fix any error with the minimum impact on the app.
Reusability	The application must use the components in an efficient way avoiding duplicate components used in different features reducing implementation and run time.	The development will be as efficient as possible avoiding the use of different code or components to achieve the same result in different places, the use of multiple similar methods or using several systems to implement the same feature or function
Availability	The application must be accessible and functional as much time as possible. It can be measured as a percentage of the total system downtime over a predefined period. Availability will be affected by system errors, infrastructure problems, malicious attacks, and system load.	The app will be available in the app store. The availability of the app will depend on the battery lifetime of the device and also, it will depend on the availability of the Capable infrastructure.
Manageability	The administrators must be able to easily manage the application, for this, Capable will use the necessary instrumentation and monitoring systems for debugging and performance tuning.	Capable will adopt monitoring frameworks (e.g. fabric.io). We will apply a log system to help the developer team fix any error with the minimum impact on the app.
Performance	The application must be responsive in order to execute any action within a given time interval. For this, it will be	The application will be developed looking for the best possible services (proper plug-in and libraries) to guarantee good performance in terms

	measured in terms of latency as the time taken by the app to response to events.	of device compatibility, memory consumption, battery consumption, app in background, integration with other services (location/GPS, social media, Wi-Fi), network services...
Scalability	The system must be scalable to either handle increases in load without impact on the performance of the system, or the ability to be readily enlarged.	The system must support the loads of flows generated by a user when using the app. The system must be adapted to the capacity of the application protocols and the server will have sufficient capacity to handle the data flows with the app.
Security	Capable needs to provide a secure system that prevents malicious or accidental events outside the normal usage and must prevent the loss of information. In the capable environment it will be a key requirement due to the clinical and personal information managed by the app.	The Capable app will follow the requirements of EN ISO 14971 (2007) – “Application of Risk management to medical devices” addressing risk identification, assessment and acceptability in the use of medical devices in terms of security.
Supportability	The system will provide information to help identifying and resolving issues when it fails and must help the users to understand and perform the correct usage of the application.	The app will provide the necessary contents and messages to support the user in case of failure. A set of alerts and guidelines will be provided to the user by the app to perform this support.
Testability	It must be created a test criterion for the system and the different components and run these tests to determine if the system works as defined, it will facilitate the isolation of possible faults and to act faster to solve the possible problems.	The development team will design a set of units, integration, functional and end-to-end test before give the application to the users. This test will be automatized to rapidly test the fixed errors, but it could be manual if necessary.
Usability	The application must meet the functional requirements defined for the users and it has to be intuitive providing good access for disabled users and resulting good and attractive in user experience.	The application interfaces must be designed with user and consumer mind. A group of technical experts will provide their support to avoid too much interactions, to choose appropriate control types, to use UI design patterns and to avoid incorporating inappropriate workflows.
Certiability	The application must be designed considering the different certifications on medical devices to achieve trust and reliability.	The Capable app will be developed following the requirements of EN ISO 13485 (2016) “Medical devices: Quality management systems” for medical devices of class I (Software for medical purpose)
Trustability & Quality of	The different contents and data provided by the app must be real,	All the contents of the application will be from proven sources and reviewed

data and contents	verified and approved so that quality and truthful information is provided to the user.	by the clinical and technical experts who participate in the project to ensure quality information.
Privacy	The application must meet the requirements of privacy of mobile applications and medical devices ensuring that the user data is properly protected and follow the guidelines of data protection.	The Capable app will follow the requirements of EN ISO 14971 (2007) – “Application of Risk management to medical devices” addressing risk identification, assessment and acceptability in the use of medical devices in terms of privacy.

CAPABLE must follow the General Data Protection Regulation (GDPR) which is detailed in D1.2 “Data management protocol” document. In addition, the Capable consortium will work also to be able to enable the user rights described in the GDPR directive which can be considered as non-functional requirements.

- **Right of access:** the user can ask to the clinical center a copy of the data in a format that will be agreed with the responsible of the pilot sites.
- **Right to rectification:** the patient can rectify any data that are not correct in the patient app.
- **Right to erasure:** if requested a patient can ask to the health professional to delete all the data from the database.
- **Right to restrict processing:** the users can ask to restrict the processing of some data.
- **Right to data portability:** (Effective 25 May 2018), the patient has the right to obtain the Personal Data from the data controller. The Personal Data will be provided in a format that will be agreed with the responsible of the pilot sites.
- **Right to object:** the user can ask to stop the data processing.
- **Rights in relation to automated decision-making and profiling:** the user can ask to stop the Capable decision support system.
- **Right to withdraw consent:** the participant has the right to withdraw that consent at any time. This will not affect the lawfulness of processing based on the prior consent.
- **Right to lodge a complaint with the data protection authority:** If the users have a concern about privacy practices, including the way in which Personal Data are handled, they can report it to the health professional that is authorized to hear those concerns.

## 5.. Clinical requirements

Clinical requirements of the healthcare professional's regarding the needs for decision-support system and Dashboard were collected via questionnaire and interviews of healthcare professionals from the two hospitals (ICSM and NKI). At NKI, a focus group and interviews were conducted. A total of 3 medical oncologists, 2 nurse practitioners, 2 psychologists and 3 residents were interviewed. The methods are presented in Section 5.1 and the results – in Section 5.3. At ICSM, 27 healthcare professionals (9 oncologists, 17 residents in oncology, 1 medical student) answered questionnaires and were interviewed. The methods are described in Section 5.2 and the results are presented in Section 5.4. The integrated clinical needs from both sites are summarized as a set of 5 clinical needs in Section 5.5.

Additional requirements collected concerned the clinical guidelines that would constitute the knowledge for the decision-support system and the patient data items that should be collected to drive the patient-specific decision-support. Section 5.6 presents the clinical guidelines addressing the most prevalent adverse effects of the cancer therapies, which were selected for implementation, as well as the cancer therapy guidelines. Analysis of these guidelines identified the clinical data that should be gathered and managed in the CAPABLE Data Store. These are described in Section 5.7.

As we are using agile methods for developing the system, Section 5.8 presents the clinical scenarios, personas and workflows of these scenarios – used for the M12 demo as well as scenarios that will be supported by future iterations. These were informed by the clinical needs summarized in Section 5.5. Thinking about the personas and the clinical workflows that they will go through, allowed us to take all of the requirements and inputs gathered, and translate them into functional and non-functional requirements described in sections 5.9 and 5.10.

Based on detailed analysis of all of the requirements gathered (Sections 5.3-5.8), as well as on studies of similar systems (see Section 2), on systems that we have previously developed, and on our work as part of the agile development, Section 5.9 presents Use Case Diagrams of functional requirements and detailed requirements for the Clinicians side of the CAPABLE system. Section 5.10 presents the non-functional requirements.

Finally, in Section 5.11 presents the barriers to market of the CAPABLE system.

## 5.1. Clinical requirement collection in NKI

---

A user-centered qualitative study was performed to assess the needs and requirements of health care professionals (HCP's) for the CAPABLE system, as prerequisite for the development of the CAPABLE system. The primary outcome of this study was the perspective of HCP's on the needed content, support and requirements for CAPABLE for monitoring and coaching patients with high-risk and advanced melanoma treated with immune checkpoint-inhibitors. A user-centered and participatory design was followed, causing the intended users of CAPABLE to take active part in defining requirements for the app. (Brenner et al., 2016)

A purposive sampling strategy was used to include a maximum variation of healthcare professionals (HCP) in the interviews. HCPs involved in the cancer care of melanoma patients (treated with immunotherapy) were eligible to participate. Medical oncologists, residents, nurse practitioners, psychologists and one primary care physician were invited to participate. HCP's willing to participate were asked to provide a signed and dated informed consent form. Each focus group lasted more than one hour.

One focus group consisting of 8 healthcare professionals (including 3 medical oncologists (One of the medical oncologists participating in the focus group is part of the CAPABLE team in NKI and might therefore been biased in the answers given.), 3 residents and 2 nurse practitioners) that are actively involved in follow up during and after immune-checkpoint inhibition (ICI) treatment was conducted until data saturation was reached. The medical oncologists, residents and nurse practitioners were asked to participate in a semi-structured focus group. A researcher experienced in leading a focus group interview (functioning as the moderator) and the study coordinator (assistant moderator) were present during the meeting. The focus group guide is shown in Appendix 10.2.2.

The focus group and interviews were audio-recorded and transcribed verbatim. All relevant information was coded (open coding) and as relevant central phenomena and categories appeared from these, the analysis was shifted to axial coding. Codes were independently compared by three researchers until consensus was reached. Thematic analysis was done by the methods of Braun & Clarke (Braun & Clarke, 2006). The study was approved by the Institutional Review Board of the NKI.

The interviews were semi-structured and started with a general introduction, background information of the CAPABLE study and the structure of the focus group. The goal of the focus group was to elicit requirements for different parts of the CAPABLE system for HCP's: the system offers (1) advice based on guidelines; (2) predictions from prediction models, and (3) summarized data from the patient's app. Furthermore, we also liked to know (4) HCP's perspective on the content of their patients' app. Within these 4 major domains we asked inductive interview questions and let the healthcare professional discuss about their needs and requirements.

The mean duration of the interviews with the psychologists was around 50 minutes. The interviews with the psychologists mainly provided information on input for educational content in the patient app, since they will not be using CAPABLE in our hospital during the trial. The focus group and two interviews were conducted between May 2020 and August 2020.

## 5.2. Clinical requirement collection in ICS Maugeri

---

A written questionnaire was administered to 27 health care professionals (doctors and residents mostly) specialized in oncology. The questionnaire was approved by the ethical committee of ICSM and it is presented in Appendix 10.3

We attached an explanation of the project to the questionnaire.

The administration of the questionnaires was guided by a trained professional and it took in average 40 minutes to complete. The administration took place between July and October 2020.

With the Clinician interviews we aim to understand which kind of specifications the final product has to feature in order to satisfy the needs of the healthcare professionals and patients.

In this questionnaire we ask the clinicians to consider which information they may find useful for them or the patient, they include:

- Info to display
- Info to input
- Info collected, including the ones coming from the wearable devices
- Guidelines to implement
- How to receive alerts
- Ways to monitor the overall wellbeing of the patient.

We took into account that the displayed content will differ according to the user (see 6.1.1).

We interviewed 27 healthcare professionals (9 oncologists, 17 residents in oncology, 1 medical student), whose age ranged between 25 and 51 years. 63% female, 37% male. 59% of them use ICT in clinical practice, but only 18% of them has a previous experience with remote monitoring systems.

### The questionnaire

The questionnaire is composed of 18 questions, aimed at investigating the opinion of the clinicians on the project, how likely they will be willing to use the system and in which features they are interested in.

The first section includes demographic questions; questions 1-3 are dedicated to which info the clinicians think are useful to display for them and the patient; Questions 4-5 are about the features that CAPABLE can implement; 6-8 patients' expressed needs; 9-10 alerts, and 11-17 clinician opinions.

The questions are of three kinds: open-ended, multiple choices, and table filling.

## 5.3. Results of Clinical Requirement Collection at NKI

---

The focus group and two interviews were conducted between May 2020 and August 2020. A total of 3 medical oncologists, 2 nurse practitioners, 2 psychologists and 3 residents were interviewed.

### 5.3.1. Current situation and supportive care needs

---

Generally, in The Netherlands, there is increased attention to supportive care. The Antoni van Leeuwenhoek (AVL) hospital contains a Centre of Quality of Life (CKvL) for multidisciplinary supportive care (physical, social, psychological, spiritual). Patients are able to receive supportive care at the CKvL even without referral of their healthcare professionals. In clinical practice patients encounter barriers of asking for psychological help and they are not always aware of additional

supportive care options. Moreover, healthcare professionals complain about complications with referring patients and the attention to patients' psychosocial state including sexuality differs per healthcare professional.

HCP's see chances for better referral to supportive care through an app. Their goal is to refer the patient (as easy as possible for the HCP) to the CKvL, where the support consultant can start triaging the patient. Filtering and referring can be done automatically from the outpatient clinic, but can also be done based on psychosocial risk factors and patient care needs. Furthermore, there needs to be an option for contacting the support consultant in the app.

### 5.3.2. Intended way of use and user needs

---

HCPs see several chances and valuable use of this app:

- Better referral to the CKvL through an app.
- To follow-up side effects and the effect of interventions to those, but also for measuring quality of life and psychosocial well-being. The app can be used as a reference during and prior to outpatient visits. Different opinions on the frequency of the app use arose in the interviews. Different HCP's agreed on using the app in the morning instead of at the end of the day, and use the app daily to monitor patients with a daily to-do list. Other HCPs agreed on using the app depending on the frequency of outpatient visits or appointments, the wishes of the patient and doctor, of depending on the patient input. HCP's all agreed on the fact that HCP's are in control over when the app is viewed and give at least weekly feedback on patient activity.

For successfully implementing this app in to clinical practice in the AVL, integration of the app in our electronic health record (EHR) is desirable. An exchange between the two systems is preferred since use of two systems is considered as double and therefore limiting for proper record filing and referring.

### 5.3.3. Input data need to come from the patient app

---

As described above, HCPs would like to use the app as a reference. They see it as an advantage to have patient information digitally. The wished/needed data input coming from the patient app is split into medical, psychosocial and sensor data.

- Medical input data: clinical patient information, such as medical diagnosis, disease/medical history, current treatment, medication use and medication registration.
- Psychosocial input data: patients' background and biography, way of thinking (meaning, religion), psychological/psychiatric history and psychosocial information (family situation, work, activities, social life, physical activity).
- Sensor input data: HCP's will not make decisions based on sensor data and they consider sensor data interesting for the patient and not necessarily for the HCP. However, some HCPs thought sensor data in combination with medical complaints can actually be very useful.

### 5.3.4. Information presentation needs

---

HCPs would like to see the provided information in a concise summary and/or graphically represented. Graphical representation of symptoms or sensor data is wished for clinical use. When notifications show up for HCPs, urgency should be displayed based on colors.



### 5.3.5. Clinical decision support and alerting needs

---

Guidelines considered being applicable and valuable in **medical** clinical decision support of melanoma patients that receive ICIs are the European Society of Medical Oncology (ESMO) Immunotoxicity and supportive guidelines. Guidelines for **psychosocial** needs or support can be found on a nation-wide guideline for the field of oncology ([www.oncoline.nl](http://www.oncoline.nl)). However, most referrals and protocols are flexible and based on intuition instead of guidelines.

HCPs' opinion towards decision support differed among them. When implementing a decision support and alerting function in an application, HCPs would like to use this for alerts of psychosocial and medical complaints. Notifications or pop-ups should be given (to either patient or HCP) when the patient is not doing well and/or enters severe acute medical complaints, since this is considered as useful. For monitoring patients during their treatments, patient-reported outcome measurements (PROMs) can be used. Questionnaires can be used for monitoring quality of life (QoL) of patients, to see how a patient is doing during and after treatment, but can also be used to open conversations on the patient's psychosocial state during an outpatient visit. Questionnaires to be used:

- Distress Thermometer
- SNAQ-score
- EORTC-QLQ C30

HCPs have different opinions on implementing such decision support or signaling function in an app. HCPs believe that decision support can improve the quality of care, and besides, can help inexperienced doctors in their training. However, HCPs also do not fully believe in/or are skeptical about decision support, since computers are lacking the ability to ask the patient for more information after reporting complaints.

### 5.3.6. Communication needs

---

Another topic that shortly arose in the interviews is the need for communication between HCP and patient through the app. Willingness of HCP's to try communication options in an app are present to better structure HCP-patient communication and patients can low-key ask questions to HCPs. A downside to a communication tool can be the overload of non-urgent questions to a HCP.

### 5.3.7. General/additional needs

---

A few requirements for successfully implementing this app for HCP's consist of the way they want to use the system together.

- The app should be available in the AVL and virtual work environment and the system should always be accessible.
- Multiple users should have access to a patient and need to be able to "change" things in a patient.

HCPs' general opinion on the app for patients and HCP's was that the app has little added value for caregivers because of already existing programs. The overall message of the interviews was that the app should not overload patient and HCP's. However, HCP's strongly believe that the app is beneficial for the patient, if the app is supportive, has added value and stands out from other apps.

## 5.4. Results of Clinical Requirement Collection at ICS Maugeri

---

In this section we report the results obtained for the questionnaires administered at ICSM, in Pavia.

The first question is related to the guidelines that are considered important (both from the oncologist and from the patient perspective), and that could be considered for inclusion in the CAPABLE system. The answers to this question are summarized in Tables 5.4.1 and Table 5.4.2. These results have been useful to define, together with the physicians involved in the project, the set of guidelines that will be implemented in the CAPABLE system (see Section 5.6)

Table 5.4.1 clinical guidelines for doctors

Guideline for Doctor	Very important	Important	Not important
Febrile Neutropenia	14	4	7
Immunotherapy toxicity	12	11	4
Infusion reaction	11	11	4
VTE (Venous Thromboembolism)	11	9	7
Pregnancy	10	8	9
Weight loss	10	7	10
End of life	10	7	9
Cardiovascular toxicity	9	13	5
Dyspnea	8	12	7
Skin toxicity	7	15	5
Delirium	7	12	8
Pain	7	11	8
Anemia	7	9	11
Bone health	5	11	10
Mucositis	3	14	10
Nausea/Vomiting	3	13	11
Fatigue	3	13	10
Paresthesia	2	15	9
Diarrhea	1	18	8
Constipation	1	15	10

Table 5.4.2 clinical guidelines for patients

Guideline for patient	Very important	Important	Not important
Nausea/Vomiting	16	11	0
Pain	16	5	5
Mucositis	15	10	2
Diarrhea	14	11	1
Pregnancy	14	8	5
Constipation	13	12	2
Fatigue	13	12	2
Skin toxicity	13	12	2
Weight loss	12	12	3
Dyspnea	12	7	7
Paresthesia	8	15	4
Immunotherapy toxicity	8	14	4
VTE (Venous Thromboembolism)	8	9	10
End of life	8	4	12
Febrile Neutropenia	7	9	9

Infusion reaction	7	5	13
Delirium	7	1	18
Bone health	5	12	9
Anemia	5	5	17
Cardiovascular toxicity	4	10	13
Infertility	1	0	0

The second question was aimed to understand, among a set of possible interventions, the ones that clinicians would like to see implemented in a system like CAPABLE, both from the oncologist’s and from the patient’s perspective. Figure 5.4.1 reports the results related to the

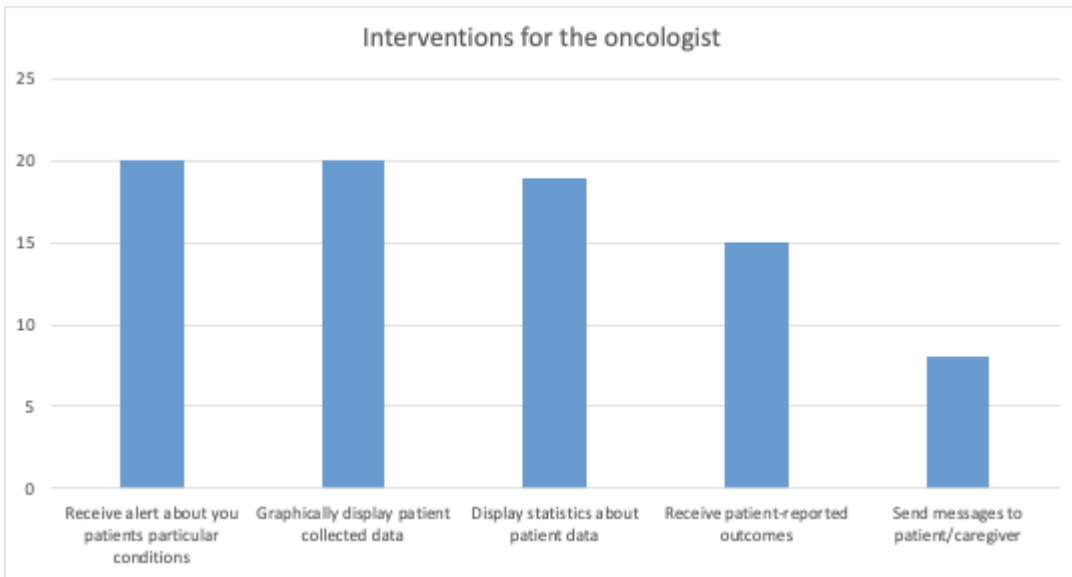


Figure 5.4.1 Interventions for the oncologists

While the functionalities related to alerts (in case of specific patient’s conditions) and of data summary/visualization have received a high number of preferences, the possibility of directly sending messages to the patients using the app is seen as less attractive.

Figure 5.4.2 reports the results on the interventions for patients. The interventions that are considered most important for a system like CAPABLE are the ones related to pain management, education on side effects and intervention related to promoting treatment adherence. These results confirm the opinion of the participants on the guidelines selection, where they indicated pain and several side effects management as the most important. We should consider that these answers depict the perspective of the doctors, who might underestimate some issues not directly related to the clinical condition but that are important for the patients’ quality of life (e.g. sleep improvement).

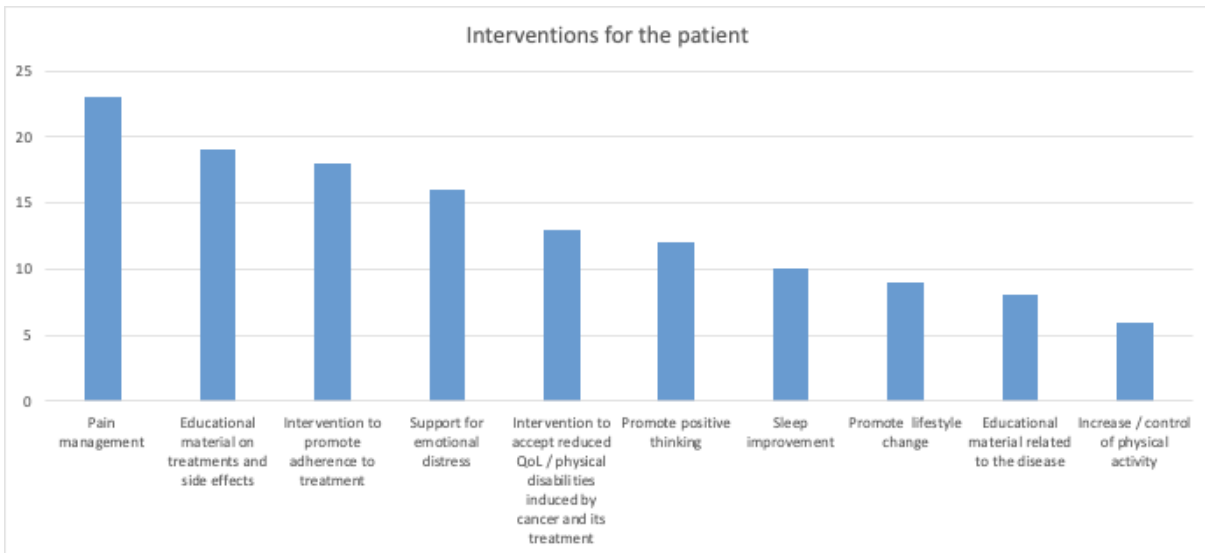


Figure 5.4.2 Interventions for patients

Question 3 is related the use of sensors for monitoring physiological and environmental parameters. We have asked participants to select, among a list of sensors, the ones they consider important. Results are summarized in Table 5.4.3. The results show that clinical parameters are the most important for oncologists, whereas other lifestyle related parameters are considered not crucial. Interestingly, some of the participants added to the proposed list other data that could be useful to monitor, such as glycemia, pain, appetite, and compliance to the oncological treatment.

Table 5.4.3. Sensors that should be used

	Very important	Important	Not important
Blood pressure	11	12	3
Weight	8	13	5
Temperature	7	14	3
HR	4	20	2
ECG	2	21	3
Sleep	1	15	10
Physical activity (steps, calories)	0	12	14
Photoplethysmography	0	2	22

Question 4 is related to the use of virtual capsules. Oncologists all agree on their use and most of them with a frequency of once a week (14/27).

Question 5 is related to use of prediction models. The results (see Table 5.4.4) show that most predictions are interesting for the oncologist, the least interesting is the one related to psychological problems.

Table 5.4.4 Predictions that interest oncologists

Prediction	Very interested	Interested	Not interested
ADE occurrence	20	7	0
Overall survival	19	7	1
Progression Free Survival	18	8	1
Psychological problems occurring	4	17	6

Question 6 is related to the information that patients ask for. Oncologists could choose from four fixed options (Diet, Physical activity, Drug-food interaction, Drug-drug interaction) and then could

report the other most frequent ones. The results are shown in Table 5.4.5 (for the four fixed categories) and 5.4.6 (for adverse events).

Table 5.4.5 Information that patients ask about

Topic	Often	Sometimes	Rarely
Diet	18	8	
Drug-drug interaction	11	12	3
Drug-food interaction	10	13	3
Physical activity	5	12	8

Table 5.4.6 Information on ADEs, asked by patients

Topic	Often	Sometimes	Rarely
Diarrhea	17	3	
Nausea	13	3	
Vomit	10		
Asthenia	6		
Alopecia	4		
Mucositis	4		
Fever	3		
Dermatological reactions	3		
Other (e.g. fatigue, hypertension, etc)	2		

The most frequent topic is the diet and the answers confirm the importance of the adverse event management and of the drug-drug and drug-food interactions.

Question 7 concerns printed/virtual educational material provided to the patient. About half of the participants currently provide printed/virtual educational material, but half of the oncologists don't. Since from our interviews most of the patients declared that they are interested in this type of information, the CAPABLE system will be able to bridge this gap.

Question 8 is about how often the oncologists refer their patients to the psychological support available at ICSM. 48% of the participants frequently refer their patients to the psychologist, 48% sometimes request the support of the psychologist, whereas 4% rarely.

Question 9 investigates the type of interaction that the physician would prefer with the system in case a new symptom is reported by the patient through CAPABLE. We offered three alternatives: (I) the doctor is notified immediately about a symptom of any nature (synchronous interaction), (ii) the doctor is notified immediately in case of a symptom of CTCAE grade  $\geq$ G3, (iii) the doctor is not notified immediately, but periodically checks the symptoms through his interface (asynchronous interaction). The results (Figure 5.4.3) show a preference for a synchronous interaction in case of moderate/severe symptom. This is in accordance with the answers to question 2 related to the desired interventions, where the one related to the alerts in case of critical conditions was considered as the most important.

We also asked participants how they would prefer to be notified in case of synchronous interactions (sms/email/other): 15/18 prefer the email, 1/18 prefers the sms, 1/18 both email and sms and 1/18 chose the "other" option, indicating in-app notification as his preference.

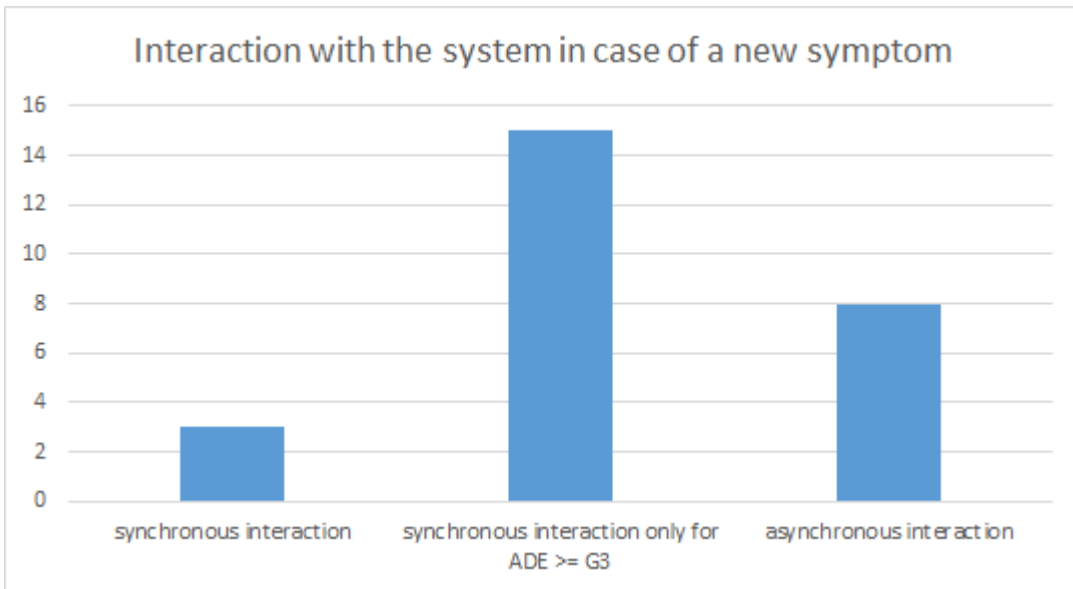


Figure 5.4.3 Type of interaction with the system that doctors prefer

Question 10 is related to the access to the CAPABLE interface. It includes 4 sub-questions: (1) frequency of access to the CAPABLE application, (2) preferred device, (3) place where the app will be mostly used, (4) importance of 24/7 accessibility. Results are shown in Figures 5.4.4-5.4.7.

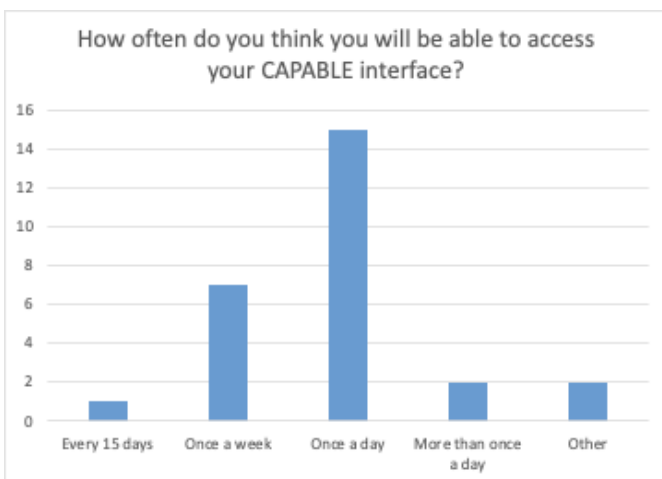


Figure 5.4.4 Intended frequency of system access by doctors

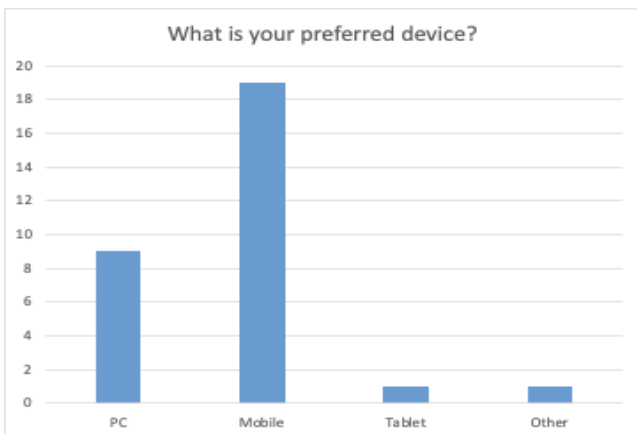


Figure 5.4.5 Doctors' preferred device

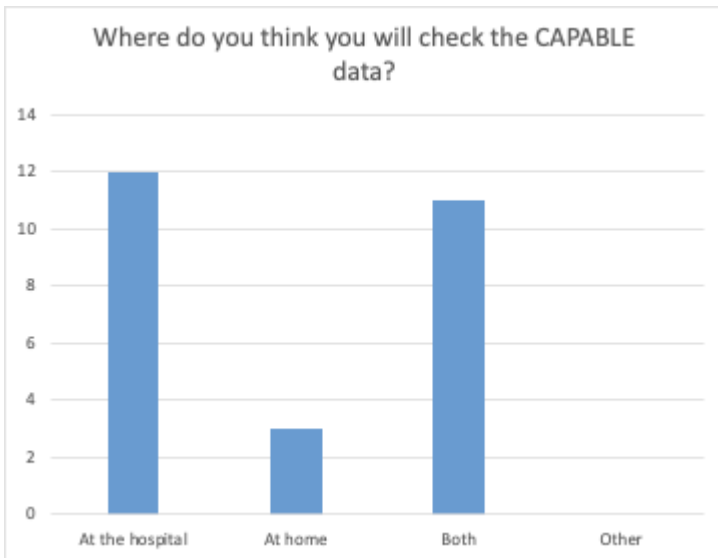


Figure 5.4.6 Place of system access preferred by doctors

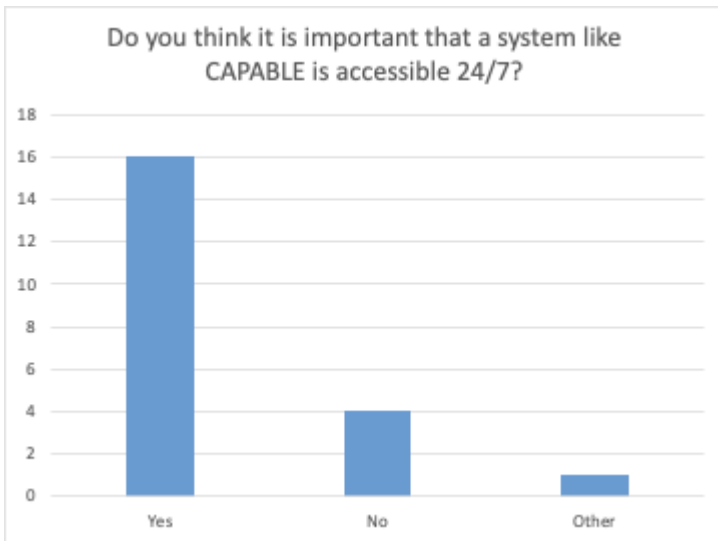


Figure 5.4.7. Importance of accessibility according to doctors

Question 11 was related to investigating the foreseen risks related to the CAPABLE concept. The results are shown in Table 5.4.7.

Table 5.4.7 Foreseen risks

To put too much confidence in the app, for the patient	17
Possible medicolegal implications	17
Too many technical skills required to use it	14
To put few confidence in the app, for the patient	10
To put too much confidence in the app, for the doctor	7
To compromise the patient-physician relationship	6
To miss some patient's data	5
To put few confidence in the app, for the doctor	4
Other	2

Question 12 implements the Technology Assessment Model (TAM) questionnaire. It is composed of the following 6 sub-questions:

Q1. Using CAPABLE in my job would enable me to accomplish tasks more quickly

- Q2 Using CAPABLE would improve my job performance
- Q3 Using CAPABLE in my job would increase my productivity.
- Q4 Using CAPABLE would enhance my effectiveness on the job.
- Q5 Using CAPABLE would make it easier to do my job.
- Q6 I would find CAPABLE useful in my job

The answers are given on a 7-points Likert scale, where 1 corresponds to Strongly Disagree and 7 to Strongly Agree. Results are reported in Figure 5.4.8.

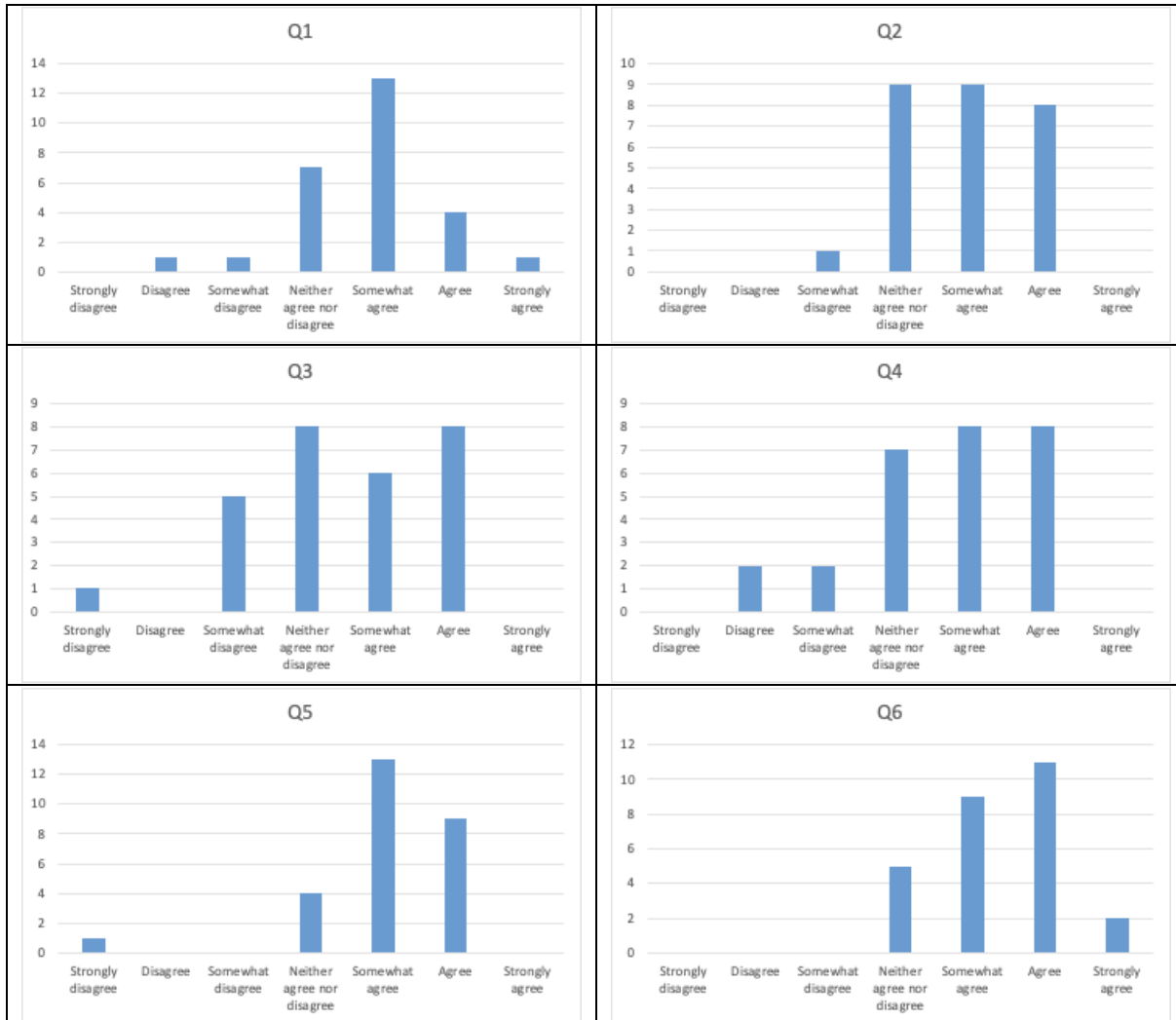


Figure 5.4.8 Answers to the TAM questionnaire

Q6 shows that all the participants believe that the system will be useful for their job, even though there are some doctors that are sceptical regarding the impact of the CAPABLE system on productivity and effectiveness (Q3, Q4). This can also be related to the idea that using a system like CAPABLE could require an additional time effort for patients’ management (Q1).

Question 13 asks what data from the hospital information system could be useful to be integrated in CAPABLE. The proposed options were: EHR, LIS, RIS, Other, and each participant could choose multiple options. The most selected option was EHR data (24 preferences). RIS got 8 preferences, and LIS got 3. 3 participants did not respond to this question.

Question 14 asked whether CAPABLE could potentially decrease healthcare costs. The costs that participants could select were: patient’s out-of-pocket costs, hospital costs (in terms of reduction of: (i) hospital admissions, (ii) number of planned visits, (iii) number of unplanned visits due to patient’s complications or adverse events, (iv) unnecessary drug prescription), other costs. Answers are reported in Table 5.4.8.



Table 5.4.8 How CAPABLE could decrease costs

Patient’s out-of-pocket costs	13
Hospital costs	2
Reduction of hospital admissions	7
Reduction of number of planned visits	13
Reduction of number of unplanned visits due to patient’s complications or adverse events	13
Reduction of unnecessary drug prescriptions	4
Other costs	-

Questions 15-17 were yes/no questions that ask the opinion of the participants on the possibility for the CAPABLE system to:

Q15 increase the efficiency of control visits

Q16 reduce patients’ emails and phone calls related to mild (G1/G2) adverse events

Q17 improve the quality of the services for the patients

Answers are reported in Table 5.4.9.

Table 5.4.9 Answers to questions 15-17

Question	Yes	No	Other/I don’t know
Q15	22 (81%)	3 (11%)	2 (8%) (it depends on the type of visits and only for the data visualization)
Q16	24 (88%)	3 (12%)	
Q17	26 (96%)	0 (4%)	1

The answers to Q15-Q17 confirm that the participants see the CAPABLE system as useful to improve the quality of the services delivered to the patients, increasing the efficiency of control visits and managing through the app mild adverse events.

Question 18 included 4 sub-questions related to possible implementation barriers. This question was originally thought to be administered only to users from the hospital IT staff. Since we had no such users, no answers are available in this case.

## 5.5. Integrated Clinical needs

From the interviews in the two clinical centers the consortium extracted the following five clinical needs (CN).

**CN1:** Monitor the progress of the disease, symptoms, side effects, the overall patients’ quality of life and wellbeing.

HCPs would like to monitor medical and psychosocial complaints, as well as quality of life. Patient data should preferably be collected using validated Patient Reported Outcome Measures (PROMs), for example such as Distress Thermometer, SNAQ-score and EORTC-QLQ C30 questionnaire.

In terms of information presentation, patient collected data/statistics should be displayed concisely and could be graphically visualized.

**CN2:** Use AI to process this monitoring data and provide a flexible clinical decision support system to identify risky and critical situations (adverse events of therapy, treatment change, referral to another specialist etc.) following the recommendations from guidelines.

HCPs would like to receive alerts based on the patient reported medical and psychosocial complaints. Immediate notifications should be displayed when the patient’s wellbeing deteriorates and/or if the patient enters acute moderate/severe medical complaints.

**CN3:** Provide digital tools to patient to foster adherence, and assist to face the daily problems of the cancer journey.

HCPs mentioned the following needs of patients during their cancer journey:

- **Education:** information about diagnosis, treatment, symptoms, side-effects (including drug-drug interactions), fitness and exercising, nutrition (including drug-food interactions), energy distribution (fatigue), personal relationships and communication, sex and intimacy, sleep, practical information regarding work, finances and insurances, social activities.
- **Interventions:** such as mindfulness, creative therapy, relaxation and interventions to promote adherence to treatment, to accept reduced QoL/physical disabilities, to promote positive thinking, sleep improvement, to promote lifestyle changes including physical activity.
- Psychological support through app.

**CN4:** Need to have a system integrated with the HIS, to obtain information about the clinical history and to report relevant event (e.g. ADE) directly in the central repository, avoiding double work of the care team.

Deemed necessary by the clinicians of the AVL for successfully implementing CAPABLE, integration of CAPABLE and the currently existing electronic health record (EHR) is desirable. An exchange between the two systems is preferred as the use of two systems (and requiring input of identical data in two different systems) can be seen as redundant.

This is for sure a desirable feature for clinicians, however the feasibility of this integration depends on several factors not only related to the clinical management of the patients, but also technical and organizational. It was decided that EHR data will be copied during patient data import in the enrollment phase.

**CN5:** Foster interdepartmental collaborations to offer integrative services with Supportive Care Team and other specialists (e.g. nutritionists, clinical psychology, social services).

The AVL contains a Centre of Quality of Life (CKvL) for multidisciplinary supportive care (physical, social, psychological, spiritual. Specifically, for the AVL, CAPABLE can promote these supportive care options within the AVL for patients and increase visibility of the CKvL for HCPs. Additionally, CAPABLE should inform the patient of supportive care options available at ICSM such as psychologists.

In general, CAPABLE should also provide patients with information about additional (certified) supportive care providers, outside of the hospital (with or without physician referral) such as physiotherapists, lymphedema therapists, occupational therapists, and rehabilitation specialists.

We have highlighted in Section 5.9 how these needs are met. Requirements CN3 and CN5 are also highlighted in Section 4.7, which related to Patient requirements.

## 5.6. Guidelines selection

---

The project will consider a set of guidelines published by the European Society for Medical Oncology (ESMO). In particular, we have identified 5 guidelines for treating the most relevant adverse events in cancer patients. These are:

- Diarrhoea in Adult Cancer Patients;
- Cancer-related fatigue
- Management of toxicities from immunotherapy
- Prevention and management of dermatological toxicities related to anticancer agents
- Management of oral and gastrointestinal mucositis

In agreement with the oncologists of NKI and ICSM, during the first year of the project we decided to analyze and then model two guidelines of the ESMO: one for the management of diarrhoea (Diarrhoea in adult cancer patients) and one for the management of fatigue (Cancer-related fatigue).

These in fact represent two of the most frequent side effects in patients who undergo cancer therapy.

In particular, diarrhoea can be managed, in case of mild or moderate symptom (diarrhoea CTCAE grade 1 or 2 and no related symptoms), by the patient at home.

The fatigue guideline was chosen because it is primarily focused on the patient and on her/his physical and psychological well-being. This aspect allows to implement and test some specific features of CAPABLE project such as the use of sensors (for the automatic detection of physical activity) and the Coaching system through the use of Capsules.

Since immunotherapy is a treatment frequently used both for melanoma and renal cancer, the next guideline to be implemented will be the one related to the management of toxicities from immunotherapy. Among the adverse events related to immunotherapy, one of the most frequent is related to skin toxicity. To complement the skin toxicity section of the immunotoxicity guideline, we chose to implement also the ESMO Prevention and management of dermatological toxicities related to anticancer agents.

Another important adverse event that can be related to cancer treatment is mucositis, so this guideline will be implemented in the system during the third year of the project.

## 5.7. Clinical data to be collected by the CAPABLE system

---

The analysis and implementation of the selected guidelines made it possible to identify clinical data to be collected within the CAPABLE system through the physician app and the patient's app.

The clinical data are the following:

- Patient characteristics (age, sex, bmi, WMO score, alcohol consumption, smoking)
- Symptoms (e.g. diarrhea, nausea, vomiting, abdominal pain, dizziness, cramps, fever, bloody stools) together with their CTCAE grade, start and end date, and actions taken to manage their impact on the current cancer treatment
- Tumor characteristics (TNM staging, possible metastases and their sites)
- Risk factors (e.g. diabetes, hypertension, autoimmune disease or other comorbidities that can act as risk factors for developing treatment toxicity)
- Clinical history (cancer-related surgeries with date, other surgeries, hospitalizations, and other relevant events)
- Cancer treatment (type of drugs for each treatment line, start and end date, reason for stopping treatment, treatment response including possible progression)
- Other treatments (also not cancer-related)
- Exams and visits
- Laboratory tests (e.g. glucose level, absolute neutrophil count, hemoglobin, serum corrected calcium, LDH, platelets lymphocytes, serum sodium, creatinine, s100b, TSH, etc)
- Physiological and lifestyle data (weight, temperature, oxygen saturation, blood pressure, heart rate, sleep monitoring, physical activity indicators) . These will be collected through an ASUS VivoWatch SP (HC-A05) smartwatch.
- Environmental data coming from a network of air quality sensors available in the Pavia area. The network includes about 40 PurpleAir [PA-II devices](#), which measure air quality in terms of PM1, PM2.5 and PM10. The data coming from such sensors will be used to develop an algorithm to allow patients to perform outdoor activity following the best pathway in terms of air quality and pollution. Having as input the patient position, the desired duration and the desired length of the activity, the algorithm will propose the optimal path, or a set of equally optimal paths, to the patient.
- Questionnaires - collected via the app or on paper (EORTC QLQ-C30 for quality of life, EUROQOL 5D-5L, EORTC QLQ INFO25, Insomnia Sleep Index, MST, PHQ-9 for depression, GAD7 for anxiety, emotional thermometers, NRS2002 nutritional risk screening,

caregiver burden inventory, HADS – hospital anxiety and depression scale, BFI- Brief Fatigue Inventory, FACT-M for melanoma, FACT-R for renal cell carcinoma, FACT-G, EORTC SHQ-C22 SUBSET).

Table 5.7.1 reports, for each category of data, the source from which it can be collected (EHR, Patient App, Physician App, Sensors)

Table 5.7.1 Data sources

Data type description	EHR	Patient App	Physician App	Sensors
Symptoms	x	x	x	
Tumor characteristics	x		x	
Risk factors	x		x	
Clinical history	x		x	
Cancer treatment	x		x	
Other treatments	x		x	
Exams and visits	x		x	
Laboratory tests	x		x	
Physiological and lifestyle data		x	x	x
Environmental data				x
Questionnaires		x	x	

## 5.8. Clinical workflows and scenarios for Clinician Users (TF2)

### 5.8.1. Personas

This section details the persona of Mimma, an Italian oncologist assisting our prototype patient Maria (described in section 4.4.1). Mimma is a female, 38 years-old oncologist, who specializes in urothelial cancers. She has over 10 years of experience of patient care. She practiced medical oncology in several Italian centers and is currently with the division of translational oncology at ICS Maugeri and head of the organization’s clinical trial center. Mimma has significant experience in telemedicine intervention for cancer patients, and she was actively involved in Onco-TreC [Passardi 2016]. Mimma’s primary motivation for using CAPABLE is to be able to follow her patients more closely and provide better assistance in-between appointments. She sees the added value of CAPABLE consisting in tighter monitoring of patients at home, improved management of therapy side effects (especially immunotherapy, the most used treatment for renal cancer patients currently), and easier collection and access to patient reported outcomes. Given her experience in designing and running clinical trials she will have a key role in the CAPABLE pilot studies.

### 5.8.2. Demonstration Scenario

The scenario that will be used to demonstrate the 1st CAPABLE POC is described in deliverable D4.1. In particular, here we focus on the physician-oriented parts, while patient-oriented parts are described in section 4.4.2. The scenario articulates over a period of 3 consecutive days, including day 0 (= time of enrollment in the CAPABLE system). Details about what is expected from different CAPABLE components are also provided along with the scenario, to show the involvement of CAPABLE system components in the enactment of specific portions of the

scenario. This also ensures the integration with section 6 Overall CAPABLE architecture, which will describe the system components in more detail.

This scenario includes parts that are driven by the Physician and some driven by the Patient. Table 5.8.2 shows the parts of the scenario related to the Physician. We report also the general requirements that are described in the use case diagram reported in Section 4.7, and the involved CAPABLE components described on Section 6.

Table 5.8.2

	Physician	Reference to Use Case Diagram (Section 5.7)	Involved CAPABLE components
Day 0	The physician enrolls a new patient: Maria Rossi and inserts initial data and prescribed treatments.	Req. 1 (Enrollment) Req. 2.2.1 (Modify/Add Data)	Physician App, Virtual Coach, Physician DSS, Case Manager, Data Platform
Day 1, Day 2	The physician can check patient data on the physician app	Req. 2.2 (View Data) Req. 3.4 (Recommendation for patient)	Virtual Coach, Physician DSS, Case Manager, Data Platform, GoCom, KDOM
Day 3	The physician app notifies the current situation and recommends the treatment interventions according to the guideline	Req. 2.2.1 (View Recommendation Option set)	Physician App, Virtual Coach, Physician DSS, Case Manager, Data Platform, KDOM

### 5.8.3. Other Scenarios (based on the extended CAPABLE proposal)

---

There are other possible scenarios than the one presented in paragraph 5.8.2 Demonstrated Scenario. The scenarios that are presented now concern the psychological and nutritional parts. Psychological Improvement Scenario

There are currently two distinct approaches to patient psychological assessment in CAPABLE. The Italian approach is structured with the help of psychologists from ICS Maugeri and AIMAC, and the Dutch method is created with the help of NKI psychologists.

In the Italian approach, the patient undergoes a first visit with the psychologists in which the same questionnaires are administered. After the first visit, the patient can be contacted immediately for a second visit, or he can go home and continue the psychological support from the application.

Home psychological support consists of the periodic execution of specific questionnaires to highlight signs of anxiety, depression and need for help. The system will always monitor the results and actions of patients, to intervene promptly, if necessary, through further psychological visits.

Also, the patient can independently fill a thermometer for help requests, if he deems it necessary, and he will be contacted directly by a psychologist who will support him.

As for the Dutch approach, the patient undergoes the first visit with the psychologists, but the caregiver is also involved. During the first visit, the psychologist proposed the CBI (Caregiver Burden Inventory, validated tool) questionnaire and the need-help thermometers to the patient. After the visit, the patient can go home to continue the psychological support remotely. Home psychological support consists of the periodic administration of the CBI questionnaire to the patient. Even in this case, the system will always monitor the results and actions of patients, to

intervene promptly through further psychological visits. Also, the patient can independently fill a need-help thermometer, and he will be contacted directly by a psychologist who will support him. To see the flowcharts and their detailed description, please look the document (Study Protocol).

### **Nutritional Improvement Scenario**

In the CAPABLE project, we aim at involving the nutritional services available at both ICSM and NKI in the management of the patients.

The wellbeing of the patient is strongly related with their nutritional status. To improve this important aspect of their life, we want to administer the malnutrition screening tool (MST) on day 1. The test is described in section 4.7, req. 1.3.

If we have even a small sign of malnutrition (score greater or equals to 2) the oncologist will address the patients to the dieticians in-situ. The dieticians will assess the patient's nutritional status and prescribe additional tests if needed.

The recommendation of the dietician will be available on the app.

Every 3 months all the patients, even the ones that didn't visit the dietician before, will receive a reminder to fill-in the MST questionnaire in the app. In case the score will be greater or equals to 2 the dieticians will contact the patient for a screening.

## **5.9. Use Case Diagram and functional requirements**

Based on detailed analysis of all of the requirements gathered from NKI and ICSM (presented in Sections 5.3 and 5.4 and summarized in Section 5.5), as well as on studies of similar systems (see Section 3), on systems that we have previously developed, and on our work as part of the agile development (Section 5.8), this section presents Use Case Diagrams of functional requirements and detailed requirements for the Clinicians side of the CAPABLE system. We have highlighted in yellow the clinical needs summarized in Section 5.5 - as they are reflected in the functional requirements below.

The use case tables below do not indicate specific dates yet. These will be set in D1.3 at M16. This is because the iterations planning will depend on how well will we do at the M12 demo, and also reviewers' feedback during 1st technical review.

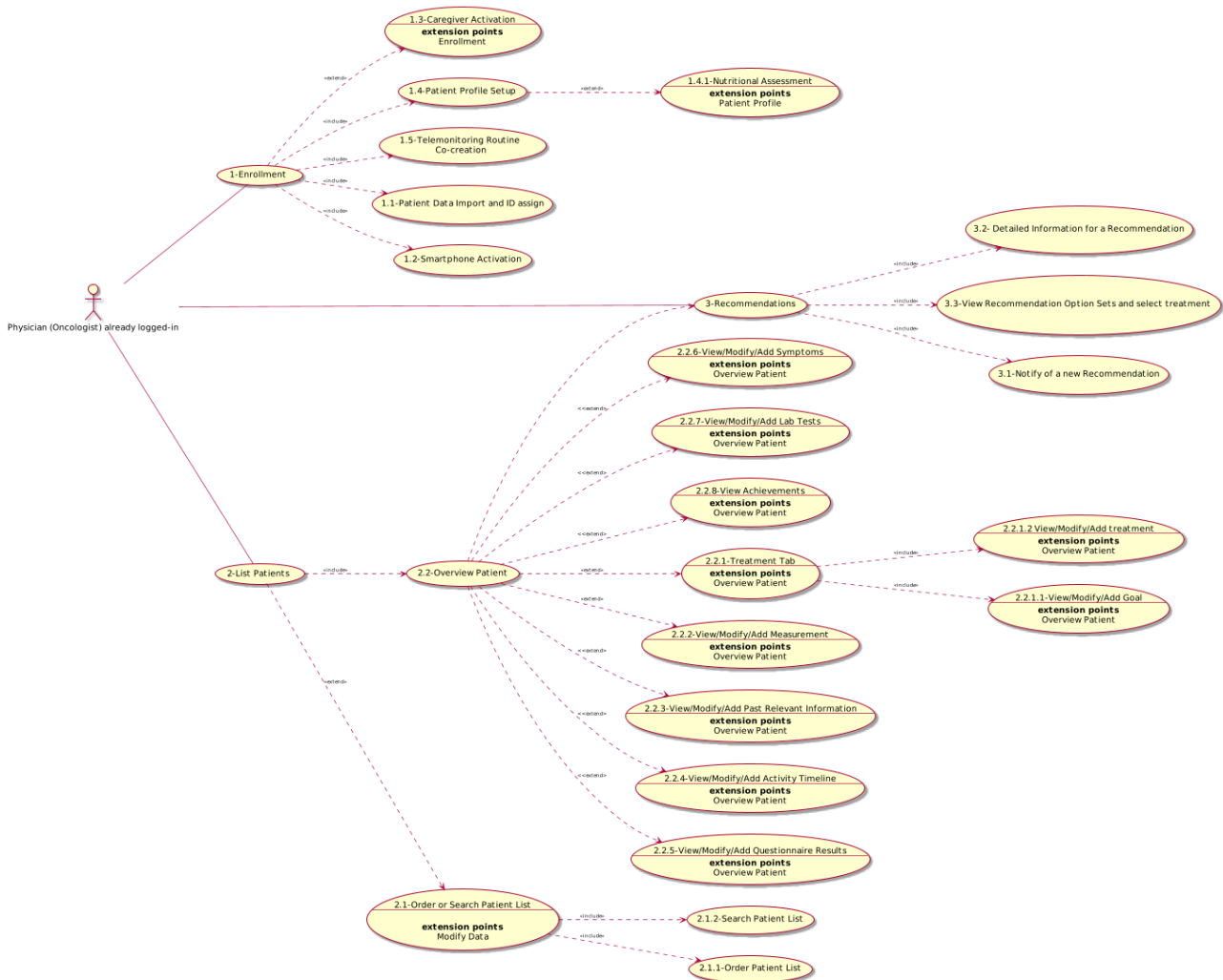


Figure 5.9 Use Case Diagram for the Physician User

Overall list of functional requirements:

- 1 Enrollment
  - 1.1 Patient Data Import and ID assign
  - 1.2 Smartphone Activation
  - 1.3 Caregiver Activation
  - 1.4 Patient Profile Setup (revised, including extensions)
    - 1.4.1 Nutritional Assessment
  - 1.5 Telemonitoring Routine Co-creation
- 2 List patients (revised, including extensions below)
  - 2.1 Order or Search Patient List
    - 2.1.1 Order Patient List
    - 2.1.2 Search Patient List
  - 2.2 Overview Patient - view and update
    - 2.2.1 Treatment Tab
      - 2.2.1.1. View/Update/Add wellbeing goals and activities
      - 2.2.1.2 View/Update/Add treatment with reference to goal and condition
    - 2.2.2 View Measurement
    - 2.2.3 View/Add Past Relevant Information (Clinical History)
    - 2.2.4 View/Add Activity Timeline
    - 2.2.5 View/Add Questionnaire Results (PRO and others)

2.2.6 View/Add Symptoms

2.2.7 View/Add Lab Tests

2.2.8 View Achievements

3 Recommendations

3.1 Notify of a New Recommendation

3.2 Detailed Information for a Recommendation

3.3 View Recommendation Option Sets and select treatment

Req. 1	Enrollment
Description	Allow the clinicians to enroll a new patient in the CAPABLE system. CN4
Preconditions	Patient fulfills the clinical inclusion criteria and he/she presents in the EHR of the hospital.
Post Conditions	Patient is enrolled in the system, patient data is stored into the Capable Data Platform, Capable ID is created and stored in the Capable Data Platform.
Course of action	The physician will search the EHR of the hospital by entering an internal unique identifier (e.g. tax code or internal ID) in order to find the patient to enroll. The corresponding data will be copied in the Capable Data Platform - this operation does not happen real-time during the enrollment. The physician will be notified about the result of the import and the Capable ID is assigned. The Capable ID is shown in the interface and ready to be used for the smartphone activation (Req. 1.2).
Alternate course A	If the patient is not present in the EHR, a message error is shown.
Alternate course B	
Alternate course C	
Component dependency	Physician application, Data Platform, Case Manager, Hospital her
Planned delivery	M30
Responsible partners	BITSENS, ICSM, NKI, UNIPV
Links to the mock-up	<p>Log in page:  <a href="https://projects.invisionapp.com/share/GUX2BJUR8C4#/screens">https://projects.invisionapp.com/share/GUX2BJUR8C4#/screens</a>                      Enrollment, mandatory fields:  <a href="https://projects.invisionapp.com/share/GUX2BJUR8C4#/screens/461598018">https://projects.invisionapp.com/share/GUX2BJUR8C4#/screens/461598018</a>                      Completing Enrollment, inputting non-mandatory fields:  <a href="https://projects.invisionapp.com/share/GUX2BJUR8C4#/screens/461598021">https://projects.invisionapp.com/share/GUX2BJUR8C4#/screens/461598021</a>                      Patient list, Maria's profile successfully created:  <a href="https://projects.invisionapp.com/share/GUX2BJUR8C4#/screens/461598278">https://projects.invisionapp.com/share/GUX2BJUR8C4#/screens/461598278</a></p>



Sign In

EMAIL  
john.fogg@email.com

PASSWORD  
\*\*\*\*\*

Remember me [Forgot password](#)

SIGN IN

Figure 5.9.1 Login Page

Name, Id, ...

ID	NAME, SURNAME	CANCER STATUS	TREATMENT	ADVERSE EVENTS	STATUS
890438	Maria Floss	stable	Treatment title	<side effects>	Action Needed!
947474	Felix Cruase	progression	Therapy	Skin rash	<Status>
890438	Susanna Gerra	stable	Treatment title	Diarrhea	<Status>
947474	Arina Rotterman	remission	Treatment title	Diarrhea	<Status>
890438	Anna Boti	stable	Treatment title	<side effects>	<Status>
947474	Gustavo Rude	remission	Treatment title	<side effects>	<Status>
890438	Alex Ro	stable	Treatment title	<side effects>	Action Needed!
947474	Jamed Collins	remission	Treatment title	<side effects>	<Status>
890438	Felicia Rose	stable	Treatment title	<side effects>	<Status>
890438	Maria De Rossi	stable	Treatment title	<side effects>	new
999998	Maria Rossi	stable	Treatment title	<side effects>	new

Figure 5.9.2 Enrolment/Adding a new Patient.

← Registration date: May 29, 2020  
Create New Patient Profile

General information

<input type="text" value="Name"/>	<input type="text" value="Surname"/>
Gender <input type="text" value="Select"/>	Email <input type="text" value="sample@gmail.com"/>

CREATE PROFILE

Figure 5.9.3 Enrolment/Adding a new Patient - mandatory fields that are needed by the CAPABLE system to create a profile.

← Registration date: May 29, 2020  
Create New Patient Profile

General information

<small>NAME</small> <input type="text" value="Maria"/>	<small>SURNAME</small> <input type="text" value="Rossi"/>
Gender <input type="text" value="Female"/>	Email <input type="text" value="maria.rossi@gmail.com"/>

CREATE PROFILE

Figure 5.9.4 Enrolment/Adding a new Patient - mandatory fields that are needed by the CAPABLE system to create profile are filled - Create profile button is activated.

**CAPABLE for Doctors** John Fogg

Name, Id, ...

ID	NAME, SURNAME	CANCER STATUS	TREATMENT	ADVERSE EVENTS	STATUS
890438	Maria Floss	stable	Treatment title	<side effects>	Action Needed!
947474	Felix Cruase	progression	Therapy	Skin rash	<Status>
890438	Susanna Gerra	stable	Treatment title	Diarrhea	<Status>
947474	Arina Rotterman	remission	Treatment title	Diarrhea	<Status>
890438	Anna Boti	stable	Treatment title	<side effects>	<Status>
947474	Gustavo Rude	remission	Treatment title	<side effects>	<Status>
890438	Alex Ro	stable	Treatment title	<side effects>	Action Needed!
947474	Jamed Collins	remission	Treatment title	<side effects>	<Status>
890438	Felicia Rose	stable	Treatment title	<side effects>	<Status>
890438	Maria De Rossi	stable	Treatment title	<side effects>	new
999998	Maria Rossi	stable	Treatment title	<side effects>	new

Profile successfully created

50 items per page

Figure 5.9.5 Enrolment/Adding a new Patient - successful message that profile in Data Platform is created.

ID: 999998  
**Maria Rossi**  
 1954 Nov 11 (67 y.o)

Treatment for cancer

**Systemic therapy**  
None

**Surgery**  
None

**Radiotherapy**  
None

---

Treatment for comorbidities  
None

---

Treatment of adverse events  
None

Figure 5.9.6 Enrolment/Adding a new Patient - possibility to continue enrollment through patients profile.

Registration date: May 29, 2020

← Create New Patient Profile

General information

NAME: Maria

SURNAME: Rossi

Gender: Female

Email: maria.rossi@gmail.com

**SEND EMAIL**

Date of birth: 1954, November, 11

Caucasian:  Yes  No

Phone number: +93 565 898 787

Sensor device ID: --

Weight: 62 kg

Height: 160 cm

BMI is 24.2, indicating the weight is in the **Normal** category for adults of such height.

---

**COMPLETE PROFILE** SAVE DRAFT

Figure 5.9.7 Enrolment/Adding a new Patient - information that is needed to fully complete enrollment. When the Patient receives the app, a physician can send an email with login information to Patient's email. If a physician has time - he can fulfill all the questionnaires during the same visit. If not - all the questionnaires will be available through Patient profile and can be fulfilled later on. The enrollment will not be complete without fulfilling all the questionnaires. A Patient receives the app installed on the additional mobile phone provided by CAPABLE during live visit with a physician. This happens after the first visit when a patient provides consent to participate in the study and signs all the documents.

### Caregiver Contacts

<small>NAME</small> <input type="text" value="Giulio"/>	<small>SURNAME</small> <input type="text" value="Rossi"/>
<small>Email</small> <input type="text" value="giulio.rossi@gmail.com"/>	<small>Phone number</small> <input type="text" value="+39..."/>

### Type of cancer

Choose type of cancer

### Physical activity

Do you perform regular physical activity ?

Yes
  No

How many times per week?

Activity duration

### Nutrition

Do you follow a particular diet?

COMPLETE PROFILE

SAVE DRAFT

Figure 5.9.8 Enrolment/Adding a new Patient - information that is needed to fully complete enrollment - Caregiver information, Cancer information, Physical activity questionnaire.

**Nutrition**

Do you follow a particular diet?

Other  Note for diet

Do you regularly eat fruit and vegetable?

Yes  No

Do you drink alcohol?

Yes  No

Do you have a history of alcohol abuse?

Yes  No

Have you recently lost weight without trying?

Yes  No  Unsure

How much weight have you lost?  Not selected

Have you been eating poorly because of a decreased appetite?

Yes  No

**MST is 0 – not at risk. Eating well with little or no weight loss**

If length of stay exceeds 7 days, then rescreen, repeating weekly as needed.

---

**Smoking**

Are you a smoker?

Never smoked

---

**Sleeping**

Do you have issue with sleeping?

Yes  No

COMPLETE PROFILE
SAVE DRAFT

Figure 5.9.9 Enrolment/Adding a new Patient - information that is needed to fully complete enrollment - Nutrition, Smoking questionnaires. MST is a Malnutrition Screening Tool - calculation of Indexes.

**Sleeping**

Do you have issue with sleeping?

Yes  No

---

**Past relevant information**

**Diabetes**

Yes  No

**Hypertension**

Yes  No

**Collagen vascular**

Yes  No

**IBD**

Yes  No

**Previous intestinal surgery**

Yes  No

COMPLETE PROFILE
SAVE DRAFT

Figure 5.9.10 Enrolment/Adding a new Patient - information that is needed to fully complete enrollment - Sleeping, Past relevant information - part of a clinical history of a patient that could be used by the CAPABLE guidelines.

Req. 1.2	Smartphone Activation
Description	Patient app is installed and activated (i.e. linked to specific patient in the data platform).
Preconditions	Patient is enrolled in the system and Capable ID assigned.
Post Conditions	The smartphone is activated and linked to the specific patient.
Course of action	The Capable patient ID on the data platform is linked to the app id installed on the smartphone.
Component dependency	Physician application, Data Platform, Case Manager, Patient App
Planned delivery	M30
Responsible partners	BITSENS, ICSM, NKI, UNIPV
Links to the mock-up	Completing Enrollment, inputting non-mandatory fields: <a href="https://projects.invisionapp.com/share/GUX2BJUR8C4#/screens/461598021">https://projects.invisionapp.com/share/GUX2BJUR8C4#/screens/461598021</a>

Req. 1.3	Caregiver Activation
Description	If the patient agrees to have a caregiver who can see and act on another instance of the smartphone app, a caregiver has to be assigned to the patient. A Patient provides caregiver's information during Enrollment visit. Also, he can update this info through a mobile app, and indicate tag that he/she allows his caregiver to use the app (through mobile app - Settings-Patient Profile). See figure 5.9.8 and Req. 5 Figures 4.7.71 - 4.7.72
Preconditions	Patient is enrolled in the system, Capable ID assigned, patient has a caregiver and agrees that the caregiver will be using the system.
Post Conditions	Caregiver is assigned and linked to the patient.
Course of action	The physician will enter the caregiver information (familiar relationship grade, if cohabitant, contact point) and the physician app will provide the information (login and password) to be entered for the caregiver activation in the smartphone application.
Alternate course A	
Alternate course B	
Alternate course C	
Component dependency	Physician application, Data Platform, Case Manager, Patient App
Planned delivery	M30
Responsible partners	BITSENS, ICSM, NKI, UNIPV

Links to the mock-up	Completing Enrollment, inputting non-mandatory fields: <a href="https://projects.invisionapp.com/share/GUX2BJUR8C4#/screens/461598021">https://projects.invisionapp.com/share/GUX2BJUR8C4#/screens/461598021</a>
Req. 1.4	<p><b>Setup of Patient Profile</b></p> <p>This information will be gathered during Enrollment, only once and will not be available further. QoL Assessment will be made on paper during the live visit.</p>
Description	Physician will enter a set of essential preliminary data (e.g. quality of life, and nutrition) needed by the capable system and that could not be imported by EHR.
Preconditions	Patient is enrolled in the system and Capable ID assigned.
Post Conditions	Patient profile is defined and the essential data are stored in the Capable Data Platform.
Course of action	The physician will perform an interview with the patient to define his/her profile (marital status, education, diet, occupation, smoke/alcohol consumption, literacy level, physical activity, sleep issues). This action is needed to initialize the Capable DSS.
Alternate course A	<p>The physician will enter the patient profile data by filling:</p> <ul style="list-style-type: none"> <li>• Nutritional Assessment (Req. 1.4.1)</li> <li>• QoL Assessment (Req. 1.4.2)</li> <li>• Psychological Assessment (Req. 1.4.3)</li> </ul>
Alternate course B	
Alternate course C	
Component dependency	Physician application, Data Platform, Case Manager
Planned delivery	M30
Responsible partners	BITSENS, ICSM, NKI, UNIPV
Links to the mock-up	Completing Enrollment, inputting non-mandatory fields: <a href="https://projects.invisionapp.com/share/GUX2BJUR8C4#/screens/461598021">https://projects.invisionapp.com/share/GUX2BJUR8C4#/screens/461598021</a>

Screens are shown below requirements 1.4.1 and 1.4.2

Req. 1.4.1	<b>Nutritional Assessment</b>
Description	Physician will administer the malnutrition screening tool (MST) Questionnaires.
Preconditions	Patient is enrolled in the system and Capable ID assigned.
Post Conditions	MST result stored in the Data Platform.



Course of action	The physician fills in the MST nutrition questionnaire with the patient. This action is needed to identify nutritional issues and the following interventions.
Alternate course A	MST < 2 (no nutritional issues) - periodic filling of the MST questionnaire by the patient through the app is expected
Alternate course B	MST >= 2 (nutritional issues) - the nutritionist performs NRS2002 and further tests, and from the results of these tests it is decided whether to perform a specialist visit or wait three months for a further execution of the MST questionnaire. If the questionnaire still highlights the nutritional problem, the clinician will request a follow-up visit.
Alternate course C	
Component dependency	Physician application, Data Platform, Case Manager
Planned delivery	M30
Responsible partners	BITSENS, ICSM, NKI, UNIPV
Links to the mock-up	Completing Enrollment, inputting non-mandatory fields: <a href="https://projects.invisionapp.com/share/GUX2BJUR8C4#/screens/461598021">https://projects.invisionapp.com/share/GUX2BJUR8C4#/screens/461598021</a>

< 30 min

**Nutrition**

Do you follow a particular diet?

Other

Do you regularly eat fruit and vegetable?

Yes  No

Do you drink alcohol?

Yes  No

Do you have a history of alcohol abuse?

Yes  No

Have you recently lost weight without trying?

Yes  No  Unsure

How much weight have you lost?

Have you been eating poorly because of a decreased appetite?

Yes  No

**MST is 0 – not at risk. Eating well with little or no weight loss**

If length of stay exceeds 7 days, then rescreen, repeating weekly as needed.

**COMPLETE PROFILE** SAVE DRAFT

Figure 5.9.11 Enrolment/Adding a new Patient – Questionnaires –Nutrition. MST is a Malnutrition Screening Tool - calculation of Indexes.

Req. 1.5	Telemonitoring Routine Co-creation
Description	<p>Allow the clinicians, in shared decision-making with the patient, to define the clinical goals and associate them with care management actions (monitoring, prevention, treatment requests, capsules).</p> <p><b>CN3</b></p> <p>This may include not only the oncology treatment but also life style recommendations of exercise and psychological wellbeing virtual capsules, nutrition support, thus aiding in <b>CN5</b> – coordination of specialties.</p>
Preconditions	The patient’s data has been imported and the patient’s profile has been defined
Post Conditions	Clinical goals defined for all patient’s conditions. Clinical goals have been associated with care management actions (including capsules)
Course of action	Activation of decision-support services Req. 2.2 and Patient Req. 4 for capsules for all active Conditions in the patient’s profile. This will result in generating the goals such that all conditions in the profile for which decision-support is available are associated with goals and with treatment requests.
Component dependency	Physician App, Virtual Coach, Data Platform
Planned delivery	M30
Responsible partners	BITSENS
Links to the mock-up	<p>Patient Profile, Treatment tab with recommendations:  <a href="https://projects.invisionapp.com/share/GUX2BJUR8C4#/screens/449308838">https://projects.invisionapp.com/share/GUX2BJUR8C4#/screens/449308838</a></p> <p>Patient Profile, Achievements tab:  <a href="https://projects.invisionapp.com/share/GUX2BJUR8C4#/screens/461181079">https://projects.invisionapp.com/share/GUX2BJUR8C4#/screens/461181079</a></p>

Other treatment

St. John's-wort 300 mg/1 day (23 March 2017)  
 Depressive disorder

EDIT

Goals & Activities

Goals      Activities

General goals

Physical Wellbeing

Tai Chi, Yoga, My Usual walk



Up to Patient (default)



Prescribed (by physician)



Contraindicated (by physician)

Mental Wellbeing

Tai Chi, Yoga, My Usual walk, Breathing Exercise, Imagery Training, Garder bowl, PhotoVoice, Vase of gratitude



Up to Patient (default)



Prescribed (by physician)



Contraindicated (by physician)

Specific goals

Sleep Improvement

Tai Chi, Yoga, My Usual walk, Breathing Exercise, Imagery Training



Up to Patient (default)



Prescribed (by physician)



Contraindicated (by physician)

Accepting Cancer Journey

Garder bowl, PhotoVoice



Up to Patient (default)



Prescribed (by physician)



Contraindicated (by physician)

Nutrition

Educational materials



Up to Patient (default)



Prescribed (by physician)



Contraindicated (by physician)

PD-1 blockade or PD-1 and ipilimumab are now a standard of care for all patients, regardless of their BRAF status, in the first-line setting.

**Nivolumab 3 mg/kg IV q3Weeks  
 Ipilimumab 1 mg/kg IV on the same day for 4 doses**

PD-1 blockade or PD-1 and ipilimumab are now a standard of care for all patients, regardless of their BRAF status, in the first-line setting.

REVIEW

**Treatment of Diarrhea**

**Loratadine 10 mg tablet, once daily  
 Topical emollient  
 Corticosteroid cream (mild strength)**

After 48 hours, in case of absence of efficacy of loperamide, administration of other drugs should be considered.

REVIEW

Figure 5.9.12 Patients Profile – Treatment tab –Goals and Activities section. List of Goals where each Goal has associated Activities (called Capsules) and three possible statuses – Up to Patient(indicated by Default), Prescribed (by physician) and Contraindicated (by Physician).

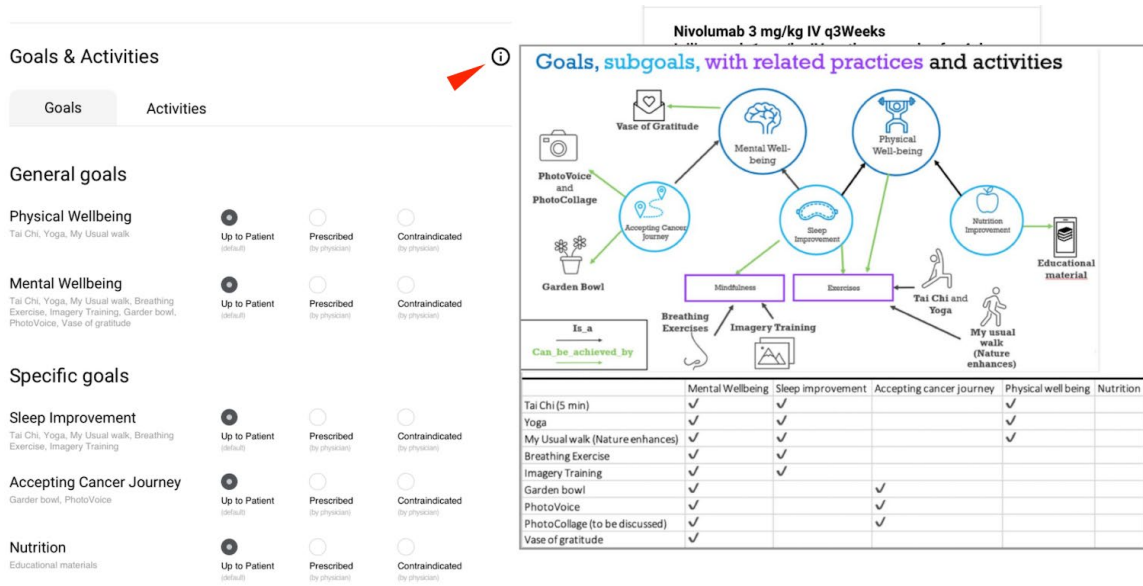


Figure 5.9.13 Patients Profile – Treatment tab –Goals and Activities section. The “i” button gives visual explanation to Goals connections and associated Activities.

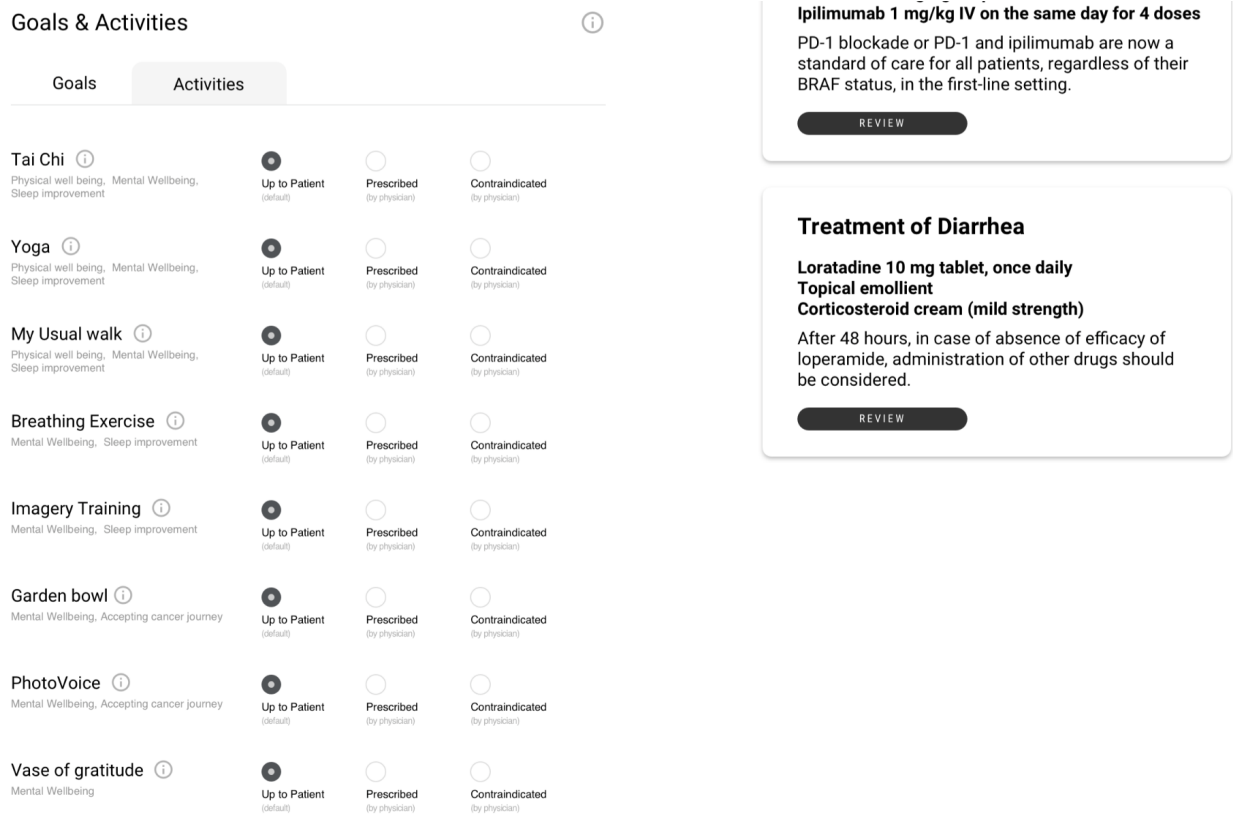


Figure 5.9.14 Patients Profile – Treatment tab –Goals and Activities section. List of Activities (called Capsules) where each Activity has associated Goals and three possible statuses – Up to Patient (indicated by Default), Prescribed (by physician) and Contraindicated (by Physician). If no Goal is Contraindicated the full list of Activities is available.

Req. 2	Physician application – List Patients
Description	List of all patients enrolled in the CAPABLE system with the ability to view /edit data <b>CNI</b>
Preconditions	The physician is logged-in into the physician app
Post Conditions	A list of enrolled patients belonging to the center of the physician is shown.
Course of action	The table contains the following information: Name, Surname, Age, Enrolment Date, Last app use, overall user’s status (using traffic-light codes). The physician can select a patient from the list to overview the specific data (Req 2.2-Overview Patient)
Alternate course A	Order the patient list (Req 2.1-Order Patient List) The physician can order the table according to the available columns and change the paging option (e.g by default 25 patients are shown, but user can change).
Alternate course B	Search for a particular patient (Req 2.1.2-Search Patient). The health professional types names or surname and the autocomplete functionality suggests a patient from the list. When the desired patient appears in the list the health professional can click on it to overview the specific subject’s data. (Req 2.2-Overview Patient)
Alternate course C	According to use case structure the health professional will be also able to go to the recommendation page or to the process of enrolment of a new patient.
Component dependency	Physician application, Data Platform, Case Manager
Planned delivery	M30
Responsible partners	BITSENS, Biomeris, UNIPV
Links to the mock-up	Patient list: <a href="https://projects.invisionapp.com/share/GUX2BJUR8C4#/screens/415504251">https://projects.invisionapp.com/share/GUX2BJUR8C4#/screens/415504251</a>

ID	NAME, SURNAME	CANCER STATUS	TREATMENT	ADVERSE EVENTS	STATUS
890438	Maria Floss	stable	Treatment title	<side effects>	Action Needed!
947474	Felix Cruase	progression	Therapy	Skin rash	<Status>
890438	Susanna Gerra	stable	Treatment title	Diarhea	<Status>
947474	Arina Rotterman	remission	Treatment title	Diarhea	<Status>
890438	Anna Boti	stable	Treatment title	<side effects>	<Status>
947474	Gustavo Rude	remission	Treatment title	<side effects>	<Status>
890438	Alex Ro	stable	Treatment title	<side effects>	Action Needed!
947474	Jamed Collins	remission	Treatment title	<side effects>	<Status>
890438	Felicia Rose	stable	Treatment title	<side effects>	<Status>
999998	Maria Rossi	stable	Treatment title	<side effects>	<Status>
890438	Maria De Rossi	stable	Treatment title	<side effects>	new

Figure 5.9.15 List of patients with possibility to filter the patients

Req. 2.1 Order or Search patient List

Req. 2.1.1	Physician application – Order Patient List
Description	Capable system patient list ordered
Preconditions	The physician is logged-in into the physician app
Post Conditions	An ordered list of patients belonging to the center of the physician is shown.
Course of action	By clicking on the column header, physicians can sort the patient list in ascending (a-z) or descending (z-a) way.
Alternate course A	The physician can order the table by clicking on any of the table headers (e.g Name, Surname, Enrolment Date Last app use, Overall user’s status). The physician can select a patient from the list to overview the specific data (Req 2.2-Overview Patient)
Alternate course B	Search for a particular patient (Req 2.1.2-Search Patient). The health professional types name or surname and the autocomplete functionality suggests a patient (the patients) from the list. When the desired patient appears in the list the health professional can click on it to overview the specific subject’s data. (Req 2.2-Overview Patient)

Component dependency	Physician application, Data Platform, Case Manager
Planned delivery	M30
Responsible partners	BITSENS, Biomeris, UNIPV
Links to the mock-up	Patient list, UI Design: <a href="https://projects.invisionapp.com/share/7W114K86D2XY#/screens">https://projects.invisionapp.com/share/7W114K86D2XY#/screens</a>

Filter

+ Add patient

ID	Name, Surname	Cancer status	Treatment	Adverse events	Status
890438	Maria Floss	Stable	Treatment	Adverse events	Action Needed!
947474	Felix Cruase	Progression	Treatment	Adverse events	<Status>
<Additional info about the patient might be placed here>					
890438	Susanna Gerra	Stable	Treatment	Diarrhea	New
947474	Arina Rotterman	Remission	Treatment	Diarrhea	<Status>
890438	Anna Boti	Stable	Treatment	Adverse events	<Status>
947474	Gustavo Rude	Remission	Treatment	Adverse events	<Status>
890438	Alex Ro	Stable	Treatment	Adverse events	Action Needed!
947474	Jamed Collins	Remission	Treatment	Adverse events	<Status>
890438	Felicia Rose	Stable	Treatment	Adverse events	<Status>
947474	Anna Boti	Remission	Treatment	Adverse events	<Status>

50 items per page

1
2
3
4
...
12

↑

Figure 5.9.16 List of patients with possibility to filter the patients - UI Design.

Req. 2.1.2	Physician application – Search Patient
Description	The physician can select a specific patient
Preconditions	Physician is viewing the patient list
Post Conditions	The list of patients (one or more) fulfilling the search criteria is displayed
Course of action	The physician types name or surname and the autocomplete functionality suggests the patient/s from the list. When the desired patient appears in the list the health professional can click

	on it to overview the specific subject’s data. (Req 2.2-Overview Patient)
Alternate course A	The physician enters the search criteria and the list of patients that satisfies them is shown.
Component dependency	Physician GUI, Data Platform, CASE manager
Planned delivery	TBD
Responsible partners	BITSENS, Biomeris, UNIPV
Links to the mock-up	Patient list: <a href="https://projects.invisionapp.com/share/GUX2BJUR8C4#/screens/415504251">https://projects.invisionapp.com/share/GUX2BJUR8C4#/screens/415504251</a>

Req 2.2	Physician application – Overview Patient - view and update
Description	The physician, after selecting the patient, can get an overview of the specific subject’s data - view and update <b>CNI</b>
Preconditions	A patient has been selected
Post Conditions	The overview of the patient is displayed allowing the physician to view the data, view the patient timeline or modify the data
Course of action	The patient overview allows access to patient data in both view and edit mode.
Alternate course A	The patient overview allows the physician to have a quick look at the patient situation (e.g. treatment, clinical history, measurements, etc) both through a timeline view and through links to edit data
Alternate course B	According to the use case structure the health professional will be also able to go to the recommendation page of the selected patient.
Component dependency	Physician application, Data Platform, Case Manager
Planned delivery	M30
Responsible partners	BITSENS, Biomeris, UNIPV
Links to the mock-up	Patient Profile, Treatment tab with recommendations: <a href="https://projects.invisionapp.com/share/GUX2BJUR8C4#/screens/446097477">https://projects.invisionapp.com/share/GUX2BJUR8C4#/screens/446097477</a>

### 2.2.1 Treatment Tab

Figure 5.9.17 Patients Profile gives an overview of patient’s Data. All the information is divided by tabs – Treatment, Measurement, Paste relevant information, Activity timeline, Questionnaire results, Symptoms, Lab tests, Achievements.

Figure 5.9.18 Patients Profile with Treatment tab has several sub sections divided by type of treatment - Treatment for cancer, Treatment for comorbidities, Treatment of adverse events, Other treatment.



ID: 890438  
**Maria De Rossi**  
 1944 Nov 10 (76 y.o.)

GUIDELINES | RUN PREDICTIVE MODEL | SCHEDULE NEXT VISIT | PRESCRIBE NEW TREATMENT | ...

Treatment | Measurement | Past relevant information | Activity timeline | Questionnaire results | Symptoms

Current | Past

**Treatment for cancer** [EDIT]

**Systemic therapy**  
 Sunitinib 50 mg/2 weeks, hospital admin. (12 December 2019)

**Surgery**  
 12 October 2018

**Radiotherapy**  
 12 December 2018 – 22 December 2018

**Treatment for comorbidities** [PRESCRIBED VIA EHR]  
 Levotyroxine (23 March 2017)  
 Hypothyroidism

**Treatment of adverse events** [PRESCRIBED VIA EHR]  
 Loperamide 4 mg/4 hours, As needed medication  
 Diarrhea

**Treatment of Diarrhea**  
**Uncomplicated diarrhea initial**  
 Initial management of mild to moderate diarrhea should include dietary modifications, such as avoiding all lactose-containing products and high-osmolar ... [REVIEW]

**Treatment of Diarrhea**  
**Consider other drugs**  
 After 48 hours, in case of absence of efficacy of loperamide, administration of other drugs should be considered. [REVIEW]

**Treatment of Cutaneous Melanoma**

**Patient status**

- Active
- Hospitalized
- Suspended for other reasons
- Drop out
- Completed the project
- Died

Figure 5.9.19 Patients Profile gives a possibility to change patients status to – Active, Hospitalized, Suspended for other reasons, Drop out, Completed the project, Died. In accordance with the status the System either will stop or actively send reminders and notifications.

ID: 890438  
**Maria De Rossi**  
 1944 Nov 10 (76 y.o.)

GUIDELINES | RUN PREDICTIVE MODEL | SCHEDULE NEXT VISIT | PRESCRIBE NEW TREATMENT | ...

Treatment | Measurement | Past relevant information | Activity timeline | Questionnaire results | Symptoms | Lab tests | Achievements

Current | Past

**Treatment for cancer**

**Systemic therapy**  
 Sunitinib 50 mg/2 weeks, hospital admin. (12 December 2019)

**Surgery**  
 12 October 2018

**Radiotherapy**  
 12 December 2018 – 22 December 2018

**Treatment for comorbidities** [PRESCRIBED VIA EHR]  
 Levotyroxine (23 March 2017)  
 Hypothyroidism

**Treatment of adverse events** [PRESCRIBED VIA EHR]  
 Loperamide 4 mg/4 hours, As needed medication  
 Diarrhea

**Treatment of Diarrhea**  
**Uncomplicated diarrhea initial**  
 Initial management of mild to moderate diarrhea should include dietary modifications, such as avoiding all lactose-containing products and high-osmolar ... [REVIEW]

**Treatment of Diarrhea**  
**Consider other drugs**  
 After 48 hours, in case of absence of efficacy of loperamide, administration of other drugs should be considered. [REVIEW]

**Treatment of Cutaneous Melanoma**

**Schedule next visit**

Date: [ ] Time: [ ]

Note (for e.g. if the patient have to bring urine samples)  
 Free text goes here

[+ ADD VISIT]

[ACCEPT] [DECLINE]

Figure 5.9.20 Patients Profile - Schedule next visit function.

ID: 890438  
**Maria De Rossi**  
 1944 Nov 10 (76 y.o)

GUIDELINES
**RUN PREDICTIVE MODEL**
SCHEDULE NEXT VISIT
PRESCRIBE NEW TREATMENT
...

Treatment
Measurement
Past relevant information
Activity timeline
Questionnaire results
Symptoms
Lab tests
Achievements

**Choose Predictive Model**

**Survival model**  
 Model for predicting Overall Survival (OS) for Melanoma patient treated with Immunotherapy. Predicted survival graphs will be presented for Nivolumab and Nivolumab+Ipilimumab.  
VIEW

**Response model**  
 Model for predicting response to the treatment for Melanoma patient treated with Immunotherapy. Predicted probabilities of having response will be presented for Nivolumab compared to Nivolumab+Ipilimumab.  
VIEW

**Treatment of Diarrhea**

**Consider other drugs**  
 After 48 hours, in case of absence of efficacy of loperamide, administration of other drugs should be considered.  
REVIEW

Figure 5.9.21 Patients Profile - Run predictive model function - a list of available models for a specific Patient.

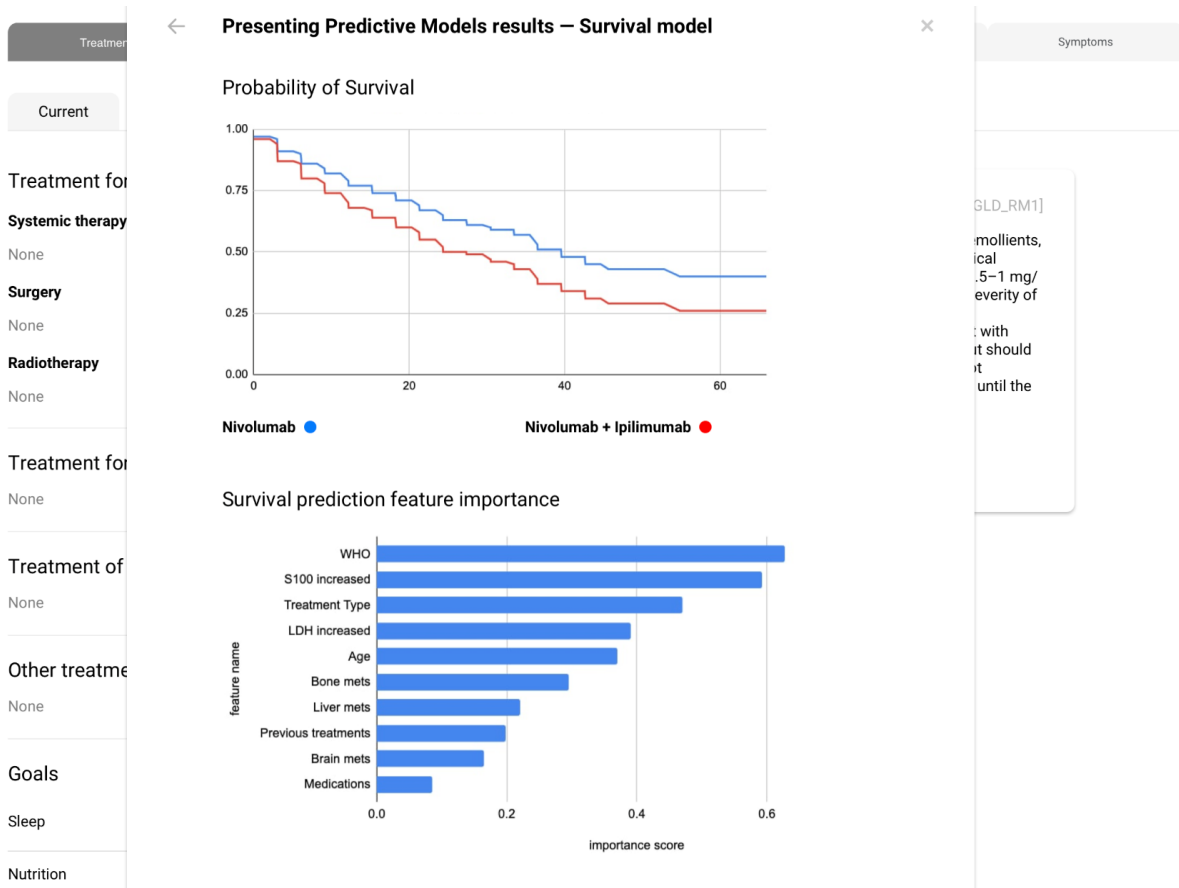


Figure 5.9.22 Patients Profile - Run predictive model function - Survival model.

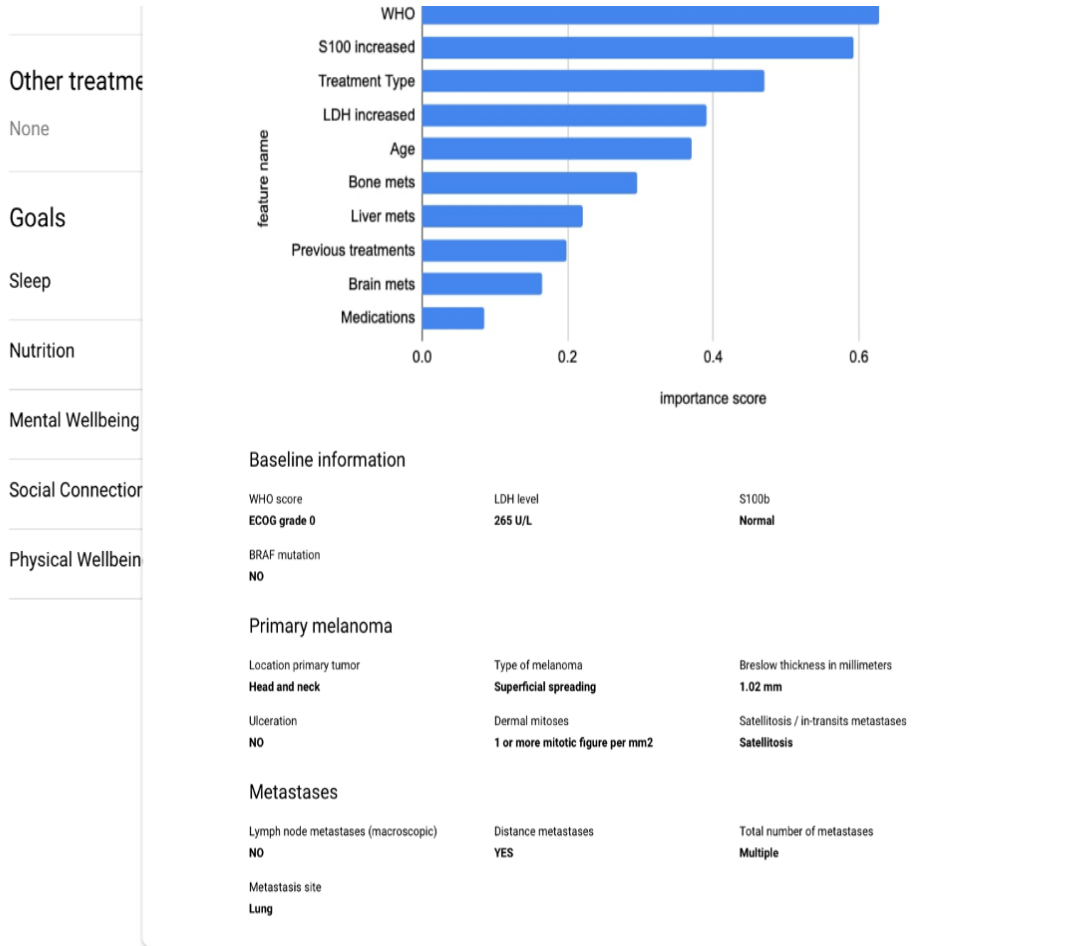


Figure 5.9.23 Patients Profile - Run predictive model function - Survival model.

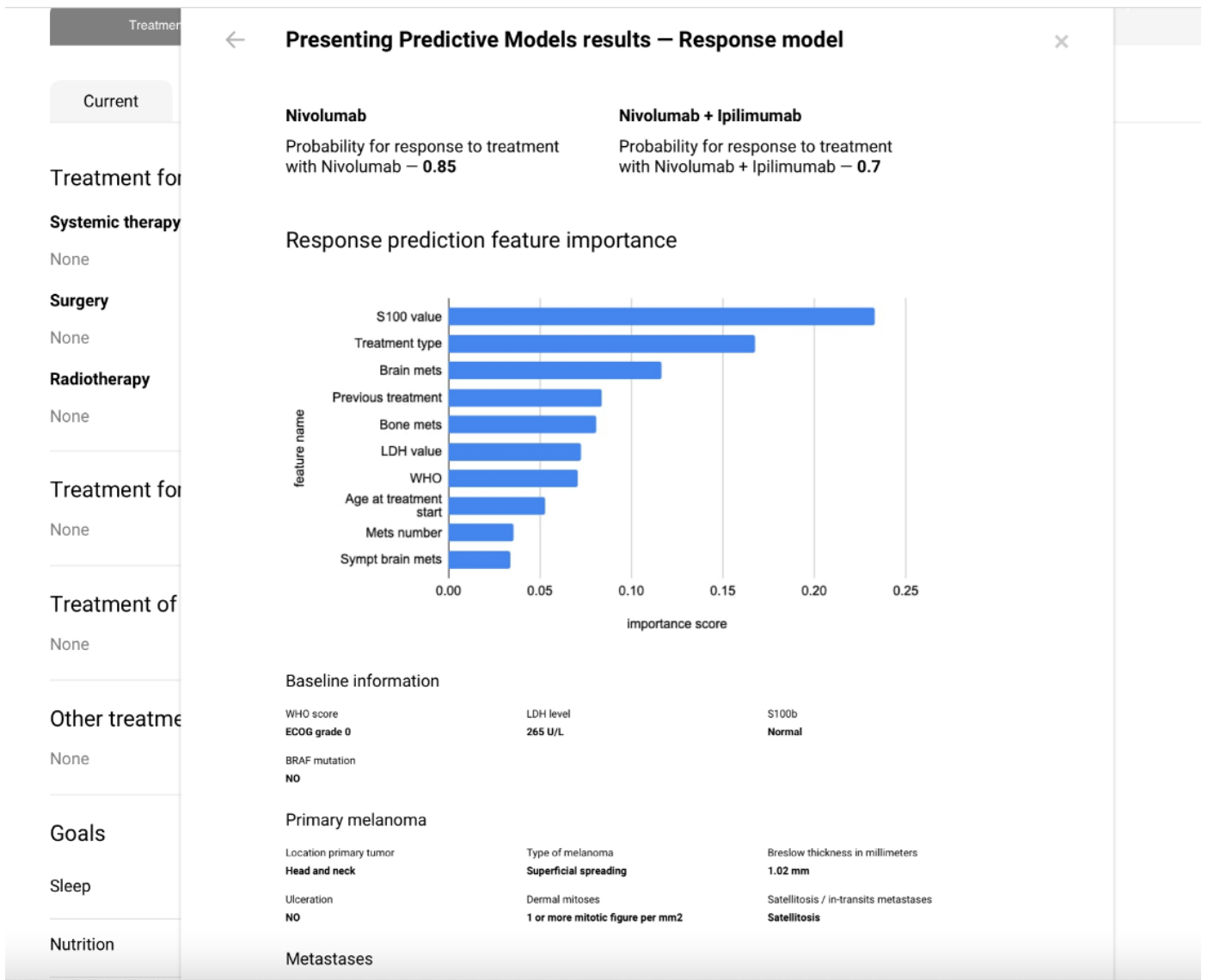


Figure 5.9.24 Patients Profile - Run predictive model function - Response model.

**2.2.1.1 Treatment Tab: Goal Setting**

Req. 2.2.1.1	View/Modify/Add wellbeing goals and activities
Description	<p>Allow the clinicians, in shared decision-making with the patient but without DSS Interactive mode of Req. 3, to choose the goals for the capsules and additionally choose activities that are associated with those goals. General goals associated with clinical treatment can be defined when prescribing a clinical treatment by setting the treatment type (e.g., “Treatment of Cancer”, see requirement 2.2.1.2) or when they are selected as part of a recommendation suggested by the system (e.g., “Treatment of Diarrhea”, see requirement 3.3).</p> <p>The physician enters the Patient Profile – Treatment tab and can see all the goals for the patient. The physician can select one of three options for each goal:</p> <ul style="list-style-type: none"> <li>● It will be up to the patient to follow it</li> <li>● The goal is prescribed</li> <li>● The goal is contraindicated</li> </ul> <p>The physician will also be able to access the “Activities” tab, which will contain all the activities associated with the goals. If a goal is contraindicated, the “Activities” tab will not show its associated activities. Once a goal is prescribed, the patient will be notified about their prescribed activities. If a goal was marked as “contraindicated”, its associated activities will not be available to the patient.</p>
Preconditions	The patient’s data has been imported and the patient’s profile has been defined.
Post Conditions	Capsule goals and activities are defined for the patient.
Course of action	
Component dependency	Physician application, Data Platform, Case Manager, Virtual Coach, GoCom
Planned delivery	M30
Responsible partners	BITSENS, Biomeris, UoH, Deontics
Links to the mock-up	<p>Patient Profile, Treatment tab with recommendations:</p> <p><a href="https://projects.invisionapp.com/share/GUX2BJUR8C4#/screens/446097477">https://projects.invisionapp.com/share/GUX2BJUR8C4#/screens/446097477</a></p>

### Other treatment

EDIT

St. John's-wort 300 mg/1 day (23 March 2017)  
Depressive disorder

---

### Goals & Activities

ⓘ

Goals

Activities

---

#### General goals

<p><b>Physical Wellbeing</b> Tai Chi, Yoga, My Usual walk</p>	<input type="radio"/> Up to Patient <small>(default)</small>	<input type="radio"/> Prescribed <small>(by physician)</small>	<input checked="" type="radio"/> Contraindicated <small>(by physician)</small>
<p><b>Mental Wellbeing</b> Tai Chi, Yoga, My Usual walk, Breathing Exercise, Imagery Training, Garder bowl, PhotoVoice, Vase of gratitude</p>	<input checked="" type="radio"/> Up to Patient <small>(default)</small>	<input type="radio"/> Prescribed <small>(by physician)</small>	<input type="radio"/> Contraindicated <small>(by physician)</small>

#### Specific goals

<p><b>Sleep Improvement</b> Tai Chi, Yoga, My Usual walk, Breathing Exercise, Imagery Training</p>	<input type="radio"/> Up to Patient <small>(default)</small>	<input checked="" type="radio"/> Prescribed <small>(by physician)</small>	<input type="radio"/> Contraindicated <small>(by physician)</small>
<p><b>Accepting Cancer Journey</b> Garder bowl, PhotoVoice</p>	<input checked="" type="radio"/> Up to Patient <small>(default)</small>	<input type="radio"/> Prescribed <small>(by physician)</small>	<input type="radio"/> Contraindicated <small>(by physician)</small>
<p><b>Nutrition</b> Educational materials</p>	<input checked="" type="radio"/> Up to Patient <small>(default)</small>	<input type="radio"/> Prescribed <small>(by physician)</small>	<input type="radio"/> Contraindicated <small>(by physician)</small>

Figure 5.9.25 Patients Profile – Treatment tab – indicating different options for each Goal will modify the list of Activities. After prescribing a Goal a Patient will receive a notification about prescribed Activities. If a Goal is Contraindicated a Patient will not be able to access all contraindicated activities.

## Other treatment

EDIT

St. John's-wort 300 mg/1 day (23 March 2017)

Depressive disorder

### Goals & Activities i

Goals

Activities

#### Breathing Exercise i

Mental Wellbeing, Sleep improvement



Up to Patient  
(default)



Prescribed  
(by physician)



Contraindicated  
(by physician)

#### Imagery Training i

Mental Wellbeing, Sleep improvement



Up to Patient  
(default)



Prescribed  
(by physician)



Contraindicated  
(by physician)

#### Garden bowl i

Mental Wellbeing, Accepting cancer journey



Up to Patient  
(default)



Prescribed  
(by physician)



Contraindicated  
(by physician)

#### PhotoVoice i

Mental Wellbeing, Accepting cancer journey



Up to Patient  
(default)



Prescribed  
(by physician)



Contraindicated  
(by physician)

#### Vase of gratitude i

Mental Wellbeing



Up to Patient  
(default)



Prescribed  
(by physician)

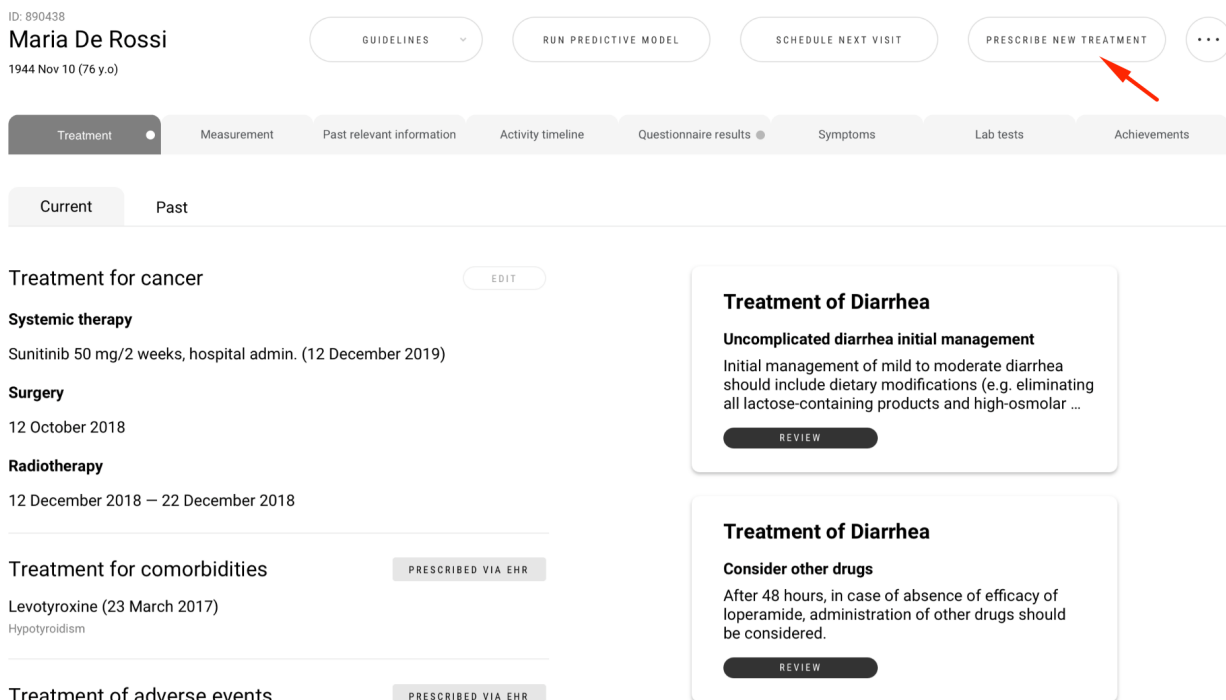


Contraindicated  
(by physician)

Figure 5.9.26 Patients Profile – Treatment tab – Shortened list of Activities due to contraindication of a Goal.

Req 2.2.1.2	Physician application – Modify/Add treatment with reference to condition and goal
Description	<p>Order a new treatment for the patient or modify an existing one.</p> <p>The physician must fill out all following fields:</p> <ul style="list-style-type: none"> <li>• Treatment goal (treatment for cancer/treatment for comorbidities/treatment for adverse event/other treatment)</li> <li>• Treatment: active principle (choose from a list), dose, administration options</li> <li>• Start date and end date</li> <li>• Prescribed by (automatically according to the user that is logged in)</li> </ul>

Preconditions	The treatment list is displayed or the physician requested to modify the patient data
Post Conditions	A new treatment is ordered (Medication request object stored in the Data Platform)
Course of action	Physician selects a new treatment from a list and confirms the order
Alternate course A	Physician cancels the new treatment order
Alternate course B	
Component dependency	Physician application, Data Platform, GoCom, Deontics engine, Case Manager, Virtual Coach
Planned delivery	M30
Responsible partners	BITSENS, Biomeris, UoH, Deontics
Links to the mock-up	<p>Patient Profile, Treatment tab with recommendations:  <a href="https://projects.invisionapp.com/share/GUX2BJUR8C4#/screens/446097477">https://projects.invisionapp.com/share/GUX2BJUR8C4#/screens/446097477</a></p> <p>Prescription of a new treatment:  <a href="https://projects.invisionapp.com/share/GUX2BJUR8C4#/screens/456576414">https://projects.invisionapp.com/share/GUX2BJUR8C4#/screens/456576414</a></p>



The screenshot shows a patient profile for Maria De Rossi (ID: 890438, 1944 Nov 10 (76 y.o.)). The interface includes several action buttons: GUIDELINES, RUN PREDICTIVE MODEL, SCHEDULE NEXT VISIT, and PRESCRIBE NEW TREATMENT (highlighted with a red arrow). Below these are tabs for Treatment, Measurement, Past relevant information, Activity timeline, Questionnaire results, Symptoms, Lab tests, and Achievements. The 'Treatment' tab is active, showing a list of treatments: 'Treatment for cancer' (Systemic therapy: Sunitinib 50 mg/2 weeks, hospital admin. (12 December 2019); Surgery: 12 October 2018; Radiotherapy: 12 December 2018 – 22 December 2018), 'Treatment for comorbidities' (Levotyroxine (23 March 2017) Hypothyroidism), and 'Treatment of adverse events'. On the right, there are two informational cards for 'Treatment of Diarrhea', one for 'Uncomplicated diarrhea initial management' and another for 'Consider other drugs', both with 'REVIEW' buttons.

Figure 5.9.27 Patients Profile – Treatment tab – treatment prescription.



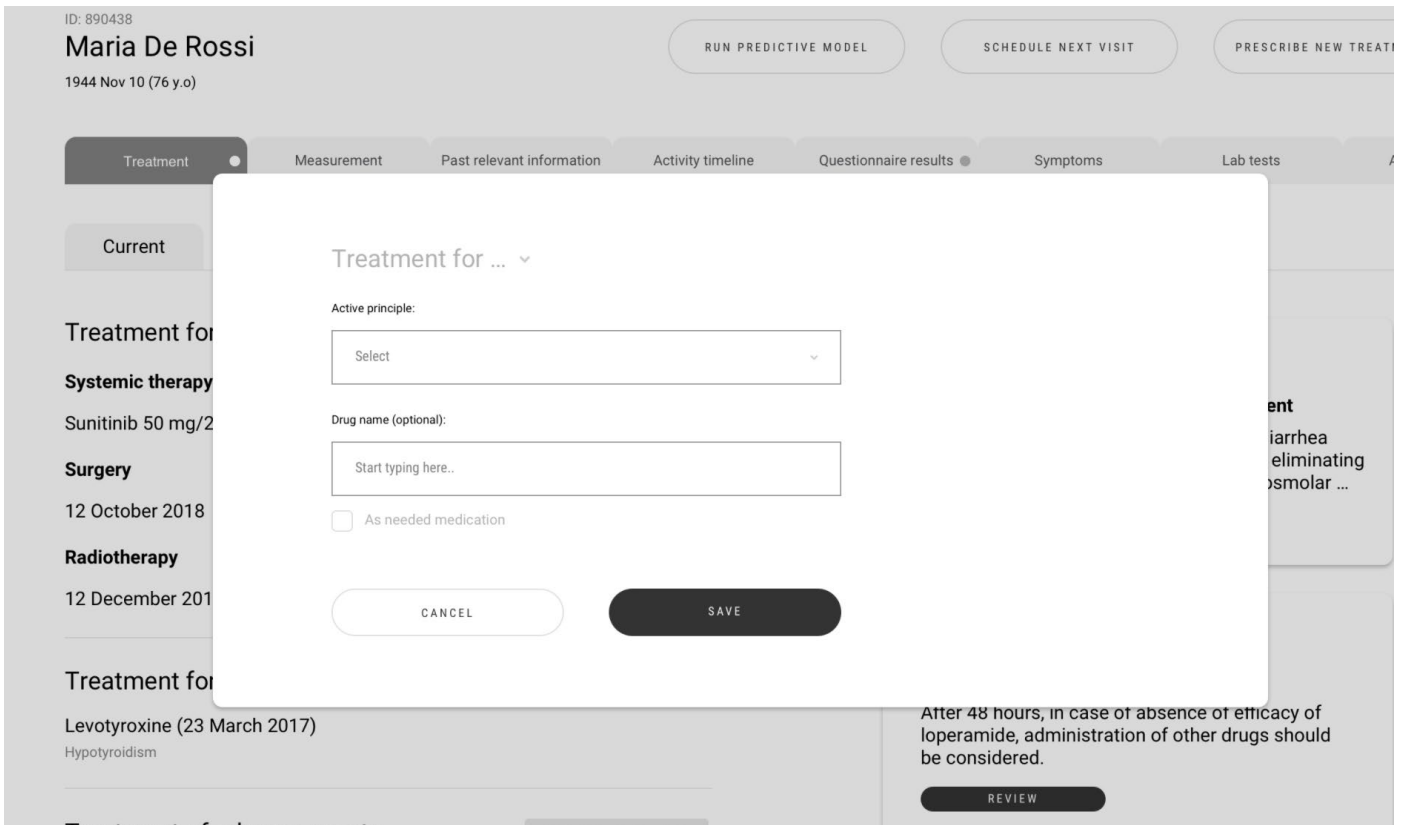


Figure 5.9.28 Patients Profile – Treatment tab – treatment prescription

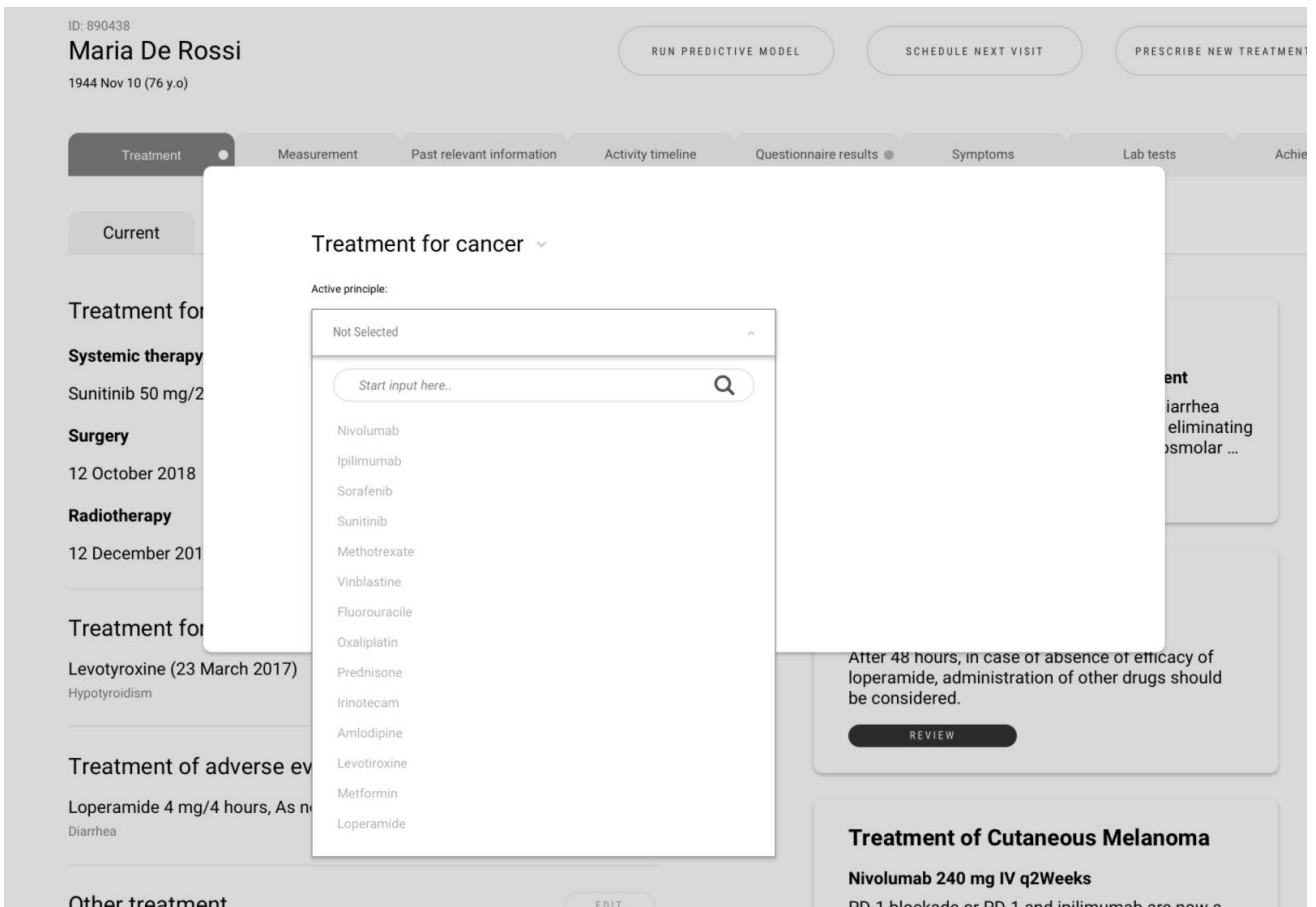
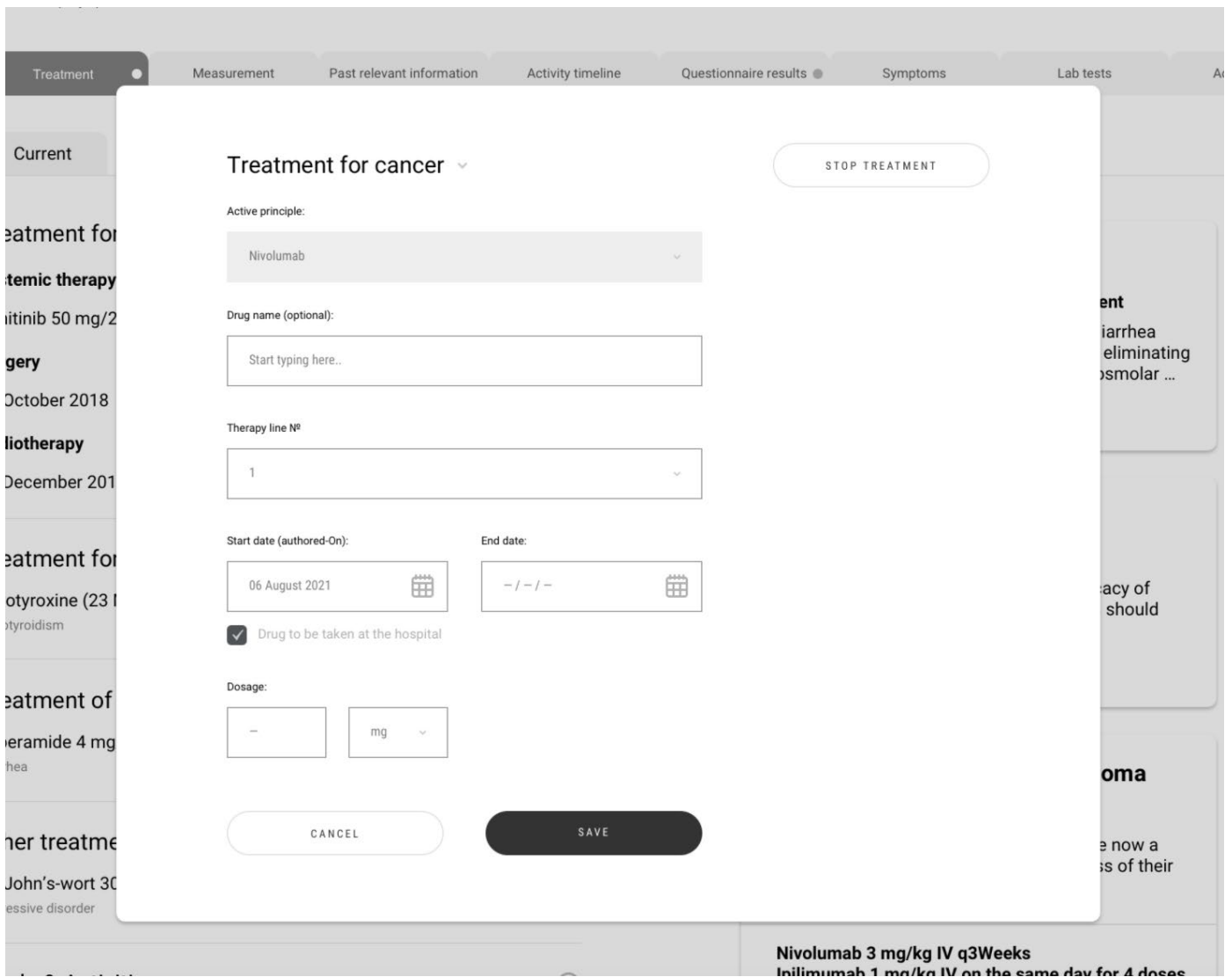


Figure 5.9.29 Patients Profile – Treatment tab – treatment prescription – indication of a treatment goal.



The screenshot shows a web interface for a patient's profile, specifically the 'Treatment' tab. A modal window titled 'Treatment for cancer' is open, allowing for the prescription of a new treatment. The form includes the following fields and options:

- Active principle:** A dropdown menu with 'Nivolumab' selected.
- Drug name (optional):** A text input field with the placeholder 'Start typing here..'
- Therapy line N°:** A dropdown menu with '1' selected.
- Start date (authored-On):** A date picker showing '06 August 2021'.
- End date:** A date picker showing '---/--/---'.
- Drug to be taken at the hospital:** A checked checkbox.
- Dosage:** A text input field with a hyphen '-' and a unit dropdown menu with 'mg' selected.

At the top right of the modal is a 'STOP TREATMENT' button, and at the bottom are 'CANCEL' and 'SAVE' buttons. The background shows a list of treatments, with the current one being 'Nivolumab 3 mg/kg IV q3Weeks'.

Figure 5.9.30 Patients Profile – Treatment tab – treatment prescription – example of a treatment for drugs to be taken at the hospital.

**Maria De Rossi**  
1944 Nov 10 (76 y.o)

RUN PREDICTIVE MODEL    SCHEDULE NEXT VISIT    PRESCRIBE NEW TREATMENT

Treatment    Measurement    Past relevant information    Activity timeline    Questionnaire results    Symptoms

Current    Past

**Treatment for cancer**

**Systemic therapy**  
Nivolumab at the hospital (06 August 2021)

**Surgery**  
None

**Radiotherapy**  
None

---

**Treatment for comorbidities**  
None

---

**Treatment of adverse events**  
None

---

**Other treatment**  
None

Figure 5.9.31 Patients Profile – Treatment tab – result of a cancer treatment prescription.

**Surgery**

1st surgery

Date: 12 October 2018    Intervention type: Free text goes here

+ ADD SURGERY

**Radiotherapy**

1st radiotherapy

Start date: 12 December 2018    End date: 22 December 2018

Total dose (Gy): --    Site: Not Selected

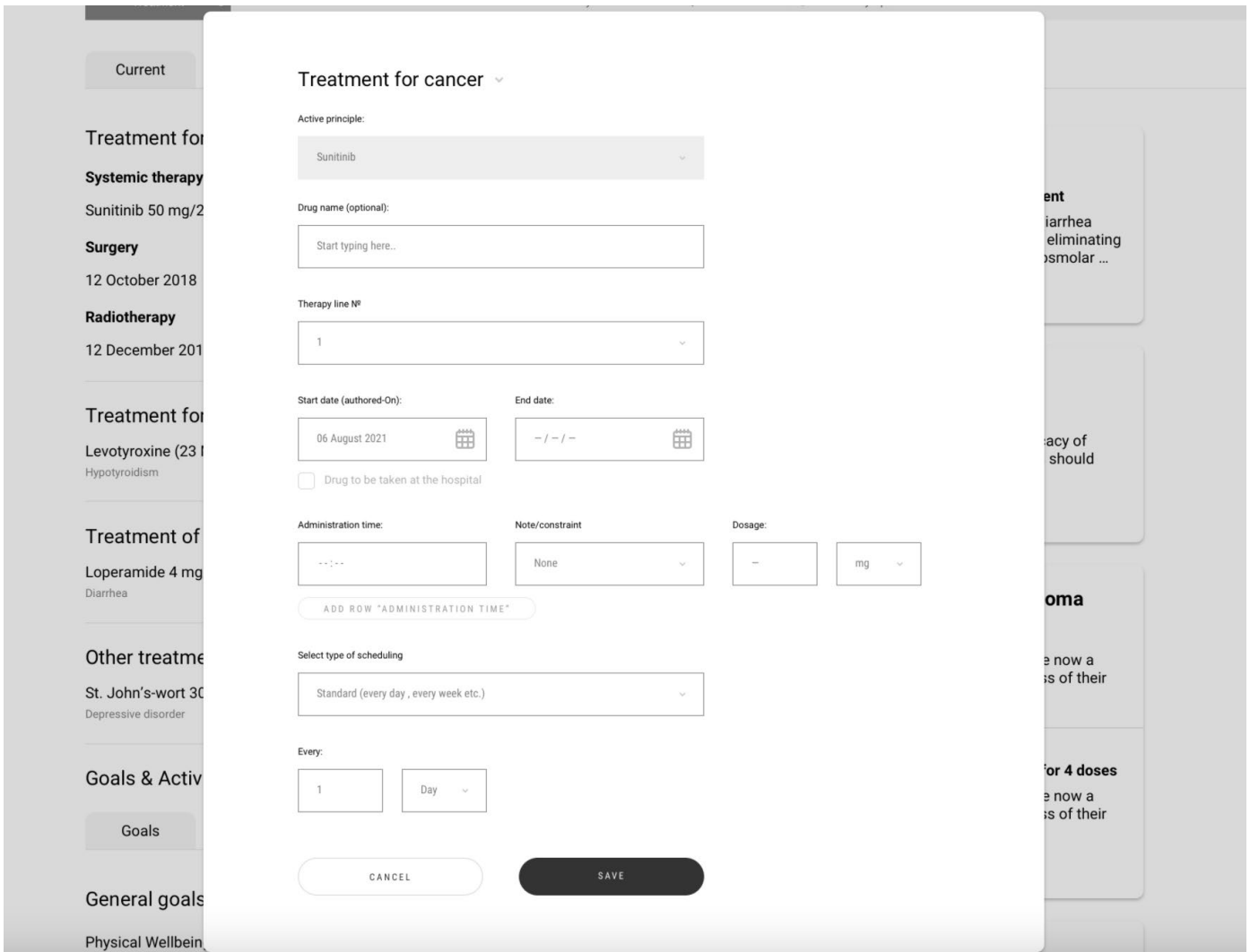
- Bones
- Lungs
- Brain
- Soft tissues
- Nodes
- Other

**Treatment for comorbidities**

Levotyroxine (23 March 2017)  
Hypothyroidism

**Treatment of adverse events**  
None

Figure 5.9.32 Patients Profile - Treatment tab – indication information about Surgery and inputting of a Radiotherapy information associated with Cancer treatment.



The screenshot shows a modal form titled "Treatment for cancer" with a dropdown arrow. The form contains the following fields and options:

- Active principle:** A dropdown menu with "Sunitinib" selected.
- Drug name (optional):** A text input field with the placeholder "Start typing here..".
- Therapy line N°:** A dropdown menu with "1" selected.
- Start date (authored-On):** A date picker showing "06 August 2021".
- End date:** A date picker showing "--/--".
- Drug to be taken at the hospital**
- Administration time:** A time input field showing "--:--".
- Note/constraint:** A dropdown menu with "None" selected.
- Dosage:** A text input field showing "-" and a unit dropdown menu with "mg" selected.
- ADD ROW "ADMINISTRATION TIME"** button
- Select type of scheduling:** A dropdown menu with "Standard (every day , every week etc.)" selected.
- Every:** A text input field with "1" and a unit dropdown menu with "Day" selected.
- CANCEL** and **SAVE** buttons at the bottom.

Figure 5.9.33 Patients Profile - Treatment tab – example of possible administration options.

Current

Treatment for  
**Systemic therapy**  
Sunitinib 50 mg/2

**Surgery**  
12 October 2018

**Radiotherapy**  
12 December 201

---

Treatment for  
Levotyroxine (23 f  
Hypothyroidism

Treatment of  
Loperamide 4 mg  
Diarrhea

Other treatme  
St. John's-wort 30  
Depressive disorder

Goals & Activ  
Goals



General goals  
Physical Wellbein  
Tai Chi, Yoga, My Usual wa

### Treatment for cancer ▼

Active principle:  
Sunitinib ▼

Drug name (optional):

Therapy line N°

Start date (authored-On):   End date:  

Drug to be taken at the hospital

Administration time: <input type="text" value="08:00"/>	Note/constraint <input type="text" value="None"/>	Dosage: <input type="text" value="5"/> <input type="text" value="mg"/>
Administration time: <input type="text" value="--:--"/>	Note/constraint <input type="text" value="None"/>	Dosage: <input type="text" value="-"/> <input type="text" value="mg"/>

ADD ROW "ADMINISTRATION TIME"

Select type of scheduling

Every:

ent  
diarrhea  
eliminating  
osmolar ...

---

acy of  
should

---

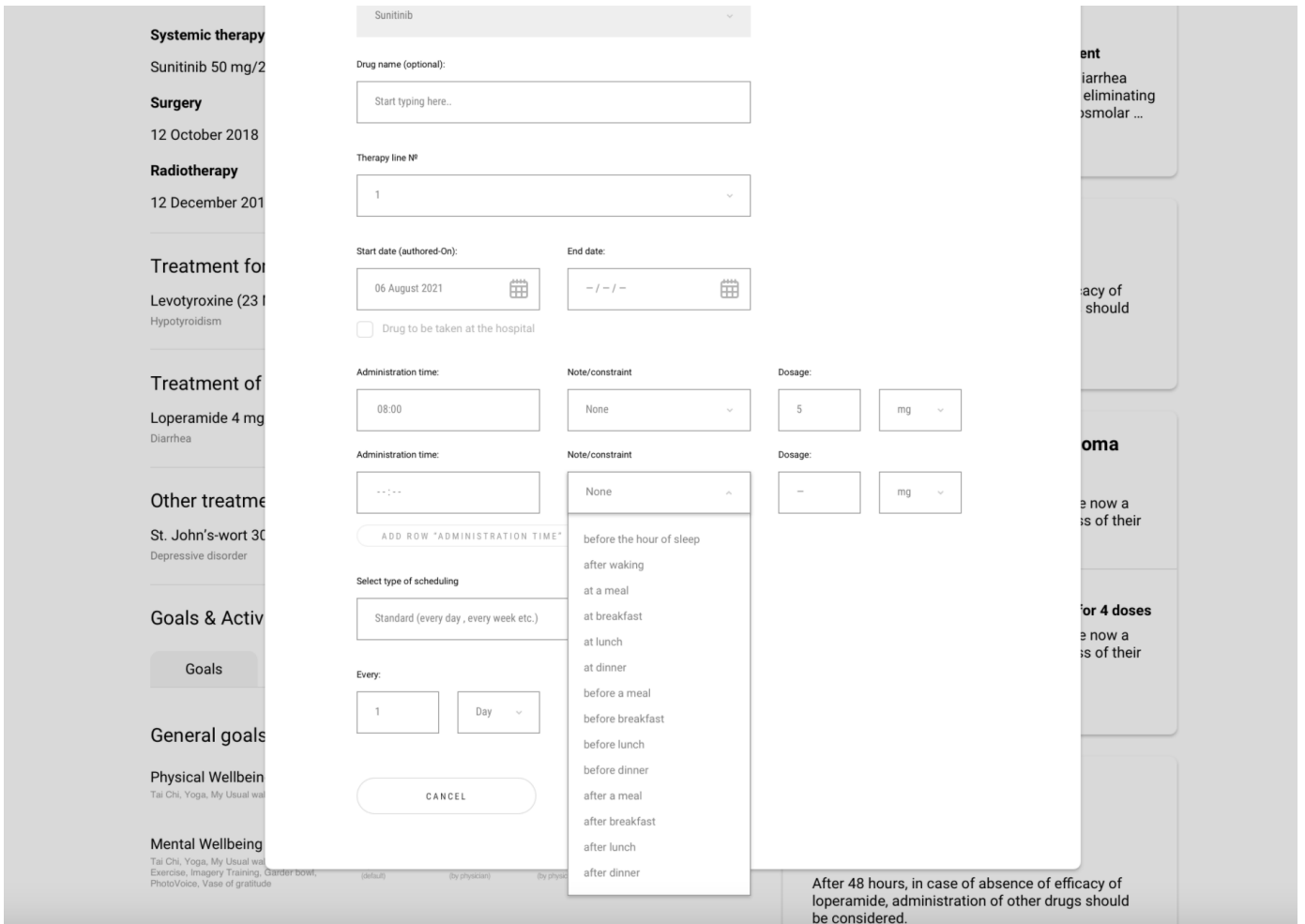
oma

now a  
s of their

---

for 4 doses  
now a  
s of their

Figure 5.9.34 Patients Profile - Treatment tab – example of possible administration options.



The screenshot displays the 'Treatment' tab for a patient's profile. The main form is for 'Sunitinib' and includes the following fields and options:

- Drug name (optional):** A text input field with the placeholder 'Start typing here..'
- Therapy line N°:** A dropdown menu currently showing '1'.
- Start date (authorized-On):** A date picker set to '06 August 2021'.
- End date:** A date picker set to '--/--/--'.
- Drug to be taken at the hospital:** An unchecked checkbox.
- Administration time:** A time input field set to '08:00'.
- Note/constraint:** A dropdown menu set to 'None'.
- Dosage:** A numerical input field set to '5' and a unit dropdown set to 'mg'.
- Administration time (second row):** A time input field set to '--:--'.
- Note/constraint (second row):** A dropdown menu set to 'None'.
- Dosage (second row):** A numerical input field set to '-' and a unit dropdown set to 'mg'.
- ADD ROW "ADMINISTRATION TIME":** A button to add a new administration row.
- Select type of scheduling:** A dropdown menu set to 'Standard (every day , every week etc.)'.
- Every:** A numerical input field set to '1' and a unit dropdown set to 'Day'.
- CANCEL:** A button to cancel the current configuration.

A dropdown menu is open from the 'Note/constraint' field, listing the following options: before the hour of sleep, after waking, at a meal, at breakfast, at lunch, at dinner, before a meal, before breakfast, before lunch, before dinner, after a meal, after breakfast, after lunch, and after dinner.

At the bottom right of the form, there is a note: "After 48 hours, in case of absence of efficacy of loperamide, administration of other drugs should be considered."

Figure 5.9.35 Patients Profile - Treatment tab – example of possible administration options.

Current

Treatment for  
**Systemic therapy**  
Sunitinib 50 mg/2  
**Surgery**  
12 October 2018  
**Radiotherapy**  
12 December 201

Treatment for  
Levotyroxine (23 I  
Hypothyroidism

Treatment of  
Loperamide 4 mg  
Diarrhea

Other treatme  
St. John's-wort 30  
Depressive disorder

Goals & Activ  
**Goals**

General goals  
Physical Wellbein  
Tai Chi, Yoga, My Usual wa  
Mental Wellbein

### Treatment for cancer ▾

Active principle:

Sunitinib ▾

Drug name (optional):

Start typing here..

Therapy line N°

1 ▾

Start date (authored-On):

06 August 2021

Drug to be taken at the hospital

End date:

- / - / -

Administration time:

08:00

Note/constraint

None ▾

Dosage:

5

mg ▾

Administration time:

- : -

Note/constraint

before the hour of sleep ▾

Dosage:

10

mg ▾

ADD ROW "ADMINISTRATION TIME"

Select type of scheduling

Standard (every day , every week etc.) ▾

---

Standard (every day , every week etc.)

Start-stop scheduling (every day for X days , stop Y days)

Select weekdays

CANCEL

SAVE

ent  
diarrhea  
eliminating  
osmolar ...

acy of  
should

oma

now a  
s of their

for 4 doses  
now a  
s of their

Figure 5.9.36 Patients Profile - Treatment tab – example of possible scheduling types.

Current

Treatment for

**Systemic therapy**

Sunitinib 50 mg/2

**Surgery**

12 October 2018

**Radiotherapy**

12 December 201

Treatment for

Levotyroxine (23

Hypothyroidism

Treatment of

Loperamide 4 mg

Diarrhea

Other treatme

St. John's-wort 30

Depressive disorder

Goals & Activ

Goals

General goals

Physical Wellbein

Tai Chi, Yoga, My Usual wa

Mental Wellbeing

Treatment for cancer

Active principle:

Sunitinib

Drug name (optional):

Start typing here..

Therapy line N°

1

Start date (authored-On): 06 August 2021

End date: - / - / -

Drug to be taken at the hospital

Administration time: 08:00

Note/constraint: None

Dosage: 5 mg

Administration time: --:--

Note/constraint: before the hour of sleep

Dosage: 10 mg

ADD ROW "ADMINISTRATION TIME"

Select type of scheduling

Start-stop scheduling (every day for X days, stop Y days)

Every: 1 Day(s)

For: 4 Week(s)

Then stop for: 2 Weeks

CANCEL SAVE

ent  
diarrhea  
eliminating  
smolar ...

acy of  
should

oma

now a  
s of their

for 4 doses  
now a  
s of their

Figure 5.9.37 Patients Profile - Treatment tab – example of possible scheduling types.



Current
Treatment for cancer ▼

Active principle:

Sunitinib ▼


Drug name (optional):

Start typing here..


Therapy line N°

1 ▼

Start date (authored-On):

06 August 2021


End date:

- / - / -


Drug to be taken at the hospital

<p>Administration time:</p> <div style="border: 1px solid #ccc; padding: 5px; margin-bottom: 10px;">08:00</div>	<p>Note/constraint</p> <div style="border: 1px solid #ccc; padding: 5px; margin-bottom: 10px;">None <span style="float: right;">▼</span></div>	<p>Dosage:</p> <div style="display: flex; align-items: center; margin-bottom: 10px;"> <div style="border: 1px solid #ccc; padding: 5px; width: 40px; text-align: center;">5</div> <div style="margin: 0 5px;">mg <span style="font-size: 0.8em;">▼</span></div> </div>
<p>Administration time:</p> <div style="border: 1px solid #ccc; padding: 5px; margin-bottom: 10px;">--:--</div>	<p>Note/constraint</p> <div style="border: 1px solid #ccc; padding: 5px; margin-bottom: 10px;">before the hour of sleep <span style="float: right;">▼</span></div>	<p>Dosage:</p> <div style="display: flex; align-items: center; margin-bottom: 10px;"> <div style="border: 1px solid #ccc; padding: 5px; width: 40px; text-align: center;">10</div> <div style="margin: 0 5px;">mg <span style="font-size: 0.8em;">▼</span></div> </div>

ADD ROW "ADMINISTRATION TIME"

Select type of scheduling

Standard (every day , every week etc.) ^


---

Standard (every day , every week etc.)
Start-stop scheduling (every day for X days , stop Y days)
Select weekdays

CANCEL

SAVE

Figure 5.9.38 Patients Profile - Treatment tab – example of possible scheduling types.

### Treatment for cancer ▼

Active principle:

Sunitinib ▼

Drug name (optional):

Start typing here..

Therapy line N°

1 ▼

Start date (authored-On):

06 August 2021 📅

Drug to be taken at the hospital

End date:

- / - / - 📅

Administration time:

08:00

Note/constraint

None ▼

Dosage:

5
mg ▼

Administration time:

--:--

Note/constraint

before the hour of sleep ▼

Dosage:

10
mg ▼

ADD ROW "ADMINISTRATION TIME"

Select type of scheduling

Select weekdays ▼

Days:

Mon
  Tue
  Wed
  Thu
  Fri
  Sat
  Sun

CANCEL

SAVE

Figure 5.9.39 Patients Profile - Treatment tab – example of possible scheduling types - specific week day can be chosen.

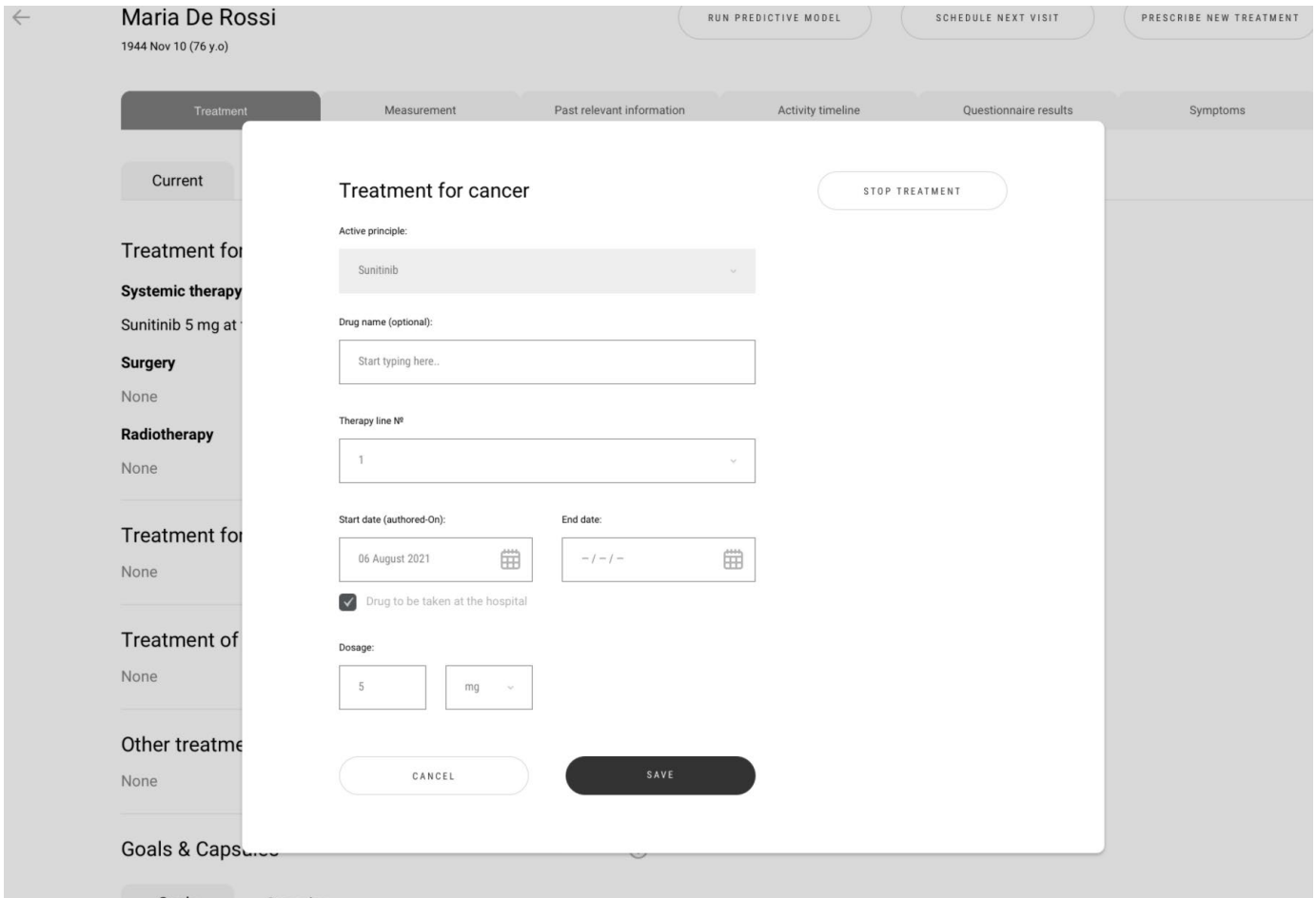


Figure 5.9.40 Patients Profile - Treatment tab – possibility to stop or change prescribed treatment (e.g., due to adverse events).

Current Past

---

Treatment for cancer EDIT

**Systemic therapy**  
Sunitinib 50 mg/2 weeks, hospital admin. (12 December 2019)

**Surgery**  
12 October 2018

**Radiotherapy**  
12 December 2018 – 22 December 2018

---

Treatment for comorbidities PRESCRIBED VIA EHR

Levotyroxine (23 March 2017)  
Hypothyroidism

---

Treatment of adverse events PRESCRIBED VIA EHR

Loperamide 4 mg/4 hours, As needed medication  
Diarrhea

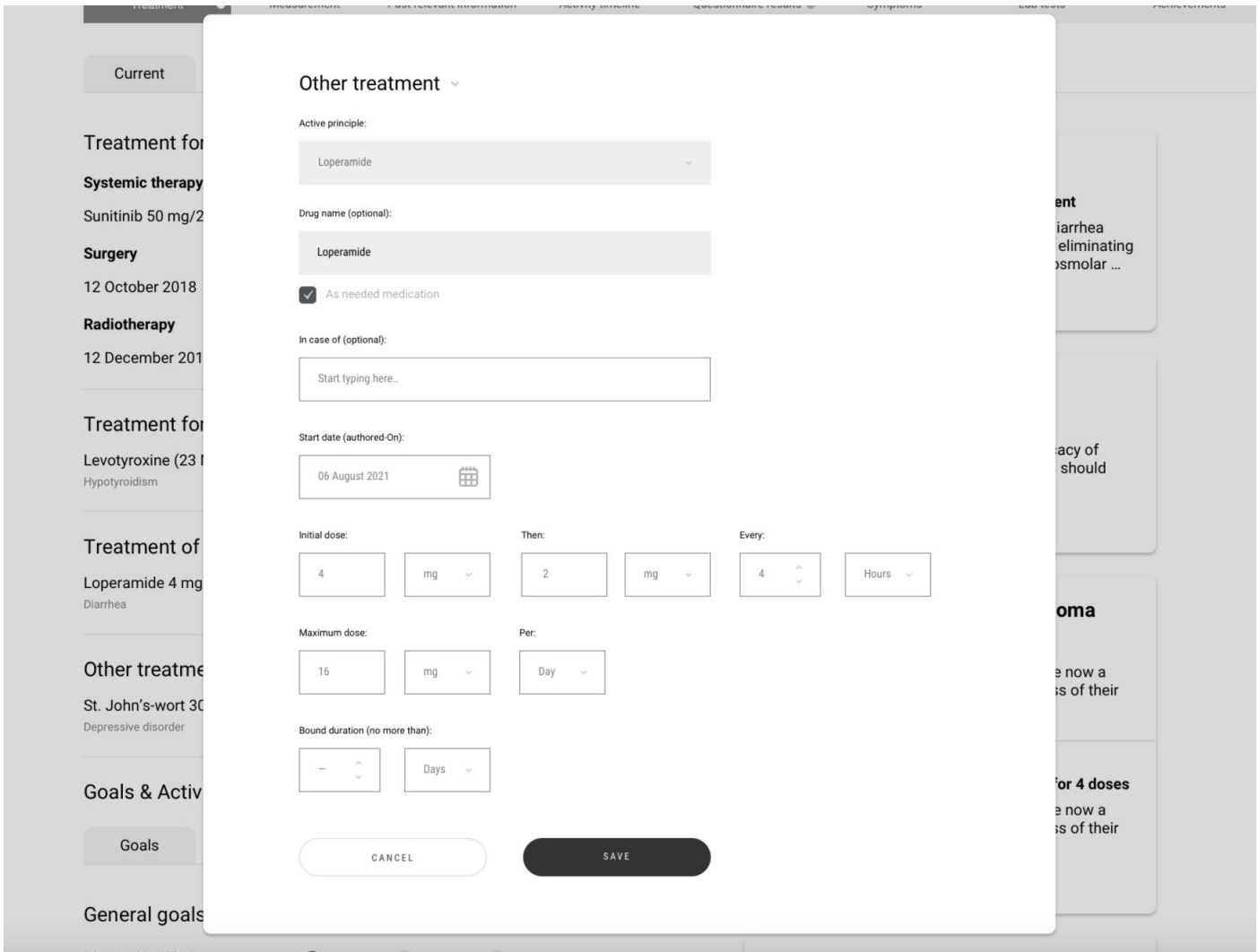
---

Other treatment EDIT

St. John's-wort 300 mg/1 day (23 March 2017)  
Depressive disorder

---

Figure 5.9.41 Patients Profile – Treatment tab – it will be visible if the treatment is prescribed via CAPABLE or it was imported from the EHR.



The screenshot shows a patient profile with a 'Treatment' tab selected. A modal window titled 'Other treatment' is open, displaying a form for a new prescription. The form includes the following fields and options:

- Active principle:** A dropdown menu with 'Loperamide' selected.
- Drug name (optional):** A text input field containing 'Loperamide'.
- As needed medication:** A checked checkbox.
- In case of (optional):** A text input field with the placeholder 'Start typing here..'.
- Start date (authored-On):** A date picker showing '06 August 2021'.
- Initial dose:** A numeric input '4', a unit dropdown 'mg', a 'Then:' label, a numeric input '2', another unit dropdown 'mg', an 'Every:' label, a numeric input '4', and a unit dropdown 'Hours'.
- Maximum dose:** A numeric input '16', a unit dropdown 'mg', and a 'Per:' label with a dropdown 'Day'.
- Bound duration (no more than):** A numeric input with a minus sign and a 'Days' dropdown.

At the bottom of the modal are two buttons: 'CANCEL' and 'SAVE'.

Figure 5.9.42 Patients Profile - Treatment tab – example of as needed prescription.

Treatment
Measurement
Past relevant information
Activity timeline
Questionnaire results
Symptoms

Current

Past

Treatment for cancer

**Systemic therapy**

None

**Surgery**

None

**Radiotherapy**

None

---

Treatment for comorbidities

None

---

Treatment of adverse events

None

---

Other treatment

Loperamide initial dose 4mg, then 2mg every 4 hours;  
max 16 mg/day  
As needed medication

---

Goals & Capsules ⓘ

Goals

Capsules

Figure 5.9.43 Patients Profile - Treatment tab – example of prescribed treatment

### 2.2.2 View Measurement

Req. 2.2.2	Physician application – Measurement Tab (including sensors)
Description	The physician can view summary data coming from the selected patient sensors. <b>CNI</b>
Preconditions	A patient is selected and the Sensors tab/button has been selected
Post Conditions	The sensor data of the selected patient are shown in a table
Course of action	The table contains sensor name, parameter, value, date
Component dependency	Physician application, Data Platform, Case Manager, Sensors
Planned delivery	
Responsible partners	BITSENS, Biomeris, UNIPV, PUT
Links to the mock-up	Patient Profile, Measurement tab: <a href="https://projects.invisionapp.com/share/GUX2BJUR8C4#/screens/448688124">https://projects.invisionapp.com/share/GUX2BJUR8C4#/screens/448688124</a>

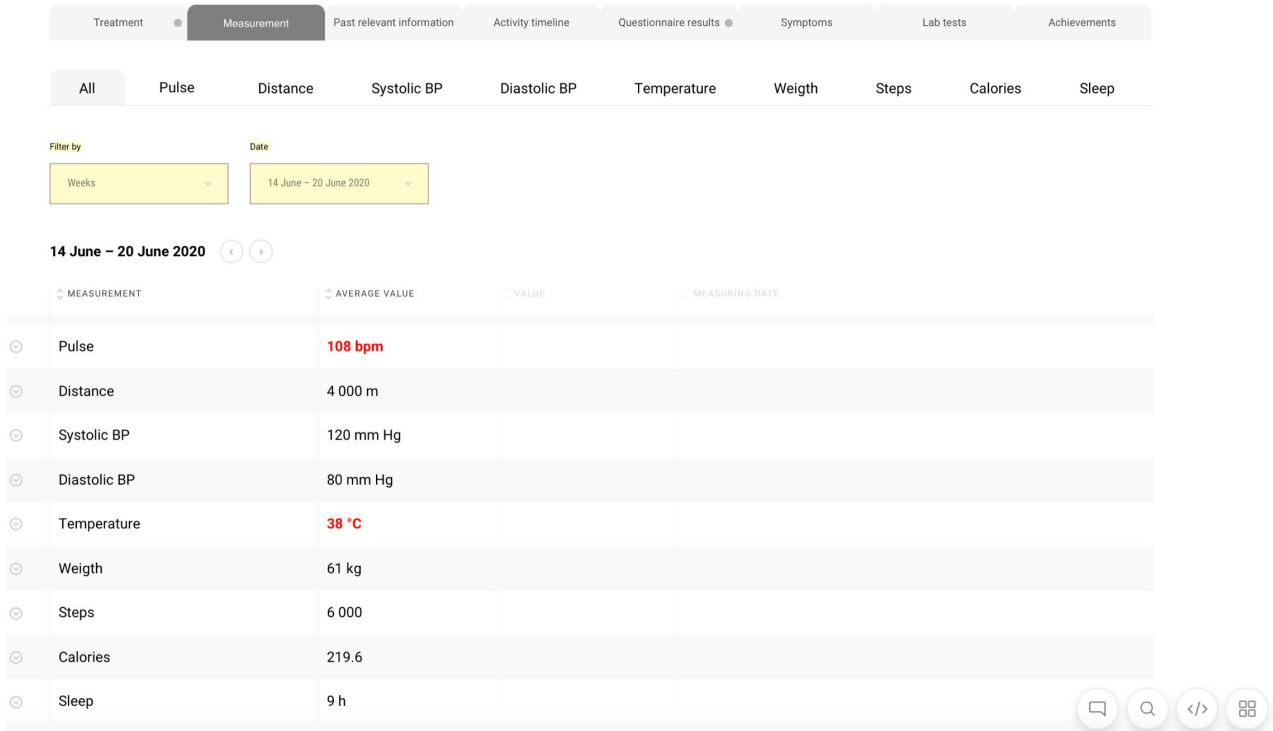


Figure 5.9.44 Patients Profile - Measurement tab – a tab with the Data from connected Sensor and the Vital signs entered by a Patient.

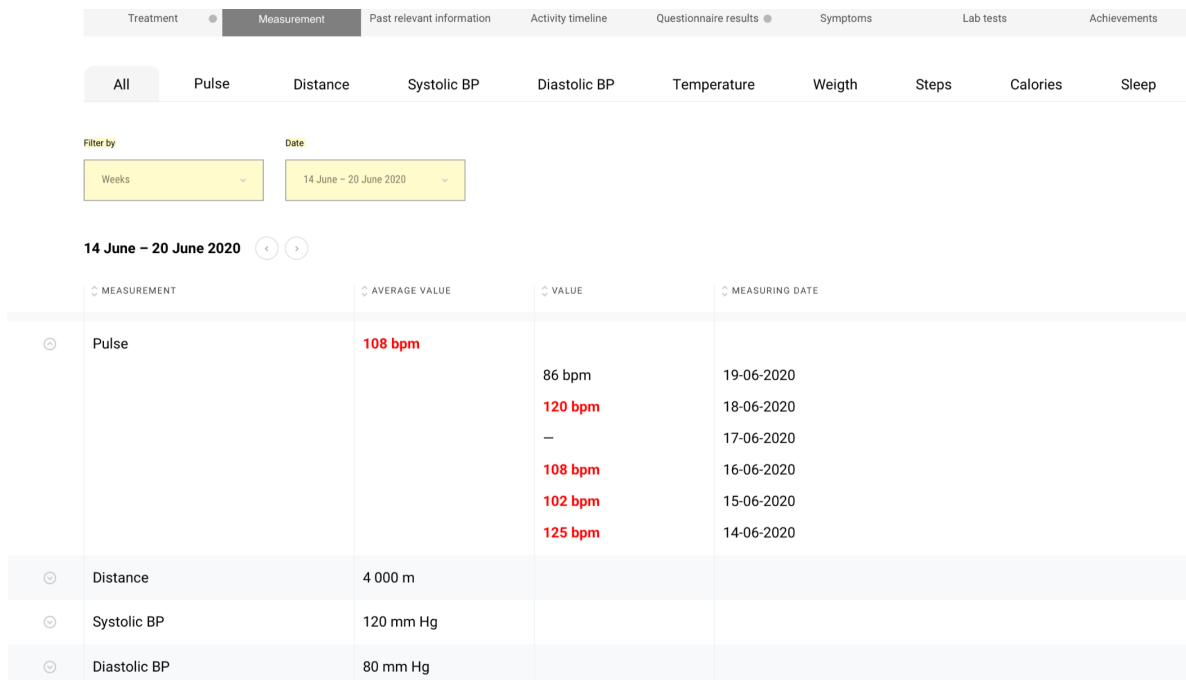


Figure 5.9.45 Patients Profile - Measurement tab – a tab with the Data from connected Sensor and the Vital signs entered by a Patient.

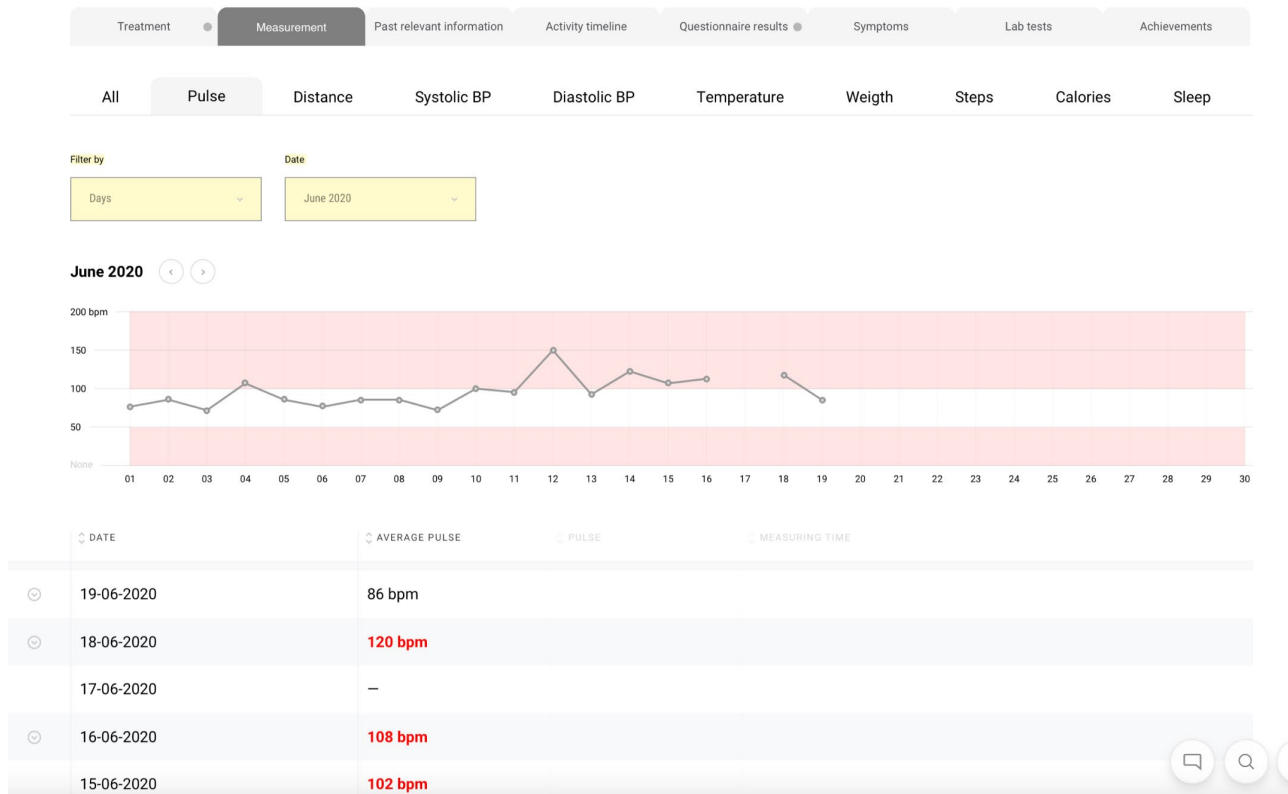


Figure 5.9.46 Patients Profile - Measurement tab – Example of a subtab with a visualisation.

### 2.2.3 View/Modify/Add Past Relevant Information (Clinical History) (Lucia)

Req. 2.2.3	Modify/Add Clinical History
Description	The physician can modify or add a new pathology for the selected patient.
Preconditions	The Past Relevant Information tab has been selected for a particular patient. If the physician wishes to add a new pathology, he needs to press the Add button. If the physician wishes to update an existing pathology, he needs to first click on one of the pathologies in the clinical history list. It is possible to filter by date and by name of the disease.
Post Conditions	Clinical History of the selected patient has been updated.
Course of action	The physician can enter the end date for the selected pathology.
Alternate course A	The physician can add a new pathology by specifying the name of the pathology, the start date, the date of the diagnosis (mandatory fields) and, possibly, the end date.
Alternate course B	



Alternate course C	
Component dependency	Physician application, Data Platform, Case Manager, GoCom, Deontics engine
Planned delivery	M30
Responsible partners	BITSENS, Biomeris, UoH, Deontics
Links to the mock-up	Patient Profile, Past relevant information tab <a href="https://projects.invisionapp.com/share/GUX2BJUR8C4#/screens/446097561">https://projects.invisionapp.com/share/GUX2BJUR8C4#/screens/446097561</a>

ID: 890438  
**Maria De Rossi**  
 1944 Nov 10 (76 y.o)

GUIDELINES | RUN PREDICTIVE MODEL | SCHEDULE NEXT VISIT | PRESCRIBE NEW TREATMENT | ...

Treatment | Measurement | **Past relevant information** | Activity timeline | Questionnaire results | Symptoms | Lab tests | Achievements

+ ADD DISEASE

Filter by date:  Filter by disease:

DATE	TITLE	NOTES	ACTIONS
2019	Diabetes	-	EDIT
2018	Hypertension	-	EDIT
2018	Collagen vascular	-	EDIT
2015	IBD	-	EDIT
08 June 2013	Previous intestinal surgery	-	EDIT

Figure 5.9.47 Patients Profile - Past relevant information tab - Possibility to add a new pathology and then to filter by date and by name.

### 2.2.4 View Activity Timeline

Req. 2.2.4	Timeline View
Description	The view includes activities related to the selected patients and it is presented as a graphical timeline in the <i>Activity timeline</i> tab on the Patient page. Individual entries in the timeline correspond to actions generated or scheduled by the system and to actions performed by patients.
Preconditions	Patient profile has been created. The physician is logged in.
Post Conditions	
Course of action	The physician navigates to the <i>Activity timeline</i> tab and is presented with a list of activities associated with the current patient. Entries (activities) are grouped by date, i.e., activities from a given date are displayed together. Moreover, entries and their groups are sorted chronologically

	<p>from the most to the least recent. It is also possible to filter the timeline to actions of specific type, thus limiting the amount of displayed information.</p> <p>A set of possible entries is as follows:</p> <ol style="list-style-type: none"> <li>1. &lt;date&gt; Account created</li> <li>2. &lt;date&gt; Patient personal information updated.</li> <li>3. &lt;date&gt; Patient enrolment completed</li> <li>4. &lt;date&gt; Treatment Recommendations (New Recommendation)</li> <li>5. &lt;date&gt; Treatment prescribed: &lt;treatmentTitle&gt; &lt;link with details&gt;. (links to Treatment tab). Full list of treatments might be found 2.2.2.1 Treatment List</li> <li>6. &lt;date&gt; Treatment course completed: &lt;treatmentTitle&gt; &lt;link with details&gt;.</li> <li>7. &lt;date&gt; Treatment taken by patients: &lt;treatmentTitle&gt;</li> <li>8. &lt;date&gt; No actions taken for N(3) days. - #days TBD</li> <li>9. &lt;date&gt; Goal set. &lt;goalTitle&gt; &lt;link with details&gt;</li> <li>10. &lt;date&gt; Patient status changed: &lt;statusTitle&gt;</li> <li>11. &lt;date&gt; Assessment completed: &lt;assessmentTitle&gt; (Sleep Assessment, Nutritional, QoL)</li> <li>12. &lt;date&gt; Measurement taken: &lt;bpmResult&gt;</li> <li>13. &lt;date&gt; Measurement taken: &lt;hoursSleep&gt;</li> <li>14. &lt;date&gt; Measurement taken: &lt;stepsWalked&gt;</li> <li>15. &lt;date&gt; Patient reported symptom: &lt;symptomTitle&gt; &lt;link&gt;</li> <li>16. &lt;date&gt; Mood track report: &lt;moodTitle&gt;</li> <li>17. &lt;date&gt; Report missed: &lt;actionTitle&gt; (for such cases when expected action was not taken)</li> <li>18. Recommendation from system received</li> <li>19. Recommendation from system accepted and prescribed via EHR/ accepted and prescribed via Capable/declined</li> <li>20. capsule activated/Capsule accepted/ Capsule declined</li> <li>21. Patient completed questionnaire</li> <li>22. Patient reported Symptom</li> <li>23. Goal/Capsule prescribed</li> </ol> <p>Each entry is characterized by:</p> <ul style="list-style-type: none"> <li>● date and time (date is presented once for the group of entries),</li> <li>● title indicating its type (see above),</li> <li>● description (e.g., recommendation details or the symptom and its level as reported by the patient),</li> <li>● optional link to tabs with details (e.g., dosage information for a prescribed drug) .</li> </ul> <p>New entries (e.g., most recent system recommendations) are marked so that the user can easily identify them and act accordingly (e.g., review them).</p>
Component dependency	Patient application, Data Platform, Case Manager, GoCom, Deontics engine
Planned delivery	TBD

Responsible partners	BITSENS, Biomeris, UoH, Deontics
Links to the mock-up	Patient profile, activity timeline tab: <a href="https://projects.invisionapp.com/share/GUX2BJUR8C4#/screens/446097690">https://projects.invisionapp.com/share/GUX2BJUR8C4#/screens/446097690</a> Patient profile, Activity timeline ta from Demo M18: <a href="https://projects.invisionapp.com/share/GUX2BJUR8C4#/screens/450978741">https://projects.invisionapp.com/share/GUX2BJUR8C4#/screens/450978741</a>

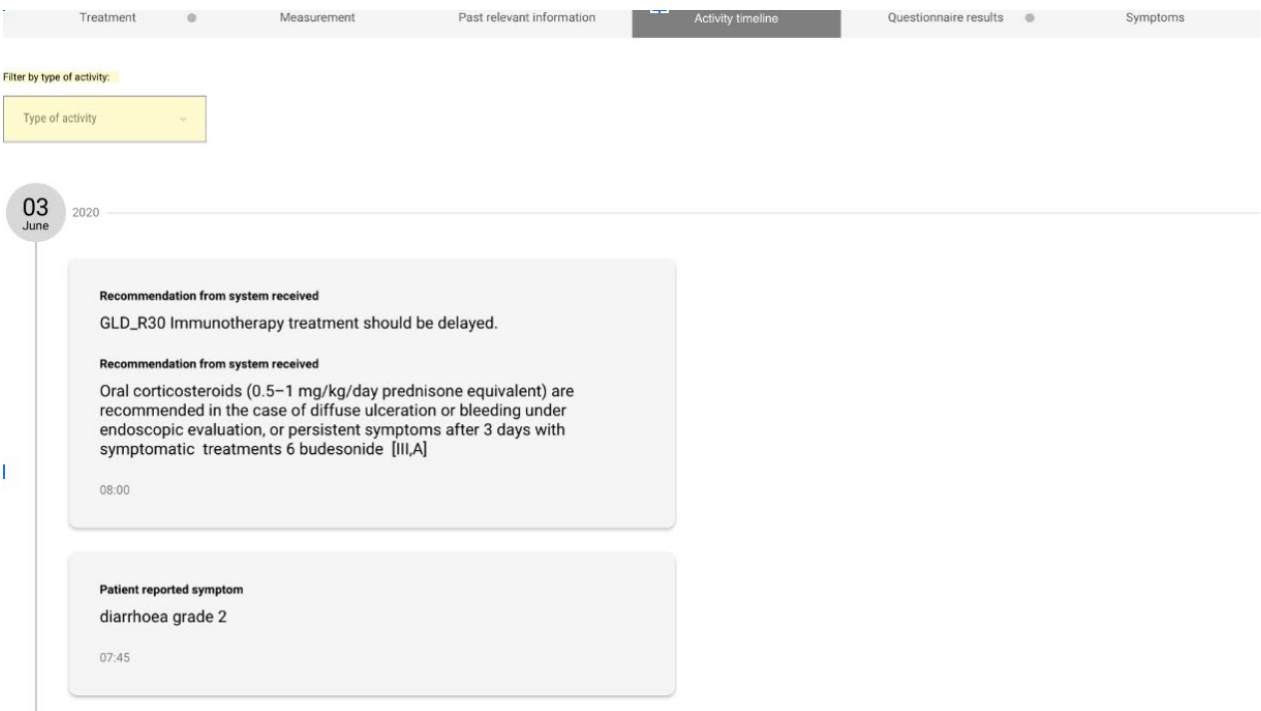


Figure 5.9.48 Patients Profile - Activity timeline tab - shows all the events regarding a Patient - Recommendations, Notifications, Symptoms, Treatments.

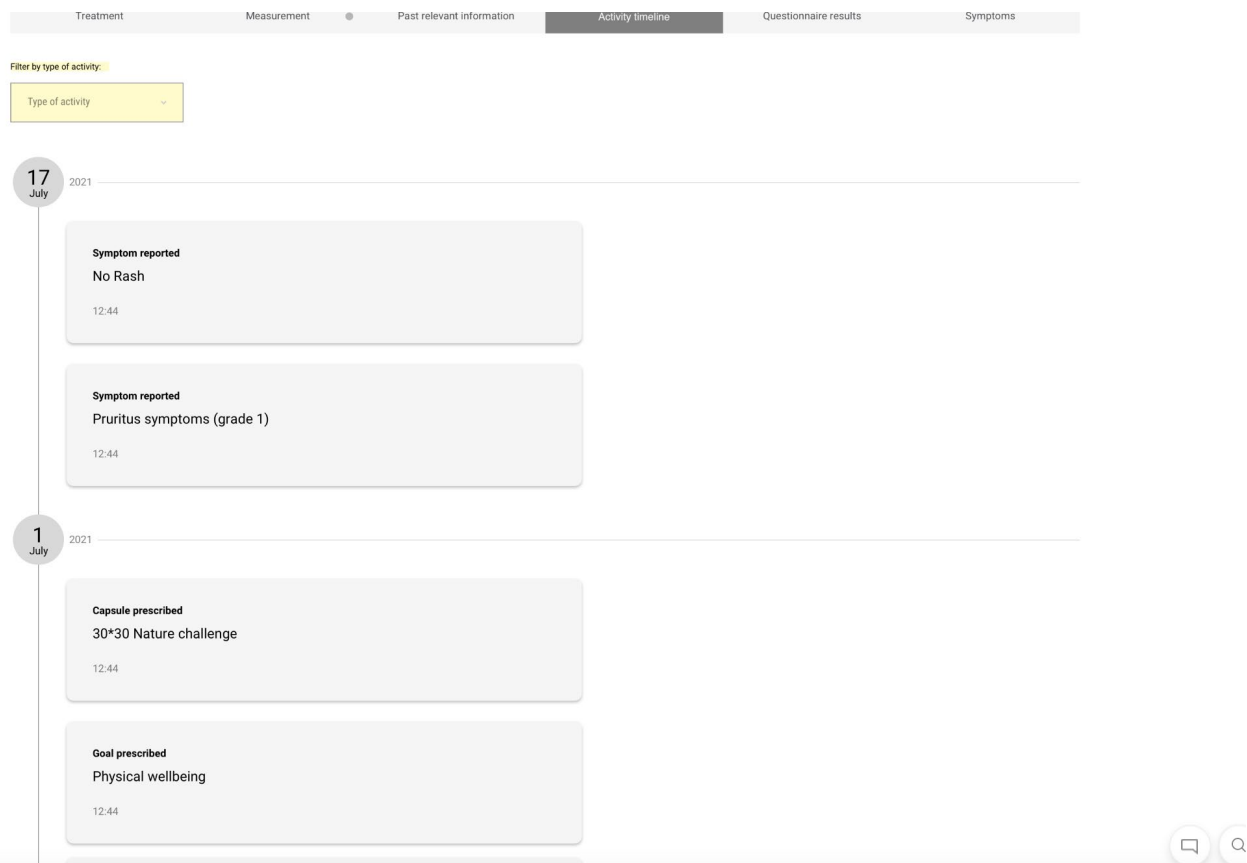


Figure 5.9.49 Patients Profile - Activity timeline tab - shows all the events regarding a Patient - Recommendations, Notifications, Symptoms, Treatments.

**2.2.5 View Questionnaire Results**

Req. 2.2.5	Physician application – Questionnaires
Description	The physician can view the data of the questionnaires of the selected patient. <b>CNI</b>
Preconditions	A patient is selected and the Questionnaires tab/button has been selected. Patients had filled in the assigned questionnaire.
Post Conditions	The questionnaire data of the selected patient are shown in a table and when opened, visualized in a line graph.
Course of action	The physician navigates to the <i>Questionnaire Results</i> tab and is presented with empty graph and a table with all the questionnaires done by the selected patient. The physician can select a specific questionnaire in order to see the results over time and he can also filter the results according to a specific period of time. The results of the questionnaire in the graph are represented as time points, and a red area highlights values that exceed a threshold specific for each questionnaires, thus allowing the physician to detect any potential critic situation. The table shows all the questionnaires taken by the patient or a specific questionnaire if selected, ordered by most recent one. The table shows the questionnaire name, the date taken, the results expressed as numeric value and a qualitative result expressed as string. All these fields in the table are sortable. Results that exceed the questionnaire threshold are presented in red.

Alternate course A	For each questionnaire presented in the table, the physician can select the <i>View Result</i> button and display a report with the results of specific questionnaire. A dialog window show the result.
Component dependency	Patient application, Data Platform, Case Manager, GoCom, Deontics engine
Planned delivery	TBD
Responsible partners	BITSENS, Biomeris, UNIPV
Links to the mock-up	<p>Patient profile, Questionnaire results tab, no questionnaire filtered:  <a href="https://projects.invisionapp.com/share/GUX2BJUR8C4#/screens/461601442">https://projects.invisionapp.com/share/GUX2BJUR8C4#/screens/461601442</a></p> <p>Patient profile, Questionnaire results tab, PHQ-9 questionnaire filtered and visualised:  <a href="https://projects.invisionapp.com/share/GUX2BJUR8C4#/screens/446097698">https://projects.invisionapp.com/share/GUX2BJUR8C4#/screens/446097698</a></p>

**Maria De Rossi**  
1944 Nov 10 (76 y.o)

GUIDELINES RUN PREDICTIVE MODEL SCHEDULE NEXT VISIT PRESCRIBE NEW TREATMENT

Treatment Measurement Past relevant information Activity timeline **Questionnaire results** Symptoms Lab tests Achievements

Filter by questionnaire: All Filter by: All period

27  
24  
21  
18  
15  
12  
9  
6  
3  
0

01 02 03 04 05 06 07 08 09 10 11 12 13 14 15 16 17 18 19 20 21 22 23 24 25 26 27 28 29 30

Please choose a questionnaire

QUESTIONNAIRE TITLE	DATE TAKEN	RESULTS	QUALITATIVE RESULT	ACTIONS
Insomnia Severity Index	12-01-2020	17 of 22 points	Normal	VIEW RESULTS
QoL EORTC QLQ-C30	12-01-2020	-		VIEW RESULTS
PHQ-9	11-01-2020	<b>24 of 27 points</b>	Severe	VIEW RESULTS
PHQ-9	08-01-2020	<b>15 of 27 points</b>	Moderately severe	VIEW RESULTS
PHQ-9	04-01-2020	9 of 27 points	Mild	VIEW RESULTS
PHQ-9	01-01-2020	3 of 27 points	Non – Minimal	VIEW RESULTS

Figure 5.9.50 Patients Profile - Questionnaire results tab- possibility to visualise evolution of questionnaire results. Before a specific questionnaire is filtered a template message will be shown. It is possible to filter by questionnaire and by period.

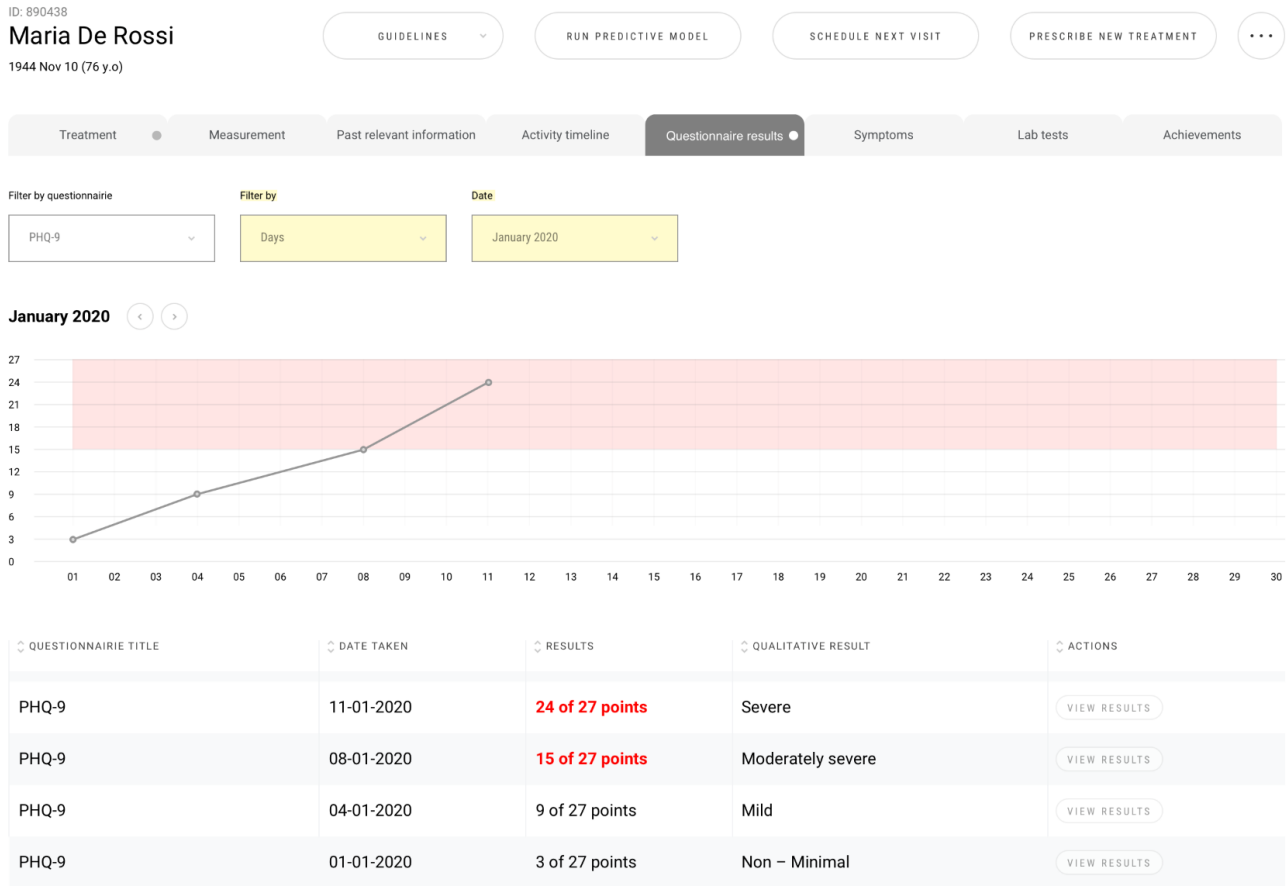


Figure 5.9.51 Patients Profile - Questionnaire results tab - possibility to visualise evolution of questionnaire results. A specific questionnaire is chosen and visualised.

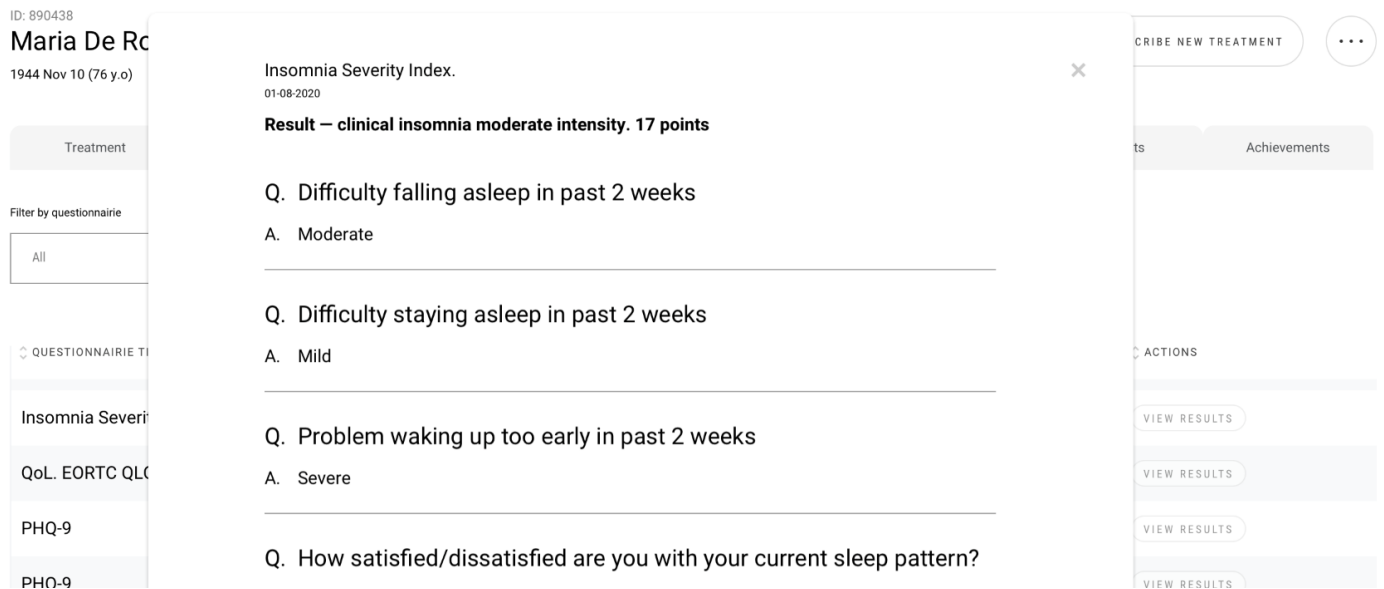


Figure 5.9.52 Patients Profile - Questionnaire results tab - View report with the results of specific questionnaire.

**2.2.6 View/Add Symptoms (Adverse Events)**

Req. 2.2.6	Physician application – Patient Symptoms (Adverse Events)
Description	The physician can view the list of patient adverse events and can add new symptoms. CNI
Preconditions	A patient is selected and the Patient adverse events tab/button has been selected
Post Conditions	The adverse events of the selected patient are shown in a table
Course of action	The table contains the name of the adverse event (e.g Diarrhea, Nausea, etc), the start date, the end date, and the CTCAE grade. To add a new symptom a physician can press the “Add new symptom” button, choose a symptom from a predefined list, indicate grade, start and end date (if applicable), relation with cancer treatment (from a predefined list) and note (if applicable). After pressing the “Accept” button, a new symptom created by a Physician will be added to the Symptom table.
Alternate course A	
Alternate course B	
Component dependency	Physician application, Data Platform, Case Manager
Planned delivery	TBD
Responsible partners	BITSENS, Biomeris, UNIPV
Links to the mock-up	Patients profile, Symptoms tab: <a href="https://projects.invisionapp.com/share/GUX2BJUR8C4#/screens/446097699">https://projects.invisionapp.com/share/GUX2BJUR8C4#/screens/446097699</a>

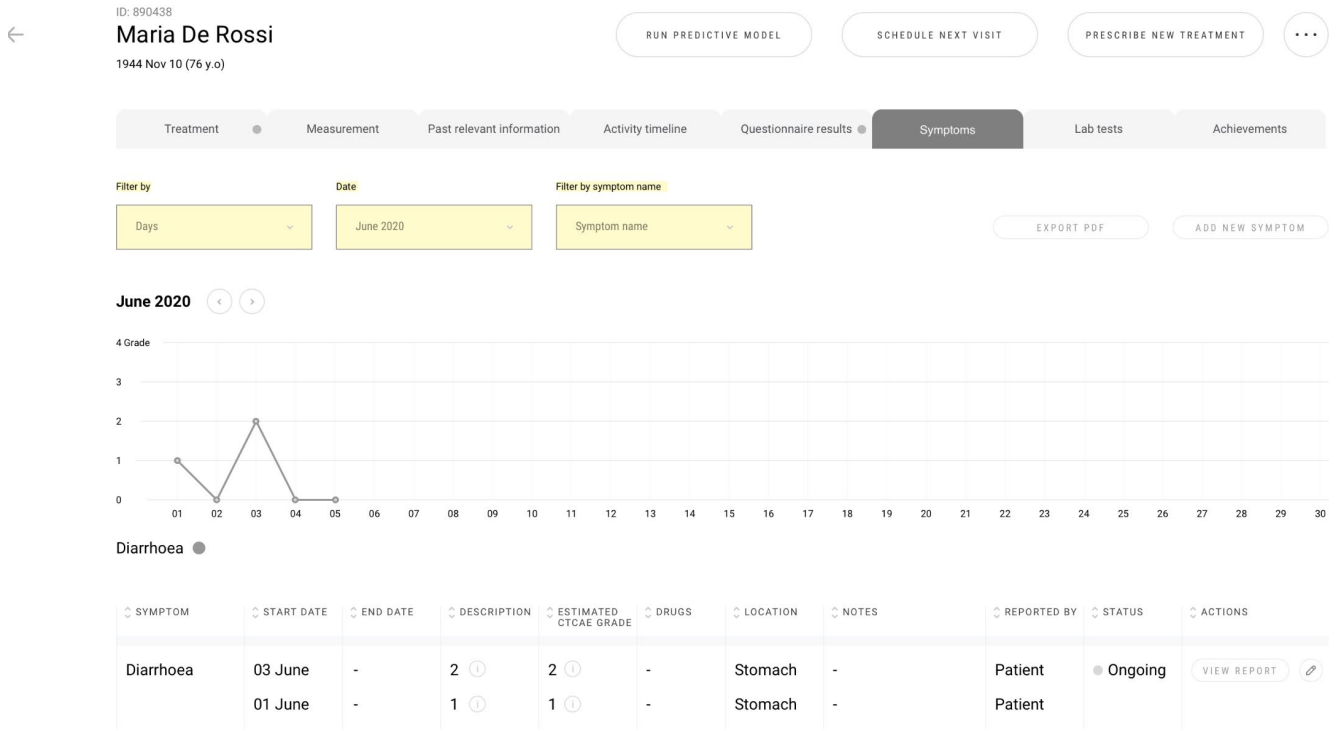


Figure 5.9.53 Patients Profile - Symptoms tab - reported symptoms with a visualisation, possibility to view, edit, add new symptom by a physician.

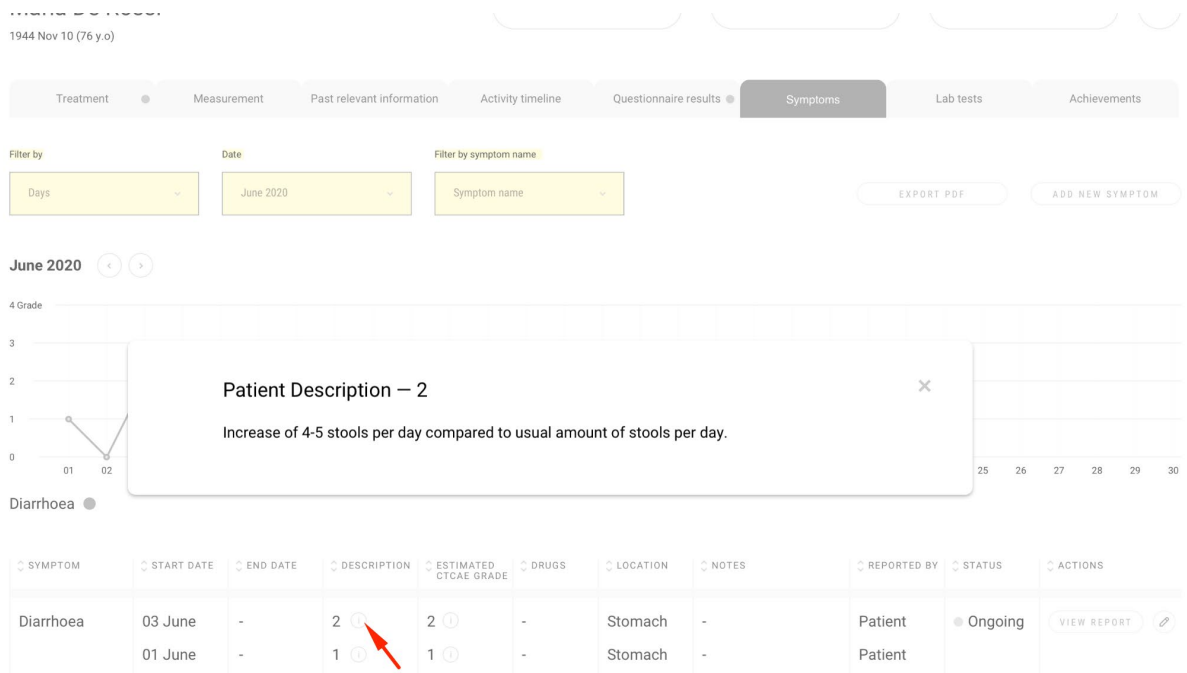


Figure 5.9.54 Patients Profile - Symptoms tab – pop-up with the textual Description of the reported Symptom.



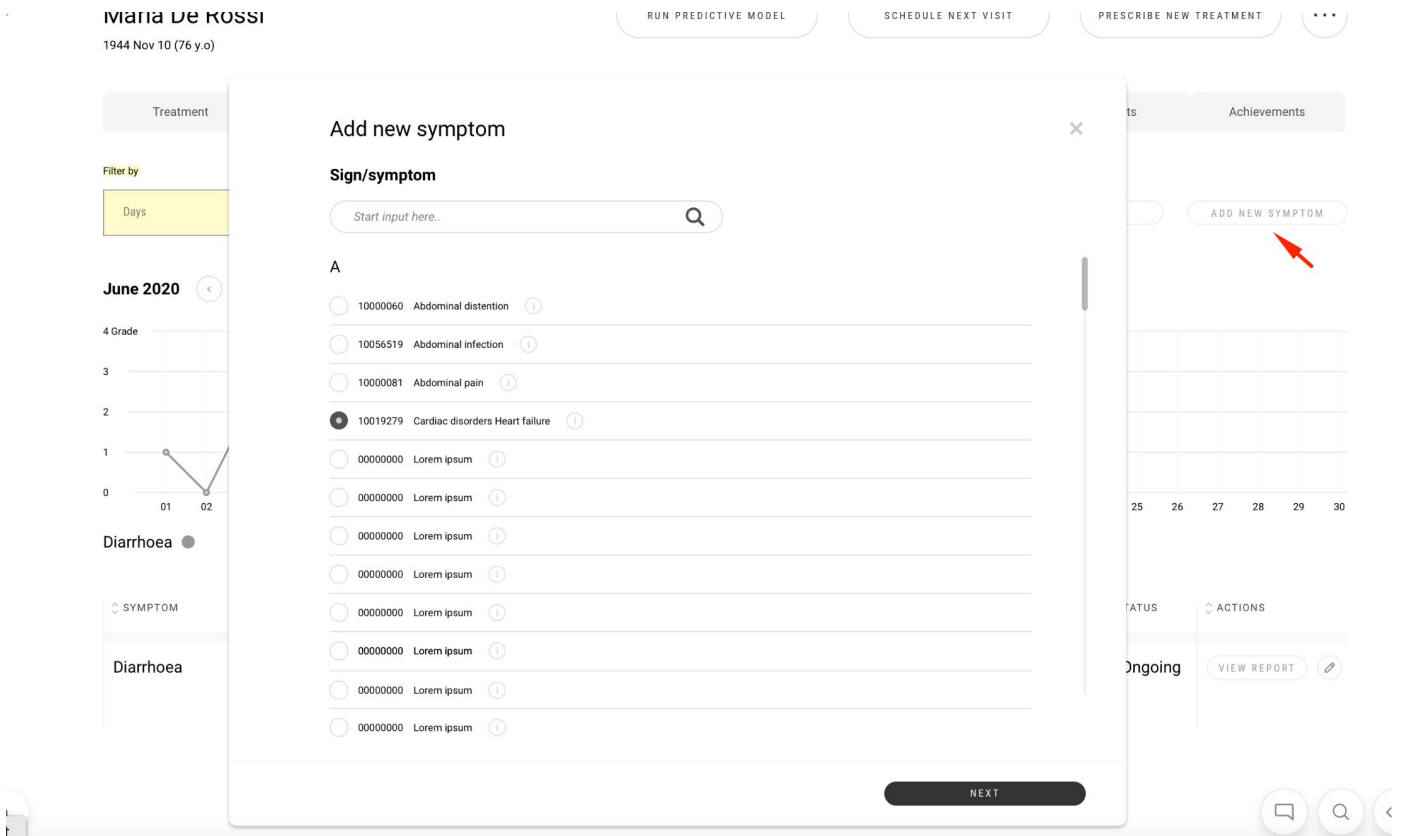
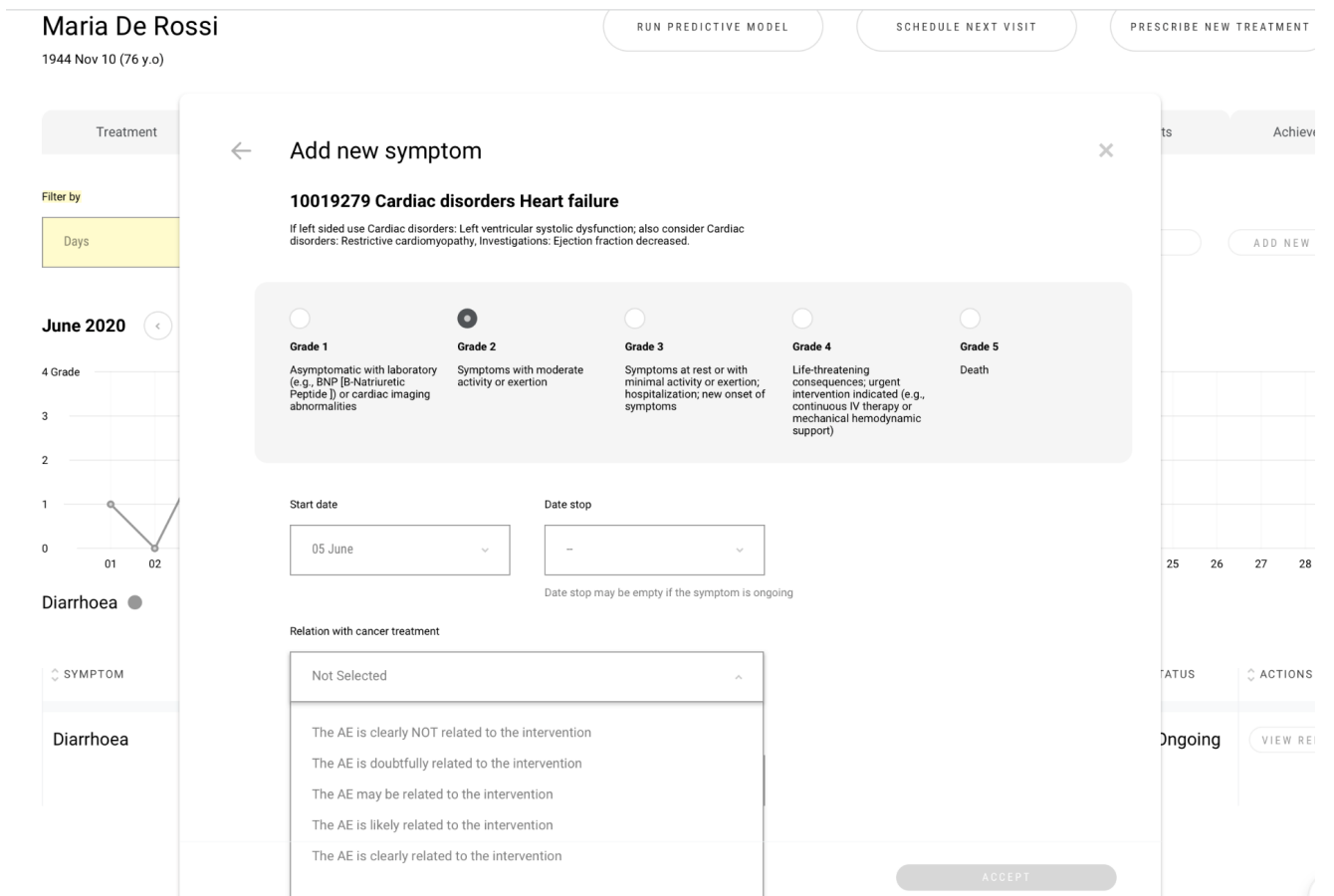


Figure 5.9.55 Patients Profile - Symptoms tab – adding a new symptom by a physician with controlled vocabulary codes



**10019279 Cardiac disorders Heart failure**  
 If left sided use Cardiac disorders: Left ventricular systolic dysfunction; also consider Cardiac disorders: Restrictive cardiomyopathy, Investigations: Ejection fraction decreased.

Grade 1: Asymptomatic with laboratory (e.g., BNP, β-Natriuretic Peptide) or cardiac imaging abnormalities

**Grade 2**: Symptoms with moderate activity or exertion

Grade 3: Symptoms at rest or with minimal activity or exertion; hospitalization; new onset of symptoms

Grade 4: Life-threatening consequences; urgent intervention indicated (e.g., continuous IV therapy or mechanical hemodynamic support)

Grade 5: Death

Start date: 05 June

Date stop: -

Relation with cancer treatment: The AE is clearly NOT related to the intervention

Note: Free text goes here

ACCEPT

Figure 5.9.57 Patients Profile - Symptoms tab – adding a new symptom by a physician.

Filter by: Days, Date: June 2020, Filter by symptom name: Symptom name

EXPORT PDF, ADD NEW SYMPTOM

June 2020

4 Grade

Cardiac disorders Heart failure ● Diarrhoea ●

SYMPTOM	START DATE	END DATE	DESCRIPTION	ESTIMATED CTCAE GRADE	DRUGS	LOCATION	NOTES	REPORTED BY	STATUS	ACTIONS
Cardiac disorders Heart failure	05 June	-	2 ⓘ	2 ⓘ	-	-	-	Doctor	● Ongoing	<a href="#">VIEW REPORT</a> ⓘ
Diarrhoea	03 June	-	2 ⓘ	2 ⓘ	-	Stomach	-	Patient	● Ongoing	<a href="#">VIEW REPORT</a> ⓘ
	01 June	-	1 ⓘ	1 ⓘ	-	Stomach	-	Patient		

Figure 5.9.58 Patients Profile - Symptoms tab –a new symptom is added by a physician.

### 2.2.7 View/Add Lab Tests

Req. 2.2.7	Physician application – Laboratory Test Results
Description	The physician can view the laboratory test results for the selected patient. It is also possible to add a new Lab Test result.
Preconditions	A patient is selected and the Laboratory Test Result tab/button has been selected
Post Conditions	The laboratory test results of the selected patient are shown in a table
Course of action	The table contains the parameter name, the value, the unit of measurement, the date, qualitative description (if applicable). A Physician needs to press the button “Add another test”, choose lab test name from a predefined list, then input manually date, value and unit of measurement or qualitative result. If everything is ready - press “Save” button and new lab test result will be added to the tab.
Alternate course A	
Alternate course B	
Component dependency	Physician GUI, Data Platform, CASE manager
Planned delivery	M30
Responsible partners	BITSENS, Biomeris, UNIPV
Links to the mock-up	Patient profile, Lab tests tab: <a href="https://projects.invisionapp.com/share/GUX2BJUR8C4#/screens/461185379">https://projects.invisionapp.com/share/GUX2BJUR8C4#/screens/461185379</a>

ID: 890438  
**Maria De Rossi**  
 1944 Nov 10 (76 y.o)

RUN PREDICTIVE MODEL    SCHEDULE NEXT VISIT    PRESCRIBE NEW TREATMENT    ...

Treatment    Measurement    Past relevant information    Activity timeline    Questionnaire results    Symptoms    **Lab tests**    Achievements

ADD ANOTHER TEST

LAB TEST	DATE	VALUE	UNIT OF MEASURE	QUALITATIVE
Neutrophil count	01-05-2021	-	-	Normal
Platelets count	20-04-2021	-	-	Low
Hemoglobin	10-03-2021	-	-	High

Figure 5.9.59 Patients Profile – Lab tests tab where all test results will be accumulated.

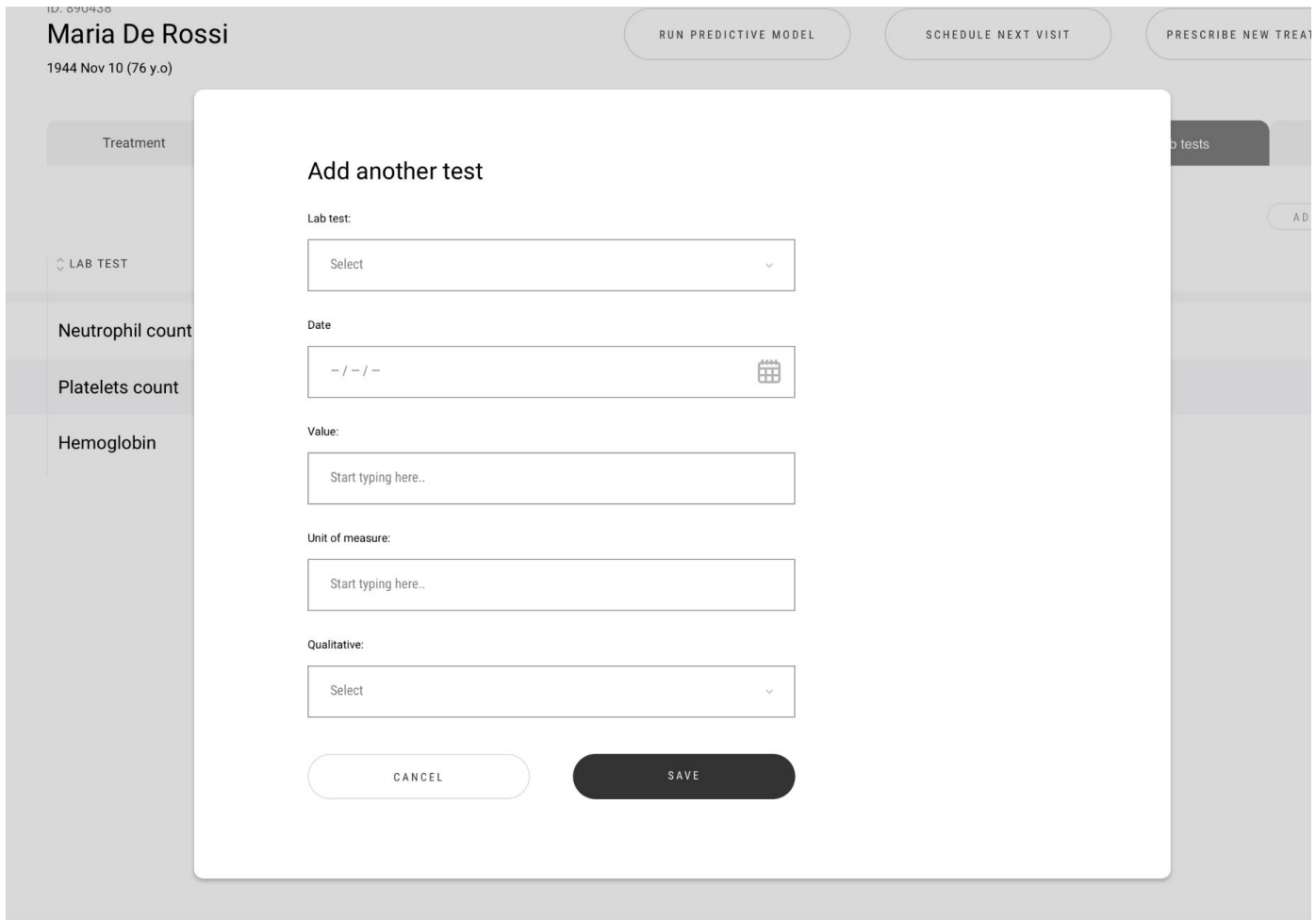


Figure 5.9.60 Patients Profile – Possibility to add Lab tests result manually from a list.

### 2.2.8 View Achievements

Req. 2.2.8	Physician application – Achievements Results
Description	The physician can view the results of a patients achievements - patient’s progress in performing prescribed activities week by week.
Preconditions	A patient is selected and the Achievements tab has been selected
Post Conditions	A table and a visualisation of a Patient progress are shown in the tab.
Course of action	The table contains Capsule (activity) name, date or time period and average percentage gained during the period of time..
Alternate course A	
Alternate course B	

Component dependency	Physician GUI, Data Platform, CASE manager
Planned delivery	M30
Responsible partners	BITSENS, Biomeris, UNIPV
Links to the mock-up	Patient profile, Achievements tab: <a href="https://projects.invisionapp.com/share/GUX2BJUR8C4#/screens/461181079">https://projects.invisionapp.com/share/GUX2BJUR8C4#/screens/461181079</a>

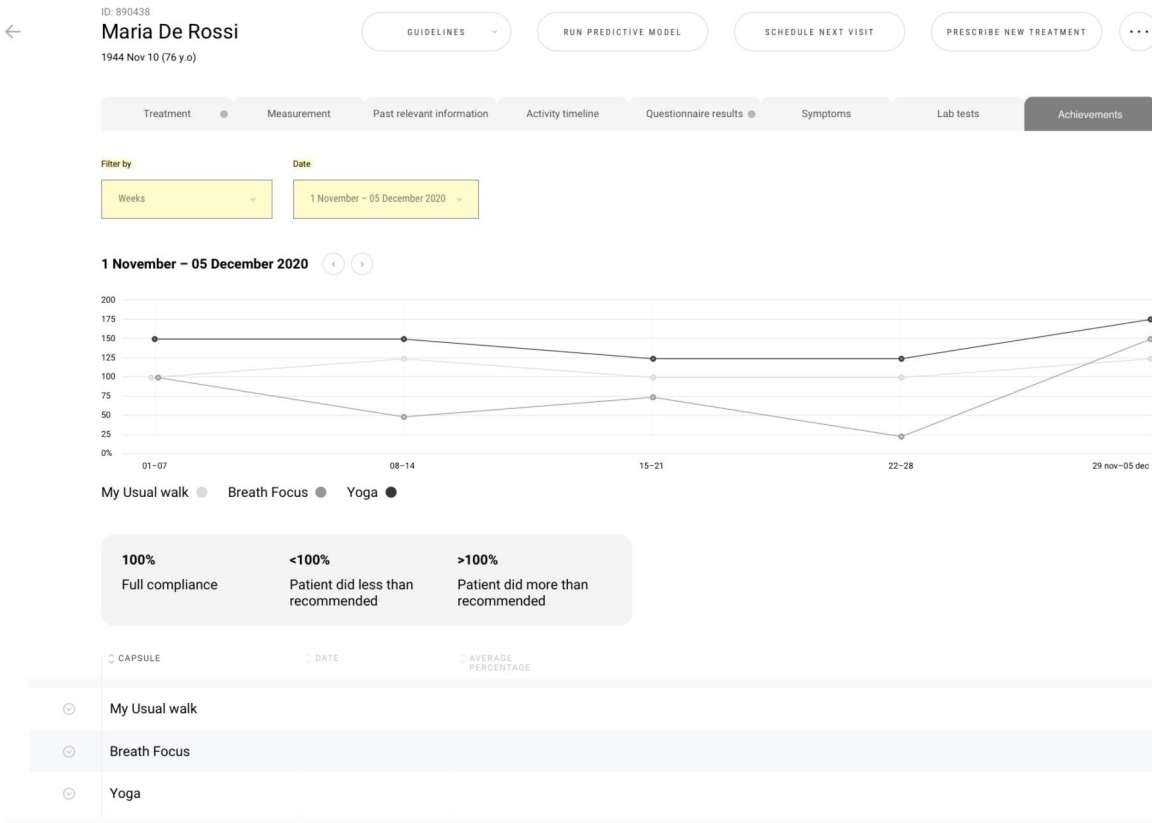


Figure 5.9.61 Patients Profile - Achievement tab – Visualize patient’s progress week by week for each prescribed Activity as % compliance. These will not be available through a Patient app. The results will be discussed during a live visit.

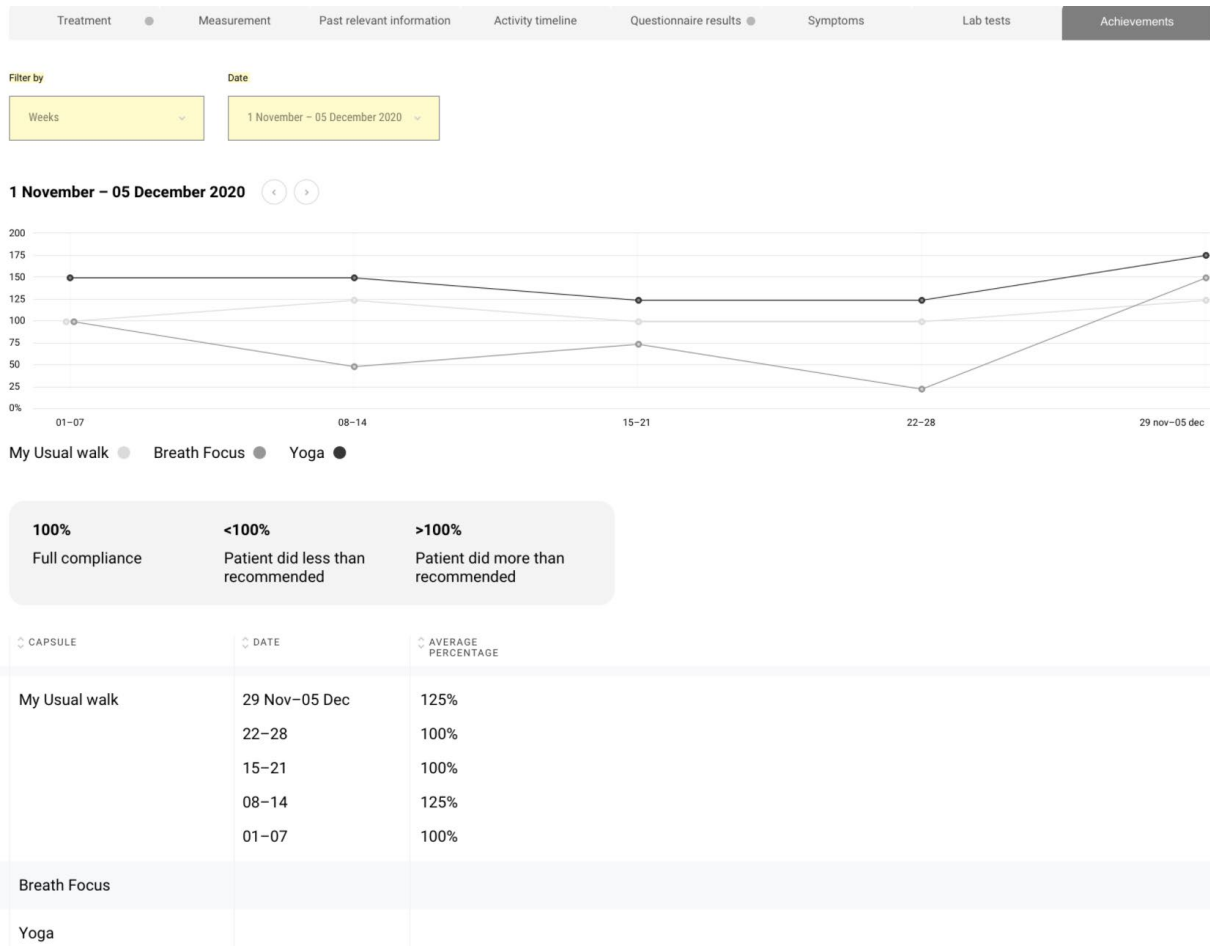
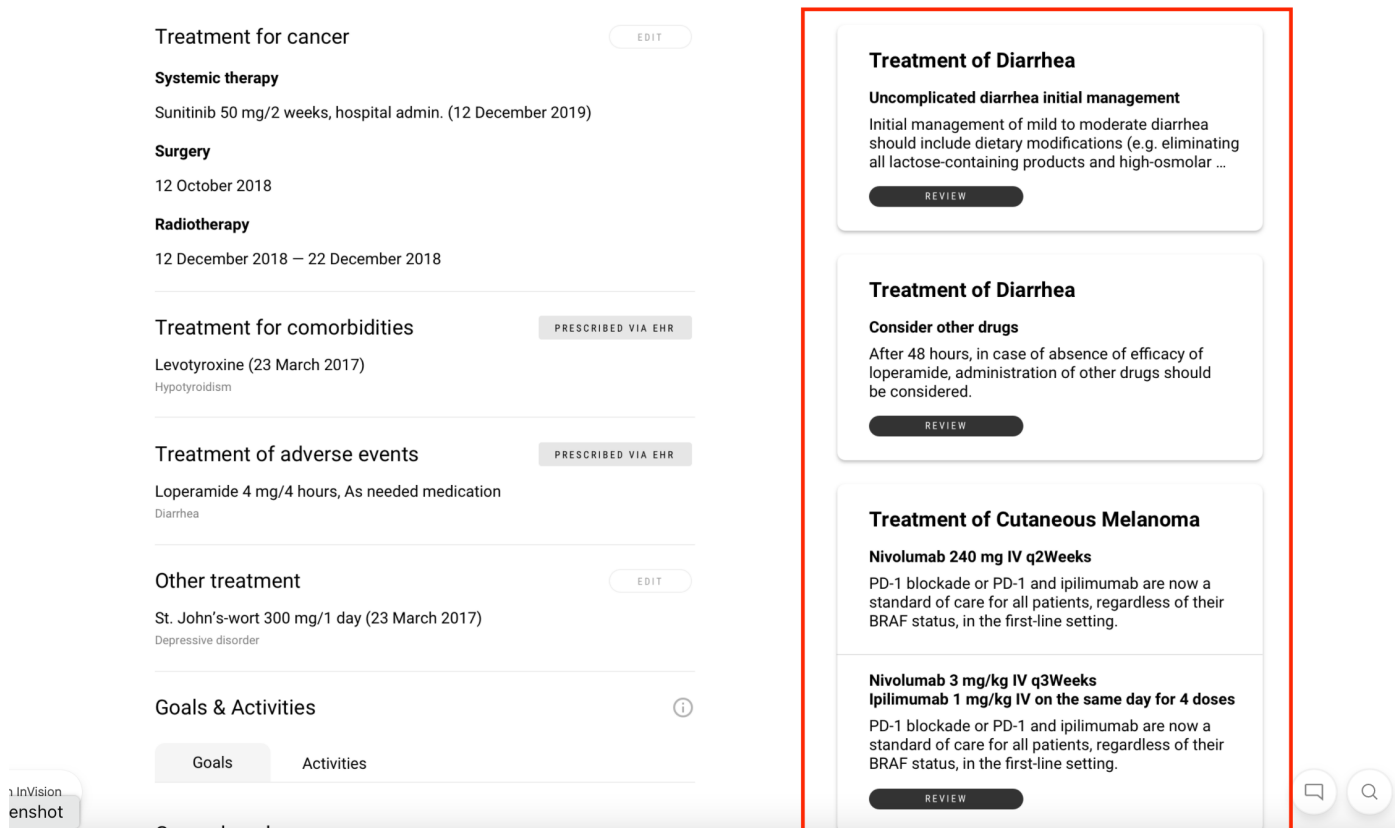


Figure 5.9.62 Patients Profile - Achievement tab – Visualize patient’s progress week by week for each prescribed Activity as % compliance. These will not be available through a Patient app. The results will be discussed during a live visit.

Req. 3.1	Notify that a New Recommendation is available
Description	A physician is notified about new recommendations generated by the system for a specific patient. These recommendations need to be reviewed by the physician who can accept or decline them. Only accepted recommendations become part of the treatment.
Preconditions	At least one new recommendation has been generated for a specific patient by the Physician DSS in response to storing new patient data in the Data Platform. A physician is viewing the record of this patient in the Physician App.
Post Conditions	
Course of action	The <i>Treatment</i> and <i>Activity timeline</i> tabs display a visual indicator (a dot or a badge) to signal that new recommendations have been generated by the system and they need to be reviewed by a physician. A physician switches to the <i>Treatment</i> tab and is presented a list of new recommendations for review. This list is displayed in the right sidebar, next to past and current treatments, so a physician can compare them. Each proposed recommendation in the list is characterized by the following properties:

	<ul style="list-style-type: none"> <li>• <i>Clinical goal</i> associated with the recommendation (e.g., treatment of diarrhea),</li> <li>• <i>Summary</i> of the recommendation that may indicate specific drugs or their classes together with dosing information (e.g., loratadine, 10mg, once daily) or refer to more general actions (e.g., uncomplicated diarrhea initial management)</li> <li>• <i>Additional description</i> of the recommendation that may contain additional information supplementing the summary and providing supporting evidence.</li> </ul> <p>Moreover, each entry in the list displays the <i>Review</i> button that takes a physician to the screen that presents full details of the recommendation and allows for its accepting or declining (see req. 3.2).</p>
Alternate course A	A physician switches to the <i>Activity timeline</i> tab and is presented a list of activities presented in a graphical form (see req. 2.2.4) with new recommendations being emphasized.
Alternate course B	
Component dependency	Physician GUI, Data Platform, CASE manager
Planned delivery	M30
Responsible partners	BITSENS, Biomeris, UNIPV
Links to the mock-up	Patient Profile, Treatment tab with recommendations: <a href="https://projects.invisionapp.com/share/GUX2BJUR8C4#/screens/446097477">https://projects.invisionapp.com/share/GUX2BJUR8C4#/screens/446097477</a>



The screenshot displays a patient's treatment profile. On the left, there are sections for 'Treatment for cancer', 'Treatment for comorbidities', 'Treatment of adverse events', 'Other treatment', and 'Goals & Activities'. Each section lists specific treatments, dates, and conditions. On the right, a red-bordered box highlights a list of generated recommendations (notifications) for 'Treatment of Diarrhea' and 'Treatment of Cutaneous Melanoma'. Each recommendation includes a title, a brief description, and a 'REVIEW' button.

Figure 5.9.63 Patients Profile –Treatment tab - List of generated Recommendations (Notification).

Req. 3.2	Detailed Info for recommendations
Description	Display explanation that the recommendations are produced according to the Grading of Recommendations Assessment, Development and Evaluation (GRADE) methodology <b>CN2</b>
Preconditions	Physician is viewing the record of a particular patient via the Physician App.
Post Conditions	An explanation is shown that all the recommendations are produced following the clinical guidelines and according to Levels of Evidence (LoEs) and Grades of Recommendation (GoRs).
Course of action	
Alternate course A	
Alternate course B	
Component dependency	Physician GUI, Data Platform, CASE manager
Planned delivery	M30
Responsible partners	BITSENS, Biomeris, UNIPV



<p>Links to the mock-up</p>	<p>Patient profile, example of a textual recommendation:  <a href="https://projects.invisionapp.com/share/GUX2BJUR8C4#/screens/459949875">https://projects.invisionapp.com/share/GUX2BJUR8C4#/screens/459949875</a>          Patient profile, example of a textual recommendation:  <a href="https://projects.invisionapp.com/share/GUX2BJUR8C4#/screens/459949878">https://projects.invisionapp.com/share/GUX2BJUR8C4#/screens/459949878</a></p>
-----------------------------	---

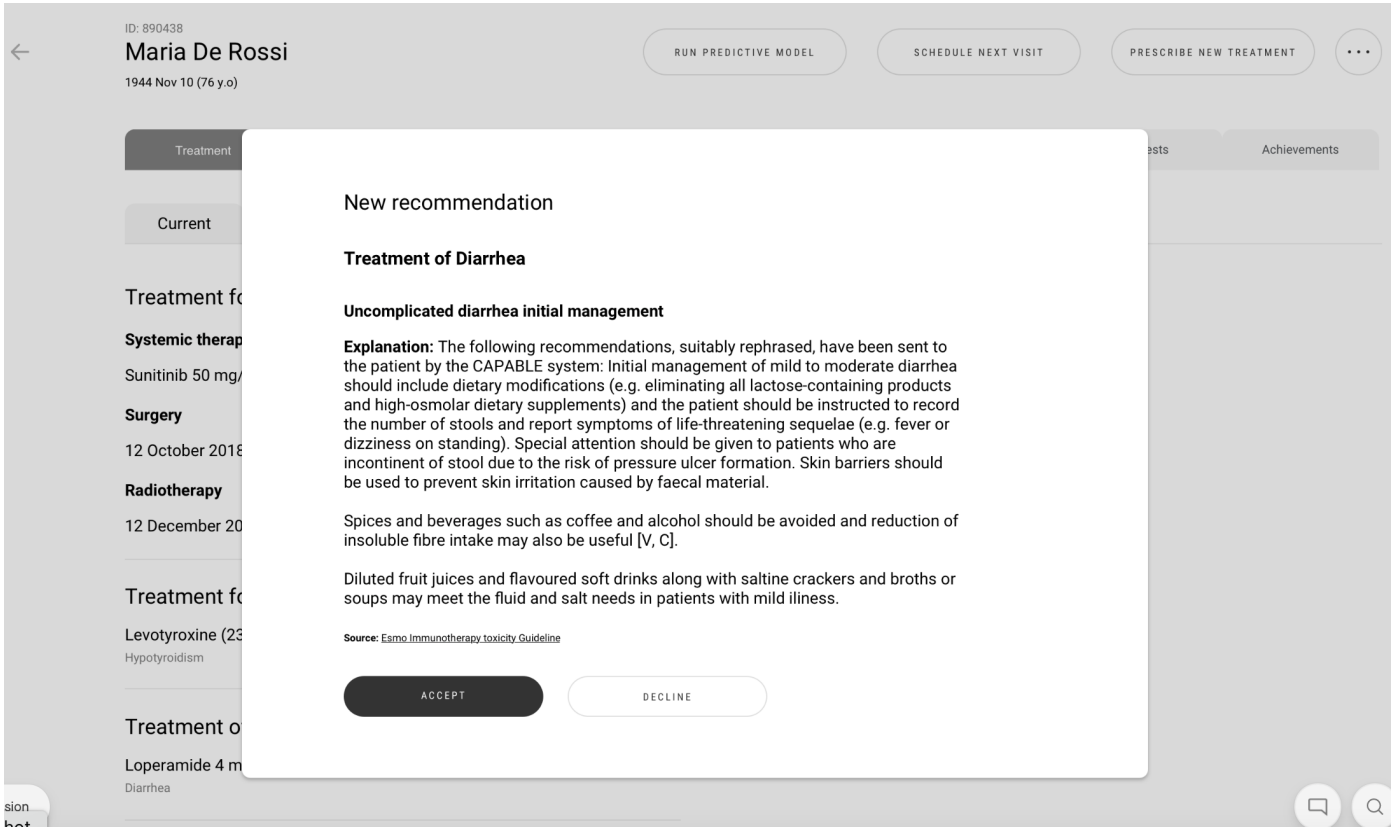


Figure 5.9.64 Patients Profile –Recommendation overview – example of a structure of a textual recommendation – title, subtitle, explanation, source, buttons.

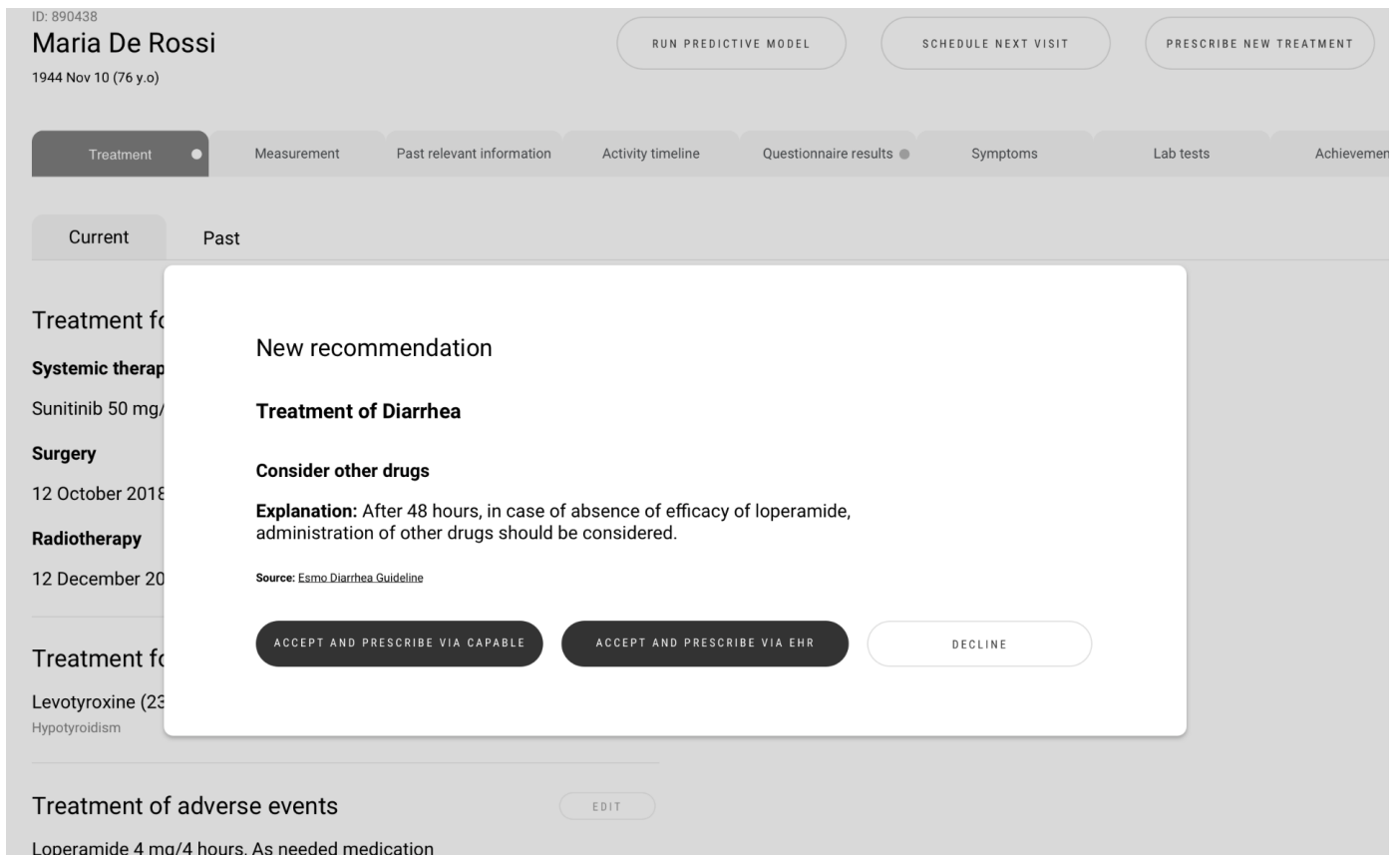


Figure 5.9.65 Patients Profile –Recommendation overview – example of a structure of a new recommendation with prescriptions – title, subtitle, explanation, source, buttons.

Req 3.3	View Recommendation Option Sets and select treatment
Description	<p>In cases where there are multiple option sets, all of them will be presented and the physician can click on the circle to the left of the chosen recommendation and commit it. The physician will see a chronologically sorted list of option sets that were provided by GoCom (DSS) and their Time/Date (in the Activity timeline tab). The new recommendations will be on top. The older ones will include only the option set that the physician has agreed to. The old recommendations that were not reviewed and not relevant any more will be shown in the Activity timeline tab in a chronological order with a note that this recommendation didn't get a reaction. Until the recommendation is valid it will stay in the Treatment tab but in the bottom of a sorted list of recommendations waiting for the reaction of the Physician.</p> <p>For the new recommendations, decision-support for the physician will be provided in interactive mode.</p> <p>New recommendations are logically arranged as option sets, where each option set associates an intervention with a clinical goal. All option sets address the same set of clinical goals. It is important to present these logical relations to the physician to provide explanation for the DSS' recommendations for multimorbidity patients. Therefore a visualization should provide a means for the decision-maker to view goal ranking under different prioritization perspectives.</p> <p>CN2</p>

Preconditions	The physician requested to see the list of recommendations in the Treatment tab. Notice that this mode is interactive. After some data in the system has been modified, new recommendations were created as part of the decision support provided by the DSS.
Post Conditions	none
Course of action	A list of recommendations for the physician and the patient is shown to the physician
Alternate course A	No recommendations are available
Alternate course B	
Component dependency	Physician GUI, Data Platform, Case Manager, GoCom, Deontics engine
Planned delivery	M30
Responsible partners	BITSENS, Biomeris, UNIPV, UoH, Deontics
Links to the mock-up	<p>Patient Profile, Treatment tab with recommendations:  <a href="https://projects.invisionapp.com/share/GUX2BJUR8C4#/screens/446097477">https://projects.invisionapp.com/share/GUX2BJUR8C4#/screens/446097477</a></p> <p>Patient profile, example of a textual recommendation:  <a href="https://projects.invisionapp.com/share/GUX2BJUR8C4#/screens/459949878">https://projects.invisionapp.com/share/GUX2BJUR8C4#/screens/459949878</a></p> <p>Patient profile, treatment tab, new treatment prescription in accordance with recommendation:</p> <ol style="list-style-type: none"> <li><a href="https://projects.invisionapp.com/share/GUX2BJUR8C4#/screens/459949879">https://projects.invisionapp.com/share/GUX2BJUR8C4#/screens/459949879</a></li> <li><a href="https://projects.invisionapp.com/share/GUX2BJUR8C4#/screens/459949880">https://projects.invisionapp.com/share/GUX2BJUR8C4#/screens/459949880</a></li> </ol> <p>Patient profile, example of a recommendation with two alternative options:  <a href="https://projects.invisionapp.com/share/GUX2BJUR8C4#/screens/459949882">https://projects.invisionapp.com/share/GUX2BJUR8C4#/screens/459949882</a></p> <p>Patient profile, treatment tab, new treatment prescription in accordance with recommendation when two medications are prescribed:</p> <ol style="list-style-type: none"> <li><a href="https://projects.invisionapp.com/share/GUX2BJUR8C4#/screens/459949883">https://projects.invisionapp.com/share/GUX2BJUR8C4#/screens/459949883</a></li> <li><a href="https://projects.invisionapp.com/share/GUX2BJUR8C4#/screens/459949884">https://projects.invisionapp.com/share/GUX2BJUR8C4#/screens/459949884</a></li> <li><a href="https://projects.invisionapp.com/share/GUX2BJUR8C4#/screens/459949885">https://projects.invisionapp.com/share/GUX2BJUR8C4#/screens/459949885</a></li> </ol> <p>Patient profile, example of a recommendation with three supplementary options:  <a href="https://projects.invisionapp.com/share/GUX2BJUR8C4#/screens/459949886">https://projects.invisionapp.com/share/GUX2BJUR8C4#/screens/459949886</a></p> <p>Patient profile, treatment tab, new treatment prescription in accordance with recommendation when three medications are prescribed:</p>

1. <https://projects.invisionapp.com/share/GUX2BJUR8C4#/screens/459949887>
2. <https://projects.invisionapp.com/share/GUX2BJUR8C4#/screens/459949888>
3. <https://projects.invisionapp.com/share/GUX2BJUR8C4#/screens/459949889>

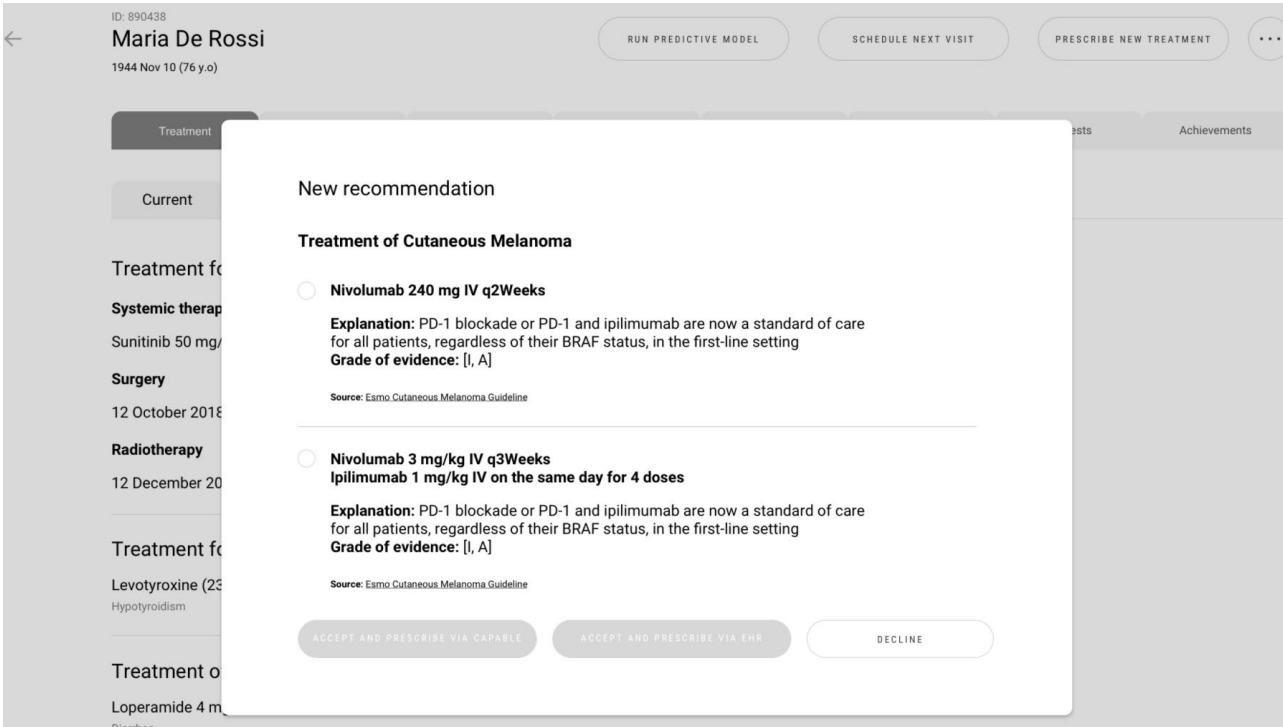


Figure 5.9.66 Patients Profile – Recommendation overview – example of a recommendation that shows two **option sets** with subtitle, explanation, grade of evidence, source, buttons. Buttons under recommendation allow Physicians to accept recommendation or part of a recommendation and to prescribe treatment through either CAPABLE System or hospital EHR. He/she can decline the recommendation.

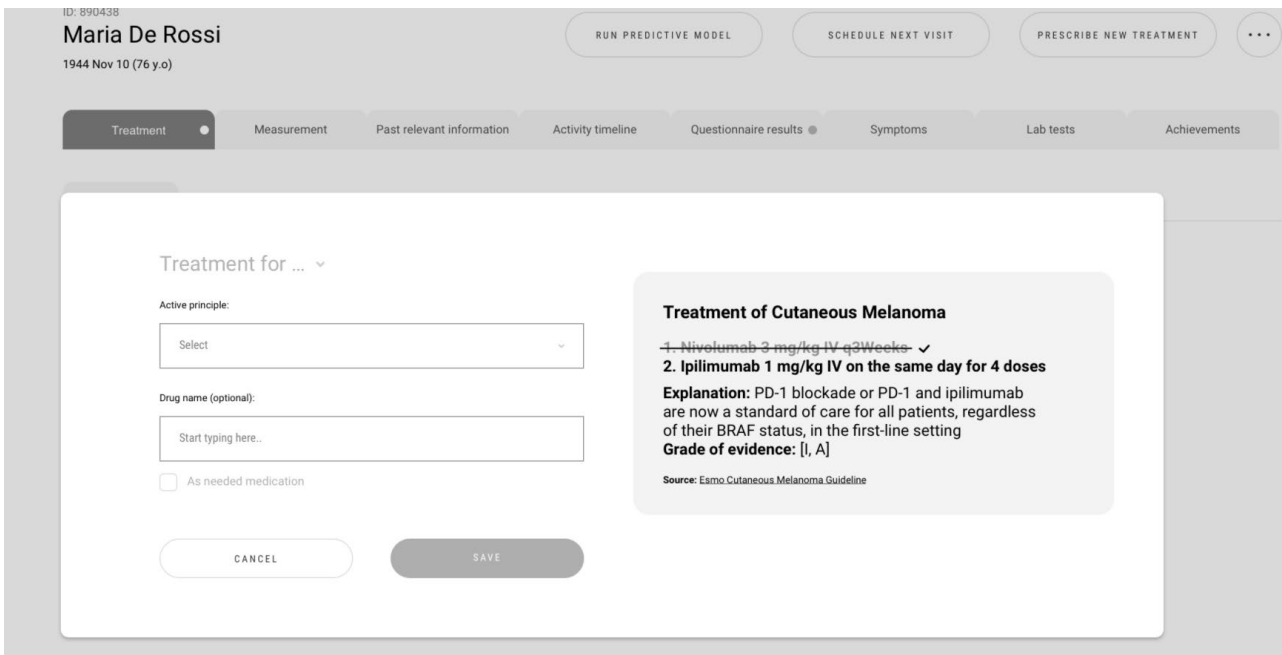


Figure 5.9.67 Patients Profile – treatment prescription through CAPABLE system in accordance with the selected option set, in this example two medications are prescribed one by one in accordance with one received recommendation.

## 5.10. Non-functional Requirements

Based on detailed analysis of all of the requirements gathered from NKI and ICSM (presented in Sections 5.3 and 5.4 and summarized in Section 5.5), as well as on studies of similar systems (see Section 3), on systems that we have previously developed, and on our work as part of the agile development, this section presents a table of non-functional requirements and detailed requirements for the Clinicians side of the CAPABLE system (the Web Portal for the health professional, known as the Clinicians Dashboard). These attributes have been selected following the work of DeFranco (DeFranco et al., 2017) on medical device software and extended for the specific Capable problem domain and project approach. The result of this work can be summarized in in table 5.10 as follows:

Table 5.10 Non-functional requirements (NFR) for the Clinicians Dashboard

NFR	Description	Health professional solution
Patient safety	The overall Capable service must grant patient safety and minimize the risk of errors dependent on the technology. Patient safety can be tracked monitoring the number of incidental findings during the use real use of the system.	Capable system proposed a decision support system that helps the health professional to stratify the patients according to reported health status in a mobile app. To grant the patient safety it is crucial that the system shows in a neutral and sharp way the health status of the system. This will be technically addressed thank to the implementation of guidelines (section 5.6) and generation of system notifications described in the Use Cases (5.8). The overall

		safety will be also revised in the work performed in Wp7 (Deliverable AI ethics and incidental findings policy).
Evidence based recommendation	The overall system must deliver clinically validated contents and recommendations based on standard clinical practice. The system will be assessed considering the guidelines and the validated contents that have been developed into the system.	The Capable system will provide to the patients clinically validated educational contents (from AIMAC sources and other available medical websites). The system for health professionals provides CIG and to support the clinical decision process (see section 5.6).
Conceptual integrity	Coherency in the overall design. This includes the way that components or modules are designed, as well as factors such as coding style and variable naming. The integrity can be assessed by the end users as a dimension of the usability (coherency and representation of real world)	The design of Capable’s solution for clinicians will be always supervised by different technical experts with the participation of the health professional to ensure a design that fits with the user needs and preferences. For this, periodic revision of the technical progress will be done by health professionals. Also, in WP7, activities of periodic assessment of User Experience will be performed to assess the conceptual integrity of the system,
Maintainability	The system must have the ability to change in an easy way facing these changes with the minimum impact in the components and functionalities. Also, fixing errors will have to be done with the minimum impact. The maintainability can be assessed with the time of response to solve specific technical problems, capacity to reproduce the error and redeploy the new improved version of the system in a more transparent way for the end users.	Tracking of errors and memory leaks of the application. Adoption of a log system to track the system status and in case of error help the developer team to fix the bugs with the minimum impact on the overall system. WP7 will also set up the requirement for the management procedures during the pilot and the clinical study.
Reusability	The application must use the components in an efficient way avoiding duplicate components used in different features reducing implementation and run time.	Capable web portal will be designed following a modular approach. Adoption of software engineering methods, modular design of the architecture as described in section 6

<p>Availability</p>	<p>The application must be accessible and functional as much as possible. It can be measured as a percentage of the total system downtime over a predefined period. Availability will be affected by system errors, infrastructure problems, malicious attacks, and system load.</p>	<p>The application will be available for clinicians through a web access and the availability will depend on the Capable infrastructure. The components will be developed taking into account the possible failure of the components. The system will be developed following scalability principles. The availability of the service will be monitored and automatic procedure for service restore will be developed.</p>
<p>Performance</p>	<p>The application must be responsive in order to execute any action within a given time interval measuring this fact in terms of latency. It is considerable a reasonable performance if the health professional page can be loaded in less than two seconds.</p>	<p>The application will be developed looking for the best possible services (proper plug-in and libraries) to avoid bottlenecks and malfunctioning events that disturbs the work practice of health professionals and the timings on the procedures.</p>
<p>Scalability</p>	<p>The system must be scalable to either handle increases in load without impact on the performance of the system, or the ability to be readily enlarged. The scalability can be assessed performing stress and load tests simulating a large number of users. In order to successfully support the final study CAPABLE should be able to support 200 concurrent users.</p>	<p>The system must support the loads of flows generated by a user when using the app. The system must be adapted to the capacity to manage concurrent connections; the server will have sufficient capacity to handle the data flows coming from concurrent patient's app sending data and different health professionals using the web portal. Capable system architecture will be design as described in section 6 in order to be adapted to the different needs of each application and services</p>
<p>Security</p>	<p>Capable needs to provide a secure system that prevents malicious or accidental events outside the normal usage and must prevent the loss of information. In the capable environment it will be a key requirement due to the clinical and personal information managed by the app.</p>	<p>The Capable app will follow the requirements of EN ISO 14971 (2007) – “Application of Risk management to medical devices” addressing risk identification, assessment and acceptability in the use of medical devices in terms of security. In addition, as the tool will be use in a clinical environment, the system must ensure the particular</p>

		<p>requirements in terms of security of each center.</p> <p>The system will follow the requirements described in System integration and security (section 6.12) and data representation and requirements (section 7)</p>
Supportability	<p>The system will provide information to help identifying and resolving issues when it fails and must help the users to understand and perform the correct usage of the application.</p>	<p>The application will provide the necessary contents and guidelines to support the users in case of failure. An information page will be delivered and, if necessary, a set of alerts will be provided for this support.</p>
Testability	<p>It must be created a test criterion for the system and the different components and run these tests to determine if the system works as defined, it will facilitate the isolation of possible faults and to act faster to solve the possible problems. Nowadays tests can be automatized and specific metrics on test (outcome, response time etc.) can be obtained.</p>	<p>The development team will design a set of units, integration, functional and end-to-end tests to be passed before the deployment in the production environment. This test will be automated to rapidly test the fixed errors.</p> <p>All major use cases must be regression tested.</p>
Usability	<p>The application must meet the functional requirements defined for the users and it has to be intuitive providing good access for disabled users and resulting good and attractive in user experience.</p>	<p>The application interfaces and flows must be designed with a user mind and with the interaction with health professionals. Co-design techniques will be necessary to avoid incorporating inappropriate workflows and design patterns in order to give a useful work tool. Capable will design and develop the application following the functional requirements described in section 5.9 and the usability will be assessed thank to the activities planned in WP7.</p>
Certiability	<p>The application must be designed considering the different certifications on medical devices to achieve trust and reliability.</p>	<p>In the same way as the patient application, the solution for clinicians must be developed following the requirements of EN ISO 13485 (2016) “Medical devices: Quality management systems” for medical devices of class I (Software for medical purpose). This requirement will be further elaborated in WP7 for the</p>



		study design and by Wp8 for the further exploitation opportunities in the market.
Privacy	The application must meet the requirements of privacy of mobile applications and medical devices ensuring that the user data is properly protected and follow the guidelines of data protection.	<p>The Capable app will follow the requirements of EN ISO 14971 (2007) – “Application of Risk management to medical devices” addressing risk identification, assessment and acceptability in the use of medical devices in terms of privacy.</p> <p>In addition, as the tool will be used in a clinical environment, the system must ensure the particular requirements in terms of privacy of each center.</p> <p>The system will follow the requirements described in System integration and security (section 6.12) and data representation and requirements (Section 7)</p>

As for the patient's application, the Capable consortium will work also to be able to enable the user rights described in the GDPR directive.

- **Right of access:** The Capable system will grant access to the patient according to the department policy. Only authorized persons will be able to manage the patient and export their data.
- **Right to rectification:** the clinician can rectify any data that are not correct in the clinical Web portal.
- **Right to erasure:** if requested by a patient, the health professional will be able to delete all the data from the database. If a health professional will ask to not have access to the Web Portal the account will be disabled.
- **Right to restrict processing:** the health professional can ask to restrict the processing of some data of the patient.
- **Right to data portability:** the CAPABLE system will manage minimal information of the health professional, so there is no need for data portability. The patients' data will be exported following the policies of the hospital.
- **Right to object:** the health professional can ask to stop the data processing.
- **Rights in relation to automated decision-making and profiling:** the user can ask to stop the Capable decision support system.
- **Right to withdraw consent:** the participant (patient) has the right to withdraw that consent at any time. This will not affect the lawfulness of processing based on the prior consent. The health professional also will have the right to withdraw consent and stop using the Capable system.
- **Right to lodge a complaint with the data protection authority:** If the health professional has a concern about privacy practices, including the way in which Personal Data are handled, they can report it to the data controller that is authorized to hear those concerns.

## 5.11. Barriers to Market

WP8 performed a preliminary analysis of the barriers to market to be taken into account for a successful implementation and further exploitation of the technological results.

Those barriers have been identified and actions to mitigate the risks have been defined. Three types of barriers have been identified, three from the systematic research of Schreiweis et al (Schreiweis 2019):

- **Individual barriers:** they depend on the actors that are involved in the Capable system, patients, caregivers and health professionals.
- **Environmental and organizational barriers:** these barriers mostly refer to problems of the deployment of the system in the hospitals.
- **Overall technical barriers:** these situations depend on the solution that has been deployed.

For every identified type of barrier, a list of possible factors has been identified and possible mitigation actions have been proposed.

**Individual barriers**

The following table shares the barriers that have been identified at this stage of the research.

Table 5.11.1 Individual barriers analysis

Type of barrier	Description	Mitigation
Cognition barriers / e-literacy	This barrier refers to the incapacity of the end users (patients and health professionals) to use the system. This can depend on the incapacity to use the Capable solution and also to be able to learn on how to use the system. The system language can also be a problem.	Set up training activities for the health professional and create a user manual for the end users. Provide the system in the spoken language of the user (Italian, Dutch and English). CAPABLE will use a translation framework provided by UPM called Lokalise ( <a href="https://lokalise.com/">https://lokalise.com/</a> ) that will manage the translation process of the GUIs for health professionals and patients
User's motivation	This happens when the user has not perceived any value in using the system. Another specific barrier can be that some users can be reluctant to use the system because they prefer a more classical healthcare service based on human-to-human interaction.	CAPABLE already adopted user centered design to better craft a system to solve unmet needs of the users. Furthermore, WP2 worked in close collaboration with health professionals and patients and planed periodic assessment of the solution through the WP7 activities (See task 7.2).
Accessibility	Patients and professionals can have some physical impairments that can be barriers for the use of the system. Those physical constraints can be tremors, impaired visions	Apply principle of usability and accessibility in the system design. Exclude patients with severe physical impairments. The criteria of accessibility of the Capable technology will be assessed in the task 7.1 in which the Consortium will define the study protocol and the inclusion criteria (not only clinical).
Lack of trust	This happens when patients are not feeling that the contents and services have a medical validity because they are not well elaborated or incoherent. The health professionals can also not trust the system because the proposed service is not working well and / or because the managed information is incoherent with the real patient	Provide contents in the patient's app that are clinically validated. Perform test and revision of the contents. Plan an overall clinical validation as stated in the DoA. The mitigation activities are on track and managed by WP7. Some preliminary results on the feasibility and effectiveness of the system will be available after the execution of the pre-

	<p>situation. For further commercialization it is crucial that the system demonstrated to be effective improving patient outcomes (e.g., QoL, patient satisfaction with the health care service etc.).</p>	<p>pilot at month 30-36. The final results will come at the end of the project, after the completion of the clinical study.</p>
--	--	---

**Environmental and organizational barriers**

The organizational barriers refer to situations at organizational level (in this case hospitals) that can reduce the adoption of a solution such as Capable.

Table 5.11.2 Organizational barriers analysis

Type of barrier	Description	Mitigation
Resource problem	When there are not enough resources to adopt the solution in the departments.	The mitigation of the environmental and organizational barriers will depend on a proper allocation of resources of the medical stakeholders involved in the project. This will help the proper project adoption and validation of the system during the project lifecycle. For the further exploitation the barrier to the market can be overcome by adopting principles of Health Technology Assessment and Value based healthcare to clearly details the value generated by the system and the required procedures for a proper deployment in real world healthcare systems.
Political barriers	It can depend on the political strategy of the decision maker involved in the purchase and deployment of a new e-health system, for example: prioritization of eHealth services and lack of readiness to implement novel eHealth solutions.	
Missing incentives in the organization	This mostly affects the motivation of the health professional that needs to have recognized the activities to use a novel e-health service.	
Added workload	A new e health system generally adds some workload to the healthcare professionals. In order to achieve a complete acceptance of the new eHealth system it is important to allocate the resources for the proper set up of the new digital service. (e.g. time for the training, time for the patient enrollment, time for the daily use of the digital service).	

**Technical barriers**

The last identified barriers are the technical one, they are presented in the next table.

Table 5.11.3 Technical barriers analysis

Type of barrier	Description	Mitigation
Design is not fitting user needs	this happens when the end users (patients and health professionals) are using a system that is not designed according to their expectations and unmet needs.	Adopt user centered design. Periodically assess the solution with end users (patients and health professionals) as previously commented
Security	Security issues can happen when users have privacy concerns on the type of information gathered and	Adopt principles of security by design (meaning that security specification starts together with the system design) and create

	how it is used. Security can also come from authorities (e.g., ethical committees, security departments etc.) that audit the security of the proposed system.	a platform compliant with GDPR. More details are provided in section 6.12.
System language	The adoption of a system depends on the easiness to understand procedures and messages within the system. It is important that systems present texts and other digital contents in the spoken user language	Provide a system available in three languages (Italian, Dutch, English) and adopt a professional translation platform to enable translation and revision process (e.g., <a href="https://lokalise.com/">https://lokalise.com/</a> )
Missing technical support	the deployment of a system needs to include the activation of a technical support service in order to solve the user problem and grant the continuation of use of the system. Any errors that stuck the user in the system can generate lack of trust and frustration to the user and can affect the overall system acceptability.	Design, develop and deploy a technical support infrastructure to provide technical support during the clinical studies that will be performed. WP7 is in process of defining the protocol to provide the technical support to the patients and to the health professionals.
Missing standard	if a digital service is not supporting medical standards it can be a barrier for further medical certifications and for the integration in other IT health services in the HIS.	CAPABLE project has been proposed as a system that will adopt Health Standard (section 7.1).
Missing system feedback	A new digital service can be demanding for an end user because it can require performing operations that consume time and request a certain level of attention. From the user's viewpoint it is crucial to receive feedback from the system in order to continuously reinforce added value that the system is providing.	Design the patient app as a system that provides a learning experience, in which the user can learn and not just report data. Provide a system for health professionals that gives full vision of the current health status and clearly shows the possible clinical options according to guidelines. Offer full control and understanding of the Decision Support System embedded in the Capable system. The proposed use cases for Health professional and patients have considered the generation of proper user feedback and these needs have been also confirmed by the previous interviews with patients and clinicians, as described in Section 4 and section 5

## 6.. Overall capable architecture

In this section we describe the overall architecture which underlies the CAPABLE project and serves the different actors involved in the use cases described so far.

The main principles guiding the design of CAPABLE system are modularity and decoupling: different component will be developed by different project's partners as separate web services. Most of the interaction between the components will happen for data exchange and events (generated by the patient's data): two components (namely the Data Platform and the Case

Manager) will exclusively accomplish these duties with documented APIs at the service of other components.

In Figure 6 the CAPABLE overall architecture is represented; all the components that will be described in the next sections are present, in particular:

- Data Platform, storing and providing patient-level data (6.2)
- Case Manager, managing events and notifications (6.3)
- KDOM, computing abstractions (6.4)
- Frontend server component, the interface between actual user interfaces and other CAPABLE components (6.5)
- Patient’s application (Patient GUI in figure), user interface for patients (6.6)
- Clinician’s dashboard (Doctor GUI in figure), user interface for physicians (6.7)
- Sensors, providing wearables data to the Data Platform (6.8)
- PROforma, providing CIG Engine and Knowledge Base (6.9)
- Multimorbidity controller, providing decision support for multimorbidity patients (6.10)
- Virtual coach, supporting outpatient cancer management process (6.11)

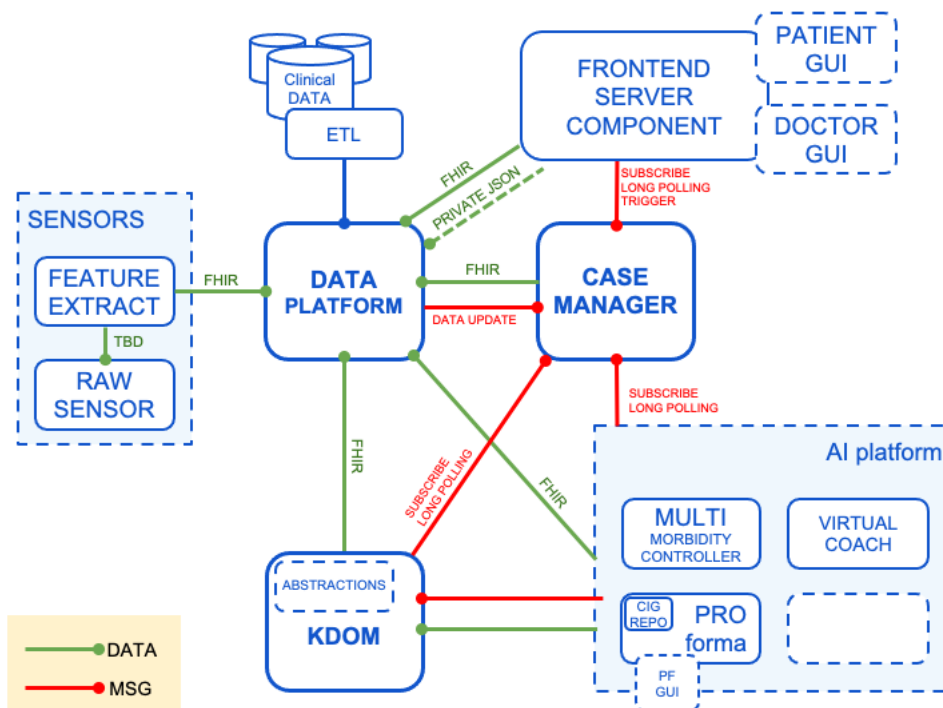


Figure 6 THE CAPABLE architecture

## 6.1. CAPABLE Sequence Diagrams

In Figure 6.1, the main, high-level interaction between CAPABLE components is identified; these interactions are:

- Write patient’s data

CAPABLE components will write patient’s data interacting with the Data Platform. After data creation, Case Manager will be notified about it by Data Platform.

- Read patient’s data

CAPABLE components will read patient’s data from the Data Platform.

- Subscribe to an event

CAPABLE components will subscribe to patient related events through the Case Manager

- Event notification

When events happen Case Manager notifies the component which subscribed it. This notification leverages the REST long polling strategy. This is a well-known approach used to circumvent the traditional client-server paradigm adopted by REST that is inherently shaped after a *pull technology*. It means that the component connecting to the Case Manager and asking for notifications will be put on hold until an event arrives or a timer expires. This virtually turns the interaction into one based on *push technology*.

- Direct communication (between two components)

Two components may communicate between each other by exposing custom REST endpoints.

- Mediated (by Data Platform and Case Manager) communication (between two components)

Data Platform and Case Manager can be used by components also to exchange message, without exposing any REST API on their side

- User interface (backend) private repository (on Data Platform) usage.

A particular document-based data repository will be set up on the Data Platform to be used by the GUIs server component. This repository will be accessed through REST APIs.

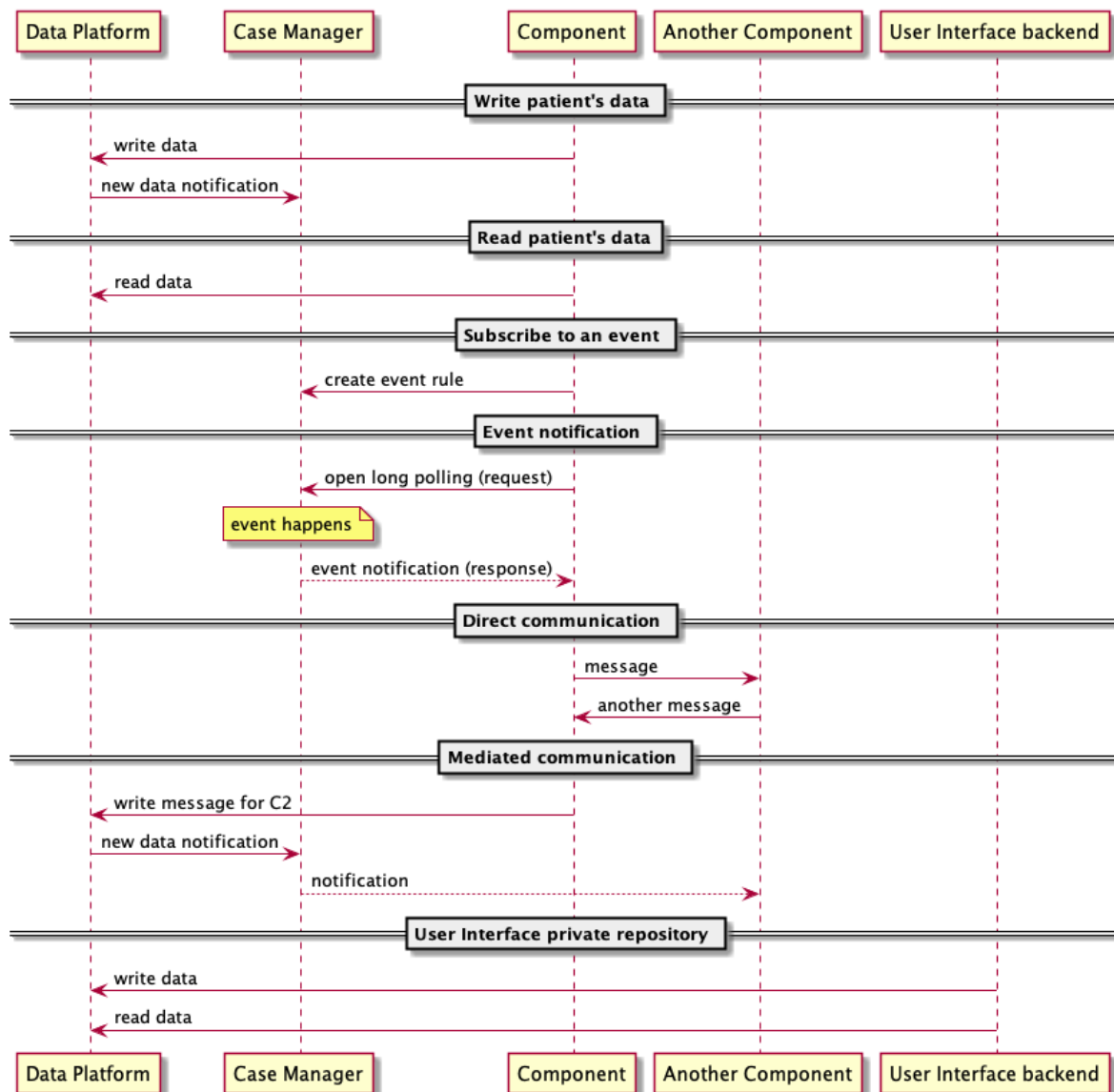


Fig. 6.1 – high level interaction between components

Next sections describe in details all the components and provide further detail on their interactions.

## 6.2. Data Platform

---

### Objective

The main objective of CAPABLE Data Platform is to provide a persistent layer where to store and fetch all patients-related data. To guarantee a state-of-the-art level component we have chosen OMOP as a common data model (CDM) and HL7-FHIR to manage data exchange (both input and output).

The OMOP CDM is composed by different sub-components, among them those that are more relevant to the project are:

1. “Standardized clinical data”, a set of tables containing the core information about the clinical events that occurred longitudinally during valid Observation Periods for each Person, as well as demographic information for the Person. [OHDSI-OMOP-CDM]
2. “Standardized vocabularies”, a set of international standard terminologies which are consolidated into the same common format. This relieves the researchers from having to understand and handle multiple different formats and life-cycle conventions of the originating vocabularies. [OHDSI-VOC]

FHIR (Fast Healthcare Interoperability Resources) *is a standard for exchanging healthcare information electronically* [FHIR]. It is based on a “composition approach” which represents standard clinical entities as resources and allows to represent complex information as the combination of these basic building blocks cross-referencing each other. All project’s data will be exchanged (between data producers and Data Platform and between Data Platform and data consumers) as FHIR Resources using REST APIs. Please refer to section 7 for a more detailed discussion on these topics.

The development of such API layer is one of the developed products of the project: it is aimed at receiving request (both to read and write) for standard FHIR resources, fetch/write the OMOP CDM accordingly and create FHIR-compliant responses.

Another custom functionality of the CAPABLE Data Platform is establishing a private notification channel towards another core component of the system: Case Manager, which is responsible of notifying other CAPABLE components about events they have subscribed to. This private channel is used to notify Case manager about every update occurring to the data base which may possibly trigger an event (REF 6.6).

Finally, Data Platform is also expected to maintain the CAPABLE data base traceable and auditable: we have chosen to limit the data transaction model to Create and Read (thus, avoiding Updates and Deletions) in order to maintain a reliable log of the whole data flow in time.

### Success metrics

- Make all data accessible
- Map all data towards standard (mediated by OMOP semantic layer) or custom coding systems
- Successfully cooperate with Case Manager
- Auditability

### Personas

- Components which need to access single data points
- Case Manager for data update notifications

### Interfaces (High Level Data) - Component level - INPUT

- Data from:
  - Hospital Information System (HIS), with custom ETL (Extract Transform and Load) procedures
  - Other CAPABLE components, through FHIR APIs

**Interfaces (High Level Data) - Component level - OUTPUT**

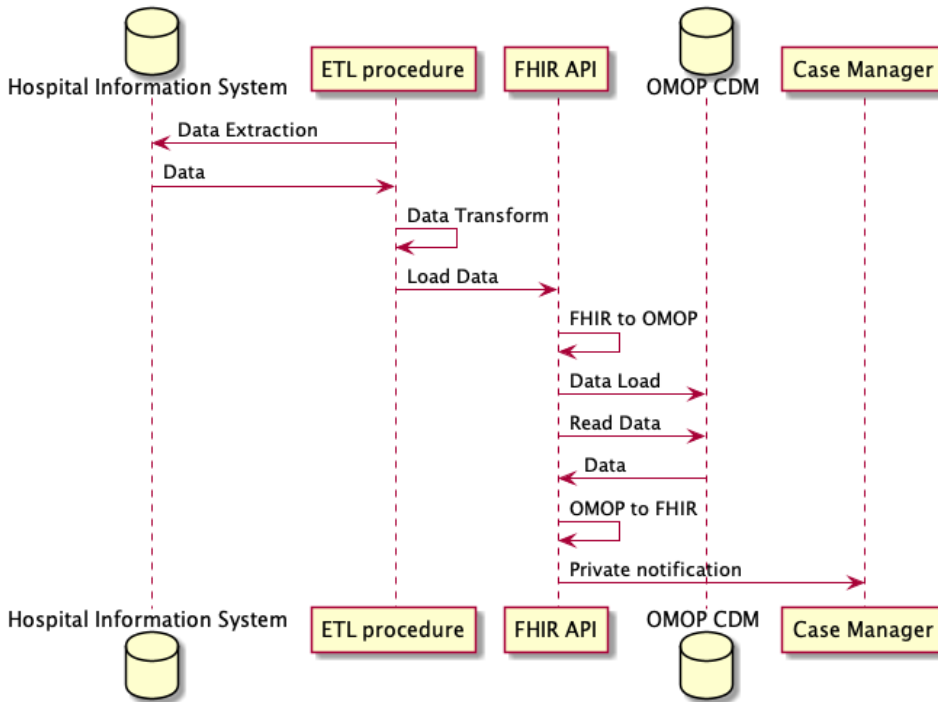
- Patient’s data, through FHIR APIs
- Case Manager for private data notification

**Events (triggers)**

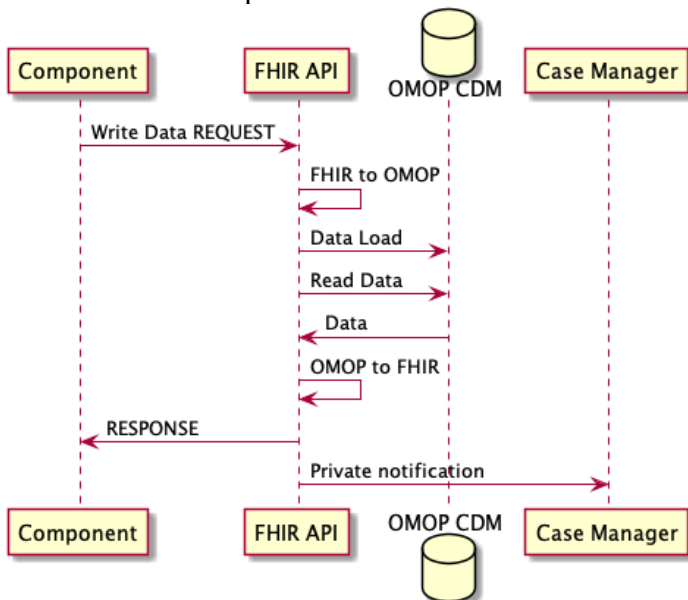
All events related to data are triggered by Case Manager, following private notification from Data Platform.

**Operating model and design**

- Data from HIS are extracted and loaded into Data Platform

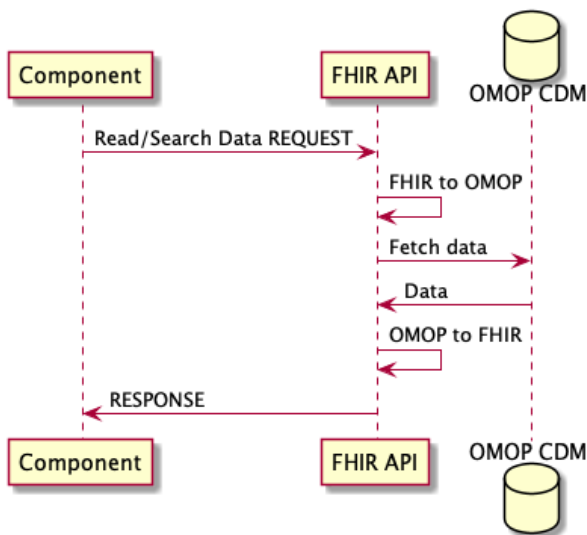


- CAPABLE component writes new data to Data Platform



- CAPABLE component read/searches data in Data Platform





## Features/Requirements

- Store data

Data is received from any CAPABLE component in the form of FHIR Resources. Data Platform performs an on-the-fly transformation from the resource to corresponding element(s) in the OMOP CDM, store it on the database and returns to persisted resource (typically, the input resource added with CAPABLE generated id) back.

- Generate unique identifiers for all persisted FHIR resources

All FHIR resources that are exchanged between components and Data Platform are assigned with a Logical ID [FHIR-ID], composed by the resource’s type (e.g. Patient, Observation) and an integer (which acts as the actual identifier among resources of the same type). The Id generation process is demanded to the OMOP CDM which uses SQL sequences to manage unique identifiers of its types (called “domains”). The process must also be compliant with the possibility that more OMOP domains could be mapped on a single FHIR resource type.

- Direct database access

Data Platform is expected to direct access OMOP database through a JPA-compliant framework relying on JDBC connectors.

- API access (read/search/write)

Data Platform users (i.e. CAPABLE components) will be able to use FHIR APIs through REST. Users are expected to use valid FHIR resources (and valid attributes) among those selected by the project (see WP3) and to precisely reference concepts with their code and coding system.

- Case Manager notification

Data platform will notify Case Manager through a private (i.e. accessible only to Data Platform) endpoint about every new resource persisted in it; this process will occur immediately after the actual insertion of the resource’s related OMOP elements in the database, thus also the resource’s id will be communicated to Case Manager.

## User interface

Data Platform is a Server Component, no UI is expected.

## Release roadmap

- M12 - Iteration 1
  - Features included:
    - *Store data*: **partial** (only a subset of final CAPABLE FHIR resource set)
    - Generate unique identifiers for all persisted FHIR resources: **partial** (only for managed resources)

- *Direct database access*: **partial** (only for managed resources)
- *API access (read/search/write)*: **partial** (only for managed resources)
- Case Manager notification: **complete**
- M18 - Iteration 2
  - Features included:
    - *Store data*: **partial** (only a subset of final CAPABLE FHIR resource set)
    - Generate unique identifiers for all persisted FHIR resources: **partial** (only for managed resources)
    - *Direct database access*: **partial** (only for managed resources)
    - *API access (read/search/write)*: **partial** (only for managed resources)
    - Case Manager notification: **complete**
- M30 - Final release
  - Features included:
    - *Store data*: **complete** (full support for CAPABLE FHIR resource set)
    - Generate unique identifiers for all persisted FHIR resources: **complete**
    - Direct database access: **complete**
    - API access (read/search/write): **complete**
    - Case Manager notification: **complete**

### Deployment info (development)

- Location. Data Platform will be released on a Virtual Machine (one VM for each CAPABLE Component).
- Component architecture description. The Component will be implemented as a J2EE service.
- Architecture technical details (Hardware). Deployed on an Amazon AWS EC2 server. Hardware specs will be adapted to actual workload.
- Architecture technical details (Software). Centos-7 operating system, Java 8, Tomcat 9, PostgreSQL 10.

### Deployment info (production)

- Location. The location will be compatible with CAPABLE deployment strategy.
- Accessibility. All the CAPABLE server components will use the Data Platform.
- Communication. Communication will be manager with FHIR messages on REST.
- Component architecture description. The Component will be deployed as a single WAR module + PostgreSQL database.
- Architecture technical details (Hardware). Hardware specs will be adapted to the production-stage level workload of the project
- Architecture technical details (Software). Centos-7 operating system, Java 8, Tomcat 9, PostgreSQL 10.

## 6.3. Case manager

---

### Objective

The CAPABLE Project foresees a reasoning model involving several independent Components, each of them encapsulating specific knowledge represented through the most suitable formalisms and exploiting different Artificial Intelligence techniques. All those Components cooperate implementing a shared patient management process which is dynamically constructed on an opportunistic basis, following the incremental addition of information to the Data Platform. Case Manager is responsible for shaping up this opportunistic reasoning process by continuously monitoring the occurrence of Events in the Data Platform and dispatching those to the interested Components.

More specifically, new information concerning a patient may become available in the Data Platform upon the following circumstances: after a scheduled visit; registered directly by the patient; generated by monitoring sensors; or when it is inferred as the result of applying knowledge of any Component being invoked.

Each Component hosting a Knowledge Source specifies a set of Events in terms of a combination of facts about the patient (e.g. raw observations, trend predictions, next activities foreseen by a guideline, etc.). Case Manager is then responsible for detecting the occurrences of those Events as soon as they appear in the Data Platform so that the Component hosting the interested Knowledge Source may be promptly notified. Upon notification, the Knowledge Sources are free to scan the patient's data looking for additional information. Finally, they process all the information retrieved to provide further interpretations that are stored back on the Data Platform. The goal is to help clinicians in managing the patient or provide coaching and recommendations to the patients in order to support them in improving their adherence to the treatment.

To simplify the design, implementation and management of the CAPABLE eco-system, a modular architecture has been chosen. According to this paradigm, Knowledge Sources are developed as pluggable Components that can be added or removed from the system without disrupting its overall reasoning ability. The basic assumption to achieve this goal is to decouple each Component from all the other ones. This prevents the onset of an unmanageable web of links among them, each one adopting a different protocol and syntax for exchanging messages. Instead, the Components and the Knowledge Sources may only interact through the Data Platform. The latter is seen as a blackboard system where any relevant information concerning a patient is published by a Component and subsequently read by any other interested one.

While this approach effectively simplifies the acquisition of patient information by the Components it also raises a new problem. How can the Components become aware of new data stored on the Data Platform as soon as they appear? Even though conceptually this could be solved by continuously polling the Data Platform for new information, such an approach is far from being optimal.

On this basis, the Case Manager has been conceived for managing the message control flow towards the Components. Thus, the Case Manager is the only Component allowed to directly message any other one, promoting on the technical side a clear design and uniform protocol. The introduction of the Case Manager also achieves a great improvement on the methodological side as it provides a way to guide the reasoning process flow within an opportunistic distributed system such as the one envisioned by CAPABLE.

The proposed approach is based on the identification and subsequent notification of suitable Events. Those are generated within the Case Manager each time new relevant data becomes available (raw data, abstractions, partial interpretations, etc.). Defining Events requires a suitable specification language in such a way that the Knowledge Sources can easily tell which ones they are interested in. Thus, Knowledge Sources register with the Case Manager for specific Events, so that they may receive notifications when their Events of interest occur.

The Case Manager must be able to access the Patient Data Platform and fully understand its contents exploiting it for checking Event occurrence. However, to guarantee the prompt notification of Events as soon as their relevant data are acquired, the Case Manager is notified by the Data Platform whenever new information is entered.

We believe that the introduction of the Case Manager effectively decouples the data flow from the control flow encapsulating the information required to resume the reasoning process of a certain Knowledge Source that has been previously "paused" waiting for new information on the patient's side to become available.

### **Interfaces (High Level Data) - Component level – INPUT**

Definitions of events of interest by the Components in the form of Rules to be monitored.

### **Interfaces (High Level Data) - Component level – OUTPUT**

Events triggered by the data showing up in the Data Platform.

### Operating model and design

In order to achieve the functionality described in the previous sections, the Case Manager has been designed to sit between the Data Platform on one side and the various Components of the CAPABLE system on the other, interacting with all of them.

At the semantic level, interaction among components is facilitated by the enforcement of a data normalization process and the adoption of standard protocols. Those are becoming key issues for an effective data integration also in health care, with HL7 FHIR (Fast Healthcare Interoperability Resources) being perhaps the most promising emerging standard for that purpose.

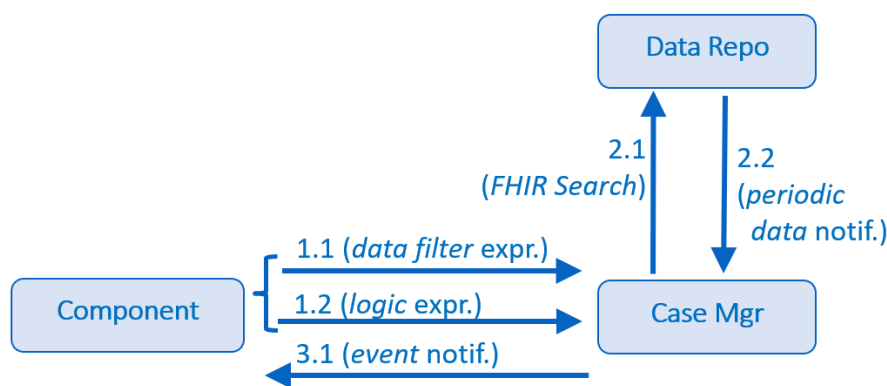


Figure 6.3.1. Communications diagram illustrating the Case Manager operation model

The interaction paths involving the Case Manager are shown in the Communication Diagram depicted in Figure 6.3.1. As shown in that diagram the interaction needs of the Case Manager address the following three areas:

- A well-defined subscription language through which the Components inform the Case Manager about the Events of their interest (connections 1.1 / 1.2 in Figure 6.3.1). Events are represented as combinations of facts that can be either raw data or partial interpretations concerning the patient clinical state. Thus, the Components must define and register those Events with the Case Manager to be properly notified about their occurrence;
- A FHIR link is used for connecting the Case Manager to the Data Platform, so that it can query and retrieve patient's data exchanged as FHIR resources. In this way, the Case Manager is able to search for them at any time and also be informed when new resources become available, checking if the conditions for triggering Events are met (connections 2.1 / 2.2 in Figure 6.3.1). In order to interface directly with the Data Platform, the Case Manager has been designed to be FHIR-compliant and able to manipulate FHIR resources internally. For implementing the link with the Data Platform, the Case Manager uses the HAPI FHIR R4 library (version 4.2.0), which is an open-source implementation of the HL7 FHIR specification for Java.
- A notification engine through which the Case Manager informs the Components about the occurrence of the Events of their interest (connection 3.1 in Figure 6.3.1).

Analyzing in a greater detail the operations that the Case Manager must carry out with reference to Figure 6.3.1, it turns out that it should first acquire the expressions defining the Events provided by the Components. Those include filters for retrieving patient data from the Data Platform, expressed

in terms of FHIR search conditions. However, they also include the logic testing the retrieved resources for Event occurrence, which is expressed in terms of JavaScript code.

Search conditions and logic build up the Rules that the Case Manager scans upon every change in the Data Platform. Thus, search conditions are rendered as FHIR search expressions retrieving the resources that are represented as an array of JSON objects tested by the logic. Logic expressions build up "goal satisfaction trees" starting from the evaluation of operands/operators/sub-expressions of the main expressions. While fetching data and checking Rule logic, the Case Manager generates partial goal satisfactions that are cached to avoid excessive strain on the Data Platform. The Case Manager builds an evaluation tree for each Event that it has been instructed to watch and parses each new advertised resource to check if it may help in progressing toward triggering an Event. Finally, at the link level, all interactions between Components and the Case Manager take place leveraging the REST standard. We make use of Postman as a debugger to easily send REST requests to the server directly from there. Postman is an API development platform and is convenient because, when the client sends an HTTP request, it displays the status code, the response time and the response size.

By exploiting the logic of Events, the Case Manager can also be used as a message broker between the Components, providing them with a private channel of communication: a Component wishing to send a message to another one must write in the Data Platform an instance of the FHIR Communication resource having the recipient code as "category" and the string containing the actual message and the sender as "payload". In this way, the target is immediately notified about the arrival of a new message for him.

### Solutions

Supporting the CAPABLE system Components in instructing the Case Manager about their own Events of interest required the definition of a shared expression language. Using this language, the Components may encode Rules, with each one of them representing the conditions for triggering the Event. Thus, registering for Events implies that Components send to the Case Manager a JSON directive representing a Rule.

Rules Management. Communication between CAPABLE Components and the Case Manager takes place synchronously via REST queries. This solution appears to be the best one because FHIR is based on REST, so we are already using it.

The main REST endpoints that the client Components must use to interface with the Case Manager (server side) are two: "rule" and "event". The "rule" endpoint is used to manage the Rules of interest for the Components. Figure 6.3.2 shows the sequence diagram for managing Rules and subscriptions with the Case Manager through REST calls made by the Components. The main activities that the client Components carry out using the "rule" endpoint are as follows:

- register a new Rule with the Case Manager, creating it through the required JSON syntax;
- access the list of the active Rules (each Component can only see its own Rules, not those of others);
- fetch a single Rule of the list;
- deregister with the Case Manager deleting a Rule.

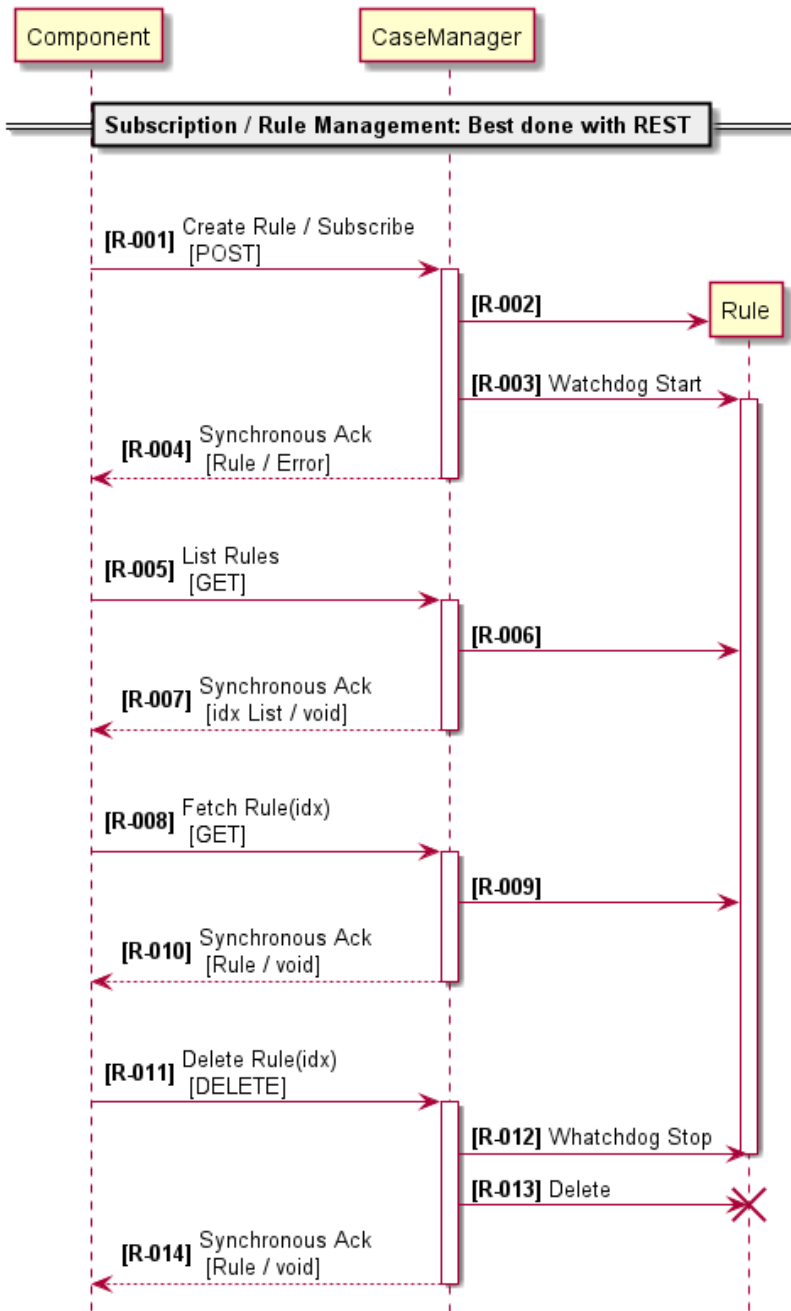


Figure 6.3.2. Subscription and Rule management through synchronous REST calls by Components

Event Management. The Case Manager informs the Components generating Events whenever a Rule is triggered. Just like managing Rules, Event notification is also accomplished synchronously via REST. Accessing Events through REST requires that Components repeatedly query the Case Manager via HTTP requests to check about their availability. To avoid an excessive CPU and network waste a long-polling technique will be implemented.

Figure 6.3.3 shows the sequence diagram for managing the Events, generated by the Case Manager, through REST calls made by the Components. The main activities that the client Components can perform using the "event" endpoint are the following:

- access the list of all activated Events corresponding to their created Rules (each Component only sees its own Events of interest, not those of the others);
- fetch a single Event from the list;
- delete a single Event among those that have occurred.

The Components cannot create the Events because, unlike the Rules, they are generated by the Case Manager. For each fired Event, the Case Manager returns all the instances of the resources that contributed to the Event activation, that is, the resources found in the Data Platform that meet the search filters requirements of the corresponding Rule.

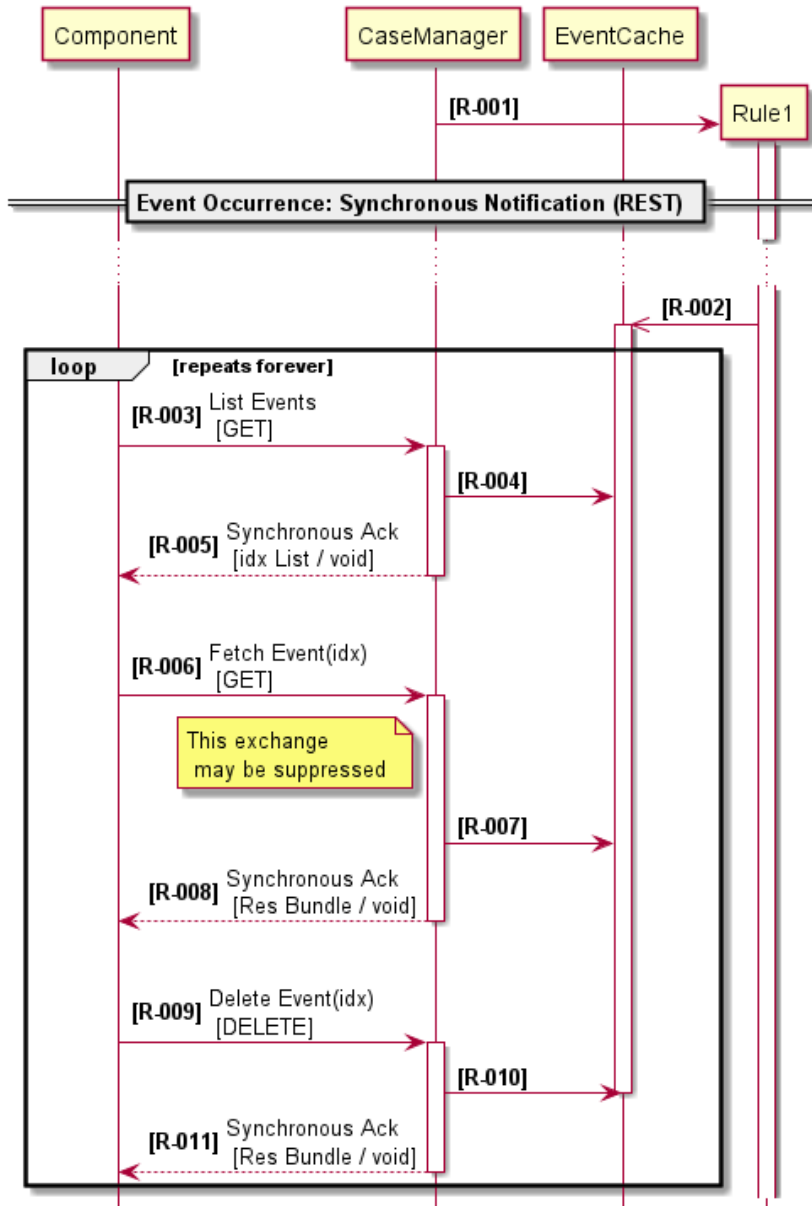


Figure 6.3.3. The (synchronous) REST way of notifying Components

**User Interface**

Case Manager is a Server Component, No UI is expected.

**Release**

Case Manager V1.0 (October 2020).

**Deployment info (development)**

**Location.** Case Manager will be released on a Virtual Machine (one VM for each CAPABLE Component).

**Component architecture description.** The Component will be implemented as a J2EE service.

**Architecture technical details (Hardware).** Deployed on a Unix. Bandwidth and other requirements depend on the Case Manager use by the other Components.

**Architecture technical details (Software).** Debian Virtual Machine to start with. Additional way to package this Component may be considered as the whole CAPABLE architecture evolves.

#### **Deployment info (production)**

**Location.** The location will be compatible with CAPABLE (it may be either Virtual Machine inside hospital or Virtual Machine outside).

**Accessibility.** All the Components wishing to be notified about Events will use this Component.

**Communication.** All the Components wishing to be notified about Events will use this Component.

**Component architecture description.** The Component will be deployed as a single WAR module.

**Architecture technical details (Hardware).** No special requirement emerges at design time on CPU/Memory/Disk/Bandwidth.

**Architecture technical details (Software).** No License required. Case Manager is developed in Java with open source libraries.

## 6.4. KDOM

---

**Introduction.** The CAPABLE system will provide decision support via multiple components: evidence-based Computer-Interpretable Guidelines (CIGs) for supporting clinicians' decision-making delivered via GoCom and the Deontics (PROforma enactment) Engine, as well as evidence-based recommendations and life-style wellbeing support delivered by the Virtual Coach to patients. All of the decision-support components reason at the level of abstractions over raw patient-data that is stored in CAPABLE's semantically integrated Data Platform. The challenge is that there exists a semantic gap between the abstractions used by the DSS components and the raw data stored in the Data Platform. The goal of Knowledge Data Ontology Mapper (KDOM) is to close this gap.

**Objective:** allow CAPABLE component to query the Data Platform in terms of clinical abstractions.

#### **KDOM's subcomponents:**

KDOM has design-time and runtime subcomponents. The **Design-time Abstraction Editor** will allow modelers to define the needed mappings of medical abstractions to raw data. This will be done by instantiating mapping classes from a **Mapping Ontology**. For 1:1 mappings, suitable standard patient data classes will be instantiated. In CAPABLE, the standard is FHIR but the component will be developed in a generic way to allow other data models to be used if desired. For hierarchical mappings, a **Terminology Service** will be used to instantiate the queries as a disjunction of all relevant vocabulary codes. After the mappings have been defined, the **Design-time Query Generator** will produce respective template FHIR search queries (<https://www.hl7.org/fhir/search.html>, 3.1.12) for querying the Patient database in terms of relevant abstractions and will store them in **KDOM's Knowledge Base**.

At runtime, different components of the CAPABLE system (e.g. Case Manager, Virtual Coach, Physician DSS) or users (e.g. Physician) who will need to query the Data Platform in abstract terms will communicate with **KDOM's Runtime Component**, which will complete the respective template query that was generated in design time and will fetch the results and return them to the component. To complete the queries, the patient's ID and the current time will need to be entered. Figure 6.4.1 illustrates how KDOM can compute an abstraction for the Virtual Coach component.



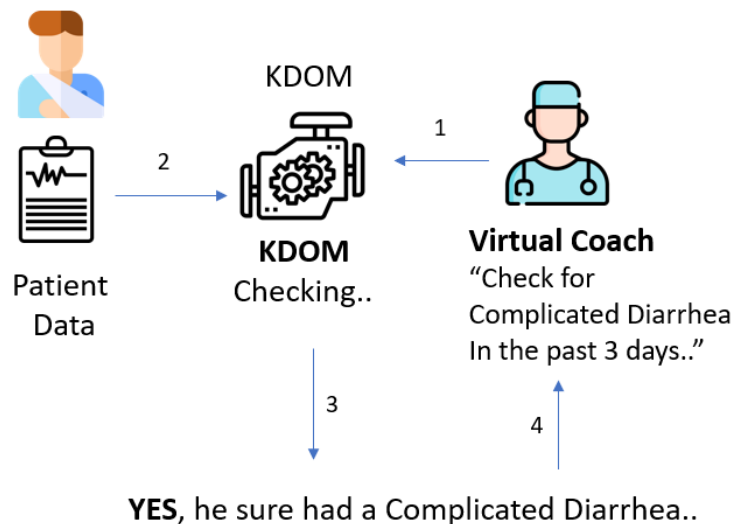


Figure 6.4.1. An illustration of KDOM’s service

### Success metrics

- It would be possible to use KDOM’s Design-time Abstraction Editor to instantiate mappings for the set of abstractions used in CAPABLE.
- The KDOM’s Design-time Query Generator will produce, ahead of time, correct queries – validated against gold standard.
- During runtime, KDOM will respond to triggers and synchronous calls and will complete the respective queries and will run them against the Data Platform and communicate back to the Case Manager, which will pass the results to the Data Platform and to the components that activated KDOM synchronously.
- Functional evaluation will be performed by running these queries against the Data Platform for the CAPABLE abstractions and checking that correct results are returned, as compared to the Gold Standard, that will be developed by the CAPABLE Modeling Team.

**Personas:** Within CAPABLE, the activation of KDOM Runtime Component will be by components and not human users. Modelers from the UoH team will use KDOM's Abstraction Editor to define abstraction via mapping ontology instances.

**Interfaces (High Level Data) - Component level – INPUT:** Abstraction name/id to execute, abstraction parameters

**Interfaces (High Level Data) - Component level – OUTPUT:** Abstraction results (strings, tables, numbers, xml, json, HL7 objects)

**Events (triggered by):** Virtual Coach, Case Manager, External Event.

**Events (triggers):** Case Manager, Data Platform

### User Flow and Design:

The Sequence Diagrams below present the interaction between KDOM and other components.

Receiving a request to compute an abstraction. In Figure 6.4.2, we see how KDOM is asked by a component (Virtual Coach) via writing the private Communication message to the Data Platform, which is delivered by the Case Manager (CM) to KDOM) to calculate an abstraction (complicated diarrhea – flows M-005 through M-007). This is done in practice via a pooling mechanism described in the next subsection about the Runtime Component of KDOM.

Computing abstractions and answering the component who asked for it. KDOM retrieves the data from the Data Platform (M-008). (a) If data is available to compute the abstraction KDOM will compute the abstraction and will save it to the Data Platform (M-009). It will then store a Communication message so that the requesting component could be informed that the abstraction

was computed and stored (M-010); (b) If data is not available, only a communication message will be stored. It will inform of the unknown data items that need to be collected. See paragraph below. Flows M-013 is a shortcut notation for flows similar to M-005 through M-007, and in this case, involve the request to calculate the abstraction of Persistent Diarrhea, for which data about diarrhea in the past 3 days needs to be available. Flow M-014 is similar to M-008 in which KDOM retrieves the needed data. However, data for 2 days is missing. So similar to case (b) above, KDOM returns in M-015 a Communication message that informs of the missing data.

In M-026, the VC knows that data for Persistent Diarrhea is available now, and asks in a private Communication that KDOM will compute it again. This message is similar to M-013. Now, as was the case for the Complicated Diarrhea, KDOM queries the data (M-027 as in M-014 and in M-008), and stores the abstraction in the Data Platform (M-028 similar to M-009) and also stores the Communication that the abstraction was computed – in the Data Platform (M-029 similar to M-010).

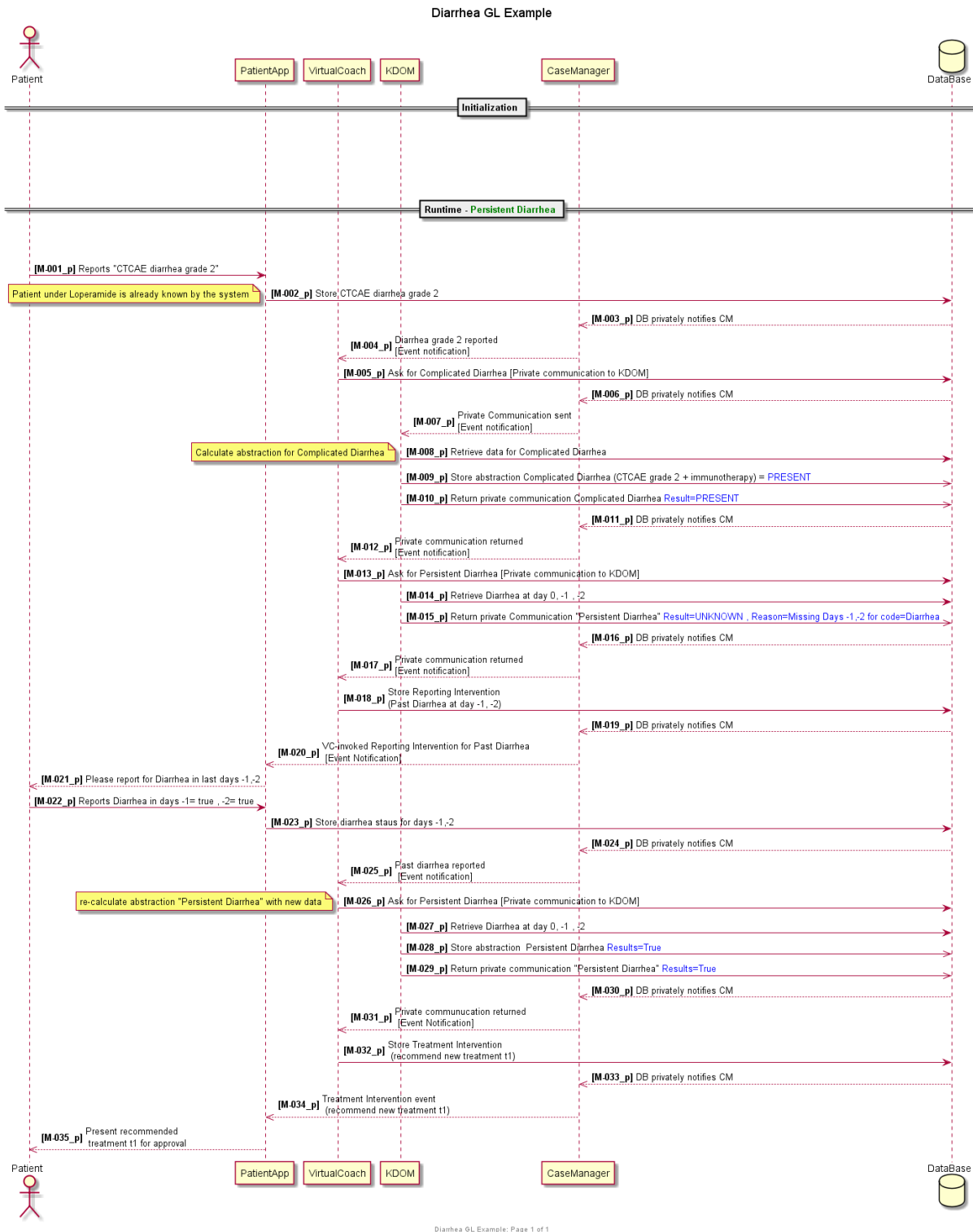


Figure 6.4.2. Virtual Coach dialog with KDOM for computing the complicated diarrhea and the persistent diarrhea abstractions.

Features of the Design-Time components:

- Mapping classes (or mapping ontology) that defines the types of abstractions supported.
  - As in the previous generation of KDOM, 1:1 mappings and logical mappings will be supported.
  - 1:1 Mapping classes include a property for specifying a terminology code (can be local code or standard vocabulary code).
  - Support for conversion of units of measure.

- Compositional abstraction class for creating complex abstractions that refer to simpler abstractions.
- The classification hierarchy support will be based on terminology services and will not duplicate terminologies as part of the mapping ontology.
- Robust temporal support will be provided by a full set of operators equivalent to temporal logic operators such as Exists (in the past or future) and Always, with time bounds.
- Ability of mapping instances to refer to some EHR (in our case, the Data Platform).
- Ability of mapping instances to refer to some Global Patient Data Model (e.g., HL7 FHIR) when defining ontology mappings) to support the Global-as-View data integration pattern.
- An Abstraction Editor for easily defining the abstractions using the mapping classes and by:
  - Referring to a patient data model (e.g., HL7 FHIR) classes and attributes when specifying the parameters for the abstraction queries. Selecting a class will include forms for attaching values for defining the abstractions. See UI requirements below.
  - Selecting standard terminology codes from SNOMED-CT and potentially other terminology systems.
  - The classification hierarchy support will be enhanced by linking to terminology services and retrieving codes from them.
- A Design-time Query Generator that will automatically generate the template queries (in CAPABLE's case, in SQL) for the abstraction definitions and store them in KDOM's Knowledge Base.
  - Architecture supports different query languages for output, but will be tested with one that will be used in CAPABLE
- KDOM's Knowledge Base will store the template queries (abstraction definitions).
- The Runtime's component:
  - Completion of the template queries by instantiating the patient ID and current time.
  - Ability to connect (to receive/send back triggers and data) to/from CAPABLE components
  - Ability to connect to the CAPABLE Data Platform
  - The communication with the Data Platform (via HL7 FHIR APIs) will be implemented using RESTful client and querying the data platform (FHIR DB) will be performed by HL7 FHIR Search mechanism

## Features of KDOM's Runtime component

KDOM Runtime layer is designed to:

- Execute search queries
- Build query results based on multiple resources.
- Send results messages to the registered components (e.g. VC, GoCom)
- Listen to events of callers' components
- Read/Write data from/to Data Platform (FHIR)-based JSON format.
- Support Data flow logging

The KDOM Runtime mechanism is based on Restful client which can be located anywhere (based on the Internet) and can send/receive standard HTTP requests (GET, POST, etc.). The FHIR API has a built-in mechanism for search and query execution, based on JSON format.

KDOM Runtime Component is activated through notifications from the Case Manager (CM). KDOM is listening to the external events by querying the CM (using pooling method, every 30 seconds).

When a component issues a new Abstraction calculation request, it specifies the ID of the Abstraction. It delivers it to the CM. KDOM pools this request from the CM, which includes the Abstraction ID and Component ID, and patient ID.

KDOM will query the Data Platform for the needed data to calculate the abstraction. If data In addition to capturing the flow in the Data Platform using Observation and Communication FHIR resources as specified above, the data flow is also captured in KDOM’s Runtime component Log for audit purposes. All data transformation is secured by SSL standard and located in unified platform (Amazon AWS), which is protected and secured and conforms with HIPAA regulations.

### User Interface ideas for the Design-time Abstraction Editor

The figures below show examples of how we envision the Abstraction Editor and the resulting query generated by the Query Generator for different types of mapping classes.

The Abstraction Editor will refer to a mapping ontology (Figure 6.4.3) defining different mapping classes and a global standard patient information model, which in our case is HL7 FHIR.

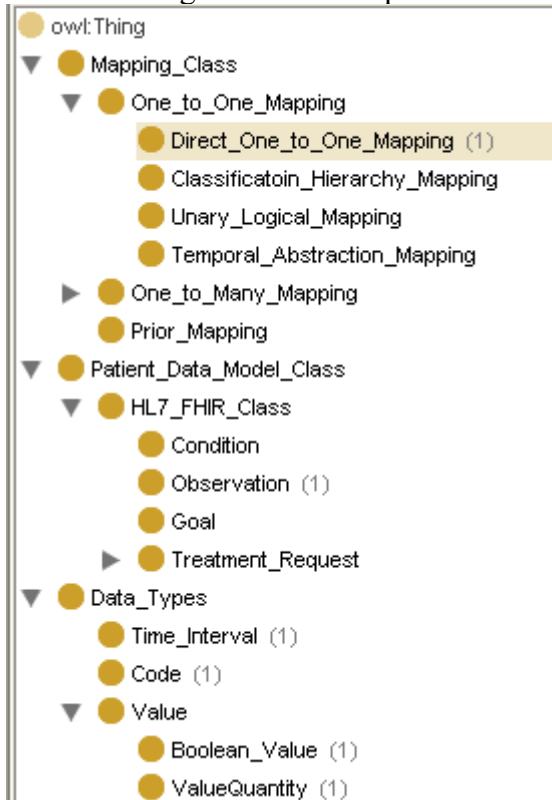


Figure 6.4.3. The mapping ontology of KDOM

Figure 6.4.4 shows how the Abstraction Editor could be used to define a 1:1 mapping between part of the K2 abstraction of the DEMO Scenario “Diarrhea CTCAE grade 2 occurring today” and the FHIR representation used by CAPABLE’s Data Platform for an Observation class. Similarly,

Figure 6.4.5 shows how the Abstraction Editor could be used to define the logical mapping Complicated Diarrhea := Diarrhea CTCAE grade 2 diarrhea occurring today AND Immunotherapy is TRUE. This corresponds to the K2 abstraction of the DEMO Scenario.

Finally, Figure 6.4.6 shows a more complex query: it is a temporal and hierarchical abstraction of “Persistent grade 2 Diarrhea”, which means Diarrhea grade 2 (hierarchical) lasting during each of the past 3 days (temporal). It is similar to the K3 abstraction of the DEMO Scenario.

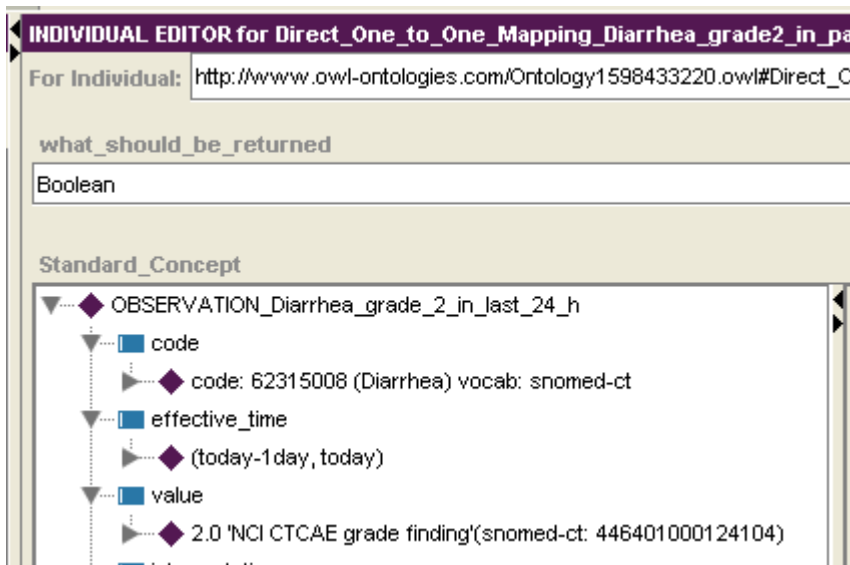


Figure 6.4.4. Abstraction Editor showing how 1:1 Mapping can be defined for **Diarrhea CTCAE grade 2 occurring today**, by instantiating the properties of what the query should return (SELECT) and the definition of the abstraction relative to FHIR Observation resource.

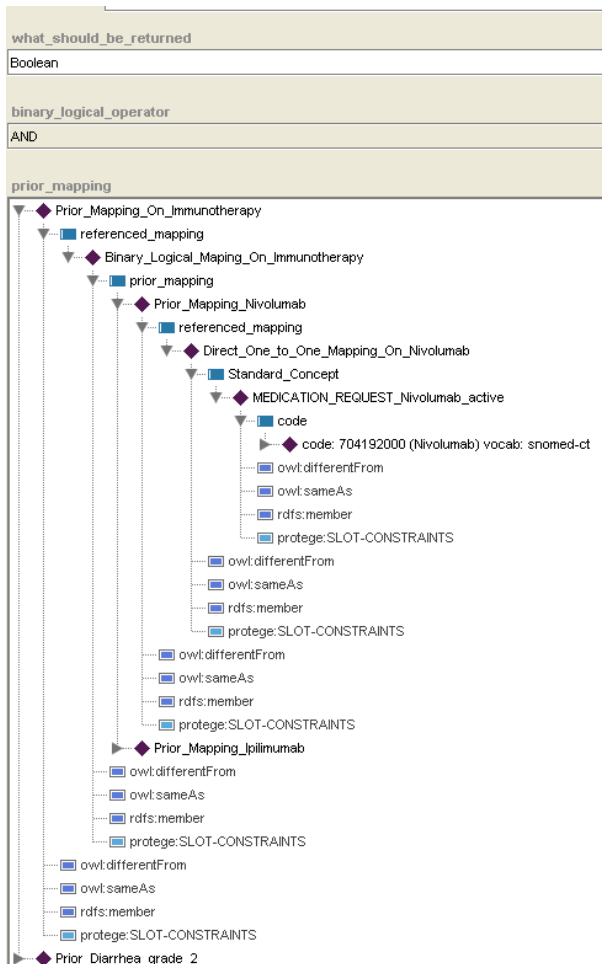


Figure 6.4.5. Abstraction Editor showing how Logical Mapping can be defined for “**grade 2 Diarrhea occurring today and On Immunotherapy**”.

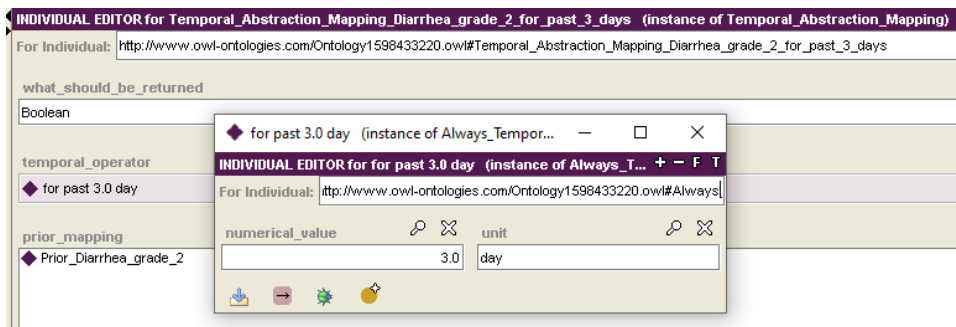


Figure 6.4.6. Abstraction Editor showing how Temporal Mapping example can be defined for “Diarrhea grade 2 during each of last 3 days”. This is done using the temporal operator Always (in the past).

### Architecture for the Runtime Component

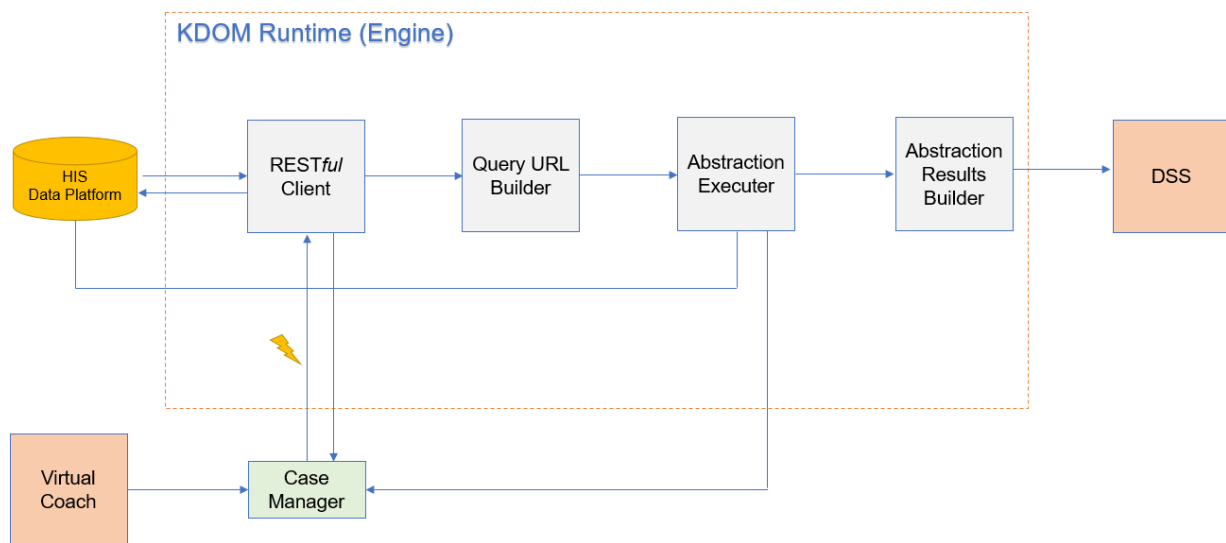


Figure 6.4.7. System Architecture Diagram

Release (Roadmap, not for tracking)

**Release** KDOM V1.0.0.0

**Date** 2021-01

**Features:** KDOM Runtime component – phase 1

Milestones: First

**Dependencies:** CM, VC, GCom, DataPlatform

**Architecture technical details (Software):** Java based, SQLite DB, Restful Client, FHIR Search mechanism.

Deployment Info (development)

**Location:** VM on windows 10 or Windows Server can be physical or VM

Component architecture description Java 1.8

Architecture technical details (Hardware) CPU: Core i5, MEM: 4Gb, SDD: 250Gb, Bandwidth: 100Mb

Architecture technical details (Software) Windows 10, Java 1.8, SQLite, HL7 Restful Client, OpenEHR Client.

## 6.5. Frontend server component

### Objective

Frontend system is to provide users of the system (patients and doctors) with tools to access CAPABLE system according to their needs and roles. Main features and goals that were taken into consideration while building and planning are:

- patient reporting
- tracking and visualization and summarization of progress
- gamification to motivate adherence to behavioral change recommendations
- reminders and scheduling
- mental and social “capsules” recommendations
- providing patient education
- clinical recommendations
- allowing communication with clinicians.

### Frontend proxy server component (FPSC)

The main two objectives of the component are:

- to manage the connection of the external clients (mobile and web) to the CAPABLE system functionality of Data Platform, Case Manager
- to manage the users (patients and doctors) notification functionality.

For the component we have chosen Debian 10, PHP 7, Laravel framework, Nginx. As a data storage we shall use the CAPABLE Data Platform component through its API or with direct private connection (if applicable) to use the separate database schema.

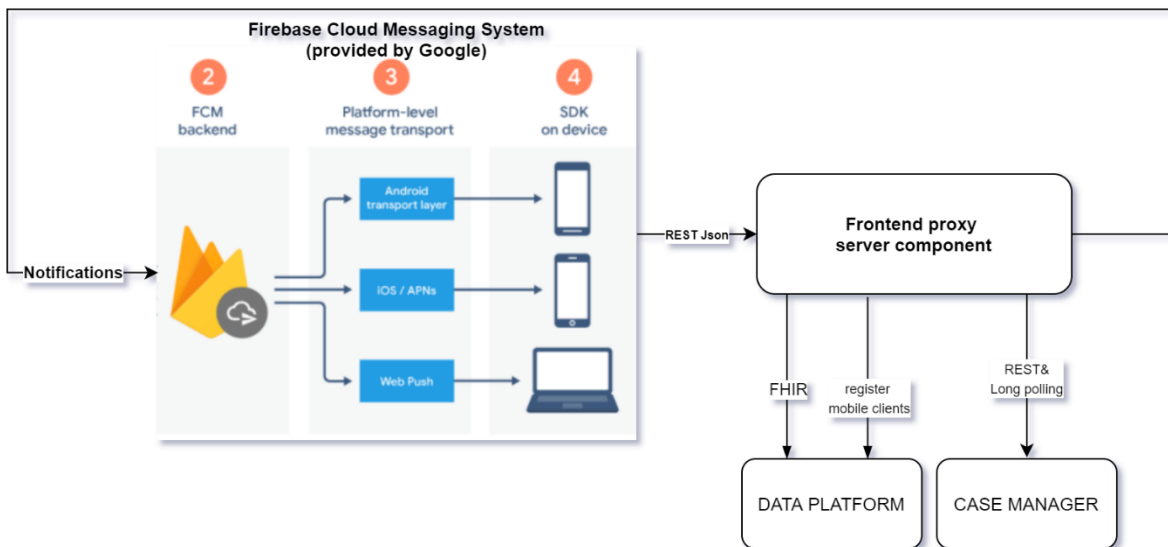


Figure 6.5.1. Overall architecture of Frontend components

To achieve the first objective FPSC will provide public REST JSON API for the mobile and web applications. FPSC itself will use private connection to the Data Platform and Case Manager components through protected, private channel. Standard APIs developed on Data Platform and Case Manager side will be used for the scope.

To achieve the second objective FPSC will be integrated with public Google Firebase Cloud Messaging API and use CAPABLE Data Platform as a data storage.



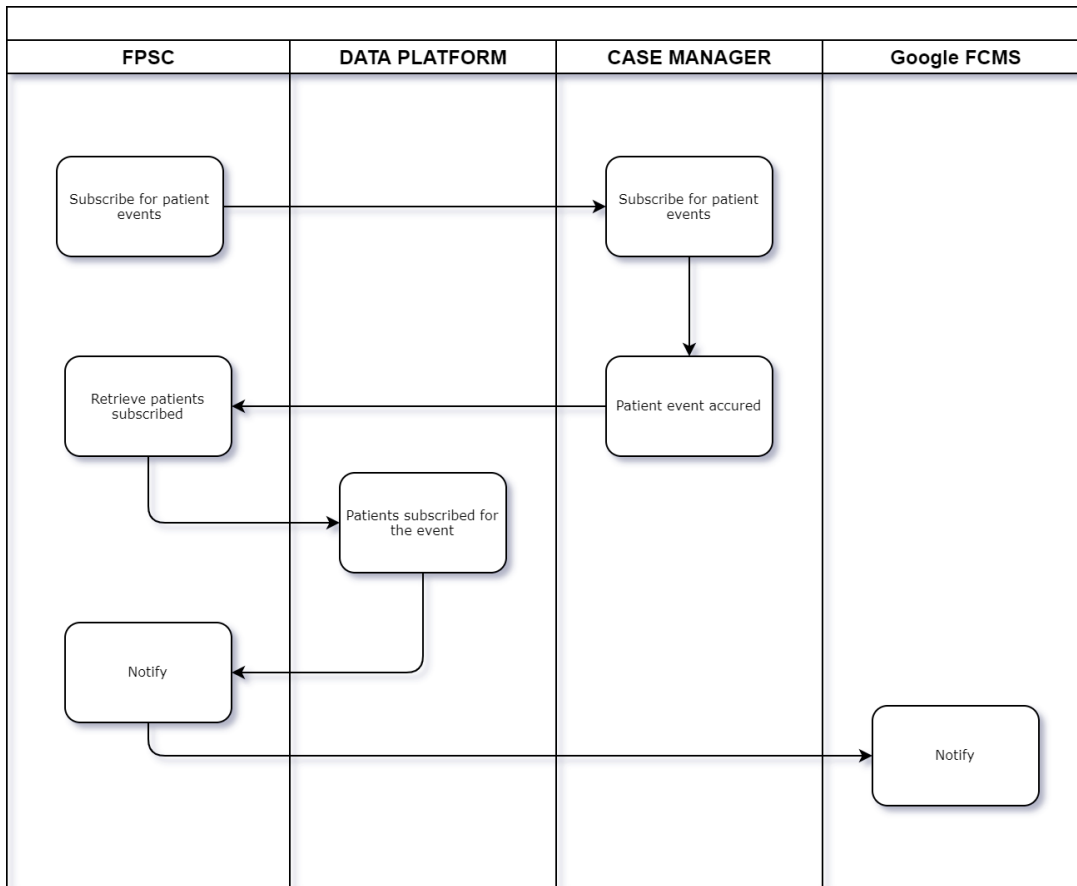


Figure 6.5.2 FPSC subscription and notification for the patients flow example

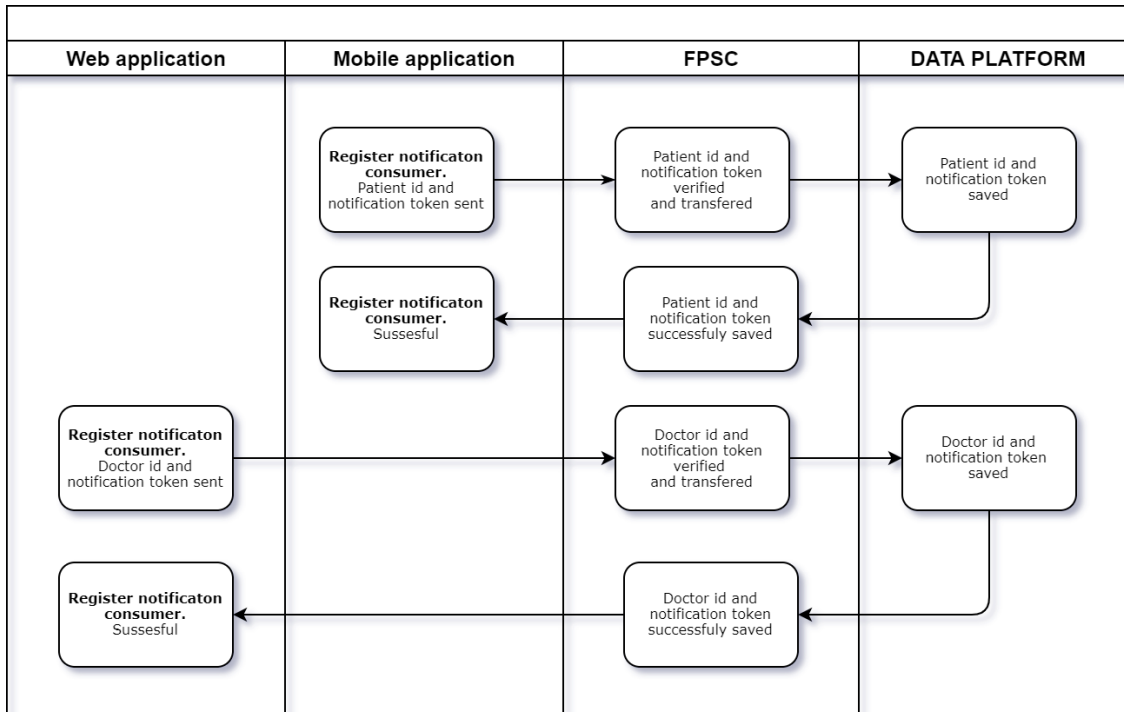


Figure 6.5.3 Notification consumers registration flow example

**User Interface**

Frontend Proxy Server component is a Server Component, no UI is expected.

**Dependencies**

DATA, Case Manager

**Release**

M30 - Final release

**Interfaces (High level data) – Component level – INPUT**

*From external consumers:* JSON data representing patient, doctor information, notification subscription information

*From internal consumers:* FHIR resources representing events, patients and doctor information, recommendations

**Interfaces (High level data) – Component level – OUTPUT**

*To external consumers:* JSON data representing patient, doctor information, notification subscription information

*To internal consumers:* JSON data representing patient, doctor information, notification subscription information, FHIR resources representing events, patients and doctor information, recommendations

**Deployment info (development)**

- Location. FPSC will be implemented in a VPS/VDS hosting
- Architecture technical details (Hardware). Deployed on Unix. 2vCPU, 2GB RAM, SSD 40GB
- Architecture technical details (Software). Debian 10, PHP 7, Laravel framework, Nginx, as a data storage we shall use the CAPABLE Data Platform component through its API or with direct private connection (if applicable) to use the separate database schema.

**Deployment info (production)**

- Location. The location will be compatible with CAPABLE (it may be either a physical server inside the hospital or an outside VPS/VDS hosting)
- Architecture technical details (Hardware). Deployed on Unix. 2vCPU, 4GB RAM, SSD 40GB (but it will depend on needs)
- Architecture technical details (Software). Debian 10, PHP 7, Laravel framework, Nginx as a data storage we shall use the CAPABLE Data Platform component through its API or with direct private connection (if applicable) to use the separate database schema.

**Personas**

- Mobile and Web applications which need to access external end points

**Success Metrics**

- Clients can interact with mobile and web REST API in order to register, save/retrieve data and subscribe to notifications
- Component meets the DATA and Case Manager interaction contract requirements to support clients registration, data transfer and notification subscription

## 6.6. Patient’s application

### Objective

The main objective of the patient-facing mobile application is to provide patients with the tool where they can:

- Keep their profile
- Report symptoms
- Receive treatment recommendations, so that they could manage them at home
- Track their condition using BLE connected devices
- Receive educational tips on side effect’s management.

To guarantee the perfect user experience during all the period of use and support, the application will meet clean architecture requirements that provide the development and support teams with very convenient and safe approach to the all above functionality.

### Application is composed of three main layers:

1. Presentation – UI layer containing feature modules with UI logic based on Model-View-ViewModel (MVVM) pattern.

The presentation layer contains following android modules:

- a. Application module
  - b. On boarding feature module
  - c. Authentication feature module
  - d. Dashboard feature module
  - e. Notification feature module
  - f. Report feature module
  - g. Capsules feature module
  - h. Wiki feature module
  - i. Profile feature module
  - j. Settings feature module
  - k. About feature module
2. Domain – business logic layer. Implements UseCases (Interactors)
  3. Data – data supplement layer that contains repositories to work with database to cache information and network access to request external APIs (Frontend Proxy Server Component). Uses Repository pattern.

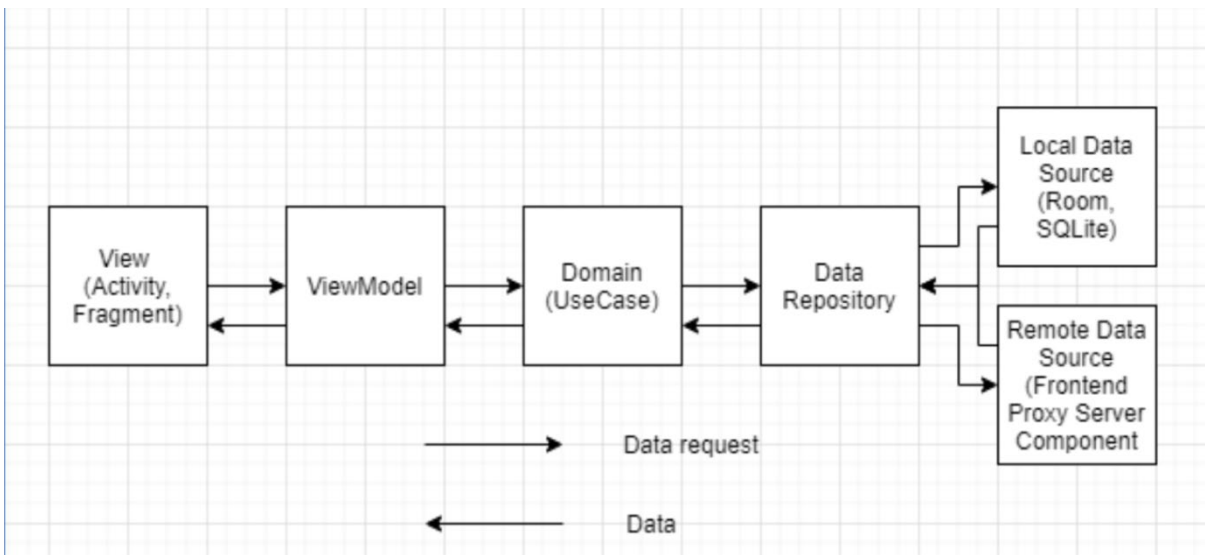


Figure 6.6.1 Patient App Data flow

### User Interface

Current UX can be found here:

<https://invis.io/Q6X4P6ATJD3>

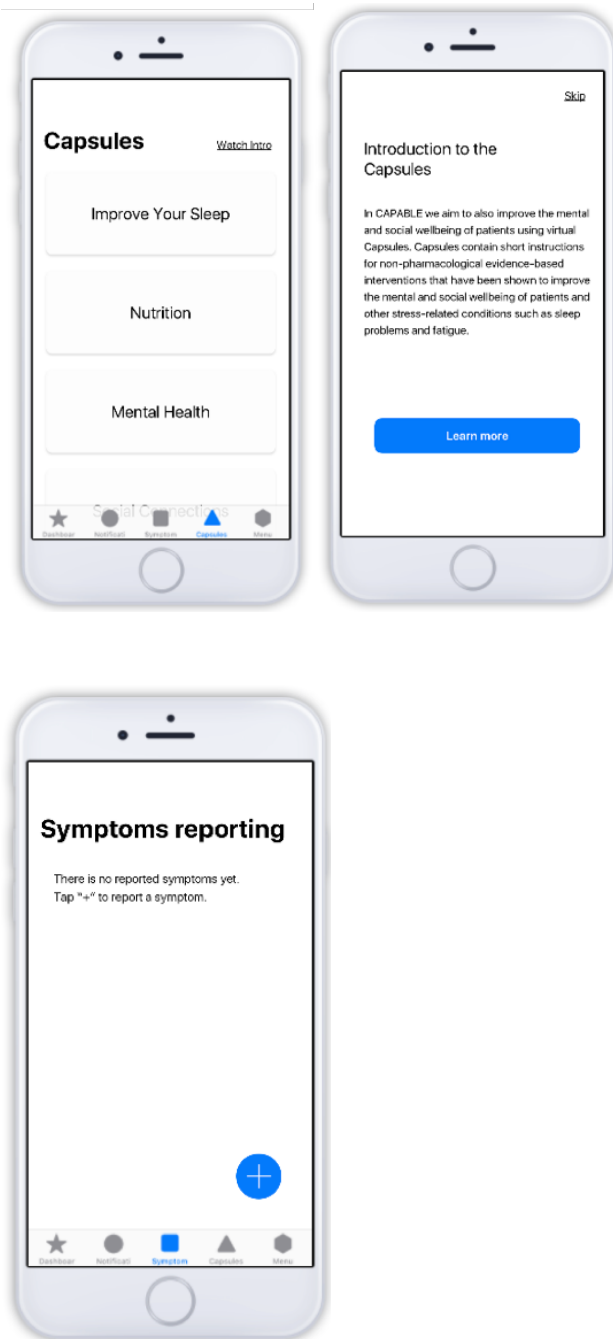


Figure 6.6.3 Report feature module UX example

**Dependencies**

Frontend Proxy Server Component API

**Release**

- M12 - Mockup (UX) of User Interface (Iteration 1)
- M18 - Mockup (UX) of User Interface (Iteration 2)
- M30 - User Interfaces (Final version)

**Interfaces (High level data) – Component level – INPUT**

Patient information input through the application UI

**Interfaces (High level data) – Component level – OUTPUT**

*To external consumers:* visual UX for the patients

*To internal consumers:* JSON data representing patient information, notification subscription information

**Deployment info (development)**

- Location. Deployment to the test Android handset
- Architecture technical details (Hardware). Emulator or a handset with Android OS, with Bluetooth support
- Architecture technical details (Software). Android OS 7 and higher, Google play services, Kotlin, Coroutines, Koin DI, Android Jetpack libraries, Room, Retrofit, SQLite, Moshi

**Deployment info (production)**

- Location. Google Play Store
- Architecture technical details (Hardware). A handset with Android OS, with Bluetooth support
- Architecture technical details (Software). Android OS 7 and higher, Google play services, Kotlin, Coroutines, Koin DI, Android Jetpack libraries, Room, Retrofit, SQLite, Moshi

**Personas**

- Patients
- Caregivers

**Success Metrics**

Patients can login/logout and interact with mobile application, having access to all feature screens:

- Application module
- On boarding feature module
- Authentication feature module
- Dashboard feature module
- Notification feature module
- Report feature module
- Capsules feature module
- Wiki feature module
- Profile feature module
- Settings feature module
- About feature module

Notifications are received by the handset and bring the user to the corresponding section of the application

## 6.7. Clinician’s Dashboard

---

### Objective

The main objective of the web application is to provide physicians to enroll/ import lists of new patients, to access the list of existing patients from the web browser, to access each patient profile and treatment reports for its analysis and modification.

To achieve the objectives the web application will be released as a standard single-page client application using HTML and Javascript. Its code will reside on the Frontend Proxy Server Component and web application will use this component’s API for data exchange

### User Interface

Current UX can be found here:

<https://invis.io/GUX2BJUR8C4>

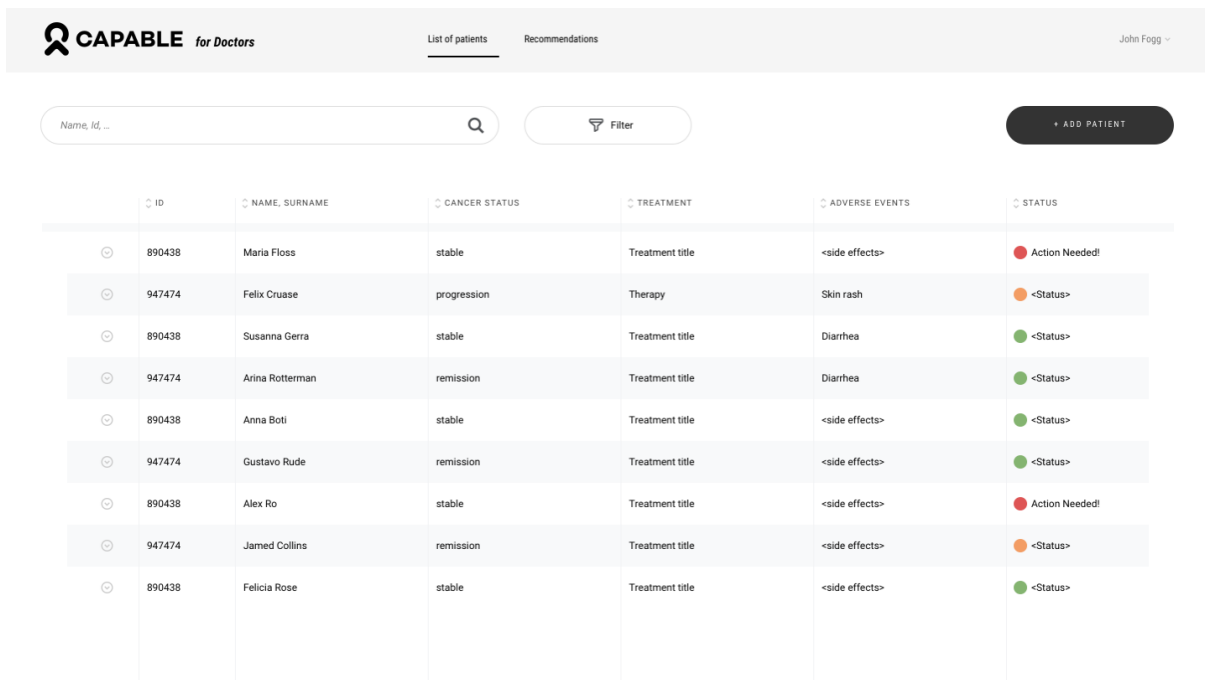


Sign In

---

Remember me [Forgot password](#)

Figure 6.7.1 Login screen example



ID	NAME, SURNAME	CANCER STATUS	TREATMENT	ADVERSE EVENTS	STATUS
890438	Maria Floss	stable	Treatment title	<side effects>	Action Needed!
947474	Felix Cruase	progression	Therapy	Skin rash	<Status>
890438	Susanna Gerra	stable	Treatment title	Diarrhea	<Status>
947474	Arina Rotterman	remission	Treatment title	Diarrhea	<Status>
890438	Anna Boti	stable	Treatment title	<side effects>	<Status>
947474	Gustavo Rude	remission	Treatment title	<side effects>	<Status>
890438	Alex Ro	stable	Treatment title	<side effects>	Action Needed!
947474	Jamed Collins	remission	Treatment title	<side effects>	<Status>
890438	Felicia Rose	stable	Treatment title	<side effects>	<Status>

**Release**

- M12 - Mockup (UX) of User Interface (Iteration 1)
- M18 - Mockup (UX) of User Interface (Iteration 2)
- M30 - User Interfaces (Final version)

**Interfaces (High level data) – Component level – INPUT**

Physicians’ information input through the application UI

**Interfaces (High level data) – Component level – OUTPUT**

*To external consumers:* visual information presented as text and graphics for the physicians  
*To internal consumers:* JSON data representing patient information, notification subscription information

**Deployment info (development)**

- Location. Frontend Proxy Server Component development environment
- Architecture technical details (Hardware). The application is located on proxy component, so using the hardware of the component
- Architecture technical details (Software). Html, Javascript, possible javascript frameworks and libraries to be considered

**Deployment info (production)**

- Location. Frontend Proxy Server Component production environment
- Architecture technical details (Hardware). The application is located on proxy component, so using the hardware of the component
- Architecture technical details (Software). Html, Javascript, possible javascript frameworks and libraries to be considered

**Personas**

- Physicians
- Nurses

**Success Metrics**

All application sections are accessible from the browser. User can login and work (read, update) with the information. Notifications are received.

## 6.8. Sensors

### Introduction:

In the CAPABLE project different ways of collecting user input will be used. As well as filling forms or answering questions via the mobile application, patients will be also equipped with a wearable health device - smartband. Wearable Health Devices (WHDs) are all electronic devices that people can wear and are able to monitor human vital signs. Currently most popular and widely available WHDs are smartwatches, smartbands or wearable ECG sensors. These devices are designed and equipped with sensors to collect large amount of personal health data during the daily life of the user. Main advantage wearables can offer (in comparison to traditional medical data collection) is repeated, continuous and real-time health monitoring.

smartphone smartbands, which are probably going to be used in the CAPABLE project are small and simple devices. They are able to monitor multiple vital signs, but not as many as smartwatches. Smartbands are similar in terms of sensors to smartwatches, but due to the physical size of these devices, some features like wide screens or communication possibilities, e.g., General Packet Radio Services (GPRS,) aren't available. Data acquired by smartbands cannot be transferred to third-party systems (external servers) directly.



Figure 6.8.1 Sensor data generation and communication

### Smartwatch sensors:

Currently, at this stage of the project a choice of smartwatch has been made to meet the project's requirements for measurements of different vital signs. ASUS is chosen as the smartwatch provider. ASUS smartwatches, in particular their latest product VivoWatch SP (HC-A05), are equipped with multiple sensors, which allow them to detect vital signs and activities. In the CAPABLE project data, such as blood pressure, sleep data and steps taken are the most valuable measurements, which are going to be collected, saved and analyzed. ASUS smartwatches have an option to synchronize their measurements with a cloud data platform – OmniCare.

Raw data (health information) generated by the wearable sensors is transmitted via Bluetooth protocol to the master device (a smartphone). In order to ensure proper communication with the OmniCare platform, an additional application (OmniCare Hub) needs to be installed on the smartphone. This app is responsible for smartwatch->remote cloud data synchronization.

The ASUS VivoWatch SP (HC-A05) is equipped with the following sensors:

- Gravity sensor (3-axis accelerometer) - it is used to track movement in every direction (x,y,z - axis). This sensor is able to detect tilt, orientation and inclination of the body. Thanks to this data the device can accurately record steps taken by the user.
- Global Positioning System sensor (GPS) - this GPS sensor gives precise coordinates (location) of the device. It allows users to map their exercise and analyze the terrain, distance, time and other exercising parameters.



- Altimeter - “Altitude Meters” sensor used mostly by the climbers and aviators. It measured the current altitude of the device. Asus Vivowatch SP is equipped with this sensor, but probably these data won’t be relevant in the CAPABLE Project.
- Electricalgraphy x2 (ECG) and photoplethysmography x2 (PPG) sensors - track real-time health data including pulse transit time (PTT) info, heart rate, body harmony index, pulse O2 level, sleep, activity and de-stress level to stay informed about your health.

**Security:**

Due to the fact that fitness trackers record sensitive information (heart rate, steps count or GPS location), data security is an important concern. As presented in Figure 6.8.1 data collected by the smartband are firstly transmitted to a mobile device and afterwards uploaded to a server.

Companies make effort in order to protect users collected data by securing connections using end-to-end encryption.

Every company has its own policy. In the following, we report as an example what is declared by Fitbit.

Smartband devices store collected fitness data in their internal memory, but it becomes available and readable to the user in the mobile application, after synchronizing with the Fitbit cloud service. Tracker connects to the mobile application using BLE protocol, which is a scaled version of standard Bluetooth protocol for communication with small and power-constrained hardware. We can distinguish two BLE connection types: legacy connections and security connection. Although the first type is insecure by default, the second one offers default protection from passive eavesdropping and allows the device to be secured even further with an appropriate pairing method. In order to protect from man-in-the-middle attack, Fitbit Charge 4 uses passkey entry pairing method. A 4-digit code is displayed on the trackers screen, and the user has to enter the code on the smartphone. Modern Fitbit trackers usually by default use advanced symmetric encryption standard with a manufacturer-generated 128-bit secret key.

Interaction and data exchange between the mobile device and Fitbit server is conducted using HTTPS protocol, which secures communications by using asymmetric public key infrastructure. In the Capable Project, data collected by the fitness trackers are going to be uploaded to a cloud service. Afterwards a dedicated CAPABLE’s smartband supervisor is going to acquire information from the remote smartwatch Web API, and use them in different components.

***Omnicare Web API***

ASUS provides OmniCare REST API, which makes it easy to access collected data for a specific user.

***Authorization***

Security of the Web API is ensured by using specially generated tokens, used for user authorization and API authentication. In order to make requests to the OmnicareWeb REST API, a special token needs to be acquired by sending a login post request with a unique Omnicare User Webstorage Password and Omnicare User WebstorageID (login). Such a token will be later attached to each HTTPS request made to the API and used to verify application privileges and scope of information it can access.

Example response, from the OmniCare Web API after sending a login request:

```
{
  "token":
  "qf345m6yqqXjI5Wv/2ciNecDBgaTuI91X7DjOp+skpT+3pDhTuEcJLjdjS1RZnZsrKCHI44Nik/wjqUy1O/qMvNm4Ba6MtROokv
  QEBdeoGegSz2hn8hjXg6puiNT7AknmqpLU1+AaT6aT2kSh47UdISxikuEdHRXXXSWNS+/48Gp4D3CVZgjkO30M/ByTBlgFo8
  cYH4/NEPznFXOGQcuOB6CSxVR+M94mmHICMpCGpHPcgTZP07E26E+iLTiZhKYW+SHvzUOILUxGklxHpFQBkOfjKoIR
  Ogcgc1m2iUDk1+w58spxGTolJUOn2lneVVwMxoEXrkRu0Jk9p6yibqdEg==",
  "sguri": "sgd05.asuswebstorage.com",
```

```
"status": "0"
}
```

In order to make a “get-data” request to the Omnicare Web REST API, an Authorization header with the token needs to be added to the request headers:

*GET* <https://omnicare.asus.life/api/data/device/VivoWatchBP-CAPABLE-001/20210426092250/20210427092250>

*Authorization:*

```
qf345m6yqqXjl5Wv/2ciNecDBgaTuI91X7DjOp+skpT+3pDhTuEcJLjds1RZNZsrKCHI44Nlk/wj
qUy1O/qMvNm4Ba6MtROOkvQEBdeoGegSz2hn8hjXg6puiNT7AknmqpLU1+AaT6aT2kSh47U
dlSxikuEdHRXXXSWNS+/48Gp4D3CVZgjkO30M/ByTBlgFo8cYH4/NEPznFXOGQcuOB6CSx
VR+M94mmHlCMpCGpHPcgTZP07E26E+iLTiZhKYW+SHvzUOILUxGklxHpFQBkOFjKoIRO
gcgc1m2iUDk1+w58spxGToIJUOn2lneVVwMxoEXrkRu0Jk9p6yibqdEg==
```

Omnicare API gives possibility to get following data for the specified smartwatch:

- blood pressure
- heart rate value (stress level)
- steps taken
- sleep activity
- body spO2 saturation
- omnicare\_location

Currently the latest smartwatch released by ASUS is (as mentioned above) ASUS Vivowatch SP (HC-A05), but by the time of clinical tests a new device can be introduced to the market. In such a case, if the new device supports OmniCare platform, it can be used in the CAPABLE project as well.

### **Smartphone selection**

During our last consortium meeting, decisions on what smartphones are going to be used in the Capable project were made. Smartphones must be equipped with the Android 11 operating system (or newer). Support for google services is welcome. Preferred devices are Google Pixel or Samsung.

### **Data flow**

User activity data available via Smartwatch Web API will be collected, aggregated, analyzed, translated and transformed to the CAPABLE Project database. This information (as well ‘traditional’ user feedback via the mobile application) will let the virtual coach and other components make more accurate recommendations.

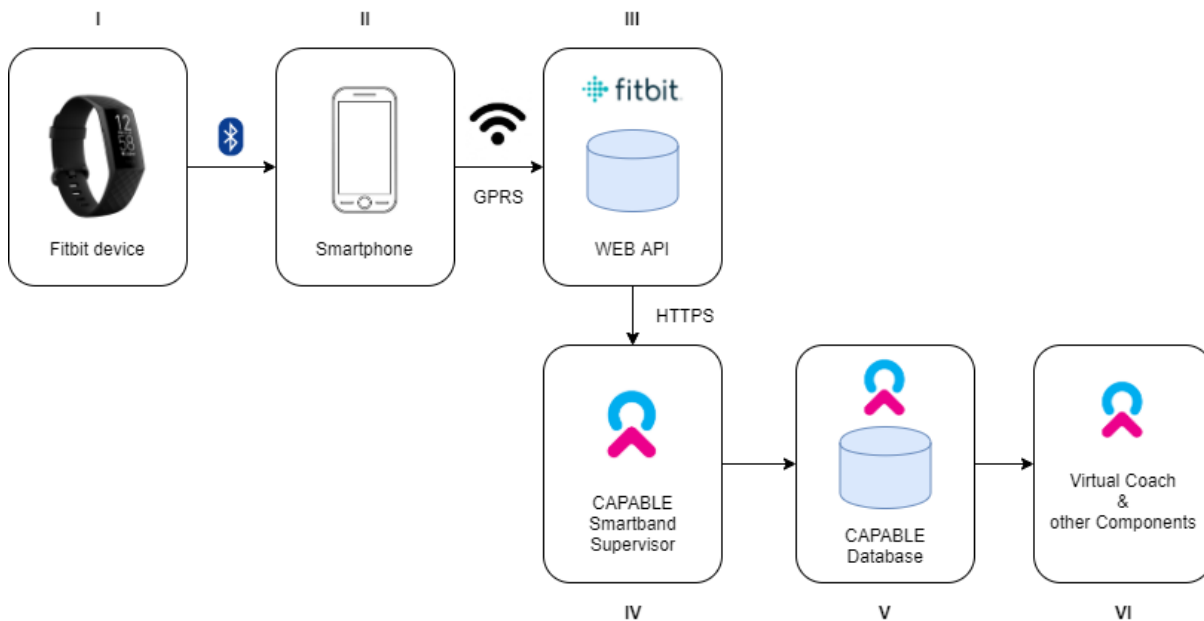


Figure 6.8.2 Sensors data flow within CAPABLE (please note that Fitbit is only an example, a different smartwatch could be selected for the project)

Diagram presents the flow of user activity data:

- Firstly, data is collected by the smartwatch and transferred via Bluetooth protocol to a dedicated smartwatch mobile application.
- Mobile application sends data to a smartwatch third party server.
- CAPABLE’s smartband supervisor (which will be implemented in the future) will collect certain users activity data using the smartwatch Web API via HTTPS protocol.
- After getting information from the smartwatch database, smartband supervisor is going to process the data and save it in a desired format in the Capable database.

## 6.9. PROforma CIG Engine and Knowledge Base

### Overview

The requirements gathering process has revealed two high-level requirements for the Deontics component, which it is useful to consider separately. There is a need for both a general service, providing access to Computer-Interpretable Guideline (CIG) functionality to multiple CAPABLE Components, and a more specific Component that will fit within the CAPABLE architecture.

The Deontics component is required to provide two high-level functions:

**Function 1. Low-level service:** Provide a general service for representing, storing and executing CIGs that is made available to any CAPABLE component that needs this functionality.

**Function 2. High-level component:** Provide a specific component, the Physician DSS, built on top of this service, that actively provides decision support to a physician user of the CAPABLE system.

Function 1 will provide a CIG execution service for use by any CAPABLE component that requires an executable clinical knowledge representation.

The service will provide access to an execution engine and allow full interaction with a CIG, including:

- Selection of a CIG for execution;

- Loading data values into the engine;
- Reading current state of guideline tasks and data;
- Carry out operations on guideline tasks (eg execute or discard tasks);
- Running processing cycles of the engine.

This service is expected to be used by the Virtual Coach and GoCom components, in addition to the Physician DSS component implemented by Deontics. These components will interact with the service via a dedicated Web API, which will extend an existing API already provided by Deontics. Function 2 will provide a specific active component within the CAPABLE architecture, the Physician DSS, which is tasked with initiating and running physician-facing guidelines for CAPABLE patients. It will interact directly with the Case Manager and Data Platform components to provide this function.

**Outline architecture**

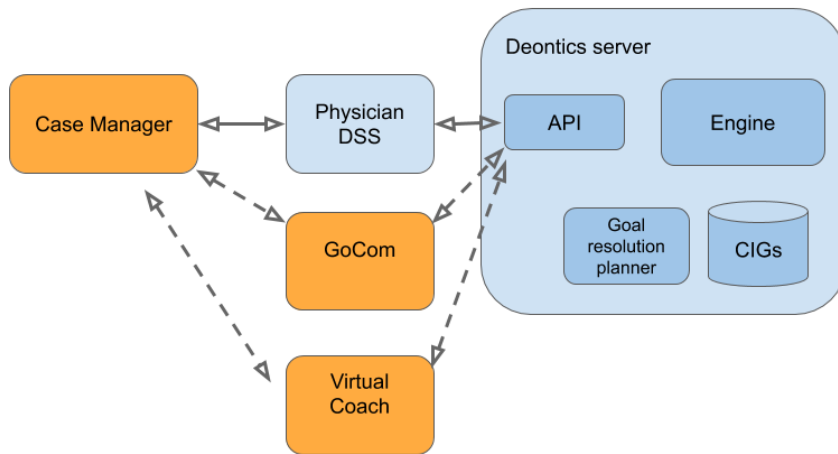


Figure 6.9 PROforma CIG engine interactions with CAPABLE components

The diagram above sketches the proposed high-level architecture for the provision of the above functionality. Deontics-provided elements are in blue. The Deontics Server provides a generic DSS service (function 1) used by various CAPABLE components including the Physician DSS component (function 2).

Interaction *between components* is handled by the Case Manager and Data Platform, which is optimised for co-ordination of patient treatment. Interaction with the CIG service is handled by the Deontics server API, which is optimised for low-level manipulation of the DSS execution process.

Specific requirements for supporting the project use-cases

DSS service (function1)

- Provide a server accessible by all components, with the ability to securely store multiple CIGs in PROforma format.
- Provide a secure Web API with the following functionality:
  - Ability to list available GIGs
  - Ability to initiate execution of a CIG in an execution engine.
  - Ability to access and manipulate states of data items and tasks within the engine.

Physician DSS Component (function 2)

- Read FHIR resources from, and write FHIR resources to, the Data Platform (DP) component.
- Register rules with the Case Manager (CP) component, and poll the CP for notification of:
  - New Patients
  - Changed data relating to existing patients
- When a new patient is registered, and whenever patient data changes, the component will carry out three functions:
  - Determine whether the patient should be registered for any physician-relevant CIGs that they are not already registered for, and start execution of the appropriate CIGs if so;
  - Update data required for all executing CIGs with all available matching data in the DP, and determine updated CIG recommendations.
  - Broadcast a message to other components, by writing a suitable resource to DP, indicating that updated recommendations are available.

It is expected that the GoCom component will be responsible for subsequent actions following this cycle, and that it will update its goal interaction model directly from the CIG engine API as indicated in the architecture diagram above.

### **Additional requirements under WP5**

Under WP5 additional functionality will be developed:

1. To more directly support goal-based representations and operations to allow a more direct integration with the Multimorbidity Controller GoCom. Two specific requirements have been identified to date:

- A service that will automatically create a PROforma decision around a set of alternative GoCom option-set objects. This will allow GoCom output to be dealt with via the functionality being developed for normal clinical decisions in the Physician DSS component.
- Add meta-information to PROforma objects representing GoCom goals and options to allow the Deontics engine to participate in goal and option ranking.

2. To explore integration with the Predictive Modelling component: (NB this functionality is experimental and not for clinical use. The requirements will be clarified during the course of WP5.)

- Input: Receive input about probable utility of treatment options from an ML component, including both options that already exist in a CIG and new options not present in the CIG.
- Output: Provide structured information about expected options and decision criteria to ML components to explore potential utility of this in compensating for small sample sizes.

### **Resources required**

The following resources are required by the Deontics CIG service and Physician DSS component:

#### **Hosting:**

- For development and testing: Hosted on a dedicated VM in Deontics' Amazon (AWS) cloud service.
- For deployment: May be hosted on any suitable VM in the cloud or within a hospital IT system as required.

#### **Technical requirements:**

- Requires a single VM (Linux preferred, Windows tested) and a single database (for storing CIGS, keeping an audit trail and maintaining internal engine state between execution sessions)
- All software is Java-based, provided as a WAR, developed on Linux/Tomcat and also tested on Windows Server / Tomcat

## 6.10. Multimorbidity Controller

---

**Introduction:** The multimorbidity Controller (A.K.A ‘GoCom’) is a component that focuses on providing decision support for multimorbidity patients. Since clinical practice guideline often focus on one particular morbidity, many interactions, among medications and diseases, may occur when several guidelines are applied simultaneously to a single patient. In addition to interactions between guideline recommendations, the patient may be taking medications that were not recommended by a guideline (such as over-the-counter medications). Those additional medications and treatments may also cause interactions and adverse events if they are not detected and mitigated properly. An example of such an interaction would be a patient that is taking an over-the-counter medication for their mood: St. John’s wort and has to take loperamide for treatment of Diarrhea that was caused by anti-cancer treatments. St. John’s wort has an interaction with loperamide thus St. John’s wort has to be stopped before the patient starts taking loperamide.

**Objective:** The goal of the GoCom component is to provide decision support to the physician and notifications to the patient. GoCom’s functionality includes detecting and mitigating interactions that may occur among the patient’s medications as well as conflicts among medications and diseases. GoCom is activated every time a new diagnosis or medication is added to the patient data in order to prevent possible interactions as well as detect adverse events that may have already happened. Notifications to the patient may be sent to confirm that a certain medication is not taken anymore if the patient is prescribed a different medication that conflicts with it.

GoCom is modeled to detect and mitigate the following types of interactions:

- 1.Temporal interactions (e.g., spacing doses)
- 2.Drug-drug interactions
- 3.Drug-disease interactions; Treatments causing adverse events

When a new diagnosis is added to the patient’s data, if the condition has a modeled guideline, the guideline will be run by the Deontics engine and afterwards, the Deontics engine will notify GoCom, so that GoCom can retrieve the goals and actions recommended by the guideline for one multimorbidity condition. Once GoCom is activated it generates a Goal forest for the patient that consists of Goal trees. The Goal trees are derived from the guideline that was run as well as other patient information such as medication requests not related to this specific guideline, that GoCom collects for constructing the patient forest.

The Goal trees consist of the goals connected to the conditions and medications of the specific patient. Along with creating the patient’s forest from the guideline recommendations, GoCom will generate the patient’s goals and link them to the medication requests that are relevant to them, using HL7 FHIR standard.

After the Goal forest is generated, GoCom traverses the forest and checks for interactions among the conditions and medications of the patient. GoCom utilizes external knowledge sources for detection of drug-drug interactions and potential adverse events.

When a new medication is added a forest is created and consistency is checked as well (without running a guideline).

In case interactions are found, GoCom will provide a number of solutions, with explanations and prioritization for each solution (aligned with the patient’s preferences), as well as display appropriate goals for the patient. That way, the physician can have all the information they need to make an informed decision while also considering the patient’s preferences.

The recommendations produced by GoCom will be JSON objects consisting of option-sets. Each option-set is an alternative solution for the conflict that was created by the interaction, and addresses the multiple goals (for the concurrent conditions of the multimorbidity patient). The option-sets are formatted as FHIR Goal objects that contain a reference to a Medication Request

object. The Medication Request objects will contain a reference to a Condition object – the condition for which the Medication Request object was prescribed.

If a medication that was previously prescribed ‘as needed’ for the patient is recommended for the patient by the virtual coach, GoCom will check for interactions again and go through the same process, in the end storing an interaction (if it exists) in the data platform, for the patient application to display as a notification for the patient.

If no interactions are found, a single-solution recommendation (option-set) is generated and Stored in the Data Platform.

After the physician chooses and confirms a specific option-set (out of 1 to many option-sets), the GoCom component separates the option-sets into goals and medications requests and stores them in the data platform so that the patient’s application or the physician’s application could display that data.

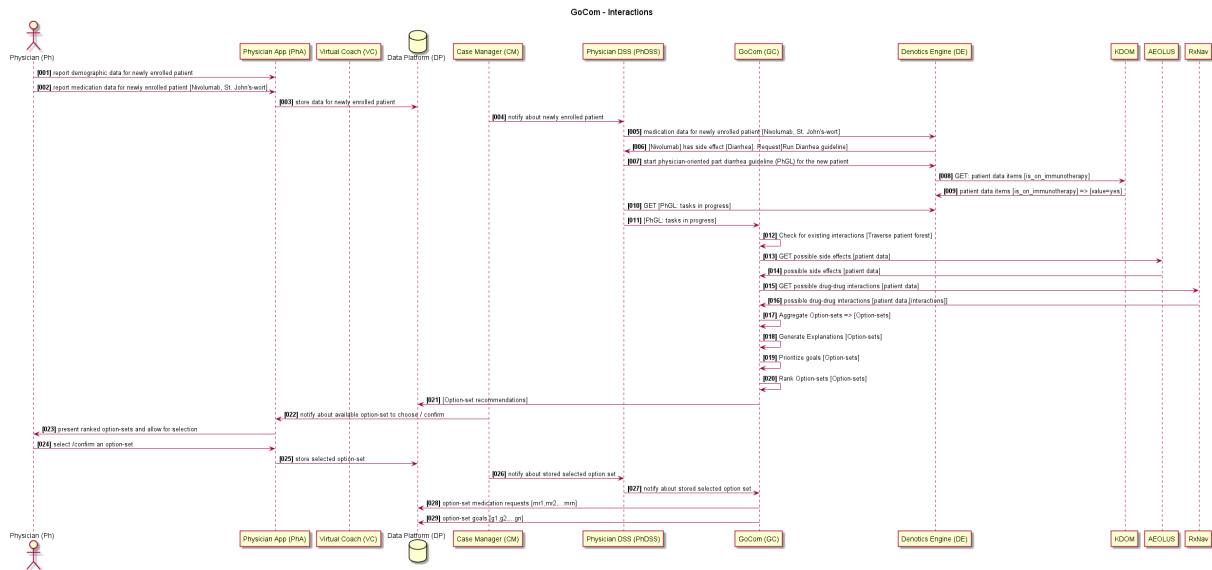


Figure 6.10.1 GoCom’s sequence diagram showing how decision support recommendations for multimorbidity are communicated to the Deontics Engine

**Success metrics:** The success metric of the component is correct and complete handling of multimorbidity interactions for the use cases that are defined below, including detection and mitigation of interactions, with temporal interactions, adverse events, goal prioritization, as well as using external knowledge sources.

**Personas:** The product is for the Clinicians' DSS. The component will produce recommendations for the physician application and notifications for the patient application.

**Interfaces – INPUT:** Enactment ID sent by the Deontics engine or by the virtual coach (through the data platform)

**Interfaces - OUTPUT:** option-set recommendations as well as separate goals and medication requests that will be stored in the data platform after the user has confirmed a recommendation.

**Events – triggered by:** Events will be triggered by the Physician DSS, the Deontics engine or the case manager.

**Events – triggers:** The component will trigger the Physician DSS, the Deontics engine, and the case manager.

Deployment information:

**Location:** Cloud / remote host (probably in country of hospital)

**Accessibility:** The Physician DSS, Deontics engine, case manager and KDOM will have permissions to trigger / notify the component. The component will also retrieve data from external knowledge sources either by API or from aws-rds.

**Communication:** Physician DSS, Deontics engine, KDOM, case manager

**Component architecture description:** Will connect to the data platform through the case manager as well as connect to external knowledge sources through API, possibly hold external knowledge downloadable databases in aws-rds db.

**Architecture technical details (Hardware):** Only what is required by the remote host service

**Architecture technical details (Software):** only cloud services (remote host, aws-rds etc)

## 6.11. Virtual Coach

---

**Introduction:** The overall purpose of the Virtual Coach (VC) is to provide comprehensive support (referred to as coaching) to *patients* (and their home caregivers) during *outpatient cancer management process*. In this sense it provides functionality complementary to the one provided by the Physician DSS (described in Section 6.7) and related components that focuses on supporting physicians. For the sake of simplicity, in the following text in this section we will refer to the patient, although most of the support functionality offered by VC is applicable to the caregiver. We assume the outpatient management process relies on digital interventions (i.e., reporting requests, reminders, alerts, recommendations, educational content) that are delivered by the CAPABLE system to the patient via the Patient App (described in Section 6.6) These interventions can be categorized according to two dimensions capturing their *type* and *complexity level*.

We consider three types of interventions:

- *Clinical* interventions captured by clinical guidelines,
- *Well-being* interventions captured by capsules,
- *Educational* interventions captured by educational courses and other materials (e.g., AIMAC publications).

Moreover, we consider two complexity levels of interventions:

- *Basic* interventions that represent atomic recommendations, reminders, actions or units of educational materials
- *Complex* interventions that are collections (ordered or unordered) of basic interventions. For example, a computer-interpretable guideline (CIG) is a complex clinical intervention that is composed of multiple basic interventions.

We also consider *meta-interventions*, i.e., interventions about interventions. They are used for selecting most appropriate interventions (e.g., selecting most appropriate capsules given patient goals specified during plan co-creation) and customizing interventions to patient's characteristics, such as adherence or observed outcomes.

**Objective:** With the above assumptions the overall goal of providing comprehensive support to patients translates into the following specific objectives:

1. Supporting delivery and shared (in cooperation with Patient App) execution of clinical, well-being and educational interventions.
2. Selection of appropriate well-being interventions for a given by using specialized meta-interventions.
3. Customization of well-being and educational interventions for a given patient by using specialized meta-interventions.

VC relies on the PROforma formalism and associated tools for representing and executing interventions. More specifically, complex interventions are represented as CIGs, while basic interventions become CIG tasks. CIGs are authored and initially tested using the Deontics Composer and executed by the Deontics Engine. In addition to tasks capturing basic interventions, CIGs may include additional tasks that should be executed by other components of the CAPABLE system (e.g., calculating an abstracted data item that should be performed by KDOM, or retrieving



a stored data item from the Data Platform) or autonomously by Deontics Engine (e.g., simple decisions made on the basis of collected data items).

In the first stage of the project we plan to construct meta-interventions from expert knowledge and represent them also as PROforma CIGs -- they will be handled analogously to complex interventions, as described above. In the later stages, we plan to apply machine learning (ML) techniques to patient data being collected in clinical trials in order to refine meta-interventions and allow for their more fine-grained customization.

**Success metrics:**

1. VC is able to interact with other components through Data Platform and Case Manager in order to generate and deliver support (recommendations and interventions) to patients
2. VC is able to provide timely and correct (validated against gold standard defined by clinicians) support according to multiple guidelines and capsules simultaneously applied to a given patient.
3. VC is able to provide support to multiple patients managed at the same time.
4. VC provides high reliability -- it responds to failures, automatically restarts its internal components and continues management without human (administrator) intervention.

**Personas:**

VC delivers support in form of digital interventions to patients through the Patient App. Provided support is personalized to a specific patient based on their clinical condition and associated guidelines, as well as non-clinical goals (e.g., improved physical activeness) and related capsules. The non-clinical support can be further customized based on specific settings or conditions (e.g., weather or air quality that may affect the scope of physical activities on a specific day). To achieve this we rely on customization meta-interventions that encapsulate expert knowledge and knowledge discovered from data.

**Interfaces (High Level Data) - Component level – INPUT:** Selected FHIR resources (Patient, Observation, Medication Request, Communication, Task) representing observations, prescribed treatments, computed abstractions, patient responses to recommendations and selected relevant clinical events, such as enrollment of a new patient.

**Interfaces (High Level Data) - Component level – OUTPUT:** Selected FHIR resources (Communication, Task) representing interventions delivered to the patient via Patient App and service requests delivered to KDOM and GoCom.

**Events (triggered by):** Data Platform, KDOM, Patient App, Physician App – indirect via Case Manager

**Events (triggers):** Internal event (timer), Data Platform – direct, KDOM, GoCom, Patient GUI – indirect via Case Manager

**User flow and design:**

A high-level architecture of VC is presented in Fig. 6.11.1. This figure also includes the employed knowledge bases and other relevant CAPABLE components that frequently interact with VC in order to achieve its goals. Most of these interactions are indirect and involve the Data Platform and Case Manager. Such solution is also applied in case of the Patient App that closely collaborates with VC in executing basic interventions.

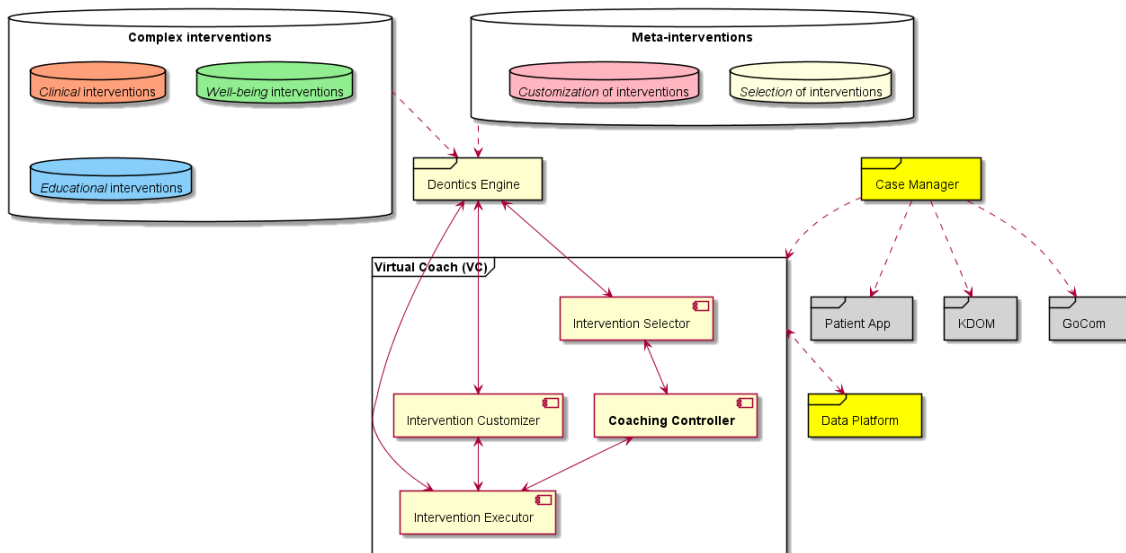


Figure 6.11.1. High-level architecture of VC

VC uses two knowledge bases – with complex interactions and meta-interactions. As the initial stage of project development both contain PROforma CIGs and during further development selected meta-interventions may be replaced by ML models derived from collected observational patient data. CIGs employed by VC are stored on a server that hosts the Deontics Engine (we employ a continuous integration mechanism to automatically upload CIGs from a version control system onto the server).

PROforma CIGs are extended to store additional information that is required for proper delivery and execution of specific tasks. For this purpose, we use meta-properties associated with CIG tasks and data items. These meta-properties are exposed by the Deontics Engine to VC components discussed above and they include:

1. At the CIG task level
  - a. *Data source* for enquiry (data collection) tasks – the origin of data item values. Possible sources are: *reported* for values that should be reported by the patient via the Patient App, *stored* for values that should be retrieved from the Data Platform, and *abstracted* for values that should be computed by KDOM (described in Section 6.7),
  - b. *Waiting time window* for enquiry tasks that require values reported by the patient (data source = reported) -- a time period or time point (e.g., 8 hours, or 6PM) until when VC can wait for patient input until it explicitly sends a reporting request,
  - c. *Interactivity indicator* for action tasks – an *interactive* task (e.g., a reminder) implies sending an intervention to the patient via the Patient App, while a *non-interactive* task is executed by VC. Specifically, non-interactive action tasks allow for starting CIGs within other CIGs,
  - d. *Approvability indicator* for interactive action tasks – an *approvable* task needs to be explicitly approved by the patient to track adherence and to allow proceeding with further CIG execution according to the patient’s decision. An example of such task is a recommendation to start loperamide earlier prescribed as needed. On the contrary, a *non-approvable* task (e.g., representing an AIMAC hint) does not require any confirmation from the patient.
2. At data item level:
  - a. *Validity time window* – a validity period for a data item value to be considered useful in a given context, e.g., last 6 hours for body temperature,
  - b. *FHIR resource* -- a resource type to be used when interacting (storing or retrieving data item value) with the Data Platform. Most data item values are stored as

Observation resources, however, there are also some data items whose values are captured as Medication Requests or Conditions.

VC consists of four internal components indicated in Fig. 6.11.1 that closely cooperate each with other – they are discussed below.

- *Coaching Controller* is the master component responsible for handling the coaching process. It initiates coaching for newly enrolled patients and then supervises it. This involves starting applicable clinical and educational interventions, selecting appropriate well-being interventions and also starting them.
- *Intervention Selector* applies a selection meta-intervention to choose well-being interventions appropriate for a given patient. These interventions are selected through shared decision making involving the patient and the physician, thus interactions in this case involve Physician Dashboard described in Section 6.7. Selected well-being interventions are then started.
- *Intervention Executor* executes a complex intervention. It delivers basic interventions to the patient via the Patient App and dispatches remaining CIG tasks to other CAPABLE components.
- *Intervention Customizer* uses customization meta-interventions to revise basic and complex interventions. Basic interventions are checked for possible customization before being delivered to the patient, while complex interventions may be customized at different time points, depending on their effects and user adherence. Examples of customization are discussed in the next subsection. In the first phase of the project we plan to focus on customizing basic interventions, and then we consider complex ones.

Moreover, individual VC components (except for the Coaching Controller) communicate with the Deontics Engine using a dedicated Web API. This API allows for controlling the execution of CIGs representing complex interventions and meta-interventions (see Section 6.9 for a more detailed description of this API). Figure 6.11.2 presents a flow diagram associated with CIG execution, limited to these CAPABLE components that interact directly with VC. The flow starts with retrieving CIG tasks with *in-progress* status (i.e., tasks to be executed) from the Deontics Engine (M\_001). There may be more than one such task, therefore, there is a loop that iterates over *in-progress* tasks. Handling of a task depends on its type as described below:

- Enquiry task -- handling starts with retrieving a recent (fitting the validity time window) value of the requested data item from in the Data Platform (M\_002). If the value is not available, and the data source is different than *stored*, then further processing starts. If the source is *abstracted*, then a request for KDOM to compute the value is stored (M\_003). Otherwise, if the source is *reported*, then VC waits according to the *waiting time window*, if specified, and stores a reporting request aimed at the Patient App (M\_004). VC waits until the Case Manager notifies about the data item value being available (M\_005) and passes it to the Deontics Engine (M\_006).
- Action task – handling depends on whether the task is interactive or not. In the latter case, the task is translated into a corresponding intervention (M\_007). Then, the intervention is (possibly) customized for the current patient and their setting (M\_008). Both translation and customization are handled internally by VC. Moreover, customization is applied if an applicable meta-intervention is available, otherwise the intervention is not changed. The intervention aimed at GoCom (if treatment) or the Patient App is stored in the Data Platform. If the current task is approvable, then VC waits until the Case Manager notifies it if the intervention has been approved or rejected by the patient (M\_010). If the task is non-interactive, it is executed internally by VC (M\_011).
- Decision Task – handling of such task is similar to handling of a *reported* enquiry task (in both cases the patient needs to provide some input, however, here it is limited to a set of candidates associated with the task). It starts with storing a selection intervention aimed at

the Patient App (M\_012). Such intervention stores all candidates together with arguments and scores computed internally by the Deontics Engine. Then, VC waits for the notification from the Case Manager about the candidate being selected by the patient (M\_013). Finally, the selected candidate is passed to the Deontics Engine (M\_014).

Regardless of its type, each handled task needs to be confirmed on the Deontics Engine (M\_015). This marks the task as completed and allows the Engine to move to subsequent CIG tasks.

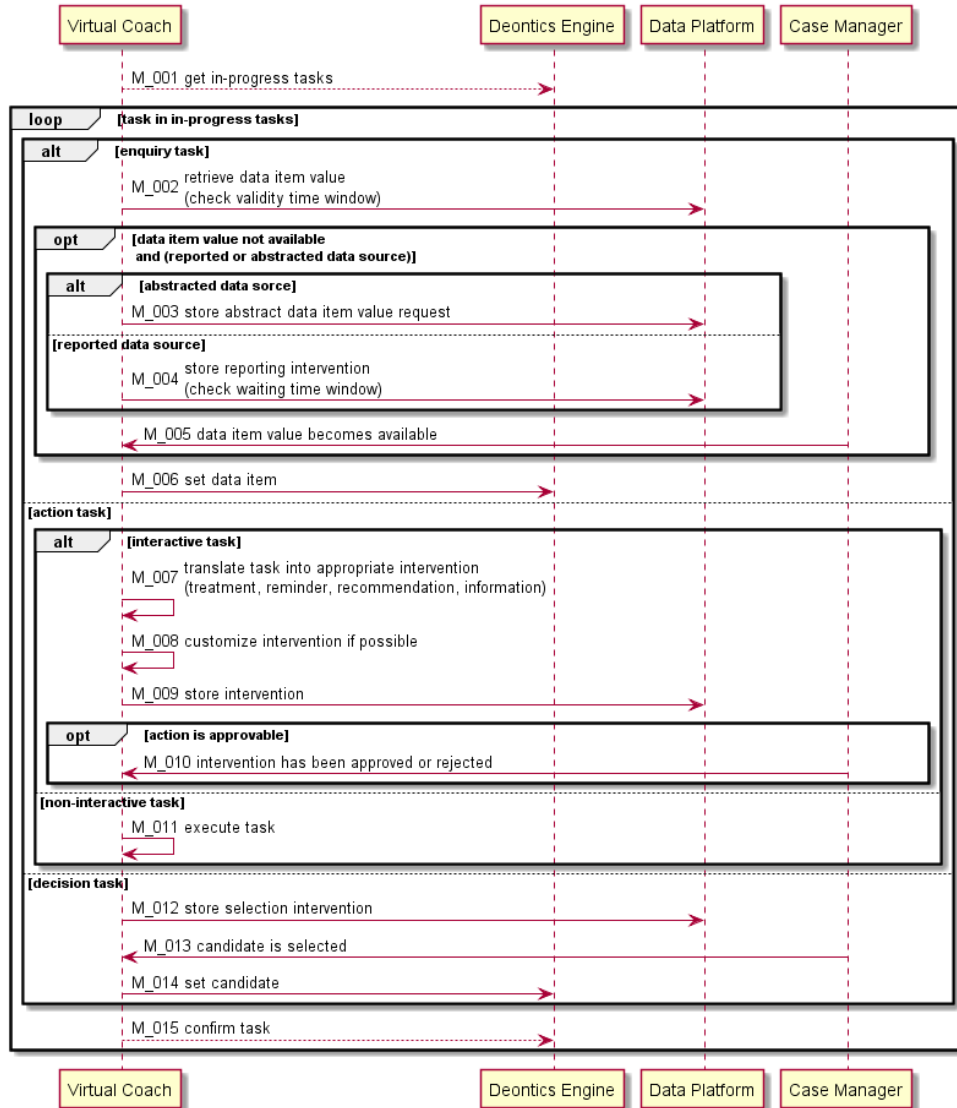


Figure 6.11.2. Flow diagram for VC and related components

When interacting with other CAPABLE components through the Data Platform, VC employs a limited set of FHIR resources. Requests aimed at KDOM, GoCom and the Patient App and responses are represented as Communication resources (see Section 6.3 for examples). In later stages of the project we consider using Task resources when interacting with the Patient App. Moreover, when checking for values stored in the Data Platform, VC currently considers Observation and Medication Request resources. Other resources, e.g., Condition, may be added later if necessary.

**Features:**

To achieve its objectives, VC needs to have the following high-level features:

- Simultaneous execution of multiple complex clinical, educational and well-being interventions for a given patient.
- Selection of most appropriate interventions given the current patient characteristics and settings (e.g., specified goals, place of residence, access to specific facilities).
- Customization of applied interventions given the patient characteristics (e.g., adherence) and observed or reported outcomes. It may involve
  - Customization of interactive tasks that should be executed via Patient App (e.g., changing physical activity type), grouping several tasks (e.g., several reminders) into a single package or rescheduling tasks (e.g., reporting) to minimize burden imposed on the patient.
  - Customization of complex interventions or changing them, if the currently applied ones are not effective (e.g., they do not result in improved outcomes)

These features are translated into the following lower level requirements:

- Representation of complex interventions and meta-interventions using PROforma to allow for uniform representation of knowledge used by different components of the CAPABLE system (Physician DSS, GoCom).
- Communication with other CAPABLE components:
  - Direct communication with the Data Platform -- reading and writing FHIR resources in JSON format.
  - Direct communication with the Case Manager -- managing subscriptions for events (event rules), checking or listening for events using REST API.
- Shared execution of complex interventions and meta-interventions represented as PROforma CIGs using the Deontics Engine and other components:
  - Execution of non-autonomous decision tasks via the Patient App (a patient will be requested to select one of possible candidates).
  - Execution of other interactive tasks via the Patient App: displaying reminders, recommendations, educational messages (a patient may be asked for approval or rejection).
  - Execution of reported enquiry tasks via the Patient App (a patient will be requested to enter specific information).
  - Execution of remaining enquiry tasks via the Data Platform (retrieval of stored data item values) or KDOM (computation of abstracted data item values)
  - Handling interactions with the Deontics Engine required to execute specific tasks.
- Additional time-based control of task execution to supplement mechanisms available in PROforma (delayed execution, execution at specific times of day).

Architecture:

VC is implemented following the actor model and using the Akka toolkit. In the actor model the functionality of the application is divided into multiple actors that work in parallel, communicate asynchronously and form a multi-level hierarchy where actors at higher levels supervise those at lower levels (if an actor at a lower level terminates unexpectedly, the supervisor may restore it). Actor model is especially suited for distributed, scalable and reliable systems. The Akka toolkit is composed of several modules and in VC two of them are used – Actors and HTTP. The former implements functionality related to actor model, while the latter allows for developing HTTP clients and servers. The client functionality is used for the M12 demo in order to communicate with the Deontics Engine and Case Manager, while later the server part may be added to VC to allow for the push communication pattern.

The hierarchy of actors employed in the implementation of VC is given in Fig. 6.11.3. It contains the following actor types:

- *Coaching Supervisor* – oversees coaching for all currently managed patients, responds to events associated with starting the management (enrollment) and ending it (end of service),
- *Patient Coach* – manages coaching for a given patient and oversees execution of all complex interventions and meta-interventions for this patient. This actor is created when the patient is enrolled and terminates when the patient is discharged,
- *CIG Executor* – executes a given complex intervention or meta-intervention (represented as PROforma CIG) for a given patient. There is a separate actor for each executed CIG. It is created when the CIG should be instantiated and started and it is deleted when CIG is completed,
- *Enquiry / Action / Decision Task Executor* – executes a given CIG task. Each CIG Executor has a pool of its own Task Executors so multiple tasks can be executed in parallel. Task Executors communicate with one of Adapter actors when interaction with other CAPABLE components is necessary,
- *Stored / Reported / Abstract Data Item Collector* – facilitates Enquiry Task Executor in collecting values of specific data items depending on their source (see the discussion above). Several Data Item Collector actors may be executed in parallel to collect multiple data values at the same time,
- *Task Customizer* – customizes CIG tasks corresponding to basic interventions before they are delivered to the patient via the Patient App. There is a separate Task Customizer for each patient managed by VC that takes into account patient's settings and preferences (e.g., preferred times for reminders). Simpler customizations may be driven by built-in rules and complex ones are controlled by appropriate meta-interventions,
- *CIG Customizer* – customizes CIGs for a given patient. Applied customization is more extensive than the one performed by Task Customizer and it includes, for example, changing the frequency and intensity of basic interventions or even switching between several related CIGs (e.g., several capsules aimed at achieving the same goal, such as improving physical activity). Similarly to Task Customizer, there is one CIG Customier actor per patient and it employs customization meta-interventions,
- *Deontics Adapter* – provides access to specific API endpoints exposed by the Deontics Engine via REST. Each CIG Executor has its own Deontics Adapter actor as this facilitates handling separate connection sessions (Deontics Engine creates a separate session for each CIG being executed),
- *Case Manager Adapter, KDOM Adapter, Data Platform Adapter and GoCom Adapter* – act as wrappers around Case Manager, KDOM, Data Platform and GoCom, respectively and facilitate interactions between other actors and these components. Case Manager Adapter actor manages subscriptions/rules, actively queries Case Manager for new events and notifies interested actors about them. The other adapters forward received requests to appropriate components

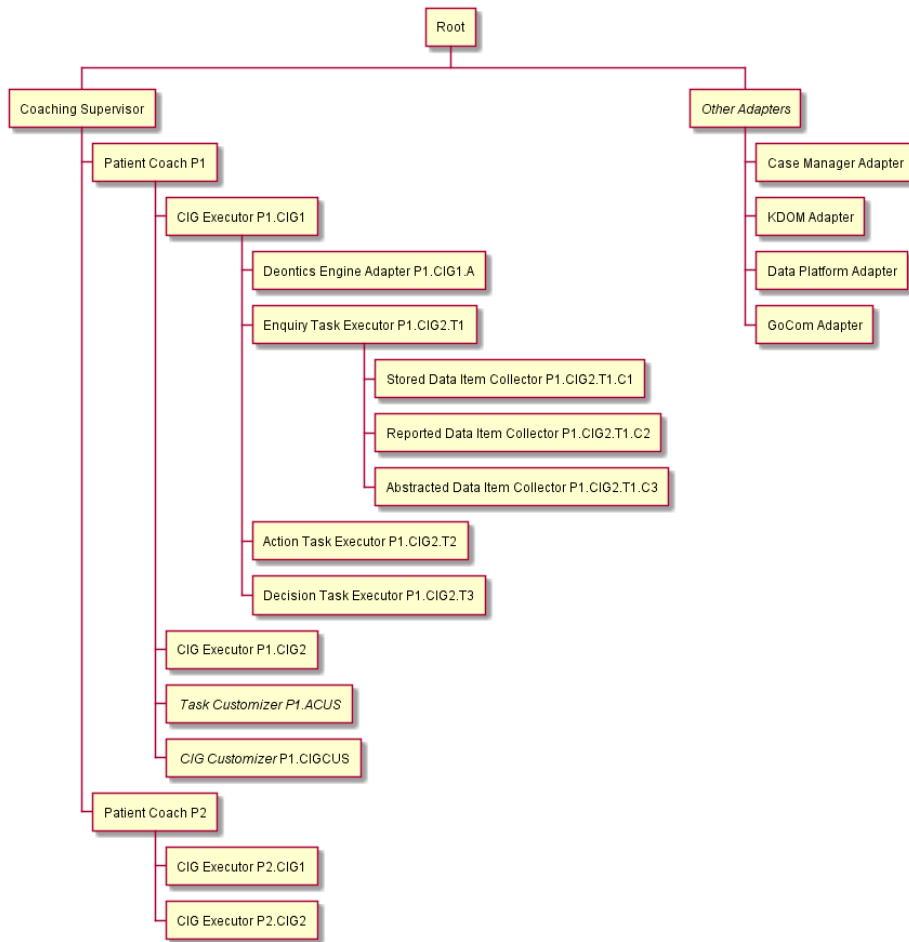


Figure 6.11.3. Hierarchy of actors in the implementation of VC (Root indicates the actor that manages all other user actors)

Table 6.11.1 presents the mapping between actors depicted in Fig. 6.11.3 and described above, and logical components of VC given in Fig. 6.11.1. Some actors are mapped to several logical components – these actors (e.g., CIG Executor) provide services that are used in several contexts, e.g., running a CIG representing a complex intervention or meta-intervention. Moreover, adapter actors have been omitted for brevity.

Table 6.11.1. Mapping of actors into logical components (wildcards ‘\*’ indicate all possible Task Executor and Data Item Collector actors)

	Coaching Controller	Intervention Selector	Intervention Executor	Intervention Customizer
Coaching Supervisor	x			
Patient Coach	x	x		
CIG Executor		x	x	x
* Task Executor		x	x	x
* Data Item Collector		x	x	x
Task Customizer				x

CIG Customizer				x
----------------	--	--	--	---

**Release:** VC V1.0.0.0

**Date:** 2021-01

**Features:** Execution of complex interventions and meta-interventions, customization limited to basic interventions, meta-interventions in form of PROforma CIGs

**Dependencies:** Deontics Engine, Data Platform, Case Manager

**Location:** a network with access to crucial components (see Dependencies)

**Accessibility:** crucial components (see Dependencies)

**Communication:** need to communicate with crucial components (see Dependencies)

**Component architecture description:** a single VM (see below for specs) per study site

Architecture technical details (Hardware): VM, 4-core CPU, 2GHz, 8GB RAM, 20GB HDD

Architecture technical details (Software): Linux (Ubuntu), Java 1.12+, Scala 3.1.1+, Akka 2.6.8+, HAPI FHIR 5.1.0+ (open-source packages, no licenses required)

## 6.12. System Integration and Security

CAPABLE components will be integrated following a loosely coupled design. We can identify 3 main interaction types among the system components:

- Data input and output
- Event subscription (and notification)
- Interaction between 2 components

Data input and output will be managed with the Data Platform, through standard HL7 FHIR interactions, relying on the FHIR subset which will be identified in WP3.

Event subscription and notification is fulfilled by interacting with the Case Manager, that will expose a standard and documented API to exploit all its capabilities. The notification mechanism is still under discussion by the technical partners and will realized in Iteration 2 (M18): currently, the most probable solution to be implemented is “long polling”.

CAPABLE components will also need to communicate between each other, this can be achieved in two ways:

- Leveraging the same mechanism to store data and create events; in this case the message exchanged between two components is represented as a FHIR Communication, that is stored in the Data Platform and notified to the recipient component by the Case Manager
- Allowing components to expose a custom API, that can be used by other components willingly to direct communicate with it.

In both cases the actual message exchanged must be defined and agreed between the communicating actors.

Regarding data management CAPABLE will rely on both data already available to partners at the beginning of the project and on data that will be collected during the clinical study. All security aspects related to retrospective data will be managed with bilateral agreements between Data Controllers (i.e. the two hospitals and AIMAC) and those partners that need to access the data before the trials. The transfer of such data will be done in a secure manner, meaning the data will be password protected, and the password will be provided separately on a different channel of communication. Also, secure network protocols (SFTP) will be used for the actual transfer of the data.

Within the CAPABLE Project, the clinical settings where the trials are expected to take place during the last year of the project are Istituti Clinici Scientifici Maugeri based in Pavia and Netherlands Cancer Institute based in Amsterdam. Both of them have Information System Departments providing Electronic Health Record services for their patients, so the final deployment architecture must account for the current infrastructure available and smoothly integrate with it.



Working groups are being defined operating independently at those settings, so the two final deployments may slightly diverge.

Security is achieved through protocols, policies and standards and all those aspects have been considered from the ground up in developing CAPABLE. In Figure 16.2.1 we illustrate how we are planning to deploy the different CAPABLE Components. As it transpires, the diagram complies with the classical notion of a three-tier system encompassing zones such as Intranet, DMZ and Internet. More specifically, only adjoining zones may exchange some information while any communication is forbidden between Intranet and Internet zones.

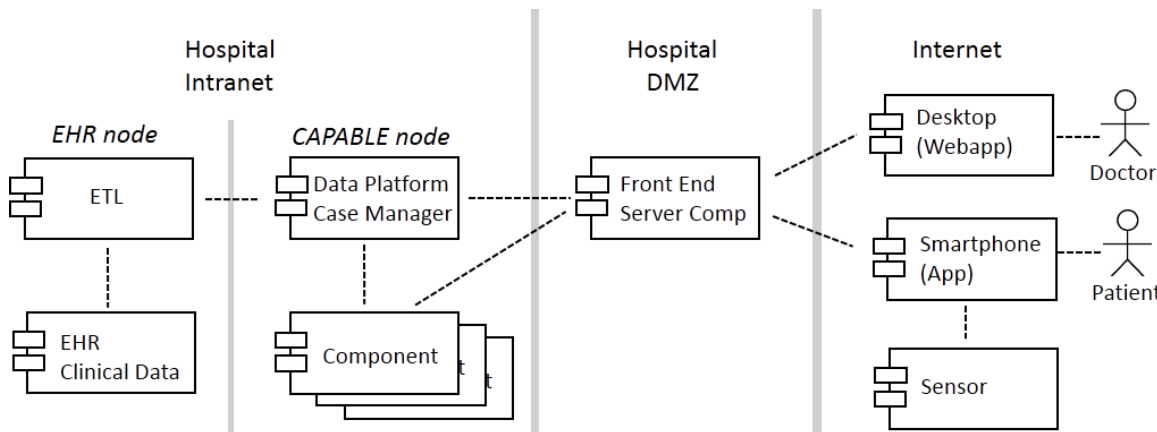


Figure 16.2.1. UML Component Diagram illustrating the Deployment Architecture envisioned for the CAPABLE system. This is a generic architecture that will be tailored to the specific requirements of the Hospital settings before starting the pilot trials.

The Intranet is the innermost security circle provided by institutions where the highest restrictions are enforced preventing any access from the Internet. Sensible data, such as those concerning patient names, social security numbers and the like may only be stored within this zone. For privacy purposes, at hospitals, patient data are often spread on at least two separate repositories located within this zone. One mostly stores demographic data useful for administrative purposes (e.g. patient name and address, social security, caregiver names and addresses, etc..) while the other one is devoted to storing clinical data. This arrangement performs some kind of de-identification and prevents the reconstruction of patient data issuing very simple queries on a single database granting different privileges to applications and system administrators. The various sources of information concerning the same patient may be linked through a system generated code. This procedure is only accomplished dynamically by applications granted the privilege to access the different sources, such as those for the medical staff.

In CAPABLE the only Component devoted to persistent data storage is the Data Platform, which is therefore located in the Hospital Intranet. The system will only be accessed by the medical staff participating to the study and the patients will be identified by their enrollment number. Thus, no direct link is expected to be set up with demographic information stored in the EHR. This is portrayed by the separation in Figure 16.2.1 between EHR node and CAPABLE node within the Hospital Intranet. On this basis, according to each deployment setting, the CAPABLE node may be stored on a separate zone of the Hospital Intranet.

CAPABLE expects indeed to exploit clinical data available in the hospital EHR concerning patients enrolled in the study that have been acquired by means other than the CAPABLE system (e.g., scheduled visits). For that purpose, an additional Component named ETL will take care of accessing the EHR, translating the relevant data concerning patients enrolled in the study and importing them into CAPABLE. This component will operate on a regular basis in an offline fashion possibly under the supervision of a staff member. In addition, the Data Platform database will be regularly backed up on a secondary database within the hospital premise.

For what regards data recovery, in case the data at the processors will be deleted or corrupted, the data providers can share again the data they provided as the original copy is also retained on their side. The actual data security management of the CAPABLE project will be active during the fourth project year for the studies data; all the patient data will be stored on virtual hardware within the premises of the respective hospital.

The rest of the CAPABLE Components will also be located on the CAPABLE node accessing the Data Platform and contributing their partial interpretation for the case at hand. The only remarkable exception is the Front-End Server Component.

The DMZ acts as a buffer between Intranet and Internet. It receives connections from the Internet and has access to the Intranet for fetching data or supplying new incoming ones. Thus, suitable policies are set up by the Information System department to enable the exchange of information on either side. Usually in this zone usually no sensible data must be stored nor accessed from the Intranet in order to prevent any leakage in case of any misconfiguration or exploiting attack.

According to the CAPABLE deployment architecture shown in Figure 16.2.1 the only Component located in this area is the Front End Server Component. This is expected to interface with the patient Smartphones and the doctor Desktop where the web application displaying patient information is accessed. No information is planned to be stored on the Front End Server Component except for technical cookies enabling session. The connections of the Front End Server Component towards the Intranet are expected to target only the Data Platform and the Case Manager. In the former case the purpose is reading patient data and entering new ones, while in the latter is for receiving notifications about events concerning patients that need to be forwarded to their Smartphones on the internet for triggering suitable actions.

CAPABLE components, whether deployed on Intranet or DMZ, will access the Data Platform (both for read and write operations) through REST APIs which will comply with state-of-the-art network standards (e.g. TLS  $\geq$  1.2) and will also use proper authentication methods. All the technical details about communication and authentication methods will be incrementally defined and refined in WP4 during the design and development phase of the project, which will last until the last iteration of requirement collection (M24).

The third zone of the 3-tier architecture is the Internet where no control may be enforced by the Information System Departments of any business. In CAPABLE the Internet will be exploited chiefly for reaching out to patients through their Smartphones. In this way they receive notifications by the CAPABLE system concerning advice to provide data useful for a better follow-up by the clinical staff or coaching actions with suggestions aimed at improving their compliance to the treatment. Through the same link patients may also spontaneously enter Patient Reported Outcomes or Patient Reported Experiences without being solicited by the system. Finally, the same Smartphone link is exploited by clinical or ambient Sensors that regularly and autonomously provide information about some clinical parameters (e.g. temperature, heartbeat, blood pressure) or environmental conditions (e.g. humidity, temperature, location, etc.). The link to the Smartphones is provided by the Front-End Server Component located on the DMZ which on its turn has access to the CAPABLE Components on the Intranet for providing the relevant services.

The same Front End Server Component also hosts the Web Application that is accessed by the Desktop stations of the medical staff to oversee the patients enrolled in the study. If the medical staff will only connect from within the institution premises (i.e. the Intranet) accessing this service will be disabled from the Internet zone.

The general architecture (and procedures, which must be considered altogether) of CAPABLE complies with Privacy by Design. In fact:

- All patient's data inside the Data Platform (the only place where patient's data can stay) are pseudonymized. The link between CAPABLE id and hospital id is managed (like in every study/trial) separately by the hospital.
- The only (partial) exception to the above is the link between CAPABLE id and "smartphone id" (necessary to correctly invoice notifications to the devices): it will be

conserved into a separate database (referred to as “user interface private repository”) which also will be installed inside the hospital premises and will undertake specific management rules.

- We will collect exclusively data that are relevant for the project: because it is generated by some CAPABLE component or because is among those that hospitals allowed to be imported from their HIS.
- Also, the data access, thanks to the fact that is not direct on the database but mediated by a software layer (the FHIR APIs indeed) allow to limit access to particular data for specific components. Again, this is something that we, as a team, have not decided yet; but if we are arguing about design: using APIs is the best way to possibly do it.
- The loosely coupled design and the fact that component will interact with web services allows to integrate state-of-the-art authentication and encryption technologies: these have not been chosen yet (we plan to do it next year), but design is compliant with them. Furthermore, having http call as the only way of exchanging information between components, allows a fine network route tuning.
- Storage and processing of data are separated.
- We have a built-in (it is a core feature of the project) feature to notify patients (if we decide to do it...) when their data is processed.
- Like in every study, patients will sign an informed consent to be enrolled in the trial and will be able to leave whenever they want. The fact that only Data Platform has their data allows to easily un-enroll them.

## 7.. Data representation

---

This section presents the data representation requirements, data storage representation requirements, data exchange representation requirements, metadata requirements, data platform considerations

### 7.1. Data representation requirements

---

The modularized design of the CAPABLE system and its adherence to the FAIR principles (Wilkinson et al., 2016) necessitate the use and integration of existing healthcare information standards. This entails standards for data storage and for data exchange, including the underlying data model and use of standardized terminologies and ontologies. It also encompasses proper description of the metadata, which includes the implemented models and vocabularies, but also summary information such as the number of patients included, and provenance data (NISO, 2017). As shown in Figure 1, the CAPABLE system is populated with a selection of EHR data. In addition, it provides interaction with mobile devices of patients, and with computer systems of clinicians. The first interaction includes receipt of PROs and PREs, based on which actions for motivation or coaching are sent to the patients, the second interaction includes therapy updates from clinicians, based on which suggestions or alarms are provided to the clinician. All of this contributes to a data set used for training the AI tools, and the trained tools will guide the delivery of advice to patients and clinicians.

In this chapter, we specify the requirements regarding data representation, that should facilitate storage and exchange of information and of metadata. For this we apply the **MoSCoW** method. This distinguishes:

**Must have** – Critical requirements. Failure to fulfill implies failure of this aspect of the project.

**Should have** – Requirements that are important but not necessary for success.

**Could have** – Requirements that are desirable but not necessary

**Won't have** – Requirements that are (currently) inappropriate

## 7.2. Data storage representation requirements

Representation of stored data should facilitate capture of data collected in different environments, including data from different electronic health records in different countries. Hence, these data need to be stored in a harmonized way, conforming to international standards. This implies that a standard information model and standardized vocabularies are applied. Such models include:

- CDISC - The Clinical Data Interchange Standards Consortium provides an Operational Data Model (ODM) “to facilitate the regulatory-compliant acquisition, archival and interchange of metadata and data for clinical research studies” (CDISC, 2020). CDISC is among the leading standards development organizations (SDOs) in the area of clinical trials. Its aim to enable compliance to regulations in clinical trials puts “Study” in the heart of the model, together with administrative information, e.g. about users, and clinical data, such as subject data, which is described in terms of (case report) forms and items on these forms.
- I2b2 – Informatics for Integrating Biology & the Bedside. This “enables effective collaboration for precision medicine, through the sharing, integration, standardization and analysis of heterogenous data from healthcare and research; through engagement and mobilization of a life sciences focused open-source, open-data community” (i2b2, 2020). The i2b2 model has been implemented in the open-source transSMART data warehouse (TransSMART, 2020), which has been actively developed until 2018 but seems to lose traction since 2019. While of relevance, the focus on precision medicine and life sciences may render this a suboptimal solution.
- OMOP CDM - The Observational Medical Outcomes Partnership, now called Observational Health Data Sciences and Informatics (OHDSI) is a global collaborative intending to facilitate large-scale distributed data analyses. To this end, a common data model (CDM) has been developed, that aims at providing a generic model for representation of observational, real-world, data. The CDM is complemented by a vocabulary, Athena, in which links to about 100 proprietary as well as international vocabularies are being provided. In addition to the data model and vocabularies, a suite of tools is provided to support the extract-transform-load of proprietary data into OMOP CDM, and for performing quality assessment as well as federated analysis on the data.
- OpenEHR / ISO13606; ISO13940; ISO12967 – OpenEHR provides specifications and reference implementations of the ISO13606 “Electronic Health Record Communication” standard. ISO13940 “System of concepts for the continuity of care”, provides a conceptual framework to represent the elements of importance for realizing continuity of care. ISO12967 “Health Informatics Service Architecture” provides an architectural viewpoint on electronic health records. Together, these 3 standards provide a generic description for representation of data in healthcare information systems. Being generic and conceptual provides the rigor required for such foundational standards, but also leaves a relatively large implementation gap to be filled. For example, no allowed or preferred vocabularies are specified.
- PCORnet – The (USA) National Patient-Centered Clinical Research Network provides a Common Data Model that “defines a standard organization and representation of data for the PCORnet Distributed Research Network”. This network aims to integrate data from heterogeneous networks. In practice, these heterogeneous networks first harmonize to other CDMs from this list, i2b2 and OMOP (Belenkaya et al., 2015). PCORnet adheres to use of those terminologies that are most common in the USA, i.e., ICD-9-CM, ICD-10-CM, ICD-11-CM and SNOMED CT for conditions, and ICD-9-CM, ICD-10-PCS, ICD-11-PCS, CPT (Current Procedural Terminology) or HCPCS (Healthcare Common Procedure Coding System) for procedures (PCORNET CDM, 2019).
- Sentinel – Through the Sentinel Initiative, the U.S. Food and Drug Administration (FDA) aims to develop new ways to assess the safety of approved medical products including drugs, vaccines, and medical devices (Sentinel, 2020). The Sentinel Common Data Model (SCDM)

is a standard data structure to allow partners to perform distributed analyses. It enables capture of enrolment data, and clinical data, including lab and clinical findings, pharmacotherapeutic information, and hospitalization information. Unlike most of the other data models, variables such as height (in inches) and weight (in lbs) are explicitly specified. Coding

The overview above shows that these models are not competitors, but rather overlapping and complementing (Moinat, 2019). This is also demonstrated by collaborative efforts, such as the Biomedical Research Integrated Domain Group (BRIDG) that develops a model to harmonize among CDISC, HL7, and ISO standards (BRIDG,2020), and IHE (integrating the healthcare enterprise), that specifies implementation profiles based on a broad range of modeling and other standards (IHE, 2020). A “perfect fit” for the CAPABLE project depends on many aspects, including: practical utility and available support by tooling, alignment with the intended goals and domain in CAPABLE, and support for use of those standards that are most applicable.

**Models and vocabularies** are to fulfill these requirements

**MUST** adhere to international standards. I.e., one of the models above, or another broadly accepted model is to be selected.

**MUST** provide an extension mechanism, so that data elements or values not covered natively by the model or vocabulary can be included.

**SHOULD** cater for capture of the vast majority of information to be represented.

**SHOULD** provide unambiguous representation of information, i.e., restrict freedom of interpretation or implementation.

**SHOULD** be available for use throughout Europe, and preferably globally.

**COULD** provide implementation guidance in the form of guidelines and or tooling.

## 7.3. Data exchange representation requirements

---

Exchange of healthcare information relies on agreed format and contents of messages. A specification on the exchanged “payload” needs to be provided for a variety of scenarios. In healthcare, this can be realized by adoption of one or more proprietary and/or standard messaging approaches. If multiple approaches are adopted, an integration service is used to realize syntactic interoperability as well as process interoperability. Integration services include products such as CloverLeaf (CloverLeaf, 2020), Corepoint (Corepoint, 2020), Rhapsody (Rhapsody, 2020), or NextGen Connect (NextGen, 2020).

Standard messaging formats include HL7 v2, v3, and FHIR<sup>®</sup>, Consolidated CDA, and DICOM. The HL7 family of standards, version 2, 3 and FHIR offers three generations of messaging paradigms. Version 2, coming from the era of 1980s’ electronic data interchange (EDI) is based on compound strings, in which segments are separated by the pipe symbol “|”. Version 3, developed in the late 1990s, uses XML as exchange format, and an extensive set of elaborate models to which these XML-messages should adhere. HL7 FHIR, under development since the 2010s, is based on the REST (for: representational state transfer) architecture, with URL-based calls and JSON (JavaScript Object Notation) replies. Around the globe there are still many HL7v2 systems in place, and only a small amount of HL7v3, which is considered stale before being production-ready. Consolidated CDA (for: Clinical Document Architecture) is a content specification describing the required contents of documents in information exchange. While originally based on HL7v3, efforts are ongoing to apply the specification in HL7 FHIR.

DICOM (Digital Imaging & Communications in Medicine) is a broadly adopted standard for exchange of image data.

**Data exchange representations** are to fulfill these requirements

**MUST** be an internationally accepted standard.

**MUST** be possible to be aligned with the selected storage representation.

**MUST** provide mechanisms for configuration to fit the CAPABLE use case.

**SHOULD** be based on state-of-the art communication, including support for secure communication, including role-based authentication.

**SHOULD** be accepted by the broader software-vendor community.

## 7.4. Metadata requirements

---

While data and storage representations are guided by the specific clinical contents that need to be stored and exchanged, metadata and the requirements posed on it are much more open to interpretation. There are different types of metadata, but the exact contents of each of these types are to be determined. This implies that the representation requirements regarding metadata are more generic, and may need to be determined in more detail once the specific metadata are determined.

According to NISO (NISO, 2017), various types of metadata can be distinguished, for which requirements are to be determined.

1. Descriptive metadata. These are for finding or understanding a resource, including for example author, subject, or publication date.
2. Administrative metadata
  - a. Technical metadata. These are for decoding and rendering files, and describe for example file size and compression scheme.
  - b. Preservation metadata. These help to establish long-term management of files, and describe for example a checksum.
  - c. Rights metadata. These cover intellectual property rights attached to content, such as copyright status and license terms.
3. Structural metadata. This provides relationships of parts of resources to one another, such as sequence number or hierarchical placement.
4. Markup languages. These integrate metadata and flags for other structural or semantic features within content, providing for example paragraphs, headings, and lists.

For CAPABLE, adherence to a recent release of the DCAT Application Profile for data portals in Europe (DCAT-AP) will be sought. DCAT-AP is “a specification for metadata records to meet the specific application needs of data portals in Europe while providing semantic interoperability with other applications on the basis of reuse of established controlled vocabularies (e.g. EuroVoc) and mappings to existing metadata vocabularies (e.g. Dublin Core, SDMX, INSPIRE metadata, etc.)” (European Union, 2020).

This includes that we will distinguish catalogues and datasets, for which metadata will be specified.

**Metadata representations** are to fulfill these requirements

**MUST** adhere to DCAT, implying it distinguishes catalogues from data sets

**MUST** adopt well-accepted vocabularies such as Dublin Core

**SHOULD** adhere to a recent version of DCAT-AP (currently 2.0.1)

**SHOULD** cater for capture of the types of metadata as laid out by NISO.

## 7.5. Data Platform Considerations

---

Based on the requirements laid out in the preceding sections, we explore initial considerations for storage and exchange, namely OMOP CDM and HL7 FHIR.

This includes the possibility of transformation of data between these two standards.

### □ Observational Medical Outcomes Partnership (OMOP)

The Observational Medical Outcomes Partnership (OMOP) Common Data Model (CDM) (Blacketer, 2020) allows to perform systematic analysis of disparate observational databases. The

idea behind this approach is to transfer data contained within different databases into a single common format (data model) as well as a common representation (terminologies, vocabularies, coding schemes), to allow systematic analysis. The CDM can accommodate both administrative claims and clinical data, allowing users to generate evidence from a wide variety of sources, using standardized analytics tools. The CDM is optimized for research purposes of identifying patient populations with certain healthcare interventions (e.g., drug exposure, medical procedures) and outcomes (conditions, procedures), grouping these patient populations by parameters such as demographics, disease history, treatment, cost, morbidities, treatments and sequence of treatment etc. Table 7.5.1 lists CDM’s capabilities.

OMOP CDM is being developed by the Observational Health Data Sciences and Informatics (OHDSI) initiative. This is a multi-stakeholder, interdisciplinary collaboration aiming at creating open-source solutions that enable the global scientific community to benefit from the value of observational health data through large-scale analytics.

Table 7.5.1. Capabilities of OMOP’s Common Data Model (Blacketer, 2020)

Suitability for purpose	The data is organized and ready for analysis.
Data protection	Patient demographic data is limited.
Design of domains	Person-centric relational data model, where for each record contains the identity of the person and a date is captured as a minimum.
Standardized vocabularies	CDM relies on the Standardized Vocabularies
Maintaining source codes	Codes are mapped to the Standardized Vocabularies. The model also stores the original source code to prevent data lost.
Technology neutrality	The CDM does not relays on a specific technology. It uses any relational database, such as SQL Server, Oracle, SAS, etc.
Scalability	CDM is optimized for data processing to accommodate data sources that vary in size.

**□ Fast Healthcare Interoperability Resources (FHIR)**

Fast Healthcare Interoperability Resources (FHIR) (HL7 International, 2019), developed by HL7, is an interoperability specification for the exchange of healthcare information electronically. HL7 FHIR was developed after HL7 version 3, which was based on a Reference Information Model (RIM), resulting in large numbers of layered, complex and hard to implement models. The goal of FHIR is to standardize the exchange of healthcare information, enabling healthcare providers and administrators to easily share patient information even when they’re using different software systems. FHIR is an industry standard developed in response to the growing use of electronic health records (EHRs) and targeted to simplify implementation without sacrificing information integrity.

FHIR leverages existing logical and theoretical models to provide a consistent, easy to implement, and rigorous mechanism for exchanging data between healthcare applications. The platform is built

around the concept of “resources”. Resources must have a common definition and method of representation, common set of metadata and human readable part. Resources leverage XML, JSON, and HTTP, web standards that can be processed by practically any system, no matter how it was developed. The FHIR API uses a robust set of universal, real-time REST APIs and a unified data model to standardize EHR integration, offering read and write capabilities with any EHR. HL7 FHIR consists of five levels shown in Table 7.5.2 and in Figure 7.5.1. The most relevant level in the context of CAPABLE is Level 4, concerned with record-keeping and data exchange for healthcare process and decision support. Important resources to be used include Problems and Procedures (from the “Clinical” category), Observations (from the “Diagnostics” category), and Medication Requests (from “Medications”).

Table 7.5.2. HL7 FHIR Levels and their functionality

Level	Functionality
(L1) Basic framework	This framework is based on Foundation Module, which is responsible for the overall infrastructure of the FHIR specification. Every implementer works with the content in the foundation module whichever way they use FHIR. The Foundation Module contains most of the basic documentation for the FHIR specification
(L2) Implementation and binding to external specifications	Contains 5 modules: (2.1) Implementer support including information about available libraries and tools; (2.2) Security & Privacy Module which describes how to protect a FHIR server; (2.3) Conformance Module represents metadata about the datatypes, resources and API features of the FHIR specification. Can be used to create derived specifications. (2.4) Terminology Module provides coded data types and externally-defined standard and FHIR-defined terminologies that are used for representing and communicating coded, structured data in the FHIR core specification and profiles; (2.5) FHIR Exchange Module specifies the content of the data exchanged between healthcare applications, and how the exchange is implemented and managed
(L3) Linking to real-world healthcare concepts	This level is based on the Administration Module, which covers the base data that is then linked into the other modules for clinical content, finance/billing, workflow, etc.
(L4) Record-keeping and Data Exchange for the healthcare process	This contains 5 modules: (4.1) Clinical: focuses on the FHIR Resources that represent core clinical information for a patient that are frequently documented, created or retrieved by healthcare providers during the course of clinical care (4.2) Diagnostics: provides an overview and guide to the FHIR content that addresses ordering and reporting of clinical diagnostics including laboratory testing, imaging and genomics (4.3) Medication: is concerned with resources and functionality in 3 main domains: (a) ordering, dispensing, administration of medications and recording statements of medication use; (b) recording of immunizations given (or not given); (c) creation or querying for medications as part of drug information or drug knowledge.



	<p>(4.4) Workflow: focuses on the coordination of activities within and across systems, including requesting activities, dependencies between activities, and orchestration of activities.</p> <p>(4.5) Financial: supports billing, authorizations, and notifications thereof.</p>
<p>(L5) Providing the ability to reason about the healthcare process</p>	<p>The Clinical Reasoning module provides resources and operations to enable the representation, distribution, and evaluation of clinical knowledge artifacts such as clinical decision support rules, quality measures, public health indicators, order sets, and clinical protocols. In addition, the module describes how expression languages can be used throughout the specification to provide dynamic capabilities. Clinical Reasoning involves the ability to represent and encode clinical knowledge in a very broad sense so that it can be integrated into clinical systems. This encoding may be as simple as controlling whether or not a particular section of an order set appears based on the conditions that a patient has, or it may be as complex as representing the care pathway for a patient with multiple conditions.</p>

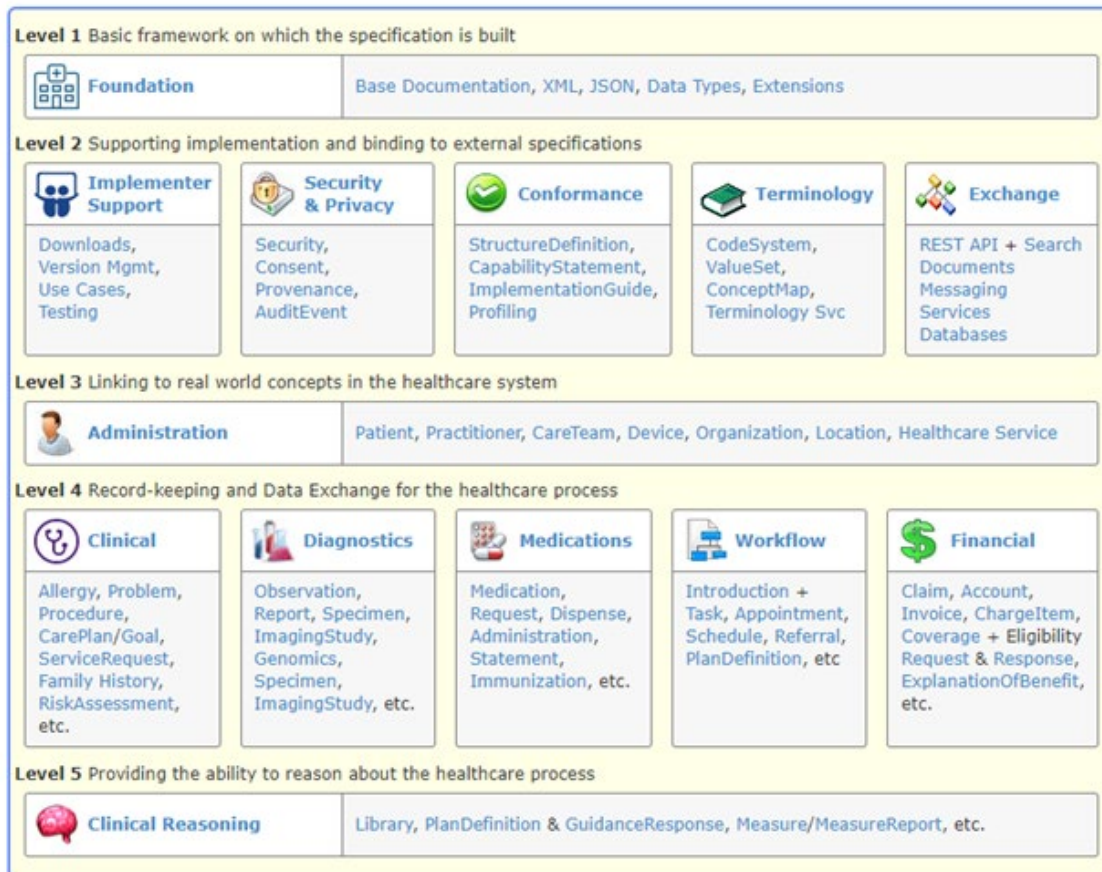


Figure 7.5.1. The five levels of HL7 FHIR (from <https://hl7.org/FHIR/>)

### □ Transformation between OMOP CDM and HL7 FHIR

In (Choi et al., 2016), development of a platform to map OMOP CDM to FHIR is described. They acknowledged that HL7 FHIR and OMOP CDM provide similar capabilities for the sharing of health research data, I.e., using a common data model, Their mapping of the OMOP CDM to FHIR resources was implemented in a platform to serve end-to-end needs from data science to patient care. The resulting platform has been made available, and is being maintained on [github](https://github.com). This will provide ample basis for exploring the extent to which OMOP CDM and HL7 FHIR jointly fulfill the requirements.

## 8.. AI Data processing and analysis

CAPABLE includes different AI components. The analysis and mutual understanding of the ways in which the AI-based components of WP5 will work together among themselves and with other system components (mainly integrated database and the knowledge base) is described as part of the documentation of GoCom, Deontics’ PROforma Engine, and the Virtual Coach in sections 6.9, 6.10, and 6.11.

The requirements related to big data management for sensor data are discussed as part of the Sensor description part (Section 6.8).

Requirements related to abstractions and their mapping to raw data are discussed in the documentation of the KDOM component (Section 6. 4).

It was decided that blockchain protocol will not be used.

The rest of this section focuses on requirements for the AI component that will be developed by IBM. A full data set that includes data reported by the patients while using the CAPABLE app will not be available before Year 4. Therefore, this section presents an analysis and requirements of which predictive models could be developed with existing retrospective data sets from the two hospitals. Because the data items of the retrospective data sets are limited and less comprehensive than the full data set to be collected during Year 4, it is unsafe to disclose to doctors, before they make decisions, the prediction generated by the predictive model; such information can only be provided to them after they have made decisions based on the full record of their patient, via the CAPALBE system.

In the subsections below, we detail an overview of the predictive AI component, the specific aims and methods of the AI predictive component and its requirements. We follow with descriptive statistics of the retrospective data sets, and conclude with risks related to the predictive AI component's development.

### 8.1. Overview of the AI prediction component

The overall purpose of the AI prediction component is to provide data-driven personalized prediction (based on a predictive model) of patients’ outcomes like survival rate and treatment results based on known clinical history and treatment details. This component uses Machine Learning (ML) approaches for knowledge discovery: recognizing patterns within large quantities of medical data in order to generate the predictions (Shamout 2020). Main elements of general ML pipeline are described in Figure 8.1.

The two main steps of the pipeline are: (i) extraction of an intermediary feature space, meaning investigation of which features can be informative to prediction and extraction of them from the raw data and (ii) label prediction using a classification or clustering algorithm

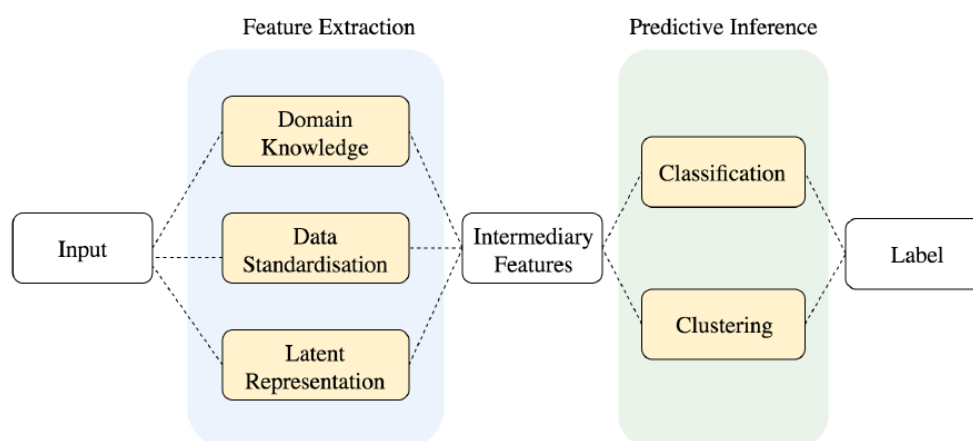


Figure 8.1. General Machine Learning Pipeline

In general, patient’s quantitative and qualitative information has longitudinal structure and can be mapped to several periods over timeline as in Figure 8.2.

Treatment start is an “index date”. All the events before “Index date” relate to “Baseline period” and the events after “index date” like outcomes are in “Follow-up period”.

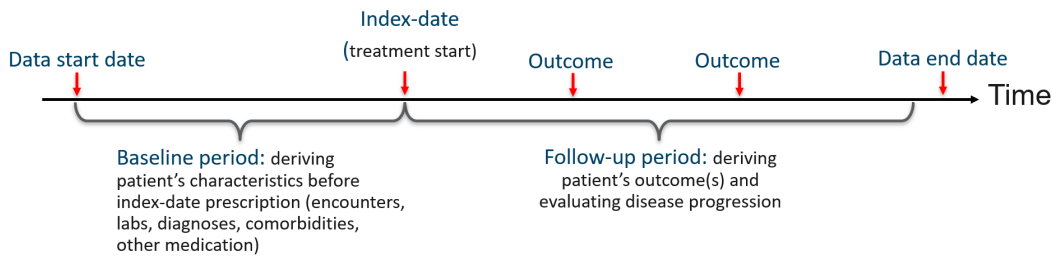


Figure 8.2. Longitudinal Patient Data

Each patient is presented by a vector of features plus labels of outcomes (see Figure 8.3). These tuples will be used to train, validate and test prediction models in a supervised way (Cunningham 2008). For that, cohort of data will be randomly split to train, validation and test. After performing training and validation, the model will be applied on test set that was not seen previously and its results will conclude on the prediction performance.

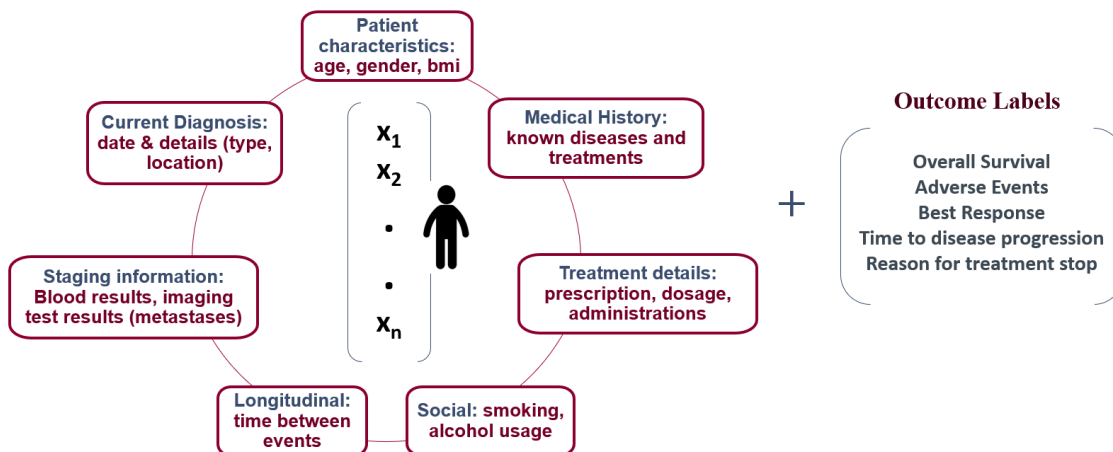


Figure 8.3. Patient feature vector and outcomes

## 8.2. Specific Aims and Methods of the AI predictive component

The main goal of this component in CAPABLE is to provide predictions (based on a predictive model) for patients with metastatic Renal Cell Carcinoma (mRCC) and metastatic Melanoma that were prescribed with corresponding treatments. For this goal, two datasets with retrospective patients were collected:

1. Data set of 500 metastatic Melanoma patients from NKI (Amsterdam, Netherlands)
2. Data set of 343 patients with mRCC from ICS Maugeri (Pavia, Italy)

Both sets have clinical information as well as outcomes labels related to corresponding treatments.

### Predicted Outcomes

Based on analysis of data sets schema and following discussions and interviews with physicians, the scope of predictions includes the following outcomes:

- Overall Survival (Larkin 2019),(Assi 2016)
- Best Response to the treatment out of all reported responses during the treatment time period (Eisenhauer, 2009)
  - o CR – Complete Response

- PR - Partial Response
- SD – Stable Disease
- PD – Progressive Disease
- Adverse events prediction for toxicities of grade 3 or 4 (National Cancer Institute 2017),(Eisen 2012),(Postow 2018),(Eun 2019)
- Reason for treatment termination
  - Disease progression
  - Toxicity
  - Pre-planned (e.g. treatment was completed as planned)
- PFS - Progression Free Survival (For Melanoma patients, since follow-up dates are available in this data set)
- Time between diagnosis of primary Melanoma to appearance of metastatic disease (since we have primary disease characteristics in Melanoma data set)

The proposed list of prediction outcomes may be updated while the project evolves due to the following reasons.

- Two available data sets have different schemas therefore availability of outcome labels can vary between them.
- Small amount of data in each sub-group of possible outcomes may limit the application of machine learning approaches.

## Methods

First, we will analyze the data in order to explore which features are significant to the outcomes we plan to predict using univariate analysis (e.g. Kaplan-Meier for survival rate) and possibly multivariate analysis. Then, we will train prediction models using these significant features (e.g. Cox proportional hazards regression model for survival). Next, different approaches for evaluation of models' performance will be applied: train/validation/test split or leave-one-out or K-fold cross-validation (Refaeilzadeh 2019). Decision on the evaluation approach will depend on data set size.

## 8.3. Requirements for the predictive component and its usage

---

### Data Requirements

In order to develop AI technology there is a need for large data sets with balanced distribution of sub-groups for all outcomes (e.g. patients with vs w/o Toxicity). This is a precondition for reaching statistical power and providing confident results.

Small size of available data sets raises a risk of inability of predicting confident prediction results  
Possible Mitigations:

- Exploring usage of publicly available data sets (e.g. SEER <https://seer.cancer.gov/>)
- Reach more data from NKI & ICS Maugeri in coming one-two years
- Updating list of predicted outcomes after performing statistical power analysis

### Retrospective stage

AI predictions for metastatic melanoma and metastatic RCC will be generated based on available retrospective data sets and will be provided as a comprehensive report that will include statistical analysis and prediction outcomes.

In case, if statistical significance of the prediction results will be achieved, the insights from AI will be given to the DSS component.

### **Prospective stage**

AI system will perform updated training and evaluation on an extended data set that will include retrospective and prospective data collected during Year 4. The results will be presented as a report in a similar way as for the retrospective stage at Q3 of year 4.

Both retrospective and prospective stage reports can serve doctors for their future decisions for patients' treatment.

### **Report Content**

Both retrospective and prospective stage reports will provide predictions for outcomes (mentioned in 8.2) and could serve doctors for their future decisions for patients' management.

#### **Metastatic Melanoma Patients**

Following discussion with Oncologist from NKI, we plan to include the following predictions and analyses:

- Reporting outcomes prediction (e.g. PFS, for full details see section 8.2) per different treatment types, like monotherapy (Anti-PD1) vs Combined treatment (Anti-PD1 + Anti-CTLA-4)
- Reporting analysis for list of features contributing significantly positively and negatively on outcomes (e.g. increased LDH level)

#### **Metastatic RCC patients**

Following discussion with Oncologist from ICS Maugeri we plan to include the following predictions and analyses

- Reporting outcomes prediction (e.g. Survival Rate, for full details see section 8.2) per different medications of Targeted treatment type, like Sunitinib vs Sorafenib
- Reporting analysis for list of features contributing significantly positively and negatively on outcomes (e.g. brain metastases)
- Modeling and prediction according to different risk groups (Heng 2009)
- Comparison to known prognostic models, like MSKCC prognostic model (Motzer 1999)

### **Optional additional AI exploration**

We plan to perform analysis of data collected from the questionnaires of patients' & clinicians' interviews (presented in sections 4,5) in order to explore if AI can detect correlation between non-medical interventions and patients' Quality of Life. This analysis will be of interest for physiotherapists and phycologists treating the patients. Results of this analysis will be provided in next iteration of this document (D2.2)

## **8.4. Descriptive Statistics for Retrospective Data Sets**

Our initial analysis of the data sets provides some descriptive statistics:

NKI (metastatic Melanoma) data set:

Patient Baseline Characteristics - see Figures 8.4.1, 8.4.2

Patient Distribution of Treatment Types and Outcomes - see Figure 8.4.3

ICSM (metastatic Renal Cell Carcinoma) data set:

Patient Baseline Characteristics - see Figure 8.4.4

Patient Distribution of Treatment Types and Outcomes - see Figure 8.4.5

Categorical variable	N. Patients	% of Patients
N. of Patients	500	
<b>Gender</b>		
Male	221	44%
Female	279	56%
<b>Alive/Dead</b>		
Dead	238	48%
Alive Patients	262	52%
Not-completed treatment	51	10%
Completed treatment	211	42%
<b>Melanoma Type</b>		
Acrolentiginous	20	4%
Desmoplastic	7	1%
Lentigo maligna	17	3%
Nodular	109	22%
Superficial spreading	212	42%
Other	19	4%
Unknown	116	23%
<b>Melanoma location</b>		
Acral	21	4%
Extremities	146	29%
Torso	159	32%
Head&Neck	91	18%
Eye	2	0%
Mucosal	20	4%
Unknown	61	12%
<b>Metastases</b>		
Brain Metastases	154	31%
<b>Total Number of Metastases</b>		
1	54	11%
2	22	4%
3	31	6%
Multiple	277	55%
Unknown	116	23%
<b>WHO Performance status</b>		
0 - Fully active	328	66%
1 - Limited in physically strenuous activity	108	22%
2 - Ambulatory and suitable for all self-care	28	6%
3 - Limited self catering only	4	1%
4 - Can't perform self-care	0	0%
Unknown	57	11%

Figure 8.4.1 Patient Baseline Characteristics for Metastatic Melanoma

Categorical variable	N. Patients	% of Patients
<b>BRAF Mutation</b>		
Yes	245	49%
No	243	49%
Unknown	12	2%
<b>NRAS Mutation</b>		
Yes	116	23%
No	328	66%
Unknown	56	11%
<b>KIT Mutation</b>		
Yes	9	2%
No	144	29%
Unknown	347	69%
<b>GNAQ Mutation</b>		
Yes	7	1%
No	58	12%
Unknown	435	87%
<b>GNA11 Mutation</b>		
Yes	7	1%
No	57	11%
Unknown	436	87%
<b>Comorbidities</b>		
Yes	317	63%
No	183	37%
<b>Taking medications</b>		
Yes	282	56%
No	218	44%
<b>Baseline serum LDH level</b>		
Increased (>0,10µg/L)	231	46%
Normal	269	54%
<b>Baseline serum S100 level</b>		
Increased (>250 U/L)	132	26%
Normal	368	74%
<b>Continues variable</b>		
Age at start of treatment (mid of interval)	avg 60, std = 13.69	median =65 IQR [55,75]
Breslow (for 400 patients)	avg=3.41, std=3.27	median =2.5 IQR [1.44,4.2]

Figure 8.4.2 Patient Baseline Characteristics for Metastatic Melanoma (cont.)



Treatment types & Outcomes	N. Patients	% of Patients
<b>Immunotherapy lines (35 patients have treatment 2 lines)</b>		
anti-PD1 (Pembrolizumab or Nivolumab)	389	78%
combined: anti-PD1 and anti-CTLA4 (Nivolumab ar	111	22%
combined + maintenance with anti-PD1 (Nivoluma	35	7%
<b>Best Outcome</b>		
CR - Complete Response	22	4%
PR - Partial Response	211	42%
SD - Stable disease (with and w/o treatment) + tum	99	20%
PD - Progressive disease	154	31%
DOD - Died	7	1%
Unknown	7	1%
<b>Reason for treatment termination</b>		
Pre-planned	89	18%
Toxicity	84	17%
Progression	213	43%
Poor Patient Condition	17	3%
Death	8	2%
Other	30	6%
<b>Toxicity grade III-IV</b>		
for anti-PD1 treatment line	42	8%
for combined or maintenance	73	15%

Figure 8.4.3. Treatment Types and Outcomes for Metastatic Melanoma

Categorical variable	N. Patients	% of Patients
N. of Patients	343	
<b>Gender</b>		
Male	265	77%
Female	78	23%
<b>Alive/Dead</b>		
Dead	306	89%
Alive Patients	37	11%
<b>Nephrectomy</b>		
Yes	328	96%
Unknown	15	4%
Patients with Brain Metastases	40	12%
<b>Primary Tumor Characteristics</b>		
<b>TNM staging (according to 2009 AJCC TNM Classification )</b>		
T1 group (size <=7cm)	47	14%
T2 group (size >7cm )	73	21%
T3 group (extends into major veins)	201	59%
T4 -(tumor invades beyond Gerota's fascia)	7	2%
T stage unknown	15	4%
N0 - No Regional lymph node methastasis	178	52%
N1 - Metastasis in regional lymph node	56	16%
NX - Regional lymph nodes cannot be assessed	94	27%
N stage unknown	15	4%
M0 - No distant metastasis	216	63%
M1 - Distant metastasis	66	19%
M stage unknown	61	18%
<b>Necrosis of primary tumor</b>		
Yes	210	61%
No	118	34%
Unknown	15	4%
<b>Micro Vascular Invasion (MVI) of primary tumor</b>		
Yes	140	41%
No	188	55%
Unknown	15	4%
<b>Fuhrman Nuclear Grade</b>		
Grade I	5	1%
Grade II	106	31%
Grade III	131	38%
Grade IV	86	25%
Unknown	15	4%
<b>Hystology</b>		
Nonclear cell RCC	55	16%
Clear cell RCC	310	90%
Papillary RCC	51	15%
Chromophobe RCC	7	2%
Unclassified RCC	1	0%
Collecting duct carcinoma (CDC)	3	1%
XP11.2 renal translocation carcinoma	12	3%
RCC with sarcomatoid differentiation	92	27%
<b>Continues variable</b>		
Age at primary RCC diagnosis	avg = 54.6, std = 11.87	median =56 IQR [47,63]
Age at diagnosis metastatic RCC	avg = 56.9, std = 12.19	median =58 IQR [49,66]
Primary Tumor Size	avg = 8.63 cm, std = 3.39 cm	median =8 IQR [6,10]

Figure 8.4.4. Patient Baseline Characteristics for Metastatic Renal Cell Carcinoma

Categorical variable	N. Lines	% of Lines
Number of treatment lines	916	
<b>Treatment Type</b>		
Chemo	49	5%
Immunotherapy	52	6%
Targeted	815	89%
<b>Metastases at treatment start</b>		
1 site	143	16%
More than 1 site	741	81%
Unknown	32	3%
<b>Outcomes</b>		
<b>Best Response</b>		
CR - Complete Response	12	1%
PR - Partial Response	156	17%
SD - Stable disease	480	52%
PD - Progression disease	266	29%
Unknown	2	0%
<b>Reason for treatment termination</b>		
Complete Response	5	1%
Toxicity	53	6%
Progression	783	85%
Progression and Toxicity	8	1%
Death	14	2%
Other	1	0%
Unknown	52	6%
<b>Toxicity</b>		
Reported	170	19%
Caused to dose reduction	134	15%
<b>Most frequent toxicity types</b>		
Hand-foot syndrome	78	9%
Hypertension	52	6%
Asthenia	25	3%
Diarrhea	18	2%
<b>Continues variable at treatment line start</b>		
Age	avg=58.22, std=12.21	median=60 IQR [50,67]
BMI	avg=24.93, std=3.26	median=24.56 IQR [22.58,27,04]
Hemoglobin (g/dL)	avg=12.97, std=3.05	median=12.9 IQR [11.9,14]
Serum Corrected Calcium (mg/dL)	avg=9.73, std=0.57	median=9.8 IQR [9.4,10.1]
LDH (mU/mL)	avg=334.4, std=174.71	median=300 IQR [221,401]
Absolute neutrophil count	avg=5.92, std=1.36	median=6 IQR [5.1,6.8]
Absolute lymphocyte count	avg=1.59, std=0.51	median=1.6 IQR [1.2,1.9]
Platelets count	avg=295, std=102.58	median=289 IQR [217,345]
Serum Sodium (Na) (mmol/l)	avg=141.56, std=3.51	median=141 IQR [139,144]
Creatinine (mg/dL)	avg=1.19, std=0.22	median=1.21 IQR [1.03,1.33]
Karnofsky performace status score	avg=94.51, std=7.33	median=100 IQR [90,100]

Figure 8.4.5. Treatment Types and Outcomes for Metastatic Renal Cell Carcinoma

## 8.5. Risks for completing the component successfully

Data suitability for performing the task:

- Data size: The data sets are relatively small. Number of patients and plurality of subgroups for predictions in the retrospective data sets can challenge the development of reliable prediction models.
- Data balancing issue: In addition to the general data set size, it is important to have enough patients for each one of the desired outcomes.

Possible Mitigation: exploring usage of publicly available data sets.

## 9.. References

---

- Abu-Dalbouh HM. A Questionnaire Approach Based on the Technology Acceptance Model for Mobile Tracking on Patient Progress Applications. *J Comput Sci.* 2013;9(6):763–70.
- Assi, H.I., Patenaude, F., Toumishey, E., Ross, L., Abdelsalam, M. and Reiman, T., 2016. A simple prognostic model for overall survival in metastatic renal cell carcinoma. *Canadian Urological Association Journal*, 10(3-4), p.113.
- Belenkaya R, et al. Establishing Interoperability Standards between OMOP CDM v4, v5, and PCORnet CDM (2015).  
[https://www.ohdsi.org/web/wiki/lib/exe/fetch.php?media=resources:ohdsi\\_poster\\_v6.pdf](https://www.ohdsi.org/web/wiki/lib/exe/fetch.php?media=resources:ohdsi_poster_v6.pdf)
- Blacketer C. Chapter 4 The Common Data Model (of OMOP). In: *The Book of OHDSI*, 2020.  
<https://ohdsi.github.io/TheBookOfOhdsi/CommonDataModel.html#design-principles>
- Braun, Virginia and Clarke, Victoria (2006) Using thematic analysis in psychology. *Qualitative Research in Psychology*, 3 (2). pp.77-101. ISSN 1478-0887.
- Brenner, W., Uebernickel, F., Abrel, T. (2016). Design thinking as mindset, process, and toolbox, in Brenner, W. and Uebernickel, F. (Eds.) *Design thinking for innovation research and practice*, ch 1, Springer, NY.
- BRIDG, 2020. <https://bridgmodel.nci.nih.gov/>
- Calvo, R. A., & Peters, D. (2015). Introduction to positive computing -technology that fosters wellbeing. *Conference on Human Factors in Computing Systems - Proceedings*, 18, 2499–2500.
- CDISC (2020), [https://en.wikipedia.org/wiki/Clinical\\_Data\\_Interchange\\_Standards\\_Consortium](https://en.wikipedia.org/wiki/Clinical_Data_Interchange_Standards_Consortium)
- M. Choi, R. Starr, M. Braunstein, and J. Duke, 2016. "OHDSI on FHIR Platform Development with OMOP CDM mapping to FHIR Resources," [ODHSI 2016](#)
- CloverLeaf (2020). <https://www.infor.com/products/cloverleaf>
- Corepoint (2020), <https://www.lyniate.com/corepoint>
- Cortes, Corinna; Vapnik, Vladimir N. (1995). "Support-vector networks". *Machine Learning*. 20 (3): 273–297
- Cunningham, P., Cord, M. and Delany, S.J., 2008. Supervised learning. In *Machine learning techniques for multimedia* (pp. 21-49). Springer, Berlin, Heidelberg.  
[https://link.springer.com/chapter/10.1007/978-3-540-75171-7\\_2](https://link.springer.com/chapter/10.1007/978-3-540-75171-7_2)
- Davis, F. D. (1989). Perceived usefulness, perceived ease of use, and user acceptance of information technology. *MIS Quarterly: Management Information Systems*, 13(3), 319–339.  
<https://doi.org/10.2307/249008>
- DeFranco, J., Kassab, M., Laplante, P. et al. The nonfunctional requirement focus in medical device software: a systematic mapping study and taxonomy. *Innovations Syst Softw Eng* 13, 81–100 (2017). <https://doi.org/10.1007/s11334-017-0301-6>
- Eisen, T., Sternberg, C.N., Robert, C., Mulders, P., Pyle, L., Zbinden, S., Izzedine, H. and Escudier, B., 2012. Targeted therapies for renal cell carcinoma: review of adverse event management strategies. *Journal of the National Cancer Institute*, 104(2), pp.93-113.
- Eisenhauer, E.A., Therasse, P., Bogaerts, J., Schwartz, L.H., Sargent, D., Ford, R., Dancey, J., Arbuck, S., Gwyther, S., Mooney, M. and Rubinstein, L., 2009. New response evaluation criteria in solid tumours: revised RECIST guideline (version 1.1). *European journal of cancer*, 45(2), pp.228-247.
- Eun, Y., Kim, I.Y., Sun, J.M., Lee, J., Cha, H.S., Koh, E.M., Kim, H. and Lee, J., 2019. Risk factors for immune-related adverse events associated with anti-PD-1 pembrolizumab. *Scientific reports*, 9(1), pp.1-8.
- European Union (2020). <https://joinup.ec.europa.eu/collection/semantic-interoperability-community-semic/solution/dcat-application-profile-data-portals-europe/release/201-0>
- FHIR, FHIR Overview, <https://www.hl7.org/fhir/overview.html#2.13>
- FHIR-ID, FHIR Logical Id, <https://www.hl7.org/fhir/resource.html#id>
- Fitbit Inc. "Fitbit Charge". <https://www.fitbit.com/eu/charge4> Last accessed Nov. 5, 2020.

- Fitbit Inc. "Fitbit System Developer Guide". <https://dev.fitbit.com/> Last accessed Nov. 5, 2020.
- Fitbit Inc. "Fitbit Activity & Exercise Logs". <https://dev.fitbit.com/build/reference/web-api/activity> Last accessed Nov. 5, 2020.
- Gray, D. (2017). Updated Empathy Map Canvas. Retrieved from <https://medium.com/the-xplane-collection/updated-empathy-map-canvas-46df22df3c8a>
- Harding, J. (2013) *Qualitative Data Analysis from Start to Finish* (1). United Kingdom, London: Sage Publications Ltd.
- Hassenzahl, M (2011). *The Encyclopedia of Human-Computer Interaction*, 2nd Ed. Chapter 3: "User Experience and Experience Design", <https://www.interaction-design.org/literature/book/the-encyclopedia-of-human-computer-interaction-2nd-ed>
- Heng, D.Y., Xie, W., Regan, M.M., Warren, M.A., Golshayan, A.R., Sahi, C., Eigl, B.J., Ruether, J.D., Cheng, T., North, S. and Venner, P., 2009. Prognostic factors for overall survival in patients with metastatic renal cell carcinoma treated with vascular endothelial growth factor-targeted agents: results from a large, multicenter study. *Journal of clinical oncology*, 27(34), pp.5794-5799.
- HL7 International. Overview-clinical - FHIR v4.0.1 2019. <https://www.hl7.org/fhir/overview-clinical.html>
- I2B2 (2020), [www.i2b2.org](http://www.i2b2.org)
- IHE (2020). <https://www.ihe.net/>
- Institute of Medicine, *Capturing Social and Behavioral Domains and Measures in Electronic Health Records: Phase 2*. National Academic Press, Washington (DC) (2015).
- Joormann J, Gotlib IH. Emotion regulation in depression: Relation to cognitive inhibition. *Cognition & Emotion*. 2010; 24(2):281–298. [PubMed: 20300538]
- Kotler P., *Marketing 4.0: Moving from Traditional to Digital*, John Wiley & Sons, 2016.
- Larkin, J., Chiarion-Sileni, V., Gonzalez, R., Grob, J.J., Rutkowski, P., Lao, C.D., Cowey, C.L., Schadendorf, D., Wagstaff, J., Dummer, R. and Ferrucci, P.F., 2019. Five-year survival with combined nivolumab and ipilimumab in advanced melanoma. *New England Journal of Medicine*, 381(16), pp.1535-1546.
- Lerouge C, Dickhut K, Lisetti C, Sangameswaran S, Malasanos T. Engaging adolescents in a computer-based weight management program: avatars and virtual coaches could help. 2018;(February 2015):19–28.
- Lubberding, S., van Uden-Kraan, C. F., Te Velde, E. A., et al. (2015) Improving access to supportive cancer care through an eHealth application: a qualitative needs assessment among cancer survivors. *Journal of Clinical Nursing*, 24, 1367 – 1379.
- Lucassen G, Dalpiaz F, Martijn J. Improving agile requirements: the Quality User Story framework and tool. *Requirement Eng*. 2016;21(3):383–403.
- Motzer, R.J., Mazumdar, M., Bacik, J., Berg, W., Amsterdam, A. and Ferrara, J., 1999. Survival and prognostic stratification of 670 patients with advanced renal cell carcinoma. *Journal of clinical oncology*, 17(8), pp.2530-2530.
- Mikolov, Tomas; et al. (2013 a). "Efficient Estimation of Word Representations in Vector Space" <https://arxiv.org/abs/1301.3781>
- Mikolov, Tomas (2013 b). "Distributed representations of words and phrases and their compositionality". *Advances in Neural Information Processing Systems* <https://arxiv.org/abs/1310.4546>
- Moinat M (2019), Where does OMOP-OHDSI fit in the open source health informatics environment? <http://blog.thehyve.nl/blog/omop-ohdsi-health-informatics-environment>
- Mummah SA, Robinson TN, King AC, Gardner CD, Sutton S. IDEAS (Integrate, Design, Assess, and Share): A Framework and Toolkit of Strategies for the Development of More Effective Digital Interventions to Change Health Behavior. *JMIR*. 2016;18(12):e317.
- National Cancer Institute, 2017. Common terminology criteria for adverse events (CTCAE) v4. 0.
- NISO - National Information Standards Organization, *Understanding Metadata: What is Metadata, and What is it For?: A Primer*. 45 pages. <https://www.niso.org/publications/understanding-metadata-2017> (2017)

- NextGen Connect (2020). <https://github.com/nextgenhealthcare/connect/>
- Norcross JC, Krebs PM, Prochaska JO. Stages of change. *J Clin Psychol.* 2011;67(2):143–54.
- Passardi A, Rizzo M, Maines F, et al (2017). Optimisation and validation of a remote monitoring system (Onco-TreC) for home-based management of oral anticancer therapies: an Italian multicentre feasibility study *BMJ Open* 2017;7:e014617. doi: 10.1136/bmjopen-2016-014617
- PCORNET CDM (2019), [https://pcorntnet.org/wp-content/uploads/2019/09/PCORnet-Common-Data-Model-v51-2019\\_09\\_12.pdf](https://pcorntnet.org/wp-content/uploads/2019/09/PCORnet-Common-Data-Model-v51-2019_09_12.pdf)
- Pedregosa, F., Varoquaux, G., Gramfort, A., Michel, V., Thirion, B., Grisel, O., ... & Vanderplas, J. (2011). Scikit-learn: Machine learning in Python. *the Journal of machine Learning research*, 12, 2825-2830.
- Peleg M, Shahar Y, Quaglin Si, et al. MobiGuide: a personalized and patient-centric decision-support system and its evaluation in the atrial fibrillation and gestational diabetes domains. *User Modeling and User-adapted Interaction* 2017;27(2):159-213. DOI: 10.1007/s11257-017-9190-5.
- Peleg M, Michalowski W, Wilk S, Parimbelli E, Bonaccio S, O’Sullivan D, et al. Ideating Mobile Health Behavioral Support for Compliance to Therapy for Patients with Chronic Disease: A Case Study of Atrial Fibrillation Management. *J Med Syst [Internet]*. 2018;42:234–48. Available from: [http://mis.hevra.haifa.ac.il/~morpeleg/JOMS-D-18-00315\\_R1.pdf](http://mis.hevra.haifa.ac.il/~morpeleg/JOMS-D-18-00315_R1.pdf)
- OHDSI-OMOP-CDM, OMOP Common Data Model, <https://ohdsi.github.io/CommonDataModel/cdm531.html>
- OHDSI-VOC, OHDSI, Building the Standardized Vocabularies, <https://ohdsi.github.io/TheBookOfOhdsi/StandardizedVocabularies.html#building-the-standardized-vocabularies>
- Postow, M.A., Sidlow, R. and Hellmann, M.D., 2018. Immune-related adverse events associated with immune checkpoint blockade. *New England Journal of Medicine*, 378(2), pp.158-168.
- Refaeilzadeh, P., Tang, L. and Liu, H., 2009. Cross-Validation. *Encyclopedia of database systems*, 5, pp.532-538.
- Rhapsody (2020). <https://www.lyniate.com/rhapsody>
- Rincon, E., Monteiro-Guerra, F., Rivera-Romero, O., et al. (2017) Mobile Phone Apps for Quality of Life and Well-Being Assessment in Breast and Prostate Cancer Patients: Systematic Review. *JMIR Mhealth Uhealth*, 5 (12), e18.
- Schreiweis, B., Pobiruchin, M., Strotbaum, V., Suleder, J., Wiesner, M., & Bergh, B. (2019). Barriers and Facilitators to the Implementation of eHealth Services: Systematic Literature Analysis. *Journal of medical Internet research*, 21(11), e14197. <https://doi.org/10.2196/14197>
- Sentinel (2020), <https://www.sentinelinitiative.org/about>
- Shamout, F., Zhu, T. and Clifton, D.A., 2020. Machine learning for clinical outcome prediction. *IEEE Reviews in Biomedical Engineering*.
- TranSMART (2020), <https://en.wikipedia.org/wiki/TranSMART>
- Wang, T., Molassiotis, A., Chung, B. P. M., Tan, J. (2018) Unmet care needs of advanced cancer patients and their informal care givers: a systematic review. *BMC Palliative Care*, 17(1), 96.
- Wilkinson, M. D. et al. The FAIR Guiding Principles for scientific data management and stewardship. *Sci. Data* 3:160018 doi: 10.1038/sdata.2016.18 (2016).

## 10.. Appendices

---

### 10.1. Abbreviations List and Glossary

---

ADE – Adverse Drug Events

AVL – Antoni van Leeuwenhoek hospital, Amsterdam, The Netherlands

BLE – Bluetooth Low Energy – compared to [Classic Bluetooth](#), Bluetooth Low Energy is intended to provide considerably reduced power consumption and cost while maintaining a [similar communication range](#).

CDM – Common Data Model

CKvL – Centre for Quality of Life, supportive care center within AVL

Computer-interpretable Guideline (CIG) - a set of formalisms used for modeling clinical guidelines in an enactable format

CTCAE - Common Terminology Criteria for Adverse Events - a set of criteria for the standardized classification of adverse effects of drugs used in cancer therapy

Data Platform – the semantically integrated patient database of FHIR that follows the OMOP model and can be accessed via HL7 FHIR APIs.

Decision-support System (DSS)

EHR – electronic health record

ETL – Extract Transform Load

FHIR - Fast Healthcare Interoperability Resources - patient data exchange standard of HL7

GoCom – Goal-oriented Comorbidity decision support - the multimorbidity “Controller” which provides clinical-guideline based decision support for multimorbidity patients

GP - General Practitioner

GPS – Global Positioning System

GPRS - General Packet Radio Service

HCD - Human Centered Design

HCPs – healthcare professionals

HIS – Hospital Information System

HTTPS - Hypertext Transfer Protocol Secure

ICIs – immune checkpoint inhibitors (immunotherapy)

Knowledge-Data Ontology Mapper (KDOM) - CAPABLE component for mapping abstract clinical concepts to raw patient data

MVVM – Model-view-view-mode – is a software architectural pattern that facilitates the separation of the development of the graphical user interface (the view) from the development of the business logic or back-end logic (the model) so that the view is not dependent on any specific model platform.

OMOP - Observational Medical Outcomes Partnership

Physician DSS – a wrapper that consolidates all the DSS services provided to physicians: from the Deontics Engine and GoCom

PROforma – the CIG formalism used in CAPABLE

SNOMED-CT – Systematized Nomenclature of Medicine - Clinical Terms. A systematic, computer-processable collection of medical terms, to provide codes, terms, synonyms and definitions. It allows a consistent way to index, store, retrieve, and aggregate medical data across specialties and sites of care the most comprehensive clinical vocabulary system available.

TLS - Transport Layer Security

VC – Virtual Coach – DSS for patients

VPS – Virtual Private Service

VDS – Virtual Desktop Service

WHD – Wearable Health Devices

## 10.2. Interview Questionnaires

### 10.2.1. Semi-structured patient interview guide

Interview guide for patients (English) - NKI

Introduction	
Introduction	Introduction
Aim of the study	Explain why we want to use the information of patients and healthcare providers for the content of the app.
Topics	Topics we will discuss: <ul style="list-style-type: none"> <li>• General questions about patient</li> <li>• Current situation</li> <li>• Explanation about CAPABLE app</li> <li>• Intention to use</li> <li>• Content of the CAPABLE-app</li> <li>• Acceptability and preferences about use of CAPABLE</li> </ul>
Privacy	Explain anonymization.
Early cancellation	Explain that patient can quit interview anytime.
Recording	Ask consent for recording the interview.

Variables, topics, central questions and sub questions	
1. General - Age, gender, marital status, etc. - Diagnosis of melanoma (when, impact, etc.) - How far in and what treatment - Treatment relationship with doctor?	Can you tell us something about yourself and your illness/treatment? How do you experience the care and treatment relationship with your doctor?  Sub-questions: - What route are you going through in the hospital?
2. Current situation - Daily life - Setbacks - Support system - Care from hospital	How does a typical day look for you (health-related)? Express also your actions, thoughts, and feelings on a good day, and a not-good day. What setbacks do you have to deal with? How do you retrieve support for your setbacks? What does well-being mean for you? Sub-questions: - How could this be better?



<p>- How do you solve your setbacks?</p>	
<p>Explanation about CAPABLE app            CAPABLE will (1) educate the patient about the disease and treatments, (2) screen patients via their Smartphones to assess and visualize their wellbeing state and disease state (symptom reporting, answering well-being questionnaires to measure patient quality of life, sensors measuring temperature, physical activity, heart rate, sleep quality), (3) provide reminders for therapies and recommendations and reminders to improve wellbeing; in addition to medications, there will be ideas for mindfulness activities and social support. The recommendations and ideas will be evidence-based. CAPABLE will also (4) support communication with staff. The app will make use of the so-called “Capsules”. Capsules – the ideas that the patient can get about how to improve her/his mental, social and spiritual wellbeing. The patient can choose what he would like to improve and how many weekly doses for each wellbeing type. The App will use machine learning to suggest ideas that have helped similar patients and fit with the patient’s preferences.</p>	
<p>3. Intention to use            - Current app usage            - The readability to use the CAPABLE app</p>	<p>Are you currently using internet/apps? If so, for what purposes?            Would you use the CAPABLE app if it were available?</p> <p>Sub-questions:            - If so, why? How often?            - If not, why not?</p>
<p>4. Contents of the CAPABLE app (according to domains)            - Physical            - Daily activity            - Psychological            - Social            - Communication            - Financial            - Spiritual            - Care and support (medication)            - Health care and information            - Symptoms and side effects</p>	<p>What kind of information would you like to have in the CAPABLE app?            Do you have ideas that have helped you to improve your well-being, which we could put in an app and share with other patients?</p> <p><b>When information is missing:</b> physical complaints, daily activities, psychological complaints, social, communication, financial, spiritual, care and support, health care and information, request symptoms. <b>Give examples where necessary!</b></p> <p>Sub-questions (if necessary):            - Do you need information about physical complaints, if so in what way?            - Do you need information about symptoms/side effects of treatment, if so in what way?            - Do you need information or support for psychological complaints?            - Etc. Ask for each interested domain.</p>
<p>5. Acceptance and preferences for the use of CAPABLE (show capsules)            - Requirements            - Capsules</p>	<p>How would you like to use the CAPABLE app?            What requirements would you have for the use of the app? For example, how easy the app is in use. How information has to be displayed? Privacy?</p>

Do you have any additions or ideas for the development of this app?  
 Capsules: Can you suggest additional scenarios with the system? Can you suggest additional ideas for capsules?

Sub-questions:

- What would you like the CAPABLE system to offer you? For example, information, social support, symptoms monitoring, lifestyle (depending on previous answers), **interventions (which kind of capsules)**
- Do you expect a difference in how you approached the doctor or hospital, for example? In what frequency?

Closing	
Closure interview	<p>Would you like to add anything to this conversation?                      Are there topics that have not been discussed in the conversation but that you think is important to tell?                      We will take the interview results and design the CAPABLE system, including the user interface.                      Would you be willing to answer in the future a questionnaire relating to how you value the different features that we will design in the CAPABLE prototype?                      What is your opinion about the interview?</p>
Participation check	Explain that they can get a draft of the interview.
Give thanks for participating	Thank patient for time and input.
Contact details	Contact detail of coordinating investigator.

## 10.2.2. Semi-structured healthcare professional focus group guide

---

Focus group guide HCP’s (English) – NKI

Baseline – stage "zero"

What problems do you encounter in caring for patients receiving immunotherapy for melanoma?

Are there situations where the guideline is not followed (but should be)?

Are there situations where following the guideline requires a lot of effort? Examples:

- Searching through the chart
- Checking for others’ mistakes
- Asking additional questions of the patient, etc. (For students/residents)

Is there information about the patient that you would like to know (that you cannot ask, or you would like to know in-between appointments)?

If we make prediction models related to these patients, what things might be useful to predict?

Example:

- Mortality (endpoints)
- Levels of LDH/s100b, etc.

---

CAPABLE system explanation:

- Decision support based on guidelines
- Summarized patient data
- Prediction models (offline)
- We will elucidate the different parts of the system in the group discussion

The system offers advice based on guidelines (decision support)

What ways might the computer be able to help?

Which guidelines must CAPABLE implement, which could be useful for patients, but also for physicians? (list)

Within those guidelines, what are the most important recommendations to support? Example:

- Not things already done well
- Not things you don't want to do
- Things you would like to do but are difficult

Interface (medical and technical) - plan to have a dashboard accessible whenever they want, might also have the option to integrate with hospital information system – we can build a separate interface or do both

What would you like to see on the interface?

What should you be able to do using the interface? e.g. check ADEs reported by patients in the last week, send messages to specific patients, receive alerts coming from the guidelines about a specific patient of yours, etc.

What general requirements should this system have? For example, does it need to be 24/7 accessible, accessible from web/hospital

What or when should the system provide you information? Notification in the hospital information system/dashboard? Example:

- Symptoms outside of the threshold range?
- Examples of recommendations of guidelines – what kind of support?
- Predictions?

Prediction models might not be available for support during the visit, but supports prediction after.

What predictions would still be useful to see?

Specific question: if data is needed that is not in the patient record, would you enter it in order to get advice or predictions?

---

CAPABLE patient app explanation

- Symptom monitoring (enter information)
- Receive information about treatment and disease
- Receive advise on psychosocial support and mindfulness
- Sensor data

The system offers summarized data coming from the patient's app

What should the user interface for a physician show?

What data about patients is critical to see in the interface?  
 Which data do you think are useful for following up your patients? What would you be most interested in to see (as a summary of patients collected data)?  
 What about sensor data? (physical activity, heart frequency, blood pressure, etc.) How can this be interesting?

What should be available for the patient in the app  
 What are the unmet needs of patients during and after treatment?  
 What would you suggest as content for the patient app? Think of psychosocial support, etc. -->  
 Use domains from patient interviews.

Close interview

After we had this discussion, did it bring up any other ideas of what you like to see being done on this project?

Is there any other thing you would like to add?

What could be the impact of CAPABLE?

What did you think of this group discussion?

### **10.2.3. Patient Questionnaire used in ICS MAUGERI**

#### I. Pre-interview questionnaire

Demographics:

1) What is your age?

2) What is your gender (male, female, other - please state).

3) Who do you live with? Check all that apply

- Myself
- Husband/wife/significant others
- Children
- Other relatives
- Friends
- I live in a residence

4) What is your occupation?

5) Do you have a home caregiver living with you? (yes, no)

6) If you have answered yes, is the caregiver a healthcare professional or a family member?

7) What cancer type do you have?

8) What is the stage of your disease (pre-treatment, treatment, or post-treatment)

9) Are you currently using internet/apps?

10) If so, for what purposes? \_\_\_\_\_

#### II. Semi-structured Interview -

Following User-centered design methods and qualitative research methods, we help the patient think about concrete situations that s/he experienced in order to get more accurate information as compared to that gathered by general questions. The first set of questions concern the current state, with a focus on the well-being of the patient, which we aim to understand and to improve via the Coaching System. The questions are phrased following the IDEAS framework (Mummah et al., 2016). This approach integrates behavioral theory, design thinking (Brenner et al., 2016), user-centered design, rigorous evaluation, and dissemination which each have widely acknowledged merits in their application to digital health interventions. IDEAS is comprised of ten phases

(empathize [with users], specify, ground, ideate, prototype, gather, build, pilot, evaluate, and share), grouped into 4 overarching stages: Integrate, Design, Assess, and Share (IDEAS). The first four questions thus try to empathize with users and allow them to reflect on specific scenarios that form positive as well as challenging situations and how they are handling them currently. Focusing on positive emotions is part of the "Positive Computing" paradigm which seeks new ways to "design and development of technologies to support well-being and human potential" (Calvo and Peters, 2015). Before users are asked to elicit requirements for features of an app that could support their wellbeing, question 4 elicits their personal view of wellbeing. Furthermore, expressing actions, thoughts and feelings in Question 2 follows the Emotional Attachment Framework (Sherkat et al., 2018) which advocates that in order to create a software application or service that will engage end-users it is important to realize their emotional goals and design systems that will address them in a way that arouse good emotions. The instructions that direct the patient to express his actions, thoughts and feelings (in addition to making statements) allows constructing Empathy Maps (of what the patient Says, Thinks, Does, and Feels), in order to help the interviewer understand the patient better (Gray, 2017). Note that the interview will be semi-structured, such that if during the interview the patient should express his or her emotions, the interviewers will empathize and relate to the answers, potentially asking additional questions to clarify and extend the response. Some good rules to follow are: two people should be interviewing to capture everything; ask the patient if you can record the interview; take notes; try to construct an empathy map during and after the interview;.. the person who will conduct the interview will practice first by interviewing a colleague.

1. Tell me a bit about yourself and your health condition (2 min)
2. How does a typical day look for you (health-related)? Express also your actions, thoughts, and feelings on a good day, and a not-good day.
3. Which difficulties (technical-related to adhering to therapy, physical, emotional, social, spiritual, occupational, financial), questions, concerns did you cope with? How did you manage to solve them?
4. What/who helps you going through rough days? How does s/he support you?
5. What does well-being mean for you?

We now describe the purpose of CAPABLE and proceed to ask questions about perceived usefulness and user acceptance of the proposed technology - questions 6 and 8. These questions follow the Technology Acceptance Model (Davis 1989), which is one of the most widely-used models for evaluation of user acceptance of technology. We have also used it in a previous study to assess user perceptions regarding the proposed Coaching System (Peleg et al. 2018). We also try to elicit from the interviewees their own ideas for needed functionality, according to the principles of user-centered design.

Question 7 tries to ideate requirements from the users, following the IDEAS framework. Note that ideas are ideated first after a very brief explanation about CAPABLE is provided (before questions 6-7) and later in question 9, after more details are provided. Question 7 is asked before the detailed explanation in order to allow brainstorming to be free of the conceptions of the research team, which are provided in the detailed explanation below question 8. Thus, questions 7, 9, and 10 correspond to the "ideate" and "test" phases of IDEAS. Note that Question 9 follows the user-story approach of agile methodologies for requirements elicitation (Lucassen et al., 2016). Regarding Question 10: after an idea is proposed we need to look for evidence-based or receive approval from the healthcare experts.

CAPABLE will (1) educate the patient about the disease and treatments, (2) screen patients via their Smartphones to assess and visualize their wellbeing state and disease state (symptom reporting, answering well-being questionnaires to measure patient quality of life, sensors measuring temperature, physical activity, heart rate, sleep quality), (3) provide reminders for therapies and recommendations and reminders to improve wellbeing; in addition to medications, there will be

ideas for mindfulness activities and social support. The recommendations and ideas will be evidence-based. CAPABLE will also (4) support communication with staff.

6. If you will have a system like CAPABLE, what would you want it to provide for you?
7. Do you have ideas that have helped you to improve your well-being which we could put in an app and share with other patients?

Now we provide a little more information on the wellbeing Capsules – the ideas that the patient can get about how to improve her/his mental, social and spiritual wellbeing. The patient can choose what he would like to improve and how many weekly doses for each wellbeing type. The App will use machine learning to suggest ideas that have helped similar patients and fit with the patient’s preferences.

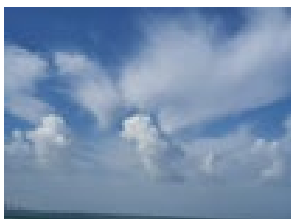
Scenario example - Thursday noon

Giulio is the husband of Maria - a cancer patient. Giulio is on his way back to the office, thinking about his wife. He receives a reminder from the Coaching System to pause and capture a picture of the sky. His picture is being sent to Maria along with the question “what do you see?”.

Last time they tried out this capsule (Monday) she excused him with “Nothing, I see nothing”. But today she replies with “Can’t you see it’s a unicorn?” so he smiles to himself, making note that today is a good day. Also, he notices that this simple act of looking at the sky had a positive effect on his own mood.

Later on, on his way home he surprisingly receives the following picture from Maria. “What do you see?”, she asks him. “I see love”, he replies.

The figures below show examples of capsules that the app can suggest for a patient. Emotion regulation helped women diagnosed with breast cancer to lower their distress. Maintaining thoughts on the now and present was facilitated by disidentifying, including use of metaphors (e.g., visualizing thoughts as clouds passing through the sky (Joormann & Gotlib, 2010). Cancer patients undergoing chemotherapy who had a dog present during sessions rated their symptoms of depression and anxiety half as severe as those who did not (Orlandi et al., 2007). Breast cancer survivors found “Garden Bowl” as reflecting their cancer journey, a source of positivity, making meaning through memories, and a sense of control provided by engagement with the intervention (Phelps et al., 2015).



Sky hints - 2 weekly doses



Pet joy – 5 doses



Garden Bowl - 7 doses

8. If you had such a system, would you use it daily? If not, how often?
9. Can you suggest additional scenarios with the system?
10. Can you suggest additional ideas for capsules?
11. We will take the interview results and design the CAPABLE system, including the user interface. Would you be willing to answer in the future a questionnaire relating to how you value the different features that we will design in the CAPABLE prototype?

Question 11 allows getting a consent for contacting the patients further for a followup questionnaire.

III. Post-interview Survey

For the following 4 questions, please score (by marking a circle) how much you agree with the following statements:

A) Being a cancer patient, my quality of Life (QoL) and my wellbeing is compromised  
 1- Strongly disagree 2- Disagree 3- Neither agree or disagree 4- Agree 5- Strongly agree

B) It is difficult for me to find ways to improve my QoL and wellbeing  
 1- Strongly disagree 2- Disagree 3- Neither agree or disagree 4- Agree 5- Strongly agree

C) I will probably use an app that would provide me information about coping with ADEs, problems sleeping, anxiety, diarrhea, etc.  
 1- Strongly disagree 2- Disagree 3- Neither agree or disagree 4- Agree 5- Strongly agree

D) I will probably use an app that provides me with information on the effects of drug use, degree of personal risk, and advise on developing mental resilience and ways to deal with stress crises, based on my personal and current situation data  
 1- Strongly disagree 2- Disagree 3- Neither agree or disagree 4- Agree 5- Strongly agree

E) We are working to create an app to assist the user during the treatment of cancer condition. Would you use an app like this? (YES / NO)  
 Please score the level of desirability of the following features on a scale of 1-3:

1- Not needed 2- desirable 3- highly desirable

- Educational material related to the condition
- Educational material related to treatments and side effects
- Support to manage emotional distress (anxiety, depression, stress)
- Lifestyle change program to improve habits
- Increase / control of physical activity
- Improvement of sleep quality
- Provide messages to promote positive thinking
- Support in accepting the reduced QoL / physical disabilities induced by the cancer treatment
- Support for pain management
- Support for promoting adherence to treatment
- Other support (please describe)

## 10.2.4. Patient Interview Guide ICS MAUGERI

---

Improving patients' interviews (Viola Ghio, Francesca Traclò)

This document summarizes a training session delivered by Francesca Traclò (AIMAC) to Viola Ghio (ICSM). The aim was to train Viola on how to interview patients.

When interviewing a patient, we should of course ask the questions listed in the questionnaire, but following the scheme blindly can lead to an inefficient interview.

This mini-guide presents some tips on how to improve the interview process and get the most out of the patient's time/effort.

Goals

- Identify patient's needs that can be covered by the app/wearable
- Invite the patient to give suggestions on how to improve the app
- Understand if the app (mockup) is indeed helpful and user friendly

- Observe if the patient is “tech-savvy”, likes the idea of an app/wearable to use often or conversely doesn’t like new techs.
- Target patients to identify the right candidates for future testing

Keeping in mind the goals helps you to ask the right questions

#### Patient’s Key Info

- Personal data (age, sex, working status)
- Family status, who they live with
- The relationship between the patient and apps/ new techs
- The relationship between the patient and the disease
- Psychophysical state

#### Setting

1. Use a recording device (upon patient’s consensus)
2. Sit in a comfortable and quiet room where you won’t be disturbed
3. Don’t forget that if you interview a patient in between their visits they can be tired or not in a good mood. In case postpone the meeting.

#### The brainstorming

##### Intro

Thinking about the interview as a brainstorm will help you focus on the key aspect: how we can improve the patients’ wellness (with their inputs). The app should be tailor-made on the patients’ needs.

First of all, put at ease the patient. Create a “safe space” by reminding them that this process is not mandatory, that at every time point they can stop the interview, and they should be free to express their opinion even if it is strongly negative. Our goal is to collect feedbacks, first impressions and ideas.

Start with a brief introduction of the project. Introduce the *medical* section of the app as a system to become more independent in the management of the mild adverse effects of the therapy and a way to register vital signs in a handy way. Stress the fact that this is not a system to be in contact with the doctor 24/7. However, explain that all the data entered through the app will be seen by the doctors within a few days.

The Capsule section should be introduced as a holistic but science-backed approach to improve the patient psychophysical wellbeing.

The tone of the interview should be close to a chat, ask them about themselves, their life, their typical days and free time. Use an empathetic approach. Be human!

Ask how the people around them –if present- are helping: “is your partner reminding you to take some pills?”, “are your children helping around the house when you are tired?”, and so on.

Try to capture the good and the bad aspects of their life and what helps them at bad times.

Ask also about Covid-19 health issues. Did the pandemic change their lifestyle?

If it is easier, or the patient is not very open, start your interview by making them fill the first part of the questionnaire. In this way you can already have some data to work with.

##### Mockup and wearable presentation

Keeping in mind their answer, start to show them the mockup of the app. Show them the whole app but focus on the parts that can be potentially more useful. Of course start with saying that this is just the backbone of the future app.

Use also the different sections of the app as a way to ask further about their needs and inputs.

Start with the medical part linking symptoms and recommendations. Show them how easy it is to



register them and the vital signs.

After the medical part go to the Capsules. Stress that participating is not mandatory and explain again that all the activities have been proven helpful based on the current literature.

Go to the sleep part, ask if they have some troubles sleeping. This is also a good moment to introduce the fitbit, show them how the wearable/app tracks sleep. The fitbit also track steps, movement and has some included exercise and meditation sessions for beginners to experts. Fitbit reminds you to take some steps if you sit for too long and promote movement as a tool for wellbeing. It can track food/water intake and your weight too.

Then go to the nutritional part. Ask the patients how is their diet and if they need some advice/guidance.

The funny capsules are a way to chill out, or in case of the radio garden, expand the horizon of their interests.

The other sections are more social –in a guided and limited way- and can create a sense of community via different activities. Pay attention to their reaction to those.

End of the Interview

Once the mockup is explained, the interview is almost over. Remind them to fill the “post-interview” part of the questionnaire, be there to explain how to do it and to collect the last reactions to the system.

Thank the patient and stop the registration.

## 10.2.5. Covid questionnaire

---

INTRODUCTION:

This questionnaire aims to understand and evaluate the needs of cancer patients in the times of Covid-19 pandemic, as well as their attitude to use technology to improve their quality of life. For this reason, it is important that - while filling in the questionnaire - the patients go back to the past months and really think about their condition and their needs during the lockdown.

We kindly ask you not only to fill it in carefully, but also to help us spread it as much as possible. The more answers we get, the more information we can process in order to propose suitable solutions:

- to foster a better interaction between the medical staff and the patient;
- to make it easier to access innovative apps to improve quality of life;
- to facilitate access to health services and tests results.

Many thanks for your help!

SURVEY:

The needs of the cancer patients in the times of the Covid19 pandemic

\*Gender

1. Male                      2. Female

\*Age

1. 0-20                      2. 21-40                      3. 41-50                      4. 51-60                      5. Over 61

\* In which region are you living right now?

\*Where do you live?

1. Center of a large city
2. Suburb of a large city
3. Small or medium inland city
4. Small or medium coastal city
5. Isolated house

\* Level of education

1. None
2. Primary school
3. Secondary School
4. Bachelor's Degree
5. Master's Degree
6. Phd

\* Do you currently have a partner?

1. Yes – 2. No

\*Do you have children

1. No
2. Yes, at least 1 child up to 10yrs old
3. Yes, all older than 10yrs old

\* Who are you living with at home these days? (multiple answers are allowed)

1. alone
2. with your partner
3. with child/children
4. with parent (s)
5. with other relatives or cohabitants
6. with a caregiver
99. Other \_\_\_\_\_

\*Right now

do you have an adequate internet connection? 1.Yes 2. No 3. I don't know

do you have adequate digital devices (pc, tablet, smartphone, etc.)? 1.Yes 2. No 3. I don't know

do you have enough digital skills? 1.Yes 2. No 3. I don't know

\* You are:

1. Unemployed
2. Student
3. Occasional worker
4. Part-time worker
5. Full-time worker
6. Retired
7. Housewife/Household

\* What is your job position?

- 1. Manager, entrepreneur, freelancer, manager
- 2. Employee, self-employed
- 3. Worker, home worker, member of a cooperative
- 99. Other \_\_\_\_\_

\*In these days

- 1. I don't work, because I'm sick or on leave
- 2. I am in layoff
- 3. Work from home (agile or smart working)
- 4. I normally go to my workplace
- 5. Work both at home and in the workplace
- 6. I was fired
- 7. I resigned
- 99. Other \_\_\_\_\_ -

\* Can you indicate the site of your tumor?

Which oncological pathology do you suffer from? \*

- 1•Lung
- 2•Kidney
- 3•Breast
- 4• Uterus
- 5• Prostate
- 6• Leukemia
- 7• Colorectal
- 8• Pancreas
- 9• Melanoma
- 10• Thyroid
- 11• lymphoma
- 12• Liver
- 13• Bladder
- 99•Other: \_\_\_\_\_

\* Can you indicate the therapeutic phase of your disease?

- 1.First therapeutic phase after the first diagnosis
- 2. Treatment of a local tumor recurrence (recurrence after response to therapy, followed by an interval free from disease)
- 3. Treatment of tumor in progression (progression = aggravation / extension of the disease, with no complete response to therapy)
- 4.Remote metastasis treatment
- 5.Pain therapy
- 99.Other \_\_\_\_\_ -

1. How much free time do you have these days?

1. More than usual 2. Much more than usual 3. Less than usual 4.As before

2. How do you spend your free time these days? (Multiple answers are possible)

- a. 1.I listen and read the news
- b. 2.I pray or attend online religious services
- c. 3.I practice sport at home
- d. 4.I browse the web to pass the time
- e. 5.I do not do anything
- f. 6.I call or video-call friends and relatives
- g. 7. I read, cook or dedicate myself to other hobbies

3. Which are your emotions because of this situation?

Rate the intensity from 1 (minimum) to 7 (maximum)

- Anger
- Irritation
- Fear
- Anxiety
- Sadness
- Happiness
- Relaxation
- Indifference

4. Thinking at this moment, how much do you agree with the following statements:

(1. very much in agreement, 2. In agreement, 3. In disagreement, 4. Very much in disagreement)

1. I am agitated
2. I tend to avoid conflicts
3. I am good at solving the problems that arise in relation to the disease
4. I feel little monitored and accompanied by my oncologists
5. I feel poorly monitored and accompanied by my general practitioner
6. I am afraid for my health
7. I suffer this situation
8. I organize the time of my day
9. This situation also has positive aspects
10. People are more collaborative with each other

5. In this period you are satisfied with the communications you have / have had with your medical team (oncologist / oncological dh)

1. Very much 2. quite 3. little 4. not at all

6. Thinking about managing your disease right now how much you agree with the following statements:

(1. very much in agreement, 2. In agreement, 3. In disagreement, 4. Very much in disagreement)

- It would help me to communicate via email with my medical team
- It would help me to have a dedicated hotline
- It would help me to be able to communicate by chat (whatsapp, etc.)
- It would help me to be able to receive a remote cancer video consultation if necessary
- It would help me to be able to share side effects, clinical data, etc. through apps.

7. Have you been contacted by the hospital that is treating you?

1. Often 2. Occasionally 3. Never

(If they answer "Often" or "Occasionally" they proceed to 7.1 otherwise if I answer "No" it jumps to 8)

7.1. You have been contacted to: (Multiple answers are possible)

- 1. Reschedule an appointment
- 2. Submit reports
- 3. Refer any oncological problems

- 4. Check your general state of health at the moment (presence of flu symptoms, etc.)
- 99. Other\_\_\_\_\_

8. How did you communicate / manage any side effects of the therapy? (Multiple answers are possible)

- 1. I asked my family doctor
- 2. I'm writing them down in a notebook waiting to hear from my oncologist
- 3. I asked the pharmacist / general practitioner for suggestions on how to manage them
- 4. I went to my reference hospital
- 5. I asked help from patients associations
- 6. I searched information on the internet
- 7. I did not have any side effects
- 99. Other\_\_\_\_\_

9. What could help you to correctly follow a drug therapy? (Multiple answers are possible)

- 1. An app on a device (Smartphone, Tablet) that reminds me to take medicines at the right time
- 2. An app that summarizes all the drugs taken daily
- 3. An alarm
- 4. The collaboration of a family member or my caregiver
- 99. Other\_\_\_\_\_

10. How useful an app for the recognition of vital signs (pressure, fever, etc.) would have been in this moment of forced home permanence? (One reply only)

1. Very much 2. quite 3. little 4. Not at all

11. How are you managing your fears and anxieties? (Multiple answers are possible)

- 1. I make a call to a friend
- 2. I contact a patient in my same condition
- 3. Remote psychological support
- 4. I ask help from patients associations
- 5. I downloaded a dedicated app
- 6. I write on forums, facebook groups or similar
- 99. Other\_\_\_\_\_

12. Have you felt the need for nutritional advice / support?

1. Often 2. Occasionally 3. Never

12.1. To take care of your nutrition right now, how much would it help to:

1. Very much 2. quite 3. little 4. not at all

- Have an app where you can keep your own nutrition diary
- Get advice through an app from your medical team
- Being able to monitor changes in weight, lean mass and fat mass through an app
- Have a chat to ask the medical team questions

13. Are you doing physical activity?

1. every day 2. three days a week 3.occasionally 4. never

14. What helps you or would help you having regular physical activity at this time of lockdown?

1. Very much 2. quite 3. little 4.not at all

A tutorial on youtube

An online group meeting (zoom, meet, skype, etc.)

A dedicated app

Doing exercises by myself

15. Do you feel that your level of autonomy in managing the disease has increased in these days?

1. Very much 2. quite 3. little 4. not at all

16. Do you feel more confident, thanks to this experience, in the management of daily problems related to the disease?

1. Very much 2. quite 3. little 4.not at all

## 10.3. QUESTIONS FOR CLINICIAN’S INTERVIEW

---

Demographics – User profile

Gender

Age

Name of Center

Department

Occupation

Use of ICT in clinical practice (YES /NO)

Previous experience in tele monitoring system (YES/NO)

1. CAPABLE will implement clinical practice guidelines to support you in managing home-patients (implementing a GL means that you will receive automatically its recommendations, according to the data you entered for the specific patient). Guidelines may support you when patients come to the control visits or when data sent from home deserve attention.

Also the patient will receive indications that the guideline suggests for him, such as lifestyle advice, diet, etc. In this regard, the recommendations of the ESMO guidelines will be integrated with those of the AIMAC information booklets.

Which guidelines would you like CAPABLE to implement?

At the moment we have considered the following Guidelines. Please rate their importance, and eventually add other guidelines that you are using or that you think are important

	Source	Not important	important	very important	Are you already using it?

		For the physician	For the patient	For the physician	For the patient	For the physician	For the patient	
-Nausea/Vomiting	ESMO							
-Mucositis	ESMO							
-VTE	ESMO							
-Pregnancy	ESMO							
-Pain	ESMO							
-Infusion reaction	ESMO							
-Immunotherapy tox	ESMO							
- Febrile Neutropenia	ESMO							
- End of life	ESMO							
- Diarrhea	ESMO							
- Delirium	ESMO							
- CVD toxicity	ESMO							
- Constipation	ESMO							
-bone health	ESMO							
- anemia	ESMO							
Other....								

Can you indicate, for each guideline, which recommendations in particular should be implemented?

2. Which ones of the following intervention would you like to have in Capable:

- For you
  - Receive PROs
  - Receive alerts for particular conditions (e.g., symptoms indicating toxicity, patient not taking the medication)
  - Send messages to the patient/caregivers (e.g., to reinforce adherence to treatment)
  - Graphical visualization of patients' data (e.g., temporal trends)
  - See patients' statistics (e.g., more frequent symptoms)
- For the patients
  - Support to manage emotional distress (anxiety, depression)
  - Lifestyle change program to increase habits
  - Increase / control of physical activity
  - Improvement of sleep quality
  - Provide messages to promote positive thinking
  - Intervention to accept the reduced QoL / physical disabilities induced by the Cancer treatment
  - Intervention for pain management

- Intervention to promote adherence to treatment
- Educational material related to the condition
- Educational material related to treatments and side effects
- Other interventions (please describe)

3. Which metric or physiological data do you think are useful for monitoring your patients using a sensor?

	Not important	important	very important	would you like to see the temporal trend of this sensor data?	would you like to be alerted if any threshold is achieved?	If yes, when? (ex: in 1 hour, immediately, ...)
physical activity (steps, calories)						
sleep						
blood pressure						
temperature						
PPG						
ECG						
HR						
weight						
Air quality sensor						
other, please specify						

Which additional specific data would you like to collect, even without a sensor?

.....

4. Virtual capsules (positive thinking pills). This is a psychological intervention. E.g., the patient is invited by the app to do an activity like taking a picture of the sky, or the app shows an aphorism, and so on. The app could also collect pictures from different patients and show a collage (sort of "social functioning" or "reinforced positive thinking")

- Do you think this could be useful for cancer patients?
- How often could they be administered?
- Do you have suggestions about additional kinds of such capsules?

5. CAPABLE will implement prediction models (based on AI methodologies). Are you interested in knowing predictions from models?

- If yes, what prediction are you most interested in?

OUTCOME	Not important	important	Very important
Overall survival			



PFS			
ADE occurrence (e.g., drug toxicity)			
Psychological problems occurrence			
Others			

- To train those models the two hospitals involved in the project provided data about some hundreds of past patients. Would you be interested on statistics about those retrospective patients' data? (e.g. treatment outcomes, detection of subpopulations, toxicity, etc.)

6. Your patients ask you recommendations about:

	Rarely	sometime	often
Diet			
Physical activity			
Drug – food interaction			
Drug -drug interaction			
Adverse effects management (please report the different ADE below)			
Effect1:			
Effect2:			
...			
other			

7. Do you usually provide educational material to your patients?  
if yes, which material .....

8. Do the patient usually access to any type of psychological support service? Is this a resource connected to the health care center?

9. The patient (or a sensor) enters a new symptom (data) through his CAPABLE app: what would you like to happen?

**OPTION 1 (synchronous interaction)**

- 1.1 the doctor is notified immediately about the event
- 1.2 the doctor is notified immediately about the event only if it is severe

you prefer notification by
<ul style="list-style-type: none"> <li>• email</li> </ul>
<ul style="list-style-type: none"> <li>• sms</li> </ul>

- others ?

**OPTION 2 (asynchronous interaction)**

- the doctor is not notified immediately, but he checks the symptom through his system interface

**OPTION 3**

- None of the above, write your option: .....

**10. Access to your CAPABLE intervention**

- how often do you think you will be able to access your CAPABLE interface?
  - Every 15 days
  - Once a week
  - Once a day
  - More than once a day
  - Other.....
- Which is your preferred device
  - PC
  - Tablet
  - Mobile
  - Other.....
- In which environment do you think you will check the CAPABLE data
  - At the hospital
  - At home
  - Both
  - Other .....
- Do you think it's important CAPABLE will be accessible 24h?

**11. Do you see any risk with the CAPABLE concept?**

- to miss some patient's data
- to compromise the patient-physician relationship
- the doctor puts too much confidence in the app
- the patient puts too much confidence in the app
- the doctor puts too few confidence in the app
- the patient puts too few confidence in the app
- too many technical skills required to use it
- possible medicolegal implications
- Others .....

**12. TAM Questionnaire (Technology Assessment Model)****Perceived Usefulness**

- Using CAPABLE in my job would enable me to accomplish tasks more quickly.
- Using CAPABLE would improve my job performance.
- Using CAPABLE in my job would increase my productivity.
- Using CAPABLE would enhance my effectiveness on the job.
- Using CAPABLE would make it easier to do my job.
- I would find CAPABLE useful in my job.

13. DATA: do you think there are data in the information system of your hospital that CAPABLE could usefully integrate?

1. HER/EMR
2. LIS
3. RIS
4. Other

14. Do you think CAPABLE could decrease the healthcare costs, and if yes, which ones?

Patient's out-of-pocket costs

Hospital cost

Decrease rehospitalization

Decrease number of control visits

Decrease number of rescheduled visit / treatment due to patient complications /

ADE

Decrease unnecessary drug prescription or consumption

Others

.....

15. Do you think that CAPABLE could increase the efficiency of control visits? (e.g., shorter visits because CAPABLE allows you to continuously monitoring the patient between-visits, you will be provided with more efficient data visualization, etc.)

16. Do you think that CAPABLE could help you by reducing the patients' emails and phone calls for G1 and G2 adverse events?

17. Do you think that a system as Capable could help to improve the quality of the services for the patients?