

Inconsistency Solution of Maxwell's Equations

Solomon I. Khmelnik

Inconsistency Solution of Maxwell's Equations

2020

ID: y9jnvp
www.lulu.com

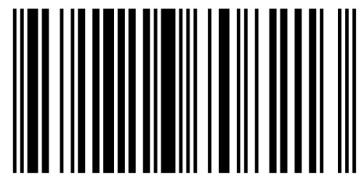

9781716708213

SOLOMON I. KHMELNIK

**INCONSISTENCY SOLUTION
OF MAXWELL'S EQUATIONS**

The 19th edition with additions

ISRAEL 2021

Previous Editions

First Editing – 22.07.2016
Second Editing – 02.09.2016
Third Editing – 22.07.2016
Fourth Editing – 08.11.2016
Fifth Editing – 20.03.2017
Sixth Editing – 27.07.2017
Seventh Edition - 04.09.2017
Eighth Edition, amended and updated - 21.08.2018
Ninth Edition, amended and updated - 13.11.2018
Tenth Edition, amended and updated - 13.02.2019
Eleventh Edition, amended - 18.03.2019
Twelfth Edition, amended - 18.04.2019
Thirteenth Edition, amended - 24.06.2019
14th edition with additions - 10.09.2019
15th edition with additions - 17.11.2019
16th edition with additions - 27.07.2020
17th edition with additions - 20.01.2021
18th edition with additions - 05.03.2021

Copyright © 2016 by Solomon I. Khmelnik

<https://orcid.org/0000-0002-1493-6630>

All right reserved. No portion of this book may be reproduced or transmitted in any form or by any means, electronic or mechanical, without written permission of the author.

Published by "MiC" - Mathematics in Computer Comp.

BOX 15302, Bene-Ayish, Israel, 0060860

E-mail: solik@netvision.net.il

Printed in United States of America, Lulu Inc.,

ID y9jnvp

ISBN 978-1-71670-821-3

Art Editor - L.M. Gelfand

Annotation

A new solution of Maxwell's equations for a vacuum, for wire with constant and alternating current, for the capacitor, for the sphere, etc. is presented. First, it must be noted that the proof of the solution's uniqueness is based on the Law of energy conservation that is not observed (for instantaneous values) in the known solution. The solution offered:

- Complies with the energy conservation law in each moment of time, i.e. sets constant density of electromagnetic energy flux;
- Reveals phase shifting between electrical and magnetic fields' strengths;
- Explains existence of energy flux along the wire that is equal to the power consumed.

A detailed proof is given for the reader who has an interest in the problem.

Experimental proofs of the theory are considered.

Explanation is proposed for the experiments that have not yet been explained.

The work offers some technical applications of the solution obtained.

Contents

Chapter	Name	Page
0	Preface	0-1
1	The Solution of Maxwell's Equations for a Vacuum in a Cylindrical Coordinate System	1-1
1a	Plane Wave	1a-1
1b	The second solution of Maxwell's equations for vacuum in a rectangular coordinate system	1b-1
1z	The solution of Maxwell's equations for a cylindrical wave in vacuum	1z -1
2	Solution of Maxwell's Equations for Electromagnetic Wave in the Dielectric Circuit of Alternating Current in cylindrical coordinates	2-1
2a	Solution of the Maxwell Equations for a Capacitor with Alternating Voltage in Cylindrical Coordinates	2a-1
2d	Solution of Maxwell's Equations for a Cylindrical Capacitor with Alternating Voltage in Cartesian Coordinates	2d-1
2h	Solution of Maxwell's Equations for Conductive dielectric in Cylindrical Coordinates	2h -1
2p	Solving Maxwell's Equations for AC Wire	2p -1
2s	Solving Maxwell's Equations for an AC Solenoid	2s -1
3	Solution of Maxwell's Equations for an Alternating Current Magnetic Circuit	3-1
4c	Special Transformers	4c-1
5	Solution of Maxwell's Equations for Wire with Constant Current	5-1
5a	Milroy Engine	5a-1
5c	Magneto-resistance	5c-1
5d	The Solution of Maxwell's equations for a wire with a constant current in a magnetic field	5d-1
5h	The Solution of Maxwell's Equations for a Rotating Ferromagnetic Wire	5h-1
5m	Refine Bio-Savar-Laplace law	5m -1
5z	Algorithms for solving Maxwell's equations for a DC wire	5z-1
7	Solution of Maxwell's Equations for Conductive Alternating Current Capacitor in Cylindrical	7-1

	Coordinates. The Nature of the Potential Energy of a Capacitor	
7a	Electrically Conductive Dielectric Capacitor	7a-1
7b	Maxwell's Equations for the Neighborhood of a Magnet End	7b-1
7e	The Solution of Maxwell's Equations for a Constant Voltage Capacitor in Cartesian Coordinates	7e-1
8	Solution of Maxwell's Equations for Spherical Coordinates	8-1
8A	Solution of Maxwell's Equations for Spherical Coordinates. Solution variant A	8A-1
8B	Solution of Maxwell's Equations for Spherical Coordinates. Solution variant B	8B-1
8C	Solution of Maxwell's Equations for Spherical Coordinates. Solution variant C.	8C-1
8H	Spherical Capacitor of AC	8H-1
8K	Spherical DC Capacitor	8K-1
8N	A New Approach to Antenna Design	8N-1
9	The Nature of Earth's Magnetism	9-1
10	Solution of Maxwell's Equations for Ball Lightning	10-1
11	Mathematical Model of a Plasma Crystal	11-1
12	Work of Lorentz Force	12-1
13	Electromagnetic Momentum and Unsupported Movement	13-1
13a	Unsupported Motion Without Violating the Laws of Physics	13a-1
13b	The Flow of Energy and the Pulse of a Static Electromagnetic Field	13b-1
13d	Flying Triangles	13d-1
14	The Structure of the Electromagnetic Field in the Body of a Permanent Magnet	14-1
15	Fourth Electromagnetic Induction	15-1
16	Electromagnetic Keeper of Energy and Information	16-1
16a	To the Question of Intranuclear Forces	16a-1
16b	On the Interaction of Nanoparticles	16b -1
16c	Information Transfer in Biological Systems by Water and Air	16c-1
16d	To the Rationale for Homeopathy	16d -1
17	The Reversibility of Unipolar Induction	17-1
18	The Forces of Lorentz, Ampere, and Khmelnik	18-1

97	Solution of Maxwell's equations for vacuum in cylindrical coordinates	97-1
99	References	99-1

The themes of the chapters are listed in the following table:

Coordinates:	Rectangular		Cylindrical		Spherical	
	AC	DC	AC	DC	AC	DC
Alternating current (AC) or direct current (DC):						
Vacuum	1b		1		8, 8A, 8B,8C	
Vacuum plane wave			1a			
Dielectric circuit			2			
Capacitor	2d	7e	2a	7	8H	
Conductive capacitor			2h	7a		
The wire			2p	5, 5z, 5m		
Magnetic wire				5A		
Wire pipe			4b			
Rotating wire				5a		
Ferromagnetic rotating wire				5h		
Соленоид			2s			
Antennas					8N	
Ball lightning					10	
Special transformers			4c			
Magnetic circuit				3		
Reluctance				5c		
Magnet clearance				7b		
Permanent magnet				14		
Plasma				11		
Electromagnetic momentum	13, 13a, 13b, 13d					
The power of Lorentz	12					
Three forces	18					
Unipolar induction	17					
4th induction	15					
Keepers of energy and information	16, 16b, 16c,16d					
Intranuclear forces	16a					

Chapter 0. Preface

Contents

1. Introduction \ 1
2. On Energy Flux in Wire \ 4
3. Requirements for Consistent Solution of Maxwell's Equations \ 5
4. Three solutions of the Maxwell equations \ 6
5. Lyrical digression \ 7
6. Variants of Maxwell's Equations \ 8
- Appendix 0. Cartesian Coordinates \ 10
- Appendix 1. Cylindrical Coordinates \ 11
- Appendix 2. Spherical Coordinates \ 12
- Appendix 3. Some Correlations Between GHS and SI Systems \ 13
- Appendix 4. Known solution of Maxwell's equations for electromagnetic fields in a vacuum \ 14
- Appendix 5. On the conservation of energy in the electromagnetic wave \ 16
- Appendix 6. The list of some theoretical predictions confirmed experimentally \ 19

1. Introduction

Maxwell's set of equations is one of the greatest discoveries of the human mind. At the same time, the known solutions of this set of equations have a number of disadvantages. Suffice it to say that these solutions do not satisfy the law of conservation of energy (see Appendix 5). Such solutions allow some authors to doubt the reliability of the Maxwell equations themselves. We emphasize, however, that **these dubious results follow only from a known decision**. However, the solution of Maxwell's equations can be different (as a rule, partial differential equations have several solutions.) Obviously, it is necessary to find a solution that does not contradict the physical laws and empirically established facts.

The author has found a new solution to the Maxwell set of equations that is free from the indicated disadvantages. This solution is found for the Maxwell equations written in the coordinate-by-coordinate form and cannot be obtained in a vector form from Maxwell's equations

written in the vector form. Apparently, this was the reason that the proposed solution has not yet been received.

Based on the new solution of Maxwell's equations, the spiral structure of electromagnetic waves and stationary electromagnetic fields was theoretically predicted and experimentally confirmed. It was also shown that spiral structures exist in all waves and technical devices without exception. The spiral nature of the structures is expressed in the fact that the coordinate-by-coordinate forms of the strengths of the electric and magnetic fields and waves vary like sinusoidal functions in dependence on the space coordinates and time (for waves).

Below the theoretical predictions are justified by the fact that these functions are such that they

- do not contradict the law of conservation of energy **at each moment in time** (but not on average) i.e. establish the constancy of the flux density of electromagnetic energy in time (chapter 1.4),
- reveal a phase shift between the strengths of the electrical and magnetic fields not only in technical devices but also in waves (chapter 1.3),
- explain the existence of a flow of energy along and **inside** (but not outside) the wire, equal to the power consumption (chapter 5),
- explain the light curl, i.e. the appearance of the orbital angular momentum, at which the flow of energy not only flies forward but also turns around the axis of motion (chapter 5).

Appendix 6 lists some theoretical predictions obtained in this book and confirmed by experimental observations and (or) explanations of experiments that have not yet been substantiated:

“Up to today, no effect was revealed that would require a modification of Maxwell’s equations” [36]. Nevertheless, recent criticism of validity of the Maxwell equations is heard from all sides. Have a look at Figure 1 that shows an electromagnetic wave being a known solution of Maxwell’s equations. The confidence of critics of Maxwell’s equations is created first of all by the violation of the Law of energy conservation in such wave. And certainly "*the density of electromagnetic energy flow (the absolute value of the Umov-Poynting vector) pulsates with a harmonic law. Doesn't it violate the Law of energy conservation?*" [1]. Certainly, this Law is violated, **if** the

electromagnetic wave satisfies the **known solution** of the Maxwell equations. However, there is no other solution: "*The proof of solution's uniqueness in general is as follows. If there are two different solutions, then their difference due to the system's linearity will also be a solution. This is true for zero charges and currents along with zero initial and boundary conditions. Here from, using the expression for electromagnetic field energy we must conclude that the difference between solutions is equal to zero. This means that the solutions are identical. Thus, the uniqueness of the Maxwell equations' solution is proved*" [2]. So, the uniqueness of solution is being proved on the base of using the law that is violated in this solution.

Another result following from the existing solution of the Maxwell equations is common-mode oscillations of mutually perpendicular vectors of electric and magnetic field strengths in an electromagnetic wave. This is shown in Figure 1. However, this contradicts with the idea of noninterrupting transformation of electrical and magnetic components of energy during propagation of an electromagnetic wave. In [1], for instance, this fact relates to "one of the vices of the classical electrodynamics".



Рис. 1.

Such results following from the known solution of the Maxwell equations allow doubting the authenticity of the Maxwell equations. However, we must stress that these doubting results follow **only from the found solution**. But this solution, as has been stated above, can be different: partial derivatives' equations can generally have several solutions.

For convenience of the reader, Appendix 4 introduces the method of obtaining of a known solution. Further we shall deduct **another solution** of the Maxwell equation, in which the density of electromagnetic energy flow remains constant in time, and the

components of the strengths of the electrical and magnetic fields in the electromagnetic wave are shifted in the phase.

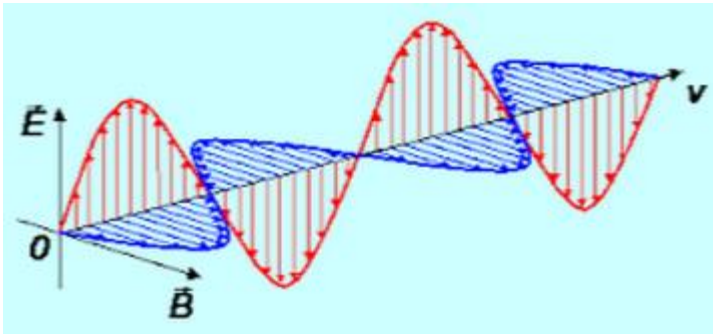
At last, the existing solution contradicts the existence of the phenomenon called the twisted light [65].

2. On Energy Flux in a Wire

Now, refer to energy flux in a wire. The existing idea of energy transfer through the wires is that the energy in a certain way is spreading outside the wire [13]: *"... so our "crazy" theory says that the electrons are getting their energies wasted by them for creation of heat outside, from the energy flow of an external field towards inside the wire. Intuition would seem to tell us that the electrons get their energy from being pushed along the wire. So, the energy as though should be flowing down (or up) along the wire. However, the theory says that in reality electrons are under action of an electric field created by very far electric charges. As a result, the electrons lose their energy wasted for heat just from these fields. The energy of remote electric charges somehow assimilates within a wide area of space and then flows in inside the wire."*

Such theory contradicts the Law of energy conservation. Indeed, the energy flow travelling in the space must lose some part of its energy. However, this fact was found neither experimentally nor theoretically. It is most important that this theory contradicts the following experiment. Let's assume that direct current (DC) runs through the central wire of a coaxial cable. This wire is isolated from the external energy flow. Then whence the energy flow compensating the heat losses in the wire comes? With the exception of loss in wire, this flux from outside should penetrate into a load, e.g. winding of electrical motors covered with steel shrouds of the stator. This matter is omitted in the discussions of the existing theory.

So, the existing theory claims that the incoming (perpendicularly to the wire) electromagnetic flow permits the current to overcome the resistance to movement and performs work that turns into heat. This known conclusion veils the natural question: how can the current attract the flow, if the current appears due to the flow? It is natural to assume that the flow creates a certain electromotive force (EMF) that "moves the current". Meanwhile, energy flux of the electromagnetic wave exists in the wave itself and does not use space exterior towards the wave.

Solution of Maxwell's equations should model such structure of the electromagnetic wave, in which a flow of the electromagnetic energy is present.

The intuition, about which Feynman speaks, does not fraud us. The author proves this statement below not exceeding the frameworks of Maxwell's equations.

3. Requirements for Consistent Solution of Maxwell's Equations

Thus, the solution of Maxwell's equations must:

- describe an electromagnetic wave in both a vacuum and a wire;
- comply with the energy conservation law in each moment of time, i.e. set constancy of density of electromagnetic energy flux in time;
- reveal a phase shifting between strengths of the electrical and magnetic fields;
- explain existence of energy flux along the wire that is equal to power consumed.

Such solution of Maxwell's equations satisfying the aforementioned requirements is deduced below.

4. Three solutions of the Maxwell equations

We call the well-known solution of Maxwell's equations the **first solution**. It was shown above that it does not satisfy the law of conservation of energy and is therefore physically unacceptable. We also note that this first solution is **applicable only in the Cartesian coordinates**.

In Chapter 1 and below, a **second solution** of the Maxwell equations is proposed and considered, which satisfies the energy conservation law. This solution is considered **in the cylindrical coordinates** but can be transformed for the Cartesian coordinates.

Chapters 2d, 16, and 16a show that there is a **third solution** to Maxwell's equations, which also satisfies the energy conservation law. This solution is considered **in the Cartesian coordinates** but can be converted for the cylindrical coordinates. However, for static fields, such a transformation is only possible formally and leads to a violation of the law of conservation of energy. The third solution describes such electromagnetic waves that exist in a limited volume. There are energy flows in this volume but the total energy stored in the volume does not change. Such wave can be called a **voluminous standing wave**.

So, for electromagnetic waves there are (at least) three solutions. This is natural for partial differential equations. Until now, it has been customary to say that the first solution is the only one because it satisfies

the law of conservation of energy. But the first solution does not satisfy just this law. Now we see that for physically acceptable solutions there can be at least two solutions. Which one nature chooses depends on the initial conditions.

“Why these solutions have not been proposed so far!” – some readers of the previous versions of this book ask me.

The set of Maxwell equations in a compact form contains 4 **first-order** partial differential equations, see in Appendix 5. Such a set of equations can have **many solutions**. To solve this set of equations, one has to convert them into **two second-order** equations. Moreover, the set of solutions decreases: the solution existing for the first-order equations may **not** be a solution for the second-order equations. This happened in our case.

“But a solution has been found, and what is the use of this reasoning?” - the same readers ask me.

The solution obtained is not acceptable for physics, since it violates the law of conservation of energy. This follows directly from the solution, see in Appendix 5. In addition, any phase inversion of the electric and magnetic fields is not observed. Therefore, it is necessary to look for another solution, from **mathematically possible** ones.

“Has anyone seen this before you?” - they also ask ...

Many have seen. In response, the apologists for the solution found answered that, **on average**, the energy conservation law is observed, and there can be no other solution because the law of conservation of energy is respected. Note two points in this answer: 1) the absence of another solution is proved by a physical argument; 2) the indication "on average" is ignored. So, the author has the right to argue that another solution is possible mathematically and must be sought.

“Why not looked for?” - they ask ...

There were those who saw this as evidence of the illegality of Maxwell's equations.

There were those who agreed with this, and perhaps were looking. However, it is impossible to find another solution in the abbreviated form of the equations (I think).

There were those who disagreed, saying that it would do. Indeed, the solution is widely applied in practice, and very beautiful. I agree with the latter. However, on the issue of the applicability of the existing solution, I have to note the following. It is shown below that 1) very often an abbreviated set of equations is used to resolve and the resulting solution has a number of disadvantages that affect the quality of the

designed equipment; 2) many consequences of Maxwell's equations were not noticed and are not used in technology.

“And how was You able to resolve?” - they ask ...

An abbreviated form of Maxwell's equations can be represented as eight partial differential equations of the first order. The scope for finding solutions is expanding. But it took me a few years ...

5. Lyrical digression

The reader, who will read this book further, will see many solutions to Maxwell's equations for various cases. After found solution, physical interpretations follow. When writing this book, it happened just like this: I followed the found solution with eyes bulging from surprise. Sometimes obvious interpretations appeared, sometimes interpretations came up that I did not know about (I do not have a regular physical education.) Then I browsed in the Internet and found out that (yes!) such a thing had already been discovered by physicists and at the same time sometimes had no formal explanation. Sometimes the interpretation was formulated as a hypothetical experiment. I climbed onto the Internet again and found that (yes!) such an experiment has been described, didn't theoretically explain, and causes controversy ... Sometimes such an experiment was not found: this looks like a patent application. In general, everything was approximate as Stanislaw Lem told:

All novels like “Solaris” are written in the same way, which I myself can't explain ... I can still show those places in “Solaris” or “Return from the Stars”, where during the writing I was essentially in the role of the reader. When Kelvin arrives at Solaris station and does not meet anyone there, when he goes in search of someone from the station personnel and meets Snaut, who is obviously afraid of him, I had no idea why no one had met the messenger from the Earth and what he was so afraid of Snaut. Yes, I definitely did not know anything about some kind of "living Ocean" covering the planet. All this was revealed to me later, just like the reader during reading, with the only difference being that only I myself could put everything in order.

Exactly the same thing happened with Maxwell's equations for gravity [180].

6. Variants of Maxwell's Equations

Further, we separate different special cases (alternatives) of Maxwell's equations system numbered for convenience of presentation.

Variant 1.

Maxwell's equations in the general case in the GHS system are of the form [3]:

$$\text{rot}(E) + \frac{\mu}{c} \frac{\partial H}{\partial t} = 0, \quad (1)$$

$$\text{rot}(H) - \frac{\varepsilon}{c} \frac{\partial E}{\partial t} - \frac{4\pi}{c} I = 0, \quad (2)$$

$$\text{div}(E) = 0, \quad (3)$$

$$\text{div}(H) = 0, \quad (4)$$

$$I = \sigma E, \quad (5)$$

where

I, H, E are the conduction current, magnetic and electric fields' strengths, respectively,

ε, μ, σ are the dielectric constant, magnetic permeability, and conductivity wire of the medium.

Variant 2.

For a vacuum it must be taken that $\varepsilon = 1, \mu = 1, \sigma = 0$. When the set of equations (1)-(5) takes the following form:

$$\text{rot}(E) + \frac{1}{c} \frac{\partial H}{\partial t} = 0, \quad (6)$$

$$\text{rot}(H) - \frac{1}{c} \frac{\partial E}{\partial t} = 0, \quad (7)$$

$$\text{div}(E) = 0, \quad (8)$$

$$\text{div}(H) = 0. \quad (9)$$

The solution to this equations' set is offered in Chapter 1.

Variant 3.

Consider the case 1 in the complex presentation:

$$\text{rot}(E) + i\omega \frac{\mu}{c} H = 0, \quad (10)$$

$$\text{rot}(H) - i\omega \frac{\varepsilon}{c} E - \frac{4\pi}{c} (\text{real}(I) + i \cdot \text{imag}(I)) = 0, \quad (11)$$

$$\text{div}(E) = 0, \quad (12)$$

$$\text{div}(H) = 0, \quad (13)$$

$$\text{real}(I) = \sigma \cdot \text{abs}(E). \quad (14)$$

It should be noted that instead of showing the whole current, equation (14) shows only its real component, i.e. the conductivity current.

Variant 4.

For the wire with *sinusoidal current* I flowing out of an external source, $\text{real}(I)$ may at times be excluded from equations (11-14). It is possible for a low-resistance wire and for a dielectric wire (for more details, refer to Chapter 2). As this takes place, the system (11-14) takes the form of

$$\text{rot}(E) + \frac{\mu}{c} \frac{\partial H}{\partial t} = 0, \quad (15)$$

$$\text{rot}(H) - \frac{\varepsilon}{c} \frac{\partial E}{\partial t} - \frac{4\pi}{c} I = 0, \quad (16)$$

$$\text{div}(E) = 0, \quad (17)$$

$$\text{div}(H) = 0. \quad (18)$$

The solution for this system will be considered in the **Chapter 2**.

Variant 5.

For a constant current wire, the equations' set in **Variant 1** simplifies due to the lack of time derivative and takes the following form:

$$\text{rot}(E) = 0, \quad (21)$$

$$\text{rot}(H) - \frac{4\pi}{c} I = 0, \quad (22)$$

$$\text{div}(E) = 0, \quad (24)$$

$$\text{div}(H) = 0, \quad (25)$$

$$I = \sigma E \quad (26)$$

or

Variant 6.

$$\text{rot}(I) = 0, \quad (27)$$

$$\text{rot}(H) - \frac{4\pi}{c} I = 0, \quad (28)$$

$$\text{div}(I) = 0, \quad (29)$$

$$\text{div}(H) = 0. \quad (30)$$

The solution for this set will be considered in Chapter 5.

We will be searching for suitable monochromatic solutions of the aforementioned sets of equations in **Variants 1 to 6**. A transition to polychromatic solution can be accomplished via Fourier transformation.

Appendix 0. Cartesian Coordinates

As it is known in book [4], in Cartesian coordinates x, y, z , scalar divergence of the \mathbf{H} vector, vector gradient of scalar function $a(x, y, z)$, vector rotor of the \mathbf{H} vector, accordingly, take the following forms:

$$\operatorname{div}(\mathbf{H}) = \left(\frac{\partial H_x}{\partial x} + \frac{\partial H_y}{\partial y} + \frac{\partial H_z}{\partial z} \right),$$

$$\operatorname{grad}(a) = \left[\frac{\partial a}{\partial x}, \frac{\partial a}{\partial y}, \frac{\partial a}{\partial z} \right],$$

$$\operatorname{rot}(\mathbf{H}) = \left(\left(\frac{\partial H_z}{\partial y} - \frac{\partial H_y}{\partial z} \right), \left(\frac{\partial H_x}{\partial z} - \frac{\partial H_z}{\partial x} \right), \left(\frac{\partial H_y}{\partial x} - \frac{\partial H_x}{\partial y} \right) \right).$$

The components of the electric and magnetic fields' strengths in Cartesian coordinates, obtained as a result of this decision, are shown in the following figure.

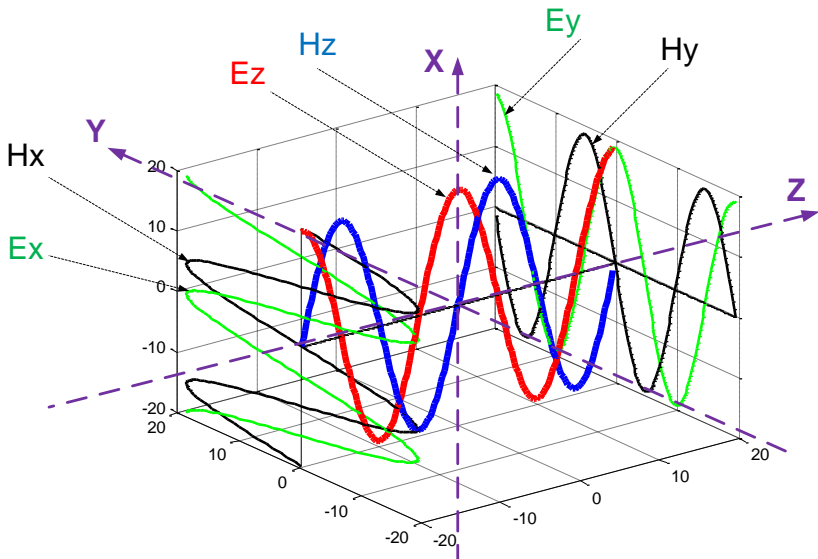

Appendix 1. Cylindrical Coordinates

As it is known in book [4], in the cylindrical coordinates \mathbf{r}, φ, z , scalar divergence of the \mathbf{H} vector, vector gradient of scalar function $a(\mathbf{r}, \varphi, z)$, vector rotor of the \mathbf{H} vector, accordingly, take the form of

$$\operatorname{div}(H) = \left(\frac{H_r}{r} + \frac{\partial H_r}{\partial r} + \frac{1}{r} \cdot \frac{\partial H_\varphi}{\partial \varphi} + \frac{\partial H_z}{\partial z} \right), \quad (\text{a})$$

$$\operatorname{grad}_r(a) = \frac{\partial a}{\partial r}, \quad \operatorname{grad}_\varphi(a) = \frac{1}{r} \cdot \frac{\partial a}{\partial \varphi}, \quad \operatorname{grad}_z(a) = \frac{\partial a}{\partial z}, \quad (\text{b})$$

$$\operatorname{rot}_r(H) = \left(\frac{1}{r} \cdot \frac{\partial H_z}{\partial \varphi} - \frac{\partial H_\varphi}{\partial z} \right), \quad (\text{c})$$

$$\operatorname{rot}_\varphi(H) = \left(\frac{\partial H_r}{\partial z} - \frac{\partial H_z}{\partial r} \right), \quad (\text{d})$$

$$\operatorname{rot}_z(H) = \left(\frac{H_\varphi}{r} + \frac{\partial H_\varphi}{\partial r} - \frac{1}{r} \cdot \frac{\partial H_r}{\partial \varphi} \right). \quad (\text{e})$$

Appendix 2. Spherical Coordinates

Figure 1 shows the system of the spherical coordinates ρ, θ, φ , and Table 1 contains expressions for rotor and divergence of the vector \mathbf{E} in these coordinates [4].

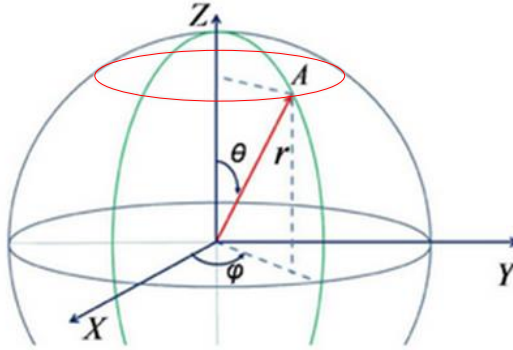

Fig. 1.

Table 1.

1	2	3
1	$\operatorname{rot}_\rho(E)$	$\frac{E_\varphi}{\rho \operatorname{tg}(\theta)} + \frac{\partial E_\varphi}{\rho \partial \theta} - \frac{\partial E_\theta}{\rho \sin(\theta) \partial \varphi}$
2	$\operatorname{rot}_\theta(E)$	$\frac{\partial E_\rho}{\rho \sin(\theta) \partial \varphi} - \frac{E_\varphi}{\rho} - \frac{\partial E_\varphi}{\partial \rho}$

3	$\text{rot}_\varphi(E)$	$\frac{E_\theta}{\rho} + \frac{\partial E_\theta}{\partial \rho} - \frac{\partial E_\rho}{\rho \partial \varphi}$
4	$\text{div}(E)$	$\frac{E_\rho}{\rho} + \frac{\partial E_\rho}{\partial \rho} + \frac{E_\theta}{\rho g(\theta)} + \frac{\partial E_\theta}{\rho \partial \theta} + \frac{\partial E_\varphi}{\rho \sin(\theta) \partial \varphi}$

Appendix 3. Some Correlations Between GHS and SI Systems

Further, formulas appear in the GHS system, yet, for illustration, some examples are shown in the SI system. This is why, for reader's convenience, Table 1 contains correlations between some measurement units of these systems.

Table 1.

Name	GHS	SI
electric current	1 GHS	$3.33 \cdot 10^{-10}$ A
voltage	1 GHS	$3 \cdot 10^2$ V
power, energy flux density	1 GHS	10^{-7} Wt
energy flux density per unit length of wire	1 GHS	10^{-5} Wt/m
electric current density	1 GHS	$3.33 \cdot 10^{-6}$ A/m ² $3.33 \cdot 10^{-12}$ A/mm ²
electric field strength	1 GHS	$3 \cdot 10^4$ V/m
magnetic field strength	1 GHS	80 A/m
magnetic induction	1 GHS	10^{-4} T
absolute dielectric permittivity	1 GHS	$8.85 \cdot 10^{-12}$ F/m
absolute magnetic permeability	1 GHS	$1.26 \cdot 10^{-8}$ H/m
capacitance	1 GHS	$1.1 \cdot 10^{-12}$ F
inductance	1 GHS	10^{-9} H
electrical resistance	1 GHS	$9 \cdot 10^{11}$ Om
electrical conductivity	1 GHS	$1.1 \cdot 10^{-12}$ sm
specific electrical resistance	1 GHS	$9 \cdot 10^9$ Om·m
specific electrical conductivity	1 GHS	$1.1 \cdot 10^{-10}$ sm/m

Appendix 4. Known solution of Maxwell's equations for electromagnetic fields in a vacuum

Let us consider a set of Maxwell's equations for a vacuum stated before in Section 4:

$$\text{rot}(E) = -\frac{1}{c} \frac{\partial H}{\partial t}, \quad (1)$$

$$\text{rot}(H) = \frac{1}{c} \frac{\partial E}{\partial t}, \quad (2)$$

$$\text{div}(E) = 0, \quad (3)$$

$$\text{div}(H) = 0. \quad (4)$$

Taking a curl from each part of equation (1), we obtain:

$$\text{rot}(\text{rot}(E)) = \text{rot}\left(-\frac{1}{c} \frac{\partial H}{\partial t}\right) \quad (5)$$

or

$$\text{rot}(\text{rot}(E)) = -\frac{1}{c} \cdot \frac{\partial}{\partial t} (\text{rot}(H)). \quad (6)$$

Having combined equations (2) and (6), we find out that

$$\text{rot}(\text{rot}(E)) = -\frac{1}{c^2} \cdot \frac{\partial^2}{\partial t^2} (E). \quad (6a)$$

It is stated in [4, p.131] that

$$\text{rot}(\text{rot}(E)) = \text{grad}(\text{div}(E)) - \Delta E. \quad (7)$$

where the orthogonal coordinates show that

$$\Delta E = \frac{\partial^2 E}{\partial x^2} + \frac{\partial^2 E}{\partial y^2} + \frac{\partial^2 E}{\partial z^2}. \quad (8)$$

With equations (3) and (7), we find that

$$\text{rot}(\text{rot}(E)) = -\Delta E. \quad (9)$$

Having combined equations (6a), (8), (9), we find out that

$$\frac{1}{c^2} \cdot \frac{\partial^2 E}{\partial t^2} = \frac{\partial^2 E}{\partial x^2} + \frac{\partial^2 E}{\partial y^2} + \frac{\partial^2 E}{\partial z^2}. \quad (10)$$

This equation has a complex solution in the orthogonal coordinates of the following form:

$$E(t, x, y, z) = |E| e^{(k_x x + k_y y + k_z z - \omega t + \phi_0)}, \quad (11)$$

which can be verified by direct substitutions. For this purpose, the first and second derivatives of (10) are pre-calculated. Constants

$(|E|, k_x, k_y, k_z, \omega, \phi_o)$ have a certain physical significance (which will be not discussed here).

The obtained solution is complex. It is known that the real part of any complex solution is also a solution. Consequently, the following solution can be chosen instead of complex solution (11):

$$E(t, x, y, z) = |E| \cos(k_x x + k_y y + k_z z - \omega t + \phi_o), \quad (12)$$

Similarly, we can obtain a solution in the following form:

$$H(t, x, y, z) = |H| \cos(k_x x + k_y y + k_z z - \omega t + \phi_o). \quad (13)$$

It should be stated that energy is calculated as an integral as follows:

$$\begin{aligned} W &= \int_t \left(\frac{\varepsilon E^2}{2} + \frac{\mu H^2}{2} \right) dt = \frac{1}{2} \int_t \left(\varepsilon (|E| \cos(\dots \omega t))^2 + \mu (|E| \cos(\dots \omega t))^2 \right) dt \\ &= \frac{1}{2} (\varepsilon (|E|)^2 + \mu (|E|)^2) \int_t (\cos^2(\dots \omega t)) dt = \\ &= \frac{1}{8\omega} (\varepsilon (|E|)^2 + \mu (|E|)^2) \Big|_0^t \sin(\dots 2\omega t), \quad (14) \end{aligned}$$

With equations (12), (13), and (14), it can be clearly stated that:

1. the energy transforms in time, which contradicts the law of energy conservation,
2. vorticities E and H are cophased, which contradicts electrical engineering.

This known solution is the solution to the wave equation. Consequently, the wave equation in electrodynamics does NOT satisfy the energy conservation law. However, this fact is well known: the wave equation satisfies the law of conservation of energy on average, which, in principle, cannot be considered compliance with the conservation law.

A huge number of theoretical conclusions in electrodynamics are made based on the use of the wave equation. These conclusions were obtained in violation of the law of conservation of energy and had to put up with it. Now that the exact solution to Maxwell's equations has been found, it is necessary to revise and refine the previously obtained results. This is necessary because some of the results may turn out to be fundamentally incorrect (and not just erroneous with some error).

Appendix 5. On the conservation of energy in the electromagnetic wave

Here we consider in detail the issue of energy conservation in an electromagnetic wave. The following reasoning must be given here,

despite their simplicity, since in further conclusions, they are of fundamental importance.

1. Running electromagnetic wave

In a traveling electromagnetic wave, the moduli of the magnetic induction B and the electric field strength E at each point in space are related by the following relation:

$$B = E\sqrt{\varepsilon\mu}/c, \quad (1a)$$

where c is the speed of light in a vacuum, $c = 1/\sqrt{\varepsilon_0\mu_0}$. The bulk density of electrical energy is

$$w_e = \frac{\varepsilon\varepsilon_0 E^2}{2}. \quad (1b)$$

The bulk density of the magnetic energy is

$$w_m = \frac{B^2}{2\mu\mu_0} \quad (2)$$

We substitute (1a) into (2) and obtain (1c). Consequently

$$w_e = w_m \quad (3)$$

Thus, in the traveling electromagnetic wave, mutual transformations of the electric and magnetic energy occur. As a result, the bulk density of electromagnetic energy can be calculated with the following formula:

$$w = w_e + w_m = \frac{\varepsilon\varepsilon_0 E^2}{2} + \frac{B^2}{2\mu\mu_0} \quad (4)$$

The sinusoidal traveling electromagnetic wave in the simplest case is described by the following formulas:

$$E = E_o \cos(\omega t - kz), \quad (5)$$

$$B = B_o \cos(\omega t - kz), \quad (6)$$

where E_o, B_o are the amplitudes of oscillations of the electric and magnetic parameters, respectively.

Substituting equations (5) and (6) into (4), we obtain

$$w = \left(\frac{\varepsilon\varepsilon_0 E_o^2}{2} + \frac{B_o^2}{2\mu\mu_0} \right) \text{Cos}^2(\omega t - kz) \quad (7)$$

From (7) it follows that at any point and **in any volume** the electromagnetic energy varies in time from zero to a certain maximum. This is clearly **contrary** to the law of conservation of energy.

2. Standing electromagnetic wave

The standing sinusoidal electromagnetic wave is described by the formulas

$$E = E_o \text{Sin}(kz) \text{Sin}(\omega t), \quad (8)$$

$$B = B_o \text{Cos}(kz) \text{Cos}(\omega t). \quad (9)$$

In this wave, the strength at all points changes in time with the same frequency and in one phase, and the amplitude in it varies according to the harmonic law depending on the z coordinate.

From formulas (8) and (9) it can be seen that the vibrations of E and B are shifted in phase by a quarter of the period. This means that when the electric field strength reaches a maximum, the B values are equal to zero.

The energy flux density of electromagnetic waves is determined by the Poynting vector. Since at the nodes the values of E or B are equal to zero, the flow at these points is equal to zero. The nodes for E coincide with the antinodes for B and vice versa. This means that through the nodes and antinodes there is no flow of electromagnetic energy. However, since E and B at other points change over time, it can be concluded that over time, energy moves between neighboring nodes and antinodes. When this happens, the energy of the electric field is converted into the energy of a magnetic field and vice versa. The total energy enclosed between two adjacent nodes and the antinodes remains constant.

Consider this question in more detail. From (4), (8), and (9), it follows that

$$w = w_e + w_m = \left\{ \begin{array}{l} \frac{\epsilon \epsilon_o E_o^2}{2} \text{Sin}^2(kz) \text{Sin}^2(\omega t) \\ + \frac{B_o^2}{2\mu\mu_o} \text{Cos}^2(kz) \text{Cos}^2(\omega t) \end{array} \right\} \quad (10)$$

Find the energy enclosed between two neighboring nodes and antinodes:

$$w_1 = \int_{z=0}^{z=\frac{\pi}{2k}} \left\{ \begin{array}{l} \frac{\epsilon \epsilon_o E_o^2}{2} \text{Sin}^2(kz) \text{Sin}^2(\omega t) \\ + \frac{B_o^2}{2\mu\mu_o} \text{Cos}^2(kz) \text{Cos}^2(\omega t) \end{array} \right\} dz$$

or

$$w_1 = \left\{ \begin{array}{l} \text{Sin}^2(\omega t) \cdot \int_{z=0}^{z=\frac{\pi}{2k}} \left\{ \frac{\varepsilon\varepsilon_o E_o^2}{2} \text{Sin}^2(kz) \right\} dz \\ + \text{Cos}^2(\omega t) \cdot \int_{z=0}^{z=\frac{\pi}{2k}} \left\{ \frac{B_o^2}{2\mu\mu_o} \text{Cos}^2(kz) \right\} dz \end{array} \right\}.$$

This energy does not change in time because

$$a_1 = \int_{z=0}^{z=\frac{\pi}{2k}} \left\{ \frac{\varepsilon\varepsilon_o E_o^2}{2} \text{Sin}^2(kz) \right\} dz = \int_{z=0}^{z=\frac{\pi}{2k}} \left\{ \frac{B_o^2}{2\mu\mu_o} \text{Cos}^2(kz) \right\} dz, \quad (11)$$

that after taking integrals follows from formula (3). Wherein

$$w_1 = a_1. \quad (12)$$

Similar relations can be obtained for the other three quarter-periods of function (12). Thus, the standing wave retains its electromagnetic energy (which it received during the formation of two traveling waves).

To maintain the ideal standing wave does not require the flow of external energy.

Appendix 6. The list of some theoretical predictions confirmed experimentally

Listed below are some theoretical predictions obtained in the book and confirmed by experimental observations and explanations of experiments that have not yet been substantiated:

- the electromagnetic wave propagates along a spiral trajectory (Chapter 1.3),
- a plane wave can exist physically (Chapter 1a),
- regardless of the parameters of the wire, there is an unambiguous relationship among the voltage U on the wire, the longitudinal component of the magnetic field strength H_z in the wire, and the active power P transmitted through the dielectric wire (Chapter 2)
- in the dielectric circuit there is a longitudinal component of the magnetic field strength (Chapter 2),
- the capacitor can be a converter of variable magnetic induction into alternating electrical voltage (Chapters 2 and 2a),

- the propagation speed of an electromagnetic wave in a capacitor is less than the speed of light and depends on the transmitted active power (Chapter 2),
- a radio signal propagating in an electrically conductive medium consists of two signals propagating at different speeds that explains the “world echo” and other similar phenomena (Chapter 2h),
- the energy flow in the transformer is independent of magnetic flux (Chapter 3),
- a current in the wire can occur not only as a result of the applied alternating voltage but also as a result of the applied external longitudinal magnetomotive force that is observed in the experiments (Chapter 3),
- the longitudinal component of the magnetic field strength in the cavity of the tubular conductor (Chapters 4b, 4c),
- explanation of the functioning of Markov, Zatsarinin, Pozynich transformers (Chapter 4c),
- the line in the DC wire on the cylinder of a constant radius, on which all the strengths and densities of the current remain constant, is a helix (Chapter 5),
- the existence of the longitudinal component of the magnetic field strength in the wire (Chapter 5),
- the energy flow in the wire, equal to the transmitted power, moves inside the wire (Chapter 5),
- torque in the wire and Milroy’s motor (ball-bearing motor based on the Huber effect) (Chapter 5a),
- the EMF in a wire located in an inhomogeneous longitudinal, transverse, or circular magnetic field (Chapter 5d),
- the appearance of a current in a conductor located between the same name ends of two magnets, i.e. the Beulie effect (Chapter 5d),
- Bedini magnetic gateway (Chapter 5d),
- simple brushless DC motor (chapter 5d),
- in a rotating electrically conductive body there appears a circular direct current and by this fact the effects of Barnett and Aspden are explained (Chapter 5h),
- the existence of energy transmission devices due to the emergence of EMFs that are inexplicable by electromagnetic induction (Chapter 6),
- single-wire power transmission (Chapter 6),

- the nature of the potential energy of the capacitor and the mechanism of energy conservation in the dielectric of the capacitor, as well as the nature of energy conservation in the dielectric of the capacitor freed from the plates (Chapter 7),
- magnetic field in a charged capacitor (Chapter 7),
- a capacitor charge in a longitudinal or circular magnetic field (Chapter 7a),
- energy flows, impulses, and angular momenta exist in the vicinity of the end face of the magnet that is confirmed by known experiments (Chapter 7c)
- permanent recovery of magnet energy (Chapter 7c),
- in a spherical electromagnetic wave, the energy flow remains constant with increasing radius and does NOT change in time, which strictly corresponds to the law of conservation of energy (Chapter 8),
- the well-known solution for a spherical electromagnetic wave does NOT satisfy the Maxwell set of equations and for designing antennas it is necessary to use the solution from Chapter 8 (Chapter 8b),
- plasma crystal (Chapter 11),
- in a wire, the density of the Lorentz magnetic force is proportional to the power density (Chapter 12),
- the Lorentz magnetic force does the job (Chapter 12),
- an electromagnetic impulse and a mechanical impulse quantitatively enter in an equivalent manner in the law of conservation of momentum; this statement explains the functioning of the reactionless drives (also known as an inertial propulsion engines, reactionless thrusters, reactionless engines, bootstrap drives, or inertia drives) (Chapter 13),
- there is a flow of energy of a moving body with a static electromagnetic field and related experiments (Chapter 13b),
- there is a static electromagnetic field and energy flow in it (Chapter 13b),
- device for converting a static electromagnetic field pulse into a mechanical pulse (Chapter 13b),
- "flying triangles" (Chapter 13d),
- nonequivalence of the solenoid and magnet (Chapter 14),
- energy flow as an electromotive force (Chapter 15),
- the existence of an electromagnetic wave of limited volume, conserving energy and information, and explaining the mirages of the past (Chapter 16),

- intranuclear forces, as a consequence the existence of an electromagnetic wave of limited volume (Chapter 16a),
- interaction of nanoparticles, as a consequence the existence of an electromagnetic wave of limited volume (Chapter 16b),
- the ability to transmit information in biological systems in the water and air environment (Chapters 16c and 16d),
- reversibility of unipolar induction (Chapter 17),
- justification of the magnetohydrodynamic dynamo effect and the existence of the magnetic field of astronomical objects (Chapter 17),
- Lorentz and Ampere forces as consequences of the existence of an electromagnetic field pulse flux (Chapter 18).

Chapter 1. The Second Solution of Maxwell's Equations for a Vacuum in a Cylindrical Coordinate System

Contents

1. Introduction
2. Solution of Maxwell's Equations
3. The Strengths
4. Energy and Energy Flows
5. Speed of energy movement
6. Momentum and moment of momentum
7. Discussion

1. Introduction

In Chapter 0, inconsistency of the well-known solution of Maxwell's equations was demonstrated. A new solution of Maxwell's equations for a vacuum is proposed below.

2. Solution of Maxwell's Equations

Consider the system of Maxwell's equations for vacuum, which has the form:

$$\text{rot}(E) + \frac{\mu}{c} \frac{\partial H}{\partial t} = 0, \quad (a)$$

$$\text{rot}(H) - \frac{\varepsilon}{c} \frac{\partial E}{\partial t} = 0, \quad (b)$$

$$\text{div}(E) = 0, \quad (c)$$

$$\text{div}(H) = 0. \quad (d)$$

In the cylindrical coordinates system r, φ, z , these equations look like the following equations:

$$\frac{E_r}{r} + \frac{\partial E_r}{\partial r} + \frac{1}{r} \cdot \frac{\partial E_\phi}{\partial \phi} + \frac{\partial E_z}{\partial z} = 0, \quad (1)$$

$$\frac{1}{r} \cdot \frac{\partial E_z}{\partial \phi} - \frac{\partial E_\phi}{\partial z} = \frac{\mu}{c} \frac{dH_r}{dt}, \quad (2)$$

$$\frac{\partial E_r}{\partial z} - \frac{\partial E_z}{\partial r} = \frac{\mu}{c} \frac{dH_\phi}{dt}, \quad (3)$$

$$\frac{E_\phi}{r} + \frac{\partial E_\phi}{\partial r} - \frac{1}{r} \cdot \frac{\partial E_r}{\partial \phi} = \frac{\mu}{c} \frac{dH_z}{dt}, \quad (4)$$

$$\frac{H_r}{r} + \frac{\partial H_r}{\partial r} + \frac{1}{r} \cdot \frac{\partial H_\phi}{\partial \phi} + \frac{\partial H_z}{\partial z} = 0, \quad (5)$$

$$\frac{1}{r} \cdot \frac{\partial H_z}{\partial \phi} - \frac{\partial H_\phi}{\partial z} = \frac{\varepsilon}{c} \frac{dE_r}{dt}, \quad (6)$$

$$\frac{\partial H_r}{\partial z} - \frac{\partial H_z}{\partial r} = \frac{\varepsilon}{c} \frac{dE_\phi}{dt}, \quad (7)$$

$$\frac{H_\phi}{r} + \frac{\partial H_\phi}{\partial r} - \frac{1}{r} \cdot \frac{\partial H_r}{\partial \phi} = \frac{\varepsilon}{c} \frac{dE_z}{dt}, \quad (8)$$

For the sake of brevity further we shall use the following notations:

$$\text{co} = \cos(\alpha\phi + \chi z + \omega t), \quad (11)$$

$$\text{si} = \sin(\alpha\phi + \chi z + \omega t), \quad (12)$$

where α, χ, ω are certain constants. Let us present the unknown functions in the following forms:

$$H_r = h_r(r)\text{co}, \quad (13)$$

$$H_\phi = h_\phi(r)\text{si}, \quad (14)$$

$$H_z = h_z(r)\text{si}, \quad (15)$$

$$E_r = e_r(r)\text{si}, \quad (16)$$

$$E_\phi = e_\phi(r)\text{co}, \quad (17)$$

$$E_z = e_z(r)\text{co}, \quad (18)$$

where $h(r), e(r)$ are the certain functions of the coordinate r . In Chapter 97.2.6 it is proved that there is a solution in the form

$$h_z(r) = 0, \quad (19)$$

$$e_z(r) = 0, \quad (20)$$

$$e_r = e_\phi = \frac{A}{2} r^{\alpha-1}, \quad (21)$$

$$h_\phi(r) = \sqrt{\frac{\varepsilon}{\mu}} e_r(r), \quad (22)$$

$$h_r(r) = -\sqrt{\frac{\varepsilon}{\mu}} e_r(r), \quad (23)$$

$$\chi = \omega\sqrt{\mu\varepsilon}/c, \quad (24)$$

where $A, \varepsilon, \mu, \alpha, \chi, \omega$ are the constants.

3. The strengths

It can be seen that in the obtained solution the strengths

- 1) take an infinite value at $r = 0$, if the exponent of r is negative;
- 2) take an infinite value as $r \rightarrow \infty$ if the exponent of r is positive.

Example 1.

In fig. 1 end 2 shows the graphs of the functions $e_r, e_z, h_\phi, h_r, h_z$ at $A = 2, R = 0.2, \omega = 10^5, \frac{\epsilon}{\mu} = 1$ in the CGS system. In fig. 1 is taken $\alpha = -0.5$, and in Fig. 2 it is taken $\alpha = 1.5$.

The noted disadvantages of the found solution may raise doubts about the applicability of this approach to solving Maxwell's equations. It may seem that a cylindrical wave does not exist in nature at all. In the next chapter, we will show that cylindrical waves exist, and the complication of this solution allows us to find a solution that still satisfies the law of conservation of energy and is devoid of the noted disadvantages of this solution.

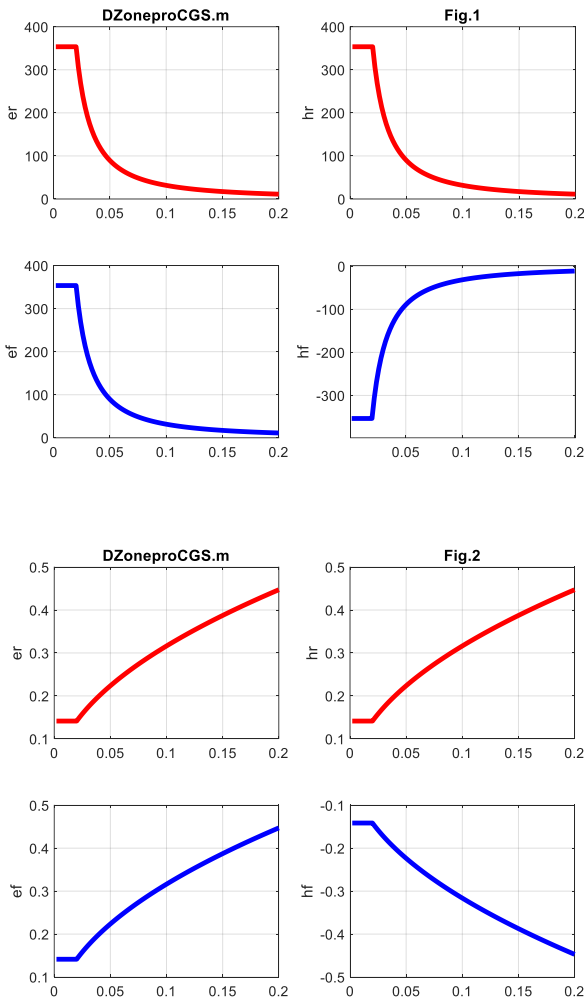

But back to the found solution.

To demonstrate the phase shift between the wave components, consider functions (2.11, 2.12) and (2.16-2.21). Consider functions (2.11, 2.12) and (2.24). Then we find

$$\begin{aligned} \text{co} &= \cos(\alpha\varphi + \sqrt{\varepsilon\mu}\frac{\omega}{c}z + \omega t) = \dots \\ &\sin(\alpha\varphi + \sqrt{\varepsilon\mu}\frac{\omega}{c}z + \omega t + \frac{\pi}{2}), \dots(4) \end{aligned}$$

$$\text{si} = \sin(\alpha\varphi + \sqrt{\varepsilon\mu}\frac{\omega}{c}z + \omega t). \quad (5)$$

Consequently, functions (2.11, 2.12) are antiphase at any moment of time provided

$$\alpha\varphi + \sqrt{\varepsilon\mu}\frac{\omega}{c}z = 0 \quad (6)$$

or

$$\varphi = -\frac{\omega\sqrt{\varepsilon\mu}}{\alpha\cdot c}z. \quad (7)$$

From here and from (2.21-2.23) we find:

$$E_{r\cdot} = e_r(r) \sin(\omega t), \quad (8)$$

$$E_{\varphi\cdot} = e_r(r) \cos(\omega t), \quad (9)$$

$$H_{r\cdot} = -h_{\varphi}(r) \cos(\omega t), \quad (10)$$

$$H_{\varphi\cdot} = h_{\varphi}(r) \sin(\omega t). \quad (11)$$

Consider the vector-function

$$\overline{E_{r\varphi}} = \overline{E_r} + \overline{E_{\varphi}}. \quad (12)$$

From (8, 9) we find the modulus of this function

$$|\overline{E_{r\varphi}}| = e_r, \quad (13)$$

which is independent of time. Likewise,

$$\overline{H_{r\varphi}} = \overline{H_r} + \overline{H_{\varphi}}. \quad (12)$$

From (8, 9) we find the modulus of this function

$$|\overline{H_{r\varphi}}| = h_{\varphi}. \quad (13)$$

Consider function (2.16) at $t = 0$ and under conditions (5, 7):

$$|E_r| = e_r(r) \sin(\alpha\varphi + \sqrt{\varepsilon\mu}\frac{\omega}{c}z), \quad z = \frac{\alpha\cdot c}{\omega\sqrt{\varepsilon\mu}}. \quad (14)$$

This function is a helix with a pitch

$$s = \frac{2\pi\alpha\cdot c}{\omega\sqrt{\varepsilon\mu}}. \quad (17)$$

Therefore, the line with constant strength E_r is a helix. Then the line with the strength E_r , depending on time, will have the form of a sinusoid, the axis of which is the given helical line. Similar conclusions can be drawn regarding the strengths $E_{\varphi}, H_r, H_{\varphi}$

In fig. 3 shows a helix for function (14) at $r = 1, c = 300000, \omega = 3000, \alpha = -3$. The same line corresponds to the functions $|E_\varphi|$ and $|E_{r\varphi}|$.

In fig. 4 shows the same helical line, on which, as on the axis, the sinusoid and cosine are shown. The latter represent the functions E_r and E_φ , respectively.

In fig. 5 shows helical lines (14) under the same conditions, but for different values of the radius $r = [0.5, 0.6, \dots, 1.0, 1.1]$. Straight lines show geometric locations of points with equal φ .

In fig. 6 shows the vectors of strengths emanating from the point $A(r, \varphi)$. The vectors of strengths E and H are orthogonal. The solution also exists with changed signs of the functions (2.11, 2.12). This case corresponds to Fig. 7. Fig. 6 and fig. 7 illustrate that two types of circular polarization of an electromagnetic wave are possible.

In fig. 8 shows all of the above vectors. It is seen that when the point T moves along the helix, the total vectors $H_{r\varphi}$ and $E_{r\varphi}$ rotate in the plane perpendicular to the helix. Their modules remain constant and equal to each other. The vectors $H_{r\varphi}$ and $E_{r\varphi}$ are always orthogonal.

Rotation of vectors around a helix is shown more clearly in Fig. 9 where

- a segment of a helix - a thick dashed line,
- vector of total strength $\overline{E_{r\varphi}}$, the beginning of which slides along a helical line - thin lines,
- circles that describe the end of the vector $\overline{E_{r\varphi}}$,
- the trajectory of the end of the vector $\overline{E_{r\varphi}}$ is a thick line.

The total magnetic strength $\overline{H_{r\varphi}}$ is also displayed in the same way. Its vector rotates along the same circle, but lags behind in phase by a quarter of a period. The following fig. 9a shows both of these vectors $\overline{E_{r\varphi}}$ and $\overline{H_{r\varphi}}$. Also shown are two sinusoids along which the ends of these vectors move. This figure shows the segments of the trajectory on which the vectors $(E_{r\varphi})^-$ and $\overline{H_{r\varphi}}$ rotate by 2π . In this case, the center of the circle is shifted along the z -axis by the value Λ (15). Thus, when these vectors slide along the helix, they rotate by 2π with a vertical displacement by a step Λ along the helix. We observe a double rotation of these vectors. It is natural to call the double rotation step Λ the length of the considered wave.

Chapter 1. The Second Solution of Maxwell's Equations for a Vacuum in a Cylindrical Coordinate System

In what follows, we will call it a double wave, and the mathematical definition of this wave in the form (2.11-2.18) is the double wave equation.

Let us compare (15), (2.24) and the well-known formula for determining the wavelength for the wave equation:

$$\lambda = \frac{2\pi c}{\omega\sqrt{\mu\varepsilon}} = \frac{2\pi}{\chi}. \tag{16}$$

Then we find:

$$\Lambda = \alpha\lambda. \tag{17}$$

We have obtained a formula linking the traditional wavelength and the length of double wave

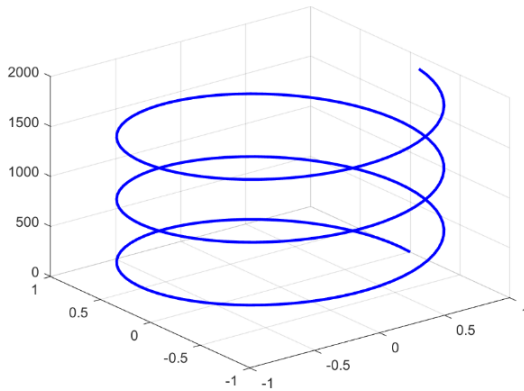

Fig. 3. (EHspiral31.m)

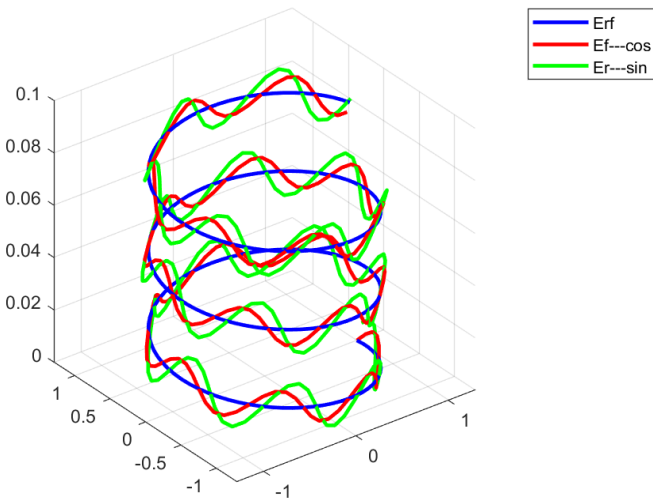

Fig. 4. (EHspiral32.m)

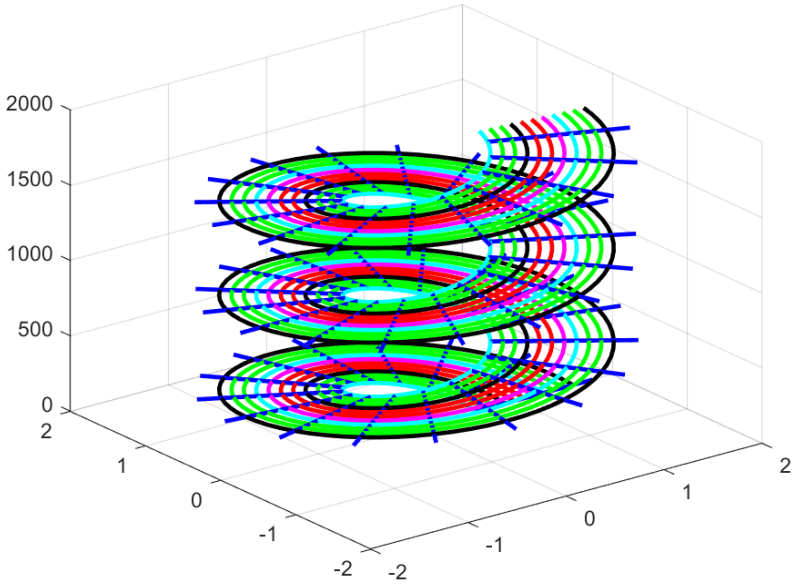

Fig. 5. (EHspiral34.m)

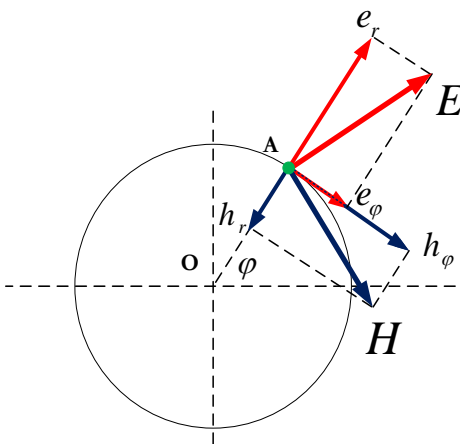

Fig. 6.

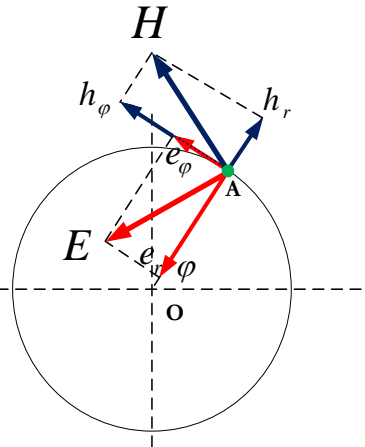

Fig. 7.

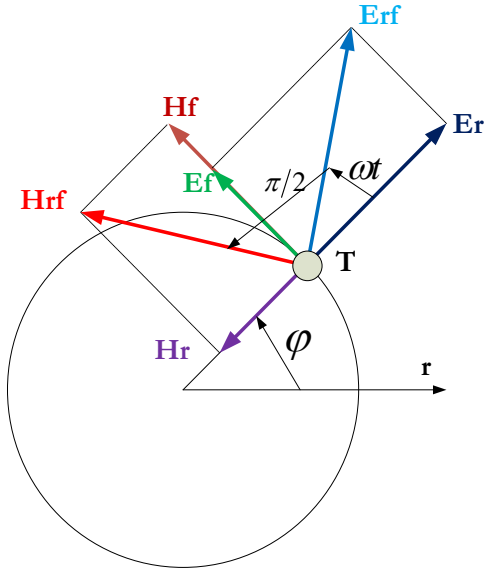
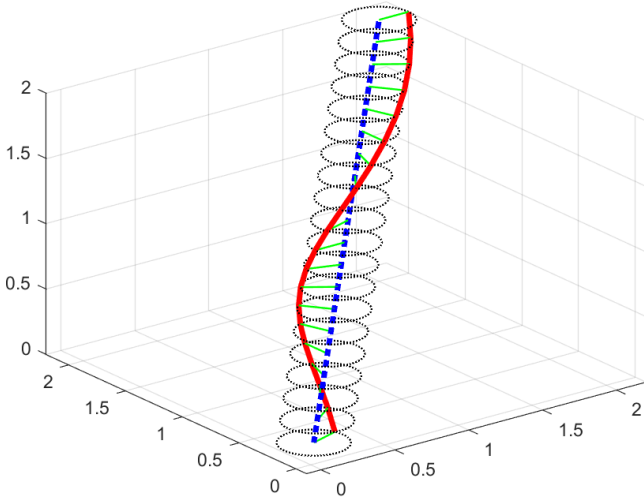
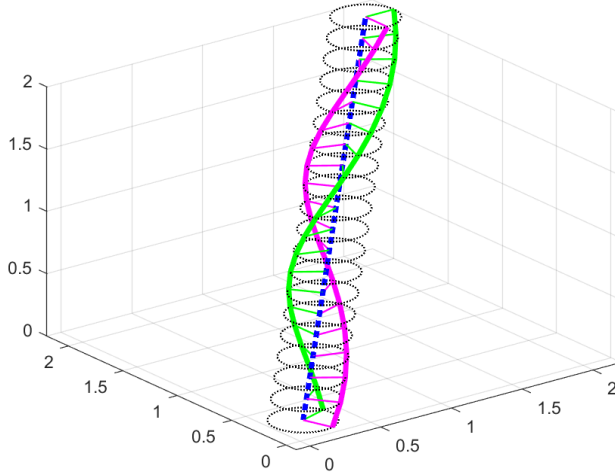

Fig. 8.



- ■ ■ ■ a segment of a helix
- vector of total strength Erf
- ● ● ● circle rotation of vector Erf
- trajectory of the end of vector Erf

Fig. 9 (EHspiral33.m)



- ■ ■ ■ segment of helix
- vector of Erf
- vector of Hrf
- ■ ■ ■ circle rotation of Erf, Hrf
- trajectory of end of Hrf
- trajectory of end of Erf

Fig. 9a (EHspiral37.m)

So, the proposed description of a cylindrical electromagnetic wave - the so-called double wave and its mathematical definition - the so-called double wave equation. The flow of energy in this wave does not change over time. In a double wave, vectors of electric and magnetic strengths of constant magnitude slide along a helical line located on a cylinder of a certain radius, and at the same time rotate so that they sweep out a circle whose plane is perpendicular to the axis of the cylinder. In this case, they rotate by 2π with a vertical displacement by a step Λ along a helical line. The so-called double rotation of these vectors. The double rotation step Λ is a length of the double wave. The projections of the vectors "sweep out" sinusoids, the axis of which is a helical line. In this case, the electrical and magnetic strengths are phase shifted by a quarter of the period.

4. Energy and Energy Flows

The density of energy is

$$W = \frac{1}{8\pi} (\epsilon H^2 + \mu E^2) \tag{a}$$

Taking into account equations (2.19-2.24), we can find:

$$\begin{aligned} W &= \frac{1}{8\pi} \left(\varepsilon \left((e_r \text{si})^2 + (e_\varphi \text{co})^2 \right) + \mu \left((h_r \text{co})^2 + (h_\varphi \text{si})^2 \right) \right) \\ &= \frac{1}{8\pi} \left(\varepsilon \left((e_r \text{si})^2 + (e_\varphi \text{co})^2 \right) + \mu \frac{\varepsilon}{\mu} \left((e_r \text{co})^2 + (e_r \text{si})^2 \right) \right) \end{aligned}$$

or

$$W(r) = \frac{\varepsilon}{4\pi} (e_r(r))^2. \quad (b)$$

Thus, electromagnetic wave energy density is constant in time and equal in all points of the cylinder of given radius.

The density of electromagnetic flow is the Poynting vector:

$$S = \eta E \times H, \quad (1)$$

where

$$\eta = c/4\pi. \quad (2)$$

In the SI system, $\eta = 1$ and formula (1) of this section takes the following form:

$$S = E \times H, \quad (3)$$

In the cylindrical coordinates r, ϕ, z , the density flow of electromagnetic energy has three components S_r, S_ϕ, S_z , directed along the corresponding axis. They are determined by the following formula:

$$S = \begin{bmatrix} S_r \\ S_\phi \\ S_z \end{bmatrix} = \eta (E \times H) = \eta \begin{bmatrix} E_\phi H_z - E_z H_\phi \\ E_z H_r - E_r H_z \\ E_r H_\phi - E_\phi H_r \end{bmatrix}. \quad (4)$$

The flow passing through a given section of a cylindrical wave at a given time is

$$\bar{S} = \begin{bmatrix} \bar{S}_r \\ \bar{S}_\phi \\ \bar{S}_z \end{bmatrix} = \iint_{r,\varphi} \left(\begin{bmatrix} S_r \\ S_\phi \\ S_z \end{bmatrix} dr \cdot d\varphi \right) \quad (6)$$

It is shown above that $H_z(r) = 0, E_z(r) = 0$. Therefore, $S_r = 0, S_\phi = 0$, i.e. the energy flux propagates only along the z -axis and is equal in accordance with (2.21-2.23) to

$$\bar{S} = \bar{S}_z = \eta \iint_{r,\varphi} \left((e_r h_\phi \text{si}^2 + e_\phi h_r \text{co}^2) dr \cdot d\varphi \right) \quad (7)$$

or

$$\bar{S} = \bar{S}_z = \sqrt{\frac{\varepsilon}{\mu}} 2\pi\eta e_r^2. \quad (8)$$

Therefore, there is only a flux along the z -axis and this flux of electromagnetic wave energy is constant in time. This corresponds to the law of conservation of energy.

The absence of energy flow along the radius means that the wave's region of existence is NOT expanding. This means that the given solution of Maxwell's equations describes a cylindrical wave.

5. Speed of energy movement

First of all, we have to find the propagation speed of a monochromatic electromagnetic wave. Obviously, this speed is equal to the derivative $\frac{dz}{dt}$ of the function $z(t)$ given implicitly in forms (2.16-2.21). For instance, consider function (2.16). We have:

$$\frac{d(H_r)}{dz} = h_r \frac{d}{dz} (\cos(\alpha\varphi + \chi z + \omega t)) = -\text{si} \cdot h_r \chi, \quad (1)$$

$$\frac{d(H_r)}{dt} = h_r \frac{d}{dt} (\cos(\alpha\varphi + \chi z + \omega t)) = -\text{si} \cdot h_r \omega. \quad (2)$$

Then the propagation speed of a monochromatic electromagnetic wave is written as follows:

$$V_m = \frac{dz}{dt} = \frac{d(H_r)}{dt} / \frac{d(H_r)}{dz} = \frac{\omega}{\chi}. \quad (3)$$

Taking (2.28) into account, we obtain

$$V_m = \omega / (\omega \sqrt{\mu\epsilon} / c) = \frac{c}{\sqrt{\mu\epsilon}}. \quad (4)$$

Since in a vacuum $\mu = \epsilon = 1$, the propagation velocity of a monochromatic electromagnetic wave in a vacuum is equal to the speed of light, namely:

$$v_m = c. \quad (5)$$

Umov's concept [81] is generally accepted, according to which the energy flux density S is a product of the energy density W and the speed v_e of energy movement:

$$S = W \cdot v_e. \quad (6)$$

With (4.11) and (3.3), we obtain:

$$v_e = \frac{S_z}{W} = \left(\frac{c}{4\pi} e_r^2 \sqrt{\frac{\epsilon}{\mu}} \right) / \left(\frac{\epsilon}{4\pi} e_r^2 \right) = \frac{c}{\sqrt{\epsilon\mu}} \quad (7)$$

Thus, the speed of energy motion is constant for all points of the wave cross-section (independent of r).

The speed v_e of movement of the electromagnetic energy is not always equal to the speed of light. For example, in a standing wave there is $v_e = 0$.

Note that, based on the known solution and formula (18), we cannot find the speed v_e . Indeed, in the SI system we find that:

$$v_e = \frac{S}{W} = EH / \left(\frac{\epsilon E^2}{2} + \frac{H^2}{2\mu} \right) = 2\mu / \left(\epsilon\mu \frac{E}{H} + \frac{H}{E} \right).$$

If $\frac{\varepsilon E^2}{2} = \frac{H^2}{2\mu}$, then $\frac{H}{E} = \sqrt{\mu\varepsilon}$. Then for a vacuum there is

$$v_e = 2\mu / \left(\varepsilon\mu \frac{1}{\sqrt{\varepsilon\mu}} + \sqrt{\varepsilon\mu} \right) = \sqrt{\frac{\mu}{\varepsilon}} \approx 376,$$

which is not true. In general, the solution obtained here cannot be found in a vector form.

We also find the rotation speed of the electromagnetic wave. Obviously, this velocity is equal to the derivative $d\varphi/dt$ of the function $\varphi(t)$ given implicitly in forms (2.16)-(2.21). Consider, for example, function (2.16). We have:

$$\frac{d(H_r)}{d\varphi} = h_r \frac{d}{d\varphi} (\cos(\alpha\varphi + \chi z + \omega t)) = -\text{si} \cdot h_r \alpha, \quad (8)$$

$$\frac{d(H_r)}{dt} = h_r \frac{d}{dt} (\cos(\alpha\varphi + \chi z + \omega t)) = -\text{si} \cdot h_r \omega. \quad (9)$$

Then the rotation speed v_φ of the monochromatic electromagnetic wave is

$$v_\varphi = \frac{d\varphi}{dt} = \frac{d(H_r)/dt}{d(H_r)/d\varphi} = \frac{\omega}{\alpha}. \quad (10)$$

6. Momentum and moment of momentum

It is known that the flow of energy is associated with other characteristics of the wave via the dependencies in the following forms [21, 25, 63] (in the SI system):

$$|f| = W, \quad (1)$$

$$S = W \cdot c, \quad (2)$$

$$p = W/c, p = S/c^2, \quad (3)$$

$$f = p \cdot c, f = S/c, \quad (4)$$

$$m = p \cdot r, \quad (5)$$

where

W is the energy density (scalar), $\text{kg m}^{-1} \cdot \text{s}^{-2}$,

S the energy flux density (vector), $\text{kg} \cdot \text{s}^{-3}$,

p the momentum density (vector), $\text{kg} \cdot \text{m}^{-2} \cdot \text{s}^{-1}$,

f the momentum flux density (vector), $\text{kg} \cdot \text{m}^{-1} \cdot \text{s}^{-2}$,

m the density of momentum at this point about an axis spaced from the given point by a distance r (vector), $\text{kg} \cdot \text{s}^{-2}$,

V the volume of the electromagnetic field (scalar), m^3 .

It follows from the above that in the electromagnetic wave there exist energy flows directed along a radius, along a circle, along an axis.

Consequently, in the electromagnetic wave there exists momentum directed along a radius, along a circle, along an axis. Also there exists momentum directed along a radius, along a circle, along an axis.

Let's consider the angular momentum about the z -axis. According to (3), we can find this momentum as follows:

$$L_z = p_z r = s_z r / c^2. \quad (6)$$

This is the orbital angular momentum that can be detected in so-called twisted light. Further on, we bring you a reduced quotation from [64]. *The fact that the light wave carries not only energy and momentum but also angular momentum was known a century ago. At first, of course, the angular momentum was associated only with polarization of light. ... But time went by. Lasers were created, scientists had learnt to control the light emitted by lasers, and a theory describing its electromagnetic field was developing. And at a certain time, it was realized that these two properties — direction of the light beam and its twisted characteristic — do not contradict to each other. ... Certain methods of generation and detection of the twisted light were proposed. Three years after ... practical researchers confirmed that a specially prepared mode of the laser beam, which have also been known before, is actually occurred to be the twisted light. ... After that, like an avalanche, researches rushed to investigate the phenomenon of the twisted light. ... Along with fundamental investigations, various practical applications of the twisted light started to be developed...*

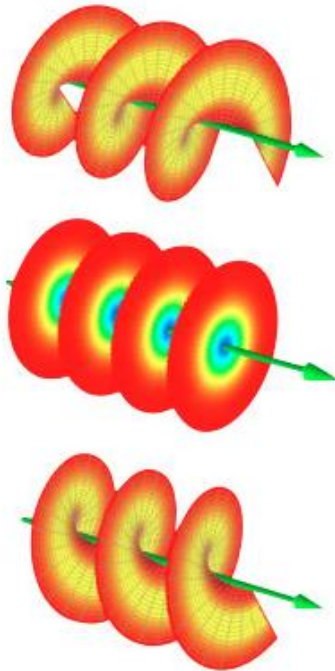

Fig. 10.

However, it should be noted that the existence of the twisted light does not follow from the existing solution of Maxwell's equations. But it naturally follows from the proposed solution, see in equation (6). In Figure 10 (taken from [64]) *"the picture with the twisted light doesn't show the electric field, but the wavefront (the middle picture shows nontwisted light, and the upper and lower ones show the light twisted to one or another side). It is not flat; in this case, the wave phase changes not only along the beam but also with shifting in cross-sectional plane... As the energy flow of the light wave is usually directed perpendicular to the wavefront, it occurs that in the twisted light energy and momentum not only fly ahead but also spin around the axis of movement."* This particular fact was confirmed above, see in Figure 3.5 for comparison.

7. Discussion

Figure 8 shows the strengths in Cartesian coordinates. The resulting solution describes a wave. The main distinctions from the known solution are as follows:

1. Instantaneous (and not average by certain period) energy flow does not change with time, which complies with the Law of energy conservation.
2. The energy flow has a positive value.
3. The energy flow extends along the wave.
4. The magnetic and electrical fields' strengths on one of the coordinate axes r, ϕ, z are shifted in a phase by a quarter of period.
5. The solution for the magnetic and electrical fields' strengths is a real parameter.
6. The solution exists at a constant speed of wave propagation.
7. The existence region of the wave does not expand that is evidenced by the existence of laser.
8. The vectors of the electrical and magnetic fields' strengths are orthogonal.
9. There are two possible types of electromagnetic wave circular polarization.
10. A wave can be represented as a set of helical lines along which vectors of electric and magnetic strengths move. These vectors are orthogonal and rotate around a helix.
11. Such a wave has nothing to do with the wave function. Therefore, we will call such a wave a double wave, and we will call mathematical description of this wave the equation double wave.

Chapter 1a. Plane Wave.

Let us again consider the set of Maxwell's equations for a vacuum in the cylindrical coordinates, which is given in Chapter 1 and consists of ten equations (1.2.1)-(1.2.10). By definition, the strengths of a plane wave are independent of φ . In this case, eight equations (1.2.1)-(1.2.8) take the following forms:

$$\frac{E_r}{r} + \frac{\partial E_r}{\partial r} + \frac{\partial E_z}{\partial z} = 0, \quad (1)$$

$$-\frac{\partial E_\varphi}{\partial z} = -\frac{\mu}{c} \frac{\partial}{\partial r} H_r, \quad (2)$$

$$\frac{\partial E_r}{\partial z} - \frac{\partial E_z}{\partial r} = -\frac{\mu}{c} \frac{\partial}{\partial r} H_\varphi, \quad (3)$$

$$\frac{E_\varphi}{r} + \frac{\partial E_\varphi}{\partial r} = -\frac{\mu}{c} \frac{\partial}{\partial r} H_z, \quad (4)$$

$$\frac{H_r}{r} + \frac{\partial H_r}{\partial r} + \frac{\partial H_z}{\partial z} = 0, \quad (5)$$

$$-\frac{\partial H_\varphi}{\partial z} = \frac{\varepsilon}{c} \frac{\partial}{\partial r} E_r, \quad (6)$$

$$\frac{\partial H_r}{\partial z} - \frac{\partial H_z}{\partial r} = \frac{\varepsilon}{c} \frac{\partial}{\partial r} E_\varphi, \quad (7)$$

$$\frac{H_\varphi}{r} + \frac{\partial H_\varphi}{\partial r} = \frac{\varepsilon}{c} \frac{\partial}{\partial r} E_z. \quad (8)$$

The solution of this set of equations for a monochromatic wave, as before, can be written in the form of equations (1.2.11), (1.2.12), (1.2.16)-(1.2.21), and (1.2.24)-(1.2.28). However, in this case there is

$$\alpha = 0. \quad (9)$$

In this case, it is necessary to write down the following three equations instead of (1.2.11), (1.2.12), and (1.2.25), respectively:

$$c_0 = \cos(\chi z + \omega t), \quad (11)$$

$$s_i = \sin(\chi z + \omega t), \quad (12)$$

$$e_r(r) = e_\varphi(r) = \frac{A}{2r}. \quad (25)$$

Thus, the front of a plane wave is a flat circle, the strengths on which have a hyperbolic decay depending on the radius. Such a plane wave can exist physically (which contradicts existing ideas).

Chapter 1b. The second solution of Maxwell's equations for vacuum in a rectangular coordinate system

Chapter 1 found the second solution of Maxwell's equations for vacuum in a cylindrical coordinate system. Here we will find the second solution of Maxwell's equations for vacuum in a rectangular coordinate system.

Chapter 1 shows that the second solution of Maxwell's equations for vacuum in a cylindrical coordinate system has the following form:

$$H_r = h_r(r) \text{co}, \quad (1)$$

$$H_\varphi = h_\varphi(r) \text{si}, \quad (2)$$

$$H_z = h_z(r) \text{si}, \quad (3)$$

$$E_r = e_r(r) \text{si}, \quad (4)$$

$$E_\varphi = e_\varphi(r) \text{co}, \quad (5)$$

$$E_z = e_z(r) \text{co}, \quad (6)$$

where

$$\text{co} = \cos(\alpha\varphi + \chi z + \omega t), \quad (7)$$

$$\text{si} = \sin(\alpha\varphi + \chi z + \omega t), \quad (8)$$

$$\chi = \omega\sqrt{\mu\varepsilon}/c, \quad (9)$$

$$e_z(r) = 0, \quad (10)$$

$$h_z(r) = 0, \quad (11)$$

$$e_r(r) = e_\varphi(r) = 0.5Ar^{(\alpha-1)}, \quad (12)$$

$$h_\varphi(r) = \sqrt{\frac{\varepsilon}{\mu}} e_r(r), \quad (13)$$

$$h_r(r) = -\sqrt{\frac{\varepsilon}{\mu}} e_r(r), \quad (14)$$

$$A, \alpha, \omega - \text{const.}$$

We now turn to the Cartesian coordinate system. Then we find:

$$r = \sqrt{x^2 + y^2}, \quad (15)$$

$$\varphi = \text{arctg}(y/x), \quad (15a)$$

$$E_x = E_r \cos(\varphi) + E_\varphi \sin(\varphi) = e_r \text{si} \cdot \cos(\varphi) + e_\varphi \text{co} \cdot \sin(\varphi) = e_r (\text{si} \cdot \cos(\varphi) + \text{co} \cdot \sin(\varphi)) = e_r \sin((\alpha + 1)\varphi + \chi z + \omega t), \quad (16)$$

$$E_y = E_r \sin(\varphi) + E_\varphi \cos(\varphi) = e_r \text{si} \cdot \sin(\varphi) + e_\varphi \text{co} \cdot \cos(\varphi) = e_r (\text{si} \cdot \sin(\varphi) + \text{co} \cdot \cos(\varphi)) = e_r \cos((\alpha - 1)\varphi + \chi z + \omega t), \quad (17)$$

$$H_x = H_r \cos(\varphi) + H_\varphi \sin(\varphi) = h_r \text{co} \cdot \cos(\varphi) + h_\varphi \text{si} \cdot \sin(\varphi) = h_r (\text{co} \cdot \cos(\varphi) - \text{si} \cdot \sin(\varphi)) = h_r \cos((\alpha + 1)\varphi + \chi z + \omega t) - \sqrt{\frac{\varepsilon}{\mu}} e_r \cos((\alpha + 1)\varphi + \chi z + \omega t), \quad (18)$$

$$H_y = H_r \sin(\varphi) + H_\varphi \cos(\varphi) = h_r \text{co} \cdot \sin(\varphi) + h_\varphi \text{si} \cdot \cos(\varphi) = h_r (\text{co} \cdot \sin(\varphi) - \text{si} \cdot \cos(\varphi)) = h_r \sin((\alpha - 1)\varphi + \chi z + \omega t) - \sqrt{\frac{\varepsilon}{\mu}} e_r \sin((\alpha - 1)\varphi + \chi z + \omega t) \quad (19)$$

or

$$E_x = e_x \sin((\alpha + 1)\varphi + \chi z + \omega t), \quad (20)$$

$$E_y = e_y \cos((\alpha - 1)\varphi + \chi z + \omega t), \quad (21)$$

$$H_x = h_x \cos((\alpha + 1)\varphi + \chi z + \omega t), \quad (22)$$

$$H_y = h_y \sin((\alpha - 1)\varphi + \chi z + \omega t), \quad (23)$$

where

$$e_x(r) = e_y(r) = 0.5Ar^{(\alpha-1)}, \quad (24)$$

$$h_x(r) = h_y(r) = -\sqrt{\frac{\varepsilon}{\mu}} e_x(r). \quad (25)$$

This solution satisfies the law of conservation of energy because the transformation of coordinates does not change the properties of the physical system, which is described by this solution.

Chapter 1z. The solution of Maxwell's equations for a cylindrical wave in vacuum

Annotation

It is shown that there are natural processes that create cylindrical waves. It is proved, as a consequence of the solution of Maxwell's equations, that theoretically possible cylindrical waves of different radii and different frequencies, carrying a flow of electromagnetic energy of different magnitude.

Contents

1. Introduction
2. On the method for solving Maxwell's equations
3. About the flow of energy
4. Solving Maxwell's equations
5. Second solution of Maxwell's equations

1. Introduction

B [202] «consider a cylindrically symmetric wavefunction $\psi(\rho, t)$, where $\rho = (x^2 + y^2)^{1/2}$ is a standard cylindrical coordinate. Assuming that this function satisfies the three-dimensional wave equation, which can be rewritten

$$\frac{\partial^2 \psi}{\partial t^2} = v^2 \left(\frac{\partial^2 \psi}{\partial \rho^2} + \frac{1}{\rho} \frac{\partial \psi}{\partial \rho} \right), \quad (538)$$

it can be shown that a sinusoidal cylindrical wave of phase angle φ , wavenumber k , and angular frequency $\omega = kv$, has the approximate wavefunction

$$\psi(\rho, t) \approx \psi_0 \rho^{-1/2} \cos(\omega t - k\rho - \varphi) \quad (539)$$

in the limit $\omega = kv$. Here, $\psi_0 \rho^{-1/2}$ is the amplitude of the wave. The associated wavefronts (i.e., the surfaces of constant phase) are a set of concentric cylinders that propagate radially outward, from their common axis $\rho = 0$ at the phase velocity $\omega/k = v$ - см. рис. 1. The wave amplitude attenuates as $\rho^{-1/2}$. Such behavior can be understood as a consequence of energy conservation, according to which the power flowing across the various $\rho = \text{const}$. (The areas of such surfaces scale as $A \propto \rho$. Moreover, the power flowing across them is proportional to $\psi^2 A$, because the energy flux associated with a wave is generally proportional to ψ^2 , and is directed

normal to the wavefronts.) The cylindrical wave specified in expression (539), is such as would be generated by a uniform line source located $\rho = 0$ - see fig. 1.»



Рис. 1.

It is strange that the author would call such waves cylindrical. They should be called conical, because in them, wavefronts are a set of concentric cylinders that propagate radially outward, and also propagate along the axis: the fronts that appeared earlier continue to expand, while the emerging cylinders begin to expand. The justification would be that really cylindrical waves, in which these cylinders retain their radius, do not exist in nature. But look at the magnifying glass with which the boy makes a fire at noon - see fig. 2. The sunbeam that enters the magnifying glass is obviously a cylindrical wave. Cylindrical lenses are also known, the feature of which is the presence of an axis in the direction of which the optical action does not manifest itself (ie, there is no refraction, reflection and scattering of radiation) [203]. Another example is a Fresnel loop that creates a cylindrical output wave - see fig. 3 from [207].

Thus, cylindrical waves (as well as conical ones) cannot be represented by a wave function. Therefore, we will consider a new function that describes cylindrical waves and is a solution to Maxwell's equations.

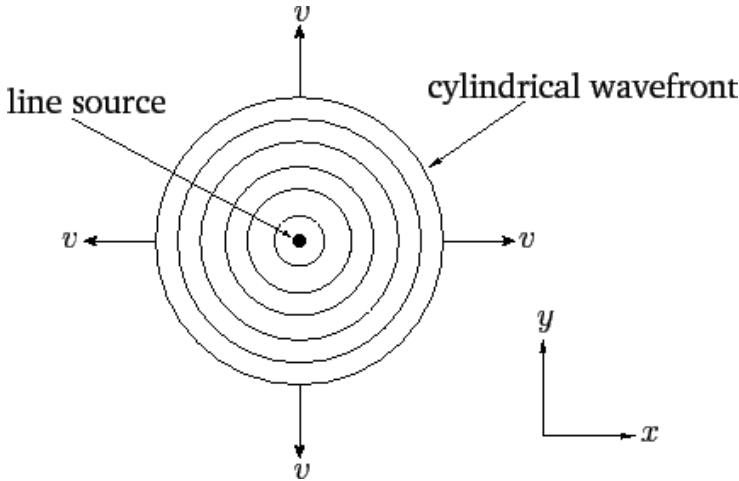

Рис. 2.



Рис. 3.

Further, it will be proved that for the system of Maxwell's equations there is a solution that describes a cylindrical wave in vacuum. This solution maintains a constant flow of energy in such a wave and the shape of this wave.

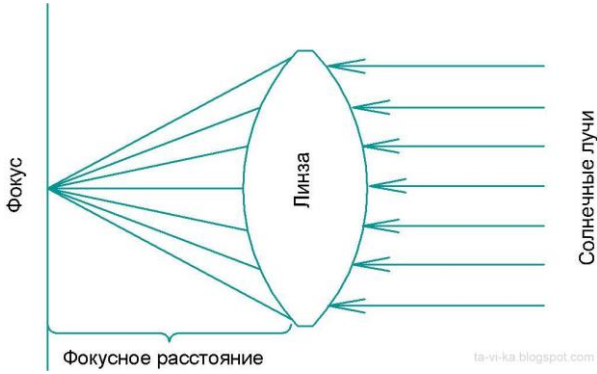
2. On the method for solving Maxwell's equations

Consider the Maxwell system of equations for vacuum, which has the form:

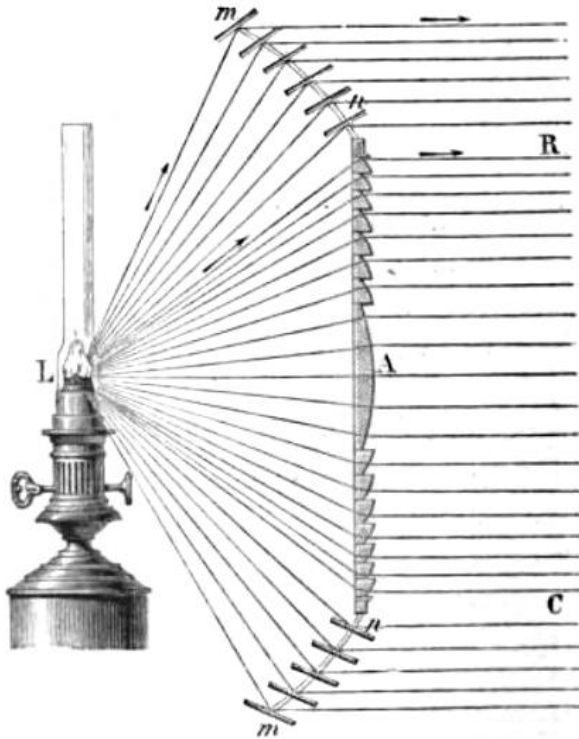
$$\operatorname{rot}(E) + \frac{\mu}{c} \frac{\partial H}{\partial t} = 0, \quad (\text{a})$$

$$\operatorname{rot}(H) - \frac{\varepsilon}{c} \frac{\partial E}{\partial t} = 0, \quad (\text{b})$$

$$\operatorname{div}(E) = 0, \quad (\text{c})$$

$$\operatorname{div}(H) = 0. \quad (\text{d})$$

In the system of cylindrical coordinates r, φ, z these equations have the form shown in Chapter 1:

$$\frac{E_r}{r} + \frac{\partial E_r}{\partial r} + \frac{1}{r} \cdot \frac{\partial E_\phi}{\partial \phi} + \frac{\partial E_z}{\partial z} = 0, \quad (1)$$

$$\frac{1}{r} \cdot \frac{\partial E_z}{\partial \phi} - \frac{\partial E_\phi}{\partial z} = \frac{\mu}{c} \frac{dH_r}{dt}, \quad (2)$$

$$\frac{\partial E_r}{\partial z} - \frac{\partial E_z}{\partial r} = \frac{\mu}{c} \frac{dH_\phi}{dt}, \quad (3)$$

$$\frac{E_\phi}{r} + \frac{\partial E_\phi}{\partial r} - \frac{1}{r} \cdot \frac{\partial E_r}{\partial \phi} = \frac{\mu}{c} \frac{dH_z}{dt}, \quad (4)$$

$$\frac{H_r}{r} + \frac{\partial H_r}{\partial r} + \frac{1}{r} \cdot \frac{\partial H_\phi}{\partial \phi} + \frac{\partial H_z}{\partial z} = 0, \quad (5)$$

$$\frac{1}{r} \cdot \frac{\partial H_z}{\partial \phi} - \frac{\partial H_\phi}{\partial z} = \frac{\varepsilon}{c} \frac{dE_r}{dt}, \quad (6)$$

$$\frac{\partial H_r}{\partial z} - \frac{\partial H_z}{\partial r} = \frac{\varepsilon}{c} \frac{dE_\phi}{dt}, \quad (7)$$

$$\frac{H_\phi}{r} + \frac{\partial H_\phi}{\partial r} - \frac{1}{r} \cdot \frac{\partial H_r}{\partial \phi} = \frac{\varepsilon}{c} \frac{dE_z}{dt}, \quad (8)$$

where E_r, E_ϕ, E_z are electrical strengths, H_r, H_ϕ, H_z are magnetic strengths. In this chapter, we will look for these functions in the following form:

$$H_r = h_r(r) \operatorname{co}, \quad (9)$$

$$H_\phi = h_\phi(r) \operatorname{si}, \quad (10)$$

$$H_z = h_z(r) \operatorname{si}, \quad (11)$$

$$E_r = e_r(r) \operatorname{si}, \quad (12)$$

$$E_\phi = e_\phi(r) \operatorname{co}, \quad (13)$$

$$E_z = e_z(r) \operatorname{co}, \quad (14)$$

where $h(r), e(r)$ are the certain functions of the coordinate r ,

$$\operatorname{co} = \cos(\alpha\varphi + \chi z + \omega t), \quad (15)$$

$$\operatorname{si} = \sin(\alpha\varphi + \chi z + \omega t), \quad (16)$$

where $\varepsilon, \mu, \alpha, \chi, \omega$ are the constants. Let us briefly consider the method for solving this system of equations from Chapter 1, since some modification of this method will be proposed below.

We will differentiate functions (15, 16) with respect to the arguments r, φ, z to obtain partial derivatives of functions (9-14). These derivatives will be substituted into equations (1-8). In this case, it turns out that in each equation, all terms will have the same trigonometric function, which can be canceled. Then equations (1-8) will take the form:

$$\frac{e_r(r)}{r} + e_r'(r) - \frac{e_\varphi(r)}{r} \alpha - \chi \cdot e_z(r) = 0, \quad (17)$$

$$-\frac{1}{r} \cdot e_z(r) \alpha + e_\varphi(r) \chi - \frac{\mu\omega}{c} h_r = 0, \quad (18)$$

$$e_r(r) \chi - e_z'(r) + \frac{\mu\omega}{c} h_\varphi = 0, \quad (19)$$

$$\frac{e_\varphi(r)}{r} + e_\varphi'(r) - \frac{e_r(r)}{r} \cdot \alpha + \frac{\mu\omega}{c} h_z = 0, \quad (20)$$

$$\frac{h_r(r)}{r} + h_r'(r) + \frac{h_\varphi(r)}{r} \alpha + \chi \cdot h_z(r) = 0, \quad (21)$$

$$\frac{1}{r} h_z(r) \alpha - h_\varphi(r) \chi - \frac{\varepsilon\omega}{c} e_r(r) = 0, \quad (22)$$

$$-h_r(r) \chi - h_z'(r) + \frac{\varepsilon\omega}{c} e_\varphi(r) = 0, \quad (23)$$

$$\frac{h_\varphi(r)}{r} + h_\varphi'(r) + \frac{h_r(r)}{r} \alpha + \frac{\varepsilon\omega}{c} e_z(r) = 0. \quad (24)$$

where k is some constant. Let's change variables according to (25-27) in equations (17-24) and rewrite them:

Let's pretend that

$$h_r = k e_r, \quad (25)$$

$$h_\varphi = -k e_\varphi, \quad (26)$$

$$h_z = -k e_z, \quad (27)$$

where k is some constant. Let's change variables according to (25-27) in equations (17-24) and rewrite them:

$$\frac{e_r}{r} + \dot{e}_r - \frac{e_\varphi}{r} \alpha - \chi e_z = 0, \quad (28)$$

$$-\frac{e_z}{r} \alpha + e_\varphi \chi - \frac{\mu\omega}{c} k e_r = 0, \quad (29)$$

$$-\dot{e}_z + e_r \chi - k \frac{\mu\omega}{c} e_\varphi = 0, \quad (30)$$

$$\frac{e_\varphi}{r} + \dot{e}_\varphi - \frac{e_r}{r} \alpha - k \frac{\mu\omega}{c} e_z = 0, \quad (31)$$

$$k \frac{e_r}{r} + k \dot{e}_r - k \frac{e_\varphi}{r} \alpha - k \chi e_z = 0, \quad (32)$$

$$-k \frac{e_z}{r} \alpha + k e_\varphi \chi - \frac{\varepsilon\omega}{c} e_r = 0, \quad (33)$$

$$k\dot{e}_z - ke_r\chi + \frac{\varepsilon\omega}{c}e_\varphi = 0, \quad (34)$$

$$-k\frac{e_\varphi}{r} - k\dot{e}_\varphi + k\frac{e_r}{r}\alpha + \frac{\varepsilon\omega}{c}e_z = 0. \quad (35)$$

It can be proved that this system can be reduced to a system of four equations (28-31) with unknowns e_z , e_φ , e_r , k .

3. About the flow of energy

The primary challenge is to find a solution in which the flow of energy remains constant over time. Let us find the conditions under which the functions (2.9-2.14) satisfy this requirement.

It is known that the flux density of electromagnetic energy is the Poynting vector

$$S = \eta E \times H, \quad (1)$$

where

$$\eta = c/4\pi. \quad (2)$$

In cylindrical coordinates r, φ, z the electromagnetic energy flux density has three components S_r, S_φ, S_z directed along the radius, along the circumference, along the axis, respectively. They are determined by the formula

$$S = \begin{bmatrix} S_r \\ S_\varphi \\ S_z \end{bmatrix} = \eta(E \times H) = \eta \begin{bmatrix} E_\varphi H_z - E_z H_\varphi \\ E_z H_r - E_r H_z \\ E_r H_\varphi - E_\varphi H_r \end{bmatrix}. \quad (3)$$

We will consider the case when there are no longitudinal stresses, i.e. $H_z(r) = 0$, $E_z(r) = 0$. Therefore, $S_r = 0$, $S_\varphi = 0$, i.e. the energy flux propagates only along the oz axis and its density is

$$S = S_z = \eta(E_r H_\varphi - E_\varphi H_r) \quad (4)$$

or, taking into account (9-16),

$$S = S_z = \eta(e_r h_\varphi \text{si}^2 - e_\varphi h_r \text{co}^2). \quad (5)$$

If

$$e_r h_\varphi = -e_\varphi h_r, \quad (6)$$

then

$$S_z = \eta e_r h_\varphi. \quad (7)$$

From (7) we find the total energy flux through the cross section of the wave

$$\bar{S}_z = \frac{c}{4\pi} \iint_{r,\varphi} (e_r h_\varphi dr \cdot d\varphi) = \frac{c}{2} \int_0^R (e_r h_\varphi dr). \quad (8)$$

This integral is independent of time. Therefore, when condition (6) is satisfied, the energy flux of the electromagnetic wave is constant in time.

4. Solving Maxwell's equations

The next task is to find the form of the functions $e_r, h_\varphi, e_\varphi, h_r$, satisfying the system of equations (1-8) and condition (3.6). Before looking for solutions, it should be noted that Maxwell's equations can have many solutions (like any system of partial differential equations). Some of these solutions violate obvious physical requirements, in particular, the fulfillment of the law of conservation of energy. For example, the well-known solution in the form of a wave function, as is known, violates this one (in this solution it is preserved only on average in time, which contradicts the very spirit of this law).

In Chapter 1, a solution was found in which the amplitudes of the magnetic and electrical intensities in cylindrical coordinates r, φ, z have the following form:

$$|E| = Ar^\beta, \quad (1)$$

where A are some constants, β is a linear function of r .

In this solution, the law of conservation of energy is fulfilled. But there is another drawback - such solutions are applicable only when the parameter r is limited:

$$0 < r < \infty. \quad (2)$$

5. Second solution of Maxwell's equations

At present, the applicability of Maxwell's equations to all phenomena of electrodynamics and electrical devices without exception is indisputable. Consequently, there must be such a solution of Maxwell's equations for an electromagnetic wave in a vacuum, where there are no infinite strengths.

This solution is obtained in chapter 97.3. It is obtained by a simple transformation of the solution considered above. For this, a function $\alpha = \alpha(r)$ is found such that the function $e_r(r)$ cannot take infinite values. This function has the form

$$\alpha(r) = 1 + (\alpha_o - 1)(1 - \exp(-\sigma r)). \quad (8)$$

where

$$\left. \begin{array}{l} \sigma > 0, \text{ if } \alpha_o < 0 \\ \sigma < 0, \text{ if } \alpha_o > 0 \end{array} \right\} \quad (9)$$

Fig. 1 shows functions (8) for different values of α_o, σ, R (the value of R is the maximum value on the abscissa).

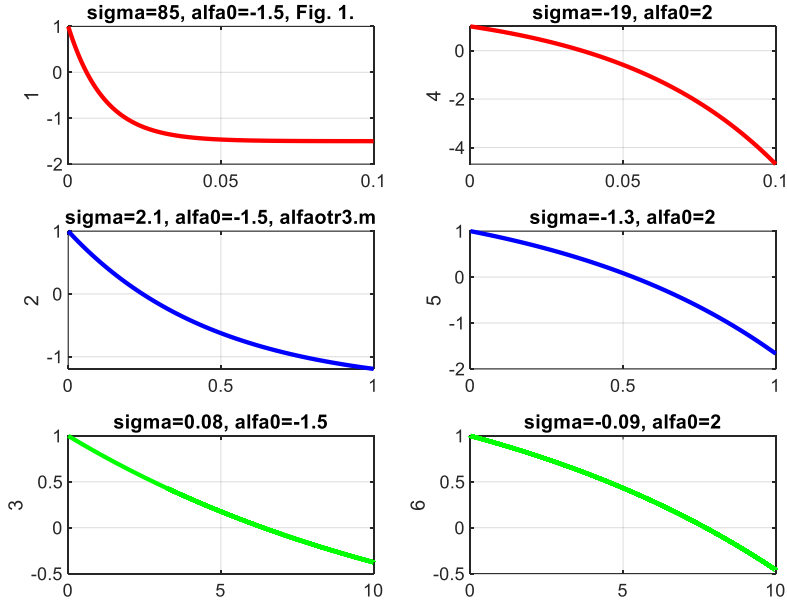

From (3.7, 6, 4.6) we find the density of the flux of electromagnetic energy at a given radius

$$S(r) = \frac{c}{4\pi} \sqrt{\frac{\epsilon}{\mu}} e_r^2(r). \quad (14)$$

and then, according to (3.8), the energy flux in a cylinder of radius R:

$$\bar{S}_z = \frac{c}{4\pi} \iint_{r,\varphi} (S(r) dr \cdot d\varphi) \quad (15)$$

or

$$\bar{S}_z = \frac{c}{2} \sqrt{\frac{\epsilon}{\mu}} \int_0^R (S_0(r) dr), \quad (16)$$

where

$$S_0(r) = (re_r^2). \quad (17)$$

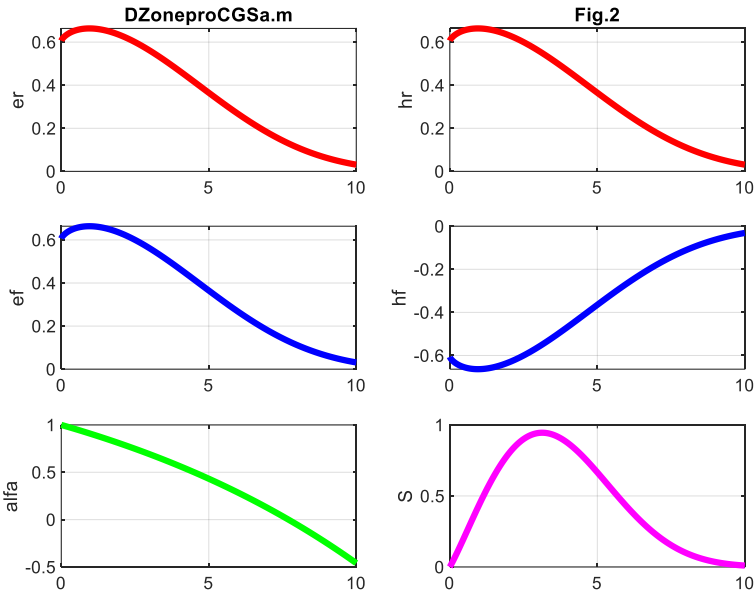

In fig. 2 shows the functions $\alpha(r)$, $e_r(r)$, $S_0(r)$ - see (8, 6, 17) for $R = 10$, $\sigma = -0.09$, $\alpha_0 = 2$, $A = 1$. It is seen that the functions $e_r(r)$, $S_0(r)$ take zero values for $r > R$. This means that an electromagnetic wave exists in the volume of a cylinder with a certain radius. It makes sense to call such a wave a cylindrical wave.

Some reader will exclaim: "Ha! The wave function is known in which there are no additional parameters. And here a solution is proposed in which you need to select some parameters. Who is looking for and installing them? "

My answer is this. The wave function arises as a solution to Maxwell's equations. The reason for this state of affairs is still unknown to us. But our confidence that our function exists is justified by the fact that it is a solution to Maxwell's equations and nothing more. Therefore, it can be argued that any solution of Maxwell's equations is realized physically under condition (3.6) - whatever this solution may be.

It turns out that the wave function cannot exist physically, but there are various other functions, less elegant, but existing physically.

Thus, there is a solution to Maxwell's equations that describe a cylindrical wave.

Chapter 2. Solution of Maxwell's Equations for Electromagnetic Wave in the Dielectric Circuit of Alternating Current in cylindrical coordinates

Contents

1. Introduction
2. Solution of Maxwell's Equations
- 3 UHP-theorem
4. Invertibility of the solution
5. Polychromatic solution of the set of equations
6. Another way to solve Maxwell's equations for a vacuum

1. Introduction

An electromagnetic field in a vacuum is considered in Chapter 1. The evident solution obtained in Chapter 1 is extended to a nonconducting dielectric medium with certain dielectric permittivity ϵ and magnetic permeability μ , respectively. Therefore, the electromagnetic field does also exist in a capacitor as well. However, a considerable difference of the capacitor is that its field has along one of the coordinates a nonzero electrical field strength induced by an external source. The electromagnetic field in a vacuum was examined on the basis of an assumption that an external source was absent.

The same can be said about an alternating current dielectric circuit. The set of Maxwell's equations is applied to such a circuit. It is shown that an electromagnetic wave is also formed in this circuit. An important difference between this wave and the wave in a vacuum is that the former has a longitudinal electrical field strength induced by an external power source.

Below it is considered the Maxwell equations of the following form written in the GHS system (as in Chapter 1 but with ϵ and μ that are not equal to 1):

$$\operatorname{rot}(E) + \frac{\mu}{c} \frac{\partial H}{\partial t} = 0, \quad (1)$$

$$\operatorname{rot}(H) - \frac{\epsilon}{c} \frac{\partial E}{\partial t} = 0, \quad (2)$$

$$\operatorname{div}(E) = 0, \quad (3)$$

$$\operatorname{div}(H) = 0, \quad (4)$$

where H, E are the magnetic field strength and the electrical field strength, respectively.

2. Monochromatic Solution of Maxwell's Equations

Let us consider solution to the Maxwell equations. In the cylindrical coordinate system r, ϕ, z , these equations can be rewritten in the following forms:

$$\frac{E_r}{r} + \frac{\partial E_r}{\partial r} + \frac{1}{r} \cdot \frac{\partial E_\phi}{\partial \phi} + \frac{\partial E_z}{\partial z} = 0, \quad (1)$$

$$\frac{1}{r} \cdot \frac{\partial E_z}{\partial \phi} - \frac{\partial E_\phi}{\partial z} = \frac{\mu}{c} \frac{dH_r}{dt}, \quad (2)$$

$$\frac{\partial E_r}{\partial z} - \frac{\partial E_z}{\partial r} = \frac{\mu}{c} \frac{dH_\phi}{dt}, \quad (3)$$

$$\frac{E_\phi}{r} + \frac{\partial E_\phi}{\partial r} - \frac{1}{r} \cdot \frac{\partial E_r}{\partial \phi} = \frac{\mu}{c} \frac{dH_z}{dt}, \quad (4)$$

$$\frac{H_r}{r} + \frac{\partial H_r}{\partial r} + \frac{1}{r} \cdot \frac{\partial H_\phi}{\partial \phi} + \frac{\partial H_z}{\partial z} = 0, \quad (5)$$

$$\frac{1}{r} \cdot \frac{\partial H_z}{\partial \phi} - \frac{\partial H_\phi}{\partial z} = \frac{\varepsilon}{c} \frac{dE_r}{dt}, \quad (6)$$

$$\frac{\partial H_r}{\partial z} - \frac{\partial H_z}{\partial r} = \frac{\varepsilon}{c} \frac{dE_\phi}{dt}, \quad (7)$$

$$\frac{H_\phi}{r} + \frac{\partial H_\phi}{\partial r} - \frac{1}{r} \cdot \frac{\partial H_r}{\partial \phi} = \frac{\varepsilon}{c} \frac{dE_z}{dt}, \quad (8)$$

where E_r, E_ϕ, E_z are the components of the electrical field strength, H_r, H_ϕ, H_z are the components of the magnetic field strength. The solution must be found at non-zero strength E_z . In this case, a non-zero strength H_z also appears. The solution to this problem is given in chapter 97.2.1 and looks like this:

$$H_r = h_r(r) \operatorname{co}, \quad (9)$$

$$H_\phi = h_\phi(r) \operatorname{si}, \quad (10)$$

$$H_z = h_z(r) \operatorname{si}, \quad (11)$$

$$E_r = e_r(r) \operatorname{si}, \quad (12)$$

$$E_\phi = e_\phi(r) \operatorname{co}, \quad (13)$$

$$E_z = e_z(r) \operatorname{co}, \quad (14)$$

$$\operatorname{co} = \cos(\alpha\phi + \chi z + \omega t), \quad (15)$$

$$\operatorname{si} = \sin(\alpha\phi + \chi z + \omega t), \quad (16)$$

where $h(r), e(r)$ are function of the coordinate r and α, χ, ω are constants. At this stage, the constants α and ω are considered known, the constant

$$\chi = \frac{\omega}{c} \sqrt{\mu \epsilon}. \quad (17)$$

Unknown functions are defined as follows. First, the function is calculated

$$e_z = Ar^\alpha, \quad (17)$$

where A is some constant. For a given function e_z , the derivative of the function e_r is determined in the form

$$\dot{e}_r = -\frac{e_r}{r} (1 - \alpha) + \left(\frac{\alpha^2}{2\chi r^2} + \chi \right) e_z, \quad (18)$$

and then the e_r function itself. After that, the function is defined

$$e_\varphi = e_r - \frac{\dot{e}_z}{2\chi}. \quad (19)$$

The functions h_r, h_φ, h_z are determined by formulas of the form

$$h_r = k e_r, \quad (21)$$

$$h_\varphi = -k e_\varphi, \quad (22)$$

$$h_z = -k e_z, \quad (23)$$

where

$$k = \sqrt{\frac{\epsilon}{\mu}}. \quad (24)$$

Equalities (21-23) were taken as an assumption when solving the problem in Chapter 97.2.1, and as a result of the solution, the value of the constant (24) was found. Consider the rationale behind this assumption.

Also, as in Chapter 1, the energy flux densities by coordinates are determined by the following formula:

$$S = \begin{bmatrix} S_r \\ S_\varphi \\ S_z \end{bmatrix} = \eta (E \times H) = \eta \begin{bmatrix} E_\varphi H_z - E_z H_\varphi \\ E_z H_r - E_r H_z \\ E_r H_\varphi - E_\varphi H_r \end{bmatrix}. \quad (25)$$

or, taking into account the previous formulas,

$$S_r = \eta (e_\varphi h_z - e_z h_\varphi) \text{co} \cdot \text{si} \quad (26)$$

$$S_\varphi = \eta (e_z h_r \text{co}^2 - e_r h_z \text{si}^2) \quad (27)$$

$$S_z = \eta (e_r h_\varphi \text{si}^2 - e_\varphi h_r \text{co}^2) \quad (28)$$

Further, it will be shown that these energy flux densities satisfy the energy conservation law if the following equalities are true (21-23).

It follows from (26, 22, 23) that

$$S_r = \eta(-e_\varphi k e_z + k e_z e_\varphi) \cos \varphi \cdot \sin \varphi = 0, \quad (29)$$

i.e. there is no radial flow of energy.

It follows from (27, 21, 23) that

$$S_\varphi = \eta k e_r e_z (\cos^2 \varphi + \sin^2 \varphi) = \eta k e_r e_z, \quad (30)$$

i.e. the energy flux density along the circumference at a given radius does not depend on time and other coordinates.

It follows from (28, 21, 22) that

$$S_z = \eta k e_r e_\varphi (\sin^2 \varphi + \cos^2 \varphi) = \eta k e_r e_\varphi, \quad (31)$$

i.e. the energy flux density along the vertical for a given radius is independent of time and other coordinates. These statements were the purpose of the assumptions (21-23).

We calculate the total longitudinal energy flux S_z taking into account the above formulas:

$$\bar{S}_z = \iint_{\varphi, r} (S_z \cdot r \cdot d\varphi \cdot dr) = \iint_{\varphi, r} (\eta k r e_r e_\varphi d\varphi \cdot dr)$$

or

$$\bar{S}_z = \frac{c}{2\pi} \sqrt{\frac{\varepsilon}{\mu}} \int_0^R (r e_r e_\varphi dr) \quad (32)$$

If you set the parameters α, χ, ω and the value of the amplitude of the function e_z , i.e. determine the values $e_z(0) = A, \alpha, \chi, \omega$, then the intensity becomes known

$$E_z = e_z(r) \cos(\alpha \varphi + \chi z + \omega t) \quad (33)$$

at the point $r = 0$.

Function (33) at the point $(r = 0, \varphi = 0, z = 0)$ has the form

$$E_{z0} = A \cos(\omega t). \quad (34)$$

Thus, function (34) determines a monochromatic solution of the set of Maxwell's equations. We shall also find the values of the other parameters at the point

3. UHP-theorem

Regardless of the wire parameters there is an unambiguous relationship among the electrical voltage U on the wire, the longitudinal magnetic intensity H_z in the wire, and the active power P transmitted through the wire.

It was shown above that all functions of the strengths and currents are determined by the values of the following parameters: A, α . Consequently, all functions of strengths and currents are determined by the values of these two parameters: A, α . The values of these two parameters also determine the energy fluxes in equations (2.26-2.28), which depend on the strengths. Therefore, if we set the value of the two quantities from the set

$$E_r, E_\varphi, E_z, H_r, H_\varphi, H_z, S_r, S_\varphi, S_z, \quad (2)$$

then from the given equations, one can find the values of the parameters A, α , and then find the values of the other quantities from set (2).

It is important to emphasize that in a dielectric circuit there is a longitudinal component of the magnetic field strength. By virtue of the limited length of this chain, the lines of the longitudinal magnetic field strength turn out to be unclosed. This is contrary to existing ideas but is confirmed by experiments, see in Chapter 4c. Note that nonclosed lines do end at nonzero strengths' values.

For instance, in set (2), the quantities E_z, S_z are defined. This determines the voltage on the wire with a length L as follows:

$$U = E_z L \quad (3)$$

and active power transmitted over the wire,

$$P = S_z. \quad (4)$$

Then, with known U, P one can find E_z, S_z , from the given equations one can find the values of the parameters A, α , and then find the values of the other quantities from set (2).

Similarly, with the known longitudinal component H_z of the magnetic field strength in the wire and active power (4), it is possible to find the values of the other quantities from set (2).

From this, in particular, it follows that regardless of the wire parameters there is an unambiguous dependence

$$U = f(H, P). \quad (5)$$

In Chapter 4c, an experiment will be described that proves the validity of this theorem.

3. Invertibility of the solution

By virtue of the symmetry of the solution obtained, there is another solution, where instead of the longitudinal component E_z of the electric field strength, the function of the longitudinal component of the magnetic field strength is defined as the value of the amplitude of the time function as follows:

$$H_z = h_z(r)\sin(\alpha \varphi + \chi z + \omega t) \quad (1)$$

at the point $r = 0$; i.e. if we determine the quantities $h_z(0) = A, \alpha, \chi, \omega$.

Find the voltage on the wire with a length L from (2.14):

$$U = \int_0^L E_z dz = e_z \int_0^L \text{co} \cdot dz. \quad (2)$$

Find the magnetomotive force on the wire with a length L from (2.11):

$$F = \int_0^L H_z dz = h_z \int_0^L \text{si} \cdot dz = -ke_z \int_0^L \text{si} \cdot dz, \quad (3)$$

With a large value of L , we have:

$$\int_0^L \text{co} \cdot dz = \int_0^L \text{si} \cdot dz = Q. \quad (4)$$

From (2)-(4) we find:

$$U = e_z Q, \quad (5)$$

$$F = -ke_z Q = -kU. \quad (6)$$

Formula (6) shows the relationship between the external voltage and the external magnetomotive force, which create equal currents in the wire.

5. Polychromatic solution of the set of equations

Obviously, if function (2.33) determines a monochromatic solution of the set of Maxwell's equations, then the following function

$$E_{z0} = \sum_b (A_b \cos(\omega_b t)). \quad (1)$$

determines a polychromatic solution of the set of Maxwell's equations. We denote this function by

$$f(t) = \sum_b (A_b \cos(\omega_b t)). \quad (2)$$

A reversible polychromatic solution is defined by the following function:

$$H_{z0} = \sum_b (A_b \sin(\omega_b t)). \quad (3)$$

We denote this function by

$$y(t) = \sum_b (A_b \sin(\omega_b t)), \quad (4)$$

The coefficients of functions (2) and (3) coincide.

6. Another way to solve Maxwell's equations for a vacuum

In Chapter 1, the solution was found under the assumption that there is no longitudinal electric field strength.

Here, in Chapter 2, the existence of a longitudinal electric field was postulated.

In Chapter 1, the solution was found without any assumptions about the characteristics of the energy fluxes along the coordinate axes. It was found that there is only a longitudinal flow of energy.

Here in Chapter 2, we assumed that there is only a longitudinal energy flow and a circular energy flow. It was much easier to find a solution.

Now we can assume that there is no longitudinal electric field strength and there is only a longitudinal energy flow. These assumptions correspond to the solution found in Chapter 1. However, we will find this solution again, using the method applied here.

To do this, it is sufficient to assume in the formulas obtained that

$$e_z = 0. \quad (1)$$

Then from (2.18) we find:

$$\dot{e}_r + \frac{e_r}{r}(1 - \alpha) = 0 \quad (2)$$

or

$$e_r = Ar^{-(1-\alpha)}, \quad (3)$$

where A is some constant. Then from (2.19) we find:

$$e_\varphi = e_r. \quad (4)$$

Solution (3) and (4) coincides with the solution obtained in Chapter 1.

Chapter 2a. Solution of Maxwell's Equations for Capacitor with Alternating Voltage in Cylindrical Coordinates

Contents

1. Introduction \ 1
2. Solution of the Maxwell's equations \ 2
3. Propagation speed of electromagnetic wave \ 3
4. Energy density \ 3
5. Energy flows \ 3
6. Voltage in the capacitor \ 4
7. Reversibility of the capacitor \ 4
8. Discussion \ 5

1. Introduction

In Chapter 2, a new solution of the Maxwell equations is obtained for a monochromatic wave in a dielectric medium with definite ϵ and μ representing the dielectric permittivity (dielectric constant) and magnetic permeability (magnetic constant) respectively. The main feature of this solution is that the field has a nonzero longitudinal component of the electric field strength created by an external source. When considering the electromagnetic field in a vacuum, the absence of an external source was postulated.

The dielectrics of the capacitor, which is under an alternating voltage, is also such a medium. Therefore, for it the solution obtained in Chapter 2 can be applied without reservations.

According to the existing concept, in the energy flow through the capacitor only the average (in time) value of the energy flux is conserved [3]. The existing solution is such that it assumes a synchronous change in the electric and magnetic intensities of such a field as a function of the radius on the Bessel function, which has zeros along the axis of the argument, i.e. at certain values of the radius. At these points (more precisely - circles of a given radius), the energy of the radial field turns out to be zero [13]. And then it increases with increasing radius ... This contradicts the law of conservation of energy (which has already been discussed above for a traveling wave). Therefore, we propose a new

solution of the Maxwell equations for a capacitor in which the law of conservation of energy is satisfied without exceptions and for each moment of time.

2. Solution of the Maxwell equations

Next, we will use the cylindrical coordinates r, ϕ, z and the solution of the Maxwell equations obtained in Chapter 2. Here we only note the following:

1. There are electrical and magnetic stresses along all the coordinate axes r, ϕ, z . In particular, there is the longitudinal component H_z of the magnetic field strength proportional to the longitudinal component E_z of the electric field strength.
2. The magnetic and electric fields' strengths on each coordinate axis r, ϕ, z are shifted in a phase by a quarter of a period.
3. The vectors of electric and magnetic fields' strengths on each axis of the coordinates r, ϕ, z are orthogonal.

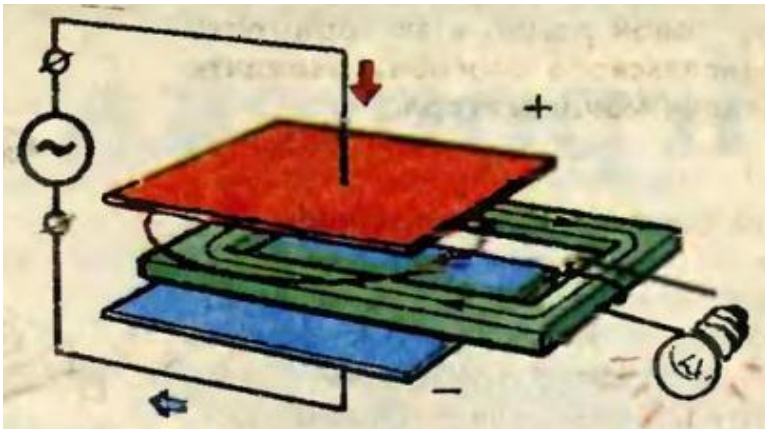

Fig. 1.

In particular, it is important to note that there exists the longitudinal component H_z of the magnetic field strength proportional to the longitudinal component E_z of the electric field strength. This fact is known. For instance, figure 1 shows a capacitor converter that can convert an alternating voltage into an alternating magnetic field strength, which in a magnetic core is converted into an alternating voltage on the winding [117]. However, the author of article [117] published in 1992 cautiously notes that "the work of an externally simple device to this day in its subtleties is not entirely clear."

3. Propagation speed of electromagnetic wave

Obviously, the speed of propagation of an electromagnetic wave is equal to the derivative $\frac{dz}{dt}$ of a function $z(t)$ specified implicitly in the form of functions (2.2.13)-(2.2.18). Having determined this derivative, we find the speed of propagation of the electromagnetic wave as follows:

$$v_m = \frac{dz}{dt} = -\frac{\omega}{\chi}. \quad (1)$$

Chapter 2 shows that

$$\chi = \frac{\omega}{c} \sqrt{\mu\varepsilon}. \quad (2)$$

From (1) and (2) we get:

$$v_m = c/\sqrt{\mu\varepsilon}. \quad (3)$$

We also find the rotation speed of the electromagnetic wave.

Obviously, this velocity is equal to the derivative $\frac{d\varphi}{dt}$ of the function $\varphi(t)$ given implicitly in forms (2.2.13)-(2.2.18). Having determined this derivative, we find the following speed of the rotation of the electromagnetic wave:

$$v_\varphi = \frac{d\varphi}{dt} = \frac{\omega}{\alpha}. \quad (4)$$

4. Density of energy

The energy density is

$$W = \frac{1}{8\pi} (\varepsilon H^2 + \mu E^2) \quad (1)$$

or, taking into account the previous formulas of Chapter 2,

$$W = \frac{\varepsilon}{8\pi} \left((e_r \text{si})^2 + (e_\varphi \text{co})^2 + (e_z \text{co})^2 \right) + \frac{\mu}{8\pi} \left((h_r \text{co})^2 + (h_\varphi \text{si})^2 + (h_z \text{si})^2 \right)$$

or, taking into account equations (2.2.33)-(2.2.35),

$$W = \frac{1}{8\pi} (\varepsilon + k\mu) \left((e_r \text{si})^2 + (e_\varphi \text{co})^2 + (e_z \text{co})^2 \right). \quad (2)$$

Thus, **the energy density of the electromagnetic wave in the capacitor is the same at all points of the cylinder of a given radius.**

5. Energy Flows

The density of the flux of electromagnetic energy in the coordinates r, ϕ, z is found in Chapter 2, see in equations (2.2.36)-(2.2.38), respectively. In the equations, it is shown that

- there is no radial energy flow,

- the energy flux density along the circle at a given radius is independent of time and other coordinates,
- the energy flux density along the vertical for a given radius is independent of time and other coordinates.

The energy flow, which propagates along the z -axis through the cross section of the capacitor, is equal to

$$\vec{S}_z = \iint_{r,\varphi} (S_z dr d\varphi) = \iint_{r,\varphi} (\eta k e_r e_\varphi dr d\varphi) = 2\pi\eta k \int_0^R (e_r e_\varphi dr). \quad (1)$$

This flow represents an active power

$$P = \overline{S}_z, \quad (2)$$

transmitted through the capacitor. There is only simple parameter undefined in the mathematical model of the wave. This is the constant \mathcal{A} in the definition of the function e_z defined in Appendix 4 as follows:

$$e_z = \mathcal{A} r^\beta. \quad (3)$$

With (1) and (2), we find:

$$k = P/2\pi\eta \int_0^R (e_r e_\varphi dr). \quad (4)$$

From formula (2.48c) of Chapter 2 we find:

$$k = \sqrt{\frac{\varepsilon}{\mu}}. \quad (5)$$

Next, with (4) and (5), we find:

$$\sqrt{\frac{\varepsilon}{\mu}} = P/2\pi\eta \int_0^R (e_r e_\varphi dr), \quad (6)$$

In this formula, the functions e_r, e_φ depend on the constant \mathcal{A} because they are determined as dependencies on the function e_z defined by (3). Therefore, the reader can write:

$$e_r = \mathcal{A} \bar{e}_r, e_\varphi = \mathcal{A} \bar{e}_\varphi. \quad (7)$$

Then expression (6) takes the following form:

$$\sqrt{\frac{\varepsilon}{\mu}} = P/2\pi\eta \mathcal{A}^2 \int_0^R (\bar{e}_r \bar{e}_\varphi dr) \quad (8)$$

or

$$\mathcal{A}^2 = P / \left(2\pi\eta \sqrt{\frac{\varepsilon}{\mu}} \int_0^R (\bar{e}_r \bar{e}_\varphi dr) \right) \quad (9)$$

6. Voltage in the capacitor

It follows from (2.2.18) that

$$E_z = e_z(r) \cos(\alpha \varphi + \chi z + \omega t). \quad (1)$$

We assume that the electrical potential on the lower plate is equal to zero for $z = 0$ and for some φ_o, r_o , and the potential on the upper plate for $z = d$ and for the same number φ_o, r_o is numerically equal to the voltage U across the capacitor. Then

$$U = e_z(r_o)\cos(\alpha \varphi_o + \chi d + \omega t). \quad (2)$$

At some intermediate value of z , the voltage for the same φ_o, r_o will be equal to

$$u(z) = e_z(r_o)\cos(\alpha \varphi_o + \chi z + \omega t), \quad (3)$$

i.e. the voltage along the capacitor varies according to function $\cos(\chi z)$.

7. Reversibility of the capacitor

At a certain external voltage between the plates (i.e. at a given value of the component of the electrical field strength, E_z) the component H_z of the magnetic field strength appears in the capacitor, see in Chapter 2.3. Above we consider a capacitor, in which the external voltage between the plates is determined. Similarly, we can consider a capacitor, in which the magnetic parameter H_z is given. In this case (due to the reversibility of the solution of the set of Maxwell's equations, see in Chapter 2.3) the electric component E_z also appears in the capacitor, i.e. on the capacitor plates there is a voltage. Such a capacitor can be considered as a converter of alternating magnetic induction into an alternating electric voltage.

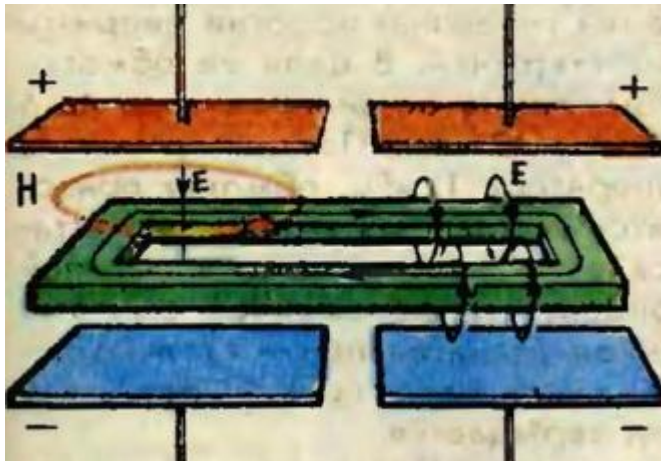

Fig. 2.

The "Mislavsky transformer" invented by a student of the 7th class in 1992 is known, where this conversion of electrical field strength into magnetic induction is performed explicitly in the body of the capacitor, see in Figure 2 [117, 118]. In this transformer, the electrical field strength is transformed into the magnetic field strength (see the left-hand side in Figure 2) and the reverse transformation of the magnetic field strength into the electrical field strength (see the right-hand side in Figure 2).

Thus, this experiment illustrates the reversibility of a capacitor.

8. Discussion

The proposed solution of Maxwell's equations for a capacitor under an alternating voltage is interpreted as an electromagnetic wave. We note the following features of this wave:

1. There are electrical and magnetic intensities along all the coordinate axes r , φ , z . In particular, there is the longitudinal component H_z of the magnetic field strength proportional to the longitudinal component E_z of the electric field strength.
2. The magnetic and electrical fields' strengths on each coordinate axis r , φ , z are shifted in a phase by a quarter of a period.
3. The vectors of the electric and magnetic fields' strengths on each axis of the coordinates r , φ , z are orthogonal.
4. The instantaneous (rather than the average over a certain period) energy flow through the capacitor does **not** change in time, which corresponds to the law of conservation of energy.
5. The energy flow along the axis of the capacitor is equal to the active power transmitted through the capacitor.
6. The speed of propagation of an electromagnetic wave is less than the speed of light.
7. This speed decreases with increasing transmission power (in particular, in the absence of power, the velocity is equal to zero and the wave becomes stationary).
8. The longitudinal component E_z of the electric field strength varies according to the modified Bessel function in dependence on the radius.
9. All other electric and magnetic fields' strengths also depend on the radius and vary according to the modified Bessel function or its derivative.
10. The wave propagates also along the radii.
11. The energy flux along the radius is absent on any radius. We note that this conclusion contradicts with the well-known assertion [13] that there exist radii, along which the flow exists.

12. There is an electromagnetic momentum proportional to the square of the active power transmitted through the capacitor.
13. The capacitor is reversible in the sense that at a certain external voltage between the plates (i.e. at a given value of the component of the electrical field strength, E_z) the component H_z of the magnetic field strength appears in the capacitor, and for a certain external induction between the plates (i.e. at a given value of the magnetic parameter H_z) in the capacitor there is the component of the electrical field strength, E_z . This effect can be used in various designs.

Chapter 2d. Solution of Maxwell's Equations for alternating Voltage Capacitor in Cartesian Coordinates

Contents

1. The solution of the set of Maxwell's equations \ 1
2. Densities of energy flux \ 4

1. The solution of the set of Maxwell's equations

Chapter 2a gives a solution of the Maxwell equations for a capacitor with an alternating voltage in the cylindrical coordinates. Here we consider the capacitor in Cartesian coordinates shown in figure 1.

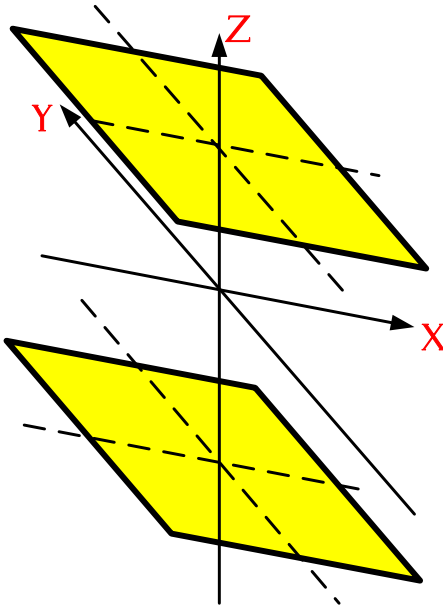

Fig. 1.

2. A partial solution of the set of Maxwell's equations

In the Cartesian coordinate system x, y, z and time t , these equations in the SI system are:

1	$\frac{\partial H_z}{\partial y} - \frac{\partial H_y}{\partial z} - \epsilon \frac{\partial E_x}{\partial t} = 0$	(1)
2	$\frac{\partial H_x}{\partial z} - \frac{\partial H_z}{\partial x} - \epsilon \frac{\partial E_y}{\partial t} = 0$	
3	$\frac{\partial H_y}{\partial x} - \frac{\partial H_x}{\partial y} - \epsilon \frac{\partial E_z}{\partial t} = 0$	
4	$\frac{\partial E_z}{\partial y} - \frac{\partial E_y}{\partial z} + \mu \frac{\partial H_x}{\partial t} = 0$	
5	$\frac{\partial E_x}{\partial z} - \frac{\partial E_z}{\partial x} + \mu \frac{\partial H_y}{\partial t} = 0$	
6	$\frac{\partial E_y}{\partial x} - \frac{\partial E_x}{\partial y} + \mu \frac{\partial H_z}{\partial t} = 0$	
7	$\frac{\partial E_x}{\partial x} + \frac{\partial E_y}{\partial y} + \frac{\partial E_z}{\partial z} = 0$	
8	$\frac{\partial H_x}{\partial x} + \frac{\partial H_y}{\partial y} + \frac{\partial H_z}{\partial z} = 0$	

where E_x, E_y, E_z are the components of the electric field strength, H_x, H_y, H_z are the components of the magnetic field strength. The solution must be found with a nonzero parameter E_z . We will seek a solution in the form of the following functions [45]:

$$E_x(x, y, z, t) = e_x \cosh(\beta y) \cosh(\gamma z + \omega t) \cos(\alpha x), \quad (9)$$

$$E_y(x, y, z, t) = e_y \sinh(\beta y) \cosh(\gamma z + \omega t) \sin(\alpha x), \quad (10)$$

$$E_z(x, y, z, t) = e_z \cosh(\beta y) \sinh(\gamma z + \omega t) \sin(\alpha x), \quad (11)$$

$$H_x(x, y, z, t) = h_x \sinh(\beta y) \sinh(\gamma z + \omega t) \sin(\alpha x), \quad (12)$$

$$H_y(x, y, z, t) = h_y \cosh(\beta y) \sinh(\gamma z + \omega t) \cos(\alpha x), \quad (13)$$

$$H_z(x, y, z, t) = h_z \sinh(\beta y) \cosh(\gamma z + \omega t) \cos(\alpha x), \quad (14)$$

where

$e_x, e_y, e_z, h_x, h_y, h_z$ are the constant amplitudes of the functions,

α, β, λ are the constants,

ω is the angular frequency.

Differentiating equations (9)-(14) and substituting the result in equations (1)-(8) after reduction by common factors, we obtain:

$h_z\beta - h_y\gamma - \omega\epsilon e_x = 0$	(15)
$h_x\gamma + h_z\alpha - \omega\epsilon e_y = 0$	(16)
$-h_y\alpha - h_x\beta - \omega\epsilon e_z = 0$	(17)
$e_z\beta - e_y\gamma + \omega\mu h_x = 0$	(18)
$e_x\gamma - e_z\alpha + \omega\mu h_y = 0$	(19)
$e_y\alpha - e_x\beta + \omega\mu h_z = 0$	(20)
$e_x\alpha + e_y\beta + e_z\gamma = 0$	(21)
$h_x\alpha + h_y\beta + h_z\gamma = 0$	(22)

The set of eight equations (15)-(22) with known values of e_z and ω contains the following eight unknowns:

$$e_x, e_y, h_x, h_y, h_z, \alpha, \beta, \lambda.$$

First, we consider the set of five linear equations (15)-(19) with respect to the following five unknowns: e_x, e_y, h_x, h_y, h_z . Solving this set, we find these unknowns. Then we substitute the found values into equations (20)-(22) and obtain a set of three linear equations with respect to the three unknowns α, β, λ . Thus, the original set of equations (15)-(22) will be solved.

A solution always exists.

2. Energy flux densities

Density of energy flux in the coordinates $\{x, y, z\}$ is determined by the following formula:

$$S = \begin{bmatrix} S_x \\ S_y \\ S_z \end{bmatrix} = (E \times H) = \begin{bmatrix} E_y H_z - E_z H_y \\ E_z H_x - E_x H_z \\ E_x H_y - E_y H_x \end{bmatrix} \quad (23)$$

or, taking into account formulas (9)-(14), it is possible to write down

$$S_x = (e_y h_z \Psi_{yz} - e_z h_y \Psi_{zy}) \quad (24)$$

$$S_y = (e_z h_x \Psi_{zx} - e_x h_z \Psi_{xz}) \quad (25)$$

$$S_z = (e_x h_y \Psi_{xy} - e_y h_x \Psi_{yx}) \quad (26)$$

where the coefficients Ψ are determined from (9)-(14). For instance,

$$\Psi_{xy} = \cosh(\beta y) \cosh(\gamma z + \omega t) \cos(\alpha x) \cdot \cosh(\beta y) \sinh(\gamma z + \omega t) \cos(\alpha x)$$

or

$$\Psi_{xy} = 0.5 \cosh^2(\beta y) \sinh^2(2(\gamma z + \omega t)) \cos^2(\alpha x). \quad (27)$$

Similarly

$$\Psi_{yx} = \sinh(\beta y) \cosh(\gamma z + \omega t) \sin(\alpha x) \cdot \sinh(\beta y) \sinh(\gamma z + \omega t) \sin(\alpha x)$$

or

$$\Psi_{xy} = 0.5 \text{Sh}^2(\beta y) \text{Sh}^2(2(\gamma z + \omega t)) \sin^2(\alpha x). \quad (28)$$

This means that there are energy flows along all axes of the capacitor. It also means that energy flows through the capacitor. Consider, for example, the cross-section xy for $z = z_1$. In this section, the energy flux density \mathcal{S}_z is determined by function (26) with (27) and (28). The energy flow of the entire section is determined by the integral of this function over the entire area of this section.

It is important to note that this flow does not change the internal energy of the capacitor. This flow is the active power that passes through the capacitor along the z -axis. On other faces of the capacitor, there may also be energy flows that emit energy subtracted from the energy.

Chapter 2h. Solving Maxwell's equations for a conductive dielectric in cylindrical coordinates

Contents

1. Introduction
2. Solution of Maxwell's Equations
3. Stermer's paradox

1. Introduction

Chapter 2 obtained a solution to Maxwell's equations for alternating current in a dielectric circuit, which was used in Chapter 2a for an alternating current capacitor. Here we consider an electrically conductive AC capacitor, which has a certain dielectric permeability ϵ and magnetic permeability μ , as well as a finite electrical resistivity ρ . In this case, not only displacement currents are present in the capacitor, but also conduction currents I , and Maxwell's equations in the CGS system take the form

$$\operatorname{rot}(E) + \frac{\mu}{c} \frac{\partial H}{\partial t} = 0, \quad (1)$$

$$\operatorname{rot}(H) - \frac{\epsilon}{c} \frac{\partial E}{\partial t} - I = 0, \quad (2)$$

$$\operatorname{div}(E) = 0, \quad (3)$$

$$\operatorname{div}(H) = 0. \quad (4)$$

2. Solution of Maxwell's Equations

В системе цилиндрических координат r, ϕ, z эти уравнения имеют вид:

$$\frac{E_r}{r} + \frac{\partial E_r}{\partial r} + \frac{1}{r} \cdot \frac{\partial E_\phi}{\partial \phi} + \frac{\partial E_z}{\partial z} = 0, \quad (1)$$

$$\frac{1}{r} \cdot \frac{\partial E_z}{\partial \phi} - \frac{\partial E_\phi}{\partial z} = \frac{\mu}{c} \frac{dH_r}{dt}, \quad (2)$$

$$\frac{\partial E_r}{\partial z} - \frac{\partial E_z}{\partial r} = \frac{\mu}{c} \frac{dH_\phi}{dt}, \quad (3)$$

$$\frac{E_\phi}{r} + \frac{\partial E_\phi}{\partial r} - \frac{1}{r} \cdot \frac{\partial E_r}{\partial \phi} = \frac{\mu}{c} \frac{dH_z}{dt}, \quad (4)$$

$$\frac{H_r}{r} + \frac{\partial H_r}{\partial r} + \frac{1}{r} \cdot \frac{\partial H_\phi}{\partial \phi} + \frac{\partial H_z}{\partial z} = 0, \quad (5)$$

Chapter 2h. Solving Maxwell's equations for a conductive dielectric in cylindrical coordinates

$$\frac{1}{r} \cdot \frac{\partial H_z}{\partial \phi} - \frac{\partial H_\phi}{\partial z} = \frac{\varepsilon}{c} \frac{dE_r}{dt} + I_r, \quad (6)$$

$$\frac{\partial H_r}{\partial z} - \frac{\partial H_z}{\partial r} = \frac{\varepsilon}{c} \frac{dE_\phi}{dt} + I_\phi, \quad (7)$$

$$\frac{H_\phi}{r} + \frac{\partial H_\phi}{\partial r} - \frac{1}{r} \cdot \frac{\partial H_r}{\partial \phi} = \frac{\varepsilon}{c} \frac{dE_z}{dt} + I_z. \quad (8)$$

These equations differ from the corresponding equations of Chapter 2 only by the additional terms of form $\frac{\varepsilon}{c} \frac{dE}{dt}$ in equations (6-8). We will search for unknown functions in the following form:

$$H_r = h_r(r) \text{co}, \quad (10)$$

$$H_\phi = h_\phi(r) \text{si}, \quad (11)$$

$$H_z = h_z(r) \text{si}, \quad (12)$$

$$E_r = e_r(r) \text{si}, \quad (13)$$

$$E_\phi = e_\phi(r) \text{co}, \quad (14)$$

$$E_z = e_z(r) \text{co}, \quad (15)$$

$$I_r = i_r(r) \text{co}, \quad (16)$$

$$I_\phi = i_\phi(r) \text{si}, \quad (17)$$

$$I_z = i_z(r) \text{si}, \quad (18)$$

where

$$\text{co} = \cos(\alpha\varphi + \chi z + \omega t), \quad (19)$$

$$\text{si} = \sin(\alpha\varphi + \chi z + \omega t). \quad (20)$$

Эта система уравнений имеет решение, являющееся суммой решений, полученных в главе 2 и главе 2р. Общая часть этих решений имеет вид

$$\chi = k\mu\omega/c \quad (21)$$

$$e_z = Ar^\alpha, \quad (22)$$

$$\dot{e}_r = -\frac{e_r}{r}(1 - \alpha) + \left(\frac{\alpha^2}{2\chi r^2} + \chi\right) e_z, \quad (23)$$

$$e_\phi = e_r - \frac{\dot{e}_z}{2\chi}, \quad (24)$$

$$h_r = ke_r, \quad (25)$$

$$h_\phi = -ke_\phi. \quad (26)$$

$$h_z = -ke_z. \quad (27)$$

Различие состоит в виде функций, приведенных в табл. 1

Thus, displacement currents and conduction currents exist in an electrically conductive capacitor. Wherein

- electrical tensions are antiphase to magnetic strengths,
- conduction currents are in phase with electrical strengths
- displacement currents are in phase with magnetic strengths.

Table 1.

	χ	k	$v_m = \frac{\omega}{\chi}$
Chapter 2	$\frac{\omega}{c} \sqrt{\mu\epsilon}$	$\sqrt{\frac{\epsilon}{\mu}}$	$v_{mA} = \frac{c}{\sqrt{\epsilon\mu}}$
Chapter 2p	$\sqrt{\frac{\mu\omega}{\rho c}}$	$\sqrt{\frac{c}{\rho\mu\omega}}$	$v_{mB} = \sqrt{\frac{\rho\omega c}{\mu}}$

However, in our case, inphase and antiphase have a broader meaning in comparison with the known concepts. Namely, in our case, in-phase means that two in-phase functions both depend

- from $\cos(\alpha\varphi + \chi z + \omega t)$ or from $\sin(\alpha\varphi + \chi z + \omega t)$, whereas in the known representations two in-phase functions both depend
- from $\cos(\omega t)$ or from $\sin(\omega t)$.

3. Stermer's paradox

The solutions differ in the values of χ , k and, as a consequence of equations (21-27), in the form of the strength functions. This means that there are two electromagnetic waves. These waves travel at different speeds. Chapter 1 shows that the speed of propagation of a monochromatic electromagnetic wave

$$v_m = \frac{\omega}{\chi}.$$

Applying this formula to the values given in table 1, we find for two waves of reactive and active currents. Let's find a relationship

$$\frac{v_{mA}}{v_{mB}} = \frac{c}{\sqrt{\epsilon\mu}} / \sqrt{\frac{c\rho\omega}{\mu}} = \sqrt{\frac{c}{\epsilon\rho\omega}}.$$

It follows from the foregoing that a radio signal propagating in an electrically conductive medium consists of two signals: one of them (signal A) propagates at the speed of light v_{mA} , and the other (signal B) - at a speed of $v_{mB} \ll v_{mA}$. If these signals can return and be received at the point of emission, then the observer will detect two signals: an echo of signal A and an echo of signal B. The observer is unlikely to pay attention to the echo of signal A, because it returned instantly and

merged with the signal A. But the echo of signal B, which coincides in shape with signal A, will be perceived by the observer as an echo of signal A. "What did signal A reflect from and why did it not return for so long?!" - the observer will exclaim.

Such cases are known [171, 172]. I mean "Stermer's paradox", "world echo", "long delayed echoes" (LDE) - radio echo with very long delays. "Unlike the known echoes with delays of a fraction of a second, the mechanism of which has long been explained, delays of radio signals in seconds, tens of seconds and even minutes remain one of the oldest and most intriguing mysteries of ionospheric physics."

Here is another description of one of the experiments at sea [173]: "... in the 1960s, a group of scientists from the Naval Research Directorate conducted tests in the field of long-distance underwater communications (*signal transmission in an electrically conductive medium*). A mile long antenna was laid along the continental shelf ... When we got down to work, everyone was stunned by the fact that the ship first received a signal (echo of signal A), then its repetition (*echo of signal B*) ...".

Chapter 2p. Solving Maxwell's Equations for AC Wire

Annotation

It is indicated that an electromagnetic wave propagates in an AC wire. The well-known solution of Maxwell's equations in the form of a wave equation is not acceptable, if only because in such a solution the law of conservation of energy is fulfilled only on average.

Contents

1. Introduction
2. Solving Maxwell's Equations
3. Energy flows

1. Introduction

At present, the applicability of Maxwell's equations to all phenomena of electrodynamics and electrical devices without exception is indisputable. However, it is not always possible to describe these phenomena and devices in the form of a solution to the complete system of Maxwell's equations, and not a certain subset of this system. The same applies to the AC wire. Below, an electromagnetic wave in an alternating current wire is described as a solution to the full system of Maxwell's equations. It is important to note that the well-known solution of Maxwell's equations in the form of a wave equation is not acceptable, if only because in such a solution the energy conservation law is fulfilled only on average.

Maxwell's equations for vacuum cannot be used directly for AC wire, since the wire has conduction currents and dielectric constant. In the case under consideration, Maxwell's equations have the form:

$$\operatorname{rot}(E) + \frac{\mu}{c} \frac{\partial H}{\partial t} = 0, \quad (1)$$

$$\operatorname{rot}(H) - I = 0, \quad (2)$$

$$\operatorname{div}(E) = 0, \quad (3)$$

$$\operatorname{div}(H) = 0, \quad (4)$$

$$\operatorname{div}(I) = 0, \quad (5)$$

where E is electric strengths, H is magnetic strengths, I is conduction currents, μ - absolute magnetic permeability.

2. Solving Maxwell's Equations

In the system of cylindrical coordinates, these equations have the form:

$$\frac{E_r}{r} + \frac{\partial E_r}{\partial r} + \frac{1}{r} \cdot \frac{\partial E_\phi}{\partial \phi} + \frac{\partial E_z}{\partial z} = 0, \quad (1)$$

$$\frac{1}{r} \cdot \frac{\partial E_z}{\partial \phi} - \frac{\partial E_\phi}{\partial z} = \frac{\mu\omega}{c} \frac{dH_r}{dt}, \quad (2)$$

$$\frac{\partial E_r}{\partial z} - \frac{\partial E_z}{\partial r} = \frac{\mu\omega}{c} \frac{dH_\phi}{dt}, \quad (3)$$

$$\frac{E_\phi}{r} + \frac{\partial E_\phi}{\partial r} - \frac{1}{r} \cdot \frac{\partial E_r}{\partial \phi} = \frac{\mu\omega}{c} \frac{dH_z}{dt}, \quad (4)$$

$$\frac{H_r}{r} + \frac{\partial H_r}{\partial r} + \frac{1}{r} \cdot \frac{\partial H_\phi}{\partial \phi} + \frac{\partial H_z}{\partial z} = 0, \quad (5)$$

$$\frac{1}{r} \cdot \frac{\partial H_z}{\partial \phi} - \frac{\partial H_\phi}{\partial z} = I_r, \quad (6)$$

$$\frac{\partial H_r}{\partial z} - \frac{\partial H_z}{\partial r} = I_\phi, \quad (7)$$

$$\frac{H_\phi}{r} + \frac{\partial H_\phi}{\partial r} - \frac{1}{r} \cdot \frac{\partial H_r}{\partial \phi} = I_z, \quad (8)$$

$$\frac{I_r}{r} + \frac{\partial I_r}{\partial r} + \frac{1}{r} \cdot \frac{\partial I_\phi}{\partial \phi} + \frac{\partial I_z}{\partial z} = 0, \quad (9)$$

We will search for unknown functions in the following form:

$$H_r = h_r(r) \cos, \quad (10)$$

$$H_\phi = h_\phi(r) \sin, \quad (11)$$

$$H_z = h_z(r) \sin, \quad (12)$$

$$E_r = e_r(r) \sin, \quad (13)$$

$$E_\phi = e_\phi(r) \cos, \quad (14)$$

$$E_z = e_z(r) \cos, \quad (15)$$

$$I_r = i_r(r) \cos, \quad (16)$$

$$I_\phi = i_\phi(r) \sin, \quad (17)$$

$$I_z = i_z(r) \sin, \quad (18)$$

where

$$\cos = \cos(\alpha\phi + \chi z + \omega t), \quad (19)$$

$$\sin = \sin(\alpha\phi + \chi z + \omega t). \quad (20)$$

By direct substitution, one can make sure that functions (10-18) transform the system of equations (1-8) with four arguments r, ϕ, z, t into a system of equations with one argument and unknown functions $h(r), e(r), i(r)$. This system of equations is as follows:

$$\frac{e_r(r)}{r} + e_r'(r) - \frac{e_\phi(r)}{r} \alpha - \chi \cdot e_z(r) = 0, \quad (21)$$

$$-\frac{1}{r} \cdot e_z(r) \alpha + e_\phi(r) \chi - \frac{\mu\omega}{c} h_r = 0, \quad (22)$$

$$e_r(r) \chi - e_z'(r) + \frac{\mu\omega}{c} h_\phi = 0, \quad (23)$$

$$\frac{e_\phi(r)}{r} + e_\phi'(r) - \frac{e_r(r)}{r} \cdot \alpha + \frac{\mu\omega}{c} h_z = 0, \quad (24)$$

$$\frac{h_r(r)}{r} + h_r'(r) + \frac{h_\phi(r)}{r} \alpha + \chi \cdot h_z(r) = 0, \quad (25)$$

$$\frac{1}{r} h_z(r) \propto -h_\phi(r) - i_r(r) = 0, \quad (26)$$

$$-h_r(r)\chi - \dot{h}_z(r) - i_\phi(r) = 0, \quad (27)$$

$$\frac{h_\phi(r)}{r} + \dot{h}_\phi(r) + \frac{h_r(r)}{r} \propto -i_z(r) = 0. \quad (28)$$

$$\frac{i_r(r)}{r} + i_r'(r) + \frac{i_\phi(r)}{r} \alpha + \chi \cdot i_z(r) = 0. \quad (29)$$

Next, we introduce into consideration the coefficient k , which connects the functions h and e :

$$h_r = ke_r, \quad (30)$$

$$h_\phi = -ke_\phi. \quad (31)$$

$$h_z = -ke_z. \quad (32)$$

Next, we introduce into consideration the coefficient ρ , which connects the functions i and e :

$$i_r = \frac{1}{\rho} e_r, \quad (32a)$$

$$i_\phi = -\frac{1}{\rho} e_\phi. \quad (32b)$$

$$i_z = -\frac{1}{\rho} e_z, \quad (32c)$$

where ρ is the electrical resistance. We perform the change of variables according to (30-32c) in equations (21-29) and rewrite them

$$\frac{e_r}{r} + \dot{e}_r - \frac{e_\phi}{r} \alpha - \chi e_z = 0, \quad (33)$$

$$-\frac{e_z}{r} \alpha + e_\phi \chi - \frac{\mu\omega}{c} ke_r = 0, \quad (34)$$

$$-\dot{e}_z + e_r \chi - k \frac{\mu\omega}{c} e_\phi = 0, \quad (35)$$

$$\frac{e_\phi}{r} + \dot{e}_\phi - \frac{e_r}{r} \alpha + k \frac{\mu\omega}{c} e_z = 0, \quad (36)$$

$$k \frac{e_r}{r} + k \dot{e}_r + k \frac{e_\phi}{r} \alpha - k \chi e_z = 0, \quad (37)$$

$$-k \frac{e_z}{r} \alpha + ke_\phi \chi - \frac{1}{\rho} e_r = 0, \quad (38)$$

$$k \dot{e}_z - ke_r \chi + \frac{1}{\rho} e_\phi = 0, \quad (39)$$

$$-k \frac{e_\phi}{r} - k \dot{e}_\phi + k \frac{e_r}{r} \alpha + \frac{1}{\rho} e_z = 0, \quad (40)$$

$$\frac{i_r}{r} + i_r' + \frac{i_\phi}{r} \alpha + \chi \cdot i_z = 0. \quad (41)$$

Заметим, что уравнения (29+5) и (33+5) совпадают при

$$\frac{1}{\rho k} = \frac{\mu\omega k}{c}. \quad (42)$$

СЛЕДОВАТЕЛЬНО,

$$k = \sqrt{\frac{c}{\rho\mu\omega}}. \quad (43)$$

Note also that equations (35) and (39) and equations (36) and (40) also coincide under condition (42). Finally, equations (33) and (37) coincide. Thus, equations (37-40) can be excluded from the system of equations. The remaining 4 equations (33-36) are a system of differential equations with 3 unknowns e_r, e_φ, e_z .

This 4 equations (33-36) are solved in Chapter 97 - see Section 2.2, where it is shown that the solution has the form:

$$\chi = k\mu\omega/c, \quad (44)$$

$$e_z = Ar^\alpha, \quad (45)$$

$$\dot{e}_r = -\frac{e_r}{r}(1 - \alpha) + \left(\frac{\alpha^2}{2\chi r^2} + \chi\right) e_z, \quad (46)$$

$$e_\varphi = e_r - \frac{\dot{e}_z}{2\chi}. \quad (47)$$

From (43, 44) we find:

$$\chi = \frac{\mu\omega}{c} \sqrt{\frac{c}{\rho\mu\omega}} = \sqrt{\frac{\mu\omega}{\rho c}} \quad (48)$$

Let's find another voltage on a wire with a length L

$$U = \int_0^L E_z dz = e_z \int_0^L \cos \cdot dz. \quad (49)$$

3. Energy flows

The flux density of electromagnetic energy - the Poynting vector is determined by the formula

$$S = \eta E \times H, \quad (1)$$

where

$$\eta = c/4\pi. \quad (2)$$

In cylindrical coordinates r, ϕ, z , the electromagnetic energy flux density has three components S_r, S_ϕ, S_z directed along the radius, along the circumference, along the axis, respectively. They are determined by the formula

$$S = \begin{bmatrix} S_r \\ S_\phi \\ S_z \end{bmatrix} = \eta(E \times H) = \eta \begin{bmatrix} E_\phi H_z - E_z H_\phi \\ E_z H_r - E_r H_z \\ E_r H_\phi - E_\phi H_r \end{bmatrix}. \quad (3)$$

or, taking into account the previous formulas,

$$S_r = \eta(e_\phi h_z - e_z h_\phi) \cos \cdot \sin, \quad (4)$$

$$S_\phi = \eta(e_z h_r \cos^2 - e_r h_z \sin^2), \quad (5)$$

$$S_z = \eta(e_r h_\varphi \text{si}^2 - e_\varphi h_r \text{co}^2). \quad (6)$$

Substituting here (2.30-2.32, 2.68-2.70), we get:

$$S_r = \eta(-ke_\varphi e_z + ke_z e_\varphi) \text{co} \cdot \text{si}, \quad (7)$$

$$S_\varphi = \eta(ke_z e_r \text{co}^2 + ke_r e_z \text{si}^2) = \eta ke_r e_z, \quad (8)$$

$$S_z = \eta(-ke_r e_\varphi \text{si}^2 - ke_\varphi e_r \text{co}^2) = -\eta ke_r e_\varphi. \quad (9)$$

Given these known densities, the unknowns A and α can be found.

From (3) it follows that the longitudinal energy flux is a consequence of the presence of the strengths $E_r, H_\varphi, H_r, E_\varphi$. But these strengths themselves are a consequence of the appearance of the E_z strength. Indeed, the functions e_r, e_φ are defined through the function e_z - see (2.46, 2.47) and below (2.30, 2.31).

But another case is also possible, when at the beginning of the wire the strengths are $E_r, H_\varphi, H_r, E_\varphi$. Then there is a longitudinal flow of energy. The consequence of the existence of the flow is the EMF, described in Chapter 15 and called there fourth electromagnetic induction. In this case, the strengths and currents arise in the wire, which satisfy the Maxwell equation system.

Chapter 2s. Solving Maxwell's Equations for an AC Solenoid

Contents

1. Introduction
2. Solution of Maxwell's equations
3. Energy

1. Introduction

Consider a solenoid cylindrical coordinate system r, φ, z . In it, the current moves in a spiral. The current can be considered as the movement of current elements. Consequently, the spiral current can be considered as the spiral movement of the current elements. In this case, the trajectory of the current along a spiral along the z axis is described by equations of the form

$$J_r = j_r \sin(\alpha\varphi + \chi z), \quad (1)$$

$$J_\varphi = j_\varphi \cos(\alpha\varphi + \chi z), \quad (2)$$

where J_r, J_φ are current projections, j_r, j_φ are current projection densities, α, χ are some constants. Strengths are associated with currents

$$E_r = \frac{j_r}{\rho} \sin(\alpha\varphi + \chi z), \quad (3)$$

$$E_\varphi = \frac{j_\varphi}{\rho} \cos(\alpha\varphi + \chi z), \quad (4)$$

where ρ is the electrical resistivity of the wire. In the case of alternating current, these formulas take the following form:

$$J_r = j_r \sin(\alpha\varphi + \chi z + \omega t), \quad (5)$$

$$J_\varphi = j_\varphi \cos(\alpha\varphi + \chi z + \omega t), \quad (6)$$

$$E_r = \frac{j_r}{\rho} \sin(\alpha\varphi + \chi z + \omega t), \quad (7)$$

$$E_\varphi = \frac{j_\varphi}{\rho} \cos(\alpha\varphi + \chi z + \omega t). \quad (8)$$

Then the voltage between two points located at opposite ends of any diameter of the solenoid is

$$U = E_\varphi - E_{\varphi+\pi} = \frac{j_\varphi}{\rho} \left\{ \cos(\alpha\varphi + \chi z + \omega t) - \cos((\alpha\varphi + \pi) + \chi z + \omega t) \right\}$$

or

$$U = 2 \frac{j\varphi}{\rho} \cos(\chi z + \omega t). \quad (9)$$

This means that the voltage across any diameter of the solenoid does not depend on the angle φ .

When the strengths (7.8) appear in the vicinity of the solenoid, an electromagnetic field arises. Let us find a solution of Maxwell's equations for vacuum in a cylindrical coordinate system, which meets the specified conditions.

2. Solution of Maxwell's equations

Consider the system of Maxwell's equations for vacuum, which has the form

$$\operatorname{rot}(E) + \frac{\mu}{c} \frac{\partial H}{\partial t} = 0, \quad (a)$$

$$\operatorname{rot}(H) - \frac{\varepsilon}{c} \frac{\partial E}{\partial t} = 0, \quad (b)$$

$$\operatorname{div}(E) = 0, \quad (c)$$

$$\operatorname{div}(H) = 0. \quad (d)$$

Consider the solution to this system of Maxwell equations. In the system of cylindrical coordinates r, φ, z , these equations have the following form:

$$\frac{E_r}{r} + \frac{\partial E_r}{\partial r} + \frac{1}{r} \cdot \frac{\partial E_\varphi}{\partial \varphi} + \frac{\partial E_z}{\partial z} = 0, \quad (1)$$

$$\frac{1}{r} \cdot \frac{\partial E_z}{\partial \varphi} - \frac{\partial E_\varphi}{\partial z} = \frac{\mu}{c} \frac{dH_r}{dt}, \quad (2)$$

$$\frac{\partial E_r}{\partial z} - \frac{\partial E_z}{\partial r} = \frac{\mu}{c} \frac{dH_\varphi}{dt}, \quad (3)$$

$$\frac{E_\varphi}{r} + \frac{\partial E_\varphi}{\partial r} - \frac{1}{r} \cdot \frac{\partial E_r}{\partial \varphi} = \frac{\mu}{c} \frac{dH_z}{dt}, \quad (4)$$

$$\frac{H_r}{r} + \frac{\partial H_r}{\partial r} + \frac{1}{r} \cdot \frac{\partial H_\varphi}{\partial \varphi} + \frac{\partial H_z}{\partial z} = 0, \quad (5)$$

$$\frac{1}{r} \cdot \frac{\partial H_z}{\partial \varphi} - \frac{\partial H_\varphi}{\partial z} = \frac{\varepsilon}{c} \frac{dE_r}{dt}, \quad (6)$$

$$\frac{\partial H_r}{\partial z} - \frac{\partial H_z}{\partial r} = \frac{\varepsilon}{c} \frac{dE_\varphi}{dt}, \quad (7)$$

$$\frac{H_\varphi}{r} + \frac{\partial H_\varphi}{\partial r} - \frac{1}{r} \cdot \frac{\partial H_r}{\partial \varphi} = \frac{\varepsilon}{c} \frac{dE_z}{dt}, \quad (8)$$

where E_r, E_φ, E_z are electrical strengths, H_r, H_φ, H_z are magnetic strengths. The solution to the system of equations (1-8) in the form (9-16) was found in Chapter 2 and has the following form:

$$H_r = h_r(r) \cos, \quad (9)$$

$$H_\varphi = h_\varphi(r) \sin, \quad (10)$$

$$H_z = h_z(r) \text{si}, \quad (11)$$

$$E_r = e_r(r) \text{si}, \quad (12)$$

$$E_\varphi = e_\varphi(r) \text{co}, \quad (13)$$

$$E_z = e_z(r) \text{co}, \quad (14)$$

where

$$\text{co} = \cos(\alpha\varphi + \chi z + \omega t), \quad (15)$$

$$\text{si} = \sin(\alpha\varphi + \chi z + \omega t), \quad (16)$$

and a α, χ, ω are some constants and $h(r), e(r)$ are some functions of the coordinate r . More precisely,

$$e_z = Ar^\alpha, \text{ A is some constant}, \quad (18)$$

$$\dot{e}_r = \frac{e_r}{r}(\alpha - 1) + \left(\frac{\alpha^2}{2\chi r^2} + \chi\right) e_z, \quad (19)$$

$$e_\varphi = e_r - \frac{\dot{e}_z}{2\chi}, \quad (20)$$

$$h_r = ke_r, \quad (21)$$

$$h_\varphi = -ke_\varphi, \quad (22)$$

$$h_z = -ke_z, \quad (23)$$

$$k = \sqrt{\frac{\varepsilon}{\mu}}, \quad (24)$$

$$\chi = \frac{\omega}{c} \sqrt{\mu\varepsilon}. \quad (25)$$

The parameters α and χ are related to the known pitch ϑ of the solenoid winding:

$$\vartheta = \frac{1}{\alpha + \chi}. \quad (26)$$

Note that all quantities in this formula can take positive and negative values. The step sign indicates the direction of rotation of the moving element. In practice, the sign of the step is the result of winding the wire with an inclination of the winding turn to one side or the other (because the plane of the turn cannot be perpendicular to the solenoid axis). The signs of the parameters α, χ affect the sign of the sinusoid in formulas (15, 16). Consequently, the inclination of the winding can affect the sign of the magnetic field strength of the solenoid in different parts of the solenoid - the magnetic field of the solenoid can be asymmetric. I managed to find only one article describing the discovery of the asymmetry of the magnetic field of the solenoid and an unsuccessful search for the causes of this asymmetry [205].

It follows from this solution that there is a nonlinear dependence of the radial magnetic field strength inside the solenoid on the radius. This phenomenon has not been discovered experimentally, but follows from the found solution of Maxwell's equations.

3. Energy

The resulting formulas mean that there is an electromagnetic wave inside the solenoid. As shown in Chapter 2, these equations imply that there is a time-constant energy flow inside a solenoid of radius R

$$\bar{S} = g \int_0^R ((e_r)^2 r \cdot dr), \quad (1)$$

where

$$g = \frac{c}{2} \sqrt{\frac{\epsilon}{\mu}}. \quad (2)$$

The existence of an electromagnetic wave and energy flow inside the solenoid seems to be an obvious fact. Such a flow of energy was not considered, apparently, only because no explanation was found for it within the framework of the existing solution of Maxwell's equations. It is this energy of the solenoid that performs the work of the solenoid, which is considered to be the work of only magnetic forces.

Chapter 3. Solution of Maxwell's Equations for an Alternating Current Magnetic Circuit

Chapter 2 discusses the electromagnetic field in an alternating current dielectric circuit. Similarly, we can consider the electromagnetic field in a magnetic circuit of alternating current. The simplest example of such a circuit is an AC solenoid. However, if in a dielectric circuit there is the longitudinal component of the **electric** field strength created by an external energy source, then in a magnetic circuit there is the longitudinal component of the **magnetic** field strength created by an external energy source and transmitted to the circuit by a solenoid winding.

Using the GHS system, it is possible to consider anew the Maxwell equations of form (2.2.1)-(2.2.8) and the solution of these equations in form (2.2.11)-(2.2.18c), where the functions $h(r)$, $e(r)$, $j(r)$ are defined in Appendix 1 of Chapter 2 for given values of the parameters A, α, χ, ω .

Here, as in Chapter 2, electromagnetic energy fluxes with densities (2.2.36) and (2.2.37) are defined. The flow of electromagnetic energy S_z along the magnetic circuit is equal to the active power P transmitted by the magnetic circuit, namely

$$P = S_z. \quad (1)$$

It is shown in Section 2a of Chapter 2 that if we set the value of two quantities from the following set

$$E_r, E_\varphi, E_z, H_r, H_\varphi, H_z, S_r, S_\varphi, S_z, \quad (2)$$

then from the obtained solution of Maxwell's equations one can find the value of the parameters A, α , and finally find the value of the remaining quantities from set (2).

Let treat, for instance, the following magnetomotive force in a magnetic circuit with the length L :

$$F = H_z L \quad (3)$$

and transmitted by a magnetic circuit,

$$P = S_z. \quad (4)$$

Then with known F and P , it is possible to find H_z and S_z . Next, from the obtained solution of Maxwell's equations, one can find the values of the parameters A, α , and then find the values of the other quantities from set (2).

Further conclusions are similar to those obtained in Chapters 1 and 2. Thus, an electromagnetic wave propagates in a magnetic circuit of a sinusoidal current, and the mathematical description of this wave is a solution of Maxwell's equations. At the same time, the strength and flow of energy spread in such a chain along a helical trajectory.

Such an electromagnetic wave propagates in the magnetic circuit of the transformer. Together with it, the magnetic flux and the flux of electromagnetic energy propagate through a magnetic circuit. It is important to note that the magnitude of the magnetic flux does not change with the load. Consequently, it is the flow of electromagnetic energy that transfers energy from the primary winding to the secondary winding. So, the flow of energy does not depend on the magnetic flux. Here the reader can see an analogy with the transfer of current through an electrical circuit, where the same current can transfer different energy. This issue is discussed in detail in Chapter 5. It shows that the energy flux at a given current density (in the case under consideration, at a given magnetic flux density) the transmitted power can take on virtually any value depending on the values of the quantities χ, α , i.e. on the density of the screw path of the current (in this case, at a given magnetic flux density). Consequently, the transmitted power is determined by the density of the helical trajectory of electromagnetic energy at a fixed magnitude of the magnetic flux.

Chapter 4c. Special Transformers

Contents

1. Introduction \ 1
2. Markov's Transformer \ 1
3. Zatsarinin's Transformer \ 2
4. Pozynich's Transformer \ 3

1. Introduction

In Section 3 of Chapter 2, it is shown that current in a wire can arise not only as a result of an applied alternating voltage U but as a result of an applied external longitudinal magnetomotive force F . For either of these cases, equal currents are generated in the wire if in the SI system there is

$$F = \omega \sqrt{\frac{\varepsilon}{2\mu}} U. \quad (0)$$

In Section 2a of Chapter 2, it is also shown that there is the longitudinal component of the magnetic field strength in the wire with nonclosed lines of this longitudinal component.

2. Markov's Transformer

Markov's transformer is known [150, 151], see in Figure 1. Unlike a conventional transformer, this transformer has an elongated magnetic circuit, two primary windings, and a secondary winding that is wound over the primary windings. The primary windings are turned on and create opposing magnetic fluxes.

According to the new Markov induction law, the magnetic flux in the conductor can be induced simultaneously in both opposite directions. After several years of experimentation and practical research, Markov was able to prove the validity of his theory. He developed a workable transformer based on it and obtained several international patents for his invention. The advantage of the Markov transformers is that they can induce the necessary voltage even from the “worst iron” and can have significantly reduced dimensions.

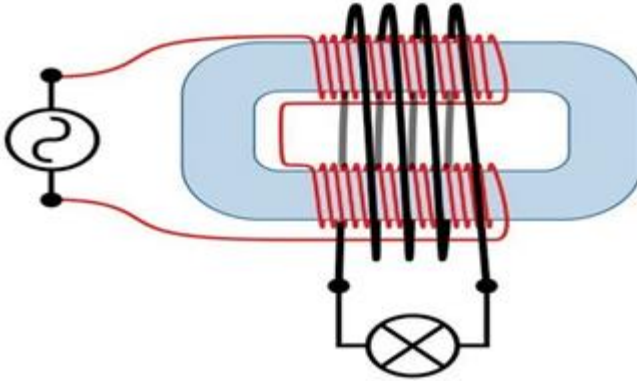

Fig. 1.

According to the existing ideas, the lines of the magnetic field strength should be closed. Opposed windings with an equal number of turns in the Markov transformer do not allow the existence of closed lines of the magnetic field strength. Therefore, they are not at all. This conclusion (the author thinks) forced Markov to create a new theory.

It was stated above that the existence of nonclosed lines of the magnetic field strength is possible. This explains the operation of Markov's transformer.

3. Zatsarinin's Transformer

Zatsarinin's transformer is also known [120]. This transformer is a solenoid, the axis of which is a rod of any conductive material. If the voltage U_1 is applied to the coil of the solenoid, then the voltage U_2 also appears on the rod. The rod can be connected to the load (for example, a lamp) and then the power P_1 from the voltage source U_1 is transferred to the load that consumes power $P_1 < P_2$. Other experiments with the Zatsarinin transformer are also known.

This is the fact that the appearance of voltage in the rod is not a consequence of the law of electromagnetic induction. The magnetic field inside the solenoid does not have the longitudinal component of the magnetic field strength directed perpendicular to the radius. However, in the solenoid there is the longitudinal component of the magnetic field strength and therefore, there is a magnetomotive force F . Zatsarinin's

transformer proves the previous theoretical statement: a current can arise as a result of an applied external longitudinal magnetomotive force F .

4. Pozynich's Transformer

The coaxial transformer of Pozynich (CTP) is also known [121]. In this transformer, the sheath and center wire are included as transformer windings. There are the following two possible inclusion schemes.

1. The central wire is the primary winding of the transformer connected to a voltage source; the shell is the secondary winding of the CTP.

2. The sheath is the central wire is the primary winding of the CTP connected to the voltage source; the central wire is the secondary winding of the package transformer.

In this case, the primary winding of the CTP is connected to a voltage source and the secondary to the load.

Experiments have shown that in both modes, the transformation ratio was equal to 1.

CTP cannot be identified with Zatsarinin's transformer [120] (although the external manifestations are similar). The circuit of the CTP does not coincide with the diagram of the known coaxial transformer because the latter is a two-pole cell but the CTP is a four-pole cell.

As will be shown below, the operation of CTP in mode 2 cannot be explained by the law of electromagnetic induction.

All these features of CTP require some explanation.

In mode 1, in the center wire there is a current with the following density (see in Chapter 4a):

$$J_{zp} = j_{zp} \sin(\alpha \varphi + \chi z + \omega t) \quad (1)$$

In accordance with the law of electromagnetic induction, this current can create the following magnetic field strength in the shell:

$$H_{\varphi o} = \frac{dJ_{zp}}{dt} = \omega j_{zp} \cos(\alpha \varphi + \chi z + \omega t). \quad (2)$$

This strength creates (as shown in Chapter 4b) a longitudinal wave in the shell and, in particular, the following current:

$$J_{zo} = j_{zo} \cos(\alpha \varphi + \chi z + \omega t). \quad (3)$$

Thus, current (1) is transformed into current (3).

In mode 2, the cable jacket is under alternating voltage, i.e. this shell is a tubular wire. The current of the shell as a whole should not

Chapter 4c. Special Transformers

create the magnetic field strength in the center of the pipe because the elementary currents in all cylinder create the strengths that cancel out each other due to symmetry. However, as the experiment shows, the current through the central wire flows. It can only be caused by the magnetic field strength. So, “according to Faraday” there is no magnetic field strength but “according to Pozynich” there is the strength. This requires an explanation.

In mode 2 in the shell, as in a tubular wire there is a current with the following density (see in Chapter 4b):

$$J_{z0} = j_{z0} \sin(\alpha \varphi + \chi z + \omega t) \quad (4)$$

At the same time (as shown in Chapter 4b) in the cavity of the tubular wire creates the following longitudinal component of the magnetic field strength:

$$H_{zp} = h_{zp} \sin(\alpha \varphi + \chi z + \omega t), \quad (5)$$

The central wire is in the area of existence of this strength. This strength (5) creates (as shown in Chapter 4) a longitudinal wave in the wire and, in particular, the following current:

$$J_{zp} = j_{zp} \cos(\alpha \varphi + \chi z + \omega t). \quad (6)$$

Thus, current (4) is transformed into current (6).

This fact (as shown) is not a consequence of the law of electromagnetic induction. In this regard, it should be noted that the Maxwell equations were a generalization of this and some other particular laws. This generalization covers an area of phenomena that is larger than the areas related to each particular law. Therefore, the consequence of Maxwell's equations can describe a phenomenon that is not subject to the law of electromagnetic induction (but cannot contradict this law where it operates).

Consider the mathematical model of CTP in more detail. Maxwell's equations for the center conductor are described in Chapter 2. We will denote the solution of these equations as (E_p, H_p, J_p) . Maxwell's equations for the shell are described in Chapter 4c. We will denote the solution of these equations as (E_o, H_o, J_o) . The sheath and wire are in a common cylindrical area. Therefore, the longitudinal magnetic strengths in the solutions (E_p, H_p, J_p) and (E_o, H_o, J_o) coincide, i.e.

$$H_{pz} = H_{oz} = H_z. \quad (7)$$

Chapter 2 proved the UHP-theorem, which states that regardless of the wire parameters, there is a one-to-one relationship between the

electrical voltage U on the wire, the longitudinal magnetic strength in the wire H , and the active power P transmitted over the wire,

$$U = f(H, P). \quad (8)$$

In our case there is a common strength H on the shell and the central wire, and the power P is transmitted between the shell and the central wire in any switching mode of the CTP. Consequently, the voltage U on the shell and the center wire must be the same in any switching mode CTP.

That is what is observed in the experiments.

Thus, CTP is described by sixteen equations with the following sixteen unknowns:

$$\begin{aligned} &E_{pr}, H_{pr}, J_{pr}, E_{p\varphi}, H_{p\varphi}, J_{p\varphi}, J_{pz}, \\ &E_{or}, H_{or}, J_{or}, E_{o\varphi}, H_{o\varphi}, J_{o\varphi}, J_{oz}, E_z, H_z. \end{aligned} \quad (9)$$

Such a set of equations has a unique solution. This is a set of differential equations (since these are the equations for the wire in Chapter 2). Therefore, the solution depends on the initial conditions.

According to obtained solution (9), the energy flow passing through the CTP can be determined, i.e. power transmitted through the CTP or load power equal to the generator power. Therefore, the initial conditions determine the power of the load.

Physically, of course, everything happens the other way round: the power of the generator determines the initial conditions that determine the type of solution.

Thus, the existence of the listed transformers is another experimental confirmation of the theory developed in this book.

Chapter 5. Solution of Maxwell's Equations for Wire with Constant Current

Contents

1. Introduction \ 1
2. The Mathematical Model \ 3
3. Calculation of currents and strength \ 7
4. Energy Flows \ 9
5. Calculation of all parameters \ 14
6. Speed of energy motion \ 17
7. The speed of energy from the battery \ 18
8. Discussion \ 19

1. Introduction

In [7, 9, 10, 11] based on the Law of impulse conservation, it is shown that a constant electric current in a conductor must have a complex structure. Let us consider first a conductor with the constant current. The current J in the wire creates the magnetic induction B in the body. This induction acts with the Lorentz force F on the electrons with charge q_e moving at an average speed v in the direction opposite to the current J . This action makes the electrons move to the center of the wire. This is shown in Figure 1.

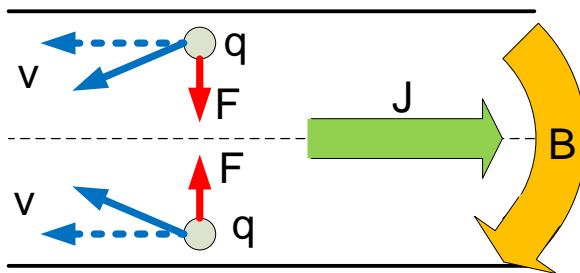

Fig. 1.

Due to the known distribution of the induction B on the wire's cross section, the force F decreases from the wire surface to its center. This is shown in Figure 2. This figure shows the change of F depending on the radius r , on which the electron is located.

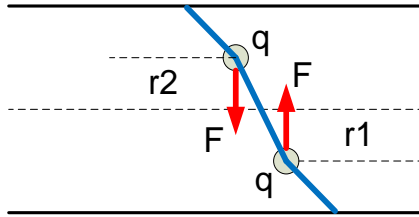

Fig. 2.

Thus, it may be assumed that in the wire's body there exist some elementary currents I , beginning on the axis and directed by the certain angle α to the wire axis. This is shown in Figure 3.

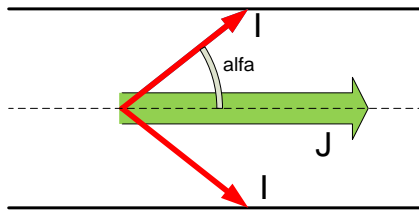

Fig. 3.

In [7, 9, 10, 11], it was also shown that the flow of electromagnetic energy is spreading inside the wire. Also, the electromagnetic flow

- is directed along the wire axis,
- spreads along the wire axis,
- spreads inside the wire,
- compensates the heat losses of the axis component of the current.

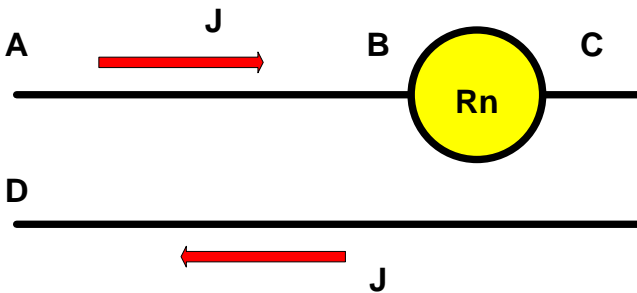

Fig. 4.

In [9-11] a mathematical model of the current and the flow has been. The model was built exclusively on the base of Maxwell's equations. Only one question remained unclear. The electric current J and the flow of electromagnetic energy S are spreading inside the wire ABCD and it is

passing through the load R_n . In this load shown in Figure 4, a certain amount of power P is spent. Therefore, the energy flow on the segment AB should be larger than the energy flow on the segment CD . More accurate, $S_{ab} = S_{cd} + P$. However, the current force after passing the load did not change. How must the current structure be changed in order to decrease the corresponding electromagnetic energy? This issue was considered in [7].

Below we shall consider a mathematical model that is more general model compared to the one in [7, 9, 10, 11]. This model will allow clarification of the aforementioned question. This mathematical model is also built solely on the base of Maxwell's equations. In [12], it was described an experiment carried out in 2008. In [17], it is shown that this experiment can be explained on the basis of nonlinear structure of the constant current in the wire and can serve as an experimental proof of the existence of such a structure.

2. The Mathematical Model

Maxwell's equations for the direct current wire are shown in the introductory chapter, namely see in Variant 6:

$$\text{rot}(J) = 0, \tag{a}$$

$$\text{rot}(H) - J - J_o = 0, \tag{b}$$

$$\text{div}(J) = 0, \tag{c}$$

$$\text{div}(H) = 0. \tag{d}$$

During the building of this model, we shall be using the cylindrical coordinates r, φ, z considering

- the main current with density J_o ,
- the additional currents with density J_r, J_φ, J_z ,
- the magnetic strengths H_r, H_φ, H_z ,
- the electrical field strength E ,
- the electrical resistivity ρ .

Here in these equations, we included a given value of the density J_o of the current passing through the wire as a load. This current creates a magnetic strength $H_{o\varphi}$.

The current in the wire is usually considered as an averaged stream of electrons. The mechanical interactions of electrons with atoms are considered equivalent to electrical resistance. Obviously

$$E = \rho \cdot J. \tag{0}$$

Therefore, equations (a)-(d) for the cylindrical coordinates have the following form:

$$\frac{1}{r} \cdot \frac{\partial H_z}{\partial \phi} - \frac{\partial H_\phi}{\partial z} = J_r, \quad \text{see (b)} \quad (2)$$

$$\frac{\partial H_r}{\partial z} - \frac{\partial H_z}{\partial r} = J_\phi, \quad \text{see (b)} \quad (3)$$

$$\frac{H_\phi + H_{\phi_0}}{r} + \frac{\partial H_\phi}{\partial r} - \frac{1}{r} \cdot \frac{\partial H_r}{\partial \phi} = J_z + J_o, \quad \text{cm. (b)} \quad (4)$$

$$\frac{J_r}{r} + \frac{\partial J_r}{\partial r} + \frac{1}{r} \cdot \frac{\partial J_\phi}{\partial \phi} + \frac{\partial J_z}{\partial z} = 0, \quad \text{see (c)} \quad (5)$$

$$\frac{1}{r} \cdot \frac{\partial J_z}{\partial \phi} - \frac{\partial J_\phi}{\partial z} = 0, \quad \text{see (a)} \quad (6)$$

$$\frac{\partial J_r}{\partial z} - \frac{\partial J_z}{\partial r} = 0, \quad \text{see (a)} \quad (7)$$

$$\frac{J_\phi}{r} + \frac{\partial J_\phi}{\partial r} - \frac{1}{r} \cdot \frac{\partial J_r}{\partial \phi} = 0. \quad \text{see (a)} \quad (8)$$

The model is based on the following facts:

1. the main electric field strength E_o is directed along the wire axis,
2. it creates the main electric current J_o representing the vertical flow of charges,
3. the vertical current J_o forms the annular magnetic field strength H_ϕ and the radial magnetic field strength H_r , see in formula (4),
4. the magnetic field strength H_ϕ via the Lorentz forces deflects the electric charges of the vertical flow towards the radial direction, creating a radial flow of the charges representing the radial electric current J_r ,
5. the magnetic field strength H_ϕ via the Lorentz forces deflects the electric charges of the radial flow towards perpendicular to the radii, thus creating the vertical electric current J_z (in addition to the current J_o),
6. the magnetic field strength H_r by the aid of the Lorentz forces deflects the charges of the vertical flow towards perpendicular to the radii, thus creating the annular current J_ϕ ,
7. the magnetic field strength H_r by the aid of the Lorentz forces deflects the charges of the annular flow towards along the radii, thus creating the vertical current J_z (in addition to the current J_o),
8. the current J_r forms both the vertical magnetic field strength H_z and the annular magnetic field strength H_ϕ , see in formula (2),
9. the current J_ϕ forms both the vertical magnetic field strength H_z and the radial magnetic field strength H_r , see in (3),
10. the current J_z forms both the annular magnetic field strength H_ϕ and the radial magnetic field strength H_r , see in (6),

Thus, the main electric current J_o creates the additional currents J_r, J_ϕ, J_z and the magnetic field strengths H_r, H_ϕ, H_z . They should satisfy the Maxwell equations.

In addition, electromagnetic fluxes shall be such that

- A. Energy flux in the vertical direction was equal to the transmitted power,
- B. The sum of energy fluxes is equal to the transmitted power plus the power of thermal losses in the wire.

Thus, these currents and strengths shall confirm Maxwell's equations and conditions A and B.

Chapter 5z details the solution of Maxwell's equations for a DC wire and proves that the solution to system (1-8) exists at nonzero currents J_r, J_ϕ, J_z . For the sake of brevity further we shall use the following notations:

$$\text{co} = \cos(\alpha\varphi + \chi z), \tag{10}$$

$$\text{si} = \sin(\alpha\varphi + \chi z), \tag{11}$$

where α, χ are the certain constants. In Appendix 1, it is shown that there exists a solution of the following form:

$$J_r = j_r \text{si}, \tag{12}$$

$$J_\phi = j_\phi \text{co}, \tag{13}$$

$$J_z = j_z \text{co}, \tag{14}$$

$$H_r = h_r \text{co}, \tag{15}$$

$$H_\phi = h_\phi \text{si}, \tag{16}$$

$$H_z = h_z \text{si}, \tag{17}$$

where $j(r), h(r)$ are the certain function of the coordinate r .

It can be assumed that the average speed of electrical charges doesn't depend on the current direction. In particular, for a fixed radius the way passed by the charge around a circle and the way passed by it along a vertical will be equal. Consequently, for a fixed radius it can be assumed that

$$\Delta\varphi \equiv \Delta z. \tag{18}$$

Thus, on the cylinder of constant radius there is trajectory of point, which can be described by formulas (10), (11), and (18). This trajectory is a helix. On the other hand, in accordance with (12)-(17), many possible trajectories can pass through each circle. Along these trajectories, both the strengths and the current densities varies harmonically as functions of φ . Consequently,

the line on the cylinder of the constant radius r is a helical line. Along this line, some point moves so that all the strengths and the current densities remain constant.
--

Based on this assumption, it is possible to construct a trajectory of motion of the charge in accordance with functions (10) and (11). Figure 5 shows three helix lines with $\Delta\phi = \Delta z$. These functions of the electric current are described by formulae (10) and (11): the thick line with $\alpha = 2, \chi = 0.8$, the middle line with $\alpha = 0.5, \chi = 2$, and the thin line with $\alpha = 2, \chi = 1.6$.

Fig. 1 shows the helices for the functions J and H defined by expressions (10)-(17), namely for the total current with the projections J_φ and J_z with $r = \text{const}$. These projections are determined by (13) and (14), i.e. depend on the function si . However, the functions J and H can be defined as follows:

$$\bar{J}_r = j_r \text{co}, \tag{19}$$

$$\bar{J}_\varphi = j_\varphi \text{si}, \tag{20}$$

$$\bar{J}_z = j_z \text{si}, \tag{21}$$

$$\bar{H}_r = h_r \text{si}, \tag{22}$$

$$\bar{H}_\varphi = h_\varphi \text{co}, \tag{23}$$

$$\bar{H}_z = h_z \text{co}. \tag{24}$$

The difference of these functions from functions (10)-(17) is that the functions co are replaced by the functions si , and vice versa.

Figure 6 shows helix lines

- for the functions J and H defined by (13) and (14), similar to those shown in Fig. 2. These functions depend on the function si (see the thin line) and
- for the functions J and H defined by (20) and (21) that depend on the function si (see the thick line).

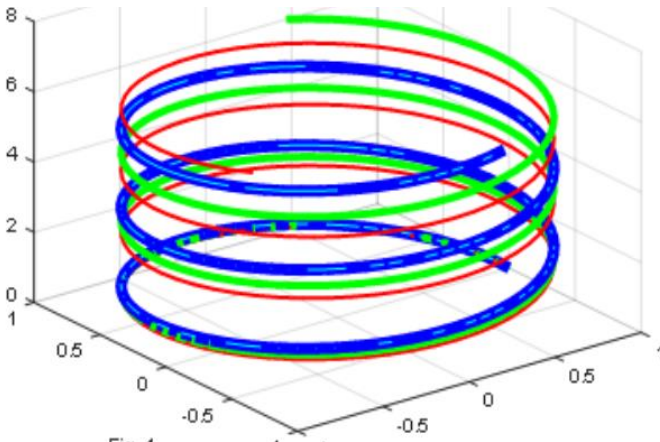

Fig. 1.

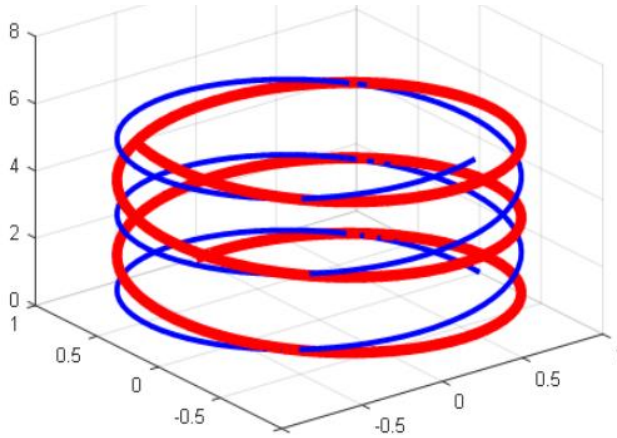

Fig. 2.

The very fact of existence around a conductor with a constant current of a magnetic field, having a spiral-like configuration, was established by Oersted in 1820 [127, p. 184]. Fig. 3 shows the photograph of the wire moistened with magnetic fluid (magnified 20 times). One can see the spiral lines formed in the magnetic fluid. This photograph indicates the existence of the spiral lines of magnetic strengths.



Fig. 3.

3. Calculation of currents and strength

Chapter 5z deals with the solution of the system of differential equations (2.1-2.8) in the form of functions (2.10-2.17). The functions $j_r(r)$, $j_\phi(r)$, $j_z(r)$, $h_r(r)$, $h_\phi(r)$, $h_z(r)$ are determined depending on the values of two parameters: α and χ . These functions are as follows:

$$h_z''(r) + h_z'(r) - h_z(r) \left(\frac{\alpha^2}{r^2} + \chi^2 \right) = 0, \quad (18)$$

$$h_\phi(r) = \frac{\alpha}{\chi} \left(\frac{h_z(r)}{r} - j_r(r) \right), \quad (19)$$

$$h_r(r) = -\frac{1}{\chi} \left(h_z'(r) + j_\phi(r) \right), \quad (20)$$

$$j_z''(r) + j_z'(r) \frac{1}{r} - j_z(r) \left(\frac{\alpha^2}{r^2} + \chi^2 \right) = 0, \quad (21)$$

$$j_\phi(r) = \frac{\alpha}{\chi} \cdot \frac{j_z(r)}{r}, \quad (22)$$

$$j_r(r) = -\frac{1}{\chi} \cdot j_z'(r). \quad (23)$$

It is interesting to note that in this solution $j_z(r) = h_z(r)$!

Example 1.

Figure 4.1 shows the graphs of the functions $j_r(r), j_\phi(r), j_z(r), h_r(r), h_\phi(r), h_z(r)$. These functions are calculated with the following data: $\alpha = 0.005$, $\chi = 0.9$ and the radius of the wire $R = 0.001$. In Figure 4.1, the first column shows the functions $j_r(r), j_\phi(r), j_z(r)$, the second column shows the functions $h_r(r), h_\phi(r), h_z(r)$, and the functions shown in the third column will be discussed later.

In chapter 5z, appendix 3, the magnetic strengths are found, which allow you to calculate the magnetic field OUTSIDE the wire:

$$h_z''(r) + \frac{1}{r} h_z'(r) - h_z(r) \left(\frac{\alpha^2}{r^2} + \chi^2 \right) = 0, \quad (25)$$

$$h_\phi(r) = \frac{\alpha}{\chi} \frac{h_z(r)}{r}, \quad (26)$$

$$h_r(r) = -\frac{1}{\chi} h_z'(r), \quad (27)$$

moreover, $r \geq R$, where R is the radius of the wire.

Find the value of the average axial current J_{zmid} in a wire with radius R , which is created by the current density $j_z(r)$. It can be assumed that the current in the volume of the wire section with thickness dz moves, rotating along the wire axis. If the WHOLE volume of the wire is filled with current spirals, then the average axial current in the wire can be determined by a formula of the form:

$$J_{zmid} = \frac{1}{\pi R^2} \int_0^{2\pi} \left(\int_0^R j_z(r) r dr \right) d\phi = \frac{2\pi}{\pi R^2} \int_0^R j_z(r) r dr$$

or

$$J_{zmid} = \frac{2}{R^2} \int_0^R j_z(r) r dr. \quad (1)$$

Similarly, we find the value of the average radial current $J_{r\text{mid}}$, directed along ALL radii of the wire of a certain section,

$$J_{r\text{mid}} = \int_0^{2\pi} \left(\int_0^R j_r(r) 2\pi r dr \right) \cos(\alpha\varphi + \chi z) d\varphi = 4\pi(\cos(\chi z) - \cos(2\pi\alpha + \chi z)) \int_0^R j_r(r) r dr \quad (2)$$

We will also find the value of the average circular current $J_{\varphi\text{mid}}$, flowing along all circles of a certain section,

$$J_{\varphi\text{mid}} = \int_0^{2\pi} \left(\int_0^R j_{\varphi}(r) 2\pi r dr \right) \cos(\alpha\varphi + \chi z) d\varphi = 4\pi(\sin(\chi z) - \sin(2\pi\alpha + \chi z)) \int_0^R j_{\varphi}(r) r dr \quad (3)$$

Similarly, you can determine the average magnetic strength:

$$H_{z\text{mid}} = \frac{2}{R^2} \int_0^R h_z(r) r dr. \quad (4)$$

$$H_{r\text{mid}} = 4\pi(\sin(\chi z) - \sin(2\pi\alpha + \chi z)) \int_0^R j_r(r) r dr \quad (5)$$

$$H_{\varphi\text{mid}} = 4\pi(\cos(\chi z) - \cos(2\pi\alpha + \chi z)) \int_0^R j_{\varphi}(r) r dr \quad (6)$$

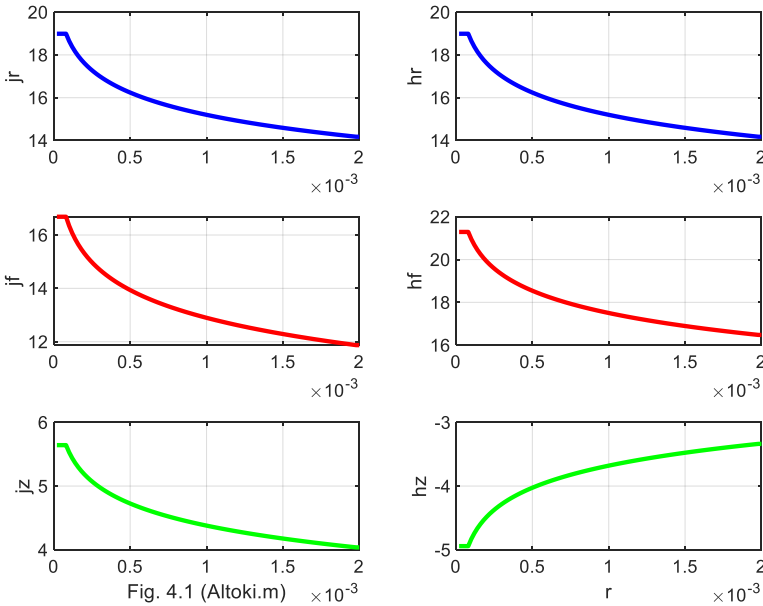

Fig. 4.1 (Altoki.m) $\times 10^{-3}$

4. Energy Flows

The density of electromagnetic flow is the Poynting vector defined by

$$S = E \times H. \quad (1)$$

The electrical field strengths E depend on the corresponding electric currents J , i.e.

$$E = \rho \cdot J, \tag{2}$$

where ρ is the electrical resistivity. Combining (1) and (2), we get:

$$S = \rho J \times H = \frac{\rho}{\mu} J \times B. \tag{3}$$

The magnetic Lorentz force acts on all the charges of the conductor per unit volume. It is the bulk density of magnetic Lorentz forces and is equal to

$$F = J \times B. \tag{4}$$

From (3) and (4), we find:

$$F = \mu S / \rho. \tag{5}$$

Therefore, in the wire with some constant current the magnetic Lorentz force density is proportional to the Poynting vector.

Example 1. To examine the dimension checking of the quantities in the above formulas, see Table 1 in the SI system.

Table 1

Parameter		Dimension
Energy flux density	S	$\text{kg} \cdot \text{s}^{-3}$
Current density	J	$\text{A} \cdot \text{m}^{-2}$
Induction	B	$\text{kg} \cdot \text{s}^{-2} \cdot \text{A}$
Bulk density of magnetic Lorentz forces	F	$\text{N} \cdot \text{m}^{-3} = \text{kg} \cdot \text{s}^{-2} \cdot \text{m}^{-2}$
Permeability	μ	$\text{kg} \cdot \text{s}^{-2} \cdot \text{m} \cdot \text{A}^{-2}$
Resistivity	ρ	$\text{kg} \cdot \text{s}^{-3} \cdot \text{m}^3 \cdot \text{A}^{-2}$
μ/ρ	μ/ρ	$\text{s} \cdot \text{m}^{-2}$

So, the current with the density J and the magnetic field generate the energy flux with the density S , which is identical with the magnetic Lorentz force density F , see in formula (5). This Lorentz force acts on the charges moving in the current J , and this action is in the direction perpendicular to this current. So, it's fair to say that the Poynting vector produces an emf in the conductor. Some other aspects of this problem are considered in Chapter 15, where this emf is called the fourth type of electromagnetic induction.

In the cylindrical coordinates r, ϕ, z the density flow of electromagnetic energy has three components S_r, S_ϕ, S_z , directed along вдоль the axis accordingly.

4.1. In each point of a cylinder surface there are two electromagnetic fluxes directed radially to the center with the following densities (see in Figure 9):

$$S_{r1} = \rho J_\phi H_z, \quad S_{r2} = -\rho J_z H_\phi \quad (6)$$

The total radially-directed flux density in each point of the cylinder surface is

$$S_r = S_{r1} + S_{r2} = \rho(J_\phi H_z - J_z H_\phi) \quad (7)$$

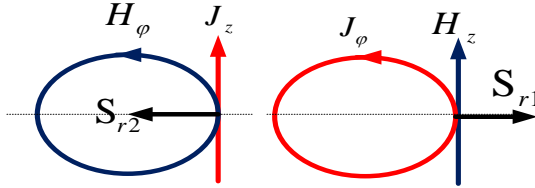

Fig. 9.

4.2. At each point of the cylinder surface there are two electromagnetic fluxes directed vertically with the following densities (see in Figure 10):

$$S_{z1} = -\rho J_\phi H_r, \quad S_{z2} = \rho J_r H_\phi \quad (8)$$

The total vertically-directed flux density in each point of the cylinder surface is defined by

$$S_z = S_{z1} + S_{z2} = \rho(J_r H_\phi - J_\phi H_r) \quad (9)$$

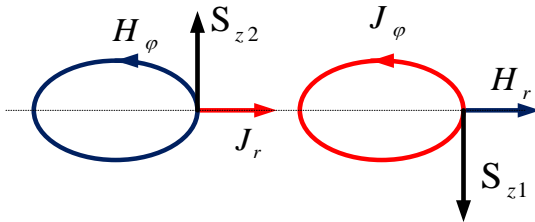

Fig. 10.

4.3. At each point of the cylinder surface there are two electromagnetic fluxes circumferentially directed with the following densities (see in Figure 11):

$$S_{\phi1} = \rho J_z H_r, \quad S_{\phi2} = -\rho J_r H_z, \quad (10)$$

The total circumferentially directed flux density in each point of the cylinder surface can be expressed by

$$S_\phi = S_{\phi1} + S_{\phi2} = \rho(J_z H_r - J_r H_z) \quad (11)$$

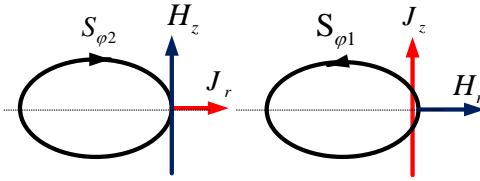

Fig. 11.

In view of the above, we can write the equation for electromagnetic flux density in the direct current wire as follows:

$$S = \begin{bmatrix} S_r \\ S_\phi \\ S_z \end{bmatrix} = \rho(J \times H) = \rho \begin{bmatrix} J_\phi H_z - (J_z + J_o)(H_{\phi o} + H_\phi) \\ (J_z + J_o)H_r - J_r H_z \\ J_r(H_{\phi o} + H_\phi) - J_\phi H_r \end{bmatrix}. \quad (12)$$

From (12, 2.12-2.17) we find:

$$S = \begin{bmatrix} S_r \\ S_\phi \\ S_z \end{bmatrix} = \rho \begin{bmatrix} (j_\phi h_z \cos \theta \cdot \sin \theta - (j_z \cos \theta + j_o)(h_\phi \sin \theta + H_{\phi o})) \\ (j_z h_r \cos^2 \theta - j_r h_z \sin^2 \theta) + j_o h_r \cos \theta \\ (j_r h_\phi \sin^2 \theta - j_\phi h_r \cos^2 \theta) + j_r \sin \theta H_{\phi o} \end{bmatrix}. \quad (13)$$

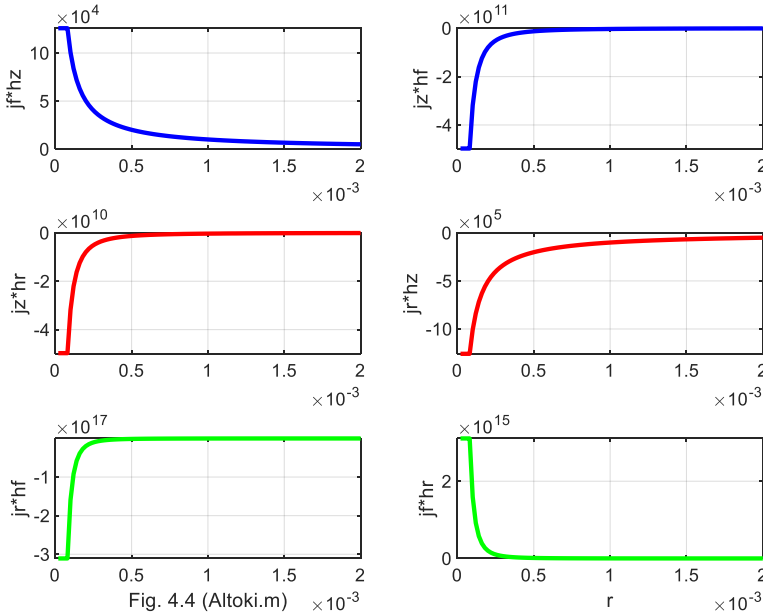

Fig. 4.4 (Altoki.m) $\times 10^{-3}$

Example 1. In fig. 4.4 shows the products of the logarithms of functions of the form $j_\phi h_z$ given in formula (14). The calculations were performed under the conditions of Example 1 from Section 3 at $\rho =$

$0.018 \cdot 10^{-6}$ for copper. It can be seen that the values from $S_z(r)$ significantly (by three orders of magnitude) exceed the values from $S_r(r)$ and $S_\phi(r)$. Therefore, further we will consider in more detail only the energy flux density along the axis of the wire.

So, consider the density of the axial energy flux from (13):

$$S_z = \rho(j_r h_\phi \text{si}^2 - j_\phi h_r \text{co}^2) \quad (15)$$

На площади сечения провода плотность осевого потока энергии равна

$$S_{zR} = \rho \int_{\varphi=0}^{2\pi} \left(d\varphi \int_{r=0}^R S_z 2\pi r dr \right) =$$

$$= 2\pi\rho \left[\int_{\varphi=0}^{2\pi} \left(d\varphi \int_{r=0}^R (j_r h_\phi \text{si}^2) r dr \right) - \int_{\varphi=0}^{2\pi} \left(d\varphi \int_{r=0}^R (\text{co}^2) r dr \right) \right]$$

or

$$S_{zR} = 2\pi^3 \rho \int_{r=0}^R (j_r h_\phi - j_\phi h_r) r dr. \quad (16)$$

So, in the wire the fluxes of electromagnetic energy circulate, keeping a constant value. They are internal. They are generated by the currents and the magnetic strengths generated by these currents. In turn, these flows affect the currents, as the Lorentz forces. In this case, the total energy of these flows is partially spent on heat losses but is mainly transferred to the load.

Longitudinal energy flow S_{zR} . is equal to the power P transmitted through the wire:

$$P = S_{zR}. \quad (19)$$

Note that this power varies along the wire, because part of the energy is spent on heat losses.

Example 2.

Let us also consider function (16). In fig. 4.5 shows this function for $\alpha = 0.1$, $\chi = 0.005$, wire radius $R = 0.001$ and $\rho = 0.018 \cdot 10^{-6}$) for copper. It can be seen that it is always non-negative. Average value $P = S_{zR} = 15000$.

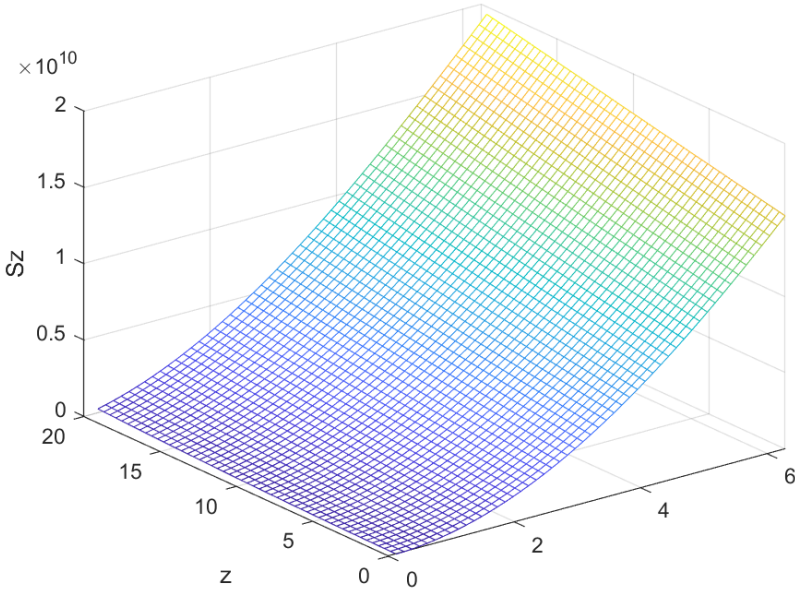

fi Fig. 4.5 (Meisner.m)

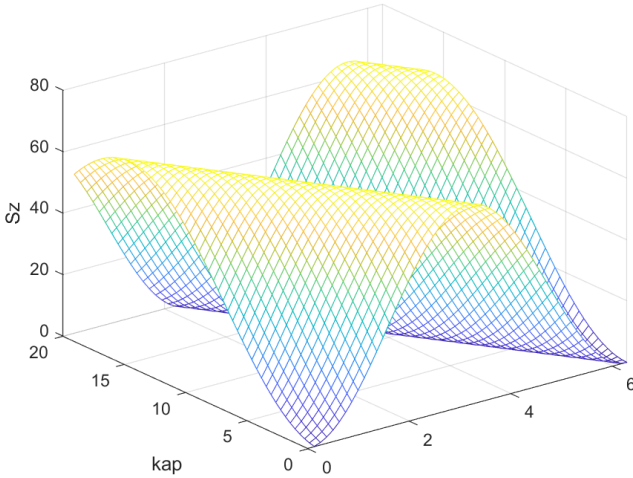

fi Fig. 4.5 (Meisner.m)

5. Calculation of all parameters

For given α and χ , the current and strengths densities, as well as the average axial current J_{zmid} , can be found - see (3.1). Magnetic strength outside the wire can also be found.

With known current densities and strengths, energy fluxes can be found, as shown in Section 4.

It is important to note again that the transmitted power P and the total axial current J_o are independent. This fact allows a complete calculation to be performed as follows:

- with a known radius R , and a known power P and wire material, the values of the constants α and χ are determined, since the function $P(\alpha, \chi)$ is single-valued;
- for known α and χ , current J_{zmid} is determined by (3.1);
- the known parameters α и χ determine the functions $j_r(r), j_\phi(r), j_z(r), h_r(r), h_\phi(r), h_z(r)$ - see Section 3;
- the known parameters α and χ determine the magnetic strength outside the wire $h_r(r), h_\phi(r), h_z(r)$ – see Appendix 3 in Chapter 5z.

Example 1. In fig. 5.1 shows the functions $P(\alpha, \chi)$ and $J_{zmid}(\alpha, \chi)$, obtained at $R=0.002$ for a copper wire with $\rho = 0.018 \cdot 10^{-6}$. The power was determined as $P = S_{zR}$ according to (4.17, 4.16). In fig. 5.2 shows a function of the form

$$\varepsilon = (P - P_0)/P_0$$

where $P_0 = 4000$ is the given power value. The dots show the error values $\varepsilon < \varepsilon_0$, where the permissible error $\varepsilon_0 = 7\%$. The white bar shows the range of values (α, χ) for which the condition $\varepsilon < \varepsilon_0$ is satisfied. In this case, the values $(\alpha = 0.041, \chi = 0.0113)$ were obtained, and from these values and $J_{zmid}(\alpha, \chi) \approx 7.7$ was found by (3.1).

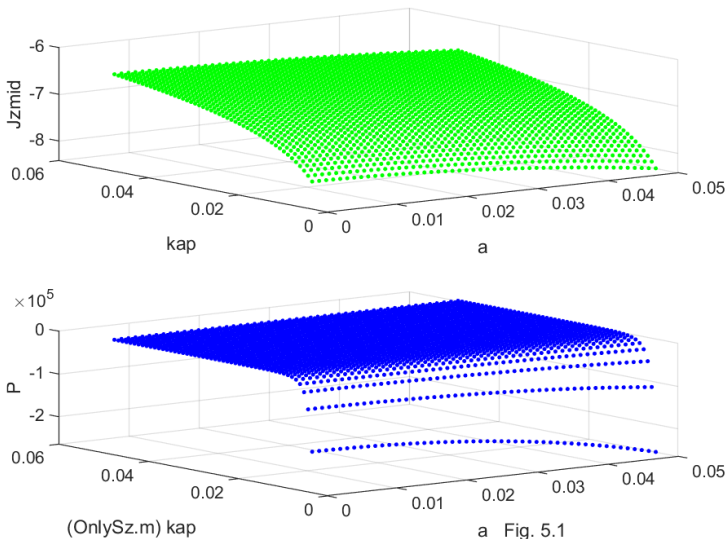

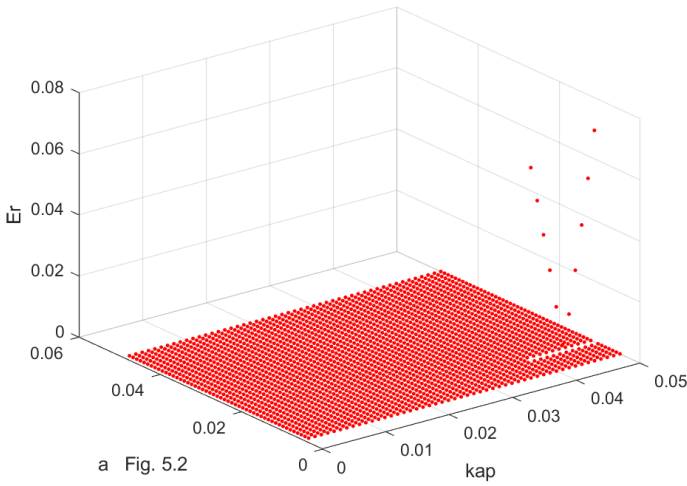

Example 2. In fig. 5.3 shows the dependences of the function (P) , $\chi(P)$, $J_{zmid}(P)$, obtained at $R = 0.002$ for a copper wire with $\rho = 0.018 \cdot 10^{-6}$ - see the corresponding windows.

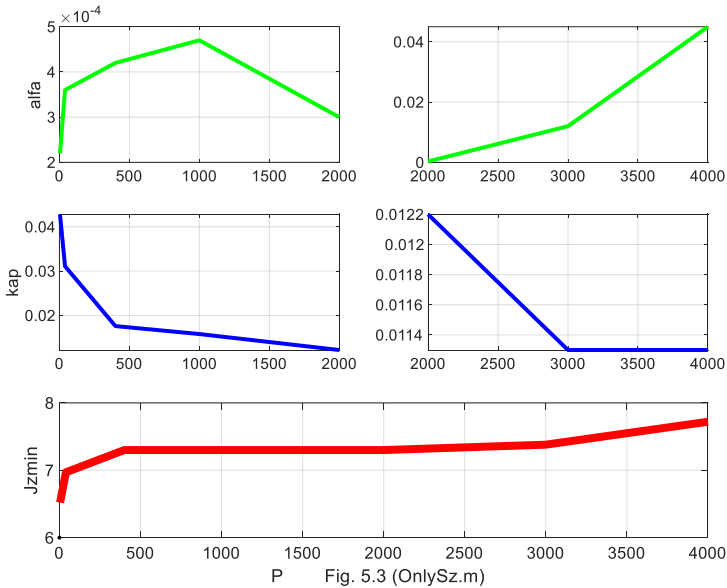

From the function $J_{zmid}(P)$ it follows that this value practically does NOT change when the power transmitted through the wire changes. It can be assumed that the considered structure of currents exists even when the power is zero and there is no load current J_0 . Consequently, heat currents are not chaotic, but have a spiral structure.

Consider the relationship between the main current J_0 in the wire and the current J_{zmid} . In reality, the current spirals are located with a certain step, depending on the speed of current propagation along the wire. Therefore, let us first assume that the real axial current in the wire, formed by the current J_{zmid} , is defined as

$$J_\beta = \beta \cdot J_{zmid}, \quad (1)$$

where the coefficient β is to be determined. If the current J_w measured in the wire is such that $J_\beta < J_w$, then the main current $J_0 = J_w - J_\beta$ exists in the wire.

It can also be assumed that the current J_β is the current J_0 , i.e. $J_0 = J_w = J_\beta$. This will mean that the speed of current propagation through the wire is always such that

$$J_0 = \beta \cdot J_{zmid}. \quad (2)$$

The relationship between the speed of propagation of the current and the speed of propagation of the static energy flow through the wire is to be determined. The latter is discussed below.

6. Speed of energy motion

Let us consider the speed of energy motion in the constant current wire. Just as in Chapter 1, we will use the concept of Umov [81], according to which the energy flux density s is a product of the energy density w and the velocity v_e of energy movement, namely:

$$s = w \cdot v_e. \quad (1)$$

We will only consider the flow of energy along the wire. This flux is equal to the power P transmitted over the wire to the load:

$$s = P/\pi R^2. \quad (2)$$

where R is the radius of the wire.

Let us first assume that the energy source is the internal energy of the wire - the energy of the magnetic field of the main current I_0 . This energy is

$$W_m = \frac{L_i L I_0^2}{2}, \quad (3)$$

where L is the length of the wire. L_i is the inductance of a unit of the wire length, and [83]

$$L_i \approx \frac{\mu_0}{2\pi} \ln \frac{1}{R}. \quad (4)$$

The wire volume is

$$V = L\pi \cdot R^2. \quad (5)$$

With (3)-(5), we find the energy density in the wire as follows:

$$W = \frac{W_m}{V} = \frac{L_i I_0^2}{2\pi R^2}. \quad (6)$$

With formulae (1), (2), and (6), we find the following velocity of the energy motion:

$$v_\phi = \frac{s}{w} = \frac{P}{\pi R^2 / \left(\frac{L_i I_0^2}{2\pi R^2} \right)} = \frac{2P}{L_i I_0^2}. \quad (7)$$

The load resistance is

$$R_H = \frac{P}{I_0^2} \quad (8)$$

Consequently,

$$v_\phi = \frac{2R_H}{L_i}. \quad (9)$$

For example, if $R = 10^{-3}$ and $R_H = 1$, we have

$$\ln \frac{1}{r} \approx 7, L_i \approx \frac{\mu_0}{2\pi} \ln \frac{1}{r} \approx 7 \times 10^{-7}, v_\phi = 3 \times 10^6.$$

This speed is much less than the speed of light in a vacuum. With this speed, the energy flows into the wire and out of it towards the load. We do not take into account the energy of heat losses because it is not transferred to the load.

When the load is switched on, the current in the wire increases according to the following function:

$$I_0 = \frac{U}{R_H} \left(1 - \exp\left(-\frac{t}{\tau}\right) \right), \quad (10)$$

where U is the input voltage and

$$\tau = \frac{L_i L}{R_H}. \quad (11)$$

With equations (9) and (10), we can find:

$$v_\phi = \frac{2P}{L_i I_0^2} = \frac{2U}{L_i I_0} = \frac{2U}{L_i} / \frac{U}{R} \left(1 - \exp\left(-\frac{t}{\tau}\right) \right) = \frac{2R}{L_i} / \left(1 - \exp\left(-\frac{t}{\tau}\right) \right). \quad (12)$$

Thus, the speed of energy moving in the transient process decreases from infinity (the speed of light in a vacuum) to the value of equation (9).

7. The speed of energy from the battery

The characteristics of the "average battery" are presented below [92]:

Em is the battery capacity	60 Ah
P is the density of the electrolyte	1250 kg/m ³
G is the weight of electrolyte	1.5 kg
V = G/p is the volume of the electrolyte	0.0012 m ³
R is the load resistance	0.047 Ohm
U is the voltage on the load	12.8 V
I is the load current (starting)	270 A
P = UI = U ² /R is the load power	3456 W

$W = 3600 \times E_m \times U$ is the electrolyte energy	2,764,800 J
$w = W/V$ is the energy density	$2.3 \times 10^9 \text{ J/m}^3$
$S = P$ is energy flow	3,456 W
b is wire cross-section	100 mm^2
$s = S/(b \times 10^{-6})$ is energy flux density	$3.5 \times 10^7 \text{ Wt}$
$v_\phi = \frac{w}{s}$ is speed of energy movement	100 m/s
c is the speed of light	$300 \times 10^6 \text{ m/s}$

Thus, the speed of energy movement on the wire from the battery is much less than the speed of light.

8. Discussion

The energy flow along the wire's axis S_z is created by the electric currents and the strengths directed along the radius and the circles. This energy flow is equal to the power released in the load R_H and in the wire resistance. The currents flowing along the radius and the circle are also creating heat losses. Their powers are equal to the energy flows S_r, S_ϕ directed along the radius and the circle.

The question of the way by in which the electromagnetic energy creates current is considered in [19]. It is shown in [19] that there exists a fourth electromagnetic induction created by a change in electromagnetic energy flow. Further we must find the dependence of emf of this induction on both the electromagnetic flow density and the wire parameters. There is a well-known experiment that can provide an evidence for the existence of this type of induction [17].

It is shown that the direct current has a complex structure and extends inside the wire along a helical trajectory. There are two components of the current. The density of the first component J_o is permanent of the whole wire section. The density of the second component is changing along the wire section so that the current is spreading in a spiral. In the cylindrical coordinates r, ϕ, z , this second component has the coordinates J_r, J_ϕ, J_z . They can be found as the solution of Maxwell's equations. The solution is discussed in detail in Chapter 5z.

With invariable density of the main current in the wire, the power transmitted by it depends on the structure parameters (α, χ) which influence the density of the turns of helical trajectory. Thus, the same current in the wire can transmit various values of power (depending on the load).

Let us again look at the scheme shown in Figure 4. On segment AB the wire transmits the load energy P. Some certain values of α and χ and

the density of coils of the current's helical trajectory correspond to this energy. On segment CD the wire transmits only small amount of energy. A small value of χ and a small density of the coils of current's helical trajectory corresponds to this energy.

Naturally, the resistivity of the wire itself is also a load. Thus, as the current flows within the wire, the helix of the current's path straightens.

Thus, it is shown that there exists such a solution of Maxwell's equations for the wire with constant current which corresponds to the idea of

- law of energy preservation
- helical path of constant current in the wire,
- energy transmission along and inside the wire,
- the dependence of helical path density on the transmitted strength.

The foregoing does not in any way affect the methods for calculating DC circuits. But further it will be shown that the existence of a spiral structure of a direct current can explain well-known experiments that have not found an explanation, and propose methods for calculating new technical devices.

Chapter 5a. Milroy Engine

Contents

- 1. Introduction \ 1
- 2. Mathematical model \ 2
- 3. Electromagnetic energy flux \ 4
- 4. Torque \ 5
- 5. An Additional Experiment \ 6
- 6. About the Law of Impulse Conservation \ 7
- Appendix 1. Calculation of the torque \ 7
- Photos \ 9

1. Introduction

The Milroy Engine (ME) [67] is well known. In the Youtube network, some experiments with the ME [68-73] are demonstrated. There are attempts to theoretically explain the functioning of the ME [74-77, 80]. In [80], the functioning of this engine is explained by the action of nonpotential lateral Lorentz forces. In [74], the functioning of this engine is explained by the interaction of magnetic flow created by current spiral I in the shaft and modulated variable reluctance of the gap between the holders of the bearing with the currents inducted in the inner holder of the bearing. Without discussing the validity of these theories, it should be noted that they were not brought to the stage when they could be used to calculate the ME technical parameters. However, such calculations are necessary before mass production begins.

The photographs at the end of this chapter show the various ME constructions. Conductive shaft with flywheels can rotate in two bearings. Through the outer rings of the bearing and through the shaft an electric current is passed. The shaft begins to spin up to any side after the first push.

Along with a very simple design, the ME has two considerable disadvantages:

1. Low efficiency
2. Initial acceleration of the ME with other engine/motor (in the process, the ME continues rotation in the direction it was jerked for starting and increases the speed).

It should be noted that the latter disadvantage often has no importance. For example, the ME installed on a bicycle could be accelerated by the bicyclist.

The engine ME was presented by the English physicist R. Milroy in the year 1967 [67]. V.V. Kosyrev, V.D. Ryabkov, and N.N. Velman before Milroy in 1963 have presented an engine of different construction [82]. Their engine differs fundamentally from the Milroy engine by the absence of one of bearings. The conductive shaft is pressed into the inner ring of the horizontal bearing. So the shaft is hanging on the bearing. The electrical circuit is closed through the outer ring of the bearing and the brush touching the lower face of the shaft. The authors see the cause of rotation in the fact that the shaft "rotates as a result of elastic deformation of the engine's parts when they are heated by electric current flowing through them".

Finally, often the functioning of this engine is explained by the Hoover's effect [77, 84].

Below we are giving another explanation of this engine's operating principle. We show that inside the conductor with the current there appears a torque. It seems to the author that the Kosyrev's engine cannot be explained in another way.

2. Mathematical model

In Chapter 5, we considered solutions of Maxwell's equations for the wire with the direct current with the density J_{oz} . The density of this current is the same over the entire section of the wire. Maxwell's equations in this case have the following form:

$$\text{rot}(J) = 0, \tag{a}$$

$$\text{rot}(H) - J = 0, \tag{b}$$

$$\text{div}(J) = 0, \tag{c}$$

$$\text{div}(H) = 0, \tag{d}$$

The current density J_{oz} is not included in equations (a) and (d) because all derivatives of this current are equal to zero.

It was shown that the complete solution of Maxwell's equations in this case consists of two parts:

- 1) one known equation of the following form:

$$H_{o\varphi} = J_{oz}r, \tag{1}$$

- 2) the equations in forms (5.2.10)-(5.2.17) and (5.2.25)-(5.2.30) obtained in Chapter 5. These equations combine the magnetic field strengths and the current densities with the known constants (α , χ) and the wire radius R .

The currents and the strengths determined by these equations are formally independent of the given current J_{oz} . However, they define the flow of energy transmitted through the wire, i.e. namely the capacity produced by the current in the load.

Below we consider the case when there is the DC current directed along the circumference, ring current. For example, the coil of the solenoid can be represented as a solid ring cylinder with direct current around its circumference. We denote the density of this given current as $J_{o\phi}$. Just as in the case of the given current J_{oz} , the complete solution of Maxwell's equations (a)-(d) in this case consists of the following two parts:

1) one known equation that reads:

$$-\frac{\partial H_{z0}}{\partial r} = J_{\phi 0}, \quad (17)$$

2) equations (5.2.10)-(5.2.17) and (5.2.25)-(5.2.30).

Let us consider the source of current $J_{o\phi}$. If there is no rotation of the rod, the direct current with the density J_{oz} flows through it. Free electrons of this current move with some velocity along the rod. When the rod rotates, free electrons of this current also acquire the circumferential velocity. Thus, there is some convection current that is the current with the density $J_{o\phi}$. Eichenvald [86] has shown that the convection current creates also the magnetic intensity. Therefore, the current with the density $J_{o\phi}$ creates magnetic strength (17).

Thus, the charges with density q and velocity v (*velocity of electrons in the wire*) move along the wire in the current J_o , where

$$J_o = qv. \quad (18)$$

If the rod rotates at angular speed ω , then

$$J_{\phi 0} = q\omega \cdot r \quad (19)$$

or, with consideration of equation (4),

$$J_{\phi 0}(r) = J_o\omega \cdot r/v. \quad (20)$$

Consequently, in the rotating rod of the Milroy engine the direct convection current with density (20) flows along the wire circumference together with the axial current J_o .

With expressions (17) and (20), we find that

$$H_{z0} = \frac{J_o\omega \cdot r^2}{2v}. \quad (21)$$

Further, it will be shown that the solution of equations (1)-(16) implies the existence of driving moment M in the rod. This driving moment increases the rotation speed, thereby increasing the convection current $J_{o\phi}$. Balance occurs when the specified driving moment and the braking moment on the engine shaft are equal (at given current J_{oz}). This

phenomenon is analogous to the fact that the currents flowing along the wire, under the influence of the Ampere force, shift the wire as a whole (in ordinary electric motors).

Finally, it is possible to imagine a design where an additional radial magnetic strength H_{or} is created in the rod.

One can also imagine a design where an additional axial magnetic strength H_{zo} is created in the rod.

3. Electromagnetic energy flux

Section 3 of Chapter 5 shows that the electromagnetic flux density and the Lorentz magnetic force density in the DC wire are connected by the following relationships:

$$S = E \times H, \quad (1)$$

$$S = \rho J \times H = \frac{\rho}{\mu} J \times B, \quad (3)$$

$$F = J \times B, \quad (4)$$

$$F = \mu S / \rho, \quad (5)$$

where ρ, μ are the electrical resistivity and the magnetic permeability, respectively. Consequently, in the wire with the direct current the density of Lorentz magnetic force is proportional to the Poynting vector.

In the cylindrical coordinates, the densities of these flows of energy by the coordinates are expressed by the following formula, also see in formula (5.3.12):

$$S = \begin{bmatrix} S_r \\ S_\varphi \\ S_z \end{bmatrix} = \rho(J \times H) = \rho \begin{bmatrix} J_\varphi H_z - (J_z + J_o)(H_\varphi + H_{o\varphi}) \\ J_z H_r - J_r H_z + J_o H_r \\ J_r H_\varphi - J_\varphi H_r + J_r H_{o\varphi} \end{bmatrix}. \quad (6)$$

For the Milroy engine, this formula is amended due to the values of $H_{zo}, J_{\varphi o}$ and takes the following form:

$$S = \begin{bmatrix} S_r \\ S_\varphi \\ S_z \end{bmatrix} = \rho(J \times H) = \rho \begin{bmatrix} (J_\varphi + J_{\varphi o})(H_z + H_{zo}) - (J_z + J_o)(H_\varphi + H_{o\varphi}) \\ (J_z + J_o)H_r - J_r(H_z + H_{zo}) \\ J_r(H_\varphi + H_{o\varphi}) - (J_\varphi + J_{\varphi o})H_r \end{bmatrix}. \quad (7)$$

According to (5), we can find the following Lorentz forces acting on volume unit:

$$F = \begin{bmatrix} F_r \\ F_\varphi \\ F_z \end{bmatrix} = \frac{\mu}{\rho} \begin{bmatrix} S_r \\ S_\varphi \\ S_z \end{bmatrix}. \quad (8)$$

4. Torque

In (3.8), in particular, F_φ is the rotational force acting on the shaft in the volume unit of the layer with the radius r . Therefore, the density of driving moment acting on the shaft in the layer with the radius r is equal to:

$$M(r) = r \cdot F_\varphi. \quad (9)$$

With equations (7) and (8), we can find that

$$S_\varphi = \rho[(J_z + J_o)H_r - J_r(H_z + H_{z_o} + H_{2z_o})], \quad (11)$$

$$F_\varphi = \frac{\mu}{\rho} S_\varphi = \mu \left[\begin{array}{l} (J_z + J_o)(H_r + H_{r_o}) - \\ -J_r(H_z + H_{z_o} + H_{2z_o}) \end{array} \right]. \quad (12)$$

With (9) and (12), we can also find that

$$M(r) = r \cdot F_\varphi = \mu \cdot r \left[\begin{array}{l} (J_z + J_o)(H_r + H_{r_o}) - \\ -J_r(H_z + H_{z_o} + H_{2z_o}) \end{array} \right]$$

or, with consideration of (2.21),

$$M(r) = \mu \cdot r \left[\begin{array}{l} (J_z + J_o)(H_r + H_{r_o}) - \\ -J_r \left(H_z + H_{2z_o} + \frac{J_o \omega \cdot r^2}{2\nu} \right) \end{array} \right]. \quad (13)$$

In Chapter 5, it is shown that $H_z \equiv 0$. Then

$$M(r) = \mu \cdot r \left[\begin{array}{l} (J_z + J_o)(H_r + H_{r_o}) - \\ -J_r \left(H_{2z_o} + \frac{J_o \omega \cdot r^2}{2\nu} \right) \end{array} \right]. \quad (14)$$

Formula (14) determines the density of the torque acting on the shaft in the layer with the radius r . Recall from Chapter 5 that

$$J_r = -j_r(r) \cos(\alpha\varphi + \chi z), \quad (15)$$

$$J_z = j_z(r) \sin(\alpha\varphi + \chi z), \quad (16)$$

$$H_r = h_r(r) \cos(\alpha\varphi + \chi z), \quad (17)$$

where

$$j_\varphi(r) = F_\alpha(r), \quad (18)$$

$$j_r(r) = (j_\varphi(r) + r \cdot j'_\varphi(r)) / \alpha, \quad (19)$$

$$j_z(r) = -\frac{\chi}{\alpha} r \cdot j_\varphi(r), \quad (20)$$

$$h_r(r) = j_\varphi(r) / \chi, \quad (21)$$

Here the constants χ , α and the Bessel function $F_\alpha(r)$ are defined in Chapter 5. Combining (14)-(17), we get:

$$M(r) = \mu \cdot r \left[\begin{array}{l} (j_z(r) \sin(\alpha\varphi + \chi z) + J_o) \cdot \\ \cdot (h_r(r) \cos(\alpha\varphi + \chi z) + H_{r_o}) + \\ -H_{2z_o} j_r(r) \cos(\alpha\varphi + \chi z) + \\ + \frac{J_o \omega \cdot r^2 j_r(r)}{2\nu} \cos(\alpha\varphi + \chi z) \end{array} \right] \quad (22)$$

The total torque is calculated as an integral of the following form:

$$\overline{M} = \iiint_{r,\varphi,z} M(r) dr d\varphi dz. \quad (23)$$

This integral can be represented as the sum of integrals as follows:

$$\overline{M} = \overline{M}_1 + \overline{M}_2 + \overline{M}_3 + \overline{M}_4 + \overline{M}_5 + \overline{M}_6, \quad (24)$$

where the summands are defined in Appendix 1.

These relationships allow the calculation of the mechanical torque in the Milroy engine.

In Appendix 1, it is shown that in the ordinary Milroy engine, the magnitude of moment (21) is negligible, if $\omega = 0$, i.e. there is no starting torque. However, when $H_{r0} \neq 0$ and/or $H_{z0} \neq 0$ there is a significant starting torque.

5. An Additional Experiment

We may propose an experiment, in which the previously suggested explanations of the reasons for the rotation of the Milroy engine are not acceptable (in the author's view). We should give the opportunity to the rod with the current to rotate freely. This can be realized in the following way shown in Figure 1. A copper roll with pointed ends is clamped between two carbon brushes so that it could rotate. The carbon brushes are needed in order that the contacts would not be welded at strong currents. In accordance with the theory contained in this paper, in such a structure the shaft must rotate. This will permit to refrain from the consideration of several hypothesis for the explanation of Milroy engine functioning.

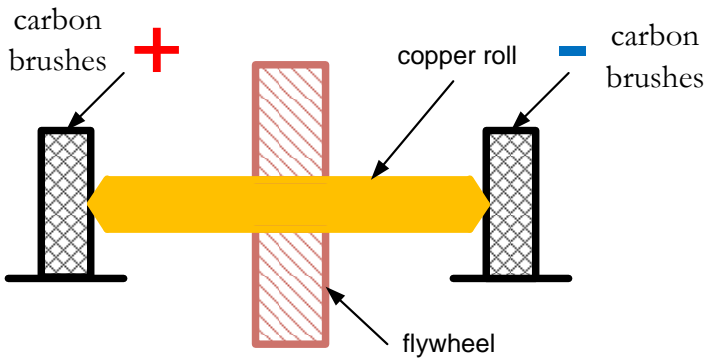

Fig. 1.

6. About the Law of Impulse Conservation

We need to pay attention to the fact that in the Milroy engine, the Law of mechanical impulse conservation is clearly violated. This is explained by the fact that in the rod, together with the flow of electromagnetic energy there are both an electromagnetic momentum and a mechanical momentum of equal magnitude, see in Chapter 13. A

mechanical impulse directed in a circle creates a mechanical moment of rotation.

Appendix 1. Calculation of the torque

We transform equation (3a.22). Then we get:

$$M(r) = \mu \cdot r \left[\begin{array}{l} j_z(r)h_r(r) \sin(\alpha\varphi + \chi z) \cdot \cos(\alpha\varphi + \chi z) + \\ + j_z(r) \sin(\alpha\varphi + \chi z)H_{r_0} + J_oH_{r_0} + \\ + \left[J_o \left(h_r(r) + \frac{\omega \cdot r^2 j_r(r)}{2v} \right) - H_{2z_0} j_r(r) \right] \cos(\alpha\varphi + \chi z) \end{array} \right]. \quad (1)$$

The total torque is calculated as an integral of the following form:

$$\overline{M} = \iiint_{r,\varphi,z} \mu \cdot r \left[\begin{array}{l} j_z(r)h_r(r) \sin(\dots) \cdot \cos(\dots) + \\ + j_z(r) \sin(\dots)H_{r_0} + J_oH_{r_0} + \\ + \left[J_o \left(h_r(r) + \frac{\omega \cdot r^2 j_r(r)}{2v} \right) - H_{2z_0} j_r(r) \right] \cos(\dots) \end{array} \right] dr d\varphi dz. \quad (2)$$

This integral can be represented as the sum of the following integrals:

$$\overline{M}_1 = \iiint_{r,\varphi,z} \mu \cdot r [J_o H_{r_0}] dr d\varphi dz, \quad (3)$$

$$\overline{M}_2 = \iiint_{r,\varphi,z} \mu \cdot r [j_z(r)h_r(r) \sin(\dots) \cdot \cos(\dots)] dr d\varphi dz, \quad (4)$$

$$\overline{M}_3 = \iiint_{r,\varphi,z} \mu \cdot r [j_z(r) \sin(\dots)H_{r_0}] dr d\varphi dz, \quad (5)$$

$$\overline{M}_4 = \iiint_{r,\varphi,z} \mu \cdot J_o r h_r(r) \cos(\dots) dr d\varphi dz, \quad (6)$$

$$\overline{M}_5 = \iiint_{r,\varphi,z} \mu \cdot J_o r \left(\frac{\omega \cdot r^2 j_r(r)}{2v} \right) \cos(\dots) dr d\varphi dz, \quad (7)$$

$$\overline{M}_6 = - \iiint_{r,\varphi,z} \mu \cdot r H_{2z_0} j_r(r) \cos(\dots) dr d\varphi dz \quad (8)$$

or

$$\overline{M}_1 = \mu \cdot J_o H_{r_0} \iiint_{r,\varphi,z} r dr d\varphi dz = \mu \cdot J_o H_{r_0} \pi R^2 L, \quad (9)$$

$$\overline{M}_2 = \mu \cdot \left(\int_r M_{2r}(r) dr \right) M_{S2}, \quad (10)$$

$$\overline{M}_3 = \mu \cdot H_{r_0} \left(\int_r M_{3r}(r) dr \right) M_{S3}, \quad (11)$$

$$\overline{M}_4 = \mu \cdot J_o \left(\int_r M_{4r}(r) dr \right) M_{S4}, \quad (12)$$

$$\overline{M}_5 = \frac{\mu \cdot \omega}{2v} J_o \left(\int_r M_{5r}(r) dr \right) M_{S4}, \quad (13)$$

$$\overline{M}_6 = -\mu \cdot H_{2z_0} \left(\int_r M_{6r}(r) dr \right) M_{S4}. \quad (14)$$

where

$$M_{S2} = \left(\iint_{\varphi,z} [\sin(\dots) \cdot \cos(\dots)] d\varphi dz \right), \quad (15)$$

$$M_{S3}(r) = \left(\iint_{\varphi,z} \sin(\dots) d\varphi dz \right), \quad (16)$$

$$M_{S4} = \left(\iint_{\varphi,z} \cos(\dots) d\varphi dz \right), \quad (17)$$

$$M_{2r}(r) = r \cdot j_z(r)h_r(r), \quad (18)$$

$$M_{3r}(r) = r \cdot j_z(r), \quad (19)$$

$$M_{4r}(r) = r \cdot h_r(r), \quad (20)$$

$$M_{5r}(r) = r^3 j_r(r), \quad (21)$$

$$M_{6r}(r) = r \cdot j_r(r). \quad (22)$$

These integrals (10)-(14) include the following functions $h_r(r)$, $j_r(r)$, $j_z(r)$, $f(r) = [j_z(r)h_r(r)]$ in (18)-(22).

It is important to note the following. In the usual Milroy engine there is no strengths H_{r0} , H_{2z0} . Moreover, terms (9), (11), and (14) are equal to zero, i.e. in the conventional Milroy motor there is the following equality:

$$\overline{M} = \overline{M}_2 + \overline{M}_4 + \overline{M}_5. \quad (23)$$

At $\omega = 0$ only the following torque is remaining:

$$\overline{M} = \overline{M}_2 + \overline{M}_4, \quad (24)$$

This torque is a starting in the usual Milroy engine and its magnitude is negligible. However, when $H_{r0} \neq 0$ and/or $H_{2z0} \neq 0$, the torque exists, even at $\omega = 0$. Consequently, when $H_{r0} \neq 0$ and/or $H_{2z0} \neq 0$ there is a significant starting torque.

Photos

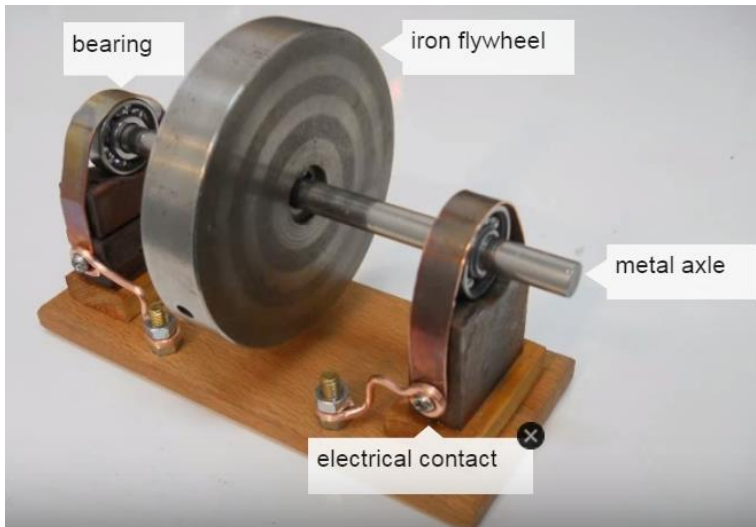

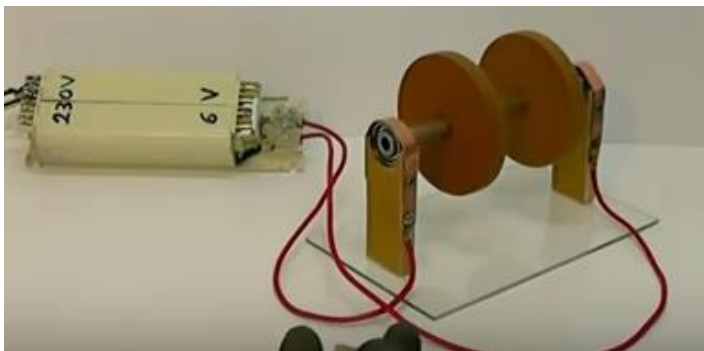
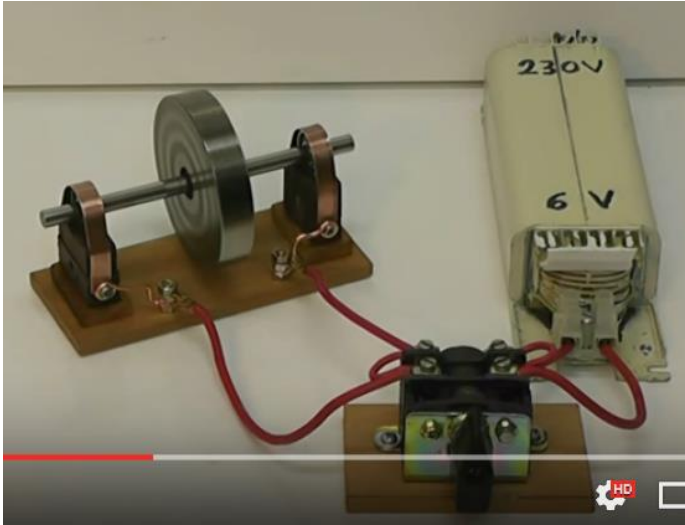

Chapter 5c. Magnetoresistance

The magnetoresistive effect is known as the fact that the electrical resistance of a material depends on the magnetic induction of the magnetic field in which the material is located, i.e. the magnetoresistance [114]. Below, we consider a conductor with direct current in a magnetic field and show that the existence of magnetoresistance directly follows from the solution of Maxwell's equations.

Chapter 5 dealt with the solution of Maxwell's equations for a wire with direct current. It shows that in a wire with direct current, the density of the Lorentz magnetic force acting along the wire axis is proportional to the Poynting vector representing the energy flux density. This force drives electrical charges. Namely this force overcomes the resistance of the material of the wire to the movement of charges.

Chapter 5a shows the calculation of this force. It is shown that it also depends on the strength of the external magnetic field. Consequently, the effect of an external magnetic field manifests itself as a change in the resistance of the wire.

Chapter 5d. The Solution of Maxwell's Equations for a Wire with a Constant Current in a Magnetic Field

Contents

1. Introduction \ 1
2. Wire with direct current \ 2
3. Wire in a longitudinal magnetic field \ 3
4. Solenoid with the electrically conductive core \ 3
5. Wire in a circular magnetic field \ 5
6. Wire in a transverse magnetic field \ 6
7. Summary \ 7
8. Strict solution for wire in a magnetic field \ 10

1. Introduction

Here we look at the wire under action of a constant magnetic field.

2. Wire with direct current

Chapter 5 deals with Maxwell's equations for a wire, through which direct current flows with a density of J_0 . The solution obtained in Chapter 5 can be used without changes in this case, too. The solution has the following form:

$$J_r = j_r(r) \cdot \text{co}, \quad (2)$$

$$J_\varphi = -j_\varphi(r) \cdot \text{si}, \quad (3)$$

$$J_z = j_z(r) \cdot \text{si}, \quad (4)$$

$$H_r = -h_r(r) \cdot \text{co}, \quad (5)$$

$$H_\varphi = -h_\varphi(r) \cdot \text{si}, \quad (6)$$

$$H_z = h_z(r) \cdot \text{si}, \quad (7)$$

$$\text{co} = -\cos(\alpha\varphi + \chi z), \quad (8)$$

$$\text{si} = \sin(\alpha\varphi + \chi z), \quad (9)$$

where α , χ are some constants, $j(r)$, $h(r)$ are some functions of the coordinate r , namely,

$$j_\varphi(r) = F_\alpha(r), \quad (10)$$

$$j_r(r) = (j_\varphi(r) + r \cdot j'_\varphi(r)) / \alpha, \quad (11)$$

$$j_z(r) = -\frac{\chi}{\alpha} r \cdot j_\varphi(r), \quad (12)$$

$$h_z(r) \equiv 0, \quad (13)$$

$$h_\varphi(r) = j_r(r)/\chi, \tag{14}$$

$$h_r(r) = j_\varphi(r)/\chi, \tag{15}$$

moreover, the function $F_\alpha(r)$ is a solution of the modified Bessel equation. For small values of r , this function takes the following form:

$$y = Ax^\beta, \tag{16}$$

where A is a constant, and

$$\beta = \frac{1}{2}(-3 \pm \sqrt{3 + 4\chi^2}), \quad \beta < 0. \tag{17}$$

Using these equations, it is already possible to perform calculations. However, the quantities A , α , χ should be known. The obtained solution determines the value of energy flux S entering the wire, i.e. power P that enters the wire. Thus, the values of A , α , χ determine the magnitude of the power P .

The value of J_o is determined by the magnitude of the power P and the load resistance. The existence of some nonzero current density J_o ensures the existence of some nonzero solution of the set of Maxwell's equations that follows from the following equation:

$$\frac{H_\varphi}{r} + \frac{\partial H_\varphi}{\partial r} - \frac{1}{r} \cdot \frac{\partial H_r}{\partial \varphi} = J_z, \tag{18}$$

Indeed, if J_z exists, then the magnetic field strength H_r and \ or H_φ must also exist. At the same time, the Maxwell set of equations must have a nonzero solution. However, the constant J_o is not formally included in the solution of these equations. This is explained by the fact that J_o creates the strength $H_{\varphi o} = J_o r$ and both these values of $H_{\varphi o}$ and J_o can be excluded from equation (18).

Chapter 5 shows that the density of this energy flow is determined (in the SI system) by the following formula:

$$S(r) = \rho \left(j_r(r)h_\varphi(r) - j_\varphi(r)h_r(r) \right), \tag{19}$$

where ρ is the resistivity of the wire. So, the solution of Maxwell's equations in the form of functions $j(r)$, $h(r)$ determines the energy flux density $S(r)$. Obviously, there is an inverse relationship: $S(r)$ defines the functions $j(r)$, $h(r)$. This inverse problem is mathematically much more complicated than the solution considered. However, for further consideration it is important to emphasize that Nature solves this inverse problem.

3. Wire in a longitudinal magnetic field

In Section 2, it was assumed that there is a direct current with a density J_o in the wire. This current is created by the flow of energy entering the wire from the end. Suppose now that there is the longitudinal component H_z of the magnetic field strength. The existence of the nonzero longitudinal component H_z nonuniformly distributed along the radius ensures the existence of a nonzero solution of the set of Maxwell's equations. This statement follows from the following equation:

$$\frac{\partial H_r}{\partial z} - \frac{\partial H_z}{\partial r} = J_\varphi, \quad (1)$$

Indeed, if there is $\frac{\partial H_z}{\partial r}$ (since there is the magnetic strength H_z unevenly distributed along the radius) then there must be a magnetic strength H_r and current density J_φ . Moreover, the Maxwell set of equations must have a nonzero solution. It still has the form given in Section 2.

It follows that in a wire under action of a nonuniform longitudinal magnetic field there is a solution to the Maxwell equations in the form given in Section 2. Therefore, there is an energy flow in this wire, the density of which is determined by expression (2.19). The source of the magnetic strength H_z obviously is the source of this energy flow.

This energy flow generates a longitudinal constant current in the wire. Thus, there is a conversion of the energy of the longitudinal constant magnetic field in the wire into electrical energy transferred by direct current along the wire.

4. Solenoid with the electrically conductive core

Consider a solenoid with a core. The current in the coil of the solenoid creates a magnetic field strength in the rod. However, the magnetic field inside the ideal solenoid is uniform. In accordance with the above, in this case, the current in the rod does not occur. However, if the coils of the solenoid were wound imperfectly (inclined to the axis, randomly, etc.) or the solenoid is short, then, according to the above, a current appears in the solenoid rod.

There is another reason for the appearance of current in an electrically conductive core, acting also in an ideal solenoid

The power consumed by a DC solenoid with a core is greater than that consumed by a solenoid without a core. The reason is that the magnetization of the core decreases under the action of thermal motion of the atoms and must be restored all the time by the magnetization current.

This means that in the core there is an electromagnetic energy flux equal to the bias power to counteract the chaotic orientation of the domains under the influence of thermal energy of the environment. The flow of electromagnetic energy creates an electric current in the wire, namely in the electrically conductive core.

In this sense, a DC solenoid with a core can be compared with a capacitor discharging on the resistance of a dielectric material.

Consequently, in a DC solenoid with an electrically conductive core, there should be an electromagnetic field, in which there is the longitudinal component of the electrical field strength and energy flow. When there is energy flow in the solenoid, the electrical field strengths must exist. In this case, the Maxwell equations for a solenoid in the system of the cylindrical coordinates r, φ, z completely coincide with the equations for the direct current wire. The difference is that the longitudinal flow of energy S_z

- in the DC wire is equal to the power transmitted through the wire to the load,
- in the solenoid, it is equal to the bias power to counteract the influence of thermal energy of the environment.

5. Wire in a circular magnetic field

Now suppose that there is the circular magnetic strength H_φ unevenly distributed along the radius. The existence of such strength ensures the existence of a nonzero solution of the set of Maxwell's equations. This statement follows from the following equation:

$$\frac{H_\varphi}{r} + \frac{\partial H_\varphi}{\partial r} - \frac{1}{r} \cdot \frac{\partial H_r}{\partial \varphi} = J_z, \quad (1)$$

Indeed, if there is $\frac{\partial H_\varphi}{\partial r}$ (since there is the magnetic strength H_φ unevenly distributed along the radius) then there must be the magnetic strength H_r and \ or current density J_z . Moreover, the Maxwell set of equations must have a nonzero solution.

Similar to the previous one, it follows that in the wire under action of an inhomogeneous circular magnetic field there is a solution to Maxwell's equations in the form given in Section 2. Consequently, there is an energy flow in this wire, the density of which is determined by (2.19). Energy flow, obviously, is the source of magnetic strength H_φ .

This energy flow generates a longitudinal constant current in the wire. Thus, there is a conversion of the energy of the ring constant magnetic field in the wire into electrical energy transferred by direct current along the wire.

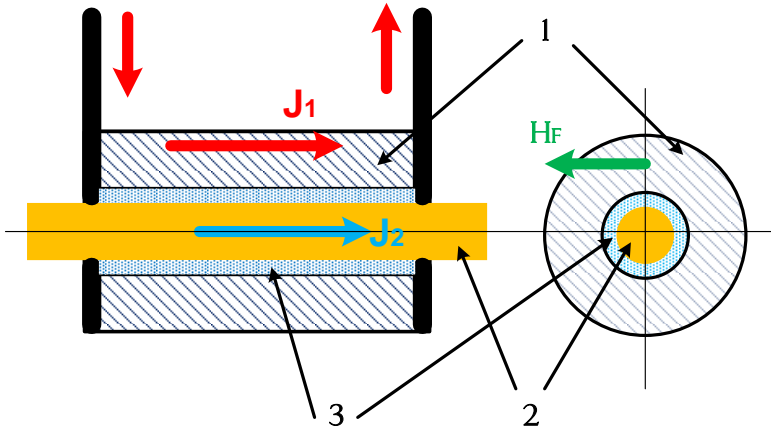

Fig. 1.

Example 1.

Figure 1 shows tubular wire 1, inside of which wire 2 passes, insulated from wire 1 by dielectric material 3. If current J_2 flows through wire 2, then a ring magnetic field H_ϕ appears in the body of wire 1. In accordance with the above, a circular ring magnetic field in wire 1 creates the constant current J_1 in this wire. The effect should be stronger if wire 1 is ferromagnetic.

6. Wire in a transverse magnetic field

Now suppose that there is the transverse magnetic strength H_r . The existence of such a strength ensures the existence of a nonzero solution of the set of Maxwell equations. This follows from the following equation:

$$\frac{H_\phi}{r} + \frac{\partial H_\phi}{\partial r} - \frac{1}{r} \cdot \frac{\partial H_r}{\partial \phi} = J_z,$$

Indeed, if H_r exists, then magnetic strength H_ϕ and \ or current density J_z must exist. Moreover, the Maxwell set of equations must have a nonzero solution.

Similar to the previous one, it follows that in the wire under action of a radial magnetic field there is a solution to Maxwell's equations in the form given in Section 2. Therefore, there is an energy flow in this wire, the density of which is determined by (2.19). The source of magnetic strength H_r obviously is the source of this energy flow.

This energy flow generates a longitudinal constant current in the wire. Thus, there is a conversion of the energy of the radial constant

magnetic field in the wire into electrical energy transferred by direct current along the wire.

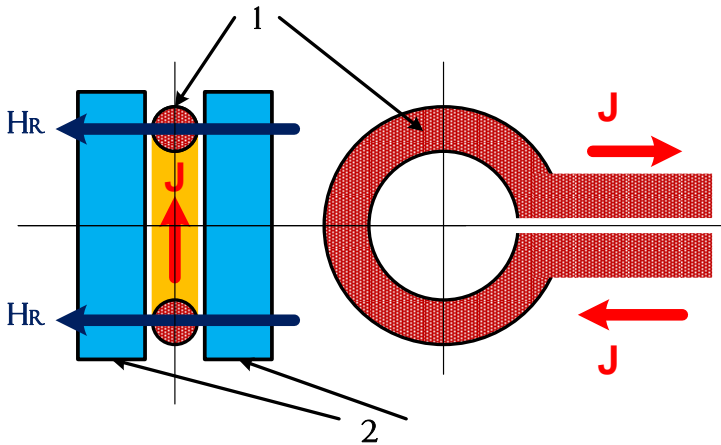

Fig. 2.

Example 1.

Figure 2 shows annular wire 1 located in the gap of two permanent magnets 2. The magnetic field strength in this gap is the component H_r that penetrates wire 1 along the radius. In accordance with the above, the radial magnetic field in wire 1 creates a constant current J in this wire. The effect should be stronger if wire 1 is ferromagnetic.

Example 2.

The magnetic strength H_r can be created by a permanent ring magnet in the wire representing the winding of this permanent magnet, see in Figures 3 and 4.

Example 3.

The Beaulieu effect is known but still not explained. This effect can be described as follows. An electric current flows in a conductor located between the same ends of two magnets. The magnetic field strength in the gap can be decomposed into longitudinal (along the conductor) and transverse (radial) components. Obviously, the longitudinal component due to symmetry cannot excite current. The radial component H_r (equal to zero in the center of the conductor) generates a longitudinal DC current in the wire.

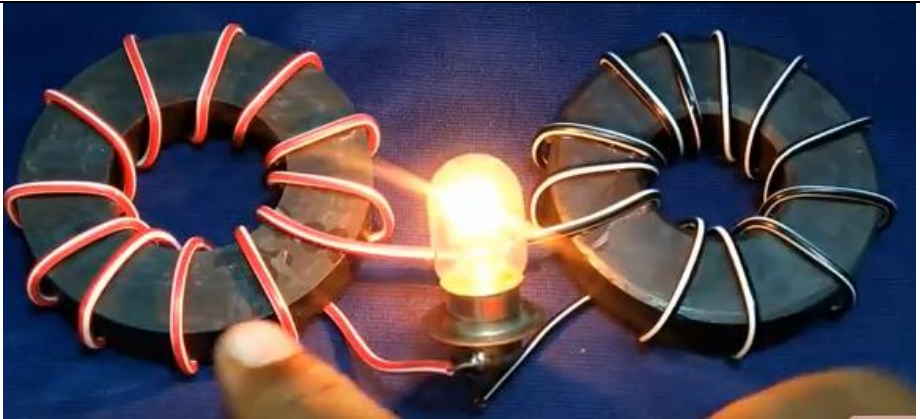

Fig. 3. Borrowed from <https://www.youtube.com/watch?v=sPH1WNXMlow>.



Fig. 4. Borrowed from <http://www.inventedelectricity.com/free-energy-generator-magnet-coil-100-real-new-technology-new-idea-project/>

7. Summary

The above shows that

1. The flux of electromagnetic energy is transmitted from a source of magnetic field to a wire in a magnetic field.
2. In a magnetic field, a flux of electromagnetic energy circulates together with a magnetic flux.

3. The flow of electromagnetic energy creates an electromotive force that moves the charges in the wire, see in Chapter 15.

4. In this case, in the wire there is a longitudinal constant current.

The experiments shown in Section 5 are often viewed as generators of unlimited energy stored in permanent magnets. However, in fact, they demonstrate the exact opposite, namely the limited energy of the permanent magnet: the light bulbs gradually go out.

8. Strict solution for wire in a magnetic field.

Let us consider again the Maxwell equations for the direct current wire from Appendix 1 in Chapter 5. It shows that for the wire, their solution reduces to solving the following set of six homogeneous equations:

$$\frac{j_r(r)}{r} + j'_r(r) + \frac{j_\varphi(r)}{r} \alpha + \chi j_z(r) = 0, \quad (1)$$

$$\frac{h_z(r)}{r} \alpha - \chi h_\varphi(r) = j_r(r), \quad (3)$$

$$-h_r(r) \chi - h'_z(r) = j_\varphi(r), \quad (4)$$

$$\frac{h_\varphi(r)}{r} + h'_\varphi(r) + \frac{h_r(r)}{r} \alpha = j_z(r), \quad (5)$$

$$\frac{j_z(r)}{r} \alpha - \chi j_\varphi(r) = 0, \quad (6)$$

$$-j_r(r) \chi - j'_z(r) = 0. \quad (7)$$

The following known functions can be added to these equations:

$$h_{r0}(r), h_{\varphi0}(r), h_{z0}(r).$$

The obtained set of equations can be resolved numerically.

Consider the special case when a magnetic field is created in a vacuum. Then equations containing electric currents can be excluded from the set of eight equations for the wire. In this case, we obtain a set of four equations of the following form:

$$\frac{h_r(r)}{r} + h'_r(r) + \frac{h_\varphi(r)}{r} \alpha + \chi h_z(r) = 0, \quad (10)$$

$$\frac{h_z(r)}{r} \alpha - \chi h_\varphi(r) = 0, \quad (11)$$

$$-h_r(r) \chi - h'_z(r) = 0, \quad (12)$$

$$\frac{h_\varphi(r)}{r} + h'_\varphi(r) + \frac{h_r(r)}{r} \alpha = 0. \quad (13)$$

This set is similar, up to the notation, to the set of equations (2)-(5) considered in Appendix 2 of Chapter 5, see the *Hvaku.m* function.

Example 1.

Consider the known Magnetic Gate Bedini. This technical device is known in the Internet. This device allegedly demonstrates the receipt of energy > 1 . The device contains many magnets located around the circumference and magnetized along the radius, see in Figure 5. The configuration of the magnetic field in the cylindrical coordinates (r, φ, z) is shown in Figure 6 by the dashed lines. In this figure, R is the radius of the inner cylinder, N and S are the poles of the magnets, H_{r0} is the magnetic strength at the end of the magnets.

It is seen that in the vicinity of the device, a magnetic field is created in which there are radial and axial components. In accordance with Maxwell's equations there are

$$\text{rot}(H) = 0, \tag{14}$$

$$\text{div}(H) = 0. \tag{15}$$

A circular magnetic field also appears in it. The solution of these equations (as shown in Chapter 5) has the following form:

$$H_r = h_r \cos(\alpha\varphi + \chi z + \delta), \tag{15}$$

$$H_\varphi = h_\varphi \sin(\alpha\varphi + \chi z + \delta), \tag{16}$$

$$H_z = h_z \sin(\alpha\varphi + \chi z + \delta), \tag{17}$$

where α, χ, δ are some constants, $h(r)$ are some functions of the coordinate r . These functions are related by equations (10)-(13) and have a unique solution for given values of the parameters α, χ .



Fig. 5.

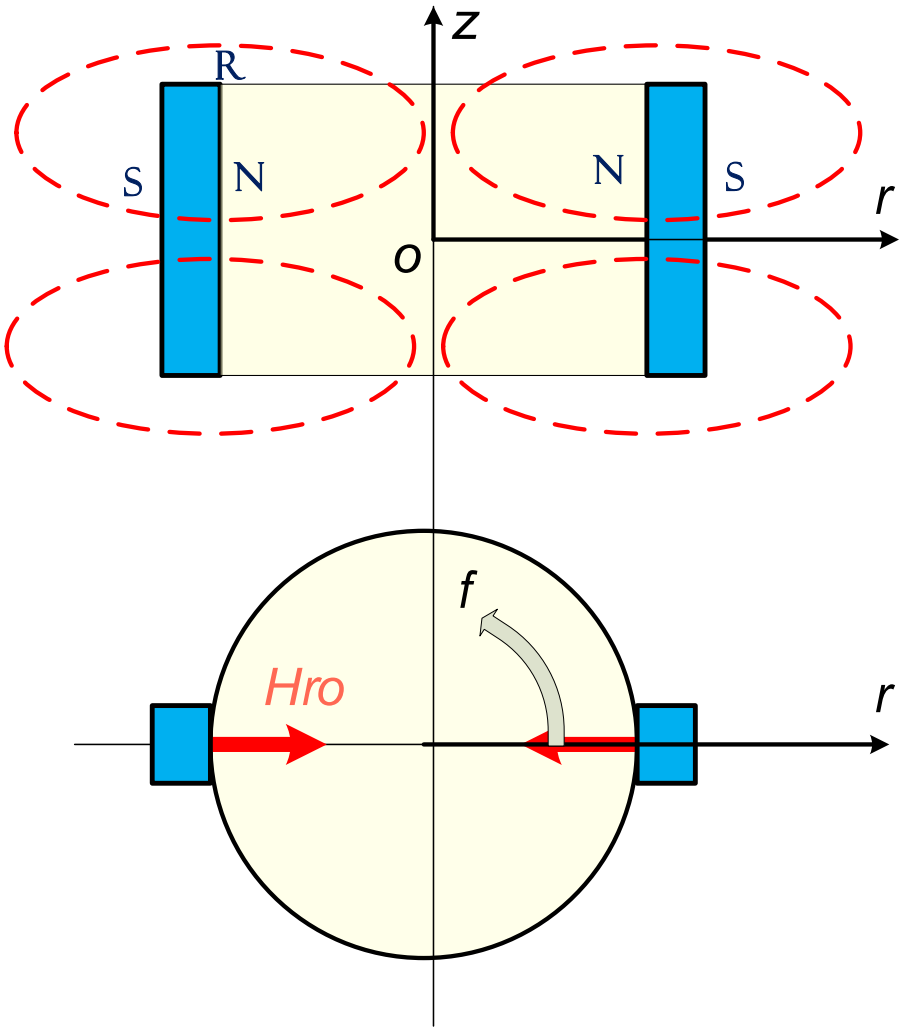

Fig. 6.

The lines with constant values of the magnetic strength are helical lines shown in Figure 7. If a magnet enters such a magnetic field, then it must rotate in this spiral. If this magnet cannot change its position in height, then it rotates around the circumference.



Рис. 7.

Example 2.

Consider the magnetic gateway Bedini that has in the SI system $R = 0.1$, the magnetic induction at the end face of the magnet is $B = 1.35$, and the magnetic strength outside the end face of the magnet $H_{r0} = 1.1 \times 10^6$. At $\delta \rightarrow 0$ we obtain $h_r(R) = 1.05 \times 10^6 \approx H_{r0}$ and the constants $\alpha = 0.005$, $\chi = 0.00002$. The functions $h_r(r), h_\varphi(r), h_z(r)$ are shown in Figure 8. Since the constants are small, functions (15)-(17) can be simplified and they take the following forms:

$$H_r = h_r \cos(\delta), \tag{19}$$

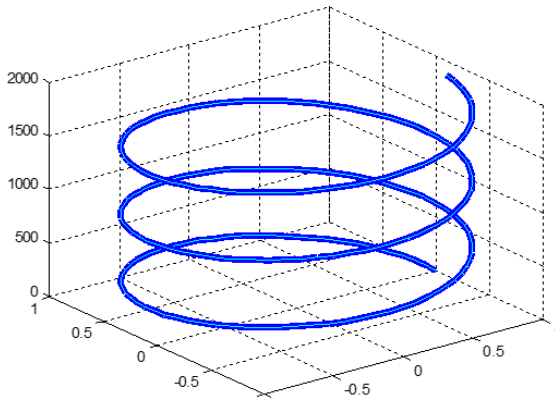
$$H_\varphi = h_\varphi \sin(\delta), \tag{20}$$

$$H_z = h_z \sin(\delta). \tag{21}$$

Obviously, the constant δ can be determined from the following condition:

$$H_{r0} = h_r(R) \cos(\delta). \tag{22}$$

Apparently, just in the same way the reader can create an "electric gateway" of electrets. If the magnetic and electric gateways are combined, then a constant electromagnetic field will appear in the cavity of such a combined gateway. In such an electromagnetic field, a flow of electromagnetic energy will arise, which will rotate around the circumference. In this way, a DC motor can be built.

Such an engine uses the magnetic energy of magnets and the electrical energy of electrets. Continuous operation of such an engine will mean that magnets and electrets are fueled by environmental energy, namely the thermal energy of air, see in Chapter 7b.

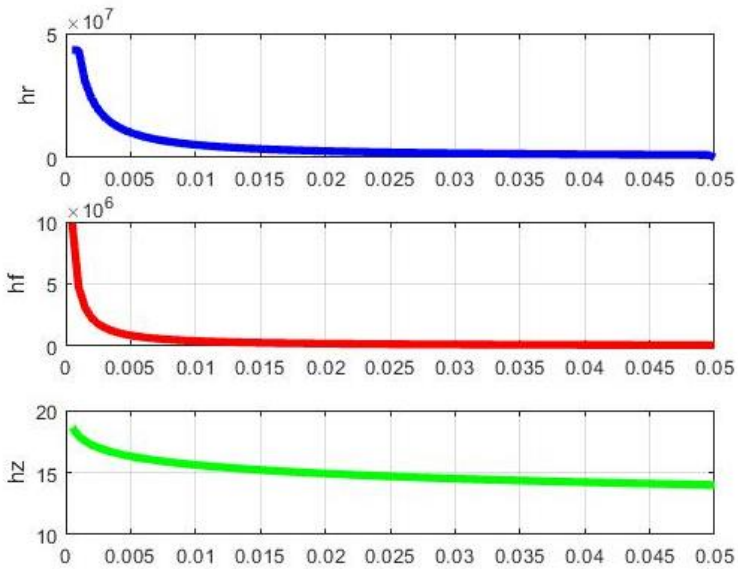

Fig. 8. (Hvaku.m)

Obviously, the reader can use electromagnets instead of magnets, and a voltage source connected between the center and the outer circumference of the gateway can be used instead of electrets. This results in a very simple brushless DC motor.

Chapter 5h. The Solution of Maxwell's Equations for a Rotating Ferromagnetic Wire

Contents

1. Introduction \ 1
2. The Barnett Effect \ 1
3. Aspden effect \ 2
4. Appendix 1 \ 3

1. Introduction

Eichenwald [86] has considered a rotating charged disk that excites a magnetic field. Eichenwald calls these rotating charges the convection current. His experiment is among a number of classical and indisputable experiments. In [153], the question of the existence of a magnetic field of a rotating **uncharged** body is considered. In fact, the appearance of such an effect should be expected due to the existence of free electrons that are not rigidly connected with the atomic nucleus. The authors of work [153] indicate that “simple estimates predict an anomalously large value of the induction of the magnetic field created by a body whose velocity relative to the laboratory system is far from relativistic ... Therefore, experimental detection of the effect becomes relevant.” Further, the authors find estimates of the induction of this magnetic field. Numerical estimates are also given, from which it follows that magnetic induction can reach several mT. This estimate, apparently, can be increased tenfold if the material of the body is magnetically soft. In short, estimates show that this effect can be detected experimentally.

2. The Barnett Effect

It seems to us that this has already happened a long time ago: it is known the Barnett effect [154] representing the magnetization of ferromagnets during their rotation in the absence of a magnetic field. In the existing explanation, it is assumed that magnetization is created due to the fact that the rotating domains exhibit the properties of gyroscopes. But for this it is necessary first that the domains rotate around their own

axis but not around the common axis. Second and this is the main thing, such a method of magnetization is not observed as yet.

3. Aspden effect

There is another effect, for which there is no generally accepted explanation but which can be explained by the existence of a magnetic field of a rotating uncharged body. This refers to the Aspden effect [155, 164]. It consists in the following.

The rotor of an electric machine spins up to certain rotation speed in any direction, rotates at this speed for several minutes, and then abruptly stops. In this case, the energy spent on acceleration is measured. This experiment is repeated under the following two conditions:

1. The rotor spins after a long state of rest to a certain speed and then abruptly stops,

2. The rotor spins up and stops as in case 1. However, after a short time interval it spins up again to the same speed.

It was found that in the second case, it took ten times less energy to spin the rotor to the same speed if it was again brought into rotation in less than 60 seconds. This fact required explanation. Aspden declares the existence of “virtual inertia” to explain this fact. It is shown below that this effect can be explained by the existence of a magnetic field of a rotating uncharged body.

It follows from the foregoing that a rotating rotor can be considered as a rotating uncharged body, in which currents circulate through rotation around circles. It is natural to assume that the amplitudes of these currents are approximately proportional to the radius of the circle. Based on this assumption, Appendix 1 shows that there is an electromagnetic field in the rotor with the following components:

- the currents and magnetic field strengths directed along radii, around a circle, and along an axis,
- some constant flows of electromagnetic energy along radii, around a circle, and along an axis, moving at a speed significantly less than the speed of light,
- the angular momentum relative to the axis of rotation,
- the electromagnetic energy.

Energy flux carries away electromagnetic energy, turning it into thermal energy. But when the rotor rotates, its electromagnetic energy is constantly replenished and all of the indicated components of the electromagnetic field of the rotor are constantly present.

When the rotor stops, all of these components gradually disappear due to thermal scattering during the flow of currents. It is important to note that the propagation velocity of energy flows is significantly less than the speed of light. Therefore, the process of the disappearance of these components does not end instantly.

In our case, it is important to state that for some time the angular momentum of the rotor is maintained relative to the axis of rotation. This explains the Aspden effect.

The reader can notice that these experiments have much in common with the Milroy engine, see in Chapter 5a. In all these cases, a convection current and the resulting torque are generated in the rotating body. In the Milroy engine, this moment is the main but it is an additional in the cases considered above. This issue is discussed in more detail in Appendix 1.

Appendix 1.

Chapters 5 and 5a discuss the solution of Maxwell's equations for direct current wires. The magnetic field strengths and current densities appear in a wire because the longitudinal component of the direct current flows through the wire. In the cases considered above, the magnetic field strengths and current densities appear in a rotating body because a circular convection direct current flows through the wire.

It further follows from Chapter 5 that these magnetic field strengths and current densities determine the flows of electromagnetic energy in the wire and in our case in the rotating rotor. So, in this rotor there are the following constant flows of electromagnetic energy:

$$S_r = \rho \int_r \boxed{S_r} dr = \text{const}, \quad (5.3.42)$$

$$S_\varphi = \rho \int_\varphi \boxed{S_\varphi} d\varphi = \text{const}, \quad (5.3.43)$$

$$S_z = \rho \int_z \boxed{S_z} dz = \text{const}. \quad (5.3.44)$$

where ρ is the resistivity of the rotor material and the densities of these flows are defined by

$$\boxed{S_r} = (j_\varphi h_z - j_z h_\varphi), \quad (5.3.39)$$

$$\boxed{S_\varphi} = (j_z h_r - j_r h_z), \quad (5.3.40)$$

$$\boxed{S_z} = (j_r h_\varphi - j_\varphi h_r). \quad (5.3.41)$$

Thus, in the rotor there are the constant flows of electromagnetic energy along the radii, around the circumference, and along the axis.

The density of currents corresponds to the electric field strength as follows:

$$\mathbf{e}(r) = \rho(r) \cdot \mathbf{j}(r). \quad (1)$$

The electromagnetic energy W_m in the rotor is determined by the following formula:

$$W_m = L \int_r w(r) dr, \quad (2)$$

where there is the following magnetic energy density

$$w(r) = \mu(h_r^2 + h_\varphi^2 + h_z^2) + \varepsilon(e_r^2 + e_\varphi^2 + e_z^2), \quad (3)$$

In (3), μ is the absolute magnetic permeability of the rotor material, ε is the absolute electric permittivity of the rotor material, and L is the length of the rotor.

Chapter 13 shows that the flow of electromagnetic energy travels at a speed

$$v = w/s. \quad (4)$$

In the rotor there are fluxes of the electromagnetic energy that propagate at speeds

$$v_r = w/\boxed{S_r}, \quad v_\varphi = w/\boxed{S_\varphi}, \quad v_z = w/\boxed{S_z}. \quad (5)$$

It is important to note that these speeds are significantly less than the speed of light.

Chapter 13 also shows that the density of the electromagnetic pulse p can be determined through the density of electromagnetic energy w and the flux density of electromagnetic energy s by

$$p = w^2/s, \quad (6)$$

In the rotor there are electromagnetic pulses directed in the same way as electromagnetic energy flows, i.e. along the radii, around the circumference, and along the axis, namely:

$$p_r = w^2/\boxed{S_r}, \quad p_\varphi = w^2/\boxed{S_\varphi}, \quad p_z = w^2/\boxed{S_z}. \quad (7)$$

The density of the electromagnetic momentum acting on a circle of radius r corresponds to the density of the momentum relative to the axis of the rotor, namely:

$$m(r) = r \cdot p_z(r). \quad (8)$$

The moment of the electromagnetic momentum acting on the entire rotor is

$$M = L \int_r m(r) dr. \quad (9)$$

Chapter 5m. Refine Bio-Savar-Laplace law

Annotation

It is indicated that the Biot-Savart-Laplace law is not derived from Maxwell's equations, but is the result of solving Maxwell's equations for a wire with direct current. It is shown that a direct current wire creates in its vicinity a magnetic induction vector, the cylindrical projections of which are determined in a form close to the original formula. It is shown, in addition, that along with the magnetic flux, a flux of electromagnetic energy propagates, which is part of the power of the current source. It is shown that the vector potential has no formal connection with Maxwell's equations and its application in physics is devoid of substantiation by such a connection

Contents

1. Introduction
2. Mathematical model
3. Strengths in the vicinity of the wire
4. Energy flow
5. Discussion

1. Introduction

The Bio-Savart-Laplace (BSL) law was obtained experimentally and its formula has a well-known form:

$$\mathbf{H}(\mathbf{r}) = \frac{1}{c} \int \frac{[\mathbf{j}(\mathbf{r}'), (\mathbf{r} - \mathbf{r}')]}{|\mathbf{r} - \mathbf{r}'|^3} d^3\mathbf{r}'. \quad (1)$$

It is generally accepted that "*this law is a consequence of two Maxwell's equations for the magnetic field, provided that the electric field is constant*" [206]. The conclusion is as follows. A vector potential is introduced that satisfies the equation

$$\mathbf{H} = \text{rot}(\mathbf{A}), \quad (2)$$

and the gauge invariance condition

$$\text{div}(\mathbf{A}) = 0. \quad (3)$$

Путем преобразования этих уравнений выводится закон БСЛ в виде уравнения (1). Этот закон устанавливает зависимость магнитной напряженности от постоянного тока проводимости. Известно также

уравнение Максвелла, связывающее магнитную напряженность с постоянным током проводимости, а именно

$$\text{rot}(H) = J. \quad (4)$$

By transforming these equations, the BSL law is derived in the form of equation (1). This law establishes the dependence of the magnetic strength on the direct current of conduction. Also known is the Maxwell equation, which relates the magnetic strength to the constant conduction current, namely

1. If we agree that all phenomena in the field of electrodynamics are described by Maxwell's equations, then we must admit that equation (1) is not rigorous and requires refine. But this in no way diminishes the merits of the authors of this law, who were able to discover and formulate it from scratch, when there was nowhere to wait for clues. The proposed article is devoted to refine this law.

2. The vector potential has no formal connection with Maxwell's equations. We also note that the condition of gauge invariance can be met in many ways, which introduces arbitrariness in physics, which contradicts the very spirit of classical physics. At the same time, the application of this condition in the indicated proof serves as a justification for the further use of the vector potential in other areas of physics [13]. But since the vector potential has no formal connection with Maxwell's equations, its application is devoid of this justification.

Further, it will be shown that, at least for a long wire, the vector potential can be dispensed with and the solution is complete, confirmed experimentally, but more complicated than in the existing BSL.

2. Mathematical model

It was shown in Chapter 5 that Maxwell's equations for a DC wire have the form

$$\text{rot}(J) = 0, \quad (a)$$

$$\text{rot}(H) - J - J_o = 0, \quad (b)$$

$$\text{div}(J) = 0, \quad (c)$$

$$\text{div}(H) = 0. \quad (d)$$

where H, J are magnetic strengths and current densities. We will use cylindrical coordinates r, ϕ, z and consider

- the main current density of the oz axis J_o ,
- density of additional currents J_r, J_ϕ, J_z ,
- magnetic strengths H_r, H_ϕ, H_z are radial, circumferential and longitudinal, respectively.

It is important to note that the full system of Maxwell equations is used, and not the abbreviated system of two equations (b, d), which is considered acceptable for magnetostatics. Such a short system does not provide a solution even for a DC wire. In contrast, a complete system of equations allows you to find a solution for the flow of energy **inside** (rather than outside) the wire.

In Chapter 5, the solution of Maxwell's equations for a direct current wire is considered in detail and it is proved that the solution exists only for nonzero additional currents J_r, J_φ, J_z . The solution has the following form:

$$J_r = j_r(r) \cos(\alpha\varphi + \chi z), \quad (12)$$

$$J_\varphi = j_\varphi(r) \sin(\alpha\varphi + \chi z), \quad (13)$$

$$J_z = j_z(r) \sin(\alpha\varphi + \chi z), \quad (14)$$

$$H_r = h_r(r) \cos(\alpha\varphi + \chi z), \quad (15)$$

$$H_\varphi = h_\varphi(r) \sin(\alpha\varphi + \chi z), \quad (16)$$

$$H_z = h_z(r) \sin(\alpha\varphi + \chi z), \quad (17)$$

where

$j(r), h(r)$ are some functions of the r coordinate,
 α, χ are some constants.

In [3] it was proved that in a direct current wire the trajectory of a point with a constant current density and constant magnetic strengths on a cylinder of constant radius is a helix. In addition, many trajectories pass through each circle, on which the strengths and current densities change sinusoidally depending on φ . Hence,

the line on the cylinder of constant radius, along which the point moves so that all strengths and current densities remain constant, is a helical line.

For example, in Fig. 1 shows three helical lines described by stream functions: a thick line at $\alpha = 2, \chi = 0.8$, a middle line at $\alpha = 0.5, \chi = 2$, and a thin line at $\alpha = 2, \chi = 1.6$.

Further, it will be shown that outside the wire (where there is no current), the line with constant magnetic intensity on a cylinder of constant radius is a helical line.

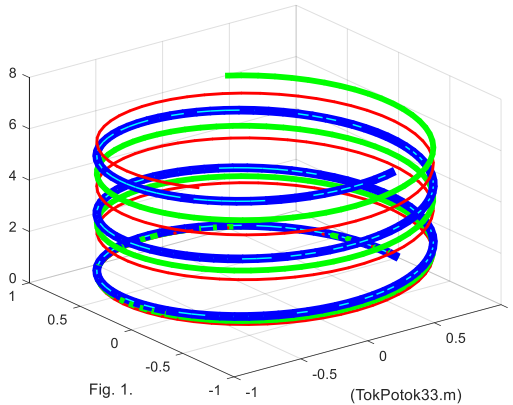

The very fact of the existence of a magnetic field with a spiral configuration around a conductor with a constant current was established by Oersted in 1820 [127, p. 184]. In fig. 2 shows a photograph of a wire soaked in magnetic fluid (magnified 20 times). The spiral lines formed by the magnetic fluid are visible. This photograph indicates the existence of spiral lines of magnetic strengths.



Fig. 2.

3. Strengths in the vicinity of the wire

The solution obtained in [3] makes it possible to find the magnetic field created by the current outside the wire. To do this, it is enough to take the solution at $r > R$, where R is the radius of the wire. In this case, we find that the magnetic strengths outside the wire are determined by the following formulas:

$$h_z''(r) + h_z'(r) - h_z(r) \left(\frac{\alpha^2}{r^2} + 1 \right) = 0 \tag{1}$$

$$h_\varphi(r) = -\frac{\alpha}{\chi} \frac{h_z(r)}{r}, \tag{2}$$

$$h_r(r) = \frac{-1}{\chi} h_z'(r). \tag{3}$$

With the known function $h_z(r)$, functions (2, 3) can be found. The solution to equation (1) is the modified Bessel function. In fig. 3 shows the functions (1, 2, 3) for

$$\alpha = 0.25, \chi = 0.5, R = 0.002, r > R. \tag{4}$$

In accordance with the BSL law, the function of the circumferential magnetic intensity of an infinitely long wire has the form:

$$h_{BSL}(r) = \frac{J_0}{4\pi r}. \tag{5}$$

This formula, as a special case of the BSL law, has been repeatedly tested experimentally and there is no doubt about it. But our task is to refine the BSL law so that it becomes a real consequence of Maxwell's equations.

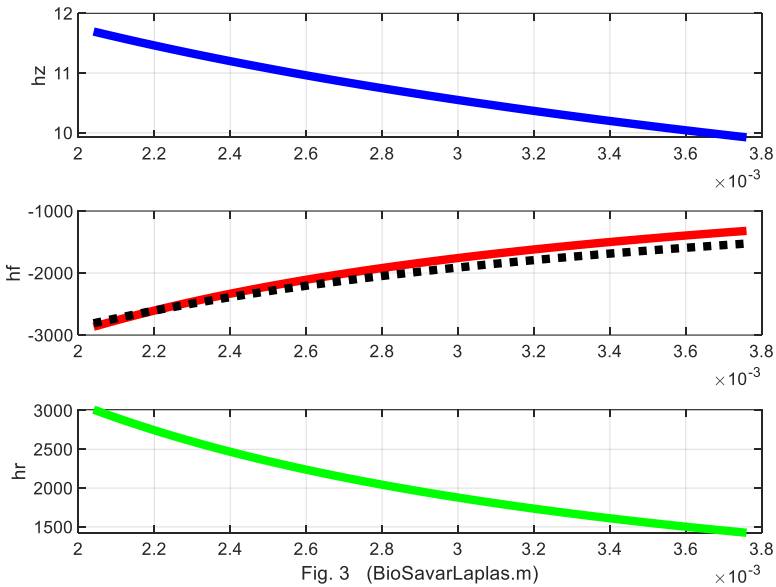

Fig. 3 (BioSavarLaplas.m)

In the second window in Fig. 3 the dotted line shows a function of the form

$$h_{\varphi 2}(r) = \frac{R h_\varphi(R)}{r}. \tag{6}$$

This example shows that function (6) is a good approximation of function (2), i.e.

$$h_{\varphi 2}(\mathbf{r}) \approx h_{BSL}(\mathbf{r}). \quad (7)$$

Thus, an analytical relationship was obtained between the strength $h_{BSL}(\mathbf{r})$, perpendicular to the wire and determined by the BSL law for an infinitely long wire, and the result $h_{\varphi 2}(\mathbf{r})$ of solving Maxwell's equations for a wire with direct current.

The BSL law establishes that there are no other projections of the strengths created by the current in the wire, except for $h_{BSL}(\mathbf{r})$. In order for the BSL law to be completely a consequence of Maxwell's equations, it must be assumed that there are still strengths directed along the radius of the wire $h_r(\mathbf{r})$ and along the axis $h_z(\mathbf{r})$ of the wire. So, the refined BSL law is that

a wire with direct current creates a vector of magnetic strength in the vicinity of the wire, the cylindrical projections of which are determined by (1, 2, 3)

All these strengths are created by current in a section perpendicular to the radius r . Thus, the strengths of an infinitely long wire have the form (2.15, 2.16, 2.17), where the values $h(\mathbf{r})$ included in these formulas are determined by (1-3).

In fig. 4 shows the hodograph of the strength vector

$$\vec{H}_{zf} = \vec{H}_z + \vec{H}_f, \quad (8)$$

where the terms vectors are defined by (2.12, 2.13) for fixed values of the coordinates r, φ . The hodograph is constructed under conditions (4) and

$$r = 0.0026, \quad \varphi = 0, \quad h_{\varphi}(\mathbf{r}) = -2000, \quad h_z(\mathbf{r}) = 11. \quad (9)$$

A point with certain vectors values \vec{H}_z, \vec{H}_f is highlighted on the wire. Their sum \vec{H}_{zf} is indicated by a point on the hodograph. It should be noted that the modulus of the vector \vec{H}_z is much less than the modulus of the vector \vec{H}_f - see also Fig. 3. This was the reason that the authors of the BSL law did not notice this projection of strength. The values of the projections H_f and H_r coincide in order of magnitude. Apparently in those ancient times it was difficult to determine the direction of the magnetic induction vector. Nowadays, H_r can be found experimentally.

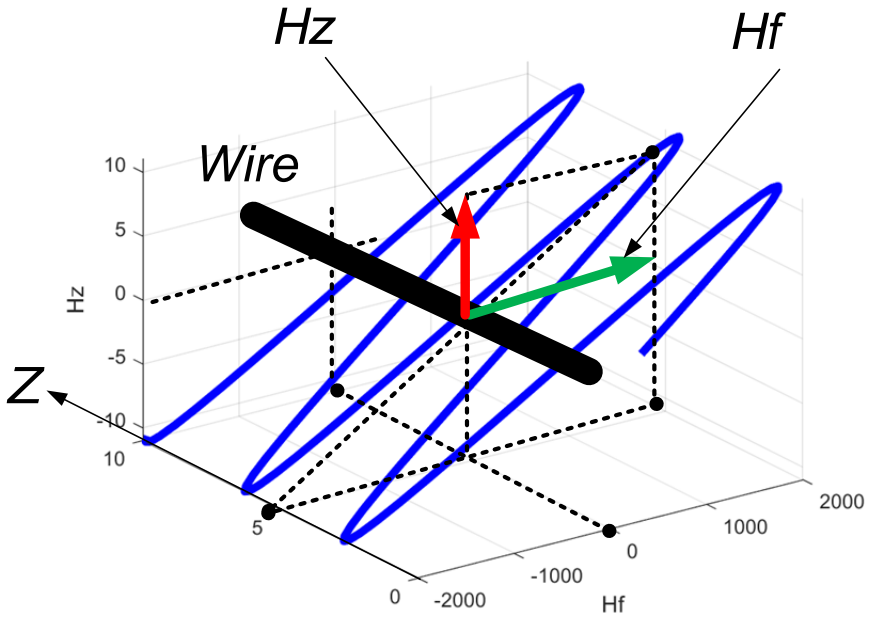

Fig. 4.

3. Energy flow

Consider the energetics of the interaction of current in a wire with magnetically sensitive elements. This interaction requires energy consumption from the current source. The appearance of a ferrite part (for example) in the vicinity of the wire causes an increase in current and the corresponding additional energy is spent on moving this part. This energy can only be transferred to the part by the energy flow. Therefore, in addition to the magnetic field, a flow of electromagnetic energy must act on the part.

In [3] it is shown that in the vicinity of the wire, in addition to the magnetic strength, an electrical strength is created. These strengths, as before, have the form (2.12-2.17), where for $r > R$:

$$e_z''(r) + e_z'(r) \frac{1}{r} - e_z(r) \left(\frac{\alpha^2}{r^2} + \chi^2 \right) = 0, \quad (1)$$

$$e_\phi(r) = \frac{\alpha}{\chi} \cdot \frac{e_z(r)}{r}, \quad (2)$$

$$e_r(r) = -\frac{1}{\chi} \cdot e_z'(r), \quad (3)$$

$$e_z(R) = \rho \cdot j_z(R), \quad (4)$$

where ρ is the specific resistance. The energy flux density reaching the part is determined by the formula (as follows from [3])

$$S_\varphi = Ae_z(r) \cdot h_r(r), \quad (5)$$

where A is a constant.

4. Discussion

In [3] the solution of Maxwell's equations for a wire with direct current was found. The above conclusions from this solution are justified, at least, by the fact that they follow from Maxwell's equations.

The DC wire solution is easily transferred to the area outside the wire. Moreover, this solution is consistent with Oersted's experiment.

There is a refined BSL law, which is a consequence of Maxwell's equations. The refinements boil down to the fact that the vector of the magnetic strength created by the direct current is not directed strictly perpendicular to the direction of the current, but has three projections, with the magnitude of the circumferential projection prevailing.

It follows that the definition of the magnetic induction in the vicinity of the wire through the divergence of the vector potential is approximate, and the idea that the condition $\text{div}(A)=0$ naturally complements Maxwell's equations is incorrect.

The refined BSL law makes it possible to determine the energy flux directed from the wire to the magnetically sensitive element.

Chapter 5z. Algorithms for solving Maxwell's equations for a DC wire

Contents

1. Introduction \ 1
2. Mathematical model \ 1
3. Solution of system A \ 2
- Appendix 1 \ 4
- Appendix 2 \ 5
- Appendix 3 \ 6
- Appendix 4 \ 7

1. Introduction

Maxwell's equations are discussed in Chapter 5:

$$\begin{aligned}\operatorname{rot}(J) &= 0, & (a) \\ \operatorname{rot}(H) - J - J_o &= 0, & (b) \\ \operatorname{div}(J) &= 0, & (c) \\ \operatorname{div}(H) &= 0. & (d)\end{aligned}$$

Methods for solving these equations are discussed in detail here. In this case, we will use the cylindrical coordinates r, ϕ, z and consider

- main current J_o ,
- additional currents J_r, J_ϕ, J_z ,
- magnetic strengths H_r, H_ϕ, H_z ,

2. Mathematical model

Equations (a-d) for cylindrical coordinates are:

$$\frac{H_r}{r} + \frac{\partial H_r}{\partial r} + \frac{1}{r} \cdot \frac{\partial H_\phi}{\partial \phi} + \frac{\partial H_z}{\partial z} = 0, \quad \text{see (d)} \quad (1)$$

$$\frac{1}{r} \cdot \frac{\partial H_z}{\partial \phi} - \frac{\partial H_\phi}{\partial z} = J_r, \quad \text{see (b)} \quad (2)$$

$$\frac{\partial H_r}{\partial z} - \frac{\partial H_z}{\partial r} = J_\phi, \quad \text{see (b)} \quad (3)$$

$$\frac{H_\phi}{r} + \frac{\partial H_\phi}{\partial r} - \frac{1}{r} \cdot \frac{\partial H_r}{\partial \phi} = J_z + J_o, \quad \text{see (b)} \quad (4)$$

$$\frac{J_r}{r} + \frac{\partial J_r}{\partial r} + \frac{1}{r} \cdot \frac{\partial J_\phi}{\partial \phi} + \frac{\partial J_z}{\partial z} = 0, \quad \text{see (c)} \quad (5)$$

$$\frac{1}{r} \cdot \frac{\partial J_z}{\partial \phi} - \frac{\partial J_\phi}{\partial z} = 0, \quad \text{see (a)} \quad (6)$$

$$\frac{\partial J_r}{\partial z} - \frac{\partial J_z}{\partial r} = 0, \quad \text{see (a)} \quad (7)$$

$$\frac{J_\phi}{r} + \frac{\partial J_\phi}{\partial r} - \frac{1}{r} \cdot \frac{\partial J_r}{\partial \phi} = 0. \quad \text{see (a)} \quad (8)$$

We will call this system of equations system A.

3. Solution of system A

To shorten the notation, we will further use the following notation:

$$\text{co} = \cos(\alpha\phi + \chi z), \quad (1)$$

$$\text{si} = \sin(\alpha\phi + \chi z), \quad (2)$$

where α, χ are some constants. There is a solution A1, which has the following form:

$$J_r = j_r \text{si}, \quad (3)$$

$$J_\phi = j_\phi \text{co}, \quad (4)$$

$$J_z = j_z \text{co}, \quad (5)$$

$$H_r = h_r \text{co}, \quad (6)$$

$$H_\phi = h_\phi \text{si}, \quad (7)$$

$$H_z = h_z \text{si}, \quad (8)$$

where $j(r), h(r)$ are some functions of coordinate r . In what follows, derivatives with r respect to will be denoted by primes. Substitute (1-8) in (2.1-2.8) and perform differentiation, and then rewrite the transformed equations (2.1-2.8) in the following order (2.5, 2.1, 2.2, 2.3, 2.4, 2.6, 2.7, 2.8) and renumber them:

$$\frac{j_r(r)}{r} + j_r'(r) - \frac{j_\phi(r)}{r} \alpha - \chi j_z(r) = 0, \quad (2.5) \quad (10)$$

$$\frac{h_r(r)}{r} + h_r'(r) + \frac{h_\phi(r)}{r} \alpha + \chi h_z(r) = 0, \quad (2.1) \quad (11)$$

$$\frac{h_z(r)}{r} \alpha - \chi h_\phi(r) = j_r(r), \quad (2.2) \quad (12)$$

$$h_r(r) \chi - h_z'(r) = j_\phi(r), \quad (2.3) \quad (13)$$

$$\frac{h_\phi(r)}{r} + h_\phi'(r) - \frac{h_r(r)}{r} \alpha = j_z(r) + J_o, \quad (2.4) \quad (14)$$

$$-\frac{j_z(r)}{r} \alpha + \chi j_\phi(r) = 0, \quad (2.6) \quad (15)$$

$$-j_r(r) \chi - j_z'(r) = 0, \quad (2.7) \quad (16)$$

$$\frac{j_\phi(r)}{r} + j_\phi'(r) + \frac{j_r(r)}{r} \alpha = 0. \quad (2.8) \quad (17)$$

First, consider equations (10, 15, 16, 17). Appendix 1 gives a numerical algorithm for determining the functions $j(r)$ for given α, χ using these equations.

The remaining system of 4 equations (11-14) with respect to three unknown functions $h(r)$ is overdetermined. Appendix 2 shows that this system has a solution for known functions $j(r)$.

In Appendix 3, a system of 4 equations (11-14) is solved for three unknown functions $h(r)$ at zero currents $j(r)$.

So, the solution of system A has the form:

$$h_z''(r) + \frac{1}{r} h_z'(r) - h_z(r) \left(\frac{\alpha^2}{r^2} + \chi^2 \right) = 0, \quad (18)$$

$$h_\varphi(r) = \frac{\alpha}{\chi} \left(\frac{h_z(r)}{r} - j_r(r) \right), \quad (19)$$

$$h_r(r) = -\frac{1}{\chi} \left(h_z'(r) + j_\varphi(r) \right), \quad (20)$$

$$j_z''(r) + \frac{1}{r} j_z'(r) - j_z(r) \left(\frac{\alpha^2}{r^2} + \chi^2 \right) = 0, \quad (21)$$

$$j_\varphi(r) = \frac{\alpha}{\chi} \cdot \frac{j_z(r)}{r}, \quad (22)$$

$$j_r(r) = -\frac{1}{\chi} \cdot j_z'(r). \quad (23)$$

It is interesting to note that in this solution

$$j_z(r) = h_z(r). \quad (23a)$$

In addition to solution A1, there is a solution A2 in the form

$$J_r = j_r \text{co}, \quad (24)$$

$$J_\varphi = j_\varphi \text{si}, \quad (25)$$

$$J_z = j_z \text{si}, \quad (26)$$

$$H_r = h_r \text{si}, \quad (27)$$

$$H_\varphi = h_\varphi \text{co}, \quad (28)$$

$$H_z = h_z \text{co}, \quad (29)$$

One can make sure that formulas (18-23) obtained for the solution A1, in which the sign in front of the constants α, χ is changed, become formulas for the solution A2. Then we get:

$$h_z''(r) + h_z'(r) - h_z(r) \left(\frac{\alpha^2}{r^2} + \chi^2 \right) = 0, \quad (30)$$

$$h_\varphi(r) = -\frac{\alpha}{\chi} \left(\frac{h_z(r)}{r} - j_r(r) \right), \quad (31)$$

$$h_r(r) = \frac{1}{\chi} \left(h_z'(r) + j_\varphi(r) \right), \quad (32)$$

$$j_z''(r) + j_z'(r) - j_z(r) \left(\frac{\alpha^2}{r^2} + \chi^2 \right) = 0, \quad (33)$$

$$j_\varphi(r) = -\frac{\alpha}{\chi} \cdot \frac{j_z(r)}{r}, \quad (34)$$

$$j_r(r) = \frac{1}{\chi} \cdot j_z'(r). \quad (35)$$

Appendix 1

Consider equations (2.10, 2.15, 2.16, 2.17) and renumber them:

$$\frac{j_r(r)}{r} + j_r'(r) + \frac{j_\phi(r)}{r} \alpha + \chi \cdot j_z(r) = 0, \quad (1)$$

$$\frac{1}{r} \cdot j_z(r) \alpha - j_\phi(r) \chi = 0, \quad (6)$$

$$j_r(r) \chi - j_z'(r) = 0, \quad (7)$$

$$\frac{j_\phi(r)}{r} + j_\phi'(r) - \frac{j_r(r)}{r} \cdot \alpha = 0. \quad (8)$$

From (6) we find:

$$j_z(r) = \frac{\chi}{\alpha} r \cdot j_\phi(r), \quad (11)$$

$$j_z'(r) = \frac{\chi}{\alpha} (j_\phi(r) + r \cdot j_\phi'(r)). \quad (12)$$

From (7, 12) we find:

$$j_r(r) \chi - \frac{\chi}{\alpha} (j_\phi(r) + r \cdot j_\phi'(r)) = 0,$$

or

$$-\frac{j_\phi(r)}{r} - j_\phi'(r) + \frac{j_r(r)}{r} \cdot \alpha = 0. \quad (13)$$

But equation (13) coincides with (8). Consequently, equation (8) is a consequence of equations (6, 7) and can be excluded from the system of equations (1, 6, 7, 8). From (6, 7) we find:

$$j_\phi(r) = \frac{1}{r\chi} \cdot j_z(r) \alpha, \quad (14)$$

$$j_r(r) = -\frac{1}{\chi} \cdot j_z'(r). \quad (15)$$

Substituting (14, 15) into (1), we find:

$$-j_z'(r) \frac{1}{\chi r} - j_z''(r) \frac{1}{\chi} + \left(\frac{\alpha}{r}\right)^2 \cdot j_z(r) \frac{1}{\chi} + \chi \cdot j_z(r) = 0, \quad (16)$$

or

$$j_z''(r) + j_z'(r) \frac{1}{r} - j_z(r) \left(\frac{\alpha^2}{r^2} + \chi^2\right) = 0. \quad (17)$$

The solution to this equation is a modified Bessel function of the second kind (besselk). In fig. 1p shows, for example, this function and its derivatives at $\alpha = 0.5$, $\chi = 0.1$ - see BesselSub2.

With a known function $j_z(r)$, functions can be found (14, 15).

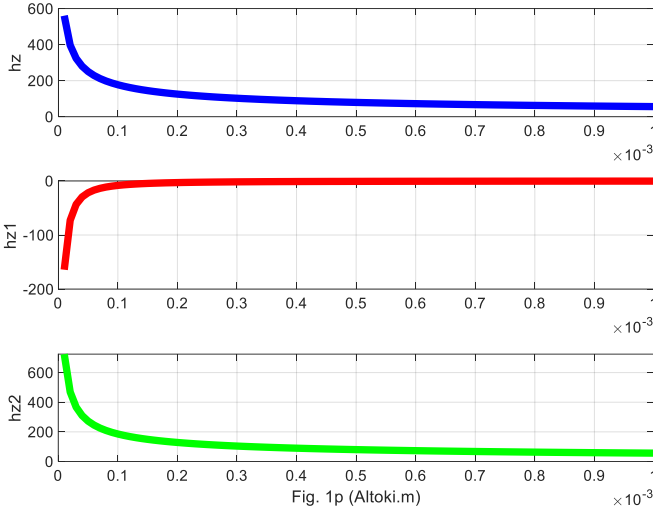

Appendix 2

Consider equations (2.11-2.14) and renumber them: Рассмотрим уравнения (2.11-2.14) и перенумеруем их:

$$\frac{h_r(r)}{r} + h'_r(r) + \frac{h_\varphi(r)}{r} \alpha + \chi h_z(r) = 0, \quad (2)$$

$$\frac{h_z(r)}{r} \alpha - \chi h_\varphi(r) = j_r(r), \quad (3)$$

$$-h_r(r) \chi - h'_z(r) = j_\varphi(r), \quad (4)$$

$$\frac{h_\varphi(r) + h_{\varphi 0}(r)}{r} + h'_\varphi(r) + h'_{\varphi 0}(r) + \frac{h_r(r)}{r} \alpha = j_z(r) + J_o. \quad (5)$$

In this case, equation (5) breaks down into the following two equations:

$$\frac{h_\varphi(r)}{r} + h'_\varphi(r) + \frac{h_r(r)}{r} \alpha = j_z(r), \quad (6)$$

$$\frac{h_{\varphi 0}(r)}{r} + h'_{\varphi 0}(r) = J_o. \quad (7)$$

From (7) we find:

$$h_{\varphi 0}(r) = J_o r / 2. \quad (7a)$$

From (3) we find

$$h_\varphi(r) = \frac{1}{\chi} \left(\frac{h_z(r)}{r} \alpha - j_r(r) \right), \quad (8)$$

$$h'_\varphi(r) = \frac{1}{\chi} \left(-j'_r(r) + \frac{h'_z(r)}{r} \alpha - \frac{h_z(r)}{r^2} \alpha \right), \quad (9)$$

From (4) we find

$$h_r(r) = -\frac{1}{\chi} \left(h'_z(r) + j_\varphi(r) \right), \quad (13)$$

$$h'_r(r) = -\frac{1}{\chi} (h''_z(r) + j'_\varphi(r)). \quad (14)$$

Substituting (8-13) in (6), we find:

$$\frac{1}{\chi r} \left(-j_r(r) + \frac{h_z(r)}{r} \alpha \right) + \frac{1}{\chi} \left(-j'_r(r) + \frac{h'_z(r)}{r} \alpha - \frac{h_z(r)}{r^2} \alpha \right) - \frac{1}{\chi} (h'_z(r) + j_\varphi(r)) \frac{\alpha}{r} = j_z(r)$$

or

$$\frac{1}{\chi r} (j_r(r)) + \frac{1}{\chi} (j'_r(r)) - \frac{1}{\chi} (j_\varphi(r)) \frac{\alpha}{r} = j_z(r)$$

or

$$\frac{1}{r} j_r(r) + j'_r(r) - \frac{\alpha}{r} j_\varphi(r) - \chi j_z(r) = 0. \quad (15)$$

This equation coincides with (3.10), i.e. equation (6) is a consequence of equations (3, 4) and can be excluded from the original system of equations.

We now substitute (13, 14, 8) in (2):

$$-\frac{1}{r} (h'_z(r) + j_\varphi(r)) - (h''_z(r) + j'_\varphi(r)) + \frac{\alpha}{r} \left(-j_r(r) + \frac{h_z(r)}{r} \alpha \right) + \chi^2 h_z(r) = 0,$$

or

$$h''_z(r) + \frac{1}{r} h'_z(r) - h_z(r) \left(\frac{\alpha^2}{r^2} + \chi^2 \right) = L(r) \quad (16)$$

where the function is known

$$L(r) = -\frac{1}{r} j_\varphi(r) - j'_\varphi(r) + \frac{\alpha}{r} j_r(r). \quad (17)$$

But it coincides with equation (8) from Appendix 1, i.e. $L(r) = 0$. In this case, equation (16) takes the form of the equation

$$h''_z(r) + \frac{1}{r} h'_z(r) - h_z(r) \left(\frac{\alpha^2}{r^2} + \chi^2 \right) = 0. \quad (18)$$

This function is the same as $j_z(r)$ - see Appendix 1.

With a known function $h_z(r)$, functions (8, 13) can be found. Thus, the system of equations (2-5) has a solution in the form (7, 8, 13, 18).

Appendix 3

Let's find the solution of Maxwell's equations for the area outside the wire. Obviously, the solution of these equations will coincide with the solution of equation (3.18-3.20) obtained in Appendix 2 for zero functions $j(r)$, i.e. will look like:

$$h''_z(r) + \frac{1}{r} h'_z(r) - h_z(r) \left(\frac{\alpha^2}{r^2} + \chi^2 \right) = 0, \quad (18)$$

$$h_\varphi(r) = \frac{\alpha h_z(r)}{\chi r}, \quad (19)$$

$$h_r(r) = -\frac{1}{\chi} h'_z(r), \quad (20)$$

Here

$$r \geq R, \quad (6)$$

where R – wire radius.

Appendix 4

The solution of Maxwell's equations for currents inside the wire is obtained in Appendix 1 and has the form:

$$j_z''(r) + j_z'(r) \frac{1}{r} - j_z(r) \left(\frac{\alpha^2}{r^2} + \chi^2 \right) = 0, \quad (1)$$

$$j_\phi(r) = \frac{\alpha}{\chi} \cdot \frac{j_z(r)}{r}, \quad (2)$$

$$j_r(r) = -\frac{1}{\chi} \cdot j_z'(r). \quad (3)$$

Since electric strengths and currents are related by an equation of the form

$$E = \rho \cdot J, \quad (4)$$

where ρ is the electrical resistance, there are electrical tensions in the wire, for which there are equations that coincide with (1-3) up to designations:

$$e_z''(r) + e_z'(r) \frac{1}{r} - e_z(r) \left(\frac{\alpha^2}{r^2} + \chi^2 \right) = 0, \quad (5)$$

$$e_\phi(r) = \frac{\alpha}{\chi} \cdot \frac{e_z(r)}{r}, \quad (6)$$

$$e_r(r) = -\frac{1}{\chi} \cdot e_z'(r), \quad (7)$$

where

$$e = \rho \cdot j. \quad (8)$$

At the border of the wire at $r = R$, the electrical strength does not experience a jump. Therefore, the same equations describe the electric strength of the wire, which is observed outside the wire at $r > R$.

Chapter 7. Solving Maxwell's Equations for a Capacitor in a DC Circuit. The Nature of the Potential Energy of a Capacitor

Contents

- 1. Introduction \ 1
- 2. Energy flows \ 2
- 3. Strengths \ 3
- 4. Energy \ 6
- 5. Charged capacitor
- 6. Ring capacitor \ 7
- 7. Discharge capacitor \ 9
- Appendix 1 \ 10

1. Introduction

It is shown below that in the capacitor, which is included in the DC circuit, there is an electromagnetic field and there are flows of electromagnetic energy. It has also been shown theoretically and experimentally that the flow of electromagnetic energy continues to circulate even after disconnecting from the DC voltage source. It remains even when the metal plates are removed, i.e. the capacitor's energy is stored in the capacitor dielectric even in the absence of charges. The energy that is contained in the capacitor and which is considered to be electrical potential energy is electromagnetic energy stored in the capacitor in the form of a stationary flow.

A charged capacitor always discharges in some resistance R , even if there is no shunt resistance. Even in a vacuum, the capacitor is discharged due to the fact that it emits energy, which can also be considered as the existence of some leakage resistance. In this case, an electromagnetic energy flux propagates along the capacitor and is equal to the power of thermal losses in the resistance R . Therefore, an electromagnetic field must exist in the capacitor, in which there are the longitudinal electrical strength and energy flows. Next, the solution of the Maxwell equations satisfying these conditions will be found.

When there is a flow of energy in a capacitor, the magnetic strengths must exist. In this case, Maxwell's equations for a charged

capacitor in the system of the cylindrical coordinates r , ϕ , z have the following form:

$$\frac{E_r}{r} + \frac{\partial E_r}{\partial r} + \frac{1}{r} \cdot \frac{\partial E_\phi}{\partial \phi} + \frac{\partial E_z}{\partial z} = 0, \quad (1)$$

$$\frac{1}{r} \frac{\partial E_z}{\partial \phi} - \frac{\partial E_\phi}{\partial z} = 0, \quad (2)$$

$$\frac{\partial E_r}{\partial z} - \frac{\partial E_z}{\partial r} = 0, \quad (3)$$

$$\frac{E_\phi}{r} + \frac{\partial E_\phi}{\partial r} - \frac{1}{r} \frac{\partial E_r}{\partial \phi} = 0, \quad (4)$$

$$\frac{H_r}{r} + \frac{\partial H_r}{\partial r} + \frac{1}{r} \cdot \frac{\partial H_\phi}{\partial \phi} + \frac{\partial H_z}{\partial z} = 0, \quad (5)$$

$$\frac{1}{r} \frac{\partial H_z}{\partial \phi} - \frac{\partial H_\phi}{\partial z} = 0, \quad (6)$$

$$\frac{\partial H_r}{\partial z} - \frac{\partial H_z}{\partial r} = 0, \quad (7)$$

$$\frac{H_\phi}{r} + \frac{\partial H_\phi}{\partial r} - \frac{1}{r} \frac{\partial H_r}{\partial \phi} = 0. \quad (8)$$

We will look for some unknown functions in the following forms:

$$H_r = h_r(r)co, \quad (9)$$

$$H_\phi = h_\phi(r)si, \quad (10)$$

$$H_z = h_z(r)si, \quad (11)$$

$$E_r = e_r(r)si, \quad (12)$$

$$E_\phi = e_\phi(r)co, \quad (13)$$

$$E_z = e_z(r)co, \quad (14)$$

where $h(r)$, $e(r)$ are some functions of the coordinate r and there are

$$co = \cos(\alpha\phi + \chi z), \quad (15)$$

$$si = \sin(\alpha\phi + \chi z), \quad (16)$$

where, in turn, α , χ are some constants.

2. Energy flows

Also, as in Chapter 1, the energy flux densities by the coordinates are determined by the following formula:

$$S = \begin{bmatrix} S_r \\ S_\phi \\ S_z \end{bmatrix} = \eta(E \times H) = \eta \begin{bmatrix} E_\phi H_z - E_z H_\phi \\ E_z H_r - E_r H_z \\ E_r H_\phi - E_\phi H_r \end{bmatrix} \quad (1)$$

or, taking into account the previous formulas,

$$S_r = \eta(e_\phi h_z - e_z h_\phi)co \cdot si \quad (2)$$

$$S_\phi = \eta(e_z h_r co^2 - e_r h_z si^2) \quad (3)$$

$$S_z = \eta(e_r h_\varphi \text{si}^2 - e_\varphi h_r \text{co}^2) \quad (4)$$

where $\eta = c/4\pi$ in the GHS system and $\eta = 1$ in the SI system.

It will be shown below that these energy flux densities satisfy the energy conservation law, if

$$h_r = k e_r, \quad (5)$$

$$h_\varphi = -k e_\varphi. \quad (6)$$

$$h_z = -k e_z. \quad (7)$$

Here, as in Chapter 2a for the capacitor in the AC circuit, the reader can also employ the following parameter:

$$k = \sqrt{\frac{\epsilon}{\mu'}} \quad (7a)$$

because this coefficient is frequency independent, see in formula (5.3a) in Chapter 2a. It follows from expressions (2), (6), and (7) that

$$S_r = \eta(-e_\varphi k e_z + k e_z e_\varphi) \text{co} \cdot \text{si} = 0, \quad (8)$$

i.e. there is no radial flow of energy pulsates. It also follows from formulae (3), (5), and (7) that

$$S_\varphi = \eta(e_z k e_r \text{co}^2 + k e_r e_z \text{si}^2) = \eta k e_r e_z, \quad (9)$$

i.e. the energy flux density along the circumference at a given radius does not depend on time and the other coordinates. It also follows from (5)-(7) that

$$S_z = \eta e_r h_\varphi (\text{si}^2 + \text{co}^2) = \eta k e_r e_\varphi, \quad (10)$$

i.e. the energy flux density along the vertical for a given radius is independent of time and the other coordinates. These statements were the purpose of assumptions (5)-(7).

The energy flow propagating along the z-axis through the cross-section of the capacitor is

$$\vec{S}_z = \iint_{r,\varphi} (S_z dr d\varphi) = \iint_{r,\varphi} (\eta k e_r e_\varphi dr d\varphi) = 2\pi\eta k \int_0^R (e_r e_\varphi dr). \quad (11)$$

So, in the charged capacitor

1. There is no radial flow of energy.
2. The flow of energy along the axis of the capacitor is equal to the active power consumed when charging or discharging the capacitor.
3. There is a flow of energy around the circumference.

Consequently, in a charged capacitor there is a stationary flow of electromagnetic energy. Also, namely the energy contained in the capacitor and generally considered as an electrical potential energy represents electromagnetic energy stored in the capacitor in the form of

the stationary flow. Namely in this flow the electromagnetic energy stored in the capacitor circulates. Consequently, the energy contained in the capacitor and commonly thought of the electric potential energy is electromagnetic energy stored in the capacitor as the stationary flow.

The known experiment of Revyakin [122], in which the question of the location of the charge in a capacitor is investigated. To carry out the experiments, an installation was made of two capacitors, between which the dielectric moves. As a result, in one capacitor the dielectric is charged with energy from a high-voltage source, and this energy is extracted from the other capacitor - the capacitor is discharged through the spark gap. The author of the experiment explains this phenomenon by charge transfer in a dielectric. This is not surprising: the question of where the charge is stored is still being debated. Until now, similar, but much less effective experiments have been explained by the fact that a moisture film is always retained on the surface of the dielectric after removing the metal plate and retaining the charge [123]. This explanation does not seem convincing, since there is no explanation for how this film manages to form and how the water manages to charge.

So, Revyakin's experiment is indisputable proof that the energy of a capacitor is stored in the dielectric of a capacitor in the absence of charges.

3. Strengths

Chapter 97, Section 3.3 shows that the system of equations (1-16) has a solution of the following form::

$$e_z(r) = A \left(\exp \left(-\frac{\alpha(r)^2}{2} \right) r^{\alpha(r)-1} \right) \quad (1)$$

$$\alpha(r) = \alpha_0 (1 - \exp(-\sigma r)). \quad (2)$$

$$\left\{ \begin{array}{l} \sigma > 0, \text{ if } \alpha_0 < 0 \\ \sigma < 0, \text{ if } \alpha_0 > 0 \end{array} \right\} \quad (3)$$

$$k = \sqrt{\frac{\varepsilon}{\mu}}, \quad (4)$$

$$\dot{e}_r = -\frac{e_r}{r} (1 - \alpha) + \left(\frac{\alpha^2}{2\chi r^2} + \chi \right) e_z, \quad (5)$$

$$e_\varphi = e_r - \frac{\dot{e}_z}{2\chi}, \quad (6)$$

$$h_r = k e_r, \quad (7)$$

$$h_\varphi = -k e_\varphi, \quad (8)$$

$$h_z = -k e_z. \quad (9)$$

Here the values of the constants A, α, σ, χ have not yet been determined. From (1) we find:

$$\begin{aligned} \dot{e}_z &= A \frac{d}{dr} \left(\exp \left(-\frac{\alpha(r)^2}{2} \right) r^{(\alpha(r)-1)} \right) = \\ &= A \left(r^{(\alpha(r)-1)} \frac{d}{dr} \exp \left(-\frac{\alpha(r)^2}{2} \right) + \exp \left(-\frac{\alpha(r)^2}{2} \right) \frac{d}{dr} r^{(\alpha(r)-1)} \right) \\ &= A \left(-r^{(\alpha(r)-1)} \alpha(r) \frac{d(\alpha(r))}{dr} \exp \left(-\frac{\alpha(r)^2}{2} \right) \right. \\ &\quad \left. + \exp \left(-\frac{\alpha(r)^2}{2} \right) (\alpha(r) - 1) r^{(\alpha(r)-2)} \right) = \\ &= A \exp \left(-0.5\alpha^2 \right) r^{(\alpha-2)} (\alpha - 1 - r\alpha\sigma \exp(-\sigma r)). \end{aligned} \quad (10)$$

Equations (1-9) define the functions and these functions $h(r), e(r)$ together with the constants α, χ, k determine the electric and magnetic strengths (1.9)-(1.14).

It follows that in the charged capacitor there are the electrical and magnetic strengths. Therefore, it can be argued that there is an electromagnetic field in the charged capacitor and the mathematical description of this field is a solution to Maxwell's equations.

Some experiments on the detection of the magnetic field between the plates of the charged capacitor using a compass [49, 50] are known. In accordance with the above, only the location of the compass needle perpendicular to the radius of the circular capacitor should be observed in the circular capacitor. In these experiments, the observed deviation of the arrow from the axis of the capacitor can be explained by the nonuniformity of the charge distribution over the square plate.

4. Energy

The energy density on a circle with the radius r in the disk capacitor is determined by formula (4.2) in Chapter 2a as follows:

$$W_r = \zeta \cdot (\varepsilon + k\mu) \left((e_r \sin)^2 + (e_\varphi \cos)^2 + (e_z \cos)^2 \right). \quad (1)$$

where $\zeta = \frac{1}{8\pi}$ in the CGS system and $\zeta = 1$ in the SI system. We also denote

$$\vartheta = \zeta \cdot (\varepsilon + k\mu) \quad (2)$$

or, taking into account (2.7a),

$$\vartheta = \zeta \cdot (\varepsilon + \sqrt{\varepsilon\mu}). \quad (3)$$

From (2, 3) we get:

$$W_r = \vartheta \cdot \left((e_r \sin i)^2 + (e_\varphi \cos \alpha)^2 + (e_z \cos \alpha)^2 \right). \quad (4)$$

Let us find from (2) the energy density on the WHOLE circle with radius r :

$$W_{r0} = \vartheta \cdot \left(e_r^2 \int_\varphi \sin^2 d\varphi + (e_\varphi^2 + e_z^2) \int_\varphi \cos^2 d\varphi \right). \quad (5)$$

For α -integer

$$W_{r0} = \vartheta \pi \alpha \cdot \left((e_r^2 + e_\varphi^2 + e_z^2) \right). \quad (6)$$

Thus, the energy density of an electromagnetic wave in a capacitor is the same at all points of a cylinder of a given radius.

The total energy of the capacitor with the external radius R is:

$$W = \int_0^R W_r dr. \quad (7)$$

On the other hand, the energy of the capacitor depends on the capacitance C and the voltage U on it as follows:

$$W = \frac{CU^2}{2}. \quad (8)$$

5. Charged capacitor

In a charged capacitor, longitudinal tension is present, but there is no longitudinal energy flow. This can only be the case when $e_\varphi = 0$. Moreover, from (3.6, 3.1, 3.10) we find:

$$e_r = \frac{e_z}{2\chi} = \frac{A}{2\chi} \exp(-0.5\alpha^2)r^{(\alpha-2)}(\alpha - 1 - r\alpha\sigma\exp(-\sigma r)). \quad (1)$$

In a charged capacitor, the energy flux density around the circumference is determined by (2.9) or, taking into account (2.7a), by the formula

$$S_\varphi = \eta \sqrt{\frac{\varepsilon}{\mu}} e_r e_z. \quad (2)$$

Consider the speed of movement of energy in a circle. The concept of Umov [81] is generally accepted, according to which the energy flux density S is the product of the energy density and the energy velocity v :

$$S = w \cdot v. \quad (3)$$

The average energy density on a circle with radius r can be determined from (4.6):

$$W_{r\text{mid}} \approx \frac{W_{r0}}{2\pi r}. \quad (4)$$

Then the speed of movement of energy along a circle with radius r

$$v_\varphi = S_\varphi / W_{r\text{mid}}, \quad (5)$$

and the rotation speed of the energy

$$\omega_\varphi = v_\varphi / 2\pi r. \quad (6)$$

Combining formulas (6, 5, 4, 5.2, 4.6), we get:

$$\omega_\varphi = S_\varphi / W_{r0} = \frac{\eta \sqrt{\frac{\varepsilon}{\mu}} e_r e_z}{\vartheta \pi \alpha \cdot ((e_r^2 + e_\varphi^2 + e_z^2))}. \quad (7)$$

Assuming that

$$e_r^2 \approx e_\varphi^2 \approx e_z^2 \approx e_r e_z,$$

we get

$$\omega_\varphi = S_\varphi / W_{r0} = \frac{\eta \sqrt{\frac{\varepsilon}{\mu}}}{3\vartheta \pi \alpha}. \quad (8)$$

or, taking into account (4.2),

$$\omega_\varphi = S_\varphi / W_{r0} = \frac{\eta}{3\pi \alpha \zeta \cdot (\sqrt{\varepsilon \mu} + \mu)}. \quad (9)$$

Note that ω_φ depends only on α .

6. Ring capacitor

We now consider the ring capacitor, in which the plates are not disks but rings.

Known electric motor of high voltage, which is a high-voltage air capacitor [131]. In it, one plate is made in the form of a wire, and the second is in the form of a strip of foil - see Fig. 3. At a high voltage between the plates, an ionic wind appears, which allows us to consider this device as a constantly discharging capacitor. The device takes off. This effect was initially explained by the action of the ion current and ion wind. Closer measurements show that the ionic wind generates about 60% of the lift. The source of 40% of the lift has not been identified. The authors argue that the lift also occurs in vacuum (where there is no ionic wind).

As a first approximation, this capacitor can be considered as a ring capacitor. Then it can be argued that in this device there is a constant flow of electromagnetic energy along the perimeter of the capacitor. With a constant discharge, there is also a vertical flow of electromagnetic energy. Such phenomena can be the reason for the appearance of lift.



Fig. 3

7. Discharge capacitor

As before, in Chapters 1 and 5 we consider the velocity of the energy. The concept of Umov [81] is generally accepted, according to which the energy flux density is the product of energy density s and energy velocity v_e :

$$S = w \cdot v_e. \quad (6)$$

The capacitor energy is

$$W_e = \frac{cU^2}{2}, \quad (7)$$

and the energy density is

$$w_e = \frac{W_e}{bd}. \quad (8)$$

where U, b, d are the voltage on the capacitor, the area of the plates, and the thickness of the dielectric, respectively. As a result, the following capacity can be calculated:

$$C = \varepsilon \cdot b/d. \quad (9)$$

When the capacitor is discharged at the resistor Ω , the energy flow S into the resistor is equal to the power P released in the resistor, i.e.

$$S = P = UI = \frac{U^2}{\Omega}. \quad (10)$$

If the capacitor is connected to the load with the entire surface of the plates, then the energy flux density is

$$s = \frac{S}{b} = \frac{U^2}{b\Omega}, \quad (11)$$

and the source power is

$$P = sb. \quad (12)$$

Then the speed of energy through the capacitor defined by (8) is

$$v_z = \frac{s}{w_e} = \frac{U^2/b\Omega}{U^2/cU^2/bd} = \frac{U^2/cU^2/bd}{U^2/cU^2/bd} = \frac{2d}{c\Omega}. \quad (13)$$

or, subject to (9),

$$v_z = \frac{2d^2}{\epsilon b \Omega'} \quad (14)$$

i.e. this speed does not depend on voltage! It may have a value substantially less than the speed of light.

We also find the constant A included in the definition of the function e_z according to (app. 1.3). The above formula (2.11) is obtained for calculating the energy flux along the axis of the capacitor. From (2.11) and (10) we obtain:

$$P = 2\pi\eta k \int_0^R (e_r e_\varphi dr). \quad (15)$$

The functions e_r, e_φ depend on the constant A because they are determined as the functions depending on the function e_z . Therefore, one can write:

$$e_r = A\bar{e}_r, e_\varphi = A\bar{e}_\varphi. \quad (16)$$

From (15), (16), and (2.7a) we find:

$$P = 2\pi\eta A^2 \sqrt{\frac{\epsilon}{\mu}} \int_0^R (\bar{e}_r \bar{e}_\varphi dr) \quad (17)$$

or

$$A = \sqrt{P / \left(2\pi\eta \sqrt{\frac{\epsilon}{\mu}} \int_0^R (\bar{e}_r \bar{e}_\varphi dr) \right)} \quad (18)$$

If the capacitor is charged, then U is known and A exists (simply because there are the strengths e_r, e_φ, e_z). This fact also occurs when the capacitor is not connected to a real resistor. Therefore, even in the absence of the resistor, there always exists the resistance R , at which the capacitor is discharged. This is the "leakage resistance".

It follows that the "leakage resistance" exists in an ideal vacuum (where there is no substance). This means that a flow of energy passes through a capacitor placed in a vacuum. It closes in the vicinity of the capacitor between the plates. In this case, the energy of the capacitor is not consumed because the real resistance does not exist.

However, the flow of energy in air is wasted in the same way as in a wire and a capacitor in air is discharged.

Chapter 7a. Electrically conductive dielectric capacitor

Contents

1. Introduction \ 1
2. Condenser charge by longitudinal magnetic field \ 1
3. Condenser charge by circular magnetic field \ 3
4. The density of electrical energy \ 4
- Appendix 1 \ 5
- Appendix 2 \ 6

1. Introduction

Here (unlike Chapter 7) consider a capacitor with a conductive dielectric material.

2. Condenser charge by longitudinal magnetic field

Chapter 5d shows that in the wire that is in a nonuniform longitudinal magnetic field, the longitudinal direct current is created. Consequently, the constant current is also generated in the capacitor with the conductive dielectric material. This current charges the capacitor. In other words, **the capacitor is charged in an external inhomogeneous magnetic field.**

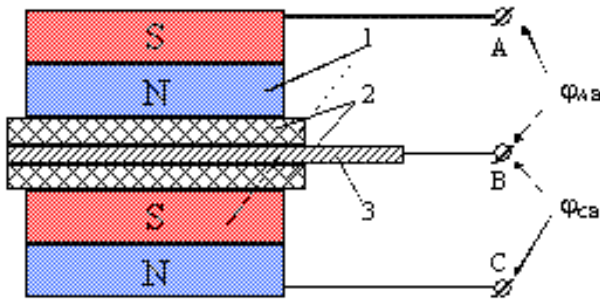

Fig. 1.

This phenomenon is detected experimentally. In [116], it is described the construction shown in Figure 1 that shows one of the options for the practical implementation of this phenomenon. Two insulating spacers 2 and metal foil 3 are placed in the inhomogeneous magnetic field of conductive magnets 1. Magnets 1 and foil 3 act as electrodes A, B, and C. A constant potential difference arisen at the time of creation of this structure is fixed between electrodes AB and CB.



Fig. 2.

In [125], one experiment shown in Figure 2 is described, where the author of work [125] checks the voltage on several structures:

- 1) single disk neodymium magnet (NM)
- 2) several NM,
- 3) ferrite disk (FD),
- 4) ferrite disc magnet (FD-magnet),
- 5) a stack of blocks FD-magnets.

In these constructions, ferrite FD is a conductive dielectric material. He has noted that

1. in 1) there is no voltage
2. in 2)-4) there is a voltage
3. in 4) the voltage is greater than in 3),
4. in 5) the voltage is greater than in 4),
5. The voltage decreases with time but is restored in the next experiment.

Example 1.

Consider a construction that differs from that shown in Figure 1 by the fact that electromagnets are used instead of permanent magnets, and the dielectric material is a ferromagnet. This is shown in Figure 3. It shows electromagnet 1 with winding 2. In the gap of electromagnet 1 there is the capacitor with dielectrics 3 and plates 4. From the previous, it follows that a voltage should appear on the capacitor located between the magnets.

This design can be considered as the transformer of the direct current J in winding 2 of electromagnet 1 to the constant voltage U on plates 4 of the capacitor. This voltage can be loaded on the external resistance R . In this case, the current source J transmits power to the resistance R .

Thus, the considered design is a power transformer of constant voltage (type 1).

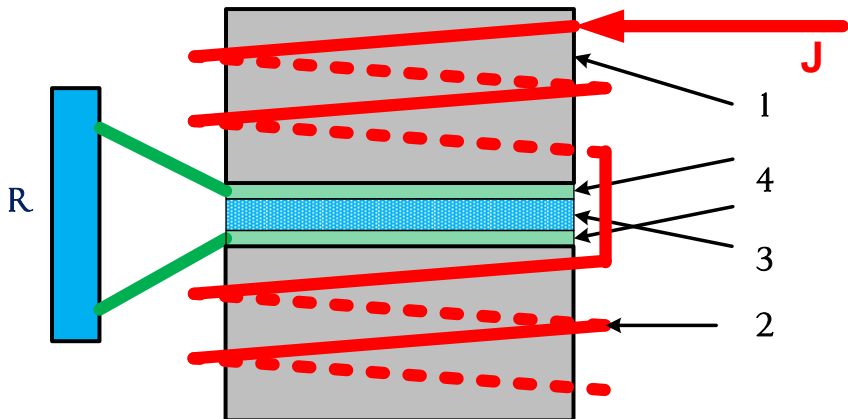

Fig. 3.

Such a scheme operates as follows. At some point in time, the capacitor under the influence of magnets accumulates magnetic energy W_m and charges up to voltage U , i.e. acquires electrical energy W_c . Next, the capacitor is discharged through its own internal resistance R . In this case, the voltage on the plates decreases. However, from the magnetic energy, it is again charged to the voltage U . Thus, this process can be considered as a constant discharge of the capacitor, the voltage on which is maintained by an external source of energy.

Formal relations are discussed in Appendix 1.

3. Condenser charge by circular magnetic field

Chapter 5d shows that the longitudinal constant current is created in the wire that is in the circular magnetic field. Consequently, the constant current is also generated in the capacitor with a conductive dielectric material. This current charges the capacitor. In other words, **the capacitor is charged in an external circular magnetic field.**

Thus, if the conductor with the constant current passes through the capacitor, the longitudinal strength arises in the capacitor.

Example 2.

Consider the construction shown in Figure 4. This figure shows the capacitor with conductive dielectrics 1 and plates 2. This capacitor has a hole, through which wire 3 passes. If the current J passes through the wire, the circular magnetic field with the strength H_ϕ is created in the capacitor. In accordance with the above, the longitudinal constant current (directed parallel to the current in the wire) is created in the conductive dielectrics. This current passes through the external resistance R .

Naturally, instead of the single wire, the reader can make a multi-turn winding. This design can be considered as the transformer of the direct current J (in the specified wire) to the constant voltage U on the capacitor plates. This voltage can be loaded on the external resistance R . In this case, the current source transmits power to the resistance R .

Thus, the considered design is the power transformer of constant voltage (type 2).

Such a scheme operates as follows. At some point in time, the capacitor under the influence of the current I accumulates the magnetic energy W_m and charges up to the voltage U , i.e. acquires the electrical energy W_c . Next, the capacitor is discharged through its own internal resistance R . In this case, the voltage on the plates decreases. However, from the magnetic energy, it is again charged to the voltage U . Thus, this process can be considered as a constant discharge of the capacitor, the voltage on which is maintained by an external source of energy.

Formal relations are discussed in Appendix 1.



Рис. 4.

4. The density of electrical energy

It is known that oxide-semiconductors and electrolytic capacitors have a very large specific capacity. The electrolyte or semiconductor serves as a dielectric material in such capacitors. Such a dielectric material is electrically conductive. The dielectric constant of such dielectrics is about 3 times greater than the dielectric constant of ordinary (nonconductive) dielectrics. However, this is impossible to explain a very large increase in specific capacity. It is also known that the specific capacitance increases with decreasing resistance. Previous results allow us to explain why conduction increases the capacitance of the capacitor.

Chapter 5 shows that at the constant density of the main current in the wire, the power transmitted through it depends on the structure parameters (α, χ), i.e. on the density of the screw trajectory of the current: as the parameter χ decreases, the power increases and the density of the screw path of the current increases. In this case, the total length of the trajectory increases. Likewise, the length of the line, on which the electric strength is proportional to this current, increases. However, the capacitance is proportional to the square of the length, at

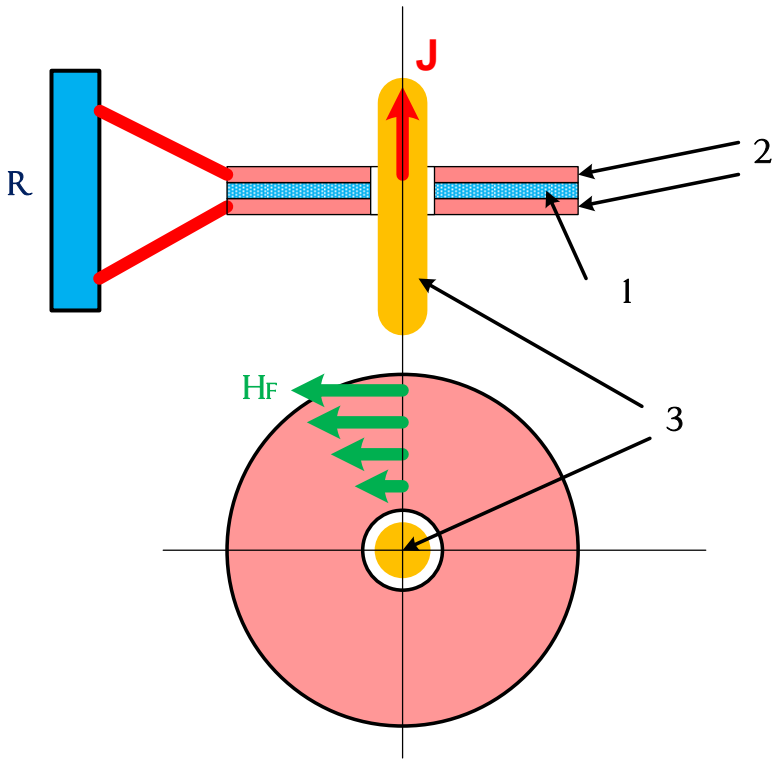
which the electric strength exists. Consequently, the capacity of the wire increases with increasing the density of the screw trajectory of the current, i.e. with increasing the transmit power. Exact relationships between electrical energy and heat power can be found from the relationships found in Chapter 5, see in expressions (2.25)-(2.30), (3.14) and Appendix 3. Since the electrical energy is proportional to the capacitance, then the capacitance of the wire can be found from these relationships.

In the electroconductive capacitor equivalent to the wire, all thermal power is released in the capacitor itself. Consequently, **the heat output from the capacitor substantially enhances the capacitance of the capacitor.**

Appendix 1.

Consider the formal relations for Sections 2 and 3. Denote:

P is the power consumed by the capacitor load,

P_1 is the power of the current source I ,

ρ is the resistance of the wire (Section 2) or the windings of electromagnets (Section 3),

L is the inductance of the capacitor,

W_c, W_m are the electric and magnetic energies of the capacitor,

P_2 is the power loss in the wire,

r is the apparent resistance of the wire (Section 2) or the windings of electromagnets (Section 3) are the load resistance for the current source I .

We have:

$$P_2 = I^2 \rho, \quad (1)$$

$$P = U^2 R, \quad (2)$$

$$W_m = LI^2/2, \quad (3)$$

$$W_c = CU^2/2, \quad (4)$$

$$P_1 = I^2 r = P + P_2 = U^2 R + I^2 \rho, \quad (5)$$

Then

$$r = I^2 / P_1 = \frac{U^2 R}{I^2} + \rho. \quad (6)$$

Obviously, for some consistent work, the time constants of the inductance charge circuit and the capacitor discharge circuit must coincide, i.e.

$$L/\rho = RC. \quad (7)$$

Then

$$R = \frac{L}{\rho C} \quad (8)$$

It is known that for the torus there is

$$L = \frac{\mu q}{l} \quad (9)$$

where

μ is the absolute magnetic permeability of the torus,

q is the cross-sectional area of the core,

l is the length of the average magnetic field line of the torus.

Obviously,

$$q = Dd/2, \quad (10)$$

$$l = \pi D, \quad (11)$$

where D is the diameter of the torus, d is the height of the torus. Then from (9)-(11) we find:

$$L = \frac{\mu d}{2\pi} \quad (13)$$

The capacitor capacitance is

$$C = \frac{\varepsilon \pi D^2}{4d} \quad (14)$$

Then from (8), (13), and (14) we find:

$$R = \left(\frac{\mu d}{2\pi \rho} \right) / \left(\frac{\varepsilon \pi D^2}{4d} \right) = \frac{2\mu d^2}{\pi^2 \varepsilon D^2 \rho} \quad (15)$$

Appendix 2.

Chapter 5 defines the density of the main current J_o , the densities of the additional currents J_r , J_φ , J_z and the magnetic strengths H_r , H_φ , H_z .

Consider also the following density of thermal energy released in the wire:

$$T = \rho(J_r^2 + J_\varphi^2 + J_z^2 + J_o^2). \quad (2)$$

The same values are determined in an electrically conductive capacitor. Consider the electrical energy of this capacitor:

$$W_e = 0.5\varepsilon E^2, \quad (3)$$

where

$$E^2 = E_r^2 + E_\varphi^2 + E_z^2 = \rho^2(J_r^2 + J_\varphi^2 + J_z^2 + J_o^2). \quad (4)$$

The capacitance of the capacitor can be determined through its electrical energy as follows:

$$C = 2W_e/U^2. \quad (5)$$

Combining expressions (2)-(5), we find:

$$C = \varepsilon \rho T / U^2. \quad (6)$$

Consider another case where all the thermal energy is released in the condenser. In this case, from (2)-(4) we find:

$$W_e = 0.5\varepsilon\rho T. \quad (7)$$

Insofar as there is

$$T = U^2/R, \quad (8)$$

where R is the electrical resistance of the capacitor, then

$$W_e = 0.5\varepsilon\rho U^2/R. \quad (9)$$

Denote by b, d the area of the plate and the distance between the plates of the capacitor, respectively. Then

$$C = \varepsilon b/d, \quad (10)$$

$$R = \rho d/b. \quad (11)$$

From (9)-(11) we get:

$$W_e = 0.5\varepsilon\rho U^2 b/\rho d = 0.5\varepsilon U^2 b/d = 0.5CU^2, \quad (12)$$

which coincides with formula (5). Thus, the electrical conductivity of the capacitor does not change its energy and therefore does not change its capacity.

Chapter 7b. Maxwell's Equations for the Neighborhood of a Magnet End

Contents

1. Mathematical model \ 1
2. Experiments on the detection of angular momentum in a magnet \ 2
3. On the demagnetization rate of the magnets \ 6

1. Mathematical model

In Chapter 7, the charged capacitor was considered, between the plates of which there is a constant electrical strength.

Consider now **the gap in the ring magnet**. There is a magnetic strength between the planes that limit this gap.

Due to the symmetry of Maxwell's equations, an electromagnetic field must exist in the "gap" of such a magnet, similar to the field in the gap of the charged capacitor. The difference between these fields lies in the fact that in the field equations the electric and magnetic fields' strengths change places. In particular, there is the electrical strength ($E_z \neq 0$) in a charged round capacitor and there is no magnetic strength ($H_z = 0$). In an uncharged round capacitor with a magnet there is the magnetic strength ($H_z \neq 0$) and no electrical strength ($E_z = 0$).

The solution of Maxwell's equations for the "gap" of a magnet is completely analogous to that for the capacitor, and we will not repeat it here.

Thus, in the gap of our magnet (i.e. where there is the strength H_z) there are both the electrical and magnetic fields' strengths.

With the existence of these strengths in the gap of our magnet, a stationary flow of electromagnetic energy is formed. In this case (as well as in the capacitor) it is possible to say the following.

1. The radial flow of energy is absent.
2. The energy flow along the gap axis is present.
3. There is some energy flow around the circumference.

As shown in Chapter 1.5, along with such energy flows in an electromagnetic wave there are also momenta directed along the radius,

along the circumference, and along the axis. There are also angular momenta about any radius, any circle, and about an axis.

Obviously, all these conclusions do not depend on the length of the gap. Therefore, it can be argued that

energy flows, momenta, and angular momenta exist in the vicinity of the end of the magnet.

In particular, as shown in formula (1.5.6), the angular momentum relative to the axis of the magnet at a given point of the "gap" is defined by the following expression:

$$L_z(r, \varphi, z) = \frac{r}{c} S_z(r, \varphi, z) \quad (1)$$

or, subject to (7.2.10),

$$L_z(r, \varphi, z) = \frac{r}{c} \eta k e_r(r) e_\varphi(r). \quad (2)$$

The total angular momentum on the entire circumference of a given radius and at a given distance from the end is

$$L_{zr}(r) = \int_0^{2\pi} L_z(r, \varphi, z) d\varphi = \frac{2\pi r}{c} \eta k e_r(r) e_\varphi(r). \quad (3)$$

2. Experiments on the detection of angular momentum in a magnet

The existence of angular momentum in the magnet could be verified experimentally. However, the author does not have such opportunities. Therefore, it is proposed to consider experiments that can demonstrate the existence of such an angular momentum in a magnet.

1. The known experiment borrowed from the Internet network is shown in Figure 1, where

- M is the magnet with induction B,
- K is the iron ring with gap V (which is needed so that when searching for an explanation not to assume that the current is flowing along the ring),
- N is the thread,
- L, D, A, C, d are the dimensions.

When the rings are lowered to a certain position, T starts to rotate quickly and is rotating for a while, and then stops and starts to rotate in the opposite direction. This rotation occurs during time $t \ll T$. These processes of the alternating-direction rotations repeat 3 to 5 times and then subside.

The author has repeated this experiment as follows:
 option 1: $B=1$ Tesla, $T=30$ sec, $(L, D, A, C, d)=(200, 15, 10, 15, d)$ mm;
 option 2: $B=1$ Tesla, $T=20$ sec, $(L, D, A, C, d)=(200, 20, 05, 15, d)$ mm.

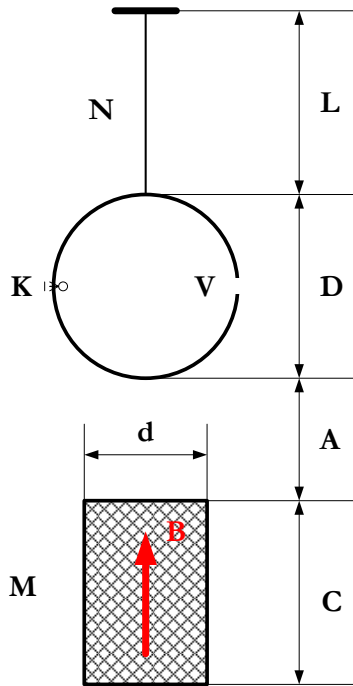

Fig. 1.

This experiment can be explained by the existence of torque, which in the steady state is balanced by the torque of the thread. Otherwise, this experiment is explained by a change in the torque of the thread, when it is pulled by the attraction of the ring K to the magnet M. This explanation seems unconvincing when the reader can do this experiment with his/her own hands.

2. The other Internet experiment [46] is shown in Figure 2, where

- M is the magnet,
- K is the other magnet in the form of an iron ring,
- S is the wooden rod,
- P is the holder of rod S.

Ring K is kept at some distance from the end face of magnet M and rotates on wooden rod S. The idea of this experiment can be used to

strictly experimentally testify the existence of the angular momentum around the axis of the magnet.

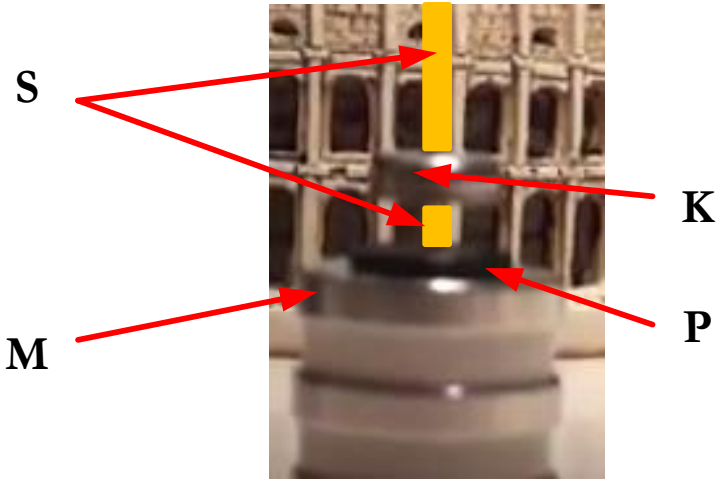

Fig. 2.

3. On Internet pages [47] another experiment is shown that can be easily repeated. Two ring magnets are hung by a hook on a long string that is shown in Figure 3.1. In the first case, the magnets interlock with the planes of the rings (see in Figure 3.2) and in the second, they touch the external cylindrical surfaces (see in Figure 3.3). In the first case, the design hangs quietly but in the second, it rotates. Since the weight of the structure does not change, the influence of the thread is excluded.



Fig. 3.1.



Fig. 3.2.



Fig. 3.3.

4. There can be also found the other Internet experiment similar to experiment 3, where the lower ring magnet was replaced by a solid rectangular magnet. This experiment is shown in Figure 4, where there are the notations used in Figure 1. The design was rotated in the same

way as in experiment 3 [48]. This experiment can be explained by the possible existence of angular momentum around the magnet axis.

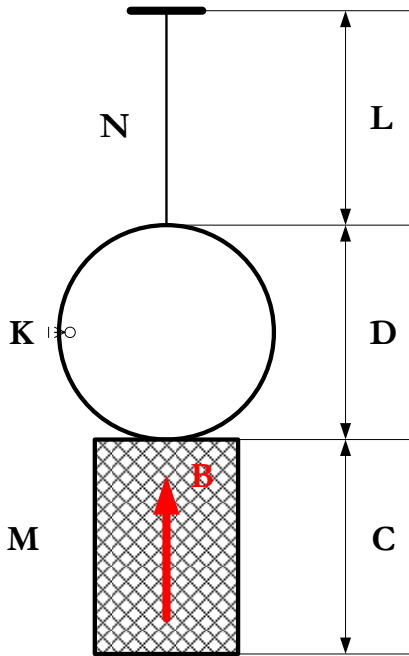

Fig. 4.

Two ring magnets in Experiment 3 can be considered as two combined structures in Figure 4:

- the bottom ring has a role of a magnet for the top ring,
- the top ring has a role of a magnet for the bottom ring,

In this case, all four experiments are explained by the existence of the angular momentum in the magnet.

Experiments 1, 3, and 4 can be represented by the general scheme shown in Figure 5. Magnet M creates magnetic flux B1 directed into ring K. (We do not consider the other part of the magnet flux M). This magnetic flux B1 splits in ring K into two fluxes B2. Further, fluxes B2 are closed by flux B3 inside the ring and flux B4 outside the ring. In this way,

$$B1 = 2 \times B2 - B3, B4 = 2 \times B2 - B3, B1 = B4,$$

i.e. there is always flux $B3 > 0$. This flux, as shown above, has angular momentum.

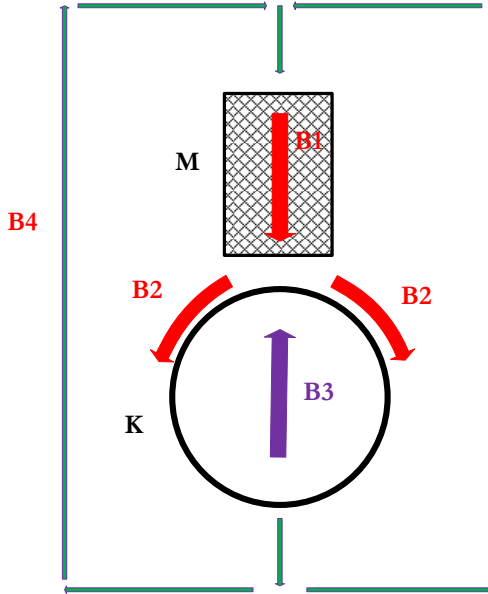

Fig. 5.

3. On the demagnetization rate of the magnets

Consider the speed of movement of energy from the magnet. As in Chapter 1, we will use the concept of Umov [81]. According to this concept, the energy flux density s is a product of energy density w and speed v_e of movement of energy, namely:

$$s = w \cdot v_e. \quad (1)$$

If the movement of energy represents some radiation from the body towards perpendicular to some section of the body, then from (1) it follows that

$$s = \frac{P}{Q} = \frac{dW/dt}{Q} = w \cdot v_e, \quad (2)$$

where Q is the cross-sectional area, P is the radiation power, W is the energy of the body. Consequently, in this case, we can measure the speed of the movement of energy as follows:

$$v_e = \frac{dW/dt}{w \cdot Q}. \quad (3)$$

We apply this formula to calculate the speed of energy moving when demagnetizing a magnet. From [93] we consider, for example, the dependence of the decrease in the magnetic induction on time for an alloy UNDK25A. This is shown in Figure 6, where the functions are shown depending on the time elapsed from the moment of

magnetization. The time is shown in days. The upper plot in Figure 6 shows the magnetic induction function from [93]. The rate of change of magnetic induction can be expressed as follows:

$$\frac{dB}{dt} = 2 \times 10^{-6} \frac{T}{sec} \quad (4)$$

The under plot in Figure 6 shows the following function of the magnetic energy density:

$$w = 10^{-4} B^2 . \quad (5)$$

From (4) and (5) it follows that

$$\frac{dw}{dt} = 2 \cdot 10^{-4} \frac{dB}{dt} B = 4 \cdot 10^{-10} B \quad (6)$$

We will assume, in the absence of more accurate data, that

$$W = w, Q = 1, B = 1 . \quad (7)$$

Then from (3) we find:

$$v_e = \frac{dW/dt}{w \times Q} = \frac{4 \times 10^{-10} B}{10^{-4} B^2} = 4 \times 10^{-6} \frac{m}{s} . \quad (8)$$

This speed is much less than the speed of light, as required to show.

It can be assumed that the flow of energy from the magnet is converted into some thermal energy and the magnet is cooled. But along with the cooling of the magnet, the heat flux enters it from outside, restoring the temperature of the magnet. Consequently, the existence of the magnet, possibly, is provided by the external environment and when cooled, the magnetic properties disappear, which is observed as the Curie point. The process of the exchange of the thermal energy of the magnet and the environment is described in detail in [124].

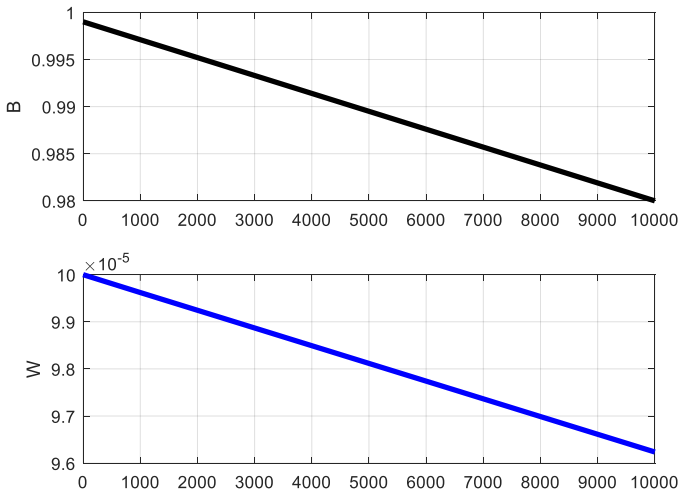

Fig. 6. PotetMy.m

Chapter 7e. The Solution of Maxwell's Equations for a Constant Voltage Capacitor in Cartesian Coordinates

Contents

1. The solution of the set of Maxwell equations \ 1
2. The density of energy flux \ 3

1. The solution of the set of Maxwell equations

Chapter 2d gives the solution to the Maxwell equations for an AC capacitor in Cartesian coordinates. Here we look at a constant voltage capacitor in Cartesian coordinates, see in Figure 1.

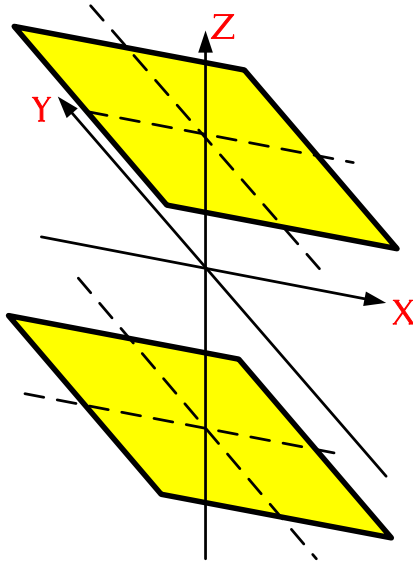

Fig. 1.

In the Cartesian coordinate system x, y, z , these equations in the SI system have the following form:

Chapter 7e. The Solution of Maxwell's Equations for a Constant Voltage Capacitor in Cartesian Coordinates

$\frac{\partial H_z}{\partial y} - \frac{\partial H_y}{\partial z} = 0$	(1)
$\frac{\partial H_x}{\partial z} - \frac{\partial H_z}{\partial x} = 0$	(2)
$\frac{\partial H_y}{\partial x} - \frac{\partial H_x}{\partial y} = 0$	(3)
$\frac{\partial E_z}{\partial y} - \frac{\partial E_y}{\partial z} = 0$	(4)
$\frac{\partial E_x}{\partial z} - \frac{\partial E_z}{\partial x} = 0$	(5)
$\frac{\partial E_y}{\partial x} - \frac{\partial E_x}{\partial y} = 0$	(6)
$\frac{\partial E_x}{\partial x} + \frac{\partial E_y}{\partial y} + \frac{\partial E_z}{\partial z} = 0$	(7)
$\frac{\partial H_x}{\partial x} + \frac{\partial H_y}{\partial y} + \frac{\partial H_z}{\partial z} = 0$	(8)

where E_x , E_y , E_z are the components of the electric field strength, H_x , H_y , H_z are the components of the magnetic field strength. A solution must be found with the nonzero component E_z . We will seek a solution in the form of the following functions [45]:

$$E_x(x, y, z, t) = e_x \text{Ch}(\beta y) \text{Ch}(\gamma z) \cos(\alpha x), \quad (9)$$

$$E_y(x, y, z, t) = e_y \text{Sh}(\beta y) \text{Ch}(\gamma z) \sin(\alpha x), \quad (10)$$

$$E_z(x, y, z, t) = e_z \text{Ch}(\beta y) \text{Sh}(\gamma z) \sin(\alpha x), \quad (11)$$

$$H_x(x, y, z, t) = h_x \text{Sh}(\beta y) \text{Sh}(\gamma z) \sin(\alpha x), \quad (12)$$

$$H_y(x, y, z, t) = h_y \text{Ch}(\beta y) \text{Sh}(\gamma z) \cos(\alpha x), \quad (13)$$

$$H_z(x, y, z, t) = h_z \text{Sh}(\beta y) \text{Ch}(\gamma z) \cos(\alpha x), \quad (14)$$

where $e_x, e_y, e_z, h_x, h_y, h_z$ are the constant amplitudes of the functions and α, β, γ are the constants.

Differentiating equations (9)-(14) and substituting the obtained result in equations (1)-(8) after reduction by common factors, we obtain:

$h_z \beta - h_y \gamma = 0$	(15)
$h_x \gamma + h_z \alpha = 0$	(16)
$-h_y \alpha - h_x \beta = 0$	(17)
$e_z \beta - e_y \gamma = 0$	(18)
$e_x \gamma - e_z \alpha = 0$	(19)

$e_y \alpha - e_x \beta = 0$	(20)
$e_x \alpha + e_y \beta + e_z \gamma = 0$	(21)
$h_x \alpha + h_y \beta + h_z \gamma = 0$	(22)

This set of eight homogeneous equations (15)-(22) with a known value of e_z contains the following eight unknowns: $e_x, e_y, h_x, h_y, h_z, \alpha, \beta, \gamma$. We first consider a set of five linear equations (15)-(19) with respect to the following five unknowns: e_x, e_y, h_x, h_y, h_z . Resolving this set, we find these unknowns. Then we substitute the found values into equations (20)-(22) and obtain a set of three linear equations with respect to the following three unknowns: α, β, γ . Thus, the original set of equations (15)-(22) will be resolved. A solution always exists.

2. The density of energy flux

The densities of energy fluxes by the coordinates are determined by

$$S = \begin{bmatrix} S_x \\ S_y \\ S_z \end{bmatrix} = (E \times H) = \begin{bmatrix} E_y H_z - E_z H_y \\ E_z H_x - E_x H_z \\ E_x H_y - E_y H_x \end{bmatrix}. \quad (23)$$

or, taking into account formulas (9)-(14),

$$S_x = (e_y h_z \Psi_{yz} - e_z h_y \Psi_{zy}) \quad (24)$$

$$S_y = (e_z h_x \Psi_{zx} - e_x h_z \Psi_{xz}) \quad (25)$$

$$S_z = (e_x h_y \Psi_{xy} - e_y h_x \Psi_{yx}) \quad (26)$$

where the coefficients Ψ are determined from (9-14). For instance,

$$\Psi_{xy} = \text{Ch}(\beta y) \text{Ch}(\gamma z) \cos(\alpha x) \cdot \text{Ch}(\beta y) \text{Sh}(\gamma z) \cos(\alpha x)$$

or

$$\Psi_{xy} = 0.5 \text{Ch}^2(\beta y) \text{Sh}^2(2(\gamma z)) \cos^2(\alpha x). \quad (27)$$

Similarly,

$$\Psi_{yx} = \text{Sh}(\beta y) \text{Ch}(\gamma z) \sin(\alpha x) \cdot \text{Sh}(\beta y) \text{Sh}(\gamma z) \sin(\alpha x)$$

or

$$\Psi_{yx} = 0.5 \text{Sh}^2(\beta y) \text{Sh}^2(2(\gamma z)) \sin^2(\alpha x). \quad (28)$$

This means that there are energy flows along all axes of the capacitor. It also means that some energy flows through the capacitor. Consider, for instance, the cross-section xy for $z = z_1$. The energy flux density S_z in this section is determined by function (26), (27), and (28). The energy flow of the entire section is determined by the integral of this function over the entire area of this section.

Chapter 7e. The Solution of Maxwell's Equations for a Constant Voltage Capacitor in Cartesian Coordinates

It is important to note that this flow does not change the internal energy of the capacitor. This flow is the active power that passes through the capacitor along the z -axis. At other faces of the capacitor there may also be energy flows that emit energy subtracted from the capacitor energy and made up by the voltage source.

This chapter also includes many of the conclusions presented in Chapter 7 for a capacitor in the cylindrical coordinate system.

Chapter 8. Solution of Maxwell's Equations for Spherical Coordinates

The Maxwell system of equations, being a system of partial differential equations, has many solutions. And we will look at several solutions. The applicability of a solution for physics is determined by a single criterion: it must satisfy the law of conservation of energy (ECL). The existing solution does NOT satisfy this law: it satisfies it on average, i.e. now it satisfies, but after a moment it does not satisfy, etc. It looks like an anecdote about crocodiles that fly, but very low. Nevertheless, the very fact that the existing solution satisfies ... is considered to be proof of the uniqueness of this solution (which can be read about in many textbooks). This also looks like an anecdote. As they say, crocodiles are resting.

So, further we will consider three solutions and their compliance with the law of conservation of energy. In the proposed options, solutions of Maxwell's equations are considered in spherical coordinates (ρ, φ, θ) , where the strengths are determined by formulas of the following form:

$$E_{\varphi} = \frac{e_{\varphi}}{\rho} \text{Khm}(\theta, \alpha) \sin(\alpha \varphi + \chi \rho + \omega t), \quad (1)$$

$$E_{\theta} = \frac{e_{\theta}}{\rho} \text{Khm}(\theta, \alpha) \cos(\alpha \varphi + \chi \rho + \omega t), \quad (2)$$

$$E_{\rho} = \frac{e_{\rho}}{\rho} \text{Khm}(\theta, \alpha) \sin(\alpha \varphi + \chi \rho + \omega t), \quad (3)$$

$$H_{\varphi} = \frac{h_{\varphi}}{\rho} \text{Khm}(\theta, \alpha) \cos(\alpha \varphi + \chi \rho + \omega t), \quad (4)$$

$$H_{\theta} = \frac{h_{\theta}}{\rho} \text{Khm}(\theta, \alpha) \sin(\alpha \varphi + \chi \rho + \omega t), \quad (5)$$

$$H_{\rho} = \frac{h_{\rho}}{\rho} \text{Khm}(\theta, \alpha) \cos(\alpha \varphi + \chi \rho + \omega t), \quad (6)$$

where the spherical coordinates are shown in Fig. 1 and the following designations are adopted:

E is electric field strength,

H is magnetic field strength,

μ is absolute magnetic permeability,

ε is absolute dielectric constant,

$\text{Khm}(\theta, \alpha)$ is some function,

$\alpha, \chi, \omega, e_{\varphi}, h_{\varphi}$ are constants.

For convenience, we will use the notation:

$$\text{Khm}^1(\theta, \alpha) = \frac{\partial}{\partial \theta} \text{Khm}(\theta, \alpha), \quad (7)$$

$$\text{co} = \cos(\alpha \varphi + \chi \rho + \omega t), \quad (8)$$

$$\text{si} = \sin(\alpha \varphi + \chi \rho + \omega t). \quad (9)$$



Рис. 1.

Table 1 shows the expressions for the rotor and the divergence of the vector E in spherical coordinates [4]. Maxwell's equations in spherical coordinates in the absence of charges and currents have the form given in table 2.

The following options are considered:

- A. $\alpha = 0, E_\rho = 0, H_\rho = 0$
- B. $\alpha = \text{any}, E_\rho = 0, H_\rho = 0$
- C. $\alpha = 0, E_\rho = \text{any}, H_\rho = \text{any}$

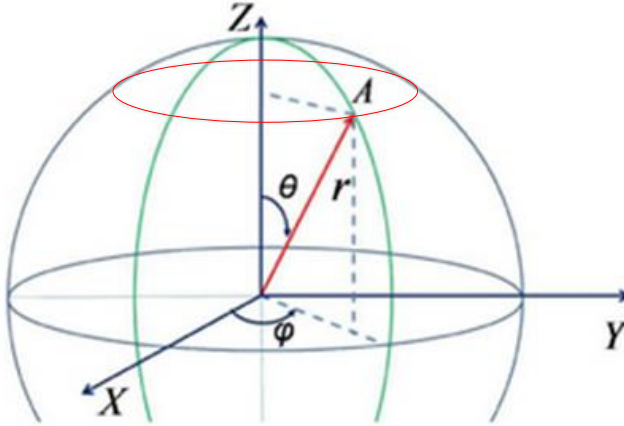
Table 1.

1	2	3
1	$\text{rot}_\rho(E)$	$\frac{E_\phi}{\rho \text{tg}(\theta)} + \frac{\partial E_\phi}{\rho \partial \theta} - \frac{\partial E_\theta}{\rho \sin(\theta) \partial \phi}$
2	$\text{rot}_\theta(E)$	$\frac{\partial E_\rho}{\rho \sin(\theta) \partial \phi} - \frac{E_\phi}{\rho} - \frac{\partial E_\phi}{\partial \rho}$
3	$\text{rot}_\phi(E)$	$\frac{E_\theta}{\rho} + \frac{\partial E_\theta}{\partial \rho} - \frac{\partial E_\rho}{\rho \partial \phi}$
4	$\text{div}(E)$	$\frac{E_\rho}{\rho} + \frac{\partial E_\rho}{\partial \rho} + \frac{E_\theta}{\rho \text{tg}(\theta)} + \frac{\partial E_\theta}{\rho \partial \theta} + \frac{\partial E_\phi}{\rho \sin(\theta) \partial \phi}$

Table 2.

1	2	3
1	$\text{rot}_\rho(E)$	$\frac{E_\phi}{\rho \text{tg}(\theta)} + \frac{\partial E_\phi}{\rho \partial \theta} - \frac{\partial E_\theta}{\rho \sin(\theta) \partial \phi} + \frac{\mu}{c} \frac{\partial H_\rho}{\partial t} = 0$
2	$\text{rot}_\theta(E)$	$\frac{\partial E_\rho}{\rho \sin(\theta) \partial \phi} - \frac{E_\phi}{\rho} - \frac{\partial E_\phi}{\partial \rho} + \frac{\mu}{c} \frac{\partial H_\theta}{\partial t} = 0$
3	$\text{rot}_\phi(E)$	$\frac{E_\theta}{\rho} + \frac{\partial E_\theta}{\partial \rho} - \frac{\partial E_\rho}{\rho \partial \phi} + \frac{\mu}{c} \frac{\partial H_\phi}{\partial t} = 0$
4	$\text{div}(E)$	$\frac{E_\rho}{\rho} + \frac{\partial E_\rho}{\partial \rho} + \frac{E_\theta}{\rho \text{tg}(\theta)} + \frac{\partial E_\theta}{\rho \partial \theta} + \frac{\partial E_\phi}{\rho \sin(\theta) \partial \phi} = 0$
5	$\text{rot}_\rho(H)$	$\frac{H_\phi}{\rho \text{tg}(\theta)} + \frac{\partial H_\phi}{\rho \partial \theta} - \frac{\partial H_\theta}{\rho \sin(\theta) \partial \phi} - \frac{\varepsilon}{c} \frac{\partial E_\rho}{\partial t} = 0$
6	$\text{rot}_\theta(H)$	$\frac{\partial H_\rho}{\rho \sin(\theta) \partial \phi} - \frac{H_\phi}{\rho} - \frac{\partial H_\phi}{\partial \rho} - \frac{\varepsilon}{c} \frac{\partial E_\theta}{\partial t} = 0$
7	$\text{rot}_\phi(H)$	$\frac{H_\theta}{\rho} + \frac{\partial H_\theta}{\partial \rho} - \frac{\partial H_\rho}{\rho \partial \phi} - \frac{\varepsilon}{c} \frac{\partial E_\phi}{\partial t} = 0$
8	$\text{div}(H)$	$\frac{H_\rho}{\rho} + \frac{\partial H_\rho}{\partial \rho} + \frac{H_\theta}{\rho \text{tg}(\theta)} + \frac{\partial H_\theta}{\rho \partial \theta} + \frac{\partial H_\phi}{\rho \sin(\theta) \partial \phi} = 0$

Chapter 8A. Solution of Maxwell's Equations for Spherical Coordinates. Solution variant A

Contents

1. Solving Maxwell's equations \ 1
2. Energy flows \ 5
3. Conclusion \ 6

1. Solving Maxwell's equations

In this version $\alpha = 0, E_\rho = 0, H_\rho = 0$. Wherein

$$E_\varphi = \frac{e_\varphi}{\rho} \text{Kh}m(\theta)\text{si}, \quad (1)$$

$$E_\theta = \frac{e_\theta}{\rho} \text{Kh}m(\theta)\text{co}, \quad (2)$$

$$E_\rho = 0, \quad (3)$$

$$H_\varphi = \frac{h_\varphi}{\rho} \text{Kh}m(\theta)\text{co}, \quad (4)$$

$$H_\theta = \frac{h_\theta}{\rho} \text{Kh}m(\theta)\text{si}, \quad (5)$$

$$H_\rho = 0, \quad (6)$$

where

$$\text{co} = \cos(\chi\rho + \omega t), \quad (7)$$

$$\text{si} = \sin(\chi\rho + \omega t). \quad (8)$$

In this case, table 8.2 takes the form of table 1. Substituting (1-8) in the formulas of the table 1, we obtain after reduction the equations shown in table 2.

Table 1.

1	2	3
11	$\text{rot}_\rho(E)$	$\frac{E_\varphi}{\rho \text{tg}(\theta)} + \frac{\partial E_\varphi}{\rho \partial \theta} = 0$
12	$\text{rot}_\theta(E)$	$-\frac{E_\varphi}{\rho} + \frac{\mu}{c} \frac{\partial H_\theta}{\partial t} = 0$
13	$\text{rot}_\varphi(E)$	$\frac{E_\theta}{\rho} + \frac{\partial E_\theta}{\partial \rho} + \frac{\mu}{c} \frac{\partial H_\varphi}{\partial t} = 0$
14	$\text{div}(E)$	$\frac{E_\theta}{\rho \text{tg}(\theta)} + \frac{\partial E_\theta}{\rho \partial \theta} = 0$
15	$\text{rot}_\rho(H)$	$\frac{H_\varphi}{\rho \text{tg}(\theta)} + \frac{\partial H_\varphi}{\rho \partial \theta} = 0$
16	$\text{rot}_\theta(H)$	$-\frac{H_\varphi}{\rho} - \frac{\varepsilon}{c} \frac{\partial E_\theta}{\partial t} = 0$
17	$\text{rot}_\varphi(H)$	$\frac{H_\theta}{\rho} + \frac{\partial H_\theta}{\partial \rho} - \frac{\varepsilon}{c} \frac{\partial E_\varphi}{\partial t} = 0$
18	$\text{div}(H)$	$\frac{H_\theta}{\rho \text{tg}(\theta)} + \frac{\partial H_\theta}{\rho \partial \theta} = 0$

Table 2.

1	2	3
23	$\text{rot}_\rho(E)$	$\text{Khm} \cdot e_\varphi \text{si} \cdot \cos(\theta) + \text{Khm}^1 e_\varphi \text{si} \cdot \sin(\theta) = 0$
24	$\text{rot}_\rho(H)$	$\text{Khm} \cdot h_\varphi \text{co} \cdot \cos(\theta) + \text{Khm}^1 h_\varphi \text{co} \cdot \sin(\theta) = 0$
25	$\text{rot}_\theta(E)$	$-\frac{e_\varphi \text{si}}{\rho^2} - \frac{e_\varphi}{\rho} \chi \text{co} - \frac{\partial}{\partial \rho} \left(\frac{1}{\rho} \right) \cdot e_\varphi \text{si} + \omega \frac{\mu h_\theta}{c \rho} \text{co} = 0$
26	$\text{rot}_\theta(H)$	$-\frac{h_\varphi \text{co}}{\rho^2} + \frac{h_\varphi}{\rho} \chi \text{si} - \frac{\partial}{\partial \rho} \left(\frac{1}{\rho} \right) \cdot \frac{h_\varphi}{\rho} \text{co} + \omega \frac{\varepsilon e_\theta}{c \rho} \text{si} = 0$
27	$\text{rot}_\varphi(E)$	$\frac{e_\theta \text{co}}{\rho^2} - \frac{e_\theta}{\rho} \chi \text{si} + \frac{\partial}{\partial \rho} \left(\frac{1}{\rho} \right) e_\theta \text{co} - \omega \frac{\mu h_\varphi}{c \rho} \text{si} = 0$
28	$\text{rot}_\varphi(H)$	$\frac{h_\theta \text{si}}{\rho^2} + \frac{h_\theta}{\rho} \chi \text{co} + \frac{\partial}{\partial \rho} \left(\frac{1}{\rho} \right) \cdot \frac{h_\theta}{\rho} \text{si} - \omega \frac{\varepsilon e_\varphi}{c \rho} \text{co} = 0$
29	$\text{div}(E)$	$\text{Khm} \cdot \frac{e_\rho}{\rho} \chi \text{co} + \text{Khm} \cdot \frac{\partial}{\partial \rho} \left(\frac{1}{\rho} \right) e_\rho \text{si} +$ $\text{Khm} \cdot e_\theta \text{co} \cdot \cos(\theta) + \text{Khm}^1 e_\theta \text{co} \cdot \sin(\theta) = 0$
30	$\text{div}(H)$	$-\text{Khm} \cdot \frac{h_\rho}{\rho} \chi \text{si} + \text{Khm} \cdot \frac{\partial}{\partial \rho} \left(\frac{1}{\rho} \right) h_\rho \text{co} +$ $\text{Khm} \cdot h_\theta \text{si} \cdot \cos(\theta) + \text{Khm}^1 h_\theta \text{si} \cdot \sin(\theta) = 0$

Equation (25) is equivalent to two equations of the form

$$-\frac{e_\varphi \sin \theta}{\rho} + \frac{\partial}{\partial \rho} \left(\frac{1}{\rho} \right) e_\varphi \sin \theta = 0, \quad (31)$$

$$-e_\varphi \chi \cos \theta + \omega \frac{\mu}{c} h_\theta \cos \theta = 0. \quad (32)$$

Equation (31) holds for any value of e_φ . Therefore, equation (25) is equivalent to equation (32) or

$$-e_\varphi \chi + \omega \frac{\mu}{c} h_\theta = 0. \quad (34)$$

In table 4 we will write the equations from table 2 after similar transformations. Similarly, it is proved that equations (26-28) are equivalent to equations (35-37) shown in table 4.

Table 4.

1	2	3
42	$\text{rot}_\rho(E)$	$\text{Kh}m \cdot e_\varphi \cos(\theta) + \text{Kh}m^1 \cdot e_\varphi \sin(\theta) = 0$
43	$\text{rot}_\rho(H)$	$\text{Kh}m \cdot h_\varphi \cos(\theta) + \text{Kh}m^1 \cdot h_\varphi \sin(\theta) = 0$
34	$\text{rot}_\theta(E)$	$-e_\varphi \chi + \omega \frac{\mu}{c} h_\theta = 0$
35	$\text{rot}_\theta(H)$	$+h_\varphi \chi + \omega \frac{\varepsilon}{c} e_\theta = 0$
36	$\text{rot}_\varphi(E)$	$e_\theta \chi + \omega \frac{\mu}{c} h_\varphi = 0$
37	$\text{rot}_\varphi(H)$	$h_\theta \chi - \omega \frac{\varepsilon}{c} e_\varphi = 0$
38	$\text{div}(E)$	$\text{Kh}m \cdot e_\theta \cos(\theta) + \text{Kh}m^1 \cdot e_\theta \sin(\theta) = 0$
39	$\text{div}(H)$	$\text{Kh}m \cdot h_\theta \cos(\theta) + \text{Kh}m^1 \cdot h_\theta \sin(\theta) = 0$

Equations (29, 30) are transformed into equations (38, 39) under the conditions

$$e_\varphi = e_\theta, \quad (40)$$

$$h_\varphi = -h_\theta. \quad (41)$$

Equation (23, 24) is transformed into equations (42, 43) under the same conditions.

Consider equations (35, 36). Multiplying their right and left sides, we find:

$$e_\theta h_\varphi \chi^2 = \omega^2 \frac{\mu \varepsilon}{c} e_\theta h_\varphi \quad (49)$$

or

$$\chi = \frac{\omega}{c} \sqrt{\varepsilon \mu}. \quad (50)$$

The same result is obtained when considering equations (34, 37). From (35, 50) it follows that

$$h_\varphi = \sqrt{\frac{\varepsilon}{\mu}} e_\theta, \quad (51)$$

and from (35, 50) it follows that

$$h_\theta = \sqrt{\frac{\varepsilon}{\mu}} e_\varphi, \quad (52)$$

From (40, 41, 51, 52) it follows that

$$e_\theta = e_\varphi = \sqrt{\frac{\mu}{\varepsilon}} h_\theta = -\sqrt{\frac{\mu}{\varepsilon}} h_\varphi, \quad (53)$$

or

$$h_\varphi = -h_\theta = \sqrt{\frac{\varepsilon}{\mu}} e_\theta = \sqrt{\frac{\varepsilon}{\mu}} e_\varphi. \quad (54)$$

It can be seen that equations (42, 43, 38, 39) coincide. We rewrite them as

$$\cos(x) \cdot y + \sin(x) \frac{\partial y}{\partial x} = 0, \quad (56)$$

where

$$y = \text{Khm}(\theta). \quad (57)$$

This function and its derivative are determined by formulas of the form

$$y = -\sin(\theta_1) = -|\sin(\theta)|, \quad (58)$$

$$\frac{\partial y}{\partial x} = \cos(\theta_1), \quad (59)$$

where θ_1 is the remainder of the division $\frac{\theta}{\pi}$. Functions (58, 59) and sum (56) are shown in Fig. 2.

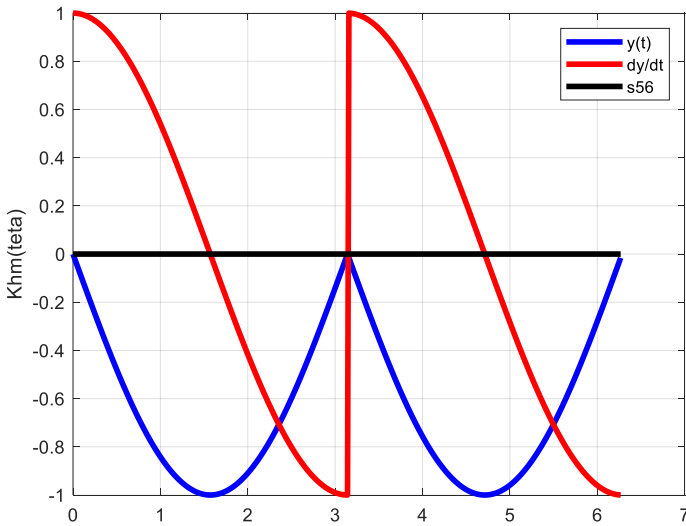

Fig. 2. teta (KhTest.m)

Note that in the well-known solution $g(\theta) = \sin(\theta)$. It is easy to verify that such a function does not satisfy Eq. (56). Consequently, **the known solution does not satisfy Maxwell's equations.**

The results obtained can be formulated as follows:

Theorem A. A monochromatic spherical wave as a solution of Maxwell's equations in spherical coordinates has a solution of the form (1-8), where the function $\text{Kh}m(\theta)$ is determined by differential equation (56), and the constants $\chi, \omega, e_\theta, e_\varphi, h_\theta, h_\varphi$ are related by relations of the form (50) and (54).

2. Energy flows

Electromagnetic energy flux density - Poynting vector

$$S = \eta E \times H, \quad (1)$$

where

$$\eta = c/4\pi. \quad (2)$$

In spherical coordinates φ, θ, ρ , the electromagnetic energy flux density has three components $S_\varphi, S_\theta, S_\rho$, directed along coordinates respectively. They are determined by the formula

$$S = \begin{bmatrix} S_\varphi \\ S_\theta \\ S_\rho \end{bmatrix} = \eta(E \times H) = \eta \begin{bmatrix} E_\theta H_\rho - E_\rho H_\theta \\ E_\rho H_\varphi - E_\varphi H_\rho \\ E_\varphi H_\theta - E_\theta H_\varphi \end{bmatrix}. \quad (3)$$

From this and (1.1-1.6) it follows that

$$S_\varphi = 0, \quad S_\theta = 0, \quad (4)$$

$$S_\rho = \frac{\eta}{\rho^2} (\text{Kh}m(\theta))^2 \begin{pmatrix} e_\varphi h_\theta (\sin(\chi\rho + \omega t))^2 - \\ -e_\theta h_\varphi (\cos(\chi\rho + \omega t))^2 \end{pmatrix}. \quad (5)$$

It follows from (1.54) that

$$S_\rho = \frac{\eta}{\rho^2} \sqrt{\frac{\varepsilon}{\mu}} (\text{Kh}m(\theta, \varphi) \cdot e_\varphi)^2. \quad (6)$$

Note also that the surface area of a sphere with radius ρ is $4\pi\rho^2$. Then the energy flux passing through a sphere with radius ρ is equal to

$$\overline{S}_\rho = \int_\theta 4\pi\rho^2 S_\rho d\theta = \eta \sqrt{\frac{\varepsilon}{\mu}} (e_\varphi)^2 \int_\theta^{2\pi} (\text{Kh}m(\theta, \varphi))^2 d\theta \quad (7)$$

3. Conclusion

A rigorous solution of Maxwell's equations is obtained, in which

- it follows from (1.1, 1.2, 1.4, 1.5) that the electric and magnetic intensities of the same name (in the coordinates φ and θ) are phase-shifted by a quarter of the period;

- it follows from (9) that the flow of electromagnetic energy passing through the spheres along the radius remains constant with increasing radius and does NOT change in time, which strictly corresponds to the law of conservation of energy;
- it follows from (6) that the energy density changes along the meridian according to the law $(\text{Khm}(\theta))^2$.

Chapter 8B. Solution of Maxwell's Equations for Spherical Coordinates. Solution variant B

Contents

1. Solving Maxwell's equations \ 1
2. Energy density \ 7
3. Energy flows \ 8
4. Conclusion \ 10

1. Solving Maxwell's equations

In this version $\alpha = any, E_\rho = 0, H_\rho = 0$. Wherein

$$E_\varphi = \frac{e_\varphi}{\rho} \text{Khm}(\theta, \alpha) \text{si}, \quad (1)$$

$$E_\theta = \frac{e_\theta}{\rho} \text{Khm}(\theta, \alpha) \text{co}, \quad (2)$$

$$E_\rho = 0, \quad (3)$$

$$H_\varphi = \frac{h_\varphi}{\rho} \text{Khm}(\theta, \alpha) \text{co}, \quad (4)$$

$$H_\theta = \frac{h_\theta}{\rho} \text{Khm}(\theta, \alpha) \text{si}, \quad (5)$$

$$H_\rho = 0, \quad (6)$$

where

$$\text{Khm}^1(\theta, \alpha) = \frac{\partial}{\partial \theta} \text{Khm}(\theta, \alpha), \quad (7)$$

$$\text{co} = \cos(\alpha \varphi + \chi \rho + \omega t), \quad (8)$$

$$\text{si} = \sin(\alpha \varphi + \chi \rho + \omega t). \quad (9)$$

In this case, table 8.2 takes the form of table 1. Substituting (1-9) in the formulas of the table 1, we obtain after reduction the equations shown in table 2.

Table 1.

1	2	3
1	$\text{rot}_\rho(E)$	$\frac{E_\varphi}{\rho t g(\theta)} + \frac{\partial E_\varphi}{\rho \partial \theta} - \frac{\partial E_\theta}{\rho \sin(\theta) \partial \varphi} = 0$
2	$\text{rot}_\theta(E)$	$-\frac{E_\varphi}{\rho} - \frac{\partial E_\varphi}{\partial \rho} + \frac{\mu}{c} \frac{\partial H_\theta}{\partial t} = 0$
3	$\text{rot}_\varphi(E)$	$\frac{E_\theta}{\rho} + \frac{\partial E_\theta}{\partial \rho} - \frac{\partial E_\rho}{\rho \partial \varphi} + \frac{\mu}{c} \frac{\partial H_\varphi}{\partial t} = 0$
4	$\text{div}(E)$	$\frac{E_\theta}{\rho t g(\theta)} + \frac{\partial E_\theta}{\rho \partial \theta} + \frac{\partial E_\varphi}{\rho \sin(\theta) \partial \varphi} = 0$
5	$\text{rot}_\rho(H)$	$\frac{H_\varphi}{\rho t g(\theta)} + \frac{\partial H_\varphi}{\rho \partial \theta} - \frac{\partial H_\theta}{\rho \sin(\theta) \partial \varphi} = 0$
6	$\text{rot}_\theta(H)$	$-\frac{H_\varphi}{\rho} - \frac{\partial H_\varphi}{\partial \rho} - \frac{\varepsilon}{c} \frac{\partial E_\theta}{\partial t} = 0$
7	$\text{rot}_\varphi(H)$	$\frac{H_\theta}{\rho} + \frac{\partial H_\theta}{\partial \rho} - \frac{\partial H_\rho}{\rho \partial \varphi} - \frac{\varepsilon}{c} \frac{\partial E_\varphi}{\partial t} = 0$
8	$\text{div}(H)$	$\frac{H_\theta}{\rho t g(\theta)} + \frac{\partial H_\theta}{\rho \partial \theta} + \frac{\partial H_\varphi}{\rho \sin(\theta) \partial \varphi} = 0$

Table 3.

1	2	3
23	$\text{rot}_\rho(E)$	$\text{Khm} \cdot e_\varphi \text{si} \cdot \cos(\theta) + \text{Khm}^1 e_\varphi \text{si} \cdot \sin(\theta) + \text{Khm} \cdot \alpha \cdot e_\rho \text{si} = 0$
24	$\text{rot}_\rho(H)$	$\text{Khm} \cdot h_\varphi \text{co} \cdot \cos(\theta) + \text{Khm}^1 h_\varphi \text{co} \cdot \sin(\theta) - \text{Khm} \cdot \alpha \cdot h_\theta \text{co} = 0$
25	$\text{rot}_\theta(E)$	$-\frac{e_\varphi \text{si}}{\rho^2} - \frac{e_\varphi}{\rho} \chi \text{co} - \frac{\partial}{\partial \rho} \left(\frac{1}{\rho} \right) \cdot e_\varphi \text{si} + \omega \frac{\mu}{c} \frac{h_\theta}{\rho} \text{co} = 0$
26	$\text{rot}_\theta(H)$	$-\frac{h_\varphi \text{co}}{\rho^2} + \frac{h_\varphi}{\rho} \chi \text{si} - \frac{\partial}{\partial \rho} \left(\frac{1}{\rho} \right) \cdot \frac{h_\varphi}{\rho} \text{co} + \omega \frac{\varepsilon}{c} \frac{e_\theta}{\rho} \text{si} = 0$
27	$\text{rot}_\varphi(E)$	$\frac{e_\theta \text{co}}{\rho^2} - \frac{e_\theta}{\rho} \chi \text{si} + \frac{\partial}{\partial \rho} \left(\frac{1}{\rho} \right) e_\theta \text{co} - \omega \frac{\mu}{c} \frac{h_\varphi}{\rho} \text{si} = 0$
28	$\text{rot}_\varphi(H)$	$\frac{h_\theta \text{si}}{\rho^2} + \frac{h_\theta}{\rho} \chi \text{co} + \frac{\partial}{\partial \rho} \left(\frac{1}{\rho} \right) \cdot \frac{h_\theta}{\rho} \text{si} - \omega \frac{\varepsilon}{c} \frac{e_\varphi}{\rho} \text{co} = 0$
29	$\text{div}(E)$	$\frac{e_\rho}{\rho} \chi \text{co} + \frac{\partial}{\partial \rho} \left(\frac{1}{\rho} \right) e_\rho \text{si} + \text{Khm} \cdot e_\theta \text{co} \cdot \cos(\theta) + \text{Khm}^1 e_\theta \text{co} \cdot \sin(\theta) + \text{Khm} \cdot e_\varphi \alpha \text{co} = 0$
30	$\text{div}(H)$	$-\frac{h_\rho}{\rho} \chi \text{si} + \frac{\partial}{\partial \rho} \left(\frac{1}{\rho} \right) h_\rho \text{co} + \text{Khm} \cdot h_\theta \text{si} \cdot \cos(\theta) + \text{Khm}^1 h_\theta \text{si} \cdot \sin(\theta) - \text{Khm} \cdot h_\varphi \alpha \text{si} = 0$

Equation (25) is equivalent to two equations of the form

$$-\frac{e_\varphi \sin \theta}{\rho} + \frac{\partial}{\partial \rho} \left(\frac{1}{\rho} \right) e_\varphi \sin \theta = 0, \quad (31)$$

$$-e_\varphi \chi \cos \theta + \omega \frac{\mu}{c} h_\theta \cos \theta = 0. \quad (32)$$

Equation (31) holds for any value of e_φ . Therefore, equation (25) is equivalent to equation (32) or

$$-e_\varphi \chi + \omega \frac{\mu}{c} h_\theta = 0. \quad (34)$$

In table 4 we will write the equations from table 2 after similar transformations. Similarly, it is proved that equations (26-28) are equivalent to equations (35-37) shown in table 4.

Table 4.

1	2	3
42	$\text{rot}_\rho(E)$	$\text{Khm} \cdot e_\varphi \cos(\theta) + \text{Khm1} \cdot e_\varphi \sin(\theta) + \text{Khm} \cdot e_\theta \alpha = 0$
43	$\text{rot}_\rho(H)$	$\text{Khm} \cdot h_\varphi \cos(\theta) + \text{Khm1} \cdot h_\varphi \sin(\theta) + \text{Khm} \cdot h_\theta \alpha = 0$
34	$\text{rot}_\theta(E)$	$-e_\varphi \chi + \omega \frac{\mu}{c} h_\theta = 0$
35	$\text{rot}_\theta(H)$	$+h_\varphi \chi + \omega \frac{\varepsilon}{c} e_\theta = 0$
36	$\text{rot}_\varphi(E)$	$e_\theta \chi + \omega \frac{\mu}{c} h_\varphi = 0$
37	$\text{rot}_\varphi(H)$	$h_\theta \chi - \omega \frac{\varepsilon}{c} e_\varphi = 0$
38	$\text{div}(E)$	$\text{Khm} \cdot e_\theta \cos(\theta) + \text{Khm1} \cdot e_\theta \sin(\theta) + \text{Khm} \cdot e_\varphi \alpha = 0$
39	$\text{div}(H)$	$\text{Khm} \cdot h_\theta \cos(\theta) + \text{Khm1} \cdot h_\theta \sin(\theta) + \text{Khm} \cdot h_\varphi \alpha = 0$

It can be seen that equations (42, 43, 38, 39) coincide. We rewrite them as

$$\cos(x) \cdot y + \sin(x) \frac{\partial y}{\partial x} = 0, \quad (46)$$

where

$$y = \text{Khm}(\theta, \alpha). \quad (47)$$

When $\alpha = 0$, the value of the function is undefined. In the general case, differential equation (46) has no analytical solution. In particular,

$$\text{Khm}(\theta, \alpha) \rightarrow \left\{ \begin{array}{l} 1, \text{ if } \alpha \rightarrow \frac{\pi}{2} \\ -1, \text{ if } \alpha \rightarrow -\frac{\pi}{2} \\ \sin(\theta), \text{ if } \alpha \rightarrow \infty \end{array} \right\}, \quad (48)$$

In fig. 2 shows the functions $\text{Khm}(\theta, \alpha)$ for different values of α . For comparison, the $\sin(\theta)$ function is shown as dots.

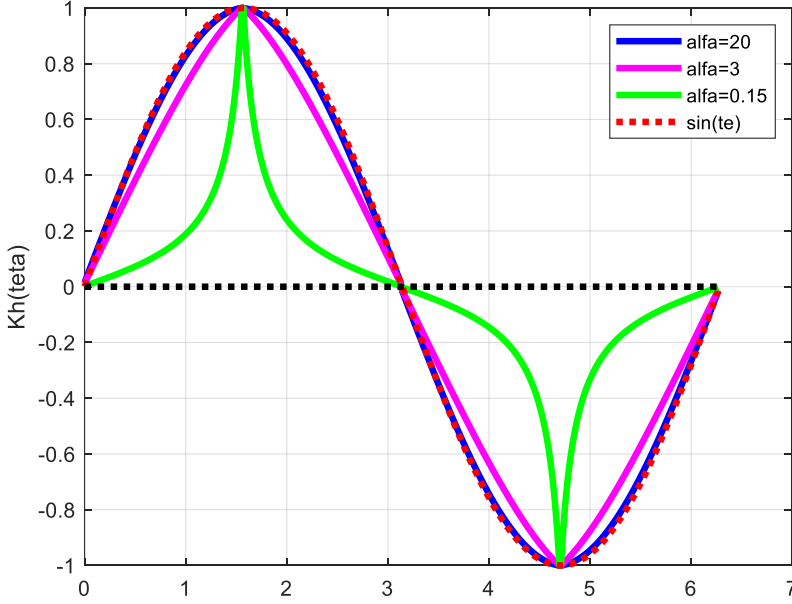

Fig. 2. teta (KhTest.m)

Consider equations (35, 36). Multiplying their right and left sides, we find:

$$e_{\theta} h_{\varphi} \chi^2 = \omega^2 \frac{\mu \varepsilon}{c^2} e_{\theta} h_{\varphi} \quad (49)$$

or

$$\chi = \frac{\omega}{c} \sqrt{\varepsilon \mu}. \quad (50)$$

The same result is obtained when considering equations (34, 37). From (35, 50) it follows that

$$h_{\varphi} = \sqrt{\frac{\varepsilon}{\mu}} e_{\theta}, \quad (51)$$

and from (35, 50) it follows that

$$h_{\theta} = \sqrt{\frac{\varepsilon}{\mu}} e_{\varphi}, \quad (52)$$

From (40, 41, 51, 52) it follows that

$$e_\theta = e_\varphi = \sqrt{\frac{\mu}{\varepsilon}} h_\theta = -\sqrt{\frac{\mu}{\varepsilon}} h_\varphi, \quad (53)$$

or

$$h_\varphi = -h_\theta = \sqrt{\frac{\varepsilon}{\mu}} e_\theta = \sqrt{\frac{\varepsilon}{\mu}} e_\varphi. \quad (54)$$

The results obtained can be formulated as follows:

Theorem A. A monochromatic spherical wave as a solution of Maxwell's equations in spherical coordinates has a solution of the form (1-9), where the function $\text{Khm}(\theta, \alpha)$ is determined by differential equation (46), the constants χ, ω are related by relations of the form (50), the constants $\chi, \omega, e_\theta, e_\varphi, h_\theta, h_\varphi$ are related by relations of the form (50, 54.

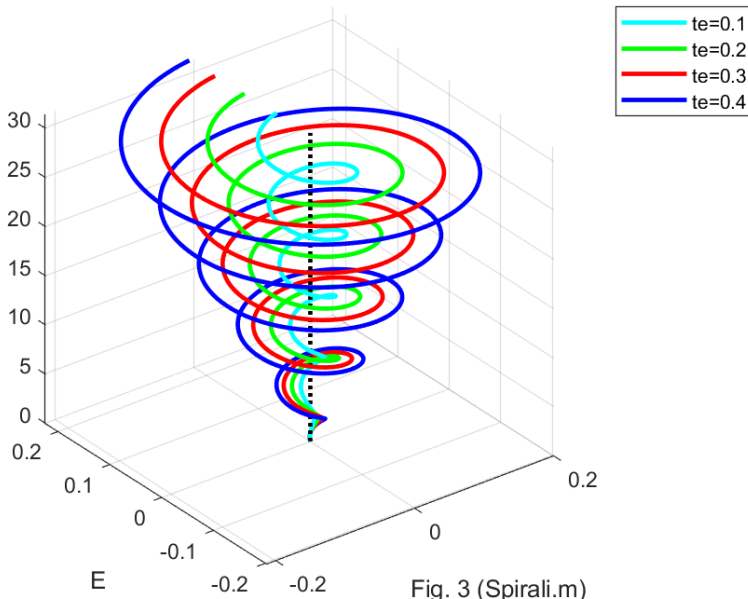

In fig. 3 shows the spirals - the geometrical places of the points where the density of the electrical strengths when multiplied by ρ remains constant. These spirals lie on a cone with an angle θ . Several of these cones are shown.

The following fig. 4 show vectors of electric strengths on a circle with a given radius of a sphere and a given angle θ . The start points of these vectors lie on a given circle, and the end points of these vectors lie on a certain curve. These figures illustrate the swirling of an electromagnetic wave. The vectors of strengths $\mathbf{E}t = \mathbf{E}_\theta$, $\mathbf{E}f = \mathbf{E}_\varphi$,

$(\overline{Et} + \overline{Ef})$ are shown for several values of θ and the following designations are adopted:

- Et+Ef
- Ef
- Et

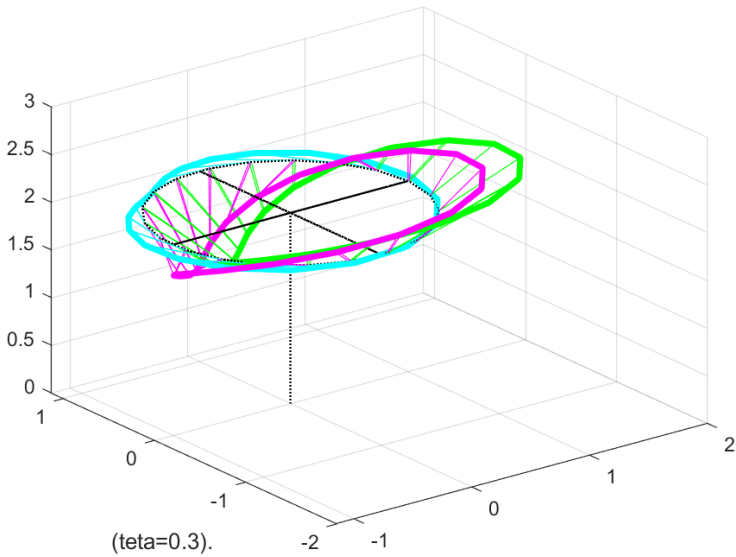
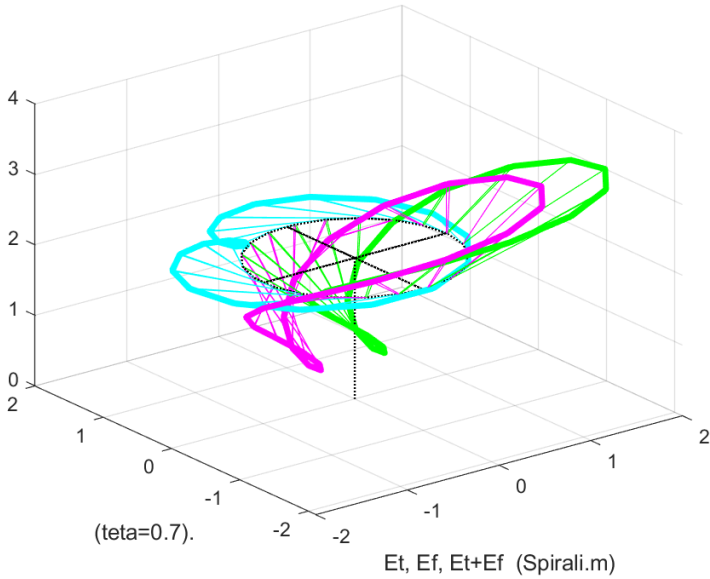

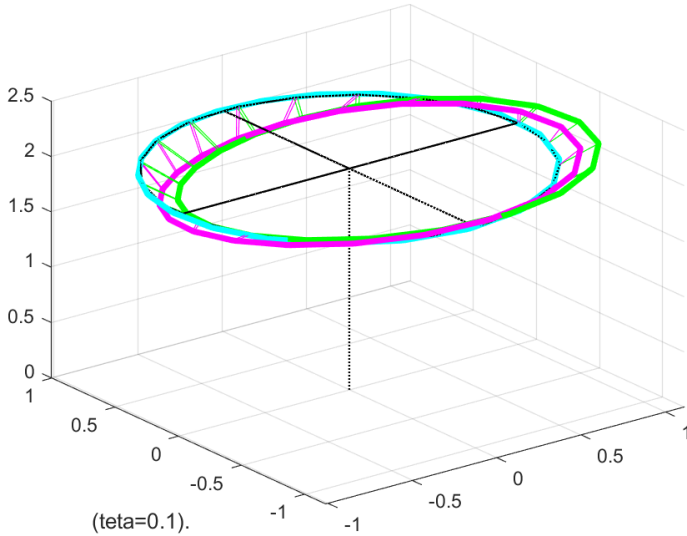

2. Energy density

Energy density

$$W = \frac{1}{8\pi} (\epsilon H^2 + \mu E^2) \quad (1)$$

Taking into account (1.9, 1.10, 1.12, 1.13), we find:

$$\begin{aligned} W &= \frac{1}{8\pi} (\epsilon (E_\varphi^2 + E_\theta^2) + \mu (H_\varphi^2 + H_\theta^2)) = \\ &= \frac{(\text{Khm}(\theta, \alpha))^2}{8\pi\rho^2} (\epsilon ((e_\varphi \text{si})^2 + (e_\theta \text{co})^2) + \mu ((h_\varphi \text{co})^2 + (h_\theta \text{si})^2)) \end{aligned}$$

Taking into account (1.53, 1.54), we find:

$$W = \frac{(\text{Khm}(\theta, \alpha))^2}{8\pi\rho^2} e_\varphi^2 \left(\epsilon (\text{si}^2 + \text{co}^2) + \mu \frac{\epsilon}{\mu} (\text{co}^2 + \text{si}^2) \right)$$

or

$$W = (\text{Khm}(\theta, \alpha))^2 \frac{\epsilon e_\varphi^2}{4\pi\rho^2} \quad (2)$$

The energy density on a sphere with radius ρ is

$$W = \epsilon e_\varphi^2 (\text{Khm}(\theta, \alpha))^2 \quad (3)$$

Thus, the energy density at each point of the sphere depends only on $\text{Khm}(\theta, \alpha)$.

3. Energy flows

Electromagnetic energy flux density - Poynting vector

$$S = \eta E \times H, \quad (1)$$

where

$$\eta = c/4\pi. \quad (2)$$

In spherical coordinates φ, θ, ρ , the electromagnetic energy flux density has three components $S_\varphi, S_\theta, S_\rho$, directed along coordinates respectively. They are determined by the formula

$$S = \begin{bmatrix} S_\varphi \\ S_\theta \\ S_\rho \end{bmatrix} = \eta(E \times H) = \eta \begin{bmatrix} E_\theta H_\rho - E_\rho H_\theta \\ E_\rho H_\varphi - E_\varphi H_\rho \\ E_\varphi H_\theta - E_\theta H_\varphi \end{bmatrix}. \quad (3)$$

From this and (1.1-1.6) it follows that

$$S_\varphi = 0, \quad S_\theta = 0, \quad (4)$$

$$S_\rho = (e_\varphi h_\theta \text{si}^2 - e_\theta h_\varphi \text{co}^2) \rho^{-2} \text{Khm}(\theta, \alpha)^2. \quad (6)$$

It follows from (1.54) that

$$S_\rho = \frac{\varepsilon}{\mu} \left(\frac{e_\varphi}{\rho} \text{Khm}(\theta, \alpha) \right)^2. \quad (7)$$

The flow of electromagnetic energy on a sphere of a given radius

$$\widehat{S}_\rho = 4\pi\rho^2 \int_0^{2\pi} (S_\rho d\theta) = 4\pi \frac{\varepsilon}{\mu} e_\varphi^2 \int_0^{2\pi} ((\text{Khm}(\theta, \alpha))^2 d\theta) \quad (8)$$

remains constant at each radius, which corresponds to the law of conservation of energy. It follows from formulas (7, 8) that the flow retains its value on the circumference of the cone with a given angle θ .

In fig. 5.0 shows the dependence of the quantity $\int_0^{2\pi} ((\text{Khm}(\theta, \alpha))^2 d\theta)$ on α .

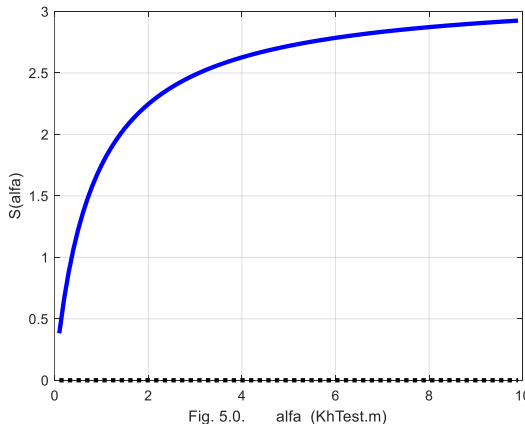

Fig. 5.0. alfa (KhTest.m)

The results obtained can be formulated as follows:

Theorem B. The energy flux in a spherical wave propagates only along the radius and its value remains constant at each moment of time on the surface of the sphere of each radius.

In fig. 5 shows the functions $E_\varphi, E_\theta, \widehat{S}_\rho$, defined by (1.9, 1.10, 8), respectively, for $\alpha = 5$ in the coordinates φ, θ on the sweep of the entire sphere at equal amplitudes e_φ at all points of the sphere and at some moment in time, and in Fig. 6 - the same on the sweep of the sphere. It is seen that the energy flux density on the sphere is substantially nonuniform, but the total flux satisfies the conditions of Theorem 2.

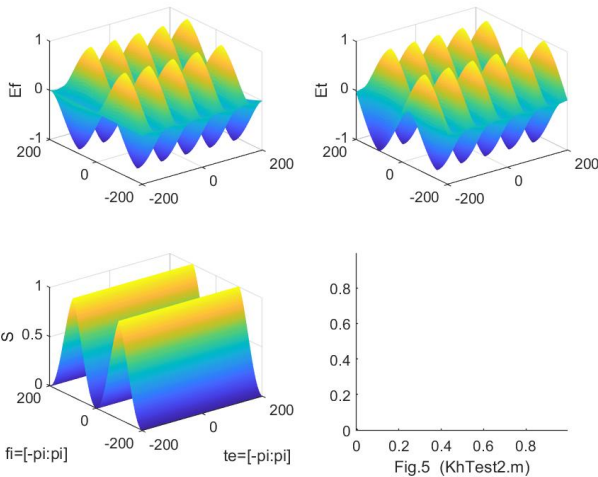

Fig.5 (KhTest2.m)

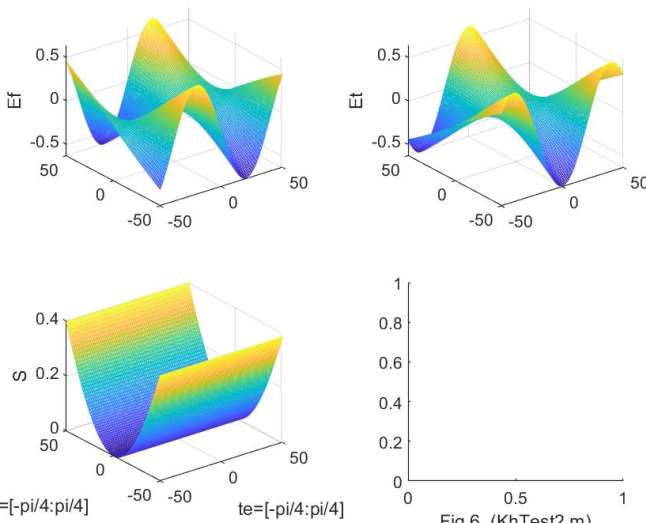

Fig.6 (KhTest2.m)

4. Discussion

In this discussion

- the density of the energy flux passing through the sphere does not depend on the radius and does not depend on time; this flow has the same magnitude on a spherical surface of any radius at any time; in other words, the energy flux directed along the radius retains its value with increasing radius and does not depend on time, which corresponds to the law of conservation of energy;
- there is a phase shift between electric and magnetic strengths, which follows directly from formulas (1.9-1.14);
- spiral propagation of electric and magnetic strengths is observed - see fig. 3.3;
- there is a swirling of the electromagnetic wave - see fig. 3.4.

Chapter 8C. Solution of Maxwell's Equations for Spherical Coordinates. Solution variant C

Contents

1. Solving Maxwell's equations \ 1
2. Energy flows \ 6
3. Conclusion \ 7

1. Solving Maxwell's equations

In this version $\alpha = 0, E_\rho = any, H_\rho = any$. Wherein

$$E_\varphi = \frac{e_\varphi}{\rho} Khm(\theta)si, \quad (1)$$

$$E_\theta = \frac{e_\theta}{\rho} Khm(\theta)co, \quad (2)$$

$$E_\rho = \frac{e_\rho}{\rho} Khm(\theta)si, \quad (3)$$

$$H_\varphi = \frac{h_\varphi}{\rho} Khm(\theta)co, \quad (4)$$

$$H_\theta = \frac{h_\theta}{\rho} Khm(\theta)si, \quad (5)$$

$$H_\rho = \frac{h_\rho}{\rho} Khm(\theta)co, \quad (6)$$

where

$$Khm^1(\theta) = \frac{\partial}{\partial \theta} Khm(\theta), \quad (7)$$

$$co = \cos(\chi\rho + \omega t), \quad (8)$$

$$si = \sin(\chi\rho + \omega t). \quad (9)$$

In this case, table 8.2 takes the form of table. 1. Substituting (1-9) in the formulas of the table 1, we obtain after reduction the equations shown in table 2.

Table 1.

1	2	3
1	$\text{rot}_\rho(E)$	$\frac{E_\varphi}{\rho \text{tg}(\theta)} + \frac{\partial E_\varphi}{\rho \partial \theta} + \frac{\mu}{c} \frac{\partial H_\rho}{\partial t} = 0$
2	$\text{rot}_\theta(E)$	$-\frac{E_\varphi}{\rho} - \frac{\partial E_\varphi}{\partial \rho} + \frac{\mu}{c} \frac{\partial H_\theta}{\partial t} = 0$
3	$\text{rot}_\varphi(E)$	$\frac{E_\theta}{\rho} + \frac{\partial E_\theta}{\partial \rho} + \frac{\mu}{c} \frac{\partial H_\varphi}{\partial t} = 0$
4	$\text{div}(E)$	$\frac{E_\rho}{\rho} + \frac{\partial E_\rho}{\partial \rho} + \frac{E_\theta}{\rho \text{tg}(\theta)} + \frac{\partial E_\theta}{\rho \partial \theta} = 0$
5	$\text{rot}_\rho(H)$	$\frac{H_\varphi}{\rho \text{tg}(\theta)} + \frac{\partial H_\varphi}{\rho \partial \theta} - \frac{\varepsilon}{c} \frac{\partial E_\rho}{\partial t} = 0$
6	$\text{rot}_\theta(H)$	$-\frac{H_\varphi}{\rho} - \frac{\partial H_\varphi}{\partial \rho} - \frac{\varepsilon}{c} \frac{\partial E_\theta}{\partial t} = 0$
7	$\text{rot}_\varphi(H)$	$\frac{H_\theta}{\rho} + \frac{\partial H_\theta}{\partial \rho} - \frac{\varepsilon}{c} \frac{\partial E_\varphi}{\partial t} = 0$
8	$\text{div}(H)$	$\frac{H_\rho}{\rho} + \frac{\partial H_\rho}{\partial \rho} + \frac{H_\theta}{\rho \text{tg}(\theta)} + \frac{\partial H_\theta}{\rho \partial \theta} = 0$

Table 2.

1	2	3
23	$\text{rot}_\rho(E)$	$\text{Kh}m \cdot e_\varphi \text{si} \cdot \cos(\theta) + \text{Kh}m^1 e_\varphi \text{si} \cdot \sin(\theta) +$ $-\text{Kh}m \cdot \omega \frac{\mu}{c} h_\rho \text{si} = 0$
24	$\text{rot}_\rho(H)$	$\text{Kh}m \cdot h_\varphi \text{co} \cdot \cos(\theta) + \text{Kh}m^1 h_\varphi \text{co} \cdot \sin(\theta)$ $-\text{Kh}m \cdot \omega \frac{\varepsilon}{c} e_\rho \text{co} = 0$
25	$\text{rot}_\theta(E)$	$-\frac{e_\varphi \text{si}}{\rho^2} - \frac{e_\varphi}{\rho} \chi \text{co} - \frac{\partial}{\partial \rho} \left(\frac{1}{\rho} \right) \cdot e_\varphi \text{si} + \omega \frac{\mu}{c} \frac{h_\theta}{\rho} \text{co} = 0$
26	$\text{rot}_\theta(H)$	$-\frac{h_\varphi \text{co}}{\rho^2} + \frac{h_\varphi}{\rho} \chi \text{si} - \frac{\partial}{\partial \rho} \left(\frac{1}{\rho} \right) \cdot h_\varphi \text{co} + \omega \frac{\varepsilon}{c} \frac{e_\theta}{\rho} \text{si} = 0$
27	$\text{rot}_\varphi(E)$	$\frac{e_\theta \text{co}}{\rho^2} - \frac{e_\theta}{\rho} \chi \text{si} + \frac{\partial}{\partial \rho} \left(\frac{1}{\rho} \right) e_\theta \text{co} - \omega \frac{\mu}{c} \frac{h_\varphi}{\rho} \text{si} = 0$
28	$\text{rot}_\varphi(H)$	$\frac{h_\theta \text{si}}{\rho^2} + \frac{h_\theta}{\rho} \chi \text{co} + \frac{\partial}{\partial \rho} \left(\frac{1}{\rho} \right) \cdot \frac{h_\theta}{\rho} \text{si} - \omega \frac{\varepsilon}{c} \frac{e_\varphi}{\rho} \text{co} = 0$
29	$\text{div}(E)$	$\text{Kh}m \cdot \frac{e_\rho \text{si}}{\rho^2} + \text{Kh}m \cdot \frac{e_\rho}{\rho} \chi \text{co} + \text{Kh}m \cdot \frac{\partial}{\partial \rho} \left(\frac{1}{\rho} \right) e_\rho \text{si} +$ $\text{Kh}m \cdot e_\theta \text{co} \cdot \cos(\theta) + \text{Kh}m^1 e_\theta \text{co} \cdot \sin(\theta) = 0$
30	$\text{div}(H)$	$\text{Kh}m \cdot \frac{h_\rho \text{co}}{\rho^2} - \text{Kh}m \cdot \frac{h_\rho}{\rho} \chi \text{si} + \text{Kh}m \cdot \frac{\partial}{\partial \rho} \left(\frac{1}{\rho} \right) h_\rho \text{co} +$ $\text{Kh}m \cdot h_\theta \text{si} \cdot \cos(\theta) + \text{Kh}m^1 h_\theta \text{si} \cdot \sin(\theta) = 0$

Equation (25) is equivalent to two equations of the form

$$-\frac{e_\varphi \sin \theta}{\rho} + \frac{\partial}{\partial \rho} \left(\frac{1}{\rho} \right) e_\varphi \sin \theta = 0, \quad (31)$$

$$-e_\varphi \chi \cos \theta + \omega \frac{\mu}{c} h_\theta \cos \theta = 0. \quad (32)$$

Equation (31) holds for any value of e_φ . Therefore, equation (25) is equivalent to equation (32) or

$$-e_\varphi \chi + \omega \frac{\mu}{c} h_\theta = 0. \quad (34)$$

In table 4 we will write the equations from table 2 after similar transformations. Similarly, it is proved that equations (26-28) are equivalent to equations (35-37) shown in table 4.

Таблица 4.

1	2	3
42	$\text{rot}_\rho(E)$	$\text{Khm} \cdot e_\varphi \cos(\theta) + \text{Khm}^1 \cdot e_\varphi \sin(\theta)$ $-\text{Khm} \cdot \omega \frac{\mu}{c} h_\rho = 0$
43	$\text{rot}_\rho(H)$	$\text{Khm} \cdot h_\varphi \cos(\theta) + \text{Khm}^1 \cdot h_\varphi \sin(\theta)$ $-\text{Khm} \cdot \omega \frac{\varepsilon}{c} e_\rho \cos \theta = 0$
34	$\text{rot}_\theta(E)$	$-e_\varphi \chi + \omega \frac{\mu}{c} h_\theta = 0$
35	$\text{rot}_\theta(H)$	$h_\varphi \chi + \omega \frac{\varepsilon}{c} e_\theta = 0$
36	$\text{rot}_\varphi(E)$	$e_\theta \chi + \omega \frac{\mu}{c} h_\varphi = 0$
37	$\text{rot}_\varphi(H)$	$h_\theta \chi - \omega \frac{\varepsilon}{c} e_\varphi = 0$
38	$\text{div}(E)$	$\text{Khm} \cdot e_\rho \chi + \text{Khm} \cdot e_\theta \cos(\theta) + \text{Khm}^1 \cdot e_\theta \sin(\theta) = 0$
39	$\text{div}(H)$	$-\text{Khm} \cdot h_\rho \chi + \text{Khm} \cdot h_\theta \cos(\theta) + \text{Khm}^1 \cdot h_\theta \sin(\theta) = 0$

Equations (29, 30) are transformed into equations (38, 39) under the conditions

$$e_\varphi = e_\theta, \quad (40)$$

$$h_\varphi = -h_\theta. \quad (41)$$

Equation (23, 24) is transformed into equations (42, 43) under the same conditions.

Consider equations (35, 36). Multiplying their right and left sides, we find:

$$e_\theta h_\varphi \chi^2 = \omega^2 \frac{\mu \varepsilon}{c} e_\theta h_\varphi \quad (49)$$

or

$$\chi = \frac{\omega}{c} \sqrt{\varepsilon\mu}. \quad (50)$$

The same result is obtained when considering equations (34, 37). From (35, 50) it follows that

$$h_\varphi = \sqrt{\frac{\varepsilon}{\mu}} e_\theta, \quad (51)$$

and from (35, 50) it follows that

$$h_\theta = \sqrt{\frac{\varepsilon}{\mu}} e_\varphi, \quad (52)$$

From (40, 41, 51, 52) it follows that

$$e_\theta = e_\varphi = \sqrt{\frac{\mu}{\varepsilon}} h_\theta = -\sqrt{\frac{\mu}{\varepsilon}} h_\varphi, \quad (53)$$

or

$$h_\varphi = -h_\theta = \sqrt{\frac{\varepsilon}{\mu}} e_\theta = \sqrt{\frac{\varepsilon}{\mu}} e_\varphi. \quad (54)$$

It can be noted that equations (42, 43, 38, 39) coincide under conditions (40, 41) and

$$-\omega \frac{\mu}{c} h_\rho = e_\rho \chi \quad (55)$$

$$-\omega \frac{\varepsilon}{c} e_\rho = -h_\rho \chi. \quad (56)$$

Let's consider these equations. Multiplying their right and left sides, we find the previously obtained expression (50). Therefore, equations (42, 43, 38, 39) coincide under condition (50). From (56, 50) we find:

$$h_\rho = \frac{\omega \varepsilon}{\chi c} e_\rho = \sqrt{\frac{\varepsilon}{\mu}} e_\rho. \quad (57)$$

We rewrite (38) as

$$\text{Khm} \cdot (e_\theta \cos(\theta) + e_\rho \chi) + \text{Khm}^1 \cdot e_\theta \sin(\theta) = 0$$

or, taking into account (40),

$$\text{Khm} \cdot \left(\cos(\theta) + \frac{e_\rho}{e_\varphi} \chi \right) + \text{Khm}^1 \cdot \sin(\theta) = 0.$$

Thus, (42, 43, 38, 39) can be represented as

$$(\cos(\theta) + \beta) \cdot y + \sin(x) \frac{\partial y}{\partial x} = 0, \quad (57)$$

where

$$y = \text{Khm}(\theta), \quad (58)$$

$$\beta = \frac{e_\rho}{e_\varphi} \chi. \quad (59)$$

In the general case, differential equation (57) has no analytical solution. In particular,

$$\text{Khm}(\theta, \beta) \rightarrow \begin{cases} 1, & \text{if } \beta \rightarrow \frac{\pi}{2} \\ -1, & \text{if } \beta \rightarrow -\frac{\pi}{2} \\ \sin(\theta), & \text{if } \beta \rightarrow \infty \end{cases}, \quad (60)$$

In fig. 2 shows the functions $\text{Khm}(\theta, \beta)$ for different values of β . For comparison, the $\sin(\theta)$ function is shown as dots.

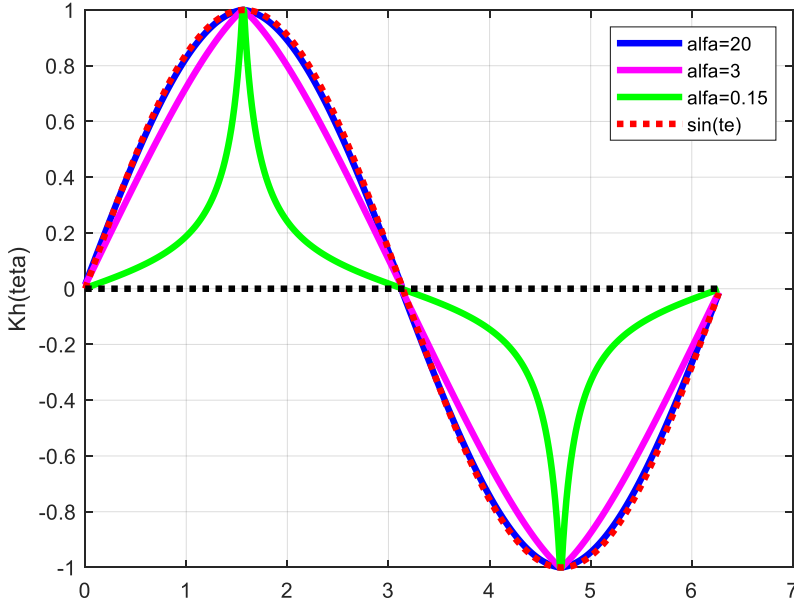

Fig. 2. teta (KhTest.m)

The results obtained can be formulated as follows:

Theorem C. A monochromatic spherical wave as a solution of Maxwell's equations in spherical coordinates has a solution of the form (1-9), where the function $\text{Khm}(\theta, \beta)$ is determined by differential equation (57, 59), the constants χ, ω are related by relations of the form (50), the constants $e_\theta, e_\varphi, h_\theta, h_\varphi$ are related by relations of the form (54), the constants e_ρ, h_ρ are related by relations of the form (57).

2. Energy flows

Electromagnetic energy flux density - Poynting vector

$$S = \eta E \times H, \quad (1)$$

where

$$\eta = c/4\pi. \quad (2)$$

In spherical coordinates φ, θ, ρ , the electromagnetic energy flux density has three components $S_\varphi, S_\theta, S_\rho$, directed along coordinates respectively. They are determined by the formula

$$S = \begin{bmatrix} S_\varphi \\ S_\theta \\ S_\rho \end{bmatrix} = \eta(E \times H) = \eta \begin{bmatrix} E_\theta H_\rho - E_\rho H_\theta \\ E_\rho H_\varphi - E_\varphi H_\rho \\ E_\varphi H_\theta - E_\theta H_\varphi \end{bmatrix}. \quad (3)$$

From this and from (1.1-1.6, 1.54, 1.57) it follows that

$$S_\varphi = \frac{\eta}{\rho^2} (\text{Kh}m(\theta))^2 \begin{pmatrix} h_\rho e_\theta \cdot \text{co}^2 - \\ -e_\rho h_\theta \cdot \text{si}^2 \end{pmatrix} =$$

$$\frac{\eta}{\rho^2} (\text{Kh}m(\theta))^2 \begin{pmatrix} e_\rho \sqrt{\frac{\varepsilon}{\mu}} e_\theta \cdot \text{co}^2 + \\ + e_\rho \sqrt{\frac{\varepsilon}{\mu}} e_\theta \cdot \text{si}^2 \end{pmatrix} =$$

$$\frac{\eta}{\rho^2} (\text{Kh}m(\theta))^2 e_\rho e_\theta \sqrt{\frac{\varepsilon}{\mu}}. \quad (4)$$

$$S_\theta = \frac{\eta}{\rho^2} (\text{Kh}m(\theta))^2 \begin{pmatrix} e_\rho h_\varphi \text{si} \cdot \text{co} - \\ -e_\varphi h_\rho \text{si} \cdot \text{co} \end{pmatrix} =$$

$$\frac{\eta}{\rho^2} (\text{Kh}m(\theta))^2 \begin{pmatrix} e_\rho \sqrt{\frac{\varepsilon}{\mu}} e_\varphi \text{si} \cdot \text{co} - \\ -e_\varphi \sqrt{\frac{\varepsilon}{\mu}} e_\rho \text{si} \cdot \text{co} \end{pmatrix} = 0 \quad (5)$$

$$S_\rho = \frac{\eta}{\rho^2} (\text{Kh}m(\theta))^2 \begin{pmatrix} e_\varphi h_\theta \text{si}^2 - \\ -e_\theta h_\varphi \text{co}^2 \end{pmatrix} =$$

$$\frac{\eta}{\rho^2} (\text{Kh}m(\theta))^2 e_\varphi h_\theta. \quad (6)$$

From (5, 1.54) it follows that

$$S_\rho = \frac{\eta}{\rho^2} \sqrt{\frac{\varepsilon}{\mu}} (\text{Kh}m(\theta) \cdot e_\varphi)^2. \quad (7)$$

Note also that the surface area of a sphere with radius ρ is $4\pi\rho^2$. Then the energy flux passing through a sphere with radius ρ is equal to

$$\overline{S}_\rho = \int_\theta 4\pi\rho^2 S_\rho d\theta = \eta \sqrt{\frac{\varepsilon}{\mu}} (e_\varphi)^2 \int_\theta^{2\pi} (\text{Kh}m(\theta))^2 d\theta \quad (8)$$

From (1.56) it follows that

$$\int_\theta^{2\pi} (\text{Kh}m(\theta))^2 d\theta = \int_\theta^{2\pi} (\sin(\theta))^2 d\theta = \pi, \quad (9)$$

then

$$\overline{S}_\rho = \pi\eta \sqrt{\frac{\varepsilon}{\mu}} (e_\varphi)^2. \quad (10)$$

The energy flux passing along the circles of a sphere with radius ρ parallel to the equator is

$$\overline{S}_\varphi = \int_\theta 4\pi \rho^2 S_\varphi d\theta = \eta \sqrt{\frac{\varepsilon}{\mu}} e_\rho e_\theta \int_\theta^{2\pi} (\text{Khm}(\theta))^2 d\theta \quad (11)$$

From (9, 11) it follows that

$$\overline{S}_\rho = \pi\eta \sqrt{\frac{\varepsilon}{\mu}} e_\rho e_\theta. \quad (12)$$

3. Conclusion

A rigorous solution of Maxwell's equations is obtained, in which

- it follows from (1.1-1.10) that the electric and magnetic intensities of the same name (in the coordinates φ and θ) are phase-shifted by a quarter of the period;
- it follows from (10) that the flow of electromagnetic energy passing through the spheres along the radius remains constant with increasing radius and does NOT change in time, which strictly corresponds to the law of conservation of energy;
- from (12) it follows that the flow of electromagnetic energy, circulating in the sphere parallel to the equator, remains constant with increasing radius and does not change in time, which strictly corresponds to the law of conservation of energy;
- it follows from (4, 6) that the energy density changes along the meridian according to the law $\text{Khm}(\theta, \beta)^2$.

Chapter 8H. Spherical Capacitor of AC

Contents

1. Introduction \ 1
2. Solution of the Maxwell Equations \ 2
3. Electric and magnetic fields' strengths \ 4
4. Conclusion \ 5

1. Introduction

A spherical capacitor in a sinusoidal current circuit is considered below. The plates of such a capacitor are two spheres with a common center and radii $R_2 > R_1$, i.e. the radial coordinate varies within

$$R_1 < \rho < R_2. \quad (1)$$

2. Solution of the Maxwell Equations

Chapter 8C gives a solution to Maxwell's equations for a spherical electromagnetic wave. Along with solution C, there can exist a solution D, which differs only in that the strength functions in it have functions $\overline{\text{co}}$ instead of $\overline{\text{si}}$ in their definition and vice versa. We will denote all parameters of this solution by the upper sign $\overline{\quad}$. So, in this version $\alpha = 0$, $\overline{E}_\rho = \text{any}$, $\overline{H}_\rho = \text{any}$, and

$$\overline{E}_\varphi = \frac{\overline{e}_\varphi}{\rho} \text{Kh}m(\theta) \overline{\text{co}}, \quad (1)$$

$$\overline{E}_\theta = \frac{\overline{e}_\theta}{\rho} \text{Kh}m(\theta) \overline{\text{si}}, \quad (2)$$

$$\overline{E}_\rho = \frac{\overline{e}_\rho}{\rho} \text{Kh}m(\theta) \overline{\text{co}}, \quad (3)$$

$$\overline{H}_\varphi = \frac{\overline{h}_\varphi}{\rho} \text{Kh}m(\theta) \overline{\text{si}}, \quad (4)$$

$$\overline{H}_\theta = \frac{\overline{h}_\theta}{\rho} \text{Kh}m(\theta) \overline{\text{co}}, \quad (5)$$

$$\overline{H}_\rho = \frac{\overline{h}_\rho}{\rho} \text{Kh}m(\theta) \overline{\text{si}}, \quad (6)$$

where $\text{Kh}m(\theta)$ is a known function and

$$\overline{\text{co}} = \cos(\chi\rho + \omega t), \quad (7)$$

$$\overline{\text{si}} = \sin(\chi\rho + \omega t). \quad (8)$$

Two solutions C and D existing simultaneously will be called the solution CD. Thus, we have obtained a complex solution of the Maxwell equations for the sphere.

It is important to note that at the moment the potential on the sphere of the given radius changes as a function of $\text{Khm}(\theta)$. The outer and inner metal surfaces are on a constant radius. Consequently, the potential on the metal plate of the spherical radius is different at different points of the sphere. Consequently, further, the currents flow on the plates of the spherical capacitor.

An additional argument in favor of the existence of such currents is the existence of telluric currents [53]. There is no generally accepted explanation of their cause.

All strengths in the solution C and D depend on the value of two constants: $\overline{e}_\varphi, \overline{e}_\rho$ and $\overline{e}_\varphi, \overline{e}_\rho$, respectively. From the formulas for the strengths \overline{E}_ρ and \overline{E}_θ we find the modulus of the total strength and the angle between them:

$$|E_\rho| = \sqrt{(\overline{e}_\rho)^2 + (\overline{e}_\theta)^2} \quad (9)$$

$$\text{tg}(\psi_{e\rho}) = \frac{\overline{e}_\theta}{\overline{e}_\rho}. \quad (10)$$

Completely similar formulas exist for other strengths.

From the obtained formulas it follows that the spherical capacitor must have magnetic properties similar to its electrical properties.

For the known voltage with the RMS value of U on the capacitor, from (3) we find:

$$U = |E_\rho(R_2)| - |E_\rho(R_1)| = K \left(\frac{1}{R_2} - \frac{1}{R_1} \right), \quad (11)$$

where K is the constant. Consequently, the amplitude of the potential on the outer sphere of the capacitor is smaller than the amplitude of the potential on the inner sphere of the capacitor.

3. Electric and magnetic fields' strengths

Let us consider some point T with the coordinates (φ, θ) on a sphere of radius ρ . The vectors H_φ and H_θ , going from this point are in plane P, tangent to this sphere at point $T(\varphi, \theta)$ that is shown in Figure 1. These vectors are perpendicular to each other. Hence, at each point (φ, θ) the following sum vector

$$H_{\varphi\theta} = H_\varphi + H_\theta \quad (1)$$

is in plane P and has an angle of ψ to a parallel line. As follows from (1.1-1.8), the module of this vector $|\vec{H}_{\varphi\theta}|$ and the angle ψ are defined by the following formulas:

$$H_{\varphi\theta} = |H_{\varphi\theta}| \cos(\psi), \quad (2)$$

$$|H_{\varphi\theta}| = \frac{B}{\rho} \sin(\theta), \quad (3)$$

$$\psi = \text{arcctg}(\chi\rho + \omega t), \quad (4)$$

where B is a definite constant.

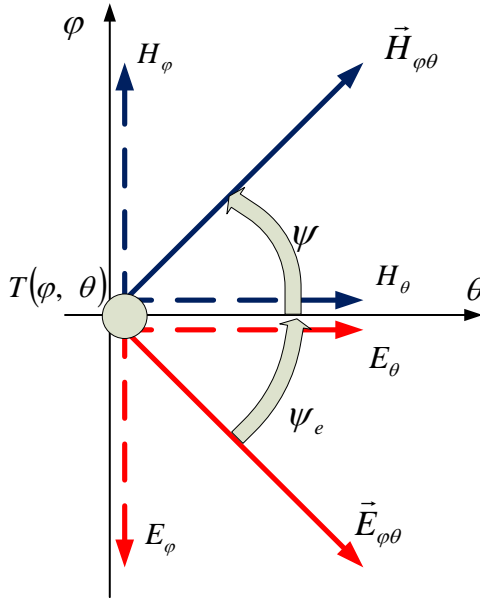

Fig. 1. (Sfera110.vsd)

We find the strengths $H_{\varphi\theta}$ at the poles of the sphere, where

$$\theta = \pm \frac{\pi}{2}, \quad \sin(\theta) = \pm 1, \quad \rho = R. \quad (5)$$

It follows from (2)-(4) that at the poles there is

$$|H_{\varphi\theta}| = \pm \frac{B}{R} \quad (6)$$

and there is the following magnetic strength between the poles

$$H_{pp} = \frac{2B}{R} \cos(\chi R + \omega t) \quad (7)$$

Similarly, the same relationships exist for the vectors \vec{E}_φ and \vec{E}_θ .

At each point (φ, θ) the total vector

$$\vec{E}_{\varphi\theta} = \vec{E}_\varphi + \vec{E}_\theta \quad (8)$$

lies in the plane P and is directed at an angle ψ_e to a line parallel (along the coordinate θ). As follows from (1.1-1.8), the module of this vector and the angle ψ_e are defined by the following formulas:

$$E_{\varphi\theta} = |E_{\varphi\theta}| \cos(\psi_e), \quad (9)$$

$$|E_{\varphi\theta}| = \frac{A}{\rho} \sin(\theta), \quad (10)$$

$$\psi_e = \arctg(\chi\rho + \omega t), \quad (11)$$

where A is a definite constant. There is the straight angle between the strengths $H_{\varphi\theta}$ and $E_{\varphi\theta}$ in the plane P.

Therefore, in a spherical capacitor we can consider only one vector of the electrical field strength $E_{\varphi\theta}$ and only one vector of the magnetic field strength $H_{\varphi\theta}$. As these vectors lie on the sphere, they will be called the spherical vectors.

Angle ψ (30) is constant for all the vectors $H_{\varphi\theta}$ for the given radius ρ . This means that the directions of all the vectors $H_{\varphi\theta}$ constitute the same angle ψ with all parallels on a sphere with the radius of ρ . This implies in turn that there are the magnetic equatorial plane inclined to the mathematical equatorial plane at angle ψ , magnetic axis, magnetic poles, and magnetic meridians, along which the vectors $H_{\varphi\theta}$ are directed. This is shown in Figure 2, where the thin lines mark the mathematical meridional grid, the thick lines mark the magnetic meridional grid. Also, the mathematical axis mm , the magnetic axis aa , and the electric axis bb are shown. It is important to note that the magnetic axis aa and the electric axis bb are perpendicular, and generally, all the vectors $E_{\varphi\theta}$ and $H_{\varphi\theta}$ are perpendicular.

When $\frac{\omega}{c} \approx 0$ the magnetic axis coincides with the mathematical axis. At points where spherical strengths are zero, only radial strengths exist.

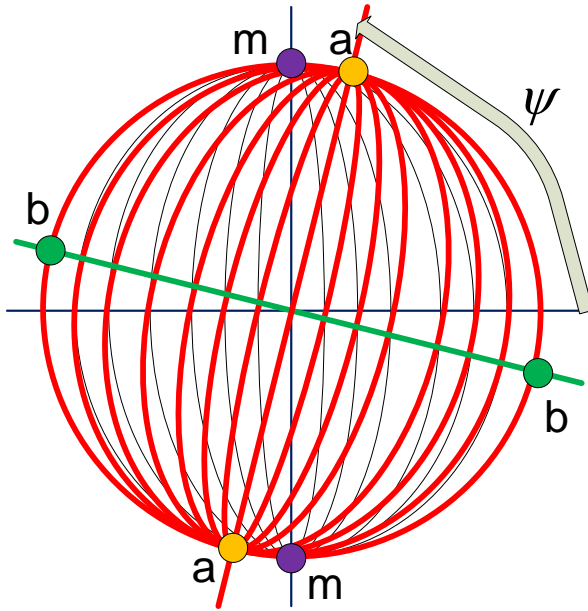

Fig. 2.

4. Conclusion

A rigorous solution of Maxwell's equations for a spherical capacitor is obtained, in which

- from the obtained formulas it follows that a spherical capacitor must have magnetic properties similar to its electrical properties;
- from (1.1-1.10) it follows that the electric and magnetic strengths of the same name (in spherical coordinates) are phase-shifted by a quarter of the period;
- it follows from the properties of solution 8C that the flow of electromagnetic energy passing through the spheres along the radius remains constant with increasing radius and does not change in time, which strictly corresponds to the law of conservation of energy;
- it follows from the properties of solution 8C that the flow of electromagnetic energy circulating over the sphere parallel to the equator remains constant with increasing radius and does not change in time, which strictly corresponds to the law of conservation of energy; the internal energy of the capacitor circulates in this stream;
- it follows from the properties of solution 8C that the energy density changes along the meridian according to the law $(Kh_m(\theta))^2$.

Chapter 8K. Spherical DC Capacitor

Contents

1. Introduction \ 1
2. Solving Maxwell's equations \ 1
3. Stability of the solution \ 4
4. Conclusion \ 7

1. Introduction

Chapter 8H deals with a spherical capacitor in a sinusoidal current circuit. The plates of such a capacitor are two spheres with a common center and radii $R_2 > R_1$, i.e. the radial coordinate varies within

$$R_1 < \rho < R_2. \quad (1)$$

Here we will consider a spherical capacitor connected to a DC link. It will be shown that the magnetic and electrical strengths inside the capacitor change during charging and reach steady-state values. Strictly speaking, these steady-state values are fluctuations around a steady state.

2. Solving Maxwell's equations

We will look for a solution in the form

$$E_\varphi = \frac{e_\varphi}{\rho} \text{Kh}m(\theta)\text{ch}, \quad (1)$$

$$E_\theta = \frac{e_\theta}{\rho} \text{Kh}m(\theta)\text{sh}, \quad (2)$$

$$E_\rho = \frac{e_\rho}{\rho} \text{Kh}m(\theta)\text{ch}, \quad (3)$$

$$H_\varphi = \frac{h_\varphi}{\rho} \text{Kh}m(\theta)\text{sh}, \quad (4)$$

$$H_\theta = \frac{h_\theta}{\rho} \text{Kh}m(\theta)\text{ch}, \quad (5)$$

$$H_\rho = \frac{h_\rho}{\rho} \text{Kh}m(\theta)\text{sh}, \quad (6)$$

where

$$\text{Kh}m^1(\theta) = \frac{\partial}{\partial \theta} \text{Kh}m(\theta), \quad (7)$$

$$\text{ch} = \cosh(\chi\rho - \omega t), \quad (8)$$

$$\text{sh} = \sinh(\chi\rho - \omega t). \quad (9)$$

In this case, table 8.2 takes the form of table 1. Substituting (1-9) in the formulas of the table 1, we obtain after reduction the equations shown in table. 2. In this table 2 we can cancel zero expressions of the form

$$-\frac{e_\varphi \text{ch } 1}{\rho} \frac{1}{\rho} + \frac{\partial}{\partial \rho} \left(\frac{1}{\rho} \right) e_\varphi \text{ch} = 0, \quad (31)$$

- see equation (25). We will write the result in table 3.

Table 1.

1	2	3
1	$\text{rot}_\rho(E)$	$\frac{E_\varphi}{\rho \text{tg}(\theta)} + \frac{\partial E_\varphi}{\rho \partial \theta} + \frac{\mu}{c} \frac{\partial H_\rho}{\partial t} = 0$
2	$\text{rot}_\theta(E)$	$-\frac{E_\varphi}{\rho} - \frac{\partial E_\varphi}{\partial \rho} + \frac{\mu}{c} \frac{\partial H_\theta}{\partial t} = 0$
3	$\text{rot}_\varphi(E)$	$\frac{E_\theta}{\rho} + \frac{\partial E_\theta}{\partial \rho} + \frac{\mu}{c} \frac{\partial H_\varphi}{\partial t} = 0$
4	$\text{div}(E)$	$\frac{E_\rho}{\rho} + \frac{\partial E_\rho}{\partial \rho} + \frac{E_\theta}{\rho \text{tg}(\theta)} + \frac{\partial E_\theta}{\rho \partial \theta} = 0$
5	$\text{rot}_\rho(H)$	$\frac{H_\varphi}{\rho \text{tg}(\theta)} + \frac{\partial H_\varphi}{\rho \partial \theta} - \frac{\varepsilon}{c} \frac{\partial E_\rho}{\partial t} = 0$
6	$\text{rot}_\theta(H)$	$-\frac{H_\varphi}{\rho} - \frac{\partial H_\varphi}{\partial \rho} - \frac{\varepsilon}{c} \frac{\partial E_\theta}{\partial t} = 0$
7	$\text{rot}_\varphi(H)$	$\frac{H_\theta}{\rho} + \frac{\partial H_\theta}{\partial \rho} - \frac{\varepsilon}{c} \frac{\partial E_\varphi}{\partial t} = 0$
8	$\text{div}(H)$	$\frac{H_\rho}{\rho} + \frac{\partial H_\rho}{\partial \rho} + \frac{H_\theta}{\rho \text{tg}(\theta)} + \frac{\partial H_\theta}{\rho \partial \theta} = 0$

Table 2.

1	2	3
23	$\text{rot}_\rho(E)$	$\text{Khm} \cdot e_\varphi \text{ch} \cdot \text{shs}(\theta) + \text{Khm}^1 e_\varphi \text{ch} \cdot \text{chn}(\theta) - \text{Khm} \cdot \omega \frac{\mu}{c} h_\rho \text{ch} = 0$
24	$\text{rot}_\rho(H)$	$\text{Khm} \cdot h_\varphi \text{sh} \cdot \text{shs}(\theta) + \text{Khm}^1 h_\varphi \text{sh} \cdot \text{chn}(\theta) - \text{Khm} \cdot \omega \frac{\varepsilon}{c} e_\rho \text{sh} = 0$
25	$\text{rot}_\theta(E)$	$-\frac{e_\varphi \text{ch}}{\rho^2} - \frac{e_\varphi}{\rho} \chi \text{sh} - \frac{\partial}{\partial \rho} \left(\frac{1}{\rho} \right) \cdot e_\varphi \text{ch} + \omega \frac{\mu h_\theta}{c \rho} \text{sh} = 0$
26	$\text{rot}_\theta(H)$	$-\frac{h_\varphi \text{sh}}{\rho^2} + \frac{h_\varphi}{\rho} \chi \text{ch} - \frac{\partial}{\partial \rho} \left(\frac{1}{\rho} \right) \cdot \frac{h_\varphi}{\rho} \text{sh} + \omega \frac{\varepsilon e_\theta}{c \rho} \text{ch} = 0$
27	$\text{rot}_\varphi(E)$	$\frac{e_\theta \text{sh}}{\rho^2} - \frac{e_\theta}{\rho} \chi \text{ch} + \frac{\partial}{\partial \rho} \left(\frac{1}{\rho} \right) e_\theta \text{sh} - \omega \frac{\mu h_\varphi}{c \rho} \text{ch} = 0$
28	$\text{rot}_\varphi(H)$	$\frac{h_\theta \text{ch}}{\rho^2} + \frac{h_\theta}{\rho} \chi \text{sh} + \frac{\partial}{\partial \rho} \left(\frac{1}{\rho} \right) \cdot \frac{h_\theta}{\rho} \text{ch} - \omega \frac{\varepsilon e_\varphi}{c \rho} \text{sh} = 0$
29	$\text{div}(E)$	$\text{Khm} \cdot \frac{e_\rho \text{ch}}{\rho^2} + \text{Khm} \cdot \frac{e_\rho}{\rho} \chi \text{sh} + \text{Khm} \cdot \frac{\partial}{\partial \rho} \left(\frac{1}{\rho} \right) e_\rho \text{ch} + \text{Khm} \cdot e_\theta \text{sh} \cdot \text{shs}(\theta) + \text{Khm}^1 e_\theta \text{sh} \cdot \text{chn}(\theta) = 0$
30	$\text{div}(H)$	$\text{Khm} \cdot \frac{h_\rho \text{sh}}{\rho^2} - \text{Khm} \cdot \frac{h_\rho}{\rho} \chi \text{ch} + \text{Khm} \cdot \frac{\partial}{\partial \rho} \left(\frac{1}{\rho} \right) h_\rho \text{sh} + \text{Khm} \cdot h_\theta \text{ch} \cdot \text{shs}(\theta) + \text{Khm}^1 h_\theta \text{ch} \cdot \text{chn}(\theta) = 0$

Table 3.

1	2	3
33	$\text{rot}_\rho(E)$	$\text{Khm} \cdot e_\varphi \text{ch} \cdot \text{shs}(\theta) + \text{Khm}^1 e_\varphi \text{ch} \cdot \text{chn}(\theta) - \text{Khm} \cdot \omega \frac{\mu}{c} h_\rho \text{ch} = 0$
34	$\text{rot}_\rho(H)$	$\text{Khm} \cdot h_\varphi \text{sh} \cdot \text{shs}(\theta) + \text{Khm}^1 h_\varphi \text{sh} \cdot \text{chn}(\theta) - \text{Khm} \cdot \omega \frac{\varepsilon}{c} e_\rho \text{sh} = 0$
35	$\text{rot}_\theta(E)$	$-\frac{e_\varphi}{\rho} \chi \text{sh} + \omega \frac{\mu h_\theta}{c \rho} \text{sh} = 0$
36	$\text{rot}_\theta(H)$	$\frac{h_\varphi}{\rho} \chi \text{ch} + \omega \frac{\varepsilon e_\theta}{c \rho} \text{ch} = 0$
37	$\text{rot}_\varphi(E)$	$-\frac{e_\theta}{\rho} \chi \text{ch} - \omega \frac{\mu h_\varphi}{c \rho} \text{ch} = 0$
38	$\text{rot}_\varphi(H)$	$\frac{h_\theta}{\rho} \chi \text{sh} - \omega \frac{\varepsilon e_\varphi}{c \rho} \text{sh} = 0$
39	$\text{div}(E)$	$\text{Khm} \cdot \frac{e_\rho}{\rho} \chi \text{sh} + \text{Khm} \cdot e_\theta \text{sh} \cdot \text{shs}(\theta) + \text{Khm}^1 e_\theta \text{sh} \cdot \text{chn}(\theta) = 0$
40	$\text{div}(H)$	$-\text{Khm} \cdot \frac{h_\rho}{\rho} \chi \text{ch} + \text{Khm} \cdot h_\theta \text{ch} \cdot \text{shs}(\theta) + \text{Khm}^1 h_\theta \text{ch} \cdot \text{chn}(\theta) = 0$

Equations (37, 38) are transformed into equations (35, 36) under the conditions

$$e_\varphi = e_\theta, h_\varphi = -h_\theta. \quad (41)$$

Equation (33, 44) is transformed into equations (39, 40) under the same conditions.

Consider equations (36, 37). Multiplying their right and left sides, we find:

$$e_\theta h_\varphi \chi^2 = \omega^2 \frac{\mu \varepsilon}{c} e_\theta h_\varphi \quad (49)$$

or

$$\chi = \frac{\omega}{c} \sqrt{\varepsilon \mu}. \quad (50)$$

The same result is obtained when considering equations (35, 38).

From (36, 50) it follows that

$$h_\varphi = \sqrt{\frac{\varepsilon}{\mu}} e_\theta, \quad (51)$$

and from (35, 50) it follows that

$$h_\theta = \sqrt{\frac{\varepsilon}{\mu}} e_\varphi, \quad (52)$$

From (41, 51, 52) it follows that

$$e_\theta = e_\varphi = \sqrt{\frac{\mu}{\varepsilon}} h_\theta = -\sqrt{\frac{\mu}{\varepsilon}} h_\varphi, \quad (53)$$

or

$$h_\varphi = -h_\theta = \sqrt{\frac{\varepsilon}{\mu}} e_\theta = \sqrt{\frac{\varepsilon}{\mu}} e_\varphi. \quad (54)$$

It can be noted that equations (33, 34, 39, 40) coincide under conditions (41) and

$$-\omega \frac{\mu}{c} h_\rho = e_\rho \chi \quad (55)$$

$$-\omega \frac{\varepsilon}{c} e_\rho = -h_\rho \chi. \quad (56)$$

Let's consider these equations. Multiplying their right and left sides, we find the previously obtained expression (50). Therefore, equations (42, 43, 38, 39) coincide under condition (50). From (56, 50) we find:

$$h_\rho = \frac{\omega \varepsilon}{\chi c} e_\rho = \sqrt{\frac{\varepsilon}{\mu}} e_\rho. \quad (57)$$

We rewrite (39) as

$$\text{Khm} \cdot (e_\theta \text{shs}(\theta) + e_\rho \chi) + \text{Khm}^1 \cdot e_\theta \text{chn}(\theta) = 0$$

or, taking into account (41),

$$\text{Khm} \cdot \left(\text{shs}(\theta) + \frac{e_\rho}{e_\varphi} \chi \right) + \text{Khm}^1 \cdot \text{chn}(\theta) = 0$$

Thus, (42, 43, 38, 39) can be represented as

$$(\text{shs}(\theta) + \beta) \cdot y + \text{chn}(x) \frac{\partial y}{\partial x} = 0, \quad (57)$$

where

$$y = \text{Khm}(\theta), \quad (58)$$

$$\beta = \frac{e_\rho}{e_\varphi} \chi. \quad (59)$$

In the general case, differential equation (57) has no analytical solution. In particular,

$$\text{Khm}(\theta, \beta) \rightarrow \left\{ \begin{array}{l} 1, \text{ if } \beta \rightarrow \frac{\pi}{2} \\ -1, \text{ if } \beta \rightarrow -\frac{\pi}{2} \\ \text{chn}(\theta), \text{ if } \beta \rightarrow \infty \end{array} \right\}, \quad (60)$$

In fig. 2 shows the functions $\text{Khm}(\theta, \beta)$ for different values of β . For comparison, the $\sin(\theta)$ function is shown as dots.

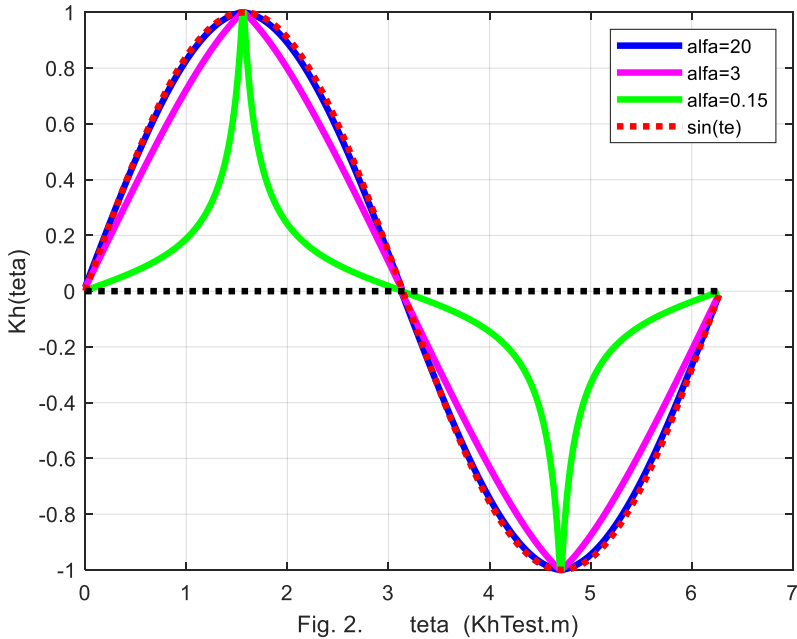

Fig. 2. teta (KhTest.m)

The obtained results can be formulated as follows:

Theorem SC. A spherical field as a solution to Maxwell's equations in spherical coordinates has a solution of the form (1-9), where the function $\text{Khm}(\theta, \beta)$ is determined by the differential equation (57, 59), the constants χ, ω are related by relation (50), the constants $e_\theta, e_\varphi, h_\theta, h_\varphi$ are related by relation (54), the constants e_ρ, h_ρ are related by relation (57).

3. Stability of the solution

Theorem SC holds at any time moment t . However, the quantities $e_\theta, e_\varphi, h_\theta, h_\varphi, e_\rho, h_\rho$, generally speaking, change in time. At the initial moment at $t = 0$, when a voltage appears on the capacitor plates, time derivatives of the strengths appear and the values of the quantities $e_\theta, e_\varphi, h_\theta, h_\varphi, e_\rho, h_\rho$ begin to change. As t increases, the argument of functions (8, 9) tends to zero and their values tend to 1 and 0, respectively. When the argument sign changes, function (8) changes the sign of the derivative. Consequently, the state of function (8) is stable.

Thus, some time after turning on the voltage on the plates of the capacitor, the tensions (1-8) take the following values:

$$E_\varphi = \frac{e_\varphi}{\rho} \text{Khm}(\theta), \quad (1)$$

$$E_\theta = 0, \quad (2)$$

$$E_\rho = \frac{e_\rho}{\rho} \text{Khm}(\theta), \quad (3)$$

$$H_\varphi = 0, \quad (4)$$

$$H_\theta = \frac{h_\theta}{\rho} \text{Khm}(\theta), \quad (5)$$

$$H_\rho = 0. \quad (6)$$

The value of ω can be considered as the frequency of oscillations of intensities around a stable state. Thus, the solution of Maxwell's equations for a charged capacitor and for a capacitor in a sinusoidal current circuit is fundamentally different only in that in the first case there are hyperbolic functions of time, and in the second, sinusoidal ones.

4. Conclusion

Similarly to a spherical capacitor in an alternating current circuit, in this case, it can be shown that

1) a spherical capacitor has magnetic properties similar to its electrical properties; we can say that a spherical capacitor is a device in which both an electric and a magnetic field are present, i.e. a device equivalent to a magnet and, at the same time, an electret, the axes of which are perpendicular;

2) a flow of electromagnetic energy circulates along the sphere parallel to the equator; the internal energy of the capacitor circulates in this stream.

Chapter 8K. A New Approach to Antenna Design

Contents

1. On the shortcomings of existing methods \ 1
 2. A new approach \ 2
- Appendix 1 \ 3

1. On the shortcomings of existing methods

The solution of the Maxwell equations for a spherical wave is necessary for the design of antennas. Such a problem arises in the solution of the equations of electrodynamics for an elementary electric dipole representing a vibrator. The solution of this problem is known and it is on the basis of this solution that the antennas are constructed. At the same time, this solution has a number of shortcomings, in particular [107-110].

1. The energy conservation law is satisfied only on the average,
2. The solution is inhomogeneous and it is practically necessary to divide it into separate zones (as a rule, the near, middle, and far zones) in which the solutions turn out to be completely different,
3. In the near zone there is no flow of energy with the real value,
4. The magnetic and electrical components are in phase,
5. In the near zone, the solution is not wave (i.e. the distance is not an argument of the trigonometric function),
6. The known solution does not satisfy Maxwell's set of equations (a solution that satisfies a single equation of the set cannot be considered as a solution of the set of equations).

Figure 1 [110] shows the distribution of the force lines of the electric field, constructed on the basis of the known solution. Obviously, such distribution cannot exist in a spherical wave.

Far from the vibrator, namely in the far zone, where the longitudinal electric and magnetic fields' strengths (directed along the radius) can be neglected, the solution of the problem is simplified. But

even there the well-known solution has a number of shortcomings [107-110]. The main disadvantages of this solution (see Appendix 1) are that

1. the law of conservation of energy is fulfilled only on the average (in time),
2. the magnetic and electrical components are in phase,
3. in the Maxwell equations' set, in the known solution, only one equation of eight is satisfied.

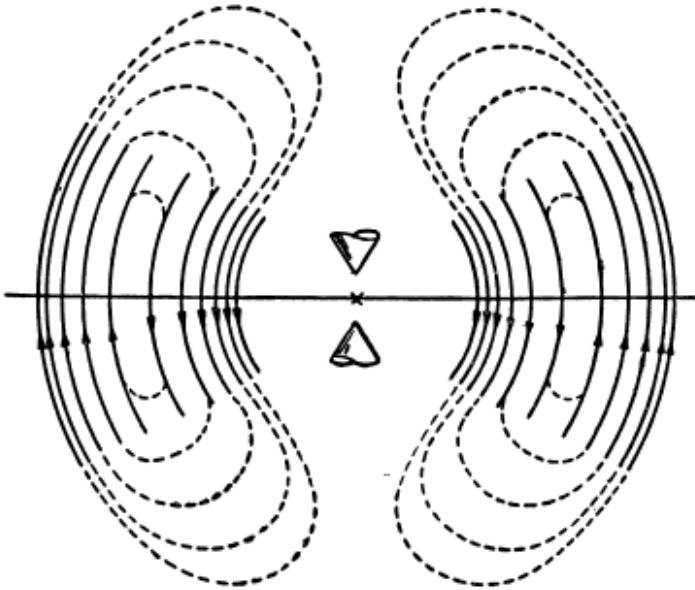

Fig. 1.

2. A new approach

These shortcomings are a consequence of the fact that until now Maxwell's equations for the spherical coordinates could not be resolved. The well-known solution can be obtained (1) after dividing the entire domain into the aforementioned near, middle, and far zones, and (2) after applying a variety of assumptions different for each of these zones.

In practice, specified drawbacks of the known solution mean that they (mathematical solutions) do not strictly describe the real characteristics of technical devices. A more rigorous solution obtained in Chapter 8, when applied in the design systems of such technical devices, must certainly improve the quality of the devices.

Appendix 1.

The known solution has the following form [107, 108]:

$$E_{\theta} = e_{\theta} \frac{1}{\rho} \sin(\theta) \sin(\omega t - \chi \rho), \quad (1)$$

$$H_{\varphi} = h_{\varphi} \frac{1}{\rho} \sin(\theta) \sin(\omega t - \chi \rho), \quad (2)$$

$k_{e\theta} = \frac{\chi^2 l I}{4\pi \omega \varepsilon \varepsilon_0}$, $k_{h\varphi} = \frac{\chi l I}{4\pi}$, where l , I are the length and the current of the vibrator. We notice that

$$\frac{e_{\theta}}{h_{\varphi}} = \frac{\chi}{\omega \varepsilon} \quad (3)$$

It should be noted that these strengths are in phase, which contradicts practical electrical engineering.

Table 2.

1	2
1.	$\text{rot}_{\rho} H - \frac{\varepsilon}{c} \frac{\partial E_{\rho}}{\partial t} = 0$
2.	$\text{rot}_{\theta} H - \frac{\varepsilon}{c} \frac{\partial E_{\theta}}{\partial t} = 0$
3.	$\text{rot}_{\varphi} H - \frac{\varepsilon}{c} \frac{\partial E_{\varphi}}{\partial t} = 0$
4.	$\text{rot}_{\rho} E + \frac{\mu}{c} \frac{\partial H_{\rho}}{\partial t} = 0$
5.	$\text{rot}_{\theta} E + \frac{\mu}{c} \frac{\partial H_{\theta}}{\partial t} = 0$
6.	$\text{rot}_{\varphi} E + \frac{\mu}{c} \frac{\partial H_{\varphi}}{\partial t} = 0$
7.	$\text{div}(E) = 0$
8.	$\text{div}(H) = 0$

Let us consider how equations (1) and (2) relate to Maxwell's set of equations, see in Table 2 rewritten from Chapter 8: the first solution. The

strengths (1) and (2) enter only in equation (6) from Table 2, which has the following form:

$$\operatorname{rot}_{\varphi} \mathbf{E} + \frac{\mu}{c} \frac{\partial \mathbf{H}_{\varphi}}{\partial t} = 0 \quad (4)$$

or

$$\frac{E_{\theta}}{\rho} + \frac{\partial E_{\theta}}{\partial \rho} + \frac{\mu}{c} \frac{\partial H_{\varphi}}{\partial t} = 0. \quad (5)$$

We substitute (1) and (2) into (5) and obtain:

$$\begin{aligned} & -e_{\theta} \frac{\chi}{\rho} \sin(\theta) \cos(\omega t - \chi \rho) - \\ & -h_{\varphi} \frac{\chi \mu}{\rho c} \sin(\theta) \cos(\omega t - \chi \rho) = 0 \end{aligned} \quad (6)$$

or

$$\frac{e_{\theta}}{h_{\varphi}} + \frac{\mu}{c} = 0. \quad (7)$$

From the comparison of (3) and (7) it follows that strengths (1) and (2) satisfy equation (4). The remaining seven equations of Maxwell's equations are violated. In equations (2), (3), and (5) listed in Table 2, one of the terms differs from zero, and the other is equal to zero. The violation of equations (1), (4), (7), and (8) listed in Table 2 is shown in Chapter 8: the first solution, formula (2.20). So,

the known solution does not satisfy Maxwell's set of equations.

Chapter 9. The Nature of Earth's Magnetism

It is known that the Earth electrical field can be considered as a field "between spherical capacitor electrodes" [51]. These electrodes are the Earth surface having a negative charge and the ionosphere having a positive charge. The charge of these electrodes is maintained by continuous atmospheric thunderstorm activities.

It is also known that there is the Earth magnetic field. However, in this case no generally accepted explanation of the source of this field is available. "The problem of the origin and retaining of the field has not been solved as yet." [52].

Next, we will consider the hypothesis that the **Earth's magnetic field is a consequence of the existence of the Earth's electric field.**

In Chapter 8K, a spherical capacitor is considered in a DC circuit and it is shown that after a capacitor charge, when the current practically ceases, the stationary electromagnetic wave and the stationary flux of electromagnetic energy in the capacitor is conserved. A magnetic field is present in the capacitor.

In Chapter 8H it was shown that in a spherical condenser are the magnetic equatorial plane, magnetic axis, magnetic poles and magnetic meridians, along which vectors $\mathbf{H}_{\varphi\theta}$ are directed – see Fig. 2 in chapter 8H. The angle between the magnetic axis and the axis of the mathematical model can not be determined from the mathematical model. Moreover, not determined angle between the magnetic axis and the Earth's physical axis of rotation.

There are the radial intensities only in locations where the spherical intensity is zero.

It flows from the above mentioned that **the Earth electrical field is responsible for the Earth magnetic field.**

Let us consider this problem in more details.

The vector field $\mathbf{H}_{\varphi\theta}$ in a diametral plane passing through the magnetic axis is shown in Fig. 8. Here, $|\mathbf{H}_{\varphi\theta}| = 0.7$; $\rho = 1$. The vector field \mathbf{H}_{ρ} in a diametral plane passing through the magnetic axis is shown

in Fig. 9. Here, $|\mathbf{H}_\rho| = 0.4$; $\rho = 1$. The vector field $\mathbf{H} = \mathbf{H}_{\varphi\theta} + \mathbf{H}_\rho$ in a diametral plane passing through the magnetic axis is shown in Fig. 10. Here, $|\mathbf{H}_{\varphi\theta}| = 0.3$; $|\mathbf{H}_\rho| = 0.2$; $\rho = 1$.

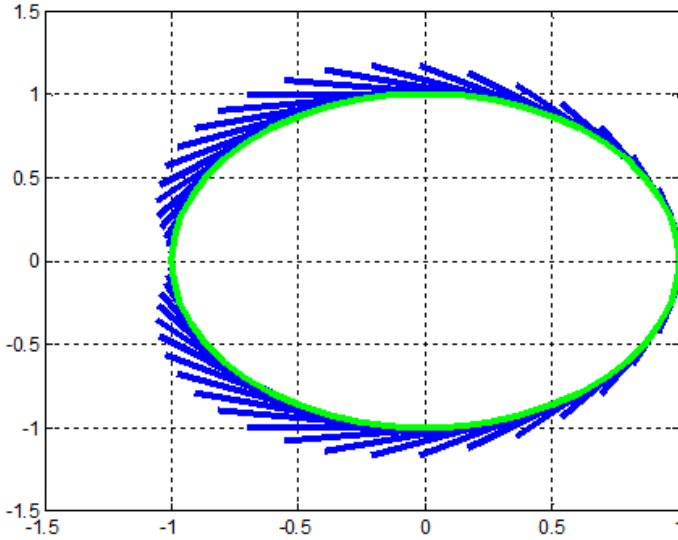

FIG. 8. (Sfera.88)

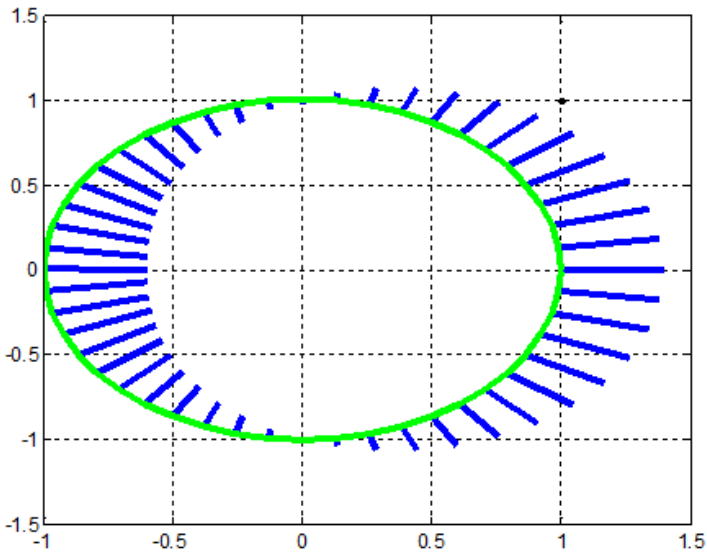

FIG. 9. (Sfera.88)

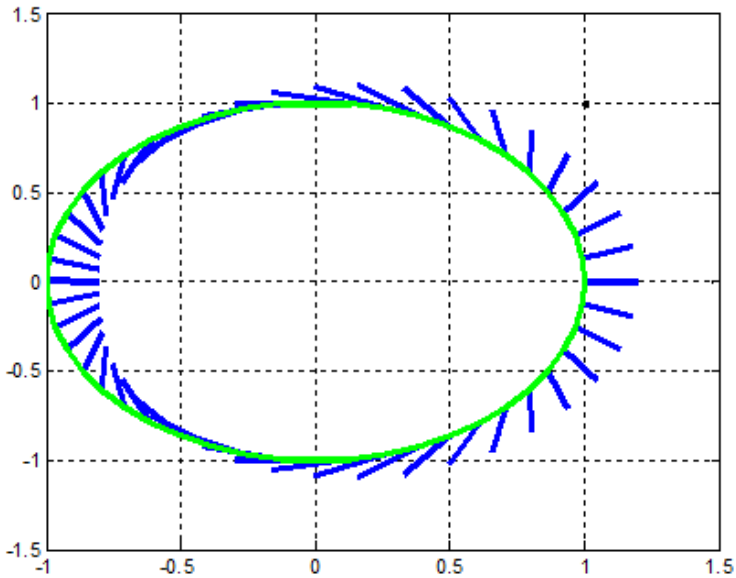

FIG. 10. (Sera.88)

Similarly, can be described the electric field of the Earth. Importantly, the electric field and the magnetic field are perpendicularly.

Once again, the very existence of the electric field is not in doubt, and the charge of “Earth's spherical capacitor” is supported by the thunderstorm activity [51, 52].

Also consider the comparative quantitative estimates of magnetic and electric intensity of the Earth's field.

In a vacuum, where $\varepsilon = \mu = 1$, there is a relation between the magnetic and electric intensity in any direction in the GHS system [51]

$$E = H . \tag{9}$$

This relation is true if these intensities are measured in the GHS system at a given point in the same direction. To go to the SI system, one shall take into account that

$$\text{for H: } 1 \text{ GHS unit} = 80 \text{ A/m}$$

$$\text{for E: } 1 \text{ GHS unit} = 30,000 \text{ B/m}$$

Hence, the equation (9) takes the following form in the SI system:

$$3000 E = 80 H \tag{10}$$

or

$$E \approx 0.03 H . \tag{11}$$

or

$$H \approx 30 E \cdot \text{tg}(\beta) . \tag{12}$$

An additional argument in favor of the existence of the electric field of the structure specified is the existence of the telluric currents [53]. There is no generally accepted explanation of their causes. On the basis of the foregoing, it shall be assumed that these currents must have the largest value in the direction of the parallels.

It is possible that the electric field of the Earth can be detected using a freely suspended electric dipole, made in the form of a long isolated rod with metal balls at the ends. It is also possible that oscillations of the rod will be recorded at the low frequency of changing in dipole charges.

Based on the hypothesis suggested, it can be assumed that the magnetic field shall be observed among planets with an atmosphere. Indeed, the Moon and Mars, free of the atmosphere, lack the magnetic field. However, there is no magnetic field at Venus. This may be due to the high density and conductivity of the atmosphere – it cannot be considered as an insulating layer of the spherical capacitor.

Chapter 10. Solution of Maxwell's Equations for Ball Lightning

Contents

1. Introduction \ 1
2. The solution of Maxwell equations in spherical coordinates \ 2
3. Energy \ 3
4. About Ball Lightning Stability \ 3
5. About Luminescence of the Ball Lightning \ 3
6. About the Time of Existence of Ball Lightning \ 4
7. About a Possible Mechanism of Ball Lightning Formation \ 5

1. Introduction

The hypotheses made about the nature of ball lightning are unacceptable because they are contrary to the law of energy conservation. This occurs because the luminescence of ball lightning is usually attributed to the energy released in any molecular or chemical transformation. So, it is suggested that a source of energy, due to which the ball lightning glows, is located in the lightning.

Kapitsa P.L. 1955 [41]

This assertion (as far as the author knows) is true also today. It is reinforced by the fact that the currently estimated typical ball lightning contains tens of kilojoules [42] that are released during its explosion.

It is generally accepted that ball lightning is somehow connected with the electromagnetic phenomena. However, there is no rigorous description of these processes.

In previous editions of this book, a mathematical model of ball lightning was proposed, which made it possible to explain many of the properties of ball lightning. This model turned out to be difficult to describe mathematically. Next, we describe a less complex model.

When constructing the mathematical model, it will be assumed that the globe lighting is plasma, i.e. a gas consisting of charged particles (electrons and positive charged ions) i.e. the globe lightning plasma is fully ionized. In addition, it is assumed that the number of positive

charges equal to the number of negative charges and hence, the total charge of the globe lightning is equal to zero. For the plasma, we usually consider charge and current densities averaged over an elementary volume. Electric and magnetic fields created by the average “charge” density and the “average” current density in the plasma obey the Maxwell equations [62]. The effect of particles’ collision in the plasma is usually described by the function of particle distribution in the plasma. These effects will be taken into account for the Maxwell equations assuming that the plasma possesses some electric resistance or conductivity.

So, based on both the Maxwell's equations and the understanding of the electrical conductivity of the body of ball lightning, a mathematical model of ball lightning can be built. Also, the structure of both the electromagnetic field and the electric currents in it are shown. Next, it is shown as a consequence of this model that in a ball lightning, the flow of electromagnetic energy can circulate. As a result, the energy obtained by the ball lightning at its creation can be saved. Sustainability, luminescence, charge, time being, the mechanism of formation of ball lightning are also briefly discussed below.

2. Solution of the Maxwell Equations in the Spherical Coordinate System

Chapter 8C gives a solution to Maxwell's equations for a spherical electromagnetic wave. Along with solution C, there can exist a solution D, which differs only in that the strength functions in it have functions \overline{co} instead of \overline{si} in their definition and vice versa. We will denote all parameters of this solution by the upper sign $\overline{\quad}$. So, in this version $\alpha=0$, $\overline{E}_\rho = \text{any}$, $\overline{H}_\rho = \text{any}$, and

$$\overline{E}_\varphi = \frac{\overline{e}_\varphi}{\rho} \text{Kh}m(\theta)\overline{co}, \tag{1}$$

$$\overline{E}_\theta = \frac{\overline{e}_\theta}{\rho} \text{Kh}m(\theta)\overline{si}, \tag{2}$$

$$\overline{E}_\rho = \frac{\overline{e}_\rho}{\rho} \text{Kh}m(\theta)\overline{co}, \tag{3}$$

$$\overline{H}_\varphi = \frac{\overline{h}_\varphi}{\rho} \text{Kh}m(\theta)\overline{si}, \tag{4}$$

$$\overline{H}_\theta = \frac{\overline{h}_\theta}{\rho} \text{Kh}m(\theta)\overline{co}, \tag{5}$$

$$\overline{H}_\rho = \frac{\overline{h}_\rho}{\rho} \text{Kh}m(\theta)\overline{si}, \tag{6}$$

where $\text{Kh}m(\theta)$ is a known function and

$$\text{Khm}^1(\theta) = \frac{\partial}{\partial \theta} \text{Khm}(\theta), \quad (7)$$

$$\text{co} = \cos(\chi\rho + \omega t), \quad (8)$$

$$\text{si} = \sin(\chi\rho + \omega t). \quad (9)$$

We will assume that the sphere is electrically conductive and the strengths E correspond to the conduction currents

$$\vec{J} = \sigma \cdot \vec{E}, \quad (10)$$

where σ is the electrical conductivity. Two solutions C and D existing simultaneously will be called the solution CD. Thus, we have obtained a complex solution of the Maxwell equations for the sphere.

So we got the solution is obtained for Maxwell's equations for a sphere whose material has dielectric permittivity and magnetic permeability. Also, this material has conductivity. This solution has been obtained under the following assumptions: the sphere is conductive and neutral (does not have any uncompensated charges). Its existence means only that in a conductive and neutral sphere, an electromagnetic wave can exist and electrical currents can circulate.

3. Energy

From the resulting solution follows that the lightning contains the following energy components:

- Active loss of energy W_a , see the second term in the expression for the electric field strength:
- Reactive electric energy W_e , see the first term in the expression for the electric field strength:
- Reactive magnetic energy W_h , see the expression for the magnetic field strength.

4. About Ball Lightning Stability

The question of stability for bodies, in which a flow of electromagnetic energy is circulating, has been treated in [43]. Here we shall consider only such force that acts along the diameter and breaks the ball lightning along diameter plane perpendicular to this diameter. At the first moment, it must perform a work expressed by:

$$A = F \frac{dR}{dt}. \quad (1)$$

This work changes the internal energy of the ball lightning, i.e.

$$A = \frac{dW}{dt} . \tag{2}$$

Considering (1) and (2) together, we find that

$$F = \frac{dW}{dt} \bigg/ \frac{dR}{dt} . \tag{3}$$

If the energy of the ball lightning is proportional to the volume, i.e.

$$W = aR^3 . \tag{4}$$

where a is the coefficient of proportionality, then

$$\frac{dW}{dt} = 3aR^2 \frac{dR}{dt} . \tag{5}$$

Therefore,

$$F = \frac{dW}{dt} \bigg/ \frac{dR}{dt} = 3aR^2 = \frac{3W}{R} . \tag{6}$$

Thus, the internal energy of the ball lightning is equivalent to the force creating the stability of the lightning.

5. About Luminescence of the Ball Lightning

The problem was solved above considering the electric resistance of the globe lightning. Naturally, it does not equal to zero and when electric currents flow through this resistance, some thermal energy is released.

6. About the Time of Existence of Ball Lightning

The energy W of the ball lightning and the power P of the heat losses can be found with the solution obtained above.

The existence time of the globe lightning is equal to the time of transformation of the electrical energy of the globe lightning into the heat losses, i.e.

$$\tau = W/P \tag{1}$$

7. About a Possible Mechanism of Ball Lightning Formation

The leader of a linear lightning, meeting a certain obstacle, may alter the motion trajectory from linear to circular. This may become the cause of the emergence of the described above electromagnetic fields and electrical currents.

In [44], this process was described as follows:

Another strong bolt of lightning, simultaneous with a bang, illuminated the entire space. I can see how a long and dazzling beam in the color of sun beam approaches to me right in the solar plexus. The end of it is sharp as a razor but further it becomes thicker and thicker, and reaches something like 0,5 meter. Further I can't see, as I am staring at a downward angle.

Instant thought that it is the end. I see how the tip of the beam approaches. Suddenly it stopped and between the tip and the body began to swell a ball the size of a large grapefruit. There was a thump as if a cork popped from a bottle of champagne. The beam flew into a ball. I see the blindingly bright ball, color of the sun, which rotates at a breakneck pace, grinding the beam inside. But I do not feel any touch, any heat.

The ball grinds the ray and increases in size. ... The ball does not issue any sounds. At first it was bright and opaque but then begins to fade, and I see that it is empty. Its shell has changed and it became like a soap bubble. The shell rotates, its diameter remained stable but the surface was with metallic sheen.

Chapter 11. Mathematical Model of a Plasma Crystal

Contents

1. Problem statement \ 1
2. Set of equations \ 4
3. The first mathematical model \ 5
4. The second mathematical model \ 7
5. The plasma crystal energy \ 9

1. Problem statement

Dusty plasma (see in [87]) is a set of charged particles. These “particles can arrange in space in a certain way and form the so-called plasma crystal” [88]. It is difficult to predict the mechanism of formation, behavior, and form of such crystals. Observation of these processes and forms under low gravity conditions sets at the gaze (see in Figure 1) of the experiments in space [89].

Therefore, they were simulated on a computer in 2007. The results surprised even greater that was reflected in the following title of paper [90]: “From plasma crystals and helical structures towards inorganic living matter”. Work [91] gives a summary and discussion of the simulation results.

The author of this book likes such comparisons, too. Nevertheless, it should be noted that the method used by the authors of the molecular dynamics simulations does not fully take into account all the features of the dusty plasma. To describe the motion of the particles, this method uses classical mechanics and considers only electrostatic forces among the charged particles. In fact, the charged particles’ motion causes occurrence of charge currents representing electrical currents and electromagnetic fields as a consequence. They should be considered during simulation.

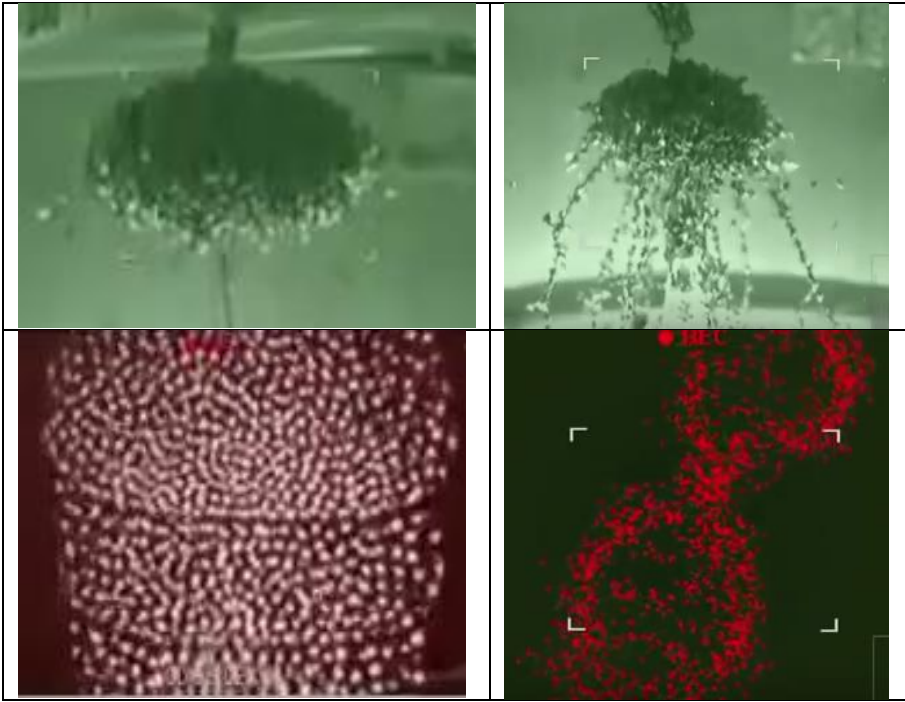

Fig. 1.

In the absence of gravity, the plasma particles are not affected by gravitational forces. If we exclude radiation energy, then it can be said that the dusty plasma represents electric charges, electric currents, and electromagnetic fields. Moreover, at its formation (filling a vessel with a set of charged particles) the plasma receives some energy. This energy may be only electromagnetic and kinetic energies of the particles because there is no mechanical interaction among the particles: they are charged with like charges. Thus, the dusty plasma should meet the following conditions:

- to meet the set of Maxwell's equations,
- to maintain the total energy as a sum of the electromagnetic and kinetic energies of the particles,
- to become stable in terms of the particles' structure and motion in some time; it follows, for instance, from the aforesaid experiments in space shown in Figure 1.

The charged particles obviously push off from each other by Coulomb forces. However, the experiments show that these forces do not act on the periphery of the particles' cloud. Consequently, they are compensated by some other forces. It will be shown below that these

forces are the Lorentz forces arising during charged particles motion (although it seems strange at first sight that these forces are directed inside the cloud, opposing the Coulomb forces). The particles cannot be fixed, since then the Coulomb forces will prevail. But then these forces will move the particles, and this movement will cause the Lorentz forces, etc.

In the mathematical model shown below we will not take into account the Coulomb forces, believing that their role is only to ensure that the particles are isolated from each other (just as these forces are not considered in electrical engineering problems).

Thus, we will consider the dusty plasma as an area with flowing electrical currents and analyze it using the set of Maxwell's equations. Since the particles are in a vacuum and are always isolated from each other, there is no ohmic resistance and no electrical strength proportional to the current. Therefore, the strength should not be taken into account in the Maxwell equations. In addition, in the first stage, we will assume that the currents change slowly, namely they are constant currents. Considering these remarks, the Maxwell equations are written as follows:

$$\operatorname{rot}(H) - J = 0, \quad (1)$$

$$\operatorname{div}(J) = 0, \quad (2)$$

$$\operatorname{div}(H) = 0, \quad (3)$$

where J and H are the current and the magnetic strength, respectively. In addition, we need to add to these equations an equation uniting the plasma energy W with these J and H :

$$W = f(J, H). \quad (4)$$

In this equation, the energy W is known because the plasma receives this energy at its formation.

In the scalar form, the set of equations (1)-(4) represents the set of six equations with six unknowns and should have only one solution. However, there is no regular algorithm for resolving such a set. Therefore, below we propose another approach:

1. Search for analytical solutions of underdetermined set of equations (1)-(3) for a given form of the plasma cloud. There can be multiple solutions.
2. Calculation of the energy W using formula (4). If the solution of set (1)-(4) is the only one, then this solution resolves set (1)-(4) for some known values of the energy W and the cloud form.

2. Set of equations

In the cylindrical coordinates r , φ , z , as is well-known [4], the divergence and curl of the vector H are written as follows:

$$\operatorname{div}(H) = \left(\frac{H_r}{r} + \frac{\partial H_r}{\partial r} + \frac{1}{r} \cdot \frac{\partial H_\varphi}{\partial \varphi} + \frac{\partial H_z}{\partial z} \right), \quad (a)$$

$$\operatorname{rot}_r(H) = \left(\frac{1}{r} \cdot \frac{\partial H_z}{\partial \varphi} - \frac{\partial H_\varphi}{\partial z} \right), \quad (b)$$

$$\operatorname{rot}_\varphi(H) = \left(\frac{\partial H_r}{\partial z} - \frac{\partial H_z}{\partial r} \right), \quad (c)$$

$$\operatorname{rot}_z(H) = \left(\frac{H_\varphi}{r} + \frac{\partial H_\varphi}{\partial r} - \frac{1}{r} \cdot \frac{\partial H_r}{\partial \varphi} \right). \quad (d)$$

Considering equations (a)-(d), we rewrite equations (1.1)-(1.3) as follows:

$$\frac{H_r}{r} + \frac{\partial H_r}{\partial r} + \frac{1}{r} \cdot \frac{\partial H_\varphi}{\partial \varphi} + \frac{\partial H_z}{\partial z} = 0, \quad (1)$$

$$\frac{1}{r} \cdot \frac{\partial H_z}{\partial \varphi} - \frac{\partial H_\varphi}{\partial z} = J_r, \quad (2)$$

$$\frac{\partial H_r}{\partial z} - \frac{\partial H_z}{\partial r} = J_\varphi, \quad (3)$$

$$\frac{H_\varphi}{r} + \frac{\partial H_\varphi}{\partial r} - \frac{1}{r} \cdot \frac{\partial H_r}{\partial \varphi} = J_z, \quad (4)$$

$$\frac{J_r}{r} + \frac{\partial J_r}{\partial r} + \frac{1}{r} \cdot \frac{\partial J_\varphi}{\partial \varphi} + \frac{\partial J_z}{\partial z} = 0 \quad (5)$$

The set of five equations (1)-(5) with the six unknowns $(H_r, H_\varphi, H_z, J_r, J_\varphi, J_z)$ is overdetermined and may have multiple solutions. It is shown below that such solutions exist and for different cases some of possible solutions can be identified.

We will first look for a solution for this set of equations (1)-(5) as separable functions relative to the coordinates. These functions are as follows:

$$H_{r.} = h_r(r) \cdot \cos(\chi z), \quad (6)$$

$$H_{\varphi.} = h_\varphi(r) \cdot \sin(\chi z), \quad (7)$$

$$H_{z.} = h_z(r) \cdot \sin(\chi z), \quad (8)$$

$$J_r = j_r(r) \cdot \cos(\chi z), \quad (9)$$

$$J_\varphi = j_\varphi(r) \cdot \sin(\chi z), \quad (10)$$

$$J_z = j_z(r) \cdot \sin(\chi z), \quad (11)$$

where χ is the constant but $h_r(r)$, $h_\varphi(r)$, $h_z(r)$, $j_r(r)$, $j_\varphi(r)$, $j_z(r)$ are the functions of the coordinate r . The derivatives of these functions will be denoted by strokes.

By putting (6)-(11) into (1)-(5) we get:

$$\frac{h_r}{r} + h'_r + \chi h_z = 0, \quad (12)$$

$$-\chi h_\varphi = j_r, \quad (13)$$

$$-\chi h_r - h'_z = j_\varphi \quad (14)$$

$$\frac{h_\varphi}{r} + h'_\varphi = j_z, \quad (15)$$

$$\frac{j_r}{r} + j'_r + \chi j_z = 0. \quad (16)$$

Let's put both (13) and (15) into (16). Then we get:

$$\frac{-\chi h_\varphi}{r} - \chi h'_\varphi + \chi \left(\frac{h_\varphi}{r} + h'_\varphi \right) = 0. \quad (17)$$

Expression (17) represents an identity $0=0$. Therefore, formula (16) follows from (13) and (15) and can be excluded from the set of equations (12)-(16). The rest of the equations can be rewritten as follows:

$$h_z = -\frac{1}{\chi} \left(\frac{h_r}{r} + h'_r \right), \quad (18)$$

$$j_z = \frac{h_\varphi}{r} + h'_\varphi, \quad (19)$$

$$j_r = -\chi h_\varphi, \quad (20)$$

$$j_\varphi = -\chi h_r - h'_z \quad (21)$$

3. The first mathematical model

In this set of four differential equations (18)-(21) with six unknown functions we can define two functions arbitrarily. For further study, we define the following two functions:

$$h_\varphi = q \cdot r \cdot \sin(\pi \cdot r / \chi), \quad (22)$$

$$h_r = h \cdot r \cdot \sin(\pi \cdot r / \chi), \quad (23)$$

where q , h are some constants. Then using (18)-(23), we find:

$$h_z = -\frac{h}{\chi} \left(2 \sin(\pi \cdot r / \chi) + \frac{\pi \cdot r}{\chi} \cos(\pi \cdot r / \chi) \right), \quad (24)$$

$$j_z = q \left(2 \sin(\pi \cdot r / \chi) + \frac{\pi \cdot r}{\chi} \cdot \cos(\pi \cdot r / \chi) \right), \quad (25)$$

$$j_r = -\chi \cdot q \cdot r \cdot \sin(\pi \cdot r / \chi) \quad (26)$$

$$j_\phi = h \cdot \left(\frac{\pi^2}{\chi R^2} - \chi \right) \cdot r \cdot \sin(\pi \cdot r / \chi) + \frac{h}{\chi} \left(2 - \frac{\pi}{\chi} \right) \cdot \cos(\pi \cdot r / \chi). \quad (27)$$

Thus, the functions $j_r(r)$, $j_\phi(r)$, $j_z(r)$, $h_r(r)$, $h_\phi(r)$, $h_z(r)$ can be defined using formulae (26), (27), (25), (23), (22), (24), respectively.

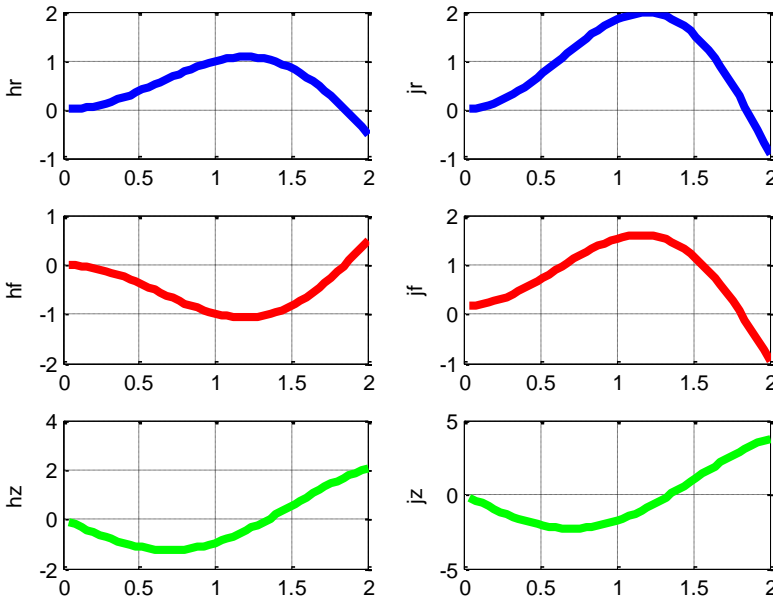

Fig. 2. (figPlazma.m)

Example 1.

Figure 2 shows the graphs for the following functions $j_r(r)$, $j_\phi(r)$, $j_z(r)$, $h_r(r)$, $h_\phi(r)$, $h_z(r)$. These functions can be calculated with the following parameters' values: $\chi = 2$, $h = 1$, $q = -1$. The first column shows the functions $h_r(r)$, $h_\phi(r)$, $h_z(r)$, the second column shows the functions $j_r(r)$, $j_\phi(r)$, $j_z(r)$.

It is important to note that there is a point in the function graphs $j_r(r)$, $j_\phi(r)$ where $j_r(r) = 0$ and $j_\phi(r) = 0$. Physically, this means that

there are the radial currents $J_r(r)$ in the area $r < \chi$ directed from the center (with $\chi q < 0$). There are no currents $J_r(r)$, $J_\phi(r)$ at the point $r = \chi$. Therefore, the value of $R = \chi$ is the radius of the crystal. The specks of dust outside this radius experience radial currents $J_r(r)$ directed towards the center. This creates a stable boundary of the crystal.

The built model describes the cylindrical crystal of infinite length, which, of course, is inconsistent with reality. Let's now consider a more complex model.

4. The second mathematical model

The root of the equation $j_r(r) = 0$ determines the value of the cylindrical crystal radius, $R = \chi$. Let's now change the value of χ . If the value of χ depends on the z , then the radius R will depend on the z . But this very dependence is observed in the experiments, see, for example, the first fragment in Figure 1.

With this in mind, let's consider the mathematical model, which differs from the above used by the fact that the function $\chi(z)$ is used instead of the constant χ . Let's rewrite equations (6)-(11) with this in mind:

$$H_{r.} = h_r(r) \cdot \cos(\chi(z)), \quad (28)$$

$$H_{\phi.} = h_\phi(r) \cdot \sin(\chi(z)), \quad (29)$$

$$H_{z.} = h_z(r) \cdot \sin(\chi(z)), \quad (30)$$

$$J_{r.} = j_r(r) \cdot \cos(\chi(z)), \quad (31)$$

$$J_{\phi.} = j_\phi(r) \cdot \sin(\chi(z)), \quad (32)$$

$$J_z = j_z(r) \cdot \sin(\chi(z)). \quad (33)$$

The set of equations (1)-(6) differs from set (2.9)-(2.14) only by the fact that instead of the constant χ we use the derivative $\chi'(z)$ along the z of the function $\chi(z)$. Consequently, the solution of set (28)-(33) will be different from that of the previous set only by using the derivative $\chi'(z)$ instead of the constant χ . Thus, the solution in this case will be as follows:

$$j_r = -\chi'(z) \cdot q \cdot r \cdot \sin(\pi \cdot r / \chi'(z)), \quad (34)$$

$$j_\phi = \left[\begin{aligned} & h \cdot \left(\frac{\pi^2}{\chi'(z)R^2} - \chi'(z) \right) \cdot r \cdot \sin(\pi \cdot r / \chi'(z)) + \\ & + \frac{h}{\chi'(z)} \left(2 - \frac{\pi}{\chi'(z)} \right) \cdot \cos(\pi \cdot r / \chi'(z)) \end{aligned} \right], \quad (35)$$

$$j_z = q \left(2 \sin(\pi \cdot r / \chi'(z)) + \frac{\pi \cdot r}{R} \cdot \cos(\pi \cdot r / \chi'(z)) \right), \quad (36)$$

$$h_r = h \cdot r \cdot \sin(\pi \cdot r / \chi'(z)), \quad (37)$$

$$h_\varphi = q \cdot r \cdot \sin(\pi \cdot r / \chi'(z)), \quad (38)$$

$$h_z = -\frac{h}{\chi'(z)} \left(2 \sin(\pi \cdot r / \chi'(z)) + \frac{\pi \cdot r}{R} \cos(\pi \cdot r / \chi'(z)) \right). \quad (39)$$

The obtained functions will depend on the $\chi'(z)$. With the following equality $\chi(z) = \eta z$, equations (34)-(39) are transformed into equations (22)-(27).

For example, Figure 3 shows the functions $\chi(z)$ and $\chi'(z)$ where the $\chi'(z)$ is an equation of ellipse.

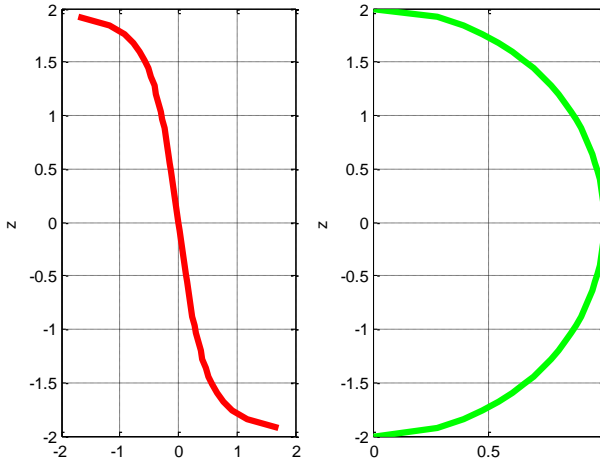

Fig. 3. (figPlazma3.m)

We can suggest that the current of the specks of dust is such that their average speed does not depend on the current direction. In particular, the path covered by a speck of dust per a unit of time in a circumferential direction and the path covered by it in a vertical direction are equal with a fixed radius. Consequently, in this case with a fixed radius we may assume that

$$\Delta\varphi \equiv \Delta z. \quad (40)$$

The dust trajectory in the above considered system is described by the following formulas:

$$co = \cos(\chi(z)), \quad (41)$$

$$si = \sin(\chi(z)). \quad (42)$$

Thus, there is a point trajectory described by formulas (40)-(42) in such system on the rotation figure with a radius of $r = \chi'(z)$. This trajectory is a helix. Along this trajectory, all the strengths and the densities of currents do not depend on the φ .

Based on this assumption, we can construct a movement trajectory for specks of dust in accordance with functions (1)-(3). Figure 4 shows these two helices described by the current functions $j_r(r)$ and $j_z(r)$: one line is for $r_1 = \chi'(z)$ and the second line is for $r_2 = 0.5\chi'(z)$, where the $\chi'(z)$ is defined in Figure 3.

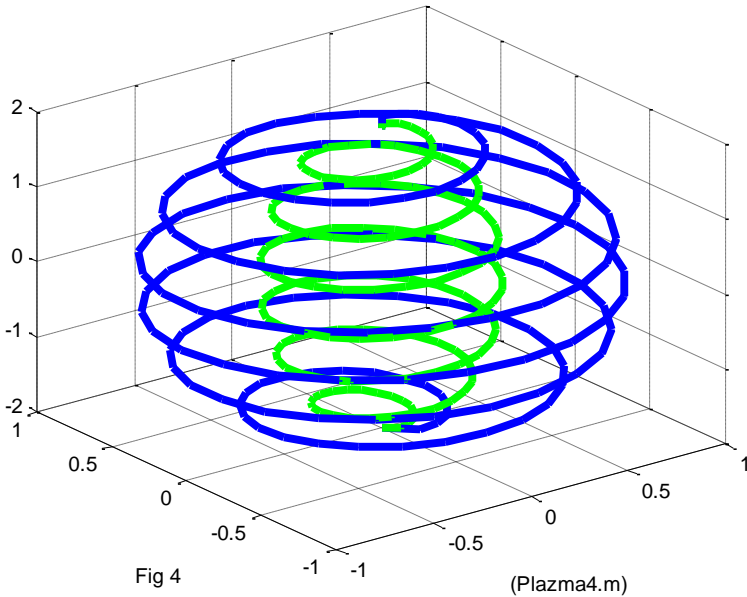

Fig. 4. (Plazma4.m)

5. The plasma crystal energy

Under certain magnetic strengths and current densities, we can find the plasma crystal energy. The magnetic field energy density is

$$W_H = \frac{\mu}{2} (H_r^2 + H_\varphi^2 + H_z^2). \quad (43)$$

The specks of dust kinetic energy density W_J can be found in the assumption that all the specks of dust have equal mass m . Then

$$W_J = \frac{1}{m} (J_r^2 + J_\varphi^2 + J_z^2). \quad (44)$$

To determine the full energy of the crystal, we need to integrate formulae (43) and (44) by the volume of the crystal, the form of which is defined. Thus, with the defined form of the crystal and assumed mathematical model we can find all the characteristics of the crystal.

Chapter 12. Work of Lorentz Force

It is proved that the Lorentz force does the work, and the relations that determine the magnitude of this work are derived.

The magnetic Lorentz force can be determined by the following formula:

$$F = qQ(V \times B), \quad (1)$$

where

q is the density of electric charge,

Q the volume of a charged body,

V the velocity of the charged body (vector),

B the magnetic induction (vector).

The work of the Lorentz force is equal to zero because the force and the velocity vectors are always orthogonal.

Also, the Ampere force is determined by the following expression:

$$A = Q(j \times B), \quad (2)$$

where j is the electric current density (vector). Because there is

$$j = qV, \quad (3)$$

then formula (2) can be rewritten in the following form:

$$A = qQ(V \times B). \quad (4)$$

It can be seen that formulas (1) and (4) coincide. Meanwhile, the work of the Ampère force is NOT equal to zero, as evidenced by the existence of electric motors. Consequently, the **work of the Lorentz force is NOT equal to zero**. Thus, the definition of mechanical force through work can not be extended to the Lorentz force.

Let us consider **how the Lorentz force performs its work**.

The density of the flow of electromagnetic energy representing the Poynting vector is determined by the following formula:

$$S = E \times H, \quad (5)$$

where

E is the electric field strength (vector),

H the magnetic field strength (vector).

The currents' densities correspond to the following electrical field strength:

$$E = \rho j, \quad (6)$$

where ρ is the electrical resistance. Combining (5) and (6), as in Chapter 5, we obtain:

$$S = \rho j \times H = \frac{\rho}{\mu} j \times B. \quad (7)$$

where μ is the absolute magnetic permeability. The magnetic Lorentz force acting on all charges of the conductor in a unit volume, namely the volume density of the Lorentz force is (as follows from (1)):

$$f = qV \times B. \quad (8)$$

With formulae (3) and (8), we find that

$$f = qV \times B = j \times B. \quad (9)$$

With expressions (7) and (9), it is possible to find that

$$f = \mu S / \rho. \quad (10)$$

The density of the magnetic force of Lorentz is proportional to the density of electromagnetic energy representing the Poynting vector.

The energy flux with density S is equivalent to the power density p , i.e.

$$p = S. \quad (11)$$

Consequently, the density of the magnetic force of Lorentz is proportional to the power density p .

Example 1. For verification, let us consider the dimensions of the quantities in the aforementioned formulas in the SI system that are listed in Table 1.

Table 1.

Parameter		Dimension
Energy		$\text{kg m}^2 \cdot \text{s}^{-2}$
Density of energy		$\text{kg m}^{-1} \cdot \text{s}^{-2}$
Power	P	$\text{kg m}^2 \cdot \text{s}^{-3}$
Density of energy flow, power density	S	kg s^{-3}
Current density	j	$\text{A} \cdot \text{m}^{-2}$
Induction	B	$\text{kg s}^{-2} \cdot \text{A}^{-1}$
The volume density of the Lorentz force	f	$\text{kg s}^{-3} \cdot \text{m}^{-2}$
Magnetic permeability	μ	$\text{kg s}^{-2} \cdot \text{m} \cdot \text{A}^{-2}$
Resistivity	ρ	$\text{kg} \cdot \text{s}^{-3} \cdot \text{m}^3 \cdot \text{A}^{-2}$
μ/ρ	μ/ρ	$\text{s} \cdot \text{m}^2$

So, the current with the density j and the magnetic field with the induction B create an energy flux with density S (or power with density p) which is identical to the magnetic force of Lorentz with the density f , see in (11) or

$$f = \mu p / \rho. \quad (12)$$

Thus, the Lorentz force with the density f through the energy flux with the density S (or power with density p) acts on charges moving in the current J in the direction along this current. Consequently, it can be argued that the Poynting vector (or power with density p) creates an emf in the conductor. This question, on the other hand, was considered in [19] and [17], where such an emf is called the fourth kind of electromagnetic induction.

Consider the emf created by the Lorentz force. The strength, which is equivalent to the Lorentz force acting on a unit charge, is defined by

$$e_f = \frac{f}{q} = \frac{p\mu}{q\rho}, \quad (13)$$

Also, the current produced by the Lorentz force in the direction of this force has the following density:

$$i = e_f \rho = \frac{p\mu}{q}. \quad (14)$$

If the current I produced by the Lorentz force at the resistance R is known, then

$$U = e_f \rho = I \left(R + \rho \frac{l}{s} \right), \quad (15)$$

where l , s are the length and cross-section of the conductor, respectively, in which the Lorentz force acts.

From (15) we find:

$$I = e_f \rho / \left(R + \rho \frac{l}{s} \right) = e_f / \left(\frac{R}{\rho} + \frac{l}{s} \right). \quad (16)$$

The full power can be defined by

$$P = pls. \quad (17)$$

Finally, from (13), (16), and (17) we obtain:

$$I = \frac{P\mu}{qls} \bigg/ \left(R + \rho \frac{l}{s} \right) = \frac{P\mu}{ql} \bigg/ (sR + \rho l), \quad (18)$$

$$U = \frac{P}{I} = \frac{ql}{\mu} (sR + \rho l). \quad (19)$$

With these formulas and the results of the measurements of the parameters U and I , the density of charges under the action of the Lorentz force can be found.

Chapter 13. Electromagnetic Momentum and Unsupported Movement

Contents

1. Preface \ 1
2. Basic ratios \ 2
- Appendix 1a. Experiment of Tamm.
- Appendix 1b. Experiment of Graham and Lahoza \ 6
- Appendix 1c. Experiment of Ivanov.
- Appendix 2. Experiment with HVEM \ 7

1. Preface

In 1874, Umov has introduced to physics the idea of energy motion, the energy flow, and the velocity of energy motion. In this case, the energy flux density S , the energy density W , and the velocity v of energy motion are related by the following formula: $S = W \cdot v$.

This statement is universal. In electrodynamics, the flux density vector of electromagnetic energy is called the Umov-Poynting vector. The velocity of electromagnetic energy in electrodynamics is assumed to be equal to the light speed: $v = c$. This statement forced out cases from scientific use, where the velocity of movement of electromagnetic energy is less than the light speed. And such cases are known. For example, the velocity of energy in a wave packet is less than the light speed. In a **stationary** electromagnetic field, there is no electromagnetic wave but there is a flow of electromagnetic energy. In this case there is no reason to associate the velocity of electromagnetic energy in static fields with the light speed.

It is known that the density of the electromagnetic momentum p is related to the density of the flow of electromagnetic energy by the following formula: $p = S/c^2$. It is also known that the density of an electromagnetic momentum propagating in the body is (numerically) the density of the mechanical momentum m in this body: $m = p$. And this fact also somehow fell out of scientific use. Indeed, is it worth paying

attention to the meager value resulting from dividing by the light speed squared.

And, meanwhile, the mechanical momentum of the electromagnetic field in the body appealed to attention. Experiments are known (they will be discussed in more detail below) that prove the existence of a momentum, the magnitude of which is 100 times greater than the theoretical value. Researchers searched for an explanation in the existence of a substance other than matter and field.

It is enough to assume that the velocity of movement of electromagnetic energy is not equal to the light speed (in general), and then all the situations described above become explainable. This velocity can be calculated. In the previous chapters of this book, various processes of electromagnetic energy propagation (battery discharge, capacitor discharge, magnet demagnetization, energy movement in the DC wire) are considered and it is shown that in treated cases, the energy velocity is much less than the light speed.

Thus, the electromagnetic momentum and the mechanical momentum enter quantitatively in an equitable manner into the law of conservation of momentum.

2. Basic ratios

There are known interdependencies between the densities of energy W , energy flux S , momentum flux p , momentum density f , which have the following forms (in the SI system):

$$S = W \cdot c, \quad (1)$$

$$p = W/c, \quad (2)$$

$$p = S/c^2. \quad (3)$$

$$f = p \cdot c. \quad (3a)$$

2.1. It was shown in Chapter 1 that for a monochromatic wave there is a solution, for which condition (1) is satisfied, i.e. for a monochromatic wave the velocity of energy motion is equal to the propagation velocity of a monochromatic wave, i.e. the light speed. The solution found in Chapter 1 is such that it establishes the constancy of both the energy and energy flux of the electromagnetic wave in time. This is in contrast to the known solution, where the constancy of these quantities **on the average in time** is established, which, of course, is not the actual constancy required by the energy conservation law.

2.2. Thus, equation (1) is valid for a monochromatic wave. The velocity of energy motion in a wave packet is generally considered equal to the group velocity. In [94], it is strictly shown that this velocity of energy motion depends on both the phase velocity and the speed of light. In any case, the velocity of energy motion in the wave packet is less than the speed of light.

2.3. In a **stationary** electromagnetic field, there is no electromagnetic wave but there is a flux of electromagnetic energy. Along with this flow there is also the electromagnetic momentum, see in formulas (2) and (3). This statement is not universally accepted. However, G.P. Ivanov in [97] proves the existence of a momentum, by analyzing known experiments by direct calculations. In these experiments there are quasi-stationary electromagnetic fields, where there is no emission of electromagnetic waves. Among these experiments there are speculative ones (their authors are Tamm and Feynman, see in **Appendix 1a**) but there is also the real experiment of G.M. Graham and D.G. Lahoza [95], see in **Appendix 1b**.

The experiments of Tamm, Graham and Lahoz are discussed by Ivanov in [144] (from where the illustrations and translation of work [95] come from). From them, in his opinion, it follows that "the angular momentum of the substance and field is not preserved." Later in [147], he proposes the construction demonstrated in **Appendix 1c**. He believes that his design will move only at the alternating voltage. His proof is built "on the basis of the laws of conservation of momentum, energy, and the principle of relativity, according to which such a movement is carried out thanks to the force and energy interaction with the physical vacuum (ether)".

So, the electromagnetic momentum exists in stationary fields. However, using the same analysis, G.P. Ivanov in [97] proves that the magnitude of this momentum is extremely small (in essence, this follows from expressions (1) and (2), where there is a division by the speed of light). Nevertheless, the experiment of G.M. Graham and D.G. Lahoza detects a large value of momentum. G.P. Ivanov proves that the experimental value of the momentum is 100 times higher than the theoretical value. Otherwise this experiment could not have taken place because the experimentalists have measured the value of the electromagnetic momentum by the value of the mechanical momentum and on the basis of the law of conservation of momentum.

So, the electromagnetic momentum exists in stationary fields but does not satisfy equations (1)-(3) because has a significant value.

G.M. Graham and D.G. Lahoz see the explanation for this in the fact that the electromagnetic energy circulates in a vacuum like a flywheel.

G.P. Ivanov sees the explanation for this in the "existence of a kind of matter (electrovacuum) that is different from matter and the field but fills the entire physical space, and is capable of entering into both impulsive (force) and energetic interactions with matter."

2.4. The above experiments were performed in stationary fields but with the variable strength E. If we assume that the energy flow exists in static fields, then we can offer other experiments. For instance, one can repeat the experiments of Tamm, Feynman, Graham and Lakhov, replacing the source of an alternating voltage to the source of constant voltage. This voltage can be high-voltage and then the observed pulse should increase significantly.

Another theoretical experiment, which proves the possibility of unsupported movement in the system due to the interaction of moving electric charges, is discussed in Chapter 13a.

Chapter 18 proves that the Ampere and Lorentz forces are a consequence of the observance of the law.

2.5. Theory and experiments by Sigalov.

R.G. Sigalov in [156], as far back as 1965, showed for the first time that **“the magnetic interaction of the currents flowing in a solid can bring this body into translational and rotational motion”**. For a theoretical proof of this phenomenon, Sigalov used electronic theory. At the same time, he had to perform complex and cumbersome calculations for almost every configuration. He accompanied all theoretical conclusions with original experiments. All this was the convincing evidence of a violation of Newton's third law. Therefore, Sigalov's theory was not widely accepted.

Now his experiments are repeated without mentioning the author. Figure 1 shows the experiment demonstrated in [157]: a rotating spiral through which direct current flows. A similar experiment is shown in Figures 28 and 29 on page 49 in [156]. Interestingly, the rotation of the helix depends on the direction of winding.

Chapter 5 shows that an electromagnetic wave propagates in the DC wire. The electromagnetic wave and the electromagnetic pulse propagate together. In clause 2.10 below, it is shown that the mechanical

pulse is present in the wire along with the electromagnetic pulse. This impulse causes the rotation of the shown spiral. The existence of this pulse explains all of Sigalov's experiments.



Fig. 1.

2.6. Umov [81] introduced to physics the idea of energy motion, the energy flow, and the velocity of energy motion. In this case, the energy flux density S , the energy density W , and the velocity v of energy motion are related by the following formula:

$$S = W \cdot v . \quad (4)$$

This statement is universal in nature. However, it is sufficient to assume that the velocity of electromagnetic energy motion is **not equal** to the light speed (in the general case) and then all the above-described situations become understandable.

Indeed, there is no reason to associate, for example, the velocity of electromagnetic energy motion in static fields with the light speed.

2.7. In the previous chapters, various processes of propagation of electromagnetic energy (battery discharge (Chapter 5), condenser discharge (Chapter 7), demagnetization of a magnet (Chapter 7a), movement of energy in the DC wire (Chapter 5)) are considered. Also, it is shown in these chapters that in these cases, condition (4) is fulfilled and the velocity of electromagnetic energy motion is significantly less than the light speed.

2.8. So, in general, we need to use formulas (1)-(3), where instead of the light speed we set the velocity of electromagnetic energy motion:

$$S = W \cdot v, \tag{4}$$

$$p = W/v, \tag{5}$$

$$p = S/v^2, \tag{6}$$

$$p = W^2/S. \tag{7}$$

So,

the electromagnetic momentum and the mechanical momentum enter the law of conservation of momentum in an equal manner. This statement opens up wide scope for the design of unsupported engines.	(8)
--	-----

2.9. The electromagnetic mass is

$$m = \frac{p}{v} = \frac{W}{v^2} = \frac{S}{v^3} = \frac{W^3}{S^2} \tag{9}$$

2.10. If at a certain part of the boundary of the body a flow of energy \bar{S} with a density S directed outwards arises, then an electromagnetic momentum with a density \bar{p} directed outward arises. According to the law of conservation of momentum, the following mechanical momentum equal to it and directed towards the body is created:

$$\bar{M} = -(\bar{p}). \tag{10}$$

Let the surface of this area is equal to q , and its volume is equal to g . Then

$$\bar{S} = qS, \tag{11}$$

$$\bar{p} = gp. \tag{12}$$

From (7), (10), and (12) we find:

$$\bar{M} = -gp. \tag{13}$$

So, if some electromagnetic energy is present in the body and a flux of electromagnetic energy leaves the body, then, according to (13), the mechanical momentum acting on the body can be found.

2.11. Naturally, the designers of unsupported engines did not wait for my approval (8) and have long been engaged in this ungrateful business.

In [99], a method is proposed for "ensuring the translational momentum of transport, including space vehicles." However, the author

himself points out that, in accordance with his theory, the tractive effort in the proposed constructions will be very small.

The Biefeld-Brown effect is known [101]. There is no reliable information on the implementation of the patent. This effect has not received a generally accepted explanation to date. It can be assumed that this effect is due to the appearance of an electromagnetic momentum.

In [102], it is described a device intended for flights in an airless environment. In this device, it is also implemented the Biefeld-Brown effect and explained this effect with the use of an electrodynamic momentum.

In [106], it is described a hypothetical experiment with some electric charges and currents, which demonstrates the violation of Newton's third law but the fulfillment of the law of conservation of momentum, i.e. the possibility of unsupported movement.

It is also known one electric high voltage motor representing a high voltage air capacitor [131]. The effect demonstrated in this case also did not receive a generally accepted explanation. Chapter 13d offers an explanation of it.

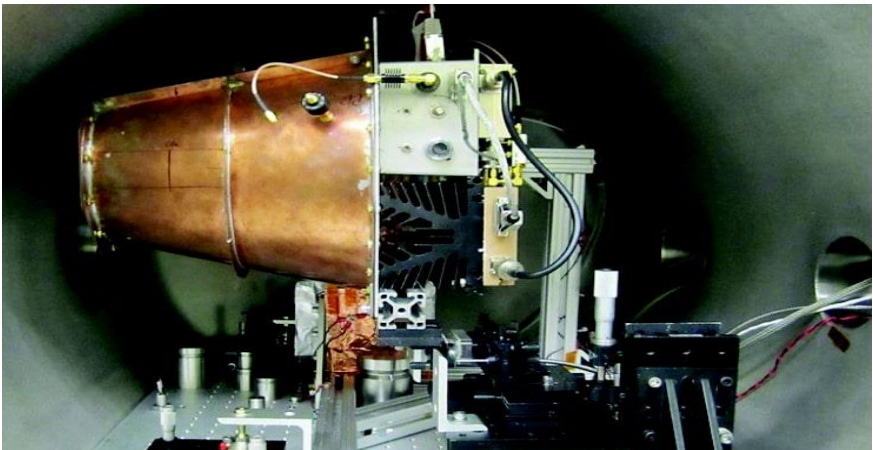

Fig. 2.

Recently, there has patent [103] and also both NASA experiment [104] and similar Chinese experiment [105] based on that patent that is shown in Figure 2. They cause the same doubts and disputes in the scientific world because they violate the law of conservation of momentum. These experiments clearly demonstrate the creation of thrust force due to the electrodynamic effects. However, they are experiments

and one cannot argue with them! In my opinion, they confirm the aforementioned theory.

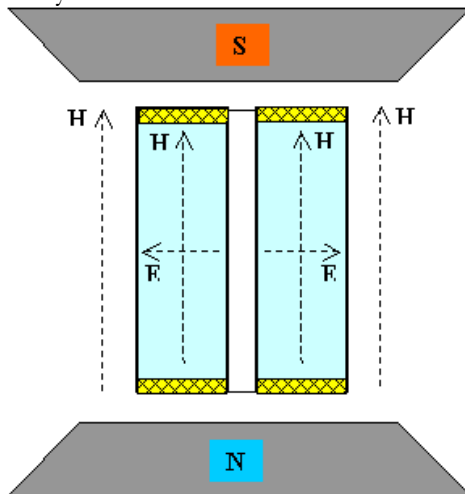

Fig. 3.

Appendix 1a. Tamm's experiment.

In [22], Tamm describes the following thought experiment shown in Figure 3 of work [144]. A cylindrical capacitor placed in a uniform magnetic field H parallel to its axis is considered. In the space between the plates of the capacitor, in addition to the magnetic there is also a radial electric field of strength E created by a charged capacitor. In the space between the capacitor plates in a static electromagnetic field there is the Poynting vector. The Poynting vector lines, i.e. the energy flow lines are concentric circles whose planes are perpendicular to the axis of the capacitor.

Appendix 1b. Experiment of Graham and Lahoza

The scheme of the experiment is shown in Figure 4 borrowed from [144], where

- 1 stands for the cylindrical capacitor,
- 2 the torsion-oscillator suspension,
- 3 the mirror,
- 4 the radially located wires for supplying alternating voltage to the plates,
- 5 the superconducting solenoid.

The authors write: "Our program for measuring the forces associated with the electromagnetic momentum at low frequencies in matter, has culminated in the first direct observation of the free

electromagnetic angular momentum produced by the quasistatic (non-wave) independent fields E and B in the vacuum gap of a cylindrical capacitor. To record condenser motion, a resonance suspension was used."

Thus, in this experiment, the electromagnetic momentum was detected by measuring the mechanical momentum during torsional vibrations of the capacitor. This means that the electromagnetic momentum exists in stationary electromagnetic fields and has a significant value.

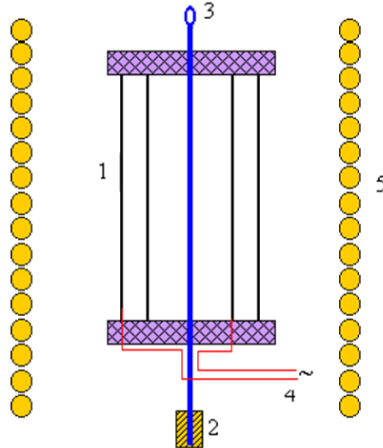

Fig. 4.

Appendix 1c. Ivanov's experiment

In [147], G.P. Ivanov offers the construction shown in Figure 5.

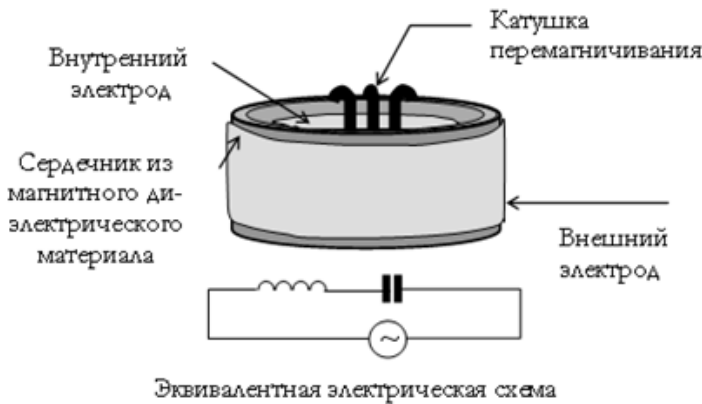

Fig. 5.

Chapter 13a. Unsupported Motion Without Violating the Laws of Physics

Contents

1. Introduction \ 1
2. The Interaction of Moving Electric Charges \ 1
3. The First Experiment \ 2
4. The Second Experiment \ 5
5. The Parameters of Motion \ 9
6. Resistance to Motion \ 11

1. Introduction

We are considering some speculative experiments with charges and currents, which demonstrate a breach of Newton's third law, i.e. an opportunity of unsupported movement. It is shown that these experiments do not violate the Law of momentum conservation. We describe a structure in which electric charges are driven into rotation. We show that this structure performs translational unsupported motion. We describe the mathematical model and the experimental results with a mathematical model of this structure. Some recommendations are given for the implementation of the design.

Unsupported motion is usually considered to be impossible due to the fact that it violates both Newton's third law and following from it (in mechanics) the law of momentum conservation. The latter is more general law of the laws of physics. In electrodynamics, the law takes into account also the momentum of electromagnetic wave. Therefore, the impulses of material objects interacting with the wave turn out in total to be not equal to zero [13].

In [161], the interaction of electric charges is considered, and it is proved that in this case there may be cases when the law of momentum conservation in mechanics is violated. Described below based on this experiments that demonstrate unsupported motion (see also [106]).

2. The Interaction of Moving Electric Charges

Let us consider two charges q_1 and q_2 , moving at speeds v_1 and v_2 , respectively. It is known [161] that the induction of the field created by the

charge q_1 in the point, where at this moment the charge is located, is equal to (here and further the GHS system is used)

$$\overline{B}_1 = q_1(\overline{v}_1 \times \overline{r})/cr^3. \quad (1)$$

The vector \overline{r} is directed from the point where the moving charge q_1 is located. The Lorentz force acting on the charge q_2 is

$$\overline{F}_{12} = q_2(\overline{v}_2 \times \overline{B}_1)/c. \quad (2)$$

or

$$\overline{F}_{12} = q_1q_2(\overline{v}_2 \times (\overline{v}_1 \times \overline{r}))/c^2r^3. \quad (3)$$

Similarly,

$$\overline{B}_2 = -q_2(\overline{v}_2 \times \overline{r})/cr^3, \quad (4)$$

$$\overline{F}_{21} = q_1(\overline{v}_1 \times \overline{B}_2)/c \quad (5)$$

or

$$\overline{F}_{21} = -q_1q_2(\overline{v}_1 \times (\overline{v}_2 \times \overline{r}))/c^2r^3. \quad (6)$$

Here the minus sign appears because the vector remained the same.

In the general case of $\overline{F}_{12} \neq \overline{F}_{21}$, i.e. the Newton's third law is not observed: there appear unbalanced forces acting on the charges q_1 and q_2 and contorting the trajectories of these charges' motion.

If the charges q_1 and q_2 in the process of moving do not leave a certain general construction, then there is the following force acting on this construction:

$$\overline{F} = \overline{F}_{12} + \overline{F}_{21} \quad (7)$$

or

$$\overline{F} = \frac{q_1q_2}{c^2r^3} ((\overline{v}_2 \times (\overline{v}_1 \times \overline{r})) - (\overline{v}_1 \times (\overline{v}_2 \times \overline{r}))). \quad (8)$$

This force is capable of moving the construction. It can be assumed that such forces provide the flight of ball lightning.

3. The First Experiment

Let us consider two charges q_1 and q_2 rotating at a constant speed $v_1 = v_2$ along mutually perpendicular circular orbits that is shown in Figure 1. The rotation begins from the position shown in Figure 1 and is provided by mechanical forces within the construction.

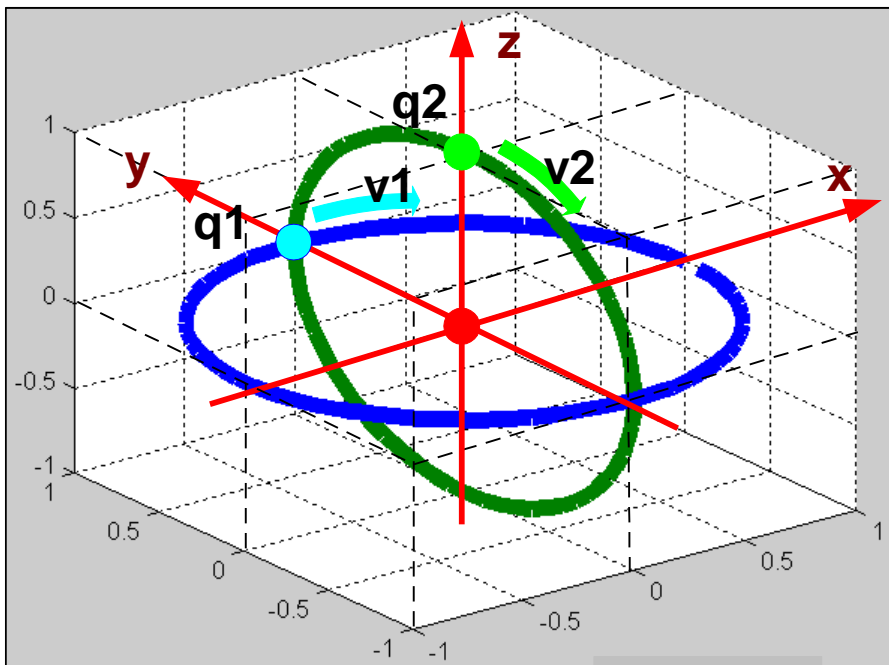

Fig. 1.

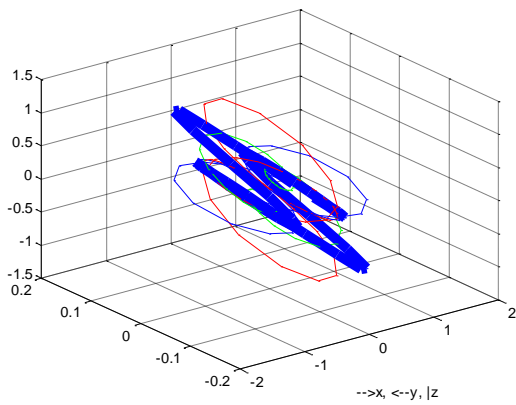

Fig. 2.

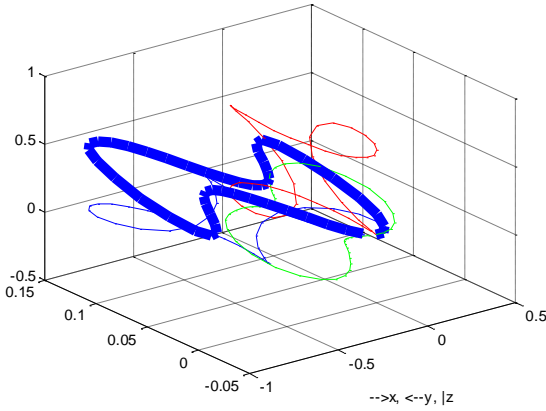

Fig. 3.

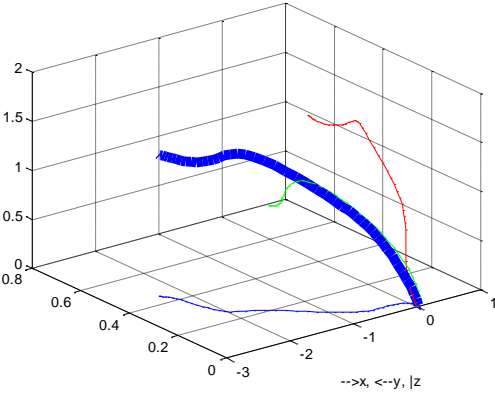

Fig. 4.

Using formula (8), we can find the force acting on the whole construction. Figure 2 shows the special graph of this force’s change during one revolution of the charges (the thick line) and the projection of this graph on the coordinate planes (thin lines). Here and further the projection lines are depicted so: the green line is xz , the blue one is xy , and the red one is yz . The axes’ directions are shown under the graph.

For the known force and given zero initial conditions, we can find both the speed and the trajectory of the construction for the given period that are shown in Figures 3 and 4, respectively. For this period, the construction is shifted to the following distance: $R_{\max} = 2.8$. Figure 5 shows the trajectory of the construction during two periods, when it has shifted to the distance of $R_{\max} = 5.6$.

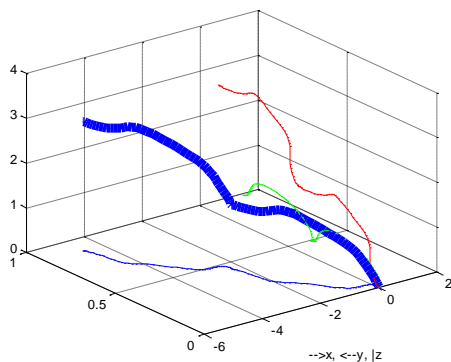

Fig. 5.

4. The Second Experiment

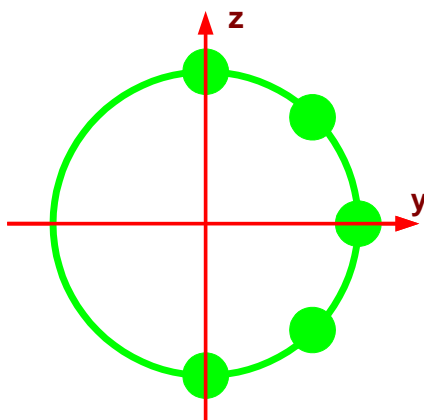

Fig. 6.

In the construction shown in Figure 1, one charge was located on each circle. Now we shall consider a construction where several charges are located on each circle but all of them are concentrated and distributed uniformly along the half-circle that is shown in Figure 6. Here also with formula (8), we may find the force acting on the construction as a whole. We find that the vector of this force lies on the plane xOz for any number of charges $a \geq 1$. The vector of speed and the trajectory are also on the plane xOz . Figure 7 shows as an example the construction's trajectory for one period for the case when the construction contains 5 charges on each circle.

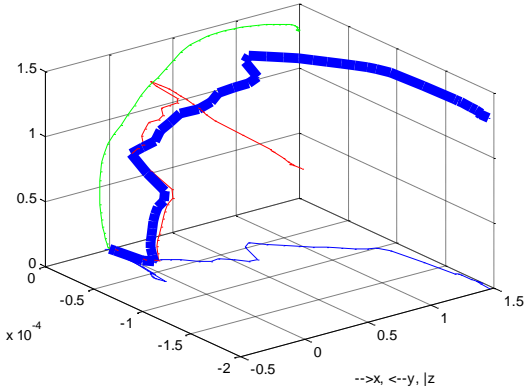

Fig. 7.

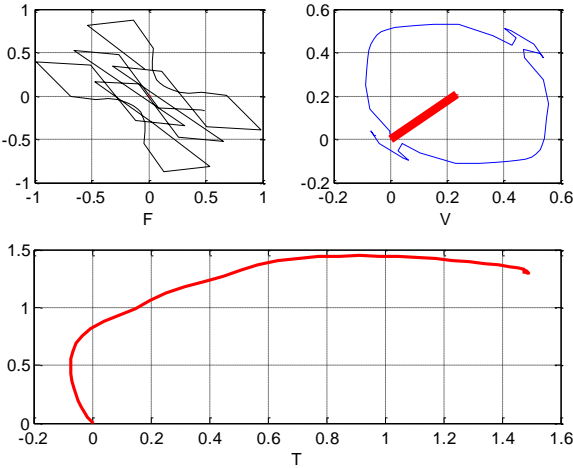

Fig. 8.

For this same case, Figure 8 shows the graphs of the force change (plot F) and the speed (plot V) during the time of one revolution of the charges and the trajectory of the construction (plot T) in the xOz coordinates. In this and in the following figures, it is assumed that the ox axis is directed horizontal but the oz axis vertical.

In Figure 8, we may also see that during one period the construction is shifted by the following certain distance: $R_{\max} = 2$. Figure 9 shows the similar graphs for the same construction during two periods. Apparently, the construction shifts on the distance of $R_{\max} = 4$.

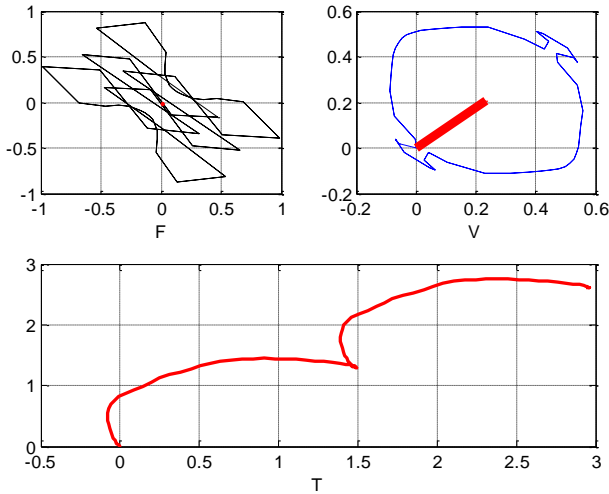

Fig. 9.

Figures 10 and 11 show the same graphs for two periods for constructions containing 15 and 25 charges, respectively. For all the constructions, the magnitude of charge is chosen to be $q = 1/a$. Apparently, in this case the graphs of force and speed change do not depend on the number of charges, and the trajectories are also independent of the charges' number. Thus, such construction on increasing the number of the charges “aims” to a construction with an infinite number of the charges. In it, the linear distribution of the density of charges by the length l of the charged half-circle is $\frac{dq}{dl} = \frac{1}{\pi R}$. Concerning the realization of such a construction, the charges in it must contact but not merge into a continuous strip because the distribution function of the charges' density along the lane is not uniform (the charges are accumulated at the strip's edges). The charges of such construction may permanently recover from a source of DC voltage through brush contacts.

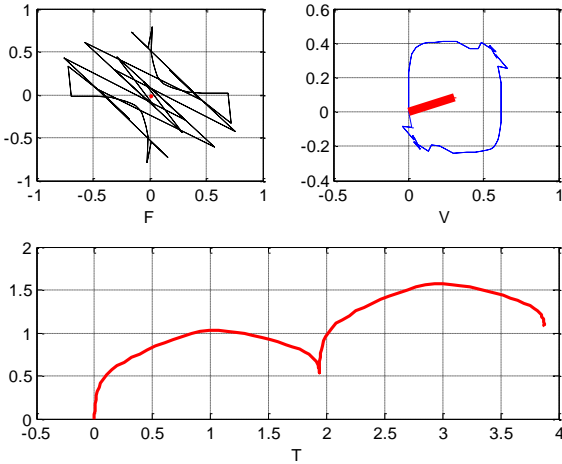

Fig. 10.

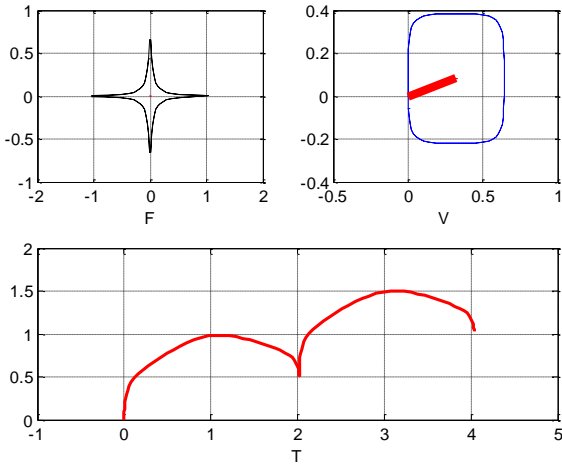

Fig. 11.

In conclusion, let us consider the results of the calculation for the same conditions that were used for the calculation of the parameters shown in Figure 10 but for 20 periods. These results are shown in Figure 12. In this figure, the red vector on the hodograph of the speed depicts the average speed $V_s \approx 0.32$ of the construction's motion. After 20 periods, the construction has shifted on $R \approx 40$.

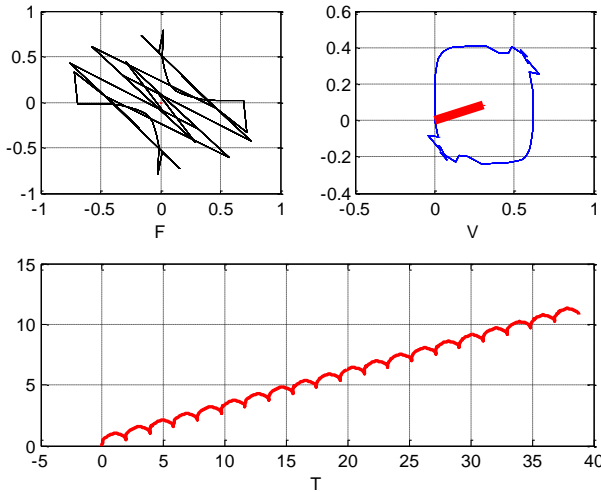

Fig. 12.

5. The Parameters of Motion

Let us consider in detail some characteristics of such motion. We shall not take into account the energy necessary for the construction's rotation at a permanent speed. The factors affecting the kinetic power P , expended by the construction for its motion, the average speed V_s , and the construction's displacement, are:

- the speed of the construction as a whole, $v = (v_1, v_2, v_3)$,
- the propulsive force $F = (f_1, f_2, f_3)$ developed by the construction,
- the number of revolutions, N ,
- the linear rotation frequency f or the angular rotation frequency $\omega = 2\pi f$,
- the construction's radius R_k ,
- the linear speed of the charges, $v_o = R_k \omega$,
- the summary charge q_o ,
- the number a of charges, each of them having magnitude q_o/a ,
- the mass of construction, m .

We can prove that for $a > 4$, the number a of charges does not affect the motion parameters, and

$$P = (v, F), \quad (1)$$

$$V_s = (v_o, m, q, \omega), \quad (2)$$

$$R = (N, v_o, m, q, \omega). \quad (3)$$

Figure 13 shows the graphs of the instant motion parameters for $a = 5, N = 5, \omega = 1, v_o = 1, q_o = 1$. Here

T is the motion trajectory,

$x1, x3$ the coordinates x, z depending on time,

V the hodograph of overall speed and the average speed vector,

F the hodograph of the force,

$f1, f3$ the force projections f_x, f_z depending on time,

P the instant power depending on time,

P_s the average power,

$v1, v3$ the projections of the speeds v_x, v_z depending on time,

vm the the speed amplitude.

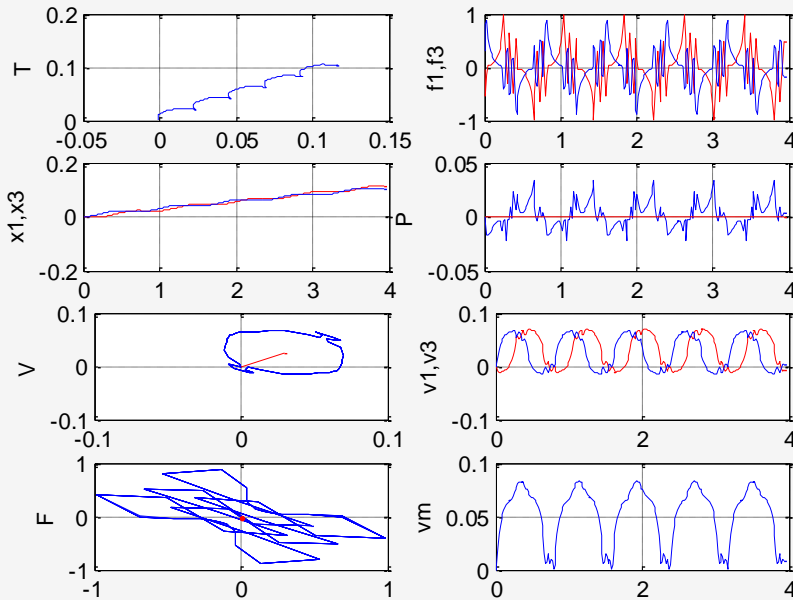

Fig. 13.

6. Resistance to Motion

The construction is always affected by the force F_T of resistance to motion that can be friction or useful load. Usually such force is proportional to the instant speed V , i.e.

$$F_T \approx F_t \cdot V, \tag{4}$$

where F_t is the known coefficient.

The instant power of resistance to motion is

$$P_T = (F_T \cdot V) = F_t \cdot V^2, \tag{5}$$

Figure 14 shows the graphs of the instant values of the motion parameters for $F_t = -0.75$ и $a = 5, N = 5, \omega = 1, v_o = 1, q_o = 1$. In plot P in Figure 14, the horizontal line is the graph of power (5). We may note that

- the trajectory gradually turns into circular motion of all the construction “on the spot”,
- the instant amplitude of speed aims to a certain constant value (as the motion turns into rotation “on the spot”),

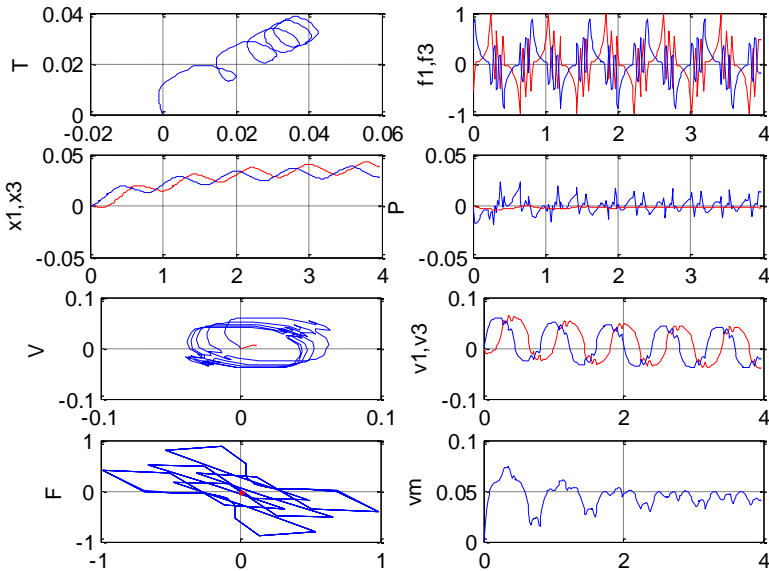

Fig. 14.

Thus, the considered construction performs unsupported motion also with the resistance. The power of the construction’s motor is expended on the rotation of charges and on overcoming the resistance.

Chapter 13b. The Flow of Energy and the Momentum of a Static Electromagnetic Field

Contents

1. Introduction
2. The energy flux density of the electromagnetic field
 - 2.1. Electromagnetic wave energy flux density
 - 2.2. The energy flux density of a moving body with a static electromagnetic field
 - 2.3. Static electromagnetic field energy flux density
3. The momentum of the electromagnetic field
 - 3.1. Electromagnetic momentum of the wave
 - 3.2. The momentum of a moving body with a static electromagnetic field
 - 3.3. The momentum of a static electromagnetic field
 - 3.4. Electromagnetic mass of a static electromagnetic field

1. Introduction

The existence of a flow of energy and momentum in an electromagnetic wave is proved analytically due to the fact that the electromagnetic energy of an electromagnetic wave changes in time. The energy of a static field is constant in time. Therefore, the applicability of the formulas obtained for any field is not obvious. The formulas for the energy flux and momentum of a static electromagnetic field are analytically derived below.

The results obtained were used to design a device for converting a pulse of the static electromagnetic field into a mechanical pulse [184].

2. The energy flux density of the electromagnetic field

2.1. Electromagnetic wave energy flux density

First, we consider the well-known method of obtaining a formula for the energy flux density of an electromagnetic wave [13, 181]. The densities of the electric and magnetic energy of the wave are respectively defined by

$$W_e = \frac{\varepsilon\varepsilon_0}{2} E^2, \quad (1)$$

$$W_m = \frac{\mu\mu_0}{2} H^2. \quad (2)$$

The total density of the electromagnetic wave energy is

$$W = \frac{1}{2} (\varepsilon\varepsilon_0 E^2 + \mu\mu_0 H^2) \quad (3)$$

Because the following equality fulfills

$$W_e = W_m \quad (3a)$$

we can use definitions (1)-(3) and write down that

$$E\sqrt{\varepsilon\varepsilon_0} = H\sqrt{\mu\mu_0}. \quad (3b)$$

Consequently,

$$W = \varepsilon\varepsilon_0 E^2 = \mu\mu_0 H^2 = EH\sqrt{\varepsilon\varepsilon_0\mu\mu_0} = EH/c. \quad (3c)$$

Further from (3) we have:

$$\frac{dW}{dt} = \frac{d}{dt} \left(\frac{\varepsilon\varepsilon_0}{2} E^2 + \frac{\mu\mu_0}{2} H^2 \right) = \left(\varepsilon\varepsilon_0 E \frac{dE}{dt} + \mu\mu_0 H \frac{dH}{dt} \right). \quad (4)$$

It follows from Maxwell's equations that

$$\text{rot}(\mathbf{E}) = -\mu\mu_0 \frac{d\mathbf{H}}{dt}, \quad (5)$$

$$\text{rot}(\mathbf{H}) = \varepsilon\varepsilon_0 \frac{d\mathbf{E}}{dt}. \quad (6)$$

Consequently,

$$\frac{dW}{dt} = (-E\text{rot}(\mathbf{H}) + H\text{rot}(\mathbf{E})). \quad (7)$$

The law of conservation of field energy has the following form:

$$\frac{dW}{dt} = -\text{div}(\mathbf{S}). \quad (8)$$

The mathematical dependence of the following form is well-known:

$$\text{div}(\mathbf{H} \times \mathbf{E}) = \mathbf{E} \cdot \text{rot}(\mathbf{H}) - \mathbf{H} \cdot \text{rot}(\mathbf{E}). \quad (9)$$

From (7)-(9) it follows that

$$\mathbf{S} = \mathbf{E} \times \mathbf{H}. \quad (10)$$

With formulas (3b) and (10), we can finally obtain the following expression:

$$\mathbf{S} = \mathbf{W}\mathbf{c}. \quad (10a)$$

2.2. The energy flux density of a moving body with a static electromagnetic field

Consider a design in which the electret and magnet create the vectors \mathbf{E} and \mathbf{H} . An example of such a design is the electret perpendicular to the magnet shown in Figure 1. The vectors of the velocity \mathbf{V} , the magnetic strength \mathbf{H} , the electric strength \mathbf{E} , and the energy flux \mathbf{S} are shown in Figure 2.

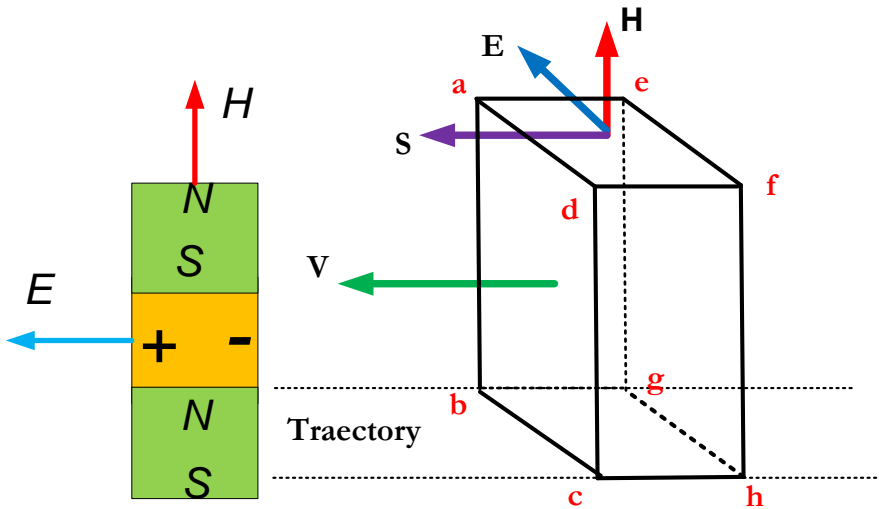

Fig. 1.

Fig. 2.

In this design, the static electromagnetic field with the density of electromagnetic energy W occurs. If this body moves at speed v , then the energy moves at the same speed. According to the concept of Umov [81], this means that there is some flow of electromagnetic energy with the following density:

$$S = Wv. \quad (11)$$

In front of the frontal surface of a moving body, both the strengths E and H change in time, i.e. the derivatives $\left(\frac{dE}{dt}, \frac{dH}{dt}\right)$ of strengths exist. Therefore, the energy density W on the frontal surface of the body satisfies equation (4). To conserve energy, the density in other parts of the body must also change. These varying strengths satisfy Maxwell's equations (5) and (6). As shown in Section 2.1, from (4)-(6) follows equation (10). Thus, in the construction under the consideration, conditions (10) and (11) are satisfied.

The flow of energy is defined as

$$\bar{S} = Sb, \quad (12)$$

where b is the surface area emitting an energy flux. The flow \bar{S} is equal to the power P of the engine, which moves the body (in the absence of friction). Consequently,

$$S = \frac{P}{b}. \quad (13)$$

From (11) and (13) we find the following density of electromagnetic energy:

$$W = \frac{P}{bv}. \quad (14)$$

and the following electromagnetic energy of a body:

$$\bar{W} = WV = \frac{PL}{v}. \quad (15)$$

where $V = Lb$ is the body volume, L is the body length.

With formulas (15) and (3), we obtain:

$$\bar{W} = \frac{Lb}{2} (\varepsilon\varepsilon_0 E^2 + \mu\mu_0 H^2) \quad (16)$$

The kinetic energy of the body is

$$\bar{W}_k = V \frac{mv^2}{2}, \quad (17)$$

where m is the body weight.

In the absence of friction, all engine power is spent on the creation of electromagnetic energy. Consequently,

$$\bar{W}_k = \bar{W} \quad (18)$$

From (16)-(18) we obtain:

$$\frac{\rho v^2}{vg} = (\varepsilon\varepsilon_0 E^2 + \mu\mu_0 H^2) \quad (19)$$

A moving body with a static electromagnetic field can be considered as **a moving packet of a static electromagnetic field**. The energy and energy flow (i.e. the power) of this package remains constant.

The power of the engine which moves the body is partly the power of the package, and partly can be spent on the compensation of mechanical losses and other needs.

Formula (19) means that the density of the mechanical energy of the body is equal to the density of the electromagnetic energy of a moving packet of a static electromagnetic field. Thus, in a moving body with a static electromagnetic field, the conversion of mechanical energy into electromagnetic energy of a static electromagnetic field occurs.

In the static flow of electromagnetic energy there is no conversion of the magnetic energy into the electrical energy, and vice versa. Therefore, there is no equality between the terms.

Let be

$$\frac{E}{H} = \beta. \quad (20)$$

With expressions (19) and (20), we find that

$$\frac{\rho v^2}{g} = H^2 (\varepsilon\varepsilon_0 \beta^2 + \mu\mu_0). \quad (21)$$

or

$$\frac{\rho v^2}{g} = E^2 \left(\varepsilon \varepsilon_0 + \frac{\mu \mu_0}{\beta^2} \right). \quad (21a)$$

For $\beta < 10^{-3}$, we have

$$\frac{\rho v^2}{g} \approx \mu \mu_0 H^2 = BH. \quad (22)$$

For $\beta > 10^3$, we have

$$\frac{\rho v^2}{g} \approx \varepsilon \varepsilon_0 E^2 = DE. \quad (22a)$$

Example 1.

In [184], a “Device for converting an electromagnetic momentum into a mechanical momentum” was proposed, in which such a package is created. In this device, a moving magnet creates the following electrical strength:

$$E = vB = vH\mu\mu_0. \quad (23)$$

Then we have

$$\beta = \frac{E}{H} = v\mu\mu_0. \quad (24)$$

With formulae (21a) and (23), we find:

$$\begin{aligned} \frac{\rho v}{g} &= E^2 \left(\varepsilon \varepsilon_0 + \frac{\mu \mu_0}{\beta^2} \right) = E^2 \left(\varepsilon \varepsilon_0 + \frac{\mu \mu_0}{(v\mu\mu_0)^2} \right) \\ &= \varepsilon \varepsilon_0 E^2 \left(1 + \frac{1}{\varepsilon \varepsilon_0 \mu \mu_0 v^2} \right) = \varepsilon \varepsilon_0 E^2 \left(\left(\frac{c}{v} \right)^2 + 1 \right) \approx \varepsilon \varepsilon_0 E^2 \left(\frac{c}{v} \right)^2. \end{aligned} \quad (25)$$

From formulae (21) and (23) we find that

$$\begin{aligned} \frac{\rho v^2}{g} &= H^2 (\varepsilon \varepsilon_0 \beta^2 + \mu \mu_0) = \mu \mu_0 H^2 (\varepsilon \varepsilon_0 \mu \mu_0 v^2 + 1) = \\ &= \mu \mu_0 H^2 \left(\left(\frac{v}{c} \right)^2 + 1 \right) \approx \mu \mu_0 H^2 = HB. \end{aligned} \quad (26)$$

Using expressions (25) and (26), it is possible to find that

$$\frac{\rho v^2}{g} \approx \varepsilon \varepsilon_0 E^2 \left(\frac{c}{v} \right)^2 \approx \mu \mu_0 H^2. \quad (26a)$$

Find more

$$\varepsilon \varepsilon_0 E^2 = \varepsilon \varepsilon_0 (vH\mu\mu_0)^2 = H^2 \left(\frac{v}{c} \right)^2, \quad (27)$$

i.e. the value of the electrical energy is negligible that results in the following packet energy density:

$$W = HB. \quad (28)$$

We also note that from (23) and (28) it follows that

$$S = EH = vBH, \quad (29)$$

which coincides with formula (11).

2.3. Static electromagnetic field energy flux density

Formula (10) can be applied to a static electromagnetic field. Feynman in [13] describes a speculative experiment, in which an electric charge and magnet are located side by side. It is stated that in consequence (10), a flux of electromagnetic energy circulates around this pair. Another example is the DC wire that also creates the static electromagnetic field. The flow of electromagnetic energy also circulates in this field due to the existence of dependence (10). However, there is no evidence of the applicability of formula (10) for the static electromagnetic field.

We again use formula (11). In the static electromagnetic field, we know the electromagnetic energy density W and the electromagnetic energy flux density S . Therefore, we can determine the energy flux rate as follows:

$$v = W/S. \quad (30)$$

In [8], some phenomena are substantiated on the basis of the existence of a flow of electromagnetic energy in the static field. In [8, Chapter 5] on this basis, it is proved that the flow of energy in the direct current wire moves inside the wire (and not outside it). In [8, Chapter 5a], on this basis, the operation of Milroy's engine is explained. In [8, Chapter 7] on this basis, it is shown that a flow of electromagnetic energy circulates in the charged capacitor and this explains the nature of the potential energy of the capacitor.

3. The momentum of the electromagnetic field

3.1. Electromagnetic momentum of the wave

First, consider the well-known method of obtaining the formula for the momentum density of an electromagnetic wave [182]. The momentum density is determined from the following assumption: the energy of an electromagnetic plane wave, incident perpendicular to the flat surface of a weakly conducting body with both the dielectric permittivity ϵ and the magnetic permeability μ equal to one, is converted into the thermal energy of the current excited in this body by this wave. It turns out that

$$J_0 = W/c. \quad (31)$$

It is important to note that J_0 is a scalar quantity, not a vector.

In the set of Maxwell's equations, Maxwell himself included an equation of the following form [183]:

$$B = \text{rot}(A). \quad (32)$$

Maxwell calls quantity A either an electromagnetic pulse at a point or a vector potential of electric currents. Currently, this equation is not included in the list of initial equations but is derived from both the following equation:

$$\operatorname{div}(\mathbf{B}) = 0 \quad (33)$$

and the following famous identity:

$$\operatorname{div}(\operatorname{rot}(\mathbf{A})) = 0 \quad (34)$$

The parameter \mathbf{A} is called the vector potential. Also, the electromagnetic momentum is called the quantity that has the dimension of a mechanical electromagnetic momentum defined above. What Maxwell had in mind when speaking of an “electromagnetic momentum at a point” remains unclear. It can be assumed that Maxwell did not have time to finish the thought. In the 80s of the last century, it was said that "God himself wrote with the hand of Maxwell" [185].

We multiply both sides of equation (32) by the electric induction vector \mathbf{D} . Then we get:

$$\mathbf{B} \times \mathbf{D} = \operatorname{rot}(\mathbf{A} \times \mathbf{D}). \quad (35)$$

It can be noted that these quantities have the dimension of momentum density. Therefore, the following vector-momentum

$$\mathbf{J} = \operatorname{rot}(\mathbf{A} \times \mathbf{D}), \quad (36)$$

we will continue to call the density of electromagnetic field and quantity (31) is the modulus of this vector. So, from (35, 36) we get the following vector:

$$\mathbf{J} = \mathbf{B} \times \mathbf{D}. \quad (37)$$

The electric and magnetic inductions are respectively defined by

$$\mathbf{D} = \varepsilon \varepsilon_0 \mathbf{E}, \quad \mathbf{B} = \mu \mu_0 \mathbf{H}. \quad (38)$$

From (36), (37), and (10) we obtain:

$$\mathbf{J} = \varepsilon \varepsilon_0 \mu \mu_0 \mathbf{S} \quad (39)$$

or we get the following well-known formula:

$$\mathbf{J} = \frac{\mathbf{S}}{c^2}. \quad (40)$$

This means that the momentum propagates together with the energy flux at the same speed.

3.2. The momentum of a moving body with a static electromagnetic field

So, the pulse propagates at the speed of energy flow and is determined by (40). This ratio can be extended to any flow speed. Therefore, it can be applied to the flow of the static electromagnetic field existing in a body moving at a speed v . In this case there is

$$\mathbf{J} = \frac{\mathbf{S}}{v^2}. \quad (41)$$

With formulae (41) and (30), we obtain:

$$\mathbf{J} = \frac{Wv}{v^2}. \quad (42)$$

Exploiting expressions (41) and (11), we obtain:

$$J = \frac{S}{v^2} = \frac{Wv}{v} = \frac{W}{v}. \quad (43)$$

The electromagnetic momentum is

$$\bar{J} = JV, \quad (44)$$

where V is the volume of the electromagnetic field.

Suppose that the volume V and the body volume are the same. Then from (43) and (44) we find:

$$\bar{J} = \frac{W}{v}V. \quad (45)$$

It follows from the law of conservation of momentum that when an electromagnetic momentum appears, the body acquires the following oppositely directed mechanical momentum:

$$\bar{M} = -\bar{J}. \quad (46)$$

Therefore, the vector \bar{M} has the direction of the vector $(-S)$, its module is

$$|\bar{M}| = \frac{W}{v}V. \quad (47)$$

or

$$|\bar{M}| = \frac{\bar{W}}{v}, \quad (48)$$

where there is the following electromagnetic energy of the body:

$$\bar{W} = WV. \quad (49)$$

Example 2.

We expand **Example 1**. From formulas (17) and (18) we find that

$$\bar{W} = \bar{W}_k = \frac{vmv^2}{2} \quad (50)$$

With equations (48) and (50), we find that

$$|\bar{M}| = \frac{vmv}{2}. \quad (51)$$

3.3. The momentum of a static electromagnetic field

In this case, from expressions (30) and (41) we can obtain that

$$J = \frac{S}{v^2} = \frac{S}{(s/W)^2} = \frac{W^2}{s}. \quad (52)$$

Thus, even in the static electromagnetic field, the electromagnetic momentum exists. As already mentioned, it follows from the law of conservation of momentum that when the electromagnetic momentum appears, the body acquires the following oppositely directed mechanical momentum:

$$\bar{M} = -\bar{J}. \quad (53)$$

Therefore, in a motionless body with the static electromagnetic field there is the mechanical momentum.

Example 3.

Figure 3 shows the electrically conductive magnet of length L with induction B , along which current I flows. In this case, the following Ampere force should occur:

$$F_A = L \cdot I \times B \tag{54}$$

However, some experiments show that this force is absent.

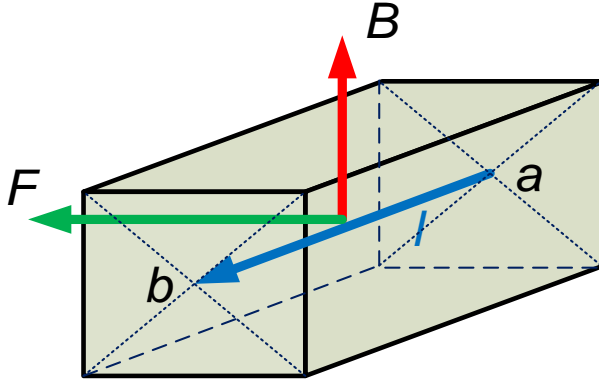

Fig. 3.

The electric and magnetic fields in this magnet are respectively defined as

$$E = r \cdot I, \tag{55}$$

$$H = \mu B, \tag{56}$$

where r, μ is the resistance and absolute magnetic permeability of the magnet. From (10) and (54)-(56) we find the flux density of electromagnetic energy as follows:

$$S = E \times H = \mu r \cdot B \times I = -\frac{\mu r}{L} F. \tag{57}$$

From formula (58) it follows that two oppositely directed pulses act on the momentum:

1. the electromagnetic pulse J depending on the flow of electromagnetic energy S (according to (52)) and applied to the free electrons of the current;
2. the mechanical impulse M depending on the Ampere force F and applied to the atoms of the magnet body.

Since these impulses are equal, oppositely directed (according to (53)) and act on the elements of the same body, the magnet remains at the rest.

Example 4.

Consider the Faraday unipolar motor and select the radius in it that is currently attached to the contact. This radius can be considered as a permanent electrically conductive magnet (shown in Figure 3) connected by point “a” to the contact and point “b” to the axis.

1. If the contact is constantly attached to a given radius during rotation of the disk, then the force will not act on this radius.
2. If the contact slides along the periphery of the disk, then a force acts on the radius connected to the contact.

These facts are established experimentally and are formulated as a paradox of the unipolar engine. Experiment 1 is explained in **Example 3**. Experiment 2 can be explained as follows.

In this case, as in **Example 3**,

1. the electromagnetic momentum J applied to free current electrons;
2. the mechanical impulse M applied to the atoms of the magnet body (disk).

In this case, the magnet body is not rigidly connected to the current line, i.e. with free electrons - a mechanical impulse moves the magnet away from the streamline in the direction opposite to the direction of rotation of the magnet.

3.4. Electromagnetic mass of a static electromagnetic field

Since there is a mechanical momentum in a motionless body with the static electromagnetic field defined by formula (53), a mass current exists in this body. This current, of course, is not related to the actual movement of the mass "from point A to point B". Such a mass current can be compared with an electric current, where a separate charge does not move from the beginning to the end of the wire or compared with a heat flux, where there are also no macro-movements of air particles.

The existence of a mechanical momentum means that in the body, a certain mass moves at some speed, i.e.

$$\vec{M} = m\vec{v}, \quad (58)$$

where \vec{v} is the energy flow rate. From (52), (53), and (58) we find:

$$\frac{1}{v} = \frac{W}{S}, \quad (59)$$

$$v^2 = \frac{S}{J} = \frac{S}{M} = \frac{S}{mv} \quad (60)$$

or

$$m = \frac{S}{v^3} = S \left(\frac{W}{S} \right)^3 = \frac{W^3}{S^2}. \quad (61)$$

Chapter 13d. "Flying Triangles"

It is known some electric high voltage motor, which represents a high voltage air capacitor [131]. It is called "Flying triangles." In it, one lining is made in the form of a wire, and the second in the form of a strip of foil that is shown in Figure 1. At high voltage between the plates there is an ionic wind that allows us to consider this device as a continuously discharging capacitor. The device takes off. This effect was initially explained by the action of ion current and ion wind. More detailed measurements show that the ionic wind produces approximately 60% of the lift. A source of a 40% lift was not identified. In [131b], the authors argue that the lift also occurs in a vacuum (where there is no ionic wind).



Fig. 1. (from [131b], time 6:37)

Consider the equivalent electrical circuit of this device shown in Figure 2. High-voltage energy source U through foil F constantly transfers energy to capacitor C and resistor R (which is the ion current channel). Capacitor C is discharged at resistor R , and the internal thermal energy of this resistor is partially radiated, i.e. the energy of the resistor is also discharged.

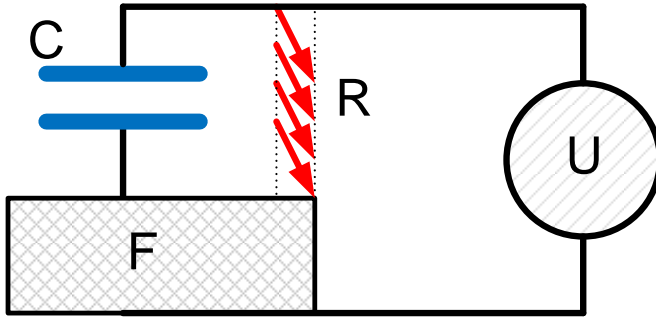

Fig. 2.

The capacitance, energy, and energy density of the capacitor are respectively defined by

$$C = \frac{\epsilon b}{d}, \quad (1)$$

$$W_{C0} = \frac{CU^2}{2}, \quad (2)$$

$$W_C = \frac{W_{C0}}{db}, \quad (3)$$

where U is the voltage across the capacitor and resistor, b is the cross-sectional area of the capacitor, and d is the length of the capacitor.

The energy and the energy density of the resistor in steady-state are respectively defined as

$$W_{R0} = gm \quad (4)$$

$$W_R = \frac{W_{R0}}{V_R} = \frac{gm}{m/\rho} = g\rho, \quad (5)$$

where g, m, ρ, V_R are the specific heat, mass, density, and volume of the resistor, respectively.

Chapter 7 shows that in the capacitor, which is constantly discharged at the resistor R and constantly recharged from the constant voltage source U , there is the static electromagnetic field and the electromagnetic energy flux flows from some source S_0 . This source S_0 is equal to the source power P . Therefore,

$$S_0 = P = \frac{U^2}{R}. \quad (6)$$

Since the energy flux flows through both the capacitor and the resistor combined in the same volume, the same energy flux flows through both and the density of this flux in each of them is

$$S = \frac{S_0}{b}. \quad (7)$$

The energy density in such a body is

$$W = W_C + W_R. \quad (8)$$

Chapter 13a shows that the energy density W of a static electromagnetic field, the electromagnetic energy flux density S , and the velocity v of this flux are related by the well-known Umov formula [81] of the following form:

$$S = Wv, \tag{9}$$

Also, the density of the electromagnetic pulse J in a static electromagnetic field is determined through the flux density of electromagnetic energy S and the velocity v of this flux, according to the following formula:

$$J = \frac{S}{v^2}. \tag{10}$$

From (9) and (10) we find:

$$J = \frac{W^2}{S}. \tag{11}$$

In the structure under consideration, the current flows through the foil. Together with the current, the electromagnetic energy flux flows along the foil and there is an electromagnetic pulse with the density J . The total pulse of electromagnetic energy in the foil is defined as

$$J_0 = V_f J, \tag{12}$$

where V_f is the volume of the foil. In accordance with the law of conservation of momentum, together with the electromagnetic impulse J_0 , the mechanical impulse M_0 is created in the foil, which is directed opposite to the electromagnetic impulse, i.e.

$$|M_0| = |J_0|. \tag{13}$$

This mechanical impulse is the driving impulse of the device.

Consider an example: there are the source data listed in Table 1. These data were obtained by Lavrinenko who is the author of the device. As the density and specific heat of the resistor, the values for the air at a temperature of 20°C were taken. Actual values in the ion current channel can be determined experimentally. However, it can be assumed that the heat capacity of the channel should be much less than the heat capacity of the ordinary air.

The last lines of the table show the values for the air and a vacuum (with $W_R = 0$). The calculated value of the momentum in the air turned out to be much larger than the measured one. This can be explained by the large value of the specific heat. However, this result indicates that the proposed explanation is valid.

It also follows that in a vacuum, the similar effect should be observed.

Table 1. (*CondPolet20.m*)

№	Parameter	Formula	Value
1	voltage, V	U	45,000
2	lifting time, seconds	t	2
3	lifting height, m	h	4
4	lifting speed, m/s	$V=h/t$	2
5	capacitor capacity, F	C	$15 \cdot 10^{-12}$
6	distance between electrodes, m	d	0.01
7	foil width, m	f	0.3
8	mass, kg	m	0.05
9	current, A	I	0.0015
10	specific heat, J/m	<i>g</i>	1005
11	density, kg/m ³	ρ	1.2
15	mechanical momentum, kg*m/s	mV	0.1
12	capacitor plate area, m ²	$b=Cd/\epsilon$	0.017
13	sectional area of the foil, m ²	f *b	0.3
14	resistor resistance, Mom	$R=U/I$	30
15	capacitor energy, J	Wco	0.015
16	capacitor energy density, J/m ³	Wc	90
17	energy density of the resistor, J/ m ³	Wr	1206
18	power, energy flow, W	P	67.5
20	energy flux density, W/ m ²	S	3983
19	energy flow rate, m/s	<i>v</i>	3.07
		<i>v_{vac}</i>	44.4
21	pulse density, kg/(s×m ²)	J	421
		J _{vac}	2
22	electromagnetic moment, kg×m/s	M	2.14
		M _{vac}	0.01

Chapter 14. The Structure of the Electromagnetic Field in the Body of a Permanent Magnet

Contents

1. Introduction \ 1
2. Maxwell's equations for a system with magnetic monopoles \ 4
3. The solution of Maxwell's equations (2.6)-(2.9) \ 5
4. Calculation of the domain structure \ 6
5. Domain structure in an external magnetic field \ 7
6. Hypothesis of Moiseev \ 7
7. The structure of the electromagnetic field of a permanent magnet \ 9

1. Introduction

Below being considered a permanent magnet. The solution of Maxwell's equations for a system with magnetic dipoles is proposed. Based on this solution, a formal model of the distribution of magnetic dipoles in the body of a permanent magnet is built.

The study of the magnetic microstructure of permanent magnets is necessary to improve their technical characteristics. For this purpose, in the well-known work, the structure of the distribution of magnetic dipoles in the body of a permanent magnet is studied. However, only experimental methods are used to study the domain structure, namely direct observations using various techniques. As far as the author knows, there is no formal model for the distribution of magnetic dipoles in the body of a permanent magnet. Obviously, such a model should be based on a formal model of the structure of the electromagnetic field of the permanent magnet, which is also absent.

Currently, the most common in modern technology are permanent magnets of the alloy NdFeB, a distinctive feature of which is conductivity. Therefore, a conductive permanent magnet is considered below. A solution is proposed for the Maxwell equations for such a magnet. On the basis of this solution, a formal model is constructed for the distribution of magnetic dipoles in the permanent magnet body.

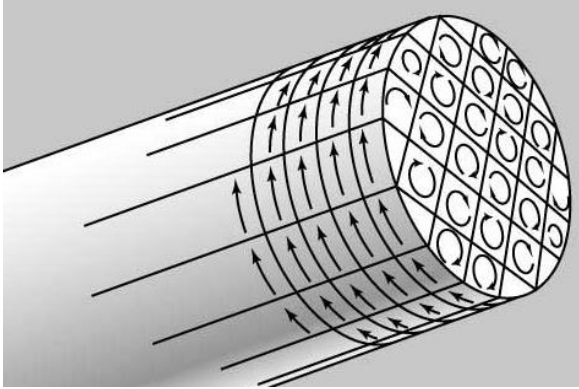

Fig. 1.

The solution found makes it necessary to reconsider the well-established ideas about the structure of the magnetic strengths and the currents in the body of the permanent magnet. It is known, for instance, the idea that the magnetic field of the permanent magnet is formed only by the currents on the surface of the magnet because the currents inside the magnet cancel each other out. This is shown in Figure 1. However, it is difficult to assume that significant currents flow in the surface layer, creating a large induction in modern magnets. And with this explanation, the role of domains in the body of the magnet becomes unnecessary. In reality there are currents in the body of the magnet (as shown below) that flow along three coordinate axes. There are also the magnetic strengths directed along the three coordinate axes. In particular, there are the currents flowing in all the circles of the cylinder. The strength is created by all the domains of the magnet (i.e. the currents forming the domains) and not just the surface domains.

In [152], an experiment of 1839 was described in which a sewing needle was inserted into a solenoid and a hollow cylindrical magnet. In the solenoid, the needle was installed in the center of the solenoid, and in a magnet, it was installed at the pole. This was explained by the fact that in the center and outside the magnetic strengths of the solenoid are opposite, and for the magnet, they coincide because they are determined by the surface currents in the magnet. However, the sewing needle "does not know what is outside." If it behaves as described, then this means that 1) the field is uniform in the solenoid, 2) and in the magnet, the field in the center is equal to zero. And this contradicts the theory of the equivalence of a solenoid and a magnet. However, it is this assumption that is used today in the modeling and design of magnets.

Erroneous ideas arise due to the fact that when analyzing a phenomenon, not all laws of electromagnetism are taken into account. All laws are combined in the set of Maxwell's equations. Consequently, a full analysis of the phenomenon can be done only after the set of Maxwell's equations has been formulated and resolved for the object under study. Meanwhile, this set is not resolved even for copper wire with a current, is not resolved for a magnetized iron rod and, especially, is not solved for the permanent magnet. This gap is eliminated in the proposed work.

Practically the absence of this solution means that the real characteristics of the permanent magnets are described loosely. The rigorous solution obtained here, being applied in the design of the permanent magnets, should certainly improve their quality.

A permanent magnet is usually considered as a ferromagnetic material consisting of a multitude of domains, each of which consists of a large number of atoms and therefore has dimensions of the order of 10^{-2} cm. However, the magnetic properties of the basic forms of carbon (diamond, graphite, nanographite, nanotubes, fullerenes) are known [158]. Organic substances with magnetic properties are also known [159]. In these cases, the magnetic properties manifest individual molecules, and not their conglomerates such as domains.

In connection with the existence of such compounds, permanent magnets can be part of nanostructures and, possibly, in the composition of organisms. The latter is of interest for nanomedicine and nanotechnology. In this connection, it is important to build a mathematical model of a permanent magnet in the general case (and not only for domain structures). However, even to study the domain structure, only experimental methods such as direct observations using various techniques are used. As far as the author knows, there is no formal model for the distribution of magnetic dipoles in the body of a permanent magnet. Obviously, such a model should be based on a formal model of the structure of the electromagnetic field of a permanent magnet, which is also absent.

At present, the idea of the absence of magnetic monopoles is accepted. Therefore, the mathematical model must operate with magnetic dipoles and take into account that the size of the dipole can be arbitrarily small. Below is a solution to the Maxwell equations for the permanent magnet that satisfies these conditions. Based on this solution, a formal model of the distribution of magnetic dipoles in the body of the permanent magnet is built.

2. Maxwell's equations for a system with magnetic monopoles

Maxwell's equations in the case when there is a constant magnetic field with the magnetic strength H and the constant currents of density J have the following forms:

$$\operatorname{rot}(J) = 0, \quad (1)$$

$$\operatorname{rot}(H) - J = 0, \quad (2)$$

$$\operatorname{div}(J) = 0, \quad (3)$$

$$\operatorname{div}(H) = 0. \quad (4)$$

In the case when there are magnetic monopoles with density M , the last equation takes the following form:

$$\operatorname{div}(H) - M = 0. \quad (5)$$

If there are magnetic monopoles of different polarity, then the set of equations can be replaced (by virtue of the linearity of these equations) with two sets of the type

$$\operatorname{rot}(J_1) = 0, \quad (6)$$

$$\operatorname{rot}(H_1) - J_1 = 0, \quad (7)$$

$$\operatorname{div}(J_1) = 0, \quad (8)$$

$$\operatorname{div}(H_1) - M_1 = 0 \quad (9)$$

and

$$\operatorname{rot}(J_2) = 0, \quad (10)$$

$$\operatorname{rot}(H_2) - J_2 = 0, \quad (11)$$

$$\operatorname{div}(J_2) = 0, \quad (12)$$

$$\operatorname{div}(H_2) - M_2 = 0. \quad (13)$$

Suppose that all magnetic monopoles are combined in pairs forming magnetic dipoles. Then

$$M_1 = -M_2 = M. \quad (14)$$

Suppose further that all magnetic dipoles have a size δ and are oriented along the z coordinate. Then

$$M_2(z) = -M_1(z + \delta), \quad (15)$$

$$H_2(z) = -H_1(z + \delta), \quad (16)$$

$$J_2(z) = -J_1(z + \delta). \quad (17)$$

So, the set of Maxwell equations for the system with magnetic monopoles takes the form of equations (6)-(9), (10)-(13), and (15)-(17). Then the algorithm for calculating the electromagnetic system with magnetic dipoles takes the following form:

1. Calculation of the magnetic strengths H_1 and the current densities J_1 (the method of this calculation is described in Chapter 5);

2. Calculation of the distribution of monopoles M_1 . It is important to note that the values of monopoles found here have different signs;
3. Then with the obtained values of the parameters M_1, J_1, H_1 for equations (15)-(17), the other parameters M_2, J_2, H_2 can be also found.
4. Neglecting δ , for the system as a whole we get:

$$H = H_2 - H_1, \quad (18)$$

$$J = J_2 - J_1. \quad (19)$$

3. The solution of Maxwell's equations (2.6)-(2.9).

So, from the previous it follows that for the conductive permanent magnet, the Maxwell equations have the following form:

$$\text{rot}(J) = 0, \quad (1)$$

$$\text{rot}(H) - J = 0, \quad (2)$$

$$\text{div}(J) = 0, \quad (3)$$

$$\text{div}(H) - M = 0 \quad (4)$$

where M is the density of magnetic monopoles (with a sign). Each monopole is one of the poles of a magnetic dipole, and the second pole of this dipole is a monopole of the opposite sign. The dipole is oriented along the z coordinate and has a size of δ .

This set of equations was resolved for the DC wire in Chapter 5. However, in equation (4) of Chapter 5 the free term is absent: $M = 0$. It was shown that equation (4) in the general case is not satisfied. In our case, equation (4) is used to calculate the function M .

4. Calculation of the domain structure

Chapter 5 shows that there is the following formula, which follows from (3.4):

$$m(r) = \frac{h_r(r)}{r} + \dot{h}_r(r) + \frac{h_\varphi(r)}{r} \alpha + \chi h_z(r), \quad (1)$$

Moreover, there are

$$H_z(r, \varphi, z) = h_z(r) \cdot \sin(\alpha \varphi + \chi z). \quad (2)$$

$$M_1(r, \varphi, z) = m(r) \cdot \sin(\alpha \varphi + \chi z). \quad (3)$$

The distribution function of dipoles around a circle of a given radius has the following form:

$$Q(r) = r \cdot m(r). \quad (4)$$

Figure 2 for the conditions of example 1 in Chapter 5 shows functions (1)-(4) and the function of the longitudinal magnetic strength $h_z(r)$.

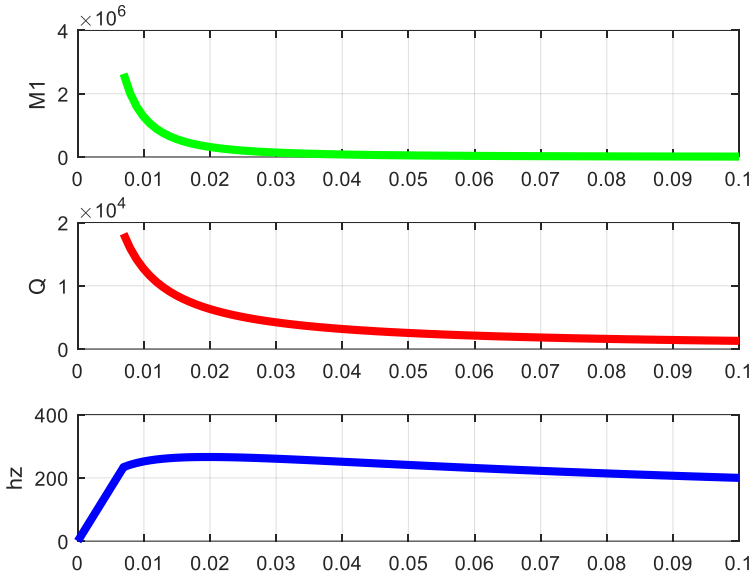

Fig. 2. (fig-5-3-1now.m)

The magnetic charge (2) is at the level of z and belongs to a certain dipole. The opposite charge of the same dipole is at the level $(z + \delta)$ and has the value of

$$M_2(r, \varphi, z) = -m(r) \cdot \sin(\alpha \varphi + \chi(z + \delta)). \quad (3)$$

Note that for small δ , the following relations hold:

$$\sin(\varphi) - \sin(\varphi + \delta) = -\delta \cdot \cos(\varphi), \quad (4)$$

$$\cos(\varphi) - \cos(\varphi + \delta) = \delta \cdot \sin(\varphi). \quad (5)$$

Moreover, as shown in Chapter 5, we obtain:

$$H_r = \delta h_r \text{si}, \quad (6)$$

$$H_\varphi = -\delta h_\varphi \text{co}, \quad (7)$$

$$H_z = -\delta h_z \text{co}, \quad (8)$$

$$J_r = \delta j_r \text{si}, \quad (9)$$

$$J_\varphi = -\delta j_\varphi \text{co}, \quad (10)$$

$$J_z = -\delta j_z \text{co}. \quad (11)$$

Thus, to calculate the electromagnetic field of a ferromagnetic wire, the following algorithm can be applied:

1. The solution of Maxwell's equations (3.1)-(3.4) for calculating functions (2)-(11), as shown in Chapter 5.
2. Calculation of function (3) taking into account equation (1). The resulting function is, in fact, a function of the distribution of magnetic domains. Thus domains

- a. located along the longitudinal axis z of the magnet,
- b. have length δ ,
- c. they have the magnetic monopole M_1 at the level of z and the magnetic monopole $(-M_1)$ at the level of $(z+\delta)$.

The real domain structure should be decomposed into a series of functions (2). The resulting graphical distribution of dipoles can be compared with real observations, which will make it possible to do various extrapolations.

5. Domain structure (DS) in an external magnetic field

The proposed method for calculating the DS extends to the calculation of the DS of a magnetically soft material in an external magnetic field. This field may be variable. As shown in [128], the behavior of the DS in alternating magnetic fields of low frequency (0.1–10 kHz) largely determines the magnetic properties of soft magnetic materials. The proposed method for calculating the DS allows analytically studying

1. the phenomenon of dynamic self-organization of DS in alternating magnetic fields of low frequency,
2. translational motion of the domain structure as a whole often observed in the process of dynamic magnetization reversal,
3. controlled (by external influences) the movement of the domain structure as a whole.

6. Hypothesis of Moiseev

Moiseev [129] proposed a hypothesis about the configuration of the field surrounding a permanent magnet. In this work, numerous observations are analyzed that are accessible to everyone but have not been implemented so far. Based on these observations, conclusions are drawn that have not yet been expressed by anyone.

The essence of the hypothesis is that Moiseev assumes the presence of a flow of energy that describes the "eight" around the permanent magnet shown in Figure 3. Further, Moiseev assumes that the magnet field is obtained by adding up the set of elementary fields of domains, each of which also has an energy flow that describes the "eight" around the domain.

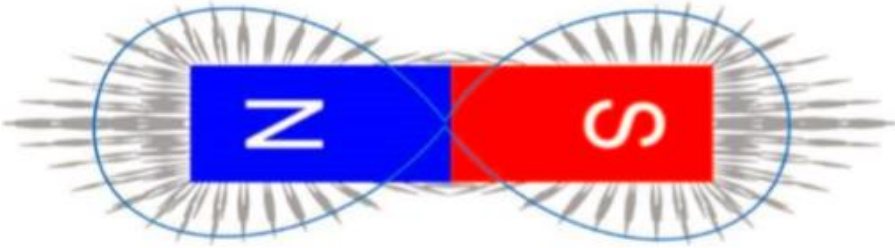

Fig. 3.

Using this hypothesis, Moiseev explains the following:

1. As a result of drawing perpendiculars to the lines of metal filings that are adhered to the magnets, it is produced a figure in the form of an "eight" shown in Figure 3.
2. There is a "neutral zone" of the permanent magnet, where the magnetic field weakens but does not fade out completely.
3. There is a well-known claim that the magnetic lines of force (MLF) form an arc that stretches continuously from one pole to another, forming a field shape around the permanent magnet that resembles a watermelon. But in experiments with the permanent magnet and iron filings, it can be seen that the rays from the sawdust extend straight from the center of each pole, away from the magnet, and there is not even any curvature of them towards the other pole.
4. MLF in the area of the neutral zone change direction by 180 degrees, i.e. MLF have no continuous trajectories stretching from one pole to another.
5. The compass magnetic needle has two declination angles from the exact direction to the pole: in the Western Hemisphere, the compass magnetic arrow has an eastern declination, and in the Eastern - western.
6. It is believed that the shape of the field of the permanent magnet and the field of the coil of the solenoid are identical and similar, in particular, due to the fact that they react equally to other magnets. However, there is one significant difference: the solenoid coil does not have a neutral zone, its field inside is uniform. This is a fundamental difference refuting the similarity of their fields.

7. The structure of the electromagnetic field of a permanent magnet

So, the above solution is obtained for the conductive ferromagnetic wire in the cylindrical coordinates. In Chapter 5f, a solution is found for the wire in the Cartesian coordinate system. Obviously, it can also be extended to a ferromagnetic wire. The conductive permanent magnet can also be considered as a ferromagnetic wire.

Next, we consider another solution to the Maxwell equations in the Cartesian coordinate system for the permanent magnet, referring to the results of Chapter 5f. This chapter shows that for the known parameters such as the constant α , the density of electromagnetic energy w , and the longitudinal strengths h_z , the remaining parameters of the permanent magnet can be found by the following equations:

$$\beta = \alpha, \quad (1)$$

$$\gamma = -\alpha\sqrt{2}, \quad (2)$$

$$h_x = -\frac{h_z}{\sqrt{2}} \pm \sqrt{\frac{3h_z^2}{2} + \mu w}, \quad (3)$$

$$h_y = -h_x - \sqrt{2}h_z, \quad (4)$$

$$j_x = \frac{\gamma}{2}(h_y - h_x), \quad (5)$$

$$j_y = j_x, \quad (6)$$

$$j_z = j_x\sqrt{2}. \quad (7)$$

Consider the example of the permanent magnet, the cross section of which is a square with side A , and the height is B . Let

$$A = \frac{\alpha\pi}{4}, B = 2\pi\gamma = 2\sqrt{2}\pi\alpha. \quad (8)$$

Figures 4 and 5 show the vectors of the magnetic strength H , the current density J , and the energy flux density S constructed on the basis of the solution found in Chapter 5f.

Figure 4 shows the top end face of the magnet and the following functions:

$$J_x(x) = H_x(x) \equiv \sin(\alpha x), \quad (9)$$

$$J_y(x) = H_y(x) = J_z(x) = H_z(x) \equiv \cos(\alpha x), \quad (10)$$

$$S_x(x) = S_z(x) \equiv \sin(2\alpha x), \quad (11)$$

Figure 5 shows the left side of the magnet and the following functions:

$$J_x(z) = H_x(z) = J_y(z) = H_y(z) \equiv \cos(\gamma z), \quad (12)$$

$$J_z(z) = H_z(z) \equiv \sin(\gamma z), \quad (13)$$

$$S_x(z) \equiv \sin(2\gamma z) = -\sin(2\sqrt{2}\gamma z), \quad (14)$$

$$S_z(z) \equiv \cos^2(\gamma z) = \cos^2(2\sqrt{2}\gamma z), \quad (15)$$

In Figures 4 and 5, the horizontal arrows represent the S_x vectors, the vertical arrows represent the S_z vectors. The sums of these vectors $S_{xz} = S_x + S_z$ are also shown.

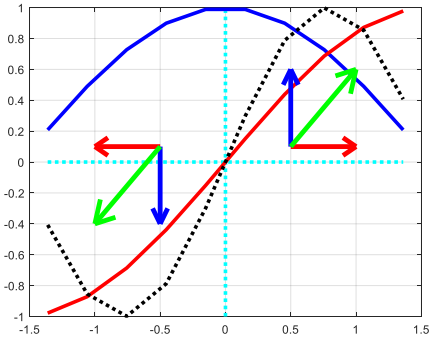

Fig. 4. (PostMagnitNow.m)

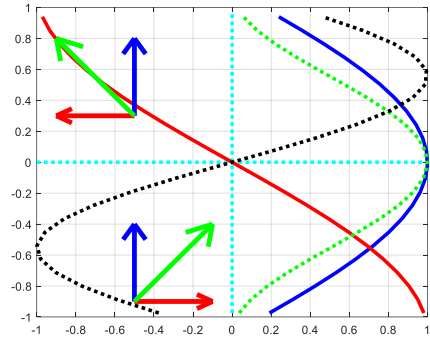

Fig. 5. (PostMagnitNow.m)

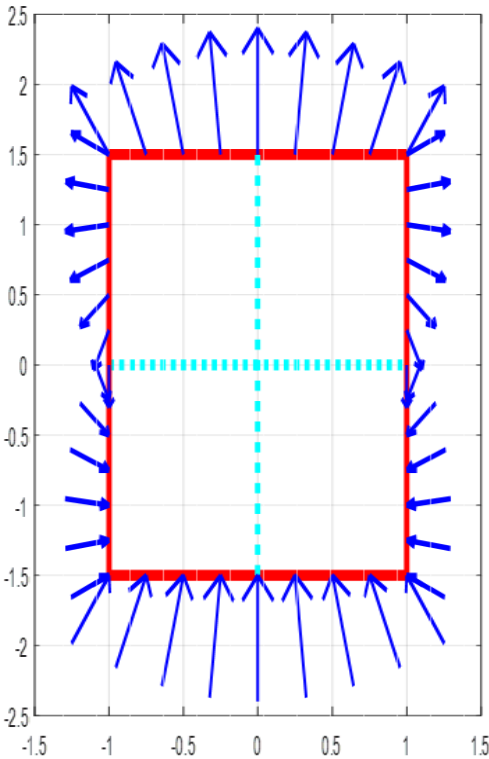

Fig. 6. (PostMaghnitNow.m)

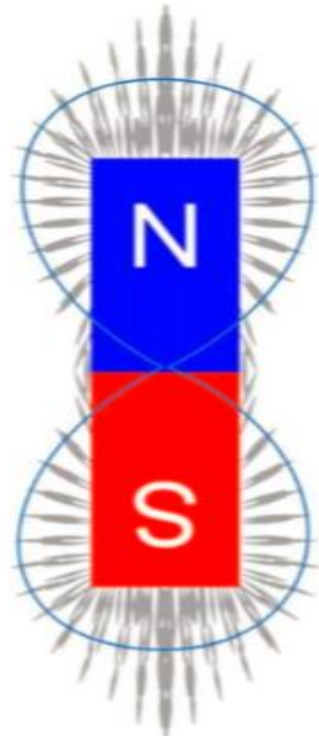

Fig. 7.

Figure 6 shows the magnetic strength $H_{xz} = H_x + H_z$ on the surface of the magnet in the XOZ plane. For comparison and convenience, Figure 7 shows the “eight” shown in Figure 3.

Figure 8 shows the energy flux densities $S_{xz} = S_x + S_z$ on the magnet surface in the XOZ plane. The horizontal lines at the levels (0.75, 0, -0.75) correspond to the values of γ at which $S_z(x) = 0$. Thus, in this permanent magnet there are two independent closed trajectories of the energy flux S_{xz} . These trajectories are indicated by the arrows.

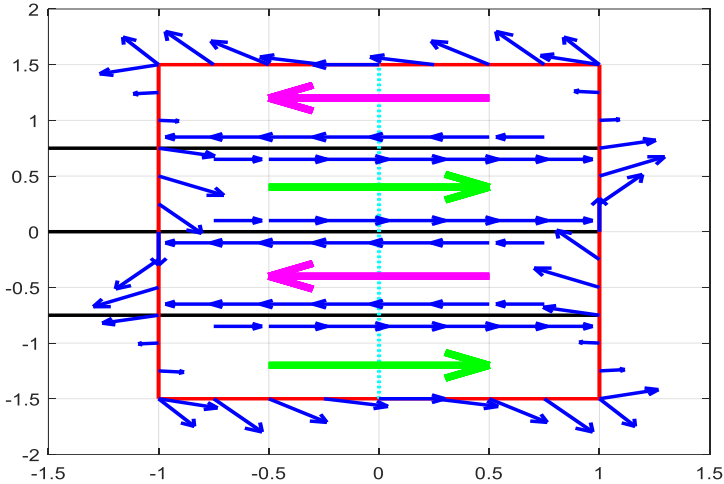

Fig. 8. (PostMaghnitNow.m)

One can see that

1. in the center along the vertical, the longitudinal strength $H_z = 0$ that is observed as the “neutral zone” of the permanent magnet,
2. at the end of the magnet, the diagram of the longitudinal strength has a convex shape of H_z that corresponds to the observations,
3. the ends of the vectors of the total magnetic strength ($\vec{H}_z + \vec{H}_y$) form the shape of the “Moiseev eight”,
4. there is the circular flow of energy $\vec{S}_{x,y}$ along the perimeter of the magnet (in the cylindrical magnet there is the circular flow of energy \vec{S}_φ).

These conclusions from the mathematical model correspond to the observations of Moiseev, although they are unexpected for the traditional theory.

Chapter 15. Fourth Electromagnetic Induction

Contents

1. Introduction \ 1
2. Forces and fluxes of electromagnetic energy in a conductive body \ 1
3. Types of electromagnetic induction \ 3

1. Introduction

Below there are different options for electromagnetic induction. An induction caused by some change of the electromagnetic energy flow can be stood out. This induction is called the fourth electromagnetic induction [19]. The dependence of the emf of this induction on the density of electromagnetic energy flux and wire parameters is determined. The mechanism of the flow of energy entering the wire and compensating for heat loss is considered.

2. Forces and fluxes of electromagnetic energy in a conductive body

The law of conservation of momentum for a body interacting with an electromagnetic field can be written in the following form [13]:

$$-\frac{\partial}{\partial t}(J) = \frac{\partial}{\partial t}(pV) + gV, \quad (1)$$

where

J is the mechanical momentum of the device,

p is the density of the electromagnetic momentum,

g is the flux density of the electromagnetic momentum,

V is the volume of the body, in which the electromagnetic field momentum interacts with the body, i.e. with charges in this volume.

It is important that this formula be applicable only to a body in which there are free electrical charges. Such a body is electrically conductive.

Equation (1) means that the total momentum flux in the entire volume of the field is equal to zero.

It is known that the force acting on the body is

$$F = -\frac{\partial}{\partial t}(J). \quad (2)$$

Consequently,

$$\frac{F}{V} = \frac{\partial p}{\partial t} + g. \quad (3)$$

It is known [13] that

$$p = \frac{S}{c^2}, \quad (4)$$

$$g = \frac{S}{c}, \quad (5)$$

where S is the density of the electromagnetic energy flux. Combining (3)-(5), we find:

$$\frac{F}{V} = \frac{\partial}{\partial t}\left(\frac{S}{c^2}\right) + \frac{S}{c}. \quad (6)$$

Thus, if the electrically conductive body is in the flow of electromagnetic energy S , then force (6) acts on it, depending only on the flow of electromagnetic energy S . This force also exists at a constant flow S , and then

$$\frac{F}{V} = \frac{S}{c}. \quad (7)$$

In is possible that the flow of electromagnetic energy propagates in the body with the relative dielectric constant ϵ and magnetic permeability μ . In this case, the previous formulas must operate with the speed c_s of electromagnetic wave in the substance instead of the speed of light in a vacuum. So, this speed c_s is defined by

$$c_s = \frac{c}{\sqrt{\epsilon\mu}}. \quad (8)$$

Consider the case when the vectors of electric and magnetic fields' strengths are perpendicular. Then instead of formula (6) we get:

$$\frac{F}{V} = \frac{\partial}{\partial t}\left(\frac{S\epsilon\mu}{c^2}\right) + \frac{S\sqrt{\epsilon\mu}}{c}. \quad (9)$$

If, moreover, the field is constant, then

$$\frac{F}{V} = \frac{S\sqrt{\epsilon\mu}}{c}. \quad (10)$$

3. Types of electromagnetic induction

The law of electromagnetic induction is known.

$$e = \frac{\partial \Phi}{\partial t}, \quad (1)$$

where Φ is the magnetic flux, e is the emf. It is also known [13] that this electromagnetic induction, namely the appearance of emf in the conductor may occur as a consequence of the fulfillment of the following two laws:

$$F = q(v \times B), \quad (2)$$

$$\nabla \times E = -\frac{\partial B}{\partial t}. \quad (3)$$

In accordance with this there are the following two types of electromagnetic induction:

The first type is case (3) when in the conductor emf appears due to a change in the magnetic flux. This is the *electromagnetic induction caused by a change in the magnetic flux*.

The second type is case (2) when the emf in the conductor appears under the action of the Lorentz magnetic force due to the mutual displacement of the wire and the magnetic field without changing the magnetic flux. This is the *electromagnetic induction caused by the Lorentz force*.

The third type of electromagnetic induction arising in the unipolar Faraday generator is also known: *unipolar electromagnetic induction*. In this generator, the motor rotates a permanent magnet, and an emf is generated at the radius of the magnet. This emf is determined by the following formula:

$$e = \omega BL^2/2, \quad (4)$$

where

B is the induction of a permanent magnet,

L is the length of the radius of the magnet,

ω is the angular velocity of rotation.

This formula was obtained by different methods: in [22] using the theory of relativity and in [26] on the basis of the law of conservation of momentum.

It is widely known that the current is induced in a conductor located in the flow of energy of an electromagnetic wave. We call *electromagnetic induction caused by the flow of electromagnetic energy* the fourth type of electromagnetic induction. The Emf of this induction is equal to the density of the forces acting on the electrical charges and arising with the advent of an electromagnetic energy flux. These forces are defined above

by equations (2.9) and (2.10). Therefore, the fourth emf induction is equal to

$$\varepsilon_4 = \frac{\partial}{\partial t} \left(\frac{S\varepsilon\mu}{c^2} \right) + \frac{S\sqrt{\varepsilon\mu}}{c} \quad (5)$$

or with a constant flow

$$\varepsilon_4 = \frac{S\sqrt{\varepsilon\mu}}{c} \quad (6)$$

Consequently, the electromagnetic flux allows the charges (charge current) to overcome the resistance to movement and does work (which is partially converted into heat). This force acts on all charges (electrons) in the wire, directed in the direction of the current (i.e. it does not act on the wire as a whole). Thus, the flow creates an emf that “drives the current”.

On the other hand, Chapter 5 shows that the electromagnetic energy density is a function of the current density J and the magnetic field strength H , which is expressed by the following formula, see in (5.3.3):

$$S = \rho JH, \quad (7)$$

where ρ is the electrical resistance. Thus, each element of the wire with a current radiates a flux of electromagnetic energy. This energy flow penetrates the next element of the wire and creates in this element a force acting on the charges, i.e. the determined above emf fourth electromagnetic induction. This force creates current. In this way,

the current in the next element arises as a result of the flow of electromagnetic energy created by the current of the previous element.
--

Note that the energy flow created by some current element can NOT affect this current element, just like the charge field cannot affect this charge.

Such a view agrees well with the well-known fact that the lightning has a leader moving at a speed of several hundred kilometers per second, see in Section 7 of Chapter 10.

There is one experiment that can serve as an experimental evidence for the existence of this induction [17].

Chapter 16. Electromagnetic Keeper of Energy and Information

Contents

1. Introduction \ 1
2. The description of the existing experiments \ 2
3. Mathematical model \ 4
4. Energy \ 7
5. The other forms of keeper \ 8
6. The capacitor keeper \ 8
7. About preserving force \ 9
8. The vacuum keeper \ 9
9. Conclusion \ 11
10. Suggested experiment \ 11

1. Introduction

One well-known experiment demonstrates the preservation of the integrity of a certain structure in the absence of visible binding forces. This experiment was first described in 1842 but still has not found a scientific explanation. However, an interest in the problem continues unabated, which is reflected in Internet publications. Based on the solution of Maxwell's equations, this work shows that the experiment is explained by the conservation of electromagnetic energy inside the structure and the appearance of a keeping electromagnetic wave.

Based on this solution, it is shown that the design can be made not only on the basis of ferromagnetics (known fact) but also in the form of a capacitor. The keepers themselves can have various forms. Understanding of the "principle of action" of the keeper, the existence of both magnetic and electrical keepers, the diversity of its forms can be the basis of various technical inventions [160].

Further it is shown that such designs can save not only energy but also information. This fact provides a basis for explaining such phenomena as the mirages of the past (battles with the sounds of battle). These phenomena are astounding and await their rigorous scientific explanation.

Observations show that mirages do not change their position on the Earth. The stability of the position of the keeper is of particular interest.

The work shows that the stability of the position of a mirage can be explained by the fact that there are a standing electromagnetic wave, a pulsating flow of electromagnetic energy, and a pulsating electromagnetic mass in the mirage zone. The center of mass does not change position, which ensures a stable position of the guardian on the ground. Thus, mirages can be viewed as experimental evidence of the existence of an electromagnetic mass. The very fact of such evidence can be a stimulus for the development of new technical devices using electromagnetic mass.

2. The description of the existing experiments

The following experiment is described in Internet [38, 133] and shown in Figure 1. Take two bars of soft magnetic iron with a notch in the center of the bar along the entire length of the bar. These bars are folded so as to form a common channel. A wire is inserted into this channel, and a current pulse is passed through it. After this, the bars are held together by some kind of force. The force disappears when the wire passes a current pulse equal to the previous one in magnitude and duration but in opposite direction. A prerequisite for the occurrence of the effect is accurate processing of adjacent surfaces, preventing the appearance of an air gap between them.

Khmelnik [39] has already addressed this problem. Here it is described a more rigorous justification of this phenomenon. Now an interest in this problem has returned, thanks to the experiments carried out by Beletsky [133] shown in Figure 2. However, this topic is not discussed in the scientific literature. Therefore, this work has few references to published papers. But in fact, this topic has a long history: in the book by [134] (1842) a similar design was considered. Figure 3 [134] shows a detachable electromagnet. The loads are suspended to it after switching on the electrical current. However, after turning off the electrical current, the electromagnet does not disintegrate.



Fig. 1.

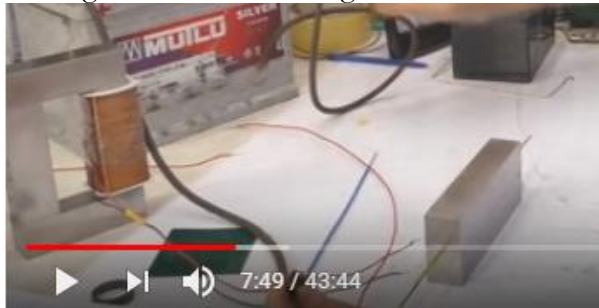

Fig. 2.

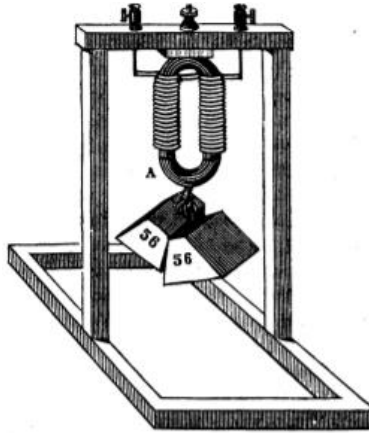

Fig. 3.



Fig. 4.



Fig. 5.

The effect cannot be explained by diffusion because the bars in Figures 1 and 2 are applied to each other without pressure and “stick out” when the reverse impulse is turned on. Also, the effect cannot be explained by magnetic attraction because the material of the bars is magnetically soft and does not preserve magnetization.

There are other experiments that demonstrate the same effect. Figure 4 shows an electromagnet that retains the force of attraction after the current is turned off. It is assumed that Ed Leedskalnin used such electromagnets during the construction of the famous Coral Castle that is shown in Figure 5 [38].

In all these structures, at the time of current shutdown, electromagnetic energy has some significance. This energy can be dissipated by radiation and heat loss. However, if these factors are not

significant (at least in the initial period) the electromagnetic energy must be conserved. Next, we consider the conditions, under which the electromagnetic energy is stored for an arbitrarily long time, and the corresponding construction can be considered as an electromagnetic energy keeper.

3. Mathematical model

Consider a cube consisting of a soft magnetic material with a certain absolute magnetic permeability μ and absolute dielectric constant ε . Let an electromagnetic wave with energy W_0 arise as a result of some impact in the cube. There are no heat losses in the cube, and the radiation of the cube (including thermal ones) is negligible. After some time, the wave parameters μ , ε , W_0 will take stationary values determined by the size of the cube. These parameters are the electric field strength and the magnetic field strength as functions of the Cartesian coordinates (x, y, z) and time (t) , i.e. $E(x, y, z, t)$ and $H(x, y, z, t)$, respectively.

For this cube, in order not to radiate from the surface of the xOy , it is necessary that at all points on this surface

$$E_x H_y = 0 \text{ and } E_y H_x = 0. \quad (0a)$$

Similar conditions should be observed on xOz and yOz surfaces, i.e.

$$E_x H_z = 0 \text{ and } E_z H_x = 0, \quad (0b)$$

$$E_y H_z = 0 \text{ and } E_z H_y = 0. \quad (0c)$$

So, the functions $E(x, y, z, t)$ and $H(x, y, z, t)$ must satisfy conditions (0) and the Maxwell's set of equations. We consider equations of the following form:

$$\left\{ \begin{array}{l} \frac{\partial H_z}{\partial y} - \frac{\partial H_y}{\partial z} - \varepsilon \frac{\partial E_x}{\partial t} = 0 \\ \frac{\partial H_x}{\partial z} - \frac{\partial H_z}{\partial x} - \varepsilon \frac{\partial E_y}{\partial t} = 0 \\ \frac{\partial H_y}{\partial x} - \frac{\partial H_x}{\partial y} - \varepsilon \frac{\partial E_z}{\partial t} = 0 \\ \frac{\partial E_z}{\partial y} - \frac{\partial E_y}{\partial z} + \mu \frac{\partial H_x}{\partial t} = 0 \\ \frac{\partial E_x}{\partial z} - \frac{\partial E_z}{\partial x} + \mu \frac{\partial H_y}{\partial t} = 0 \\ \frac{\partial E_y}{\partial x} - \frac{\partial E_x}{\partial y} + \mu \frac{\partial H_z}{\partial t} = 0 \\ \frac{\partial E_x}{\partial x} + \frac{\partial E_y}{\partial y} + \frac{\partial E_z}{\partial z} = 0 \\ \frac{\partial H_x}{\partial x} + \frac{\partial H_y}{\partial y} + \frac{\partial H_z}{\partial z} = 0 \end{array} \right. \quad (1)$$

This set of equations is solved in Chapter 2d in a general way. The solution represents the following functions:

$$E_x(x, y, z, t) = e_x \cos(\alpha x) \sin(\beta y) \sin(\gamma z) \sin(\omega t) \quad (2)$$

$$E_y(x, y, z, t) = e_y \sin(\alpha x) \cos(\beta y) \sin(\gamma z) \sin(\omega t) \quad (3)$$

$$E_z(x, y, z, t) = e_z \sin(\alpha x) \sin(\beta y) \cos(\gamma z) \sin(\omega t) \quad (4)$$

$$H_x(x, y, z, t) = h_x \sin(\alpha x) \cos(\beta y) \cos(\gamma z) \cos(\omega t) \quad (5)$$

$$H_y(x, y, z, t) = h_y \cos(\alpha x) \sin(\beta y) \cos(\gamma z) \cos(\omega t) \quad (6)$$

$$H_z(x, y, z, t) = h_z \cos(\alpha x) \cos(\beta y) \sin(\gamma z) \cos(\omega t) \quad (7)$$

where

$e_x, e_y, e_z, h_x, h_y, h_z$ are the constant amplitudes of the functions,
 $\alpha, \beta, \lambda, \omega$ are the constants.

In our particular case, we also assume that the origin is in the center of the cube, whose half-edge length is

$$R = 1/a, \quad (8a)$$

Moreover, an equation of the form

$$\sin(\alpha \cdot a) = 0, \sin(\beta \cdot a) = 0, \sin(\gamma \cdot a) = 0, \quad (8b)$$

provides the fulfillment of condition (0).

Because the treated case is symmetric, it is possible to write down the following qualities:

$$\alpha = \beta = \gamma. \quad (8c)$$

Then from the general solution written in Chapter 2d (see formulas (11)-(15) and (18) there), we find:

$$h_z = 0, \quad (10)$$

$$h_y = -h_x, \quad (11)$$

$$e_x = -\frac{h_x \alpha}{\varepsilon \omega}, \quad (12)$$

$$e_y = e_x, \quad (13)$$

$$e_z = -2e_x, \quad (14)$$

$$h_x = -\frac{3e_x \alpha}{\mu \omega}, \quad (15)$$

$$\omega = \alpha \sqrt{\frac{3}{\varepsilon \mu}}. \quad (16)$$

It is easy to see that these values also satisfy the seventh and eighth equations.

It is possible to write strength (2) in the following form:

$$E_x(x, y, z, t) = e_x \sin(\omega t) E_x^T(x, y, z) \quad (17)$$

where the trigonometric function $E_x^T(x, y, z)$ is

$$E_x^T(x, y, z) = \cos(\alpha x) \sin(\beta y) \sin(\gamma z) \quad (18)$$

Similarly, we can rewrite the functions from (3) to (7), taking into account formulas (11), (13) to (16), as follows:

$$E_y(x, y, z, t) = e_x \sin(\omega t) E_y^T(x, y, z) \quad (19)$$

$$E_z(x, y, z, t) = -2e_x \sin(\omega t) E_z^T(x, y, z) \quad (20)$$

$$H_x(x, y, z, t) = -\frac{\varepsilon\omega}{\alpha} e_x \cos(\omega t) H_x^T(x, y, z) \quad (21)$$

$$H_y(x, y, z, t) = \frac{\varepsilon\omega}{\alpha} e_x \cos(\omega t) H_y^T(x, y, z) \quad (22)$$

$$H_z(x, y, z, t) = 0 \quad (23)$$

Let us now find the square of the module of total strengths. They read as follows:

$$E^2 = (E_x^2 + E_y^2 + E_z^2) = 6e_x^2 \sin^2(\omega t) E_T^2(x, y, z) \quad (24)$$

$$H^2 = (H_x^2 + H_y^2) = 2\left(\frac{\varepsilon\omega}{\alpha}\right)^2 e_x^2 \cos^2(\omega t) H_T^2(x, y, z) \quad (25)$$

where

$$E_T^2(x, y, z) = (E_x^T(x, y, z))^2 + (E_y^T(x, y, z))^2 + (E_z^T(x, y, z))^2 \quad (26)$$

$$H_T^2(x, y, z) = (H_x^T(x, y, z))^2 + (H_y^T(x, y, z))^2 \quad (27)$$

Consider now the following relationship

$$q = \frac{E_T^2(x, y, z)}{H_T^2(x, y, z)} \quad (28)$$

It can be shown that under condition (9) the ratio does not depend on the size of the cube and the value of a . This means that the amplitudes of the total strengths are referred to as

$$\frac{E^2}{H^2} = \frac{6e_x^2 q}{2\left(\frac{\varepsilon\omega}{\alpha}\right)^2} \quad (29)$$

or

$$\frac{|E|}{|H|} = \frac{\sqrt{6q}}{\frac{\varepsilon\omega}{\alpha}\sqrt{2}} = \frac{\alpha\sqrt{3q}}{\varepsilon\omega} \quad (30)$$

or

$$|H| = \frac{\varepsilon\omega}{\alpha\sqrt{3q}} |E| \quad (31)$$

For a cube, one has to use the following value:

$$q = 3 \quad (32)$$

As a result, one can obtain the following equality:

$$|H| = \frac{\varepsilon\omega}{3\alpha} |E| \quad (33)$$

4. Energy

Energy density is equal to

$$W = \varepsilon E^2 + \mu H^2 \quad (34)$$

or, taking into account the previous formulas, one can get

$$W = 6\epsilon e_x^2 \sin^2(\omega t) E_T^2(x, y, z) + 2\mu \left(\frac{\epsilon\omega}{\alpha}\right)^2 e_x^2 \cos^2(\omega t) H_T^2(x, y, z) \quad (35)$$

Given (28), we write

$$W = E_T^2(x, y, z) e_x^2 \left(6\epsilon \sin^2(\omega t) + \frac{2\mu}{q} \left(\frac{\epsilon\omega}{\alpha}\right)^2 \cos^2(\omega t) \right) \quad (36)$$

If the frequency satisfies the condition

$$6\epsilon = \frac{2\mu}{q} \left(\frac{\epsilon\omega}{\alpha}\right)^2 \quad (37)$$

or, subject to (29), the condition

$$\omega = \frac{3\alpha}{\sqrt{\mu\epsilon}} \quad (38)$$

then the reader can get

$$W = 6\epsilon E_T^2(x, y, z) e_x^2 \left(\sin^2(\omega t) + \cos^2(\omega t) \right) \quad (39)$$

or

$$W = 6\epsilon E_T^2(x, y, z) e_x^2 \quad (40)$$

Therefore, if the frequency satisfies condition (32), then the energy of the electromagnetic wave does not depend on time. The total energy in the cube volume is as follows:

$$\bar{W} = \iiint_{x,y,z} W dx dy dz = 6\epsilon e_x^2 \iiint_{x,y,z} E_T^2(x, y, z) dx dy dz \quad (41)$$

So, there is such a frequency of an electromagnetic wave, in which the energy of an electromagnetic wave in construction is kept constant.

With (33) and (38), it follows that in this case there is the following:

$$|H| = \frac{\epsilon}{3\alpha} \frac{3\alpha}{\sqrt{\mu\epsilon}} |E| = |E| \sqrt{\frac{\epsilon}{\mu}} \quad (42)$$

With (18) and (23), it follows that

$$E = |E| \sin(\omega t) \quad (43)$$

$$H = |H| \cos(\omega t) \quad (44)$$

This means that under these conditions there is a standing electromagnetic wave in the cube. The standing wave does not radiate through the cube edges.

5. The other forms of the keeper

A keeper in the form of a cube under condition (9) was considered above. For the existence of another form of a keeper, it is sufficient to make sure that for this form, the value of relationship (28) does not depend on the body size and the value of a . The author has checked the fulfillment of this condition for a cylinder with a height equal to the diameter and for a sphere. The value of $q = 3$ was used for the cylinder, sphere, and cube. For bodies with a central point of symmetry

(parallelepiped, cylinder of arbitrary height, cylinder with an elliptical base, ellipsoid) this condition is also satisfied. However, $q \neq 3$ for them.

6. The capacitor keeper

From the foregoing, it follows that the values of the parameters ε and μ do not affect the mere existence of the phenomenon under consideration. Therefore, there may exist a capacitor keeper in addition to the magnetic keeper. This can actually exist.

The experiment is known, which is (in our opinion) the indisputable proof that the energy of a capacitor is stored in a dielectric material [122]. For experiments, the installation was made of two capacitors, between which the dielectric material moves. As a result, in one capacitor the dielectric material is charged with energy from a high-voltage source, and from the other capacitor this energy is extracted. The capacitor discharges through the discharger. The author of the experiment explains this phenomenon by charge transfer in the dielectric material. This is not surprising: the question of where the charge is stored is still being debated. Similar but much less spectacular experiments have so far been explained by the fact that a film of moisture retains charge on the surface of the dielectric material after the removal of the metal plate [123]. However, the following issues are not considered: how this film manages to arise and how water manages to charge. Thus, electromagnetic energy, which is stored in a charged capacitor as a stationary flux of electromagnetic energy when removing the plates, is converted into standing wave energy (see Chapter 7).

Let's assume that the dielectric material of the capacitor consists of two untied parts. We charge it and remove the charged plates. Both parts of the dielectric material will be held by some force. The author did not perform such an experiment that can be performed in the future.

7. About preserving force

The density of electromagnetic energy is equal, as is known, to the internal pressure in the body where this energy is located. The pressure force is directed towards the inside of the body (also, for instance, as in a charged capacitor). When a body is stretched, its energy increases because its volume increases at a constant energy density. Therefore, to stretch the body the reader has to do some work. The tensile force is equal to the force of the internal pressure in the direction of the force. This means that the “destroyer” needs to overcome such a force. This is what is demonstrated in these experiments.

8. The vacuum keeper

We emphasize once again that the value of the parameters ε and μ does not affect the mere existence of the phenomenon under consideration. Therefore, in addition to the magnetic and capacitor keeper, there may be a vacuum keeper.

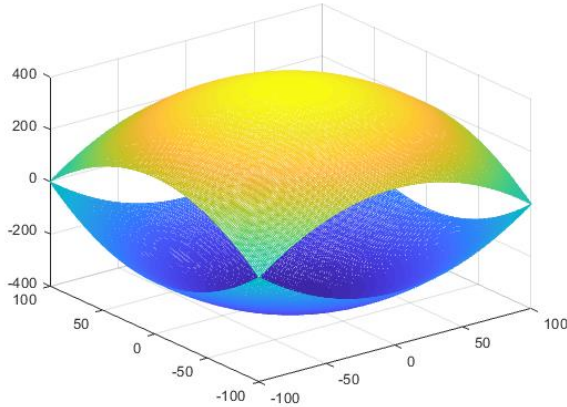

Fig. 6.

Concerning the vacuum keeper, it is difficult to imagine the keeper in a clearly limited volume, for instance, in the form of a vacuum cube with clear walls. The vacuum keeper may be, for example, in a volume that gradually decreases with distance from the center. Such a volume can be represented in the form of a rather flat ellipsoid. Another variant of the vacuum volume can be described by the following formula:

$$z = 2N - \frac{4}{N} \left(\left(x - \frac{N}{2} \right)^2 - \left(y - \frac{N}{2} \right)^2 \right) \quad (45)$$

where N is a constant, $N = 200$ in Figure 6. It is interesting to note that in this case $q = 3$.

The electromagnetic wave in the vacuum energy saver can be modulated. In this case, this energy keeper becomes the information keeper. When such a keeper is destroyed, electromagnetic energy is emitted in the form of a modulated wave.

There have been cases of radio programs of the 1930s (songs, speech), mirages of the past (battles with the sounds of battle). These phenomena are striking and inexplicable [136]. It is important to note that they are tightly linked to the terrain. For example, in [137] we read: *“Every year only in the Sabara there are 160,000 all kinds of mirages. Moreover, the emerging paintings are immediately applied to Bedouin cards ... This is a necessary measure, as there have been cases when whole caravans died because of mirages.”*

Considering the previous conclusions, these phenomena can be explained by the fact that the modulated electromagnetic wave is memorized in a certain amount. This volume can be destroyed and then this wave is emitted from it in the form of radio transmission or in the form of video transmission. It is possible that this volume may be partially destroyed and then such transfers will be repeated. It is also possible that this volume can expand with increasing energy (due to incoming energy from the outside) without changing the frequency of the wave. Then the recoverable information keeper is formed.

In this case, a question arises, to which my attention drew: how is the keeper volume held in place? If the keeper is implemented in an air dielectric, then the keeper should be moved by air flows. If it is realized in the vacuum volume, then the Earth must leave this volume in its motion.

The answer appears to be as follows. As mentioned, the electromagnetic energy W is stored in the custodian's volume and there is a standing electromagnetic wave. Consequently, in this volume the flow of electromagnetic energy S pulses. Together with this flow there is a momentum p of the electromagnetic wave and a mass m of the electromagnetic wave. These values are related to each other and with the speed c of propagation of electromagnetic energy [13], it is possible to write down the following definitions:

$$S = Wc \quad (46)$$

$$p = \frac{W}{c} \quad (47)$$

$$m = \frac{p}{c} \quad (48)$$

Therefore,

$$m = \frac{W^3}{S^2} \quad (49)$$

This electromagnetic mass pulsates along with the flow of electromagnetic energy. However, the center of mass does not change position. Consequently, the volume of the custodian can be considered as the volume of the pulsating mass with a constant center of gravity. This mass is held in place by gravity and does not interact with the material mass, i.e. cannot be shifted by air flow. This ensures a stable position of the keeper on the ground.

Another question arises, to which my attention also drew: why are there no mirages of events that took place on the Earth hundreds or thousands of years ago? The answer, apparently, is that the keeper is partially destroyed by the radiation of electric energy in the form of a modulated wave, and the recovery of energy may be incomplete. These factors limit the life of the custodian.

9. Conclusion

It follows from the written above that an electromagnetic wave can exist in a cube such that the cube faces do not radiate and there are no heat losses: there are no electric currents even in an iron cube. Under these conditions, an electromagnetic wave can exist for an arbitrarily long time. This cube saves

- magnitude of electromagnetic energy,
- structural integrity.

Such a keeper may have a different, noncubic form and is made of various materials. It can be implemented as a body or as a certain amount of a vacuum.

Together with energy the keeper can store information.

The keeper can have not only man-made but also natural origin. A vivid example is the keepers of information about events on the Earth, manifesting themselves as mirages of past battles. Such guardians prove, moreover, the existence of a mass of electromagnetic wave.

10. Suggested experiment

Consider an experiment to determine the energy stored in the keeper, see in Figure 7 where

M is the magnetic circuit made of an electrically conductive magnetically soft material, separated along the Z plane,

S is the solenoid, through which current I flows,

K is the measuring coil,

R_1 is the resistor whose terminals are soldered to the points of the magnetic circuit M near the plane Z and through which current i flows,

R_2 is the resistor whose terminals are connected to the measuring coil K .

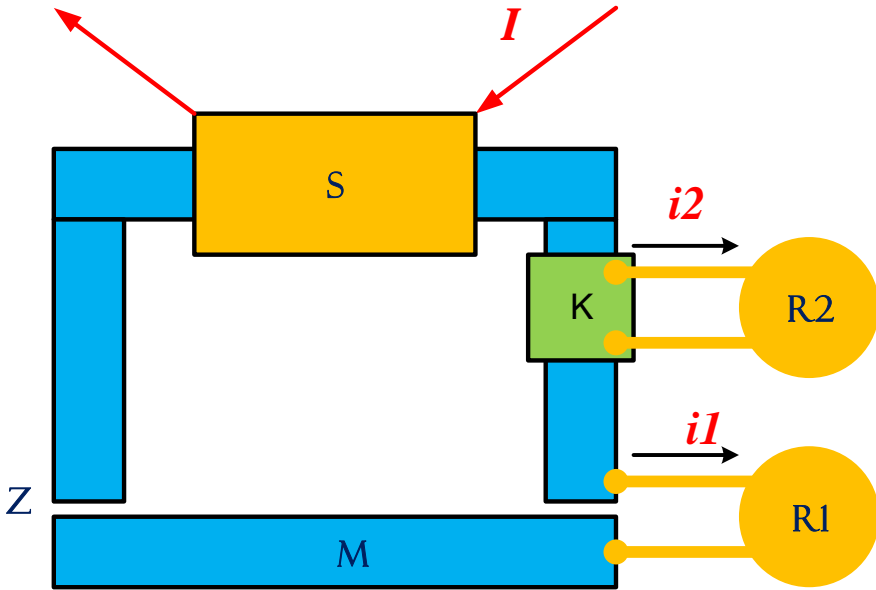

Fig. 7.

1. First, the magnetic circuit M closes along the Z plane so that there is no gap, and a current I is supplied to the solenoid S . In this case, magnetic energy is stored in the magnetic circuit M

$$W = 0.5\mu\mu_0N^2I^2V, \quad (1)$$

where

- μ_0 is the absolute magnetic permeability of a vacuum,
- μ is the relative magnetic permeability of the magnetic circuit,
- N is the number of turns of the solenoid,
- V is the volume of the magnetic circuit.

2. After that, the current is turned off and thereby the energy keeper is created.

3. Then the magnetic circuit is opened. When the keeper is destroyed, its energy is released during time T with power $P(t)$. Let's pretend that

$$P(t) = P_0e^{-at}. \quad (2)$$

Then

$$W = \int_0^T P_0e^{-at} dt. \quad (3)$$

The value of instantaneous power decreases by $e^3 \approx 20$ times at

$$at \approx 3. \tag{4}$$

Therefore, we will assume that

$$a = 3/T. \tag{5}$$

Then from (3) we can find P_o .

Assume that all the energy is released by the current $i(t)$ in the resistor R . Then

$$i(t) = \sqrt{P(t)/R} \tag{6}$$

It is advisable to perform the following three experiments.

In experiment 1, resistor R_1 is used as a resistor, and the other resistor is turned off.

In experiment 2, the resistor R_2 is used as a resistor, and the other resistor is turned off.

In experiment 3, both resistors are turned on.

To analyze the results of experiments, it is necessary to determine

$$W, R, T \tag{7}$$

and compare the observed current damping curve $i(t)$ with the calculated curve (6).

In experiment 3, the energy will be distributed between both resistors. A comparison of the currents in these resistors allows the reader to (possibly) make a conclusion about the form in which the energy is stored: in the form of electromagnetic field energy or in the form of magnetic energy.

In the future, it would be possible to modulate the current I in the solenoid with a high-frequency current. In this case, it would be possible to detect this high-frequency component in current i .

Chapter 16a. To the Question of Intranuclear Forces

Contents

1. Introduction \ 1
2. Energy, the Flow of Energy and Momentum of the Electromagnetic Field of the Cube \ 3
3. Integration and Disintegration of the Cube \ 4
4. Electromagnetic Wave Holder \ 5
5. Internuclear Interactions \ 6
6. About the spin of nucleon and nucleus \ 7
7. Zennon effect \ 7

1. Introduction

Chapter 16 is devoted to considering an experiment demonstrating preservation the integrity of the assembled structure in the absence of visible fastening forces. It is shown that the experiment may be explained by the appearance of electromagnetic energy inside the structure. Next they consider such body shapes, for which the electromagnetic energy is stored indefinitely. Outlined below has been partially published in [170].

Most detailed description is given to a cube consisting of magnetically soft and dielectric material with absolute permeability μ and absolute permittivity \mathcal{E} . Suppose that as a result of some effects in a cube there occurred an electromagnetic wave with energy W_o . There are no thermal losses in the cube, and no radiation of the cube. In particular, in order for the cube not to radiate from the surface xoy , it is necessary that the following equalities were true for all the points of this surface:

$$E_x H_y = 0 \text{ and } E_y H_x = 0. \quad (1)$$

These conditions allow finding the solution of Maxwell's equations. In Chapter 16 it is shown that this solution has the following form:

$$E_x(x, y, z, t) = e_x \cos(\alpha x) \sin(\alpha y) \sin(\alpha z) \sin(\omega t), \quad (3)$$

$$E_y(x, y, z, t) = e_y \sin(\alpha x) \cos(\alpha y) \sin(\alpha z) \sin(\omega t), \quad (4)$$

$$E_z(x, y, z, t) = e_z \sin(\alpha x) \sin(\alpha y) \cos(\alpha z) \sin(\omega t). \quad (5)$$

$$H_x(x, y, z, t) = h_x \sin(\alpha x) \cos(\alpha y) \cos(\alpha z) \cos(\omega t), \quad (6)$$

$$H_y(x, y, z, t) = h_y \cos(\alpha x) \sin(\beta y) \cos(\alpha z) \cos(\omega t), \quad (7)$$

$$H_z(x, y, z, t) = h_z \cos(\alpha x) \cos(\alpha y) \sin(\alpha z) \cos(\omega t), \quad (8)$$

$$\sin(\alpha \cdot a) = 0, \sin(\beta \cdot a) = 0, \sin(\gamma \cdot a) = 0, \quad (9)$$

where the origin is located in the cube's center, and

$$R = (l/a), \text{ is the length of half cube's edge,} \quad (10)$$

$e_x, e_y, e_z, h_x, h_y, h_z$ are the constant amplitudes of
the functions,

α, β, γ are the constant parameters,

ω is the angular frequency,

$$h_z = 0, \quad (11)$$

$$h_y = -h_x, \quad (12)$$

$$e_y = e_x, \quad (13)$$

$$e_z = -2e_x, \quad (14)$$

$$e_x = -\frac{h_x \alpha}{\varepsilon \omega}, \quad (15)$$

$$h_x = -\frac{3e_x \alpha}{\mu \omega}, \quad (16)$$

$$\omega = \alpha \sqrt{\frac{3}{\varepsilon \mu}}. \quad (17)$$

2. Energy, the Flow of Energy and Momentum of the Electromagnetic Field of the Cube

The full energy W_o stored in the cube can be found by integrating functions (3)-(8) over the volume of the cube.

As the energy average over time is

$$W_o = \iiint_{x,y,z} (E_x^2 + E_y^2 + E_z^2 + H_x^2 + H_y^2 + H_z^2) dx dy dz,$$

then

$$W_o = ma^3 (e_x^2 + e_y^2 + e_z^2 + h_x^2 + h_y^2 + h_z^2),$$

where m is a certain constant, or, given by equations (15), (13), and (14),

$$W_o = ma^3(6e_x^2 + 2h_x^2)$$

and next, given (15),

$$W_o = ma^3h_x^2\left(6\left(\frac{\alpha}{\varepsilon\omega}\right)^2 + 2\right)$$

and, given (17),

$$W_o = 2ma^3h_x^2\left(\frac{\mu}{\varepsilon} + 1\right). \quad (20)$$

This formula is related to every frequency from the spectrum of natural frequencies with the amplitude $h_x(\omega)$.

The flow of electromagnetic energy circulates along the faces of the cube by the planes perpendicular to the z -axis. The integral of this flow density S over the volume V of the cube is proportional to the momentum P of the electromagnetic field in the volume of a cube. This is true because, as the reader knows, in the SI system there is:

$$\frac{dP}{dV} = \frac{1}{c^2} S = \frac{1}{c^2} [\overline{E} \times \overline{H}]. \quad (21)$$

By the law of conservation of momentum, the cube retains its integrity because the integral of electromagnetic energy flow density changes with the change in the shape of the cube.

3. Integration and Disintegration of the Cube

Consider four identical cubes, each of which stores energy W_o and momentum P_o . When these cubes come into contact, a single cube with doubled half-edge can form. Then, in accordance with (10), upon contact, these cubes can form one cube with a double half-edge.

$$a' = a/2 \quad (22)$$

According to (19), the frequency spectrum of the combined cube will change as follows:

$$\omega' = \frac{k\pi}{a'} \sqrt{\frac{3}{\mu\varepsilon}} = 2\omega. \quad (23)$$

There will appear frequencies that were absent in the primary cube. It means that the energy flow will be passing through the contacting faces of the primary cubes. This additional flow preserves the integrity of the combined cube, because when disconnecting the primary cubes the

Chapter 16a. To the Question of Intranuclear Forces

integral of flow density of electromagnetic energy is changed and the law of conservation of momentum is violated.

The appearance of additional frequencies means also that the total momentum of the combined cube is larger than the sum of impulses of the merged cubes. This excess is equal to the momentum of forces that are uniting the cubes. The work of these forces is converted into electromagnetic energy of the combined cube, which thus becomes larger than the total energy of primary cubes.

The inverse process is also possible: it is the disintegration of the cube into four separate cubes with preservation of their total energy. The disintegration may be caused, for instance, by the fact that the cube got into the area of another electromagnetic wave, which disturbed the balance inside the cube. Moreover, the total momentum of disconnected cubes becomes smaller than the momentum of the combined cube. "Surplus" is released in the form of electromagnetic energy flow. Along with this, naturally, the energy is released, i.e. with the cubes disintegration there appears a certain radiation.

4. Electromagnetic Wave Holder

Thus, in the body of a certain form there may exist an electromagnetic wave with a spectrum of natural frequencies (determined only by the form and material of the body). This wave does not emerge beyond the body volume and does not attenuate ever in an electroconducting body. This wave also retains the once received energy W_o and the momentum P_o . We shall denote such a body as Electromagnetic Wave Holder, further abbreviated as EWH.

Several identical EWH may integrate in such way that in the integrated body an electromagnetic wave is created with an expanded spectrum of natural frequencies and with total energy and momentum greater than the sum of the energies and momenta of the combined EMK. We will call such a process a EWH synthesis.

An EWH can disintegrate into several EWH with reduced spectrum of natural frequencies and with total energy and momentum smaller than the sum of energies and momenta of the created EWH. This leads to radiation. We shall call such process the disintegration of EWH. Initiation of this disintegration can be caused by the fact that EWH enters the external electromagnetic field. The energy of this external field can be a lot less than the energy of internal electromagnetic field of EWH.

Chapter 16a. To the Question of Intranuclear Forces

In Chapter 16, EWH in various geometric forms are considered. It is possible that there can exist some forms that are not completely in contact during the synthesis, with some gaps.

The existence of EWH is confirmed by the experiments described in Chapter 16. In the Internet, the reader can find many reports of metal objects sticking to the human body. This phenomenon can also be explained by the appearance of an electromagnetic wave in a limited volume at some contact area between the "human body and the metal object." Another confirmation of the existence of EWH is the so-called black ball lightnings [174, 175]. Such lightnings do not radiate energy and are practically invisible. These lightnings can be found only in the case of an accidental contact. In general, this contact ends dramatically.

5. Internuclear Interactions

Concerning the nuclear forces, it is known, for instance, from [165] that

- A. The nuclear forces are short acting (their range is of the order of 10^{-13} cm.)
- B. The interaction forces of nucleons do not depend on the nucleon's charge.
- C. Nuclear forces are not central (they cannot be presented as directed along the line connecting the centers of interacting nucleons).
- D. Nuclear forces have the ability to saturation (this means that each nucleon in the nucleus interacts with a limited number of nucleons).
- E. There exist the so-called "magic numbers" (2, 8, 20, 50, 82, 126) of nucleons in the nucleus, under which the nuclei are most resistant to nuclear decomposition.

All these facts have no explanation, which are formulated in [166] as follows: "at present there still is no complete theory of so-called nuclear forces, i.e. forces acting between nuclear particles (nucleons) and holding them together as part of an atomic nucleus.

By analogy with the above, it can be assumed that the **nucleons in nuclei of elements are linked NOT by nuclear forces but by the overall flow of electromagnetic energy**. One must assume that in a nucleon there is an electromagnetic wave with a certain natural frequency and energy, i.e. a single nucleon represents an EWH, and the nucleus is an EWH obtained by the synthesis of EWH nucleons.

Chapter 16a. To the Question of Intranuclear Forces

On this assumption, we can explain several features of intranuclear interactions and other phenomena.

1. Nucleons must be in a mutual "contact", so that their total electromagnetic wave was concentrated in total volume, see above p. A.

2. The charge of nucleons does not matter, see above p. B.

3. Nuclear forces are not central (see above p. C). Generally, the interaction cannot be explained by the forces acting among nucleons.

4. The nucleons must have a certain form to be able to "contact" with other nucleons. The number of nucleons contacting with a given nucleon is restricted, see above p. D. The number of nucleons contacting with the given one is determined by their form and cannot be arbitrary even within certain limits, see above p. E.

5. Nuclear fusion (formation of heavier nuclei of lighter nuclei) is a synthesis of EWH. This synthesis can occur without substantial expenditure of energy, i.e. it is cold nuclear fusion. This apparently occurs in living organisms [167]. This, for instance, explains that the body of hen is constantly producing calcium (for the formation of egg shell), not getting it in the food consumed, and producing it from virtually any set of substances coming from food.

6. We can assume also the existence of nuclear disintegration (formation of lighter nuclei from heavier nuclei). The facts mentioned in the previous p. 5 can be interpreted as the nuclear disintegration: it all depends on the initial and final products.

7. Nuclear decay, as the release of electromagnetic energy of EWH-nuclei, can occur without significant external energy expenditure - see above. This may explain the so-called pyrokinesis [168], in which a person for no apparent reason flares and immediately burns, although all the surrounding objects and clothes remain intact.

We return again to the question of the existence of electromagnetic waves inside nucleons and nuclei. It is known that gamma radiation source (having a frequency $> 3 \cdot 10^{18}$ Hz) can be nuclei and particles, as well as the nuclear reaction and the reaction between the particles. Conversely, gamma radiation can be absorbed by atomic nuclei and is able to cause transformation of the particles [169]. Consequently, inside the core the electromagnetic wave of the same frequency must also exist. While the energy flow of these waves in closed volume of EWH-nucleus - it is stable, and the waves are not observed. EWH-nucleus stores energy. With the disintegration of this EWH-nucleus the energy is released in the form of gamma radiation. In the absorption of gamma radiation, the internal

energy increases and is redistributed in the volume of EWH-nucleus. This can lead to the disintegration of the nucleus into smaller nuclei.

As follows from the above, the EWH-nucleons inside the EWH-nucleus exchange by the flow of electromagnetic energy (electromagnetic waves). At high frequency of the waves, they acquire corpuscular character. Thus, EWH-nucleons inside the EWH-nucleus exchange particles. This is quite consistent with the existing theory of the exchange interaction, according to which the interaction between the nucleons inside the nucleus is the result of emission and absorption of π -mesons.

6. About the spin of nucleon and nucleus

The momentum P and the angular momentum J are linked by the following relation:

$$J = r \times P. \quad (25)$$

Similarly, the corresponding bulk densities are linked by the following relation:

$$\frac{dJ}{dV} = r \times \frac{dP}{dV}. \quad (26)$$

With equations (21) and (26), it follows that

$$\frac{dJ}{dV} = \frac{1}{c^2} [r \times S] \quad (27)$$

or

$$J = \frac{1}{c^2} \int [r \times S] dV. \quad (28)$$

From the above it follows that there is a circular flow of electromagnetic energy in both the nucleon and the nucleus. This flow determines angular momentum (28). Probably, namely this angular momentum represents both the spin of the nucleon and the nuclear spin.

7. Zennon effect

This effect, as is known, consists in the fact that the decay time of particles increases when they are observed and, in the limit, the particles do not decay if they are often monitored. The mystery of this phenomenon fades, if you clarify what is meant by the term "observation". It turns out that observation is the irradiation of a particle (for instance, a laser beam). Irradiation is the transfer of energy. Thus, the decay time of particles increases if energy is transferred to them.

Chapter 16a. To the Question of Intranuclear Forces

Let us return to the statement that the particle is the guardian of the electromagnetic wave. The energy of this wave is gradually radiated, which is observed as the decay of a particle. When a particle is irradiated during observation, the energy is replenished and the decay of the particle slows down.

Chapter 16b. About the Interaction of Nanoparticles

Nanotechnology operates with nanoparticles, which are an isolated solid-phase object that has a clearly defined boundary with the environment. The dimensions of nanoparticles in all three dimensions are from 1 to 100 nm. Nanoparticles are close to those objects that are considering in supramolecular chemistry. In this field of knowledge, the forces that bind individual molecules are considered. It is believed that intermolecular interaction consists of weak electromagnetic interactions. The energy of such interactions is inversely proportional to the sixth power of the distance between the molecules. Obviously, the interaction of nanoparticles with clear boundaries cannot be due to such forces.

The interaction of nanoparticles leads to one property that greatly interferes with their use: they can stick together. This problem has to be solved in the production of ceramics and metallurgy [176]. Obviously, this property is explained by the attraction of nanoparticles with different chemical compositions.

However, another property is also known, which can be explained by the repulsion of nanoparticles with different chemical compositions. In [177], it was shown that polycationic organic nanoparticles can disrupt model biological membranes and living cell membranes at nanomolar concentrations.

Thus, the theory of interaction of nanoparticles should explain both the attraction and repulsion of nanoparticles. Also, the forces of such interaction should significantly exceed the forces of intermolecular interaction.

Chapter 2d gives a solution to the Maxwell equations for a variable voltage capacitor in Cartesian coordinates. In the system of Cartesian coordinates x, y, z and time t , the solution of these equations in the SI system has the following form:

$$E_x(x, y, z, t) = e_x \cos(\alpha x) \sin(\beta y) \sin(\gamma z) \sin(\omega t), \quad (2)$$

$$E_y(x, y, z, t) = e_y \sin(\alpha x) \cos(\beta y) \sin(\gamma z) \sin(\omega t), \quad (3)$$

$$E_z(x, y, z, t) = e_z \sin(\alpha x) \sin(\beta y) \cos(\gamma z) \sin(\omega t). \quad (4)$$

$$H_x(x, y, z, t) = h_x \sin(\alpha x) \cos(\beta y) \cos(\gamma z) \cos(\omega t), \quad (5)$$

$$H_y(x, y, z, t) = h_y \cos(\alpha x) \sin(\beta y) \cos(\gamma z) \cos(\omega t), \quad (6)$$

$$H_z(x, y, z, t) = h_z \cos(\alpha x) \cos(\beta y) \sin(\gamma z) \cos(\omega t), \quad (7)$$

where E_r , E_ϕ , E_z are the components of the electric field strength, H_r , H_ϕ , H_z are the components of the magnetic field strength, $e_x, e_y, e_z, h_x, h_y, h_z$ are the constant amplitudes of the strengths. α, β , and γ are some constants, and ω is the angular frequency. These quantities are related by the following equations:

$$h_z = 0. \quad (8)$$

$$e_x = -e_z \frac{\gamma \alpha}{\alpha^2 + \beta^2}. \quad (9)$$

$$e_y = e_x \frac{\beta}{\alpha}, \quad (10)$$

$$h_y = e_x \frac{\varepsilon \omega}{\gamma}, \quad (11)$$

$$h_x = -e_y \frac{\varepsilon \omega}{\gamma}. \quad (12)$$

$$\gamma = \mu \omega, \quad (13)$$

$$\omega = \sqrt{\frac{\gamma^2 + \alpha^2 + \beta^2}{\varepsilon \mu}}. \quad (14)$$

For given values of the parameters α, β, γ and frequency ω , the amplitudes of the intensities can be determined depending on e_z . It follows from (14) that for $\omega = 0$ the parameters $\alpha = \beta = \gamma = 0$, i.e. the electromagnetic field cannot be static.

In Chapter 2d, it is shown that energy is stored in a capacitor with the following density:

$$w = \frac{\omega^2 \mu^2 \varepsilon}{\alpha^2 + \beta^2} e_z^2. \quad (15)$$

In this case, the density of energy fluxes along the coordinates are determined by the formulas

$$S_x = (e_y h_z - e_z h_y) \cdot \Psi(x, y, z, t) \quad (16)$$

$$S_y = (e_z h_x - e_x h_z) \cdot \Psi(x, y, z, t) \quad (17)$$

$$S_z = (e_x h_y - e_y h_x) \cdot \Psi(x, y, z, t) \quad (18)$$

where

$$\Psi(x, y, z, t) = \sin(2\alpha x) \cos(2\beta y) \sin(2\gamma z) \sin(2\omega t) \quad (19)$$

This means that the energy flux density is oscillating along all the axes in space and time, i.e. there is a space standing wave in a rectangular body.

However, the energy flux can pass through this body. Consider, for instance, the face $x0y$ at $z = z_1$. The energy flux density (18) on this face is determined by function (19) as follows:

$$\Psi(x, y, z_1, t) = \sin(2\alpha x) \cos(2\beta y) \sin(2\gamma z_1) \sin(2\omega t) \quad (20)$$

The energy flux is determined by the integral of this function on the entire $x0y$ face:

$$\Psi_z(z_1) = \iint_{x,y} \Psi(x, y, z_1, t) dx dy = \sin(2\gamma z_1) \sin(2\omega t) \iint_{x,y} \sin(2\alpha x) \cos(2\beta y) dx dy \quad (21)$$

The energy flux on the opposite face $x0y$ at $z = z_2$ is determined by the following integral:

$$\Psi_z(z_2) = \sin(2\gamma z_2) \sin(2\omega t) \iint_{x,y} \sin(2\alpha x) \cos(2\beta y) dx dy. \quad (22)$$

From (18), (20), and (21) we find the energy flux flowing through the capacitor along the z -axis if ($z_2 < z_1$):

$$\bar{S}_z = (e_x h_y - e_y h_x) \cdot (\sin(2\gamma z_2) - \sin(2\gamma z_1)) \sin(2\omega t). \quad (23)$$

It follows from the solution found that

1. There is a combination of parameters, in which the energy of the capacitor is not radiated. Consider, for example, a cube with parameters $\alpha = \beta = \gamma$. If the length R of the cube's half-edge is such that $\sin(\alpha \cdot R) = 0$, $\sin(\beta \cdot R) = 0$, $\sin(\gamma \cdot R) = 0$, then all the energy flux densities on the faces of the cube are equal to zero, see in equations (2)-(7). In this case there is no radiation.

2. An external energy flow can pass through the capacitor volume without changing its internal energy (as shown above). This flow is the active power that passes through the capacitor.

3. The formulas are valid for any values of μ and ϵ . Therefore, a capacitor with a certain energy and a standing wave in the capacitor volume can exist in a vacuum.

4. In the absence of external energy flows, the capacitor retains its integrity because it does not radiate, and the energy density is preserved while maintaining the shape, see in equation (15).

5. From p.p. 3 and 4 it follows that in some body, and even in a vacuum, a keeper of energy and information can exist. This is considered in detail in Chapter 16. It is also shown in Chapter 16 that a standing electromagnetic wave possessing the above properties can have a very diverse form.

6. Now it is possible to suppose that the nanoparticle stores the indicated electromagnetic wave. In the absence of external energy flows, such a single nanoparticle retains its shape and electromagnetic energy.

7. Suppose that a portion of external energy was expended to combine two nanoparticles. Then this portion of energy will go into the energy of the combined nanoparticle. We call this portion the binding energy of the conglomerate of two nanoparticles. Thus, the energy of a

conglomerate of two particles is greater than the sum of the energies of these particles. Consequently, the conglomerate is more stable than individual particles because it is necessary to first apply the binding energy for the destruction of the conglomerate. This can explain the adhesion of nanoparticles (as discussed above).

8. Obviously, the binding energy of particles for different materials is different. Now suppose that two particles of different materials come together and a conglomerate of these particles is formed. If these materials do not mix, then conglomerate 21 should enter the environment of conglomerates 1 or 2. Obviously, it will enter the environment of conglomerates 1, if the binding energy of material 1 is higher than the binding energy of material 2. This can explain the above-mentioned fact that organic nanoparticles can destroy living cells (see also [178]).

Chapter 16c. Information Transfer in Biological Systems by Water and Air

Contents

1. Introduction \ 1
2. The electromagnetic volume standing wave \ 1
3. Electromagnetic standing wave in the molecules of water, nitrogen, and oxygen \ 2
4. Information transfer in water and air \ 4
5. Bio-organism communities \ 6
6. Solaris \ 8
7. Distributed brain \ 9
8. Conclusion \ 11

1. Introduction

It is shown that in molecules of water and air there can exist an electromagnetic bulk standing wave of high frequency. This wave can be modulated by the organs of the bioorganism. A wave modulated in this way can propagate through the water and air and affect the organs of another bioorganism. It is shown that such a wave propagates without energy loss. Based on this, it is shown that a highly organized structure comparable in reasonableness with the brain of an animal can exist in the air. Such a structure may be the collective brain of a community of bioorganisms.

2. The electromagnetic volume standing wave

It was shown in [1, 2] (as a consequence of solving Maxwell's equations) that an electromagnetic standing wave can exist in a limited volume of a vacuum, i.e. the electromagnetic volume standing wave. This volume may have a variety of shapes. In Cartesian coordinate system, the solution can be written in the following expressions:

$$E_x(x, y, z, t) = e_x \cos(\alpha x) \sin(\beta y) \sin(\gamma z) \sin(\omega t), \quad (2)$$

$$E_y(x, y, z, t) = e_y \sin(\alpha x) \cos(\beta y) \sin(\gamma z) \sin(\omega t), \quad (3)$$

$$E_z(x, y, z, t) = e_z \sin(\alpha x) \sin(\beta y) \cos(\gamma z) \sin(\omega t), \quad (4)$$

$$H_x(x, y, z, t) = h_x \sin(\alpha x) \cos(\beta y) \cos(\gamma z) \cos(\omega t), \quad (5)$$

$$H_y(x, y, z, t) = h_y \cos(\alpha x) \sin(\beta y) \cos(\gamma z) \cos(\omega t), \quad (6)$$

$$H_z(x, y, z, t) = h_z \cos(\alpha x) \cos(\beta y) \sin(\gamma z) \cos(\omega t), \quad (7)$$

where E_r, E_ϕ, E_z are the components of the electric field strength, H_r, H_ϕ, H_z are the components of the magnetic field strength, $e_x, e_y, e_z, h_x, h_y, h_z$ are the constant amplitudes of the strengths, α, β, λ are the constants, ω is the angular frequency. These quantities are related by the following equations:

$$h_z = 0. \quad (8)$$

$$e_x = -e_z \frac{\gamma \alpha}{\alpha^2 + \beta^2}. \quad (9)$$

$$e_y = e_x \frac{\beta}{\alpha}, \quad (10)$$

$$h_y = e_x \frac{\varepsilon \omega}{\gamma}, \quad (11)$$

$$h_x = -e_y \frac{\varepsilon \omega}{\gamma}. \quad (12)$$

$$\gamma = \mu \omega, \quad (13)$$

$$\omega = \sqrt{\frac{\gamma^2 + \alpha^2 + \beta^2}{\varepsilon \mu}}. \quad (14)$$

The constants α, β, γ for a cube must satisfy the following equality:

$$\alpha = \beta = \gamma. \quad (15)$$

The length of the half-edge of the cube is defined as

$$R = \frac{\pi}{\alpha}. \quad (16)$$

Then the formula for the angular frequency in a vacuum takes the following form:

$$\omega = \frac{c\pi}{R} \sqrt{3}, \quad (17)$$

where $c \approx 3 \times 10^8$ m/s is the speed of light in a vacuum.

A standing wave is not emitted through the faces of the cube and in the absence of external energy flows, such a wave retains its energy, frequency, and volume shape. This electromagnetic wave can be modulated at a lower frequency. In this case, this volume turns into a **keeper of energy and information**. In [2, 3, 4], some well-known experiments and natural phenomena are considered, which serve as proof of the existence of such a keeper.

3. Electromagnetic standing wave in the molecules of water, nitrogen, and oxygen

It is possible to assume that a water molecule is a volume that stores a standing wave. In this case, the standing wave is stored in the space

between the oxygen and (two) hydrogen atoms, i.e. **in a vacuum**, see in Figure 1.

Molecules of nitrogen and oxygen in the air are also the volume that stores a standing wave. In this case, the standing wave is stored in the space between the atoms of these molecules, i.e. in a vacuum.

Organic molecules are combined into organs in such a way that the relative position of these molecules remains unchanged. In this case, a **free vacuum space** with linear dimensions of about 3×10^{-9} m remains between the molecules. A standing wave also appears in this stable volume.

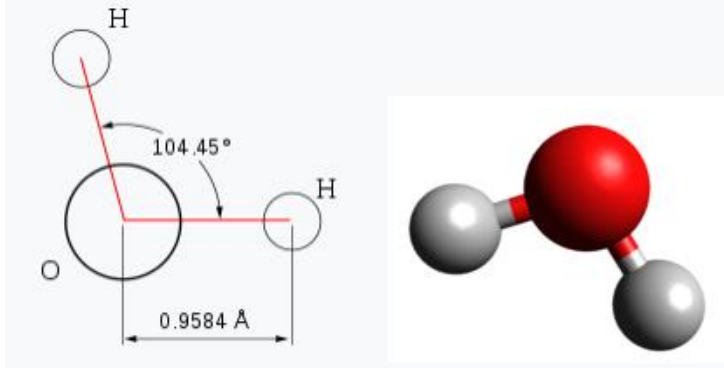

Fig. 1.

Thus, it is possible to indicate stable volumes where a standing electromagnetic wave can be located. These options are listed in Table 1. In a first approximation, we assume that these volumes have a cubic shape with the length of the half-edge R . This value is easily determined by the known linear sizes of the listed volumes, see in Table 1.

Since the body standing electromagnetic wave in all these cases is in a vacuum, the frequency of this wave can be determined by formula (17). The linear frequency f is related to this cyclic frequency ω by the following relation:

$$\omega = 2\pi f. \quad (20)$$

With equations (17) and (20), we find that

$$f = \frac{\omega}{2\pi} = \frac{c}{2R} \sqrt{3}. \quad (21)$$

We can also determine the wavelength γ from (21):

$$\gamma = \frac{c}{f} = \frac{2R}{\sqrt{3}}. \quad (22)$$

Thus, wavelength (22) and the half-edge of the cubic region of the existence of a standing wave are related as follows:

$$R \approx \frac{\gamma\sqrt{3}}{2}. \quad (23)$$

Table 1.

	Water	Nitrogen	Oxygen	Biological organ
	H_2O	N_2	O_2	
The distance between the molecules [m]	3×10^{-9}	3×10^{-9}	3×10^{-9}	3×10^{-9}
Molecule Size [m]	3×10^{-10}	3×10^{-10}	3×10^{-10}	10^{-8}
Location of the standing wave region	Between oxygen and hydrogen atoms	Between nitrogen atoms	Between oxygen atoms	Between organic molecules
Atom radius, $\text{pm} = 10^{-12} \text{ m}$	53 pm	56 pm	48 pm	
Interatomic distance $\text{\AA} = 10^{-10} \text{ m}$	0.9584 \AA	1.095 \AA	1.2074 \AA	
R [m]	5×10^{-11}	5×10^{-11}	6×10^{-11}	1.5×10^{-9}
ω [s^{-1}]	10^{19}	10^{19}	1.2×10^{19}	5×10^{16}
f [Hz]	1.5×10^{18}	1.5×10^{18}	1.8×10^{18}	10^{16}
γ [m]	2×10^{-10}	2×10^{-10}	2.4×10^{-10}	3×10^{-8}

4. Information transfer in water and air

We preliminary note the following. It is known that electromagnetic radiation interacts with molecules of a substance, causing radiation or absorption of electromagnetic radiation by molecules of a substance at certain frequencies [188]. Therefore, the molecules of a substance can interact through electromagnetic radiation. A multiple enhancement of the effect of such an interaction appears when the eigenfrequencies of the emitting and absorbing molecules coincide. Therefore, we can assume the existence in the body of generators of a certain frequency GF and receiver-analyzers of frequency AF.

At the same time, numerous works are known, in which it is shown that all organs of animals and humans emit electromagnetic waves. These emissions are used in medical diagnostics.

The distance between the molecules of water and air is constantly changing. However, the distance and volume between the molecules of organic matter in the body remain constant. This volume is usually filled with so-called **free water**, which is located in the intercellular spaces, vessels, vacuoles, organ cavities. Such water flows from the cells when they are dissected (and therefore called **free**). The volumes of the standing wave (with frequency ω_v) in water molecules are simultaneously in the intermolecular volume of the standing wave of organic matter (with frequency ω_o). For brevity, these waves will be called the ω_v -wave and the ω_o -wave, respectively. Since $\omega_o \ll \omega_v$, the ω_v -wave is modulated by the frequency of the ω_o -wave.

So, **free water molecules contain a modulated standing wave**, which we will call the ω_{vo} -wave. The frequency of the ω_o -wave depends on the type of surrounding organic molecules and on their state. This wave is polychromatic because the region of this wave is not cubic. The shape of this region affects the wave spectrum in the ω_{vo} -wave. However, the shape of this region depends on both the type of organic molecules surrounding this region and the state of these molecules. It can also be assumed that there is a GF generator (mentioned above) in the generating organ. It can be used as a modulator of the ω_v -wave. Therefore, we can say that a water molecule with a ω_{vo} -wave carries information about the state of a particular organ. We will call such molecules **information molecules of water**. The organ that generates such molecules will be called the **generating organ**.

One way or another, the generating organ forms the information molecules of water.

So, free water contains informational molecules. Free water serves to transfer substances from the environment to the cell, and vice versa. Therefore, **free** water with informational molecules is mixed with the **surrounding** water. Information frequencies are emitted by an informational molecule because a water molecule can only retain its frequency ω_v . If an informational molecule enters the surrounding water, then this radiation of the informational molecule enters the neighboring **noninformational** molecules of the surrounding water. The latter at the same time become informational. In this way, information is distributed from the biological organism through the surrounding water. Of course, part of the radiation does not find the receiver molecule and is lost in space. However, the organ-transmitter works constantly and therefore, it

can be assumed that the concentration of information molecules is large in a large area surrounding the organ-transmitter.

Suppose that two organisms A and B live in the same aquatic environment. Suppose further that an informational molecule from a certain generating organ A (belonging to organism A) enters another organ B (belonging to organism B). Suppose that organ B has a frequency receiver-analyzer AF mentioned above. Then the information radiation of this molecule can be recognized and organ B will carry out the corresponding reaction. Thus, organism B received information from organism A and reacted to this information.

So, in an aquatic environment, organisms can exchange information. In the same way, organisms can exchange information in the air. Indeed, from table 1 it follows that the nitrogen and oxygen molecules have similar characteristics with water molecules, namely the size of the molecule and the interatomic distance. Volumes filled with air can be on the surface of the body. For example, regular microroughness on the wings of beetles can create such volumes. The role of free water is played by “free air”. Each peculiar shape of such volumes determines its frequency of the ω_o -wave. In this case, the beetle continuously generates a spectrum of ω_o -waves specific for this species. This transfer of information is used in the search for partners for procreation.

5. Bio-organism communities

So, bio-organisms located in an aqueous or air environment can exchange information over long distances **without the cost of energy to transmit information**. At the same time, there are no reasons prohibiting such an exchange of information between bio-organisms of various types, for example, from a predator to a person who can feel the approach of a predator. There are also no reasons prohibiting such an exchange of information between bio-organisms, one of which lives in water and the other in the air.

A special class is made up of such organisms that can exist only in the form of communities with the obligatory exchange of information without any of tactile, visual, acoustic, olfactory contacts. I immediately recall ants and bees but the humans are probably also from this class of biological organisms.

In [192], the behavior of the anthill is described and, based on the analysis of numerous observations and experiments, it is convincingly

shown that the **anthill has a brain**. The role of neurons in this brain is performed by ants. A distributed brain exists, however, as the author notes, "many years of research on ants (and other collective insects) have not found any powerful information transfer systems." This question was asked in the first book on biological radiocommunication [193], where the author writes, "Only one causes a feeling of deep surprise. This is an insignificantly small power of the energy radiated by the brain during the act of transmitting feelings and experiences to a distance." We show that in our case there is an answer to these questions.

In technical systems, the power of the carrier frequency in a modulated wave decreases with distance. At the same time, the power of the modulating frequency decreases, i.e. this power is a part of the carrier frequency power. It can be argued that while maintaining the power of the carrier frequency, regardless of the distance, the power of the modulating frequency is also preserved. We can say that in this case, the receiver is always next to the transmitter. However, in technical systems, it is impossible to ensure such proximity. In our case, the carrier frequency (the frequency of the ω_v -wave) is evenly distributed in space. The modulating frequency of the ω_o -wave "glides" along with the carrier frequency. Attenuation can only be caused by the fact that the carrier frequency is quantized in space. In this case, the ω_o -wave "glides" along the islands-molecules - carriers of the carrier frequency, attenuating in the voids between them. However, repeated repetition of the ω_o -wave with a time shift (and therefore, a phase) at the input of the receiver allows it to restore the signal with a high accuracy. As observations on the same anthill or bugs looking for love show, communication efficiency persists for kilometers.

The foregoing is illustrated in Figure 2, where the following parameters are shown:

1. the ω_v -wave,
2. the ω_o -wave,
3. the modulated ω_{vo} -wave obtained if the standing ω_o -waves would cover space without gaps,
4. modulated wave is the ω_{vo} -wave obtained when the standing ω_o -waves are located in space with gaps.

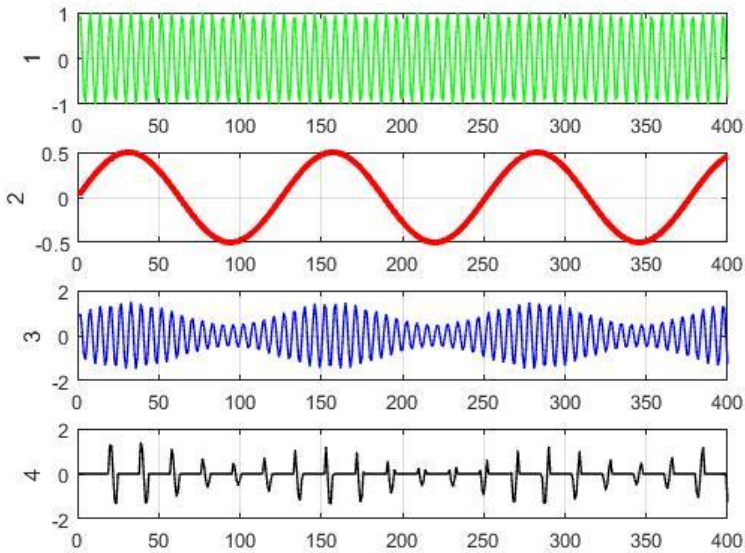

Fig. 2.

A volume filled with water or air can be created by inanimate nature. Such a volume will also transmit information to the environment. Transmit aimlessly ... However, there may be organisms that need just such information to trigger some internal processes. I immediately recall the pyramids, amulets, etc.

6. Solaris

In [194], Stanislaw Lem describes an ocean that covers the entire surface of the planet and has a highly developed mind. Lem briefly describes the most common “*Civit-Witta hypothesis, according to which the ocean is the result of a sharp transition (under the influence of external conditions) from a solution of weakly reacting chemicals to the stage of the “homeostatic” ocean, bypassing all the earth’s developmental stages, bypassing the formation of single and multicellular organisms, the evolution of plants and animals. In other words, the ocean did not adapt, like terrestrial organisms, for hundreds of millions of years to environmental conditions, so that only after such a long time give rise to a rational race but became the master of the environment immediately.*”

Stanislaw Lem is silent about another hypothesis, according to which “*the development of the ocean began in the era of the emergence of social insects. One of the species of ants changed its habitat from land to marine. Things went well. Sea ants quickly mastered the underwater lifestyle, learned to grow small pink*

translucent jellyfish. The colonies of these jellyfish were durable elastic structures with internal chambers and labyrinths, and piercing channels through which water flowed. The structures sprouted deep into the ocean but did not overshadow the sunlight for underwater inhabitants. The walls of the structures pulsed from the continuous movements of jellyfish. On the surface of the ocean, they were islands of bizarre architecture, sometimes mobile, and sometimes motionless and extremely resistant to ocean waves. Ants lived inside the structures and it was their control of the jellyfish that ensured the stability or movement of the structures. The size of the islands and the distances between them varied widely. Nevertheless, the islands were a single organism that could change configuration depending on weather conditions. "Wild" jellyfish covered the entire ocean and served as a replenishment of the "cultural" colonies. The ocean has become a giant anthill."

The ocean rationality hypothesis has been rejected by the scientific community. Scientists agreed that sea ants (whose size was by about two millimeters) could play the role of neurons in this brain, and that jellyfish structures could be controlled by ants. However, no answer was found to the question of communication channels among ants, which could be from each other at a distance of many kilometers. Now we can understand that the authors of this hypothesis were right.

7. Distributed brain

So, from the previous, it follows that there is a distributed brain of the anthill and the neurons of such a brain are ants. There are no reasons for the appearance of a distributed brain in any other community of biological organisms. There are also no reasons limiting the mind of such a brain. Consider the features of the distributed brain (DB).

1. DB consists of many neuron-like elements, which we will hereinafter call independent and capable of activity neurons (ICANs)
2. The feature of the ICANs lies in the fact that they are physically autonomous and can operate to a certain extent, regardless of the DB.
3. ICANs are united by information communication channels and, thereby, create DB.
4. DB does not exist as a physical object.
5. In the process of its rational activity, the DB sends "leading" information signals (LISs) to an individual ICAN. These signals determine the purpose of the independent actions of the ICAN.
6. It is important to note that the body sending the LISs is physically absent. One of the ICAN-1 under the action of LIS-1 sends LIS-2 to another ICAN-2.

7. The simplest ICANs do not realize their connection with the DB and their participation in the activities of the DB.
8. It must be assumed that DB can be compared by reasonableness with the brain of an animal.

There is no reason to believe that only social insects can be independent neurons in the DB. Animals can also be independent neurons. A distributed brain is present not only in a swarm of bees and anthill but also in a flock of birds, a school of fish, a herd of herbivores and a pack of predators. Without such an assumption, it is difficult to explain the coordinated movements of a school of fish or a huge flock of birds, which retains its shape not only during a purposeful flight but also in preparatory whirling. Recently, fireworks of hundreds of drones controlled from a single center were demonstrated in China. The consistency of whirling a flock of birds is comparable to the consistency of whirling of this "flock" of drones. So, there is a flock behavior in the absence of a "boss". Such behavior is often considered as a manifestation of some egregore. DB flocks can represent this **egregor**. The bird at the head of the flock is the very ICAN-1 which, under the action of LIS-1, sends LIS-2 to all other ICANs-2, i.e. to all other birds of the flock.

A team of something united peoples (emotionally, informationally, or organizationally connected) can also create a DB or an egregor. The existing idea of egregors is the idea of "*the collective unconscious reproduced by egregors as energy-informational complexes representing ... the forms of being of archetypes in psychology*" [195]. Simply put, this is something unconscious, existing in the form of an energy-information complex, the structure of which is out of the question. The author does not want to use this phrase to belittle the existing theory [195]. On the contrary, it strikes with a depth of analysis of the behavior of this collective unconscious and makes one doubt in the unconsciousness of egregors. The above is an attempt to come closer to understanding the physical structure of egregor, as an energy-information complex.

A human-ICAN may also, like an ant, not be aware of his/her connection with DB. However, some people sometimes feel this connection, not understanding where the information comes from and not completely understanding its meaning. Sometimes the same information comes to several people. Then they say that "thoughts hovers in the air." Sometimes information comes (in a tense, emotional, unconscious request) in a dream (like Mendeleev). Apparently, it is in a dream that the human brain participates in the "socially useful" work of the DB.

Many prominent scientists have argued that consciousness exists outside the brain. So, John Eccles, the largest modern neurophysiologist

and Nobel laureate in medicine, also believes that the psyche is not a function of the brain. Together with his colleague, neurosurgeon Wilder Penfield, who performed more than 10,000 brain operations, Eccles wrote the book "The Secret of Man". In it, the authors directly declare that they "*have no doubt that SOMETHING is located outside the limits of his body.*" Professor Eccles writes: "*I can experimentally confirm that the work of consciousness cannot be explained by the functioning of the brain. Consciousness exists independently of it from without*" [196].

In view of the foregoing, it can be argued that consciousness exists in the form of DB. The more developed the consciousness of DB is, the more developed the consciousness of each individual, and the more developed the consciousness of the individual is, the more developed the consciousness of DB. Then it becomes obvious that for the existence of a developed universal human consciousness, it is necessary to have the following:

- numerous humanity,
- consisting of smart individuals,
- united civilization,
- Earth with an air shell.

It follows, in particular, that

- education must be universal,
- the notorious golden billion will not last long (like Mowgli in the jungle),
- a human in space is not capable of creative activity.

8. Conclusion

1. It is shown that in molecules of water and air there can exist a bulk standing electromagnetic wave of high frequency.
2. This wave can be modulated by the organs of the bio-organism.
3. A wave modulated in this way can propagate through the water and air and affect the organs of another bio-organism.
4. It is shown that such a wave propagates without energy loss.
5. Based on this, it is shown that a highly organized structure can exist in the air.
6. In such a structure, a separate bio-organism performs the functions of a neuron.
7. Such a structure may be the collective brain of a community of bio-organisms.

Chapter 16d. To the Rationale for Homeopathy

Contents

1. Introduction \ 1
2. Electromagnetic volumetric standing wave \ 2
3. Water keeper of information \ 3
4. The effect of high dilution \ 4
5. Conclusions \ 5

1. Introduction.

The theoretical rationale for homeopathy does not correspond to scientific ideas about the functioning of organisms. Therefore, a large number of professional medical and general scientific organizations openly express a negative attitude towards homeopathy. The same organizations point to the lack of evidence of the effectiveness of homeopathy. However, homeopathy exists precisely because many see this evidence. The following is an attempt to find a rigorous scientific justification for homeopathy. The first edition of this work was published in [189].

First of all, we note some characteristic features of homeopathy.

1. The healing effects of the drug and the drug solution are the same.
2. Trivial calculations show that in drugs with high dilution, the probability of having at least one molecule of the active substance is close to zero. However, the therapeutic effect remains.
3. With a decrease in the concentration of the drug, the therapeutic effect is enhanced.
4. The amount of impurities in a homeopathic medicine is inevitably greater than that of a medicinal substance. Therefore, particles of impurities, obviously, should have a greater effect than particles of a drug substance. However, this is not observed.
5. Some homeopaths believe that the effect of the drug is due to the fact that “water has a memory” that transfers biological information.
6. There is no generally accepted scientific opinion about the existence of a “memory of water” [186, 190, 191].

Thus, the question of the justification of homeopathy boils down to the question of the ability of water to preserve the memory about substances previously dissolved in it.

2. Electromagnetic volumetric standing wave.

In [2, 3], it was shown (as a consequence of solving Maxwell's equations) that in a limited volume of a vacuum there can exist an electromagnetic standing wave. This volume may have a variety of shapes. In a Cartesian coordinate system, the solution has the following form:

$$E_x(x, y, z, t) = e_x \cos(\alpha x) \sin(\beta y) \sin(\gamma z) \sin(\omega t), \quad (2)$$

$$E_y(x, y, z, t) = e_y \sin(\alpha x) \cos(\beta y) \sin(\gamma z) \sin(\omega t), \quad (3)$$

$$E_z(x, y, z, t) = e_z \sin(\alpha x) \sin(\beta y) \cos(\gamma z) \sin(\omega t), \quad (4)$$

$$H_x(x, y, z, t) = h_x \sin(\alpha x) \cos(\beta y) \cos(\gamma z) \cos(\omega t), \quad (5)$$

$$H_y(x, y, z, t) = h_y \cos(\alpha x) \sin(\beta y) \cos(\gamma z) \cos(\omega t), \quad (6)$$

$$H_z(x, y, z, t) = h_z \cos(\alpha x) \cos(\beta y) \sin(\gamma z) \cos(\omega t), \quad (7)$$

where E_x, E_y, E_z are the components of the electric field strength, H_x, H_y, H_z are the components of the magnetic field strength, $e_x, e_y, e_z, h_x, h_y, h_z$ are the constant amplitudes of the strengths, α, β, γ are the constants, ω is the angular frequency. These quantities are related by the following equations:

$$h_z = 0, \quad (8)$$

$$e_x = -e_z \frac{\gamma \alpha}{\alpha^2 + \beta^2}, \quad (9)$$

$$e_y = e_x \frac{\beta}{\alpha}, \quad (10)$$

$$h_y = e_x \frac{\varepsilon \omega}{\gamma}, \quad (11)$$

$$h_x = -e_y \frac{\varepsilon \omega}{\gamma}, \quad (12)$$

$$\gamma = \mu \omega, \quad (13)$$

$$\omega = \sqrt{\frac{\gamma^2 + \alpha^2 + \beta^2}{\varepsilon \mu}}. \quad (14)$$

For a cube there are the following equality for the parameters α, β, γ :

$$\alpha = \beta = \gamma. \quad (15)$$

The length of the half-edge of the cube is defined as

$$R = \frac{\pi}{\alpha}. \quad (16)$$

Then the formula for the frequency in a vacuum takes the following form:

$$\omega = \frac{c\pi}{R} \sqrt{3}, \quad (17)$$

where c is the speed of light in a vacuum.

A standing wave is not emitted through the faces of the cube and, in the absence of external energy flows, such a wave retains its energy, frequency, and shape of volume. This electromagnetic wave can be modulated by a lower frequency. In this case, this volume turns into a **keeper of energy and information**. In [2-4], the well-known experiments and natural phenomena are considered, which serve as proof of the existence of such a keeper.

3. Water keeper of information

We assume that the water molecule is the volume that stores the standing wave. In this case, the standing wave is stored in the space between the oxygen and hydrogen atoms, i.e. in a vacuum. Therefore, we can apply formula (17) to determine the frequency of an electromagnetic wave in a water molecule.

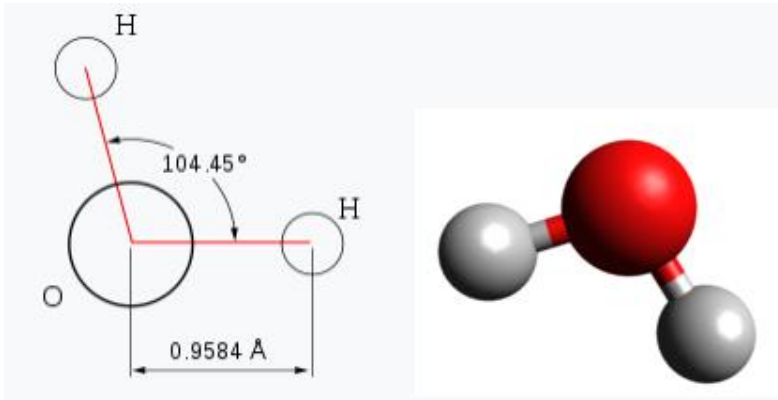

Fig. 1.

The gap between the oxygen and hydrogen atoms, where a standing wave can pulsate, has a size of 10^{-10} m, see in Figure 1. Consequently, the reader can find that

$$R \approx 5 \times 10^{-11} \text{ m.} \quad (18)$$

At the known speed of light in a vacuum $c \approx 3 \times 10^8$ from equations (17) and (18) we find the frequency of the electromagnetic field in the water molecule:

$$\omega = \frac{3 \times 10^8}{5 \times 10^{-11}} \sqrt{3} \approx 3 \times 10^{19} \text{ s}^{-1}. \quad (19)$$

The linear frequency f is related to this cyclic frequency ω by the relation

$$\omega = 2\pi f, \quad (20)$$

where

$$f = \frac{\omega}{2\pi} \approx 5 \times 10^{18} \text{ Hz}, \quad (21)$$

Therefore, we can define the wavelength γ as follows:

$$\gamma = \frac{c}{f} \approx 10^{-10} \text{ m}. \quad (22)$$

Thus, wavelength (22) and the radius of the region of existence of the standing wave (18) are related by the following relationship:

$$R \approx \frac{\gamma}{2}. \quad (23)$$

This means that the region of existence of a standing wave increases with increasing wavelength or with decreasing frequency.

The own frequency of drug molecules is within as follows:

$$L = (10^{13} \div 10^{14}) \text{ Hz} \quad (24)$$

The reader can find this parameter in [187], the value of which is much lower than frequency (21). Therefore, the frequencies of drugs can modulate the frequency of the electromagnetic field in a water molecule. We also note that the region of existence of a standing wave with a frequency of a drug substance is approximately 10^7 times greater than the region of a standing wave in a water molecule. The reader can compare (21) with (24).

It is known that electromagnetic radiation interacts with the molecules of a substance, causing radiation or absorption of electromagnetic radiation by the molecules of a substance at certain frequencies [188]. Therefore, the molecules of a substance can interact through electromagnetic radiation. A multiple enhancement of the effect of such an interaction appears when the eigenfrequencies of the emitting and absorbing molecules coincide. (In this one can see the homeopathic principle of treating of the like by the like, where the similarity is understood in the sense of similarity of frequencies, and not similarity of chemical composition). It must be assumed that it is precisely the frequencies of drugs that are the catalyst that affects diseased organs. Therefore, water molecules that carry “drug frequencies” act in exactly the same way as the drug substances themselves. This explains paragraphs 1.1 and 1.2.

4. The effect of high dilution

Initially, subject to precautions in the solution, the number of drug molecules M_0 significantly exceeds the number of impurity molecules M_1 . We write this fact in the following form:

$$M_0 = kM_1. \quad (25)$$

where the proportionality coefficient $k \gg 1$. Accordingly, the number of water molecules V_0 , bearing the drug frequency, significantly exceeds the

number of molecules V_1 , bearing the frequency of the impurity. We will record this fact in the following form

$$V_0 = kV_1. \quad (26)$$

It was noted above that the region of existence of an electromagnetic wave with a frequency of a drug substance is approximately 100 times greater than the region of a standing wave in a water molecule. Water molecules carrying any frequencies “charge” free molecules with these frequencies. Due to the mobility of water molecules, it can be assumed that all water molecules are charged of various modulating frequencies and the same relation is preserved between them (26). We denote

$$q = V_0/M_0. \quad (27)$$

When diluting the solution and maintaining the same volume, the number of molecules M_0 and M_1 decreases. However, the number of water molecules remains the same and, as before, all water molecules are charged. Therefore, after breeding

$$q_2 > q. \quad (28)$$

After many dilutions

$$q_2 \rightarrow \infty. \quad (29)$$

From equations (28), (27), and (25) it follows that the number of molecules M_0 and M_1 tends to zero. Consequently, the effect of impurities disappears. This explains paragraph 1.4.

Modulation of a standing wave of water molecules **by different molecules of the same** substance creates a phase difference of electromagnetic waves in different water molecules. The therapeutic effect depends on the total effect of all water molecules. Obviously, the total effect of molecules with different phases is less than the total effect of "in-phase molecules". Similar to the previous one, it can be shown that dilution increases the number of “in-phase molecules”. This explains paragraph 3.

5. Conclusions

It follows from the above that

1. In water molecules there are always intrinsic electromagnetic waves, which persist in the form of a standing electromagnetic wave of a certain high frequency.

2. This frequency is modulated by the intrinsic frequency of substances dissolved in water. This frequency is much less than the intrinsic frequency of water.

3. Water retains modulated electromagnetic oscillations in the absence of the substance creating these oscillations.

4. Water containing modulated electromagnetic oscillations affects the organism similar to the substance creating these oscillations.
5. Dilution of water with a therapeutic drug dissolved in it increases the therapeutic effect and weakens the effect of impurities.

Chapter 17. The Reversibility of Unipolar Induction

Содержание

1. Introduction \ 1
2. Justification of the reversibility of the law of unipolar induction \ 1
3. Magnetic currents \ 2
4. Rotating fields \ 3
5. Equations of unipolar induction in the set of Maxwell's equations \ 4
6. Proposed experiment \ 5

1. Introduction

The reversible law of unipolar induction is stated below. It is shown that this law of unipolar induction can justify the magneto-hydrodynamic dynamo effect and the existence of the magnetic field of astronomical objects. Next, we consider convection magnetic currents that can exist without the existence of magnetic charges (magnetic monopoles). Relevant experiments are indicated.

2. Justification of the reversibility of the law of unipolar induction

Eichenwald in [86] considers a rotating charged disk exciting a magnetic field. Eichenwald calls these rotating charges a convection current. His experiment suggests that ordinary electric current, convection current, a rotating electric field, and a rotating charged disk equally excite a magnetic field.

A rotating charged disk is a source of a rotating electric field. Thus, from the Eichenwald experiment, it follows that a rotating electric field excites a magnetic field.

The law of Faraday unipolar induction is widely known:

$$E = V \times B \tag{1}$$

or

$$E = V \times \mu H \tag{2}$$

On this basis, it can be assumed that there is a **reversible law of unipolar induction**:

$$H = V \times \varepsilon E \quad (3)$$

It is easy to make sure that formula (3) satisfies the requirements of the dimension of its variables.

Consider the case when the vector products in (2) and (3) can be replaced by a simple product and the magnitudes of the strengths E and H included in formulas (2) and (3) coincide. Then we get:

$$E = V_2 \mu H \quad (4)$$

$$H = V_3 \varepsilon E \quad (5)$$

Multiplying (4) by (5), we find:

$$V_2 V_3 = \frac{1}{\mu \varepsilon} = c^2 \quad (6)$$

Relation (4) is observed in known experiments at technically feasible speeds and strengths. At the technically feasible strengths, the speed

$$V_3 = \frac{c^2}{V_2} \quad (7)$$

should reach fantastically large values. However, for large both electric field strengths E and speeds V_3 , the appearance of magnetic field strength H should be observed.

The magnetohydrodynamic dynamo is known: the effect of self-generation of a magnetic field in a certain motion of a conducting fluid [145]. This effect explains the formation and existence of the magnetic field of astronomical objects such as galaxies, stars, planets [146]. In these phenomena there is high-speed movement of electric charges in a liquid or plasma, which is equivalent to large both electric field strengths E and velocities V_3 . Consequently, the reversible law of unipolar induction can serve as a justification for all these phenomena.

3. Magnetic currents

It was stated above that the magnetic field is created by the convection electric current of electric charges. In this case, equation (2) can be considered as the equation of magnetic field strength depending on the electric current of electric charges.

By analogy, it can be argued that the electric field can be created by the convection magnetic current of magnetic charges. In this case, equation (1) can be considered as the equation of electric field strength depending on the magnetic current of magnetic charges.

The idea of the existence of magnetic charges is not new. It is known that Heaviside was the first who introduced magnetic charges

and magnetic currents into Maxwell's electrodynamics [140]. Note also that in the mathematical sense, the pole of a long magnet can be identified with a magnetic charge [141].

The creation of an electric field by the convection current of magnetic charges was observed in Searl's experiments. In [142], it is described as a generator, "... accelerating more and more, began to emit a pink glow around him." A similar effect is described in forum [143]. This forum describes the disk of Azanov with many magnets attached to the circumference of the disk (for details, see answer 37). The author in the video (see answer 17) indicates that when his disk is rotated at a speed of 7000 rpm, a halo is formed. Indeed, in both cases, the rotation of the magnets is naturally identified with the convection current of the magnetic charges, and the resulting pink glow or halo is explained by the appearance of an electric field in accordance with equation (1).

Thus, the movement of magnets, the poles of which are oriented equally relative to the line of motion, can be considered as a magnetic current. This magnetic current creates an electric field. This does not mean that magnetic charges exist as a physical object but allows one to compactly describe the motion of a set of magnets.

4. Rotating fields

An electrically charged disc creates a symmetric electric field. Eichenwald's experience shows that a rotating symmetric electric field creates a magnetic field. In connection with this, Bogach in [139] says that *"with a high probability we can expect the existence of the opposite effect: with the rotation of even a symmetric magnetic field, an electric field should arise. And this possibility should be experimentally verified. Many published experimental works have been devoted to the search for the mentioned electric field ... However, it was not possible to measure the electric field in any of them, which can be explained, as will be seen from the following, with erroneous ideas about the properties of the field under study"*.

The above experiments demonstrate the opposite effect, on which Bogach says: a rotating magnetic field creates an electric field. Chapter 2g shows that there is an electric field in three-phase machines.

Bogach connects the question of the existence of this phenomenon with the question of the existence of a **static** electromagnetic field. In the previous chapters, it is shown that a static electromagnetic field follows directly from Maxwell's equations. For example, there is a **static** electromagnetic field in a DC wire and in a charged capacitor.

5. Equations of unipolar induction in the set of Maxwell's equations

Consider the formulas listed in table 1.

Table 1.

		a	b
1	Current density	$j = DV$	$m = BV$
2	Maxwell's equations	$\text{rot}H = j$	$\text{rot}E = m$
3	Unipolar Induction Equations	$H = V \times D$	$E = V \times B$

Consider the case when the electric charge is located at the end of an electret moving at a speed V . In this case, the density of the electric convection current is described by formula (1a) in table 1 because the electric induction at the end of the electret is equal to the density of the electric charge. In table 1, equation (2a) obtained above as (2.3) determines the magnetic field strength created by this convection current in the vicinity of the electret end. Equation (3a) in table 1 determines the magnetic field strength created by this convection current directly at the end face of the electret. Note that equation (2a) does not allow finding the strength at the end face. This also follows from the fact that the Bio-Savart-Laplace equation, equivalent to equation (2a), also does not allow the determination of the strength at the end face because in this case, the division by zero appears in the Bio-Savart-Laplace equation.

We now consider the case when the end face of a permanent magnet with magnetic induction B moves at a speed V . The magnetic induction at the end of the magnet is equal to the density of the magnetic charge. Therefore, the movement of the end face of the magnet is equivalent to a magnetic current with density (1b) in table 1. Equation (2b) in the table determines the electrical field strength generated by this convection current in the vicinity of the end face of the permanent magnet. Equation (3b) determines the magnetic field strength created by this convection current directly at the end face of the permanent magnet. Here it can also be noted that equation (2b) does not allow finding the strength at the end.

From this, it follows that equations (3a) and (3b) listed in table 1 should be included in the set of Maxwell's equations.

6. Proposed experiment

Below we consider a speculative (for now) experiment, which demonstrates the existence of magnetic currents, i.e. currents of magnetic charges. This will not mean that magnetic charges exist as a physical object but will allow a compact description of the movement of a set of magnets.

If this experiment were successful, then this would **not** mean a violation of the Maxwell equations: they would become even more symmetrical.

So, let's look at the scheme shown in Figure 1 below. First magnetically soft ring 1, pressed onto sleeve 2, can rotate around axis 3 by motor 4. Second magnetically soft ring 5 is fixed motionless. Between rings 1 and 5 there is copper cylinder 6. On the sides of rings 1 and 5 there are stationary ring windings 7.

If the electric current I flows through ring windings 7, then rings 1 and 5 are penetrated by a magnetic field with the induction B .

Thus, a rotating magnetic field is created. If this assumption is true, then this magnetic field excites an electric field along cylinder 6. Therefore, some electric current J should flow along cylinder 6, which closes through ammeter 8 along current lead 9. The readings of ammeter 8 will must confirm or refute this assumption.

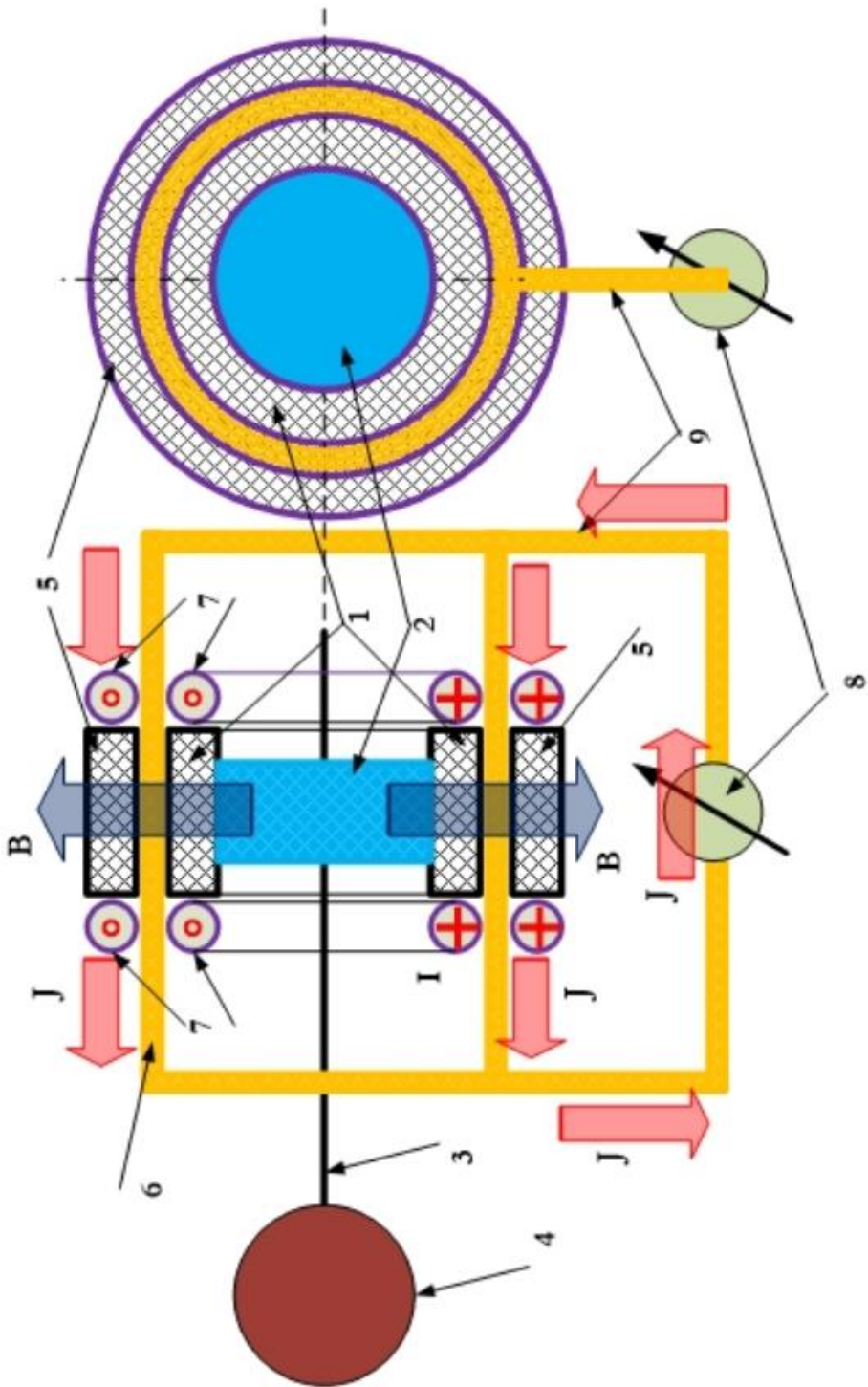

Fig. 1.

Chapter 18. The Forces of Lorentz, Ampere, and Khmelnik

Contents

1. Introduction \ 1
2. The Field's Configuration \ 1
3. The Lorentz Force \ 4
4. The Ampere Force \ 5
5. The Khmelnik Force \ 6

1. Introduction

It is known that the Ampere force contradicts the Third Newton Law. However, it does not contradict the more general Law of Momentum Conservation, as the electromagnetic field has a momentum. It is important to note that a static electromagnetic field can also have a momentum and therefore, the Ampere force does not contradict law of conservation of momentum, also in the case when it occurs in conjunction with a permanent magnetic field. From this it follows that the Ampere force must be balanced by the flow of electromagnetic field momentum. However, as far as the author knows, a quantitative comparison of the Ampere force with the flow of electromagnetic field momentum does not exist. Therefore, this comparison will be discussed below, see also in [25]. Here we shall also define some parameters and taking them into account, we shall show that the Lorentz force and the Ampere force can be regarded as corollaries of the existence of electromagnetic field momentum and the law of momentum conservation.

2. The Field's Configuration

For an electromagnetic field, let us denote the following quantities:

W is the energy density (scalar), $\text{kg}\cdot\text{m}^{-1}\cdot\text{s}^{-2}$,

S the energy flow density (vector), $\text{kg}\cdot\text{s}^{-3}$,

p the momentum density (scalar), $\text{kg}\cdot\text{m}^{-2}\cdot\text{s}^{-1}$,

f the electromagnetic field momentum density (vector), $\text{kg}\cdot\text{m}^{-1}\cdot\text{s}^{-2}$,

V the electromagnetic field volume (scalar), m^3 .

Figure 1 clearly shows several lines of current, induction, and flow. The "forest" of brown lines of the flow begins at the intersection points of the lines of current and the lines of induction, as shown by the circles. The flow lines penetrate the body, pass out of the body and are closed as shown by the horizontal arrows. These closing lines are shown by the circles in Figure 2.

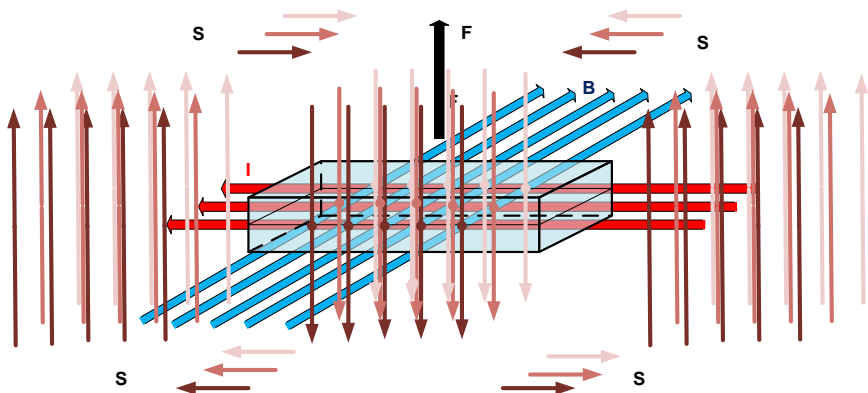

Fig. 1.

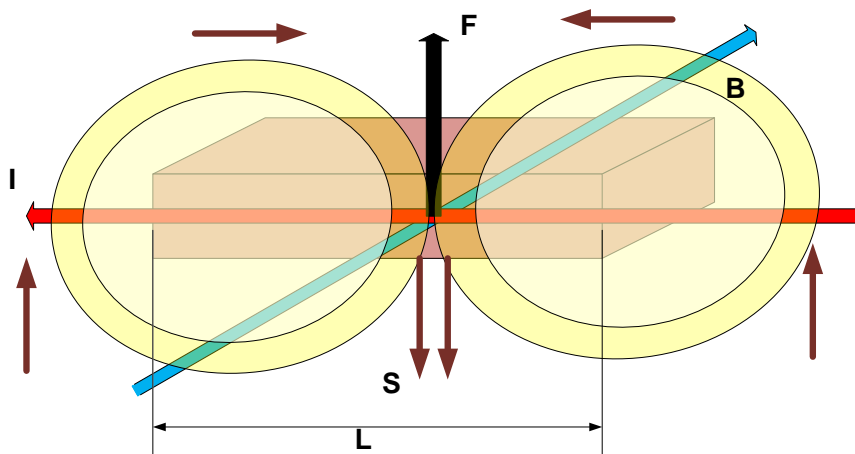

Fig. 2.

It is known [1, 2] that

$$|f| = W. \tag{1}$$

$$S = W \cdot c, \tag{2}$$

$$p = W/c, p = S/c^2, \tag{3}$$

$$f = p \cdot c, f = S/c. \tag{4}$$

The integral of the density by volume will be denoted as

$$A_V = \int_V A \cdot dV. \quad (4a)$$

The energy flow S_V may exist also in a static electromagnetic field [13]. Therefore, the momentum flow f_V exists also in a static electromagnetic field created by a direct current and permanent magnetic field.

The law of momentum conservation for a device interacting with the electromagnetic field can be written in the following form [13]:

$$-\frac{\partial}{\partial t}(J) = \frac{\partial}{\partial t}(pV) + fb, \quad (5)$$

where

J is the mechanical momentum of the device,

V is the volume of the device; the volume in which the electromagnetic field momentum interacts with the device, i.e. with charges and currents in this volume,

b is the cross-sectional area of the body, along which the flows of energy and momentum propagate.

Equation (5) means that the total flux of momentum in the entire volume of the field is equal to zero.

It is known that the force acting on the device is defined by

$$F = -\frac{\partial}{\partial t}(J). \quad (6)$$

Consequently,

$$F = \frac{\partial}{\partial t}(pV) + fb, \quad (7)$$

Combining (7) with (3) and (4), we get:

$$F = \frac{\partial}{\partial t}\left(\frac{SV}{c^2}\right) + \frac{Sb}{c}, \quad (8)$$

Thus, if the device is in the flow of electromagnetic energy S_V , then it is influenced by force (8), depending only on the flow of electromagnetic energy S_V . This force exists also for a permanent flow S_V and then

$$F = \frac{Sb}{c}, \quad (9)$$

In this case, if the flow of electromagnetic energy flux is distributed in the material with relative permittivity ϵ and relative permeability μ , then in formulas (8) and (9) the light speed c in a vacuum should be replaced by the electromagnetic wave speed c_s in the material as follows:

$$c_s = \frac{c}{\sqrt{\epsilon\mu}} \quad (10)$$

Let us consider the case shown in Figure 1 when the vectors of electric field strength E and electric field strength H are perpendicular to each other. In this case there is

$$S = EH \tag{11}$$

Let also allow the field in the device to be uniform and concentrated in some volume V . Then with equations (8), (10), and (11), the field can be expressed as follows:

$$F = \frac{\partial}{\partial t} \left(\frac{EHV\varepsilon\mu}{c^2} \right) + \frac{EHb\sqrt{\varepsilon\mu}}{c}, \tag{12}$$

If, besides that, the field is permanent, then

$$F = \frac{EHb\sqrt{\varepsilon\mu}}{c}, \tag{13}$$

or

$$F = \frac{Sb\sqrt{\varepsilon\mu}}{c}. \tag{13a}$$

3. The Lorentz Force

Let us consider the magnetic Lorentz force acting on a body with charge q moving at a speed v perpendicular to the vector of the magnetic induction B :

$$F_L = qvB. \tag{14}$$

We shall neglect the induction of the intrinsic magnetic field of a moving charge compared with the induction of an external magnetic field. We shall also neglect its own momentum of a moving charge. Then we have to accept that force (14) is caused by the flow of the momentum of electromagnetic field that penetrates the body of the charge. Thus, from equations (13) and (14), we can obtain:

$$qvB = \frac{EHb\sqrt{\varepsilon\mu}}{c}, \tag{16}$$

or for $B = \mu_o\mu H$ (μ_o is the magnetic constant for a vacuum) there is

$$qvc = \frac{Eb\sqrt{\varepsilon/\mu}}{\mu_o}, \tag{17}$$

Consequently, inside the body there should be the electric field strength directed along the velocity and equal to

$$E = \frac{qvc\mu_o}{b\sqrt{\varepsilon/\mu}}. \tag{18}$$

Let us note that

$$c\mu_o = \sqrt{\frac{\mu_o}{\varepsilon_o}} \approx 377 \tag{19}$$

where ε_o is the electric constant for a vacuum.

From (18) and (19) we find:

$$E = \frac{qvc\mu_o}{b} \sqrt{\frac{\varepsilon}{\mu}} \approx 377 \frac{qv}{b} \sqrt{\frac{\varepsilon}{\mu}}. \tag{20}$$

Consequently, **inside** a charged body moving in a magnetic field and being under the influence of Lorentz force there exists an intensity of electric field proportional to the movement speed.

The example with an Electron

It has a charge $q_o = 1.6 \cdot 10^{-19}$, classical radius $r_o = 2.8 \cdot 10^{-15}$, square of the central section of electron $b_o = \pi r_o^2 = 25 \cdot 10^{-30}$. Also $E_o \sqrt{\epsilon/\mu} = 25 \cdot 10^{21} v$. One may also say that on the diameter of the electron along the speed direction there exists a potentials' difference: a voltage $U_o = 2E_o r_o = 5 \times 10^{22} v \sqrt{\frac{\mu}{\epsilon}}$. Considering the arguments of Feynman [13] on the internal forces of the electron, restraining the electron charges on the surface of the sphere, we can see that this voltage is the force that "pulls" lagging charges to their place on the sphere when they move under the action of the Lorentz force.

Thus, the Lorentz force can be considered as a consequence of both the existence of a pulse of an electromagnetic field and the law of conservation of momentum. At the same time, however, it is necessary to assume that **inside the moving** charged body there is an electric field of form (20) proportional to the speed of movement.

So, a charged body moving at a certain speed in a magnetic field turns out to be in an electromagnetic field with

- the flow of electromagnetic energy,
- electromagnetic pulse and
- momentum flux of the electromagnetic field.

It follows from the law of conservation of momentum that the time derivative of the mechanical impulse of this body (i.e. the force acting on the body) depends on

- 1) the time derivative of the electromagnetic field momentum and
- 2) momentum flux of the electromagnetic field.

This power is the power of Lorentz.

4. The Ampere Force

Let us consider the Ampere force acting on a conductor with the electric current I moving at a speed v perpendicular to the vector of the magnetic induction \mathbf{B} :

$$F_A = IBL. \quad (21)$$

If this force F_A is caused by the momentum flux of the electromagnetic field penetrating the conductor, then from equations (13) and (21) we get:

$$IBL = \frac{EHb\sqrt{\epsilon\mu}}{c} \quad (23)$$

or for $B = \mu_0\mu H$, the reader can obtain the following expression:

$$IHL\mu_0\mu = \frac{EHb\sqrt{\epsilon\mu}}{c} \quad (24)$$

Therefore, the strength of electric field in this case will be equal to

$$E = \frac{IL\mu_0c}{b\sqrt{\epsilon/\mu}} \quad (25)$$

Qualitatively, this force can be explained by the fact that free electrons lag behind the body and accumulate in the “tail” of an accelerating body. This phenomenon was considered by Feynman for an accelerating electron [13]. The electrical resistance of the material inhibits the uniform distribution of charges. It consumes extra energy. Consequently, the movement of a charged body at a constant speed occurs with the expenditure of energy for heat losses. This ensures the constancy of the energy of the electric field inside a charged body.

If the resistivity of the conductor is equal to ρ and the electric current density is equal to j , then

$$j = I/b \quad (26)$$

and

$$E = j\rho \quad (27)$$

Then from (25)-(27) we get:

$$\rho = L\mu_0c\sqrt{\frac{\epsilon}{\mu}} \quad (28)$$

or

$$c = \frac{\rho}{L\mu_0}\sqrt{\frac{\mu}{\epsilon}} \quad (29)$$

Consequently, speed (29) of propagation of electromagnetic energy in a wire under the action of the Ampere force is less than the speed of light.

From the above, it follows that the Ampere force can be considered as a consequence of both the existence of a flux of an electromagnetic field pulse and the law of conservation of momentum.

5. The Khmelnik Force

On the basis of formula (12), it can be argued that there is another force that for brevity we will call the Khmelnik force (if, of course, no one has yet considered this force) [18]. In particular, it can be the power of Lorentz or the power of Ampere. In other cases, however, it is not equivalent to these forces. Chapter 13 examines the experiments of Tamm, Graham and Lahoz, Ivanov GP, which can be explained by the existence of this force. These experiments were performed in stationary fields but

with a variable strength E . In [18], a mental experiment is considered that works in static fields according to formula (13). Consider this problem.

Let us consider Figure 3 that shows a body located inside the solenoid with the **direct** current I . The body has covering electrodes under the **direct** voltage U . In this case, the body creates electromagnetic stationary field with the electric field strength E and the magnetic field strength H . In the body, a flow of electromagnetic energy with density (11) appears that is shown in Figure 3 by the circles. This flow can be presented in the form of two spheres united in the body and threading it in the vertical direction. This flow creates force (13) acting on the body.

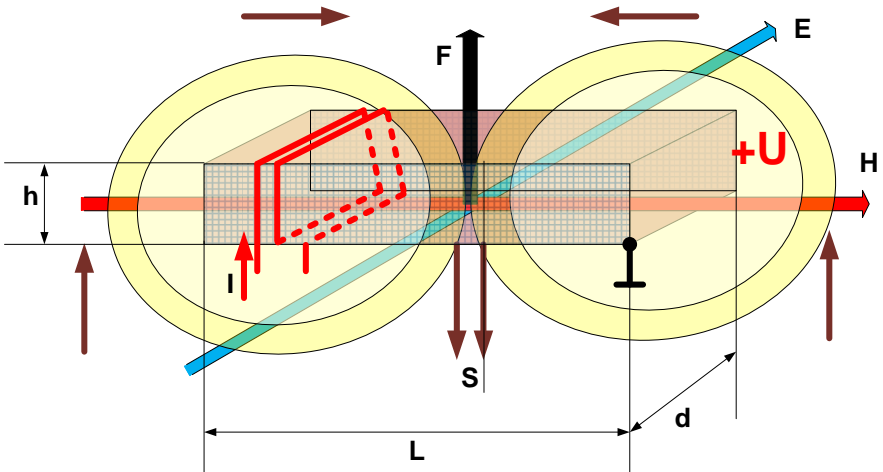

Fig. 3. The body inside the solenoid with the DC electric current.

Let us consider in more detail the calculation of force (13), using for this purpose the following designations of body size shown in Figure 3: L, d, h . Let the body be made of magnetodielectrics with the magnetic permeability $\mu = 400$, dielectric constant $\epsilon = 10$, saturation induction $B = 0.5$. The magnetic intensity with maximum induction $H = B/(\mu\mu_0) = 0.5/(400 \times 4\pi \times 10^{-7}) \approx 1000$. Let also $U = 30,000$, $h = 0.2, d = 0.5$. Then $b = hd = 0.1, E = \frac{U}{d} = 15,000$. Then with expression (13), we find:

$$F = \frac{E H b \sqrt{\epsilon \mu}}{c} = 15,000 \times 1000 \times 0.1 \times \frac{\sqrt{10 \times 400}}{c} \approx \frac{10^8}{c} \approx 0.3.$$

Thus, **we may expect that the device can be implemented**. The author suggests for experimentalists to verify the generation of the Khmelnik force and to supplement its name by their own names.

Chapter 97. Solution of Maxwell's equations for vacuum in cylindrical coordinates

Contents

1. Introduction
2. First solution method
 - 2.1. Statement of the problem
 - 2.2. Solution for the existence of longitudinal strengths.
 - 2.3. Appendix 2 to section 2.2.
 - 2.4. Appendix 3 to section 2.2.
 - 2.5. Solution in the absence of longitudinal strengths as a consequence of section 2
 - 2.6. Direct solution in the absence of longitudinal strengths
 - 2.7. Analysis of solutions obtained by the first method
3. Second solution method
 - 3.1. Justification of the method
 - 3.2. Common decision
 - 3.3. Solving static problems

1. Introduction

This chapter discusses purely mathematical methods for solving the indicated problem. Other chapters provide links to individual sections and subsections of this chapter. This is done because the same method is used in different cases, for example, when a wave propagates in a vacuum or when energy is transferred through a capacitor.

Consider the system of Maxwell's equations for vacuum, which has the form

$$\operatorname{rot}(E) + \frac{\mu}{c} \frac{\partial H}{\partial t} = 0, \quad (\text{a})$$

$$\operatorname{rot}(H) - \frac{\varepsilon}{c} \frac{\partial E}{\partial t} = 0, \quad (\text{b})$$

$$\operatorname{div}(E) = 0, \quad (\text{c})$$

$$\operatorname{div}(H) = 0. \quad (\text{d})$$

In the system of cylindrical coordinates r, φ, z , these equations have the form:

$$\frac{E_r}{r} + \frac{\partial E_r}{\partial r} + \frac{1}{r} \cdot \frac{\partial E_\phi}{\partial \phi} + \frac{\partial E_z}{\partial z} = 0, \quad (1)$$

$$\frac{1}{r} \cdot \frac{\partial E_z}{\partial \phi} - \frac{\partial E_\phi}{\partial z} = \frac{\mu}{c} \frac{dH_r}{dt}, \quad (2)$$

$$\frac{\partial E_r}{\partial z} - \frac{\partial E_z}{\partial r} = \frac{\mu}{c} \frac{dH_\phi}{dt}, \quad (3)$$

$$\frac{E_\phi}{r} + \frac{\partial E_\phi}{\partial r} - \frac{1}{r} \cdot \frac{\partial E_r}{\partial \phi} = \frac{\mu}{c} \frac{dH_z}{dt}, \quad (4)$$

$$\frac{H_r}{r} + \frac{\partial H_r}{\partial r} + \frac{1}{r} \cdot \frac{\partial H_\phi}{\partial \phi} + \frac{\partial H_z}{\partial z} = 0, \quad (5)$$

$$\frac{1}{r} \cdot \frac{\partial H_z}{\partial \phi} - \frac{\partial H_\phi}{\partial z} = \frac{\varepsilon}{c} \frac{dE_r}{dt}, \quad (6)$$

$$\frac{\partial H_r}{\partial z} - \frac{\partial H_z}{\partial r} = \frac{\varepsilon}{c} \frac{dE_\phi}{dt}, \quad (7)$$

$$\frac{H_\phi}{r} + \frac{\partial H_\phi}{\partial r} - \frac{1}{r} \cdot \frac{\partial H_r}{\partial \phi} = \frac{\varepsilon}{c} \frac{dE_z}{dt}, \quad (8)$$

where E_r, E_ϕ, E_z are electrical strengths, H_r, H_ϕ, H_z are magnetic strengths. To shorten the notation, we will further use the following notation:

$$\text{co} = \cos(\alpha\phi + \chi z + \omega t), \quad (9)$$

$$\text{si} = \sin(\alpha\phi + \chi z + \omega t), \quad (10)$$

where α, χ, ω are some constants.

2. First solution method

2.1. Statement of the problem

Consider equations (1.1-1.10). We represent the unknown functions in the following form:

$$H_r = h_r(r)\text{co}, \quad (11)$$

$$H_\phi = h_\phi(r)\text{si}, \quad (11)$$

$$H_z = h_z(r)\text{si}, \quad (13)$$

$$E_r = e_r(r)\text{si}, \quad (14)$$

$$E_\phi = e_\phi(r)\text{co}, \quad (15)$$

$$E_z = e_z(r)\text{co}, \quad (16)$$

wher $h(r), e(r)$ are some function coordinates r .

2.2. Solution for the existence of longitudinal strengths.

By direct substitution, one can make sure that functions (13-18) transform the system of equations (1-8) with four arguments r, ϕ, z, t into

a system of equations with one argument r and unknown functions $h(r), e(r)$. This system of equations is as follows:

$$\frac{e_r(r)}{r} + e_r'(r) - \frac{e_\varphi(r)}{r} \alpha - \chi \cdot e_z(r) = 0, \quad (17)$$

$$-\frac{1}{r} \cdot e_z(r) \alpha + e_\varphi(r) \chi - \frac{\mu\omega}{c} h_r = 0, \quad (18)$$

$$e_r(r) \chi - e_z'(r) + \frac{\mu\omega}{c} h_\varphi = 0, \quad (19)$$

$$\frac{e_\varphi(r)}{r} + e_\varphi'(r) - \frac{e_r(r)}{r} \cdot \alpha + \frac{\mu\omega}{c} h_z = 0, \quad (20)$$

$$\frac{h_r(r)}{r} + h_r'(r) + \frac{h_\varphi(r)}{r} \alpha + \chi \cdot h_z(r) = 0, \quad (21)$$

$$\frac{1}{r} h_z(r) \alpha - h_\varphi(r) \chi - \frac{\varepsilon\omega}{c} e_r(r) = 0, \quad (22)$$

$$-h_r(r) \chi - h_z'(r) + \frac{\varepsilon\omega}{c} e_\varphi(r) = 0, \quad (23)$$

$$\frac{h_\varphi(r)}{r} + h_\varphi'(r) + \frac{h_r(r)}{r} \alpha + \frac{\varepsilon\omega}{c} e_z(r) = 0. \quad (24)$$

Let's pretend that

$$h_r = k e_r, \quad (25)$$

$$h_\varphi = -k e_\varphi, \quad (26)$$

$$h_z = -k e_z, \quad (27)$$

where k is some constant. The rationale for this assumption is given in Chapter 2.

Let's change variables according to (25-27) in equations (17-24) and rewrite them:

$$\frac{e_r}{r} + \dot{e}_r - \frac{e_\varphi}{r} \alpha - \chi e_z = 0, \quad (28)$$

$$-\frac{e_z}{r} \alpha + e_\varphi \chi - \frac{\mu\omega}{c} k e_r = 0, \quad (29)$$

$$-\dot{e}_z + e_r \chi - k \frac{\mu\omega}{c} e_\varphi = 0, \quad (30)$$

$$\frac{e_\varphi}{r} + \dot{e}_\varphi - \frac{e_r}{r} \alpha - k \frac{\mu\omega}{c} e_z = 0, \quad (31)$$

$$k \frac{e_r}{r} + k \dot{e}_r - k \frac{e_\varphi}{r} \alpha - k \chi e_z = 0, \quad (32)$$

$$-k \frac{e_z}{r} \alpha + k e_\varphi \chi - \frac{\varepsilon\omega}{c} e_r = 0, \quad (33)$$

$$k \dot{e}_z - k e_r \chi + \frac{\varepsilon\omega}{c} e_\varphi = 0, \quad (34)$$

$$-k \frac{e_\varphi}{r} - k \dot{e}_\varphi + k \frac{e_r}{r} \alpha + \frac{\varepsilon\omega}{c} e_z = 0. \quad (35)$$

Note that equations (29) and (33) coincide for

$$\frac{\varepsilon\omega}{kc} = \frac{\mu\omega k}{c}. \quad (36)$$

Hence,

$$k = \sqrt{\frac{\varepsilon}{\mu}}. \quad (37)$$

Note also that equations (30) and (34) and equations (31) and (35) also coincide under condition (36). Finally, equations (281) and (32) coincide. Thus, equations (32-35) can be excluded from the system of equations. The remaining 4 equations (28-31) are a system of differential equations with 3 unknowns $\mathbf{e}_r, \mathbf{e}_\varphi, \mathbf{e}_z$. Let's consider the solution of these equations.

Appendix 2 provides a solution to the system of equations (28-30). It looks like this:

$$\ddot{e}_z + \frac{\dot{e}_z}{r} - e_z(\chi^2 - (k\mu\omega/c)^2) - \frac{e_z}{r^2}\alpha^2 = 0. \quad (38)$$

Appendix 3 provides a solution to the system of equations (29-31). It looks like this:

$$\ddot{e}_z + \frac{\dot{e}_z}{r} \left(\frac{k\mu\omega}{c\chi} \right) - e_z(\chi^2 - (k\mu\omega/c)^2) - \frac{e_z}{r^2}\alpha^2 = 0. \quad (39)$$

Both of these solutions (38) and (39) coincide if

$$\frac{k\mu\omega}{c\chi} = 1, \quad (40)$$

since wherein

$$(\chi^2 - (k\mu\omega/c)^2) = 0 \quad (41)$$

It follows from (40) and (37) that

$$\chi = \frac{\omega}{c} \sqrt{\mu\varepsilon}. \quad (42)$$

So, the function \mathbf{e}_z is defined by equations (38, 41) or

$$\ddot{e}_z + \frac{\dot{e}_z}{r} - e_z \frac{\alpha^2}{r^2} = 0. \quad (43)$$

His solution looks like:

$$\mathbf{e}_z = A r^\alpha, \quad (44)$$

where A is some constant. With known $\mathbf{e}_z, \dot{\mathbf{e}}_z$, one can find $\mathbf{e}_r, \mathbf{e}_\varphi$ according to (29, 30). Adding (29, 30), taking into account (40), we find:

$$-\frac{e_z}{r}\alpha - \dot{e}_z = 0 \quad (45)$$

or

$$\dot{e}_z = -\frac{e_z}{r}\alpha, \quad (46)$$

which coincides with the solution (44), Subtracting (30) from (29), taking into account (40), we find:

$$-\frac{e_z}{r}\alpha + \dot{e}_z + 2\chi(e_\varphi - e_r) = 0, \quad (47)$$

From (46, 47) we get:

$$(e_\varphi - e_r) = -\frac{\dot{e}_z}{2\chi}. \quad (48)$$

From (17, 48) we get:

$$\frac{e_r}{r} + \dot{e}_r - \left(\frac{\alpha e_z}{2\chi r} + e_r\right)\frac{\alpha}{r} - \chi e_z = 0 \quad (49)$$

or

$$\dot{e}_r = -\frac{e_r}{r}(1 - \alpha) + \left(\frac{\alpha^2}{2\chi r^2} + \chi\right)e_z. \quad (50)$$

For a given function e_z , from (50) one can find the function e_r , and then from (48) find the function e_φ - see functions Eref.m, ErefRo.m, Ezyes.m

Consider an algorithm for calculating an alternating current dielectric circuit using the obtained relations:

1. $R, \alpha, \omega, \mu, \varepsilon$ are known.
2. We calculate sequentially

$$\chi = \frac{\omega}{c}\sqrt{\mu\varepsilon}, \quad (42)$$

$$e_z = Ar^\alpha, \quad (44)$$

$$k = \sqrt{\frac{\varepsilon}{\mu}}, \quad (37)$$

$$\dot{e}_r = -\frac{e_r}{r}(1 - \alpha) + \left(\frac{\alpha^2}{2\chi r^2} + \chi\right)e_z, \quad (50)$$

$$e_\varphi = e_r - \frac{\dot{e}_z}{2\chi}, \quad (48)$$

$$h_r = ke_r, \quad (25)$$

$$h_\varphi = -ke_\varphi, \quad (26)$$

$$h_z = -ke_z. \quad (27)$$

Example 1.

In fig. 1 shows the graphs of the functions $e_\varphi, e_r, e_z, h_\varphi, h_r, h_z$ at $R = 0.2, \alpha = -5, \omega = 10^5$ in SI.

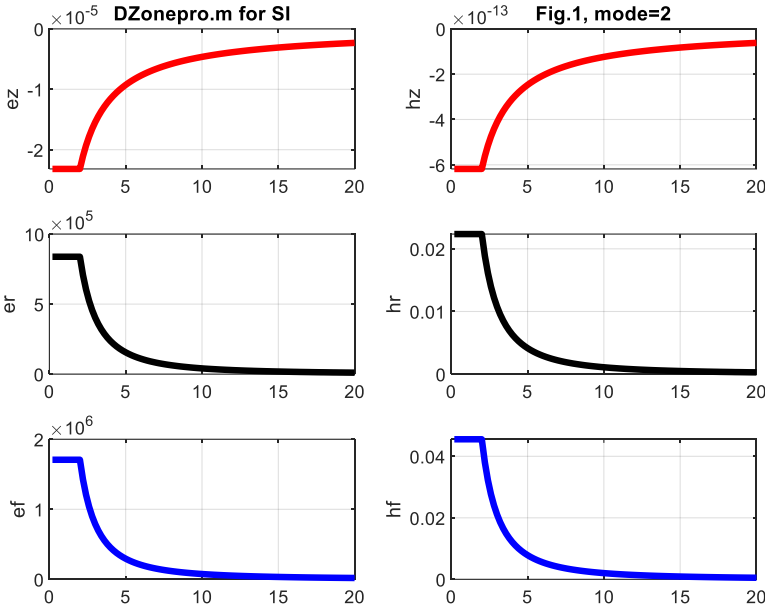

2.3. Appendix 2 to section 2.2.

Consider the solution to the system of equations (2.2.17-2.2.19) from Appendix 1:

$$\frac{e_r}{r} + \dot{e}_r - \frac{e_\varphi}{r} \alpha - \chi e_z = 0, \quad (1)$$

$$-\frac{e_z}{r} \alpha + e_\varphi \chi - \frac{\mu\omega}{c} k e_r = 0, \quad (2)$$

$$-\dot{e}_z + e_r \chi - k \frac{\mu\omega}{c} e_\varphi = 0. \quad (3)$$

We will consider the solution in detail so that the reader can easily check it. From (3) we find:

$$e_\varphi = \frac{c}{k\mu\omega} (e_r \chi - \dot{e}_z), \quad (4)$$

Combining (1, 4), we find:

$$\frac{e_r}{r} + \dot{e}_r - \frac{c}{k\mu\omega} \frac{\alpha}{r} (e_r \chi - \dot{e}_z) - \chi e_z = 0,$$

or

$$\frac{e_r}{r} \left(1 - \frac{c\alpha\chi}{k\mu\omega}\right) + \dot{e}_r - \chi e_z + \frac{c}{k\mu\omega} \frac{\alpha}{r} \dot{e}_z = 0, \quad (5)$$

Combining (2, 4), we find:

$$-\frac{e_z}{r} \alpha + \frac{c\chi}{k\mu\omega} (e_r \chi - \dot{e}_z) - \frac{\mu\omega}{c} k e_r = 0,$$

or

$$-\frac{e_z}{r}\alpha - \frac{c\chi}{k\mu\omega}\dot{e}_z + e_r\left(\frac{c\chi^2}{k\mu\omega} - \frac{k\mu\omega}{c}\right) = 0,$$

or

$$e_r = \left(\frac{e_z}{r}\alpha + \frac{c\chi}{k\mu\omega}\dot{e}_z\right) / \left(\frac{c\chi^2}{k\mu\omega} - \frac{k\mu\omega}{c}\right). \quad (6)$$

From (6) we find:

$$\dot{e}_r = \left(-\frac{e_z}{r^2}\alpha + \frac{\dot{e}_z}{r}\alpha + \frac{c\chi}{k\mu\omega}\ddot{e}_z\right) / \left(\frac{c\chi^2}{k\mu\omega} - \frac{k\mu\omega}{c}\right), \quad (7)$$

Combining (5-7), we find:

$$\begin{aligned} & \frac{1}{r}\left(1 - \frac{c\alpha\chi}{k\mu\omega}\right)\left(\frac{e_z}{r}\alpha + \frac{c\chi}{k\mu\omega}\dot{e}_z\right) / \left(\frac{c\chi^2}{k\mu\omega} - \frac{k\mu\omega}{c}\right) + \\ & \left(-\frac{e_z}{r^2}\alpha + \frac{\dot{e}_z}{r}\alpha + \frac{c\chi}{k\mu\omega}\ddot{e}_z\right) / \left(\frac{c\chi^2}{k\mu\omega} - \frac{k\mu\omega}{c}\right) - \chi e_z + \\ & \frac{c}{k\mu\omega}\frac{\alpha}{r}\dot{e}_z = 0 \end{aligned}$$

or

$$\begin{aligned} & \frac{1}{r}\left(1 - \frac{c\alpha\chi}{k\mu\omega}\right)\left(\frac{e_z}{r}\alpha + \frac{c\chi}{k\mu\omega}\dot{e}_z\right) + \left(-\frac{e_z}{r^2}\alpha + \frac{\dot{e}_z}{r}\alpha + \frac{c\chi}{k\mu\omega}\ddot{e}_z\right) + \\ & \left(\frac{c}{k\mu\omega}\frac{\alpha}{r}\dot{e}_z - \chi e_z\right)\left(\frac{c\chi^2}{k\mu\omega} - \frac{k\mu\omega}{c}\right) = 0 \end{aligned}$$

or

$$\begin{aligned} & \frac{c\chi}{k\mu\omega}\ddot{e}_z + \frac{\dot{e}_z}{r}\left(\left(1 - \frac{c\alpha\chi}{k\mu\omega}\right)\frac{c\chi}{k\mu\omega} + \alpha + \frac{c\alpha}{k\mu\omega}\left(\frac{c\chi^2}{k\mu\omega} - \frac{k\mu\omega}{c}\right)\right) - \\ & e_z\left(\frac{c\chi^2}{k\mu\omega} - \frac{k\mu\omega}{c}\right)\chi + \frac{e_z}{r^2}\left(\left(1 - \frac{c\alpha\chi}{k\mu\omega}\right)\alpha - \alpha\right) = 0 \end{aligned}$$

or

$$\begin{aligned} & \frac{c\chi}{k\mu\omega}\ddot{e}_z + \frac{\dot{e}_z}{r}\left(\frac{c\chi}{k\mu\omega} - \alpha\left(\frac{c\chi}{k\mu\omega}\right)^2 + \alpha + \left(\frac{c\alpha}{k\mu\omega}\frac{c\chi^2}{k\mu\omega} - \alpha\right)\right) - \\ & e_z\left(\frac{c\chi^2}{k\mu\omega} - \frac{k\mu\omega}{c}\right)\chi - \frac{e_z}{r^2}\frac{c\alpha^2\chi}{k\mu\omega} = 0 \end{aligned}$$

or

$$\frac{c\chi}{k\mu\omega}\ddot{e}_z + \frac{\dot{e}_z}{r}\frac{c\chi}{k\mu\omega} - e_z\left(\frac{c\chi^2}{k\mu\omega} - \frac{k\mu\omega}{c}\right)\chi - \frac{e_z}{r^2}\frac{c\alpha^2\chi}{k\mu\omega} = 0$$

or

$$c\chi\ddot{e}_z + \frac{\dot{e}_z}{r}c\chi - e_z\left(c\chi^2 - \frac{(k\mu\omega)^2}{c}\right)\chi - \frac{e_z}{r^2}c\alpha^2\chi = 0$$

or

$$\ddot{e}_z + \frac{\dot{e}_z}{r} - e_z(\chi^2 - (k\mu\omega/c)^2) - \frac{e_z}{r^2}\alpha^2 = 0. \quad (8)$$

2.4. Appendix 3 to section 2.2.

Consider the solution to the system of equations (2.2.17-2.2.19) from Appendix 1:

$$-\frac{e_z}{r}\alpha + e_\varphi\chi - \frac{\mu\omega}{c}ke_r = 0, \quad (1)$$

$$-\dot{e}_z + e_r\chi - k\frac{\mu\omega}{c}e_\varphi = 0, \quad (2)$$

$$\frac{e_\varphi}{r} + \dot{e}_\varphi - \frac{e_r}{r}\alpha - k\frac{\mu\omega}{c}e_z = 0. \quad (2)$$

We will consider the solution in detail so that the reader can easily check it. From (3) we find:

$$e_r = \frac{1}{\chi}\left(\dot{e}_z + \frac{k\mu\omega}{c}e_\varphi\right) \quad (4)$$

Combining (3, 4), we find:

$$\frac{e_\varphi}{r} + \dot{e}_\varphi - \frac{1}{\chi}\left(\dot{e}_z + \frac{k\mu\omega}{c}e_\varphi\right)\frac{\alpha}{r} - k\frac{\mu\omega}{c}e_z = 0,$$

or

$$\frac{e_\varphi}{r}\left(1 - \frac{k\alpha\mu\omega}{c\chi}\right) + \dot{e}_\varphi - \frac{k\mu\omega}{c}e_z - \frac{1}{\chi r}\dot{e}_z = 0. \quad (5)$$

Combining (2, 4), we find:

$$-\frac{e_z}{r}\alpha + e_\varphi\chi - \frac{k\mu\omega}{c}\frac{1}{\chi}\left(\dot{e}_z + \frac{k\mu\omega}{c}e_\varphi\right) = 0$$

or

$$-\frac{e_z}{r}\alpha - \frac{k\mu\omega}{c\chi}\dot{e}_z + e_\varphi\left(\chi - \frac{1}{\chi}\left(\frac{k\mu\omega}{c}\right)^2\right) = 0$$

or

$$e_\varphi = \left(\frac{e_z}{r}\alpha + \frac{k\mu\omega}{c\chi}\dot{e}_z\right) / \left(\chi - \frac{1}{\chi}\left(\frac{k\mu\omega}{c}\right)^2\right). \quad (6)$$

From (6) we find:

$$\dot{e}_\varphi = \left(-\frac{e_z}{r^2}\alpha + \frac{\dot{e}_z}{r}\alpha + \frac{k\mu\omega}{c\chi}\ddot{e}_z\right) / \left(\chi - \frac{1}{\chi}\left(\frac{k\mu\omega}{c}\right)^2\right). \quad (7)$$

Combining (5-7), we find:

$$\begin{aligned} & \frac{1}{r}\left(1 - \frac{k\alpha\mu\omega}{c\chi}\right)\left(\frac{e_z}{r}\alpha + \frac{k\mu\omega}{c\chi}\dot{e}_z\right) / \left(\chi - \frac{1}{\chi}\left(\frac{k\mu\omega}{c}\right)^2\right) + \\ & \left(-\frac{e_z}{r^2}\alpha + \frac{\dot{e}_z}{r}\alpha + \frac{k\mu\omega}{c\chi}\ddot{e}_z\right) / \left(\chi - \frac{1}{\chi}\left(\frac{k\mu\omega}{c}\right)^2\right) - \\ & \frac{k\mu\omega}{c}e_z - \frac{1}{\chi r}\dot{e}_z = 0 \end{aligned}$$

or

$$\frac{1}{r} \left(1 - \frac{k\alpha\mu\omega}{c\chi}\right) \left(\frac{e_z}{r} \alpha + \frac{k\mu\omega}{c\chi} \dot{e}_z\right) + \left(-\frac{e_z}{r^2} \alpha + \frac{\dot{e}_z}{r} \alpha + \frac{k\mu\omega}{c\chi} \ddot{e}_z\right) - \left(\frac{k\mu\omega}{c} e_z + \frac{1}{\chi} \frac{\alpha}{r} \dot{e}_z\right) \left(\chi - \frac{1}{\chi} \left(\frac{k\mu\omega}{c}\right)^2\right) = 0$$

or

$$\frac{k\mu\omega}{c\chi} \ddot{e}_z + \frac{\dot{e}_z}{r} \left(\left(1 - \frac{k\alpha\mu\omega}{c\chi}\right) \frac{k\mu\omega}{c\chi} + \alpha - \frac{\alpha}{\chi} \left(\chi - \frac{1}{\chi} \left(\frac{k\mu\omega}{c}\right)^2\right) \right) - \left(\frac{k\mu\omega}{c} e_z\right) \left(\chi - \frac{1}{\chi} \left(\frac{k\mu\omega}{c}\right)^2\right) + \frac{e_z}{r^2} \left(\left(1 - \frac{k\alpha\mu\omega}{c\chi}\right) \alpha - \alpha \right) = 0$$

or

$$\frac{k\mu\omega}{c\chi} \ddot{e}_z + \frac{\dot{e}_z}{r} \left(\frac{k\mu\omega}{c\chi} - \alpha \left(\frac{k\mu\omega}{c\chi}\right)^2 + \frac{\alpha}{\chi^2} \left(\frac{k\mu\omega}{c}\right)^2 \right) - e_z \left(\chi \frac{k\mu\omega}{c} - \frac{1}{\chi} \left(\frac{k\mu\omega}{c}\right)^3 \right) - \frac{e_z}{r^2} \frac{k\alpha^2\mu\omega}{c\chi} = 0$$

or

$$\ddot{e}_z + \frac{\dot{e}_z}{r} \left(\frac{k\mu\omega}{c\chi}\right) - e_z \left(\chi^2 - \left(\frac{k\mu\omega}{c}\right)^2\right) - \frac{e_z}{r^2} \alpha^2 = 0$$

or

$$\ddot{e}_z + \frac{\dot{e}_z}{r} \left(\frac{k\mu\omega}{c\chi}\right) - e_z \left(\chi^2 - (k\mu\omega/c)^2\right) - \frac{e_z}{r^2} \alpha^2 = 0. \quad (8)$$

2.5. Solution in the absence of longitudinal strengths as a consequence of section 2

Now we can assume that there is no longitudinal electric field strength and there is only a longitudinal energy flux.

For this, it is sufficient to assume in the formulas obtained

$$e_z = 0. \quad (1)$$

Then from (2.2.50) we find:

$$\dot{e}_r + \frac{e_r}{r} (1 - \alpha) = 0 \quad (2)$$

or

$$e_r = A r^{-(1-\alpha)}, \quad (3)$$

where A is some constant. Then from (2.2.48) we find:

$$e_\varphi = e_r. \quad (4)$$

2.6. Direct solution in the absence of longitudinal strengths

Here we will solve the Maxwell system of equations for

$$H_z = 0, \quad (1)$$

$$E_z = 0. \quad (2)$$

Section 2.2 shows that solving the Maxwell system of equations is reduced to solving equations (2.2.17-2.2.24). From (1, 2) it follows that these equations must satisfy the conditions

$$h_z = 0, \quad (3)$$

$$e_z = 0. \quad (4)$$

First, we will show that conditions (3, 4) are fulfilled simultaneously - if one of them holds, then the other holds as well.

Suppose condition (4) is satisfied. Then equation (2.2.17) takes the form:

$$\frac{e_r(r)}{r} + e_r'(r) - \frac{e_\phi(r)}{r} \alpha = 0, \quad (5)$$

Substitute the functions $e_r(r)$ and $e_\phi(r)$ from (2.2.22, 2.2.23) into (2.17). Then we get:

$$\left(\frac{\alpha}{r} h_z(r) - h_\phi(r) \chi\right) \frac{1}{r} + \left(\frac{\alpha}{r} h_z'(r) - h_\phi'(r) \chi\right) - \left(h_r(r) \chi + h_z'(r)\right) \frac{\alpha}{r} = 0,$$

or

$$\frac{\alpha}{r^2} \cdot h_z(r) - \frac{1}{r} \cdot h_\phi(r) \chi - h_\phi'(r) \chi - h_r(r) \frac{\chi \alpha}{r} = 0 \quad (6)$$

Let us find $h_\phi'(r)$ from (2.2.24) under condition (4) and substitute it into (6). Then we get:

$$\frac{1}{r^2} \cdot h_z(r) \alpha - \frac{1}{r} \cdot h_\phi(r) \chi + \left(\frac{1}{r} \cdot h_\phi(r) + h_r(r) \frac{\alpha}{r}\right) \chi - h_r(r) \frac{\chi \alpha}{r} = 0$$

or $\frac{-1}{r^2} \cdot h_z(r) \alpha = 0$ or $h_z(r) = 0$. This implies

Lemma 1. For $e_z(r) = 0$, the system of equations (2.2.21-2.2.24) is compatible only if $h_z(r) = 0$.

It can be proved similarly

Lemma 2. For $h_z(r) = 0$, the system of equations (2.2.21-2.2.24) is compatible only if $e_z(r) = 0$.

Lemma 1 and Lemma 2 imply

Lemma 3. The system of equations (2.2.21-2.2.24) is compatible only for if $h_z(r) = 0$, $e_z(r) = 0$.

When Lemma 3 is satisfied, the original system of equations (2.2.17-2.2.24) takes the form of the following equations:

$$\frac{e_r(r)}{r} + e_r'(r) - \frac{e_\phi(r)}{r} \alpha = 0, \quad (7)$$

$$e_\phi(r) \chi - \frac{\mu \omega}{c} h_r = 0, \quad (8)$$

$$e_r(r) \chi + \frac{\mu \omega}{c} h_\phi = 0, \quad (9)$$

$$\frac{e_\varphi(r)}{r} + e'_\varphi(r) - \frac{e_r(r)}{r} \cdot \alpha = 0, \quad (10)$$

$$\frac{h_r(r)}{r} + h'_r(r) + \frac{h_\varphi(r)}{r} \alpha = 0, \quad (11)$$

$$-h_\varphi(r)\chi - \frac{\varepsilon\omega}{c} e_r(r) = 0, \quad (12)$$

$$-h_r(r)\chi + \frac{\varepsilon\omega}{c} e_\varphi(r) = 0, \quad (13)$$

$$\frac{h_\varphi(r)}{r} + h'_\varphi(r) + \frac{h_r(r)}{r} \alpha = 0. \quad (14)$$

Let's multiply equations (8, 12). Then we get:

$$-e_r(r)h_\varphi(r)\chi^2 = -\mu\varepsilon\left(\frac{\omega}{c}\right)^2 e_r(r)h_\varphi(r)$$

or

$$\chi = \pm \omega\sqrt{\mu\varepsilon}/c. \quad (15)$$

Substituting (15) into (9, 13), we obtain:

$$h_\varphi(r) = \sqrt{\frac{\varepsilon}{\mu}} e_r(r) \quad . \quad (16)$$

Thus, under condition (15), equations (9, 13) are equivalent to one equation (16). A similar relationship follows from (8, 13):

$$h_r(r) = -\sqrt{\frac{\varepsilon}{\mu}} e_\varphi(r). \quad (17)$$

So, the system of equations (7-14) is equivalent to the system (7, 10, 11, 14-17). It remains for us to solve equations (7, 10). Consider first an equation of the form

$$\frac{ay}{x} + y' = 0, \quad (18)$$

The solution to this equation is:

$$y = x^{-a} \text{ or } y = 0. \quad (19)$$

Let us add equations (7) and (10):

$$(e_r + e_\varphi)' + \frac{(e_r + e_\varphi)}{r} (1 - \alpha) = 0. \quad (20)$$

Subtract equation (7) from (10):

$$(e_r - e_\varphi)' + \frac{(e_r - e_\varphi)}{r} (1 + \alpha) = 0. \quad (21)$$

In accordance with (18, 19) from (20) we find:

$$(e_r + e_\varphi) = Ar^{-(1-\alpha)} \text{ или } (e_r + e_\varphi) = 0. \quad (22)$$

In accordance with (18, 19) from (21) we find:

$$(e_r - e_\varphi) = Cr^{-(1+\alpha)} \text{ или } (e_r - e_\varphi) = 0. \quad (23)$$

Adding and subtracting equations (22) from (23), we find 4 solutions:

$$e_r = e_\varphi = \frac{A}{2} r^{-(1-\alpha)}, \quad (24)$$

$$e_r = -e_\varphi = \frac{C}{2} r^{-(1+\alpha)}, \quad (25)$$

$$\begin{cases} e_r(r) = \frac{1}{2}(Ar^{-(1-\alpha)} + Cr^{-(1+\alpha)}) \\ e_\phi(r) = \frac{1}{2}(Ar^{-(1-\alpha)} - Cr^{-(1+\alpha)}) \end{cases} \quad (26)$$

$$e_r = e_\phi = 0. \quad (27)$$

Other variables in the system of equations (2.2.21-2.2.28) are determined by the following expressions:

$$h_z(r) = 0, \quad (3)$$

$$e_z(r) = 0, \quad (4)$$

$$\chi = \omega\sqrt{\mu\varepsilon}/c, \quad (15)$$

$$h_\phi(r) = \sqrt{\frac{\varepsilon}{\mu}}e_r(r), \quad (16)$$

$$h_r(r) = -\sqrt{\frac{\varepsilon}{\mu}}e_\phi(r). \quad (17)$$

2.7. Analysis of solutions obtained by the first method

These solutions are as follows:

$$e_r = e_\phi = Ar^\beta, \quad (1)$$

where A is some constant, β is a linear function of r . These functions have two properties that are physically unacceptable, namely

- they take an infinite value at $r = 0$, if the exponent of r is negative;
- they take on an infinite value as $r \rightarrow \infty$, if the exponent of r is positive.

Therefore, such solutions are applicable only when the parameter r is limited:

$$0 < r < \infty. \quad (2)$$

3. Second solution method

3.1. Justification of the method

It was shown above that the solution obtained by the first method takes an infinite value at $r = 0$, which is inapplicable from the physical point of view. This result can be avoided by assuming that the parameter α depends on r . We will show this for a particular case.

Consider equation (2.2.17):

$$\frac{e_r(r)}{r} + e_r'(r) - \frac{e_\phi(r)}{r}\alpha - \chi \cdot e_z(r) = 0, \quad (1)$$

If the parameter α depends on r , i.e. $\alpha = \alpha(r)$, then this equation takes the form:

$$\frac{e_r(r)}{r} + e_r'(r) + e_r(r)\alpha(r)\alpha'(r) - \frac{e_\varphi(r)}{r}\alpha - \chi \cdot e_z(r) = 0,$$

For $e_z(r) = 0$ and $e_\varphi(r) = e_r(r)$, it takes the form:

$$\frac{e_r}{r} + e_r' + e_r\alpha\alpha' - \frac{e_r}{r}\alpha = 0, \quad (2)$$

or

$$\left(\frac{1}{r}(1 - \alpha) + \alpha\alpha'\right) e_r + e_r' = 0, \quad (3)$$

Let's denote:

$$y(x) = e_r(r) \quad (4)$$

and from (3, 4) we get:

$$\frac{dy}{dx} = \left(\frac{1}{x}(\alpha - 1) - \alpha\alpha'\right) y. \quad (5)$$

The solution to this equation is known and has the form:

$$y = Ae^F,$$

$$F = \int \left(\frac{1}{r}(\alpha - 1) - \alpha\alpha'\right) dr = (\alpha - 1)\log(r) - \frac{\alpha^2}{2},$$

$$\begin{aligned} e^F &= \exp\left((\alpha - 1)\log(r) - \frac{\alpha^2}{2}\right) = x^{(\alpha-1)} \exp\left(-\frac{\alpha^2}{2}\right) \\ &= \left(\exp\left(-\frac{\alpha^2}{2}\right) x^{(\alpha-1)}\right) \end{aligned}$$

Returning to the previous notation, we find

$$e_r(r) = A \left(\exp\left(-\frac{\alpha(r)^2}{2}\right) r^{(\alpha(r)-1)}\right). \quad (6)$$

We need to find a function increasing in modulus such that the condition

$$\alpha(r=0) = 0 \quad (7)$$

so that at $r = 0$ we get $r^{(\alpha(r)-1)} = 0$. We will use the following function

$$\alpha(r) = \alpha_o(1 - \exp(-\sigma r)). \quad (8)$$

In this function

$$\left\{ \begin{array}{l} \sigma > 0, \text{ if } \alpha_o < 0 \\ \sigma < 0, \text{ if } \alpha_o > 0 \end{array} \right\} \quad (9)$$

In fig. 1 shows functions (8) for various values of α_o, σ, R (the value of R is the maximum value on the abscissa).

All equations (2.1.28-2.1.31) can be transformed in the same way. Then they will take the form:

$$\left(\frac{1}{r} + \alpha\alpha'\right) e_r + e_r' - \chi \cdot e_z(r) = 0, \quad (10)$$

$$-\frac{e_z}{r}\alpha + e_\varphi\chi - \frac{\mu\omega}{c}ke_r = 0, \quad (11)$$

$$-(1 + \alpha\alpha')e_z - \dot{e}_z + e_r\chi - k\frac{\mu\omega}{c}e_\varphi = 0, \quad (12)$$

$$\left(\frac{1}{r} - \alpha\alpha'\right) e_\varphi + e_r' - k\frac{\mu\omega}{c} e_z(r) = 0. \quad (13)$$

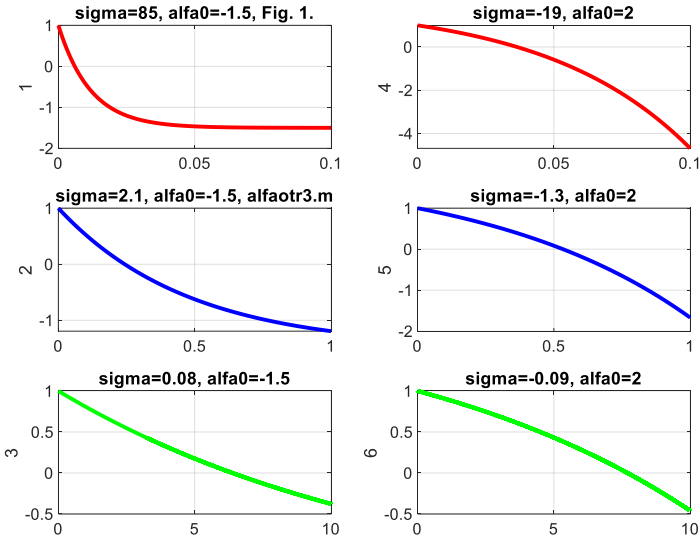

3.2. Common decision

The solution to these equations will differ from the solutions obtained in Sections 2.6 and 2.2, only in the form of formulas for $e_r(r)$ and $e_\varphi(r)$, which in this case will take the form (6).

Table 1 shows one of the solutions in section 2.2.

Table 1

Solution in section 2.2	New solution
$e_r = e_\phi = \frac{A}{2} r^{\alpha-1} \quad (24)$	$e_r(r) = A \left(\exp\left(-\frac{\alpha(r)^2}{2}\right) r^{\alpha(r)-1} \right). \quad (6)$
	$\alpha(r) = \alpha_o (1 - \exp(-\sigma r)). \quad (8)$
	$\left\{ \begin{array}{l} \sigma > 0, \text{ if } \alpha_o < 0 \\ \sigma < 0, \text{ if } \alpha_o > 0 \end{array} \right\} \quad (9)$
	$h_z(r) = 0, \quad (3)$
	$e_z(r) = 0, \quad (4)$
	$\chi = \omega\sqrt{\mu\epsilon}/c, \quad (15)$
	$h_\phi(r) = \sqrt{\frac{\epsilon}{\mu}} e_r(r), \quad (16)$
	$h_r(r) = -\sqrt{\frac{\epsilon}{\mu}} e_\phi(r). \quad (17)$

Table 2 shows the solution in section 2.2. Here the values of the constants A , α_o , σ have not yet been determined.

Table 2

Solution in section 2.2	New solution
$e_z(r) = Ar^\alpha$ (44)	$e_z(r) = A \left(\exp \left(-\frac{\alpha(r)^2}{2} \right) r^{(\alpha(r)-1)} \right)$ (6)
	$\alpha(r) = \alpha_o (1 - \exp(-\sigma r))$. (8)
	$\left\{ \begin{array}{l} \sigma \geq 0, \text{ if } \alpha_o < 0 \\ \sigma < 0, \text{ if } \alpha_o > 0 \end{array} \right\}$ (9)
$\chi = \frac{\omega}{c} \sqrt{\mu \epsilon}$, (42)	
$k = \sqrt{\frac{\epsilon}{\mu}}$, (37)	
$\dot{e}_r = -\frac{e_r}{r} (1 - \alpha) + \left(\frac{\alpha^2}{2\chi r^2} + \chi \right) e_z$, (50)	
$e_\varphi = e_r - \frac{\dot{e}_z}{2\chi}$, (48)	
$h_r = k e_r$, (25)	
$h_\varphi = -k e_\varphi$, (26)	
$h_z = -k e_z$. (27)	

The solution shown in table 2 is the most general, since it also implies a solution in the absence of longitudinal strengths - see table 1. Indeed, for (4, table 1), from (50, table 2) it follows (24, table 1).

3.3. Solving static problems

The general solution is applicable for any ω . Therefore, it should be applicable for $\omega = 0$ as well. This is easy to verify by considering table. 2. Only the parameter χ is indeterminate, which formally becomes zero. However, in the main chapters, its meaning is determined.

References

Comment: **DNA** – The Papers of independent Authors,
ISSN 2225-6717, <http://dna.izdatelstwo.com/>

1. Kann K.B. Electrodynamics. Electromagnetic waves, <http://electrodynamics.narod.ru/em-waves.html>
2. The bias current and Maxwell's equations, <http://www.webpoliteh.ru/subj/dinamo/767-25-tok-smeshheniya-i-sistema-uravnenij-maksvella.html>
3. Rozanov N.N. Special sections of mathematical physics. Part 3. The electromagnetic waves in a vacuum. ITMO. St. Petersburg, 2005.
4. Andre Ango. Mathematics for Electrical and Radio Engineers, publ. "Nauka", Moscow, 1964, 772 p. (in Russian).
5. Khmelnik S.I. The Second Solution of Maxwell's Equations, DNA-35.105, 2016, in Russian, <https://zenodo.org/record/3937578>
6. Khmelnik S.I. Mathematical Model of Electric Tornado, DNA-33.129, 2015, in Russian, <https://zenodo.org/record/3574960>
7. Khmelnik S.I. The Second Structure of Constant Current, DNA-35.92, 2016, in Russian, <https://zenodo.org/record/3937569>
8. Khmelnik S.I. Electromagnetic Energy Flux in a Conductor with a Alternating Current, ViXra, 2015-03-10, in Russian, <http://lib.izdatelstwo.com/Papers2/ViXraParamTokovPerem.pdf>
9. Khmelnik S.I. Electromagnetic Energy Flux in a Conductor with a Constant Current, DNA-32.218, 2015, in Russian, <https://zenodo.org/record/3574684>
10. Khmelnik S.I. Structure of Constant Current, DNA-33.110, 2015, in Russian, <https://zenodo.org/record/3574960>
11. Khmelnik S.I. The Flow Structure of the Electromagnetic Energy in the Wire with Constant Current, DNA-33.121, 2015, in Russian, <https://zenodo.org/record/3574960>
12. Torshin V.V., Busygin B.P., Pashchenko F.F., Krukovskiy L.E. Effect of direct electric current generation in static conductor in constant magnetic field. Trapeznikov Institute of Control Sciences of Russian academy of Sciences Journal of Modern Science and Education, issue 12, 2008 (in Russian),

-
- <http://cyberleninka.ru/article/n/effekt-generatsii-postoyannogo-elektricheskogo-toka-v-nepodvizhnom-provodnike-v-postoyannom-magnitnom-pole>
13. R.P. Feynman, R.B. Leighton, M. Sands. The Feynman Lectures on Physics, volume 2, 1964.
 14. Khmelnik S.I. Flow of Electromagnetic Energy in the Wire and the Milroy Engine, 2015-10-26 (in Russian), <http://lib.izdatelstwo.com/Papers2/Milroy.pdf>.
 15. Khmelnik S.I. The Electromagnetic Wave in Alternating Current Wire, 2016-03-02, (in Russian), <http://lib.izdatelstwo.com/Papers2/VolnaPeremToka2.pdf>
 17. Khmelnik S.I. The Experiment Confirming the Existence of the Fourth Electromagnetic Induction, 2016-01-20 (in Russian), <http://lib.izdatelstwo.com/Papers2/Escho4ind.pdf>
 18. Khmelnik S.I. Khmelnik Force, DNA-28.153; <https://zenodo.org/record/3549537>
 19. Khmelnik S.I. The Fourth Electromagnetic Induction, DNA-31.197 (in Russian), <https://zenodo.org/record/3574669>
 20. <https://ru.wikipedia.org/wiki/Рельсотрон> (in Russian).
 21. L.D. Landau, E.M. Lifshitz, Field theory.
 22. Tamm I.E. Fundamentals of the theory of electricity, Moscow, FIZMATLIT, 2003, p. 547.
 23. Khmelnik S.I. Faraday Unipolar Motor and the Impulse Preservation Law, DNA-23.155 (in Russian),
 24. Khmelnik S.I. To the Question of intranuclear Forces, DNA-28.125, <https://zenodo.org/record/3549473>
 25. Khmelnik S.I. Lorentz Force, Ampere Force and Momentum Conservation Law Quantitative. Analysis and Corollaries, DNA-28.145, <https://zenodo.org/record/3549515>
 26. Khmelnik S.I. Invertibility Principle in Faraday Unipolar Machines, DNA-28.160, <https://zenodo.org/record/3549582>
 27. Khmelnik S.I. Experiment for the proof of Newton's Third Law Violation in Unipolar Motor, 2015, <http://lib.izdatelstwo.com/Papers2/ViXraExpFaradEng.pdf>
 28. Strebkov D.S. Electric power transmission without metal wires, <http://www.electrolibrary.info/tesla/peredachaenergii.htm>
 29. Rothammel K. Antennas, publ. "Energy", 1967, <http://www.radiouniverse.ru/book/antenny/2-1-antenna-v-vide-dlinnogo-provoda>
-

30. N.E. Zaev. Superconductors engineer Avramenko. "Technology - Youth", №1, Moscow, 1991 (in Russian).
31. Inventor, 1992, №5, 6, 1-32 (in Russian).
32. V.A. Kuligin, M.V. Korneva, G.A. Kuligina, G.P. Bolshakov, Inertionless charges and currents, <http://www.n-t.ru/ac/iga/>, <https://docplayer.ru/288164-Bezinerercialnye-zaryady.html> (in Russian).
33. M. Lobova, G. Shipov, Tawatchai Laosirihongthong, Supakit Chotigo. Experimental observation of scalar electromagnetic field. King Mongkut's University of Technology, Thonburi, Bangkok, 10140, Thailand, (in Russian) <http://www.trinitas.ru/rus/doc/0231/004a/1032-MonopolE.pdf>
34. N.E. Zaev, S.V. Avramenko, V.N. Lisin. Measurement of conduction current excited by polarization current. (in Russian) <http://rusphysics.ru/dissertation/269/>
35. N.V. Kosinov. Experiments in wireless energy transmitting: proof of N. Tesla's revolutionary ideas, <http://kosinov.314159.ru/kosinov31.htm>
36. Wikipedia, Maxwell's equations, https://en.wikipedia.org/wiki/Maxwell%27s_equation
37. Khmelnik S.I. The Electromagnetic Wave in the Dielectric and Magnetic Circuit of Alternating Current, DNA-36.124, in Russian, <https://zenodo.org/record/3575097>
38. Leedskalnin's Perpetual Motion Holder, <http://www.leedskalnin.com/LeedskalninsPerpetualMotionHolder.html>
39. Khmelnik S.I. To the Theory of Perpetual Motion Holder. DNA-22.66; <https://zenodo.org/record/3557702>
40. Coulomb's Law (in Russian), https://ru.wikipedia.org/wiki/Закон_Кулона
41. Kapitsa P.L. On the nature of ball lightning. DAN USSR, 1955, Volume 1 (in Russian).
42. http://www.wikiznanie.ru/ru-wz/index.php/Паровая_молния (in Russian).
43. Khmelnik S.I. To the Question of Intranuclear Forces. DNA-27.127, in Russian, <https://zenodo.org/record/1318293>
44. Anatoly Mäkeläinen (Finland), Valery Buerakov (Ukraine). Flying on ball lightning, (in Russian) https://drive.google.com/file/d/0B4rZDrYTBG_pMFZ1RFNOd2hSTDA/edit

45. Khmel'nik S.I. Variational Principle of Extremum in Electromechanical and Electrodynamic Systems. Publisher by "MiC", printed in USA, Lulu Inc., ID 1142842, 2014, ISBN 9780557082315, <http://doi.org/10.5281/zenodo.3926034>
46. <https://www.youtube.com/watch?v=zQYFMJSKiu8>
47. Really working perpetuum mobile on magnets, part 2, <http://x-faq.ru/index.php?topic=4144.msg119758;topicseen#msg119758>
48. <http://x-faq.ru/index.php?topic=4144.new#new>, message 1271, 25.10.2016.
49. The magnetic field inside the capacitor (in Russian), <https://www.youtube.com/watch?v=RNkYd1mueYk>
50. Compass inside the condenser (in Russian), <https://www.youtube.com/watch?v=A4vO2rLvtug>
51. D.V. Sivukhin. The general course of physics. Volume 3. Electricity (in Russian).
52. Earth's magnetic field (in Russian), https://ru.wikipedia.org/wiki/Магнитное_поле_Земли
53. Earth currents, Wikipedia (in Russian), https://ru.wikipedia.org/wiki/Земные_токи
54. Khmel'nik S.I. The Electromagnetic Wave in a Spherical Capacitor and the Nature of Earth Magnetism, DNA-36.147, in Russian, <https://zenodo.org/record/3937557>
55. Khmel'nik S.I. Mathematical Model of Ball Lightning, DNA-33.179, 2015, in Russian, <https://zenodo.org/record/3574960>
56. Khmel'nik S.I. Second Mathematical Model of Ball Lightning, 2016-05-28, <http://lib.izdatelstwo.com/Papers2/molnia66eng.pdf>
57. Wen Y K. Dynamic tornado wind loads on tall buildings / Wen Y.K. // Journ. Of Struct. Div., Proc. ASCE, 1975, STI, p.169.
58. A.A. Vlasov. About vibration properties of electron gas, Journal of Experimental and Theoretical Physics, 1938, Vol. 8 (3), in Russian, http://ufn.ru/ufn67/ufn67_11/Russian/r6711f.pdf, https://ru.wikipedia.org/wiki/Уравнение_Власова
59. P.B. Rutkevich, P.P. Rutkevich Axisymmetric model of tornado type instability, in Russian, http://d33.infospace.ru/d33_conf/2011v8n4/76-82.pdf
60. Spouts and Tornado (in Russian),

- http://www.krugosvet.ru/enc/nauka_i_tehnika/fizika/smerchi_i_tornado.html?page=0,3
61. Modelling of the "eye" of cyclones, tornados, tornadoes, global ocean currents, in Russian, http://old.msun.ru/vector/Konuhov_ATR/Glaz_ciklona.htm
 62. Artsimovich L.A., Sagdeev R.Z. Plasma physics for physicists. M.: "Atomizdat", 1979 (in Russian).
 63. Ivanov V.V. Course of general physics (in Russian). http://lms.physics.spbstu.ru/pluginfile.php/2134/mod_resource/content/1/opt_1_03.pdf
 64. Igor Ivanov. Twisted light and twisted electrons: review of the recent results, http://elementy.ru/nauchno-populyarnaya_biblioteka/432009/Zakruchennyy_svet_i_zakruchennyye_elektrony_obzor_poslednikh_rezultatov
 65. Goldstein, LD, Zernov, N.V. Electromagnetic fields and waves. The second edition, revised and enlarged. Ed. "Soviet Radio", Moscow, 1971. - 665 p.
 66. Charging the capacitor with a fork Avramenko from zero, forum <http://x-faq.ru/index.php?topic=4203.0>, in Russian.
 67. R.A. Milroy, Hydrodynamic Gyroscope, <http://appliedmechanics.asmedigitalcollection.asme.org/article.aspx?articleid=1398258>, as well as <http://izdatelstwo.com/clicks/clicks.php?uri=lib.izdatelstwo.com/Papers2/MilroyFromMilroy.pdf>.
 68. Igor Beletsky, Engine from Bearing, (in Russian), <https://www.youtube.com/watch?v=dQUkWFwCxrE&list=TLn9vNCag6KRUXMjA2MjAxNg>
 69. A strange electric motor, <https://www.youtube.com/watch?v=i7LOF1GZpdo>
 70. Timur Khodzhev. Milroy engine, ver. 3.2, <https://www.youtube.com/watch?v=XuLqsdHqoPI>
 71. Spins and no one and no one explains why IT is spinning, in Russian, <https://www.youtube.com/watch?v=zuGDnWEQE94>
 72. Unusual engine (part 2), in Russian, <https://www.youtube.com/watch?v=k04Ifn2SVj4>
 73. Self-rotation or the Huber effect, in Russian, <https://www.youtube.com/watch?v=lgaOsnOyMxY>
 74. Silvestrov AN, Zimenkov DK On the nature of the moment in the Kosyrev-Milroy engine. National Technical University

- of Ukraine (NTUU "KPI"), in Russian,
<http://izdatelstwo.com/clicks/clicks.php?uri=lib.izdatelstwo.com/Papers2/Silvestrow.pdf>
75. Kuzmin VV, Doctor of Technical Sciences, prof., Shpatenko. Vs about the Nature of Appearing a Rotating Moment in the Engine of Kosyrev-Milroy, in Russian,
<http://izdatelstwo.com/clicks/clicks.php?uri=lib.izdatelstwo.com/Papers2/Kuzmin.pdf>
76. Andrus V.F. Explaining the effect of Huber from the position of neutron sciences, in Russian,
<http://izdatelstwo.com/clicks/clicks.php?uri=lib.izdatelstwo.com/Papers2/Andrus.pdf>
77. N.N. Sinelnikov. On the effect of Huber, in Russian,
<http://izdatelstwo.com/clicks/clicks.php?uri=lib.izdatelstwo.com/Papers2/Sinelnikow.pdf>
78. Khmelnik S.I. Electromagnetic Energy Flow in the Wire and Milroy Engine, 2015-11-16,
<http://lib.izdatelstwo.com/Papers2/MilroyE.pdf>
79. <https://www.youtube.com/watch?v=BM9waVSfc4s>
80. Nikolaev G.V. Modern electrodynamics and the reasons for its paradox. - Tomsk: The Stronghold, 2003 - 149 p., in Russian.
81. N.A. Umov. Beweg-Gleich. Energie in cintin. Kopern, Zeitschriff d. Math und Phys., v. XIX, Slomilch, 1874.
82. V.V. Kosyrev, V.D. Rabko, N.I. Welman. Electrical engine. Invention of the USSR, No. 1521216, 1963, in Russian.
83. <https://ru.wikipedia.org/wiki/Индуктивность>
84. Khmelnik S.I. Explanation of the Huber Effect, DNA-29.176, in Russian, <https://zenodo.org/record/3574432>
85. Khmelnik S.I. Electromagnetic Energy Flow in the Wire and Milroy Engine, 2015-11-16,
<http://lib.izdatelstwo.com/Papers2/MilroyE.pdf>.
86. A. Eichenwald. Electricity, M.L. 1933, paragraph 282,
<http://books.e-heritage.ru/book/10074637>
87. V.Ye. Fortov, A.G. Khrapak, S.A. Khrapak, V.I. Molotkov, O.F. Petrov./ Dusty plasma, UFN, May 2004, in Russian,
<http://ufn.ru/ru/articles/2004/5/b/>
88. Dusty plasma, https://en.wikipedia.org/wiki/Dusty_plasma
89. Experiments with plasma in space, in Russian,
<https://www.youtube.com/watch?v=SI406HKLYkM>

90. V.N. Tsytovich, G.E. Morfill, V.E. Fortov, N.G. Gusein-Zade, B.A. Klumov and S.V. Vladimirov. From plasma crystals and helical structures towards inorganic living matter. New Journal of Physics, Volume 9, August 2007, <http://iopscience.iop.org/article/10.1088/1367-2630/9/8/263/meta>
91. Dusty plasma hints at a molecule of life, in Russian, <http://www.membrana.ru/particle/693>.
92. <http://akb-darom.ru/vse-o-akb/Вес-аккумулятора.html>
93. <http://www.magntech.ru/aging.htm>
94. Kuligin V.A, Kuligina G.A, Korneva M.V. Phase velocity, group velocity and energy transfer rate, Voronezh University, deposited at VINITI 24.07.90, <http://www.efir.com.ua/tmp/velrus.pdf>, <http://izdatelstwo.com/clicks/clicks.php?url=lib.izdatelstwo.com/Papers2/velrus.pdf>
95. G.M. Graham, D.G. Lahoz. Observation of static electromagnetic angular momentum in vacua, Nature, 285, 154, 1980.
96. A. Stasenko. Why be a capacitor in a magnetic field? QUANTUM, 1998, No. 5, <http://lib.izdatelstwo.com/Papers2/CondVrasch.pdf>
97. Ivanov G.P. Fundamentals of Electrodynamics Ether-supported Movement and Inner-ether Energetics the theory without any hypotheses, <http://www.tts.lt/~nara/>, <http://www.tts.lt/~nara/strogijrus.htm>, <http://www.tts.lt/~nara/chast1.htm>
98. R.I. Grabovsky. Course of Physics. Textbook, allowance for agricultural institutes. Ed. 4 th, revised and additional. M., "Higher education. school", 1974, 552 c., http://books.alam.ru/book_phis.php, §83. Capacitor. The energy of the electric field, http://books.alam.ru/book_phis.php?id=84
99. Ivanov G.P., Ivanov Y.P. Method of obtaining tractive effort, Patent RU-2172865, 1999, (in Russian), <http://www.tts.lt/~nara/patent/patent.html>
100. Electromagnetic Thruster, USA Patent 2014013724, https://en.wikipedia.org/wiki/RF_resonant_cavity_thruster.
101. Electrostatic motor, USA Patent 1974483, http://en.wikipedia.org/wiki/Biefeld%E2%80%93Brown_effect

-
102. S.I. Khmelnik. A capacitor engine for an aircraft, Israel Patent 200435, 2009.
 103. R. Shawyer. Superconducting microwave radiation thruster, PCT/GB2016/050974, 2016,
<https://patentscope.wipo.int/search/en/detail.jsf?docId=W02016162676>
 104. NASA Team Claims 'Impossible' Space Engine Works—Get the Facts,
<http://news.nationalgeographic.com/2016/11/nasa-impossible-emdrive-physics-peer-review-space-science/>
 105. China Claims Its Made the Impossible EmDrive Possible,
<https://futurism.com/china-claims-its-made-the-impossible-emdrive-possible/>
 106. S.I. Khmelnik. Unsupported Motion Without Violating the Laws of Physics. DNA-28, 2014,
<https://zenodo.org/record/3549487>
 107. Jackson, John D. Classical Electrodynamics (3rd ed.). New York: John Wiley & Sons, 1999
 108. Yu.V. Pimenov, V.I. Volman, A.D. Muravtsov. Technical electrodynamics. Edited by Yu.V. Pimenov, Moscow, 2002 г., 536 p. (in Russian).
 109. V.A. Neganov, D.P. Tabakov, D.P. Yarovoi. Modern theory and practical applications of antennas. Editor Neganov V.A. Publ. «Radio engineering», Moscow, 2009, 720 pages (in Russian).
 110. Antennas: Theory and Practice», Sergei A. Schelkunoff and Harald T. Friis, Bell Telephone Laboratories, New York: John Wiley & Sons, 1952.
 111. Zaitsev VF, Polyanin AD Handbook of ordinary differential equations. Moscow, FIZMATLIT, 2001, 576 pages (in Russian).
 112. John D. Jackson. Classical Electrodynamics. John Wiley & Sons, Inc/ New York –London, 1962. - 703 pages.
 113. See [45].
 114. <https://en.wikipedia.org/wiki/Magnetoresistance>
 115. S.I. Khmelnik. Solution of Maxwell's equations for a capacitor with alternating voltage, 2017-10-15 (in Russian).
 116. Lemeshko Andrey. Magnetic battery, (in Russian)
http://samlib.ru/l/lemeshko_a_w/as.shtml.
 117. The journal "Young technician", 1992, № 08, (in Russian)
<http://zhurnalko.net/=sam/junyj-tehnik/1992-08--num65>.
-

118. A. Ilyin, Yu. Prokoptsev. DO FOR A SCHOOL. About how Volodya Mislavsky helped James K. Maxwell, the magazine "Young Technician", 2004 № 02, (in Russian)
<https://profilib.net/chtenie/32537/zhurnal-yunyy-tekhnik-yunyy-tekhnik-2004-02-lib-13.php>.
119. Khmelnik S.I., Khmelnik M.I. Analysis of Energy Processes in Searle's Generator. DNA-7.80, 2007,
<https://zenodo.org/record/1318873>
120. Zatsarinin S.B. About the cunning Transformer,
<http://lib.izdatelstwo.com/Papers2/Zazarinin.pdf>
121. Vitaliy Pozynic, Coaxial Transformer, 284, (in Russian)
https://www.youtube.com/watch?time_continue=8&v=hgmU4g4lpsI.
122. Revyakin P.Yu. Energy transfer through dielectric, DNA-45.101, 2018, in Russian,
<https://zenodo.org/record/2588411>
123. S.A. Semikov. About surface electroconductivity. "Nature", No. 12, 2004, (in Russian)
http://vivovoco.astronet.ru/VV/JOURNAL/NATURE/12_04/SURFCOND.PDF.
124. Khmelnik S.I. Energy processes in non-fuel electromagnetic generators. Publisher by "MiC", printed in USA, Lulu Inc., ID 10060906, ISBN 978-1-257-08919-2, 2011, 84 p.
125. Revyakin P.Yu. Magnetic battery. Observations and experiments. DNA-45.109, 2018, in Russian,
<https://zenodo.org/record/2588411>
127. Torshin V.V. Spiral formations in nature and electrodynamics, - M.: TsP VASIZDAST, 2008, – c. 251, ISBN 5911900297,
<http://www.trinitas.ru/rus/doc/0231/008a/1092-tr.pdf>
128. L.A. Pamyatny, V.E. Ivanov, G.S. Kandaurova. Guide to laboratory and practical classes "Magneto-optical installation for the study of domain and micromagnetic structures in constant and alternating magnetic fields." Ural State University. Ekaterinburg, 2007,
http://clar.urfu.ru/bitstream/10995/1321/4/1324749_guide.pdf
129. D.V. Moiseev, Hypothesis about the form of the field surrounding a permanent magnet or torsmagnetic field. Dialogues on Science, ISSN 2074-7284, №1, 2014, стр. 44,
<https://torsmagnit.jimdo.com/>

-
130. Khmelnik S.I. Levitation of rotating disks, DNA-45.136, 2019, in Russian, <https://zenodo.org/record/3937550>
 131. Mikhail Lavrinenko. High voltage motor,
 - a) <https://pandoraopen.ru/2015-10-21/dvigatel-vysokogo-napryazheniya-mixail-lavrinenko-svobodnaya-energiya/>
 - b) <https://lenr.su/forum/index.php?threads/bezopornaja-tjaga-v-vakuume-nesimmetrichnye-dvigateli-vysokogo-naprzazhenija.23/>
 132. F. Kaczmarek. Introduction to the physics of lasers. Translation from Polish. Ed. Mir, Moscow, 1981, 540 pages.
 133. Igor Beletsky. The magnetic keeper surprises again, https://www.youtube.com/watch?time_continue=2617&v=J912WdC7Od4
 134. Davis's. Manual of Magnetism, Boston, 1842, https://www.princeton.edu/ssp/joseph-henry-project/daniel-davis-jr/Davis_s_Manual_of_Magnetism_1842.pdf
 135. V.I. Beloded. Electrodynamics. Moscow-Minsk, 2011.
 136. Ghostly battles, http://paranormal-news.ru/news/prizrachnye_bitvy/2013-02-12-6246
 137. Vladimir Elagin. Mirages of the great battle. "Arguments and Facts - Kursk", February 20, 2008, <http://othereal.ru/mirazhi-velikoj-bitvy/>
 139. Bogach, V. A. A hypothesis about the existence of a static electromagnetic field and its properties. Preprint 13-96-463. Dubna, Russia, 1996, <http://lib.izdatelstwo.com/Papers2/Bogach.pdf>
 140. O. Heaviside, "Electromagnetic theory", London, 1893.
 141. E. Madelung. Mathematical apparatus of physics. Publ. «Nauka», Russia, 1968.
 142. Gunner Sendberg. Antigravity. Searle effect, <http://www.ufolog.nm.ru/artikles/searl.htm>
 143. Forum "x-faq". Flying disk Azanova V.N. [part 1], <http://x-faq.ru/index.php?topic=3158.msg74878#msg74878> (message 37), <http://x-faq.ru/index.php?topic=3158.msg71829#msg71829> (message 17, time 2.15).
 144. Ivanov G.P. This is not FLYWHEEL or the first steps of real physics, <http://www.sciteclibrary.ru/rus/catalog/pages/4225.html>, and also <http://www.tts.lt/~nara/chast1.htm>
-

145. Dynamo Theory. Wikipedia,
https://en.wikipedia.org/wiki/Dynamo_theory
146. Stellar magnetic field, Wikipedia,
https://en.wikipedia.org/wiki/Stellar_magnetic_field
147. Ivanov G.P. Justification of the existence of ether-supporting forces in classical electrodynamics. DNA-15.120, 2010, in Russian, <https://zenodo.org/record/3566217>
148. Forum: In addition to the topic "EPS and Grebennikov Platform" [part 2]", ответ #4707: 09.04.2019, 21:40:45.
149. Effect moving of winding of transformer effect,
<http://zaryad.com/forum/threads/ehffekt-dvizhenija-obmotki-v-transformatore.9172/>, Ersh, 12 February 2017.
150. G.A. Markov. Transformer. Canadian Patent # 2,224,708 1997-10-23,
<http://www.rexresearch.com/markov/ca2224708.pdf>
151. Gennady MARKOV. Bidirectional Transformer,
<http://www.rexresearch.com/markov/markov.htm>
152. Forum: "Faraday Unipolar Generator (Part 4)", Vladimir, answer # 5896: 04/24/2019, 11:17:24 PM (see also «Experimenteller Bweis, dafs ein efektdynamischer Schraubendraht noch kein Magnet ist»,
<https://docslide.net/documents/experimenteller-beweis-dass-ein-elektrodynamischer-schraubendraht-noch-kein.html>)
153. Gerasimov S.A. Durymanov V.A. Magnetic field of a rotating uncharged body. International Journal of Applied and Fundamental Research. - 2015. - № 11 (part 5) – C. 614-618,
<https://applied-research.ru/ru/article/view?id=7847>
154. Barnett effect. Virtual Fund of Natural Science, Scientific and Technical Effects,
<https://web.archive.org/web/20071216020349/http://www.effects.ru/science/87/index.htm>
155. Harold Aspden. Discovery of "VirtualInertia". New Energy News, volume2, number 10, February 1995,
<http://newenergytimes.com/v2/archives/fic/N/N199502s.PDF>
156. R.G. Sigalov. New research on the driving forces of the magnetic field. Ed. "Science" Uz. SSR. Tashkent, 1965.
157. Carles Paul. Cool G Experiment, 2018,
https://www.youtube.com/watch?time_continue=1&v=c_e3wTfqSwtl

158. T.L. Makarova. Magnetic properties of carbon structures. Physics and Engineering of Semiconductors, 2004, Vol. 38, no. 6, <https://journals.ioffe.ru/articles/viewPDF/5546>
159. Magnetic properties of organic compounds. Theoretical foundations of organic chemistry. Volume 2, 1958, <https://www.chem21.info/info/1368538/>
160. S.I. Khmelnik. Electromagnetic Keeper of Energy and Information. Canadian Journal of Pure and Applied Sciences, Vol. 13, No. 2, June 2019, Online ISSN: 1920-3853; Print ISSN: 1715-9997.
161. Zilberman G.E. Electricity and magnetism, Moscow, ed. "Science", 1970.
162. Experience with a steel ball in the magnetic field of the stator of an induction motor, <https://www.youtube.com/watch?v= IHjeEBJPvU>
163. Forum site "Auto electrician for all" <http://autodevice.ru/forum/index.php?s=fa784fcc53273c1d2f818b203418a7f8&act=ST&f=22&t=11094>
164. I. Beletsky. Aspden Effect, <https://x-faq.ru/index.php?topic=3389.new;topicseen#new>
165. Saveliev IV, Course in General Physics
166. Landau L.D., Livshits E.M., Theoretical Physics, vol. 3.
167. Petrakovich G.N. Nuclear reactions in a living cell, <http://www.rusphysics.ru/dissertation/219/>
168. Pyrokinesis, http://nenosfirs.ucoz.ru/load/nepoznannoe/fenomeny/cht_o_takoe_pirokinez_i_kak_ne_sgoret_slovno_spichka/79-1-0-251
169. Gamma ray, https://en.wikipedia.org/wiki/Gamma_ray
170. S.I. Khmelnik. To the Question of Intranuclear Forces. DNA-28.125, 2014, in Russian, <https://zenodo.org/record/3549473>
172. R.T. Fayzullin. Long radio echo: a new approach to the problem. Omsk State University (materials of the conference "SETI-XXI"), <http://www.astronet.ru/db/msg/1177361>.
173. Ufological dictionary-reference book, <http://ufodic.sochka.com/category/sh/page/2/>

174. Properties of black ball lightning,
<https://zen.yandex.ru/media/id/5b64456ebf4da000aaace9e3/svoistva-chernoi-sharovoi-molnii-5bbb55cba5bd5400a990d9cb>
175. OLDER REPORTS. BALL LIGHTNING REPORTS.
[Lazarus, talisman275 a yahoo com](https://www.lazarus.com/entry/275), Chicago, IL USA -
Tuesday, May 09, 2006 at 14:23:57 (PDT)
176. D.J. Shanefield. Organic Additives and Ceramic Processing,
Kluwer Academic Publ., Boston.
https://books.google.co.il/books?hl=en&lr=&id=O-rcBwAAQBAJ&oi=fnd&pg=PP10&dq=Organic+Additives+And+Ceramic+Processing&ots=sGC7eIyO2D&sig=foB1Iv7yquN--OftliVwAdvHpg&redir_esc=y#v=onepage&q=Organic%20Additives%20And%20Ceramic%20Processing&f=false
177. P.R. Leroueil, S. Hong, A. Mecke, J.R. Baker, Jr. B.G. Orr, M.M.B. Holl. Nanoparticle interaction with biological membranes: does nanotechnology present a Janus face? Accounts of chemical, 2007 - ACS Publications,
<https://pubs.acs.org/doi/abs/10.1021/ar600012y>
178. S.I. Khmelnik. About the Interaction of Nanoparticles. Determinations in Nanomedicine & Nanotechnology, DNN.000518, Volume - 1, Issue - 4, 2020
179. К.В. ТИТОВ. Эгрегоры и архетипы энергоинформационной цивилизации. Монография, НАУЧНОЕ ИЗДАНИЕ, МОСКВА, 2006
180. Khmelnik S.I. Gravitomagnetism: natural phenomena, experiments, mathematical models,
<http://doi.org/10.5281/zenodo.1403663>
181. Electromagnetic field energy density (by Russian),
<https://helpiks.org/6-65087.html>;
182. Energy and momentum of the electromagnetic field (by Russian),
http://fn.bmstu.ru/data-physics/library/physbook/tom4/ch1/texthtml/ch1_2.htm
183. 150 Years in the Stacks. A Treatise on Electricity and Magnetism by James Clerk Maxwell,
<https://libraries.mit.edu/150books/2011/01/19/1873/>
184. S.I. Khmelnik. Device for converting electromagnetic momentum to mechanical momentum,
<https://patentscope.wipo.int/search/ru/detail.jsf?docId=W/O2019145942>

-
185. https://en.wikipedia.org/wiki/History_of_Maxwell%27s_equations.
 186. Water memory, https://en.m.wikipedia.org/wiki/Water_memory
 187. Aleshkevich V.A. University course in general physics. Optics. Moscow, Fizmatlit, 2011, 320 p. (by Russian)
 188. NOVAKOVSAYA Yu.V. STRUCTURE OF MOLECULES. Moscow, Chemistry Faculty of Moscow State University (by Russian) <https://teach-in.ru/file/synopsis/pdf/molecular-structure-M.pdf>
 189. S.I. Khmelnik. To the rationale for homeopathy. Determinations in Nanomedicine & Nanotechnology, DNN.000501, Volume - 1, Issue - 5, 2020
 190. Water. The New Dimension (2013). Documentary, <https://www.youtube.com/watch?v=u4y1mNHW8is&feature=youtu.be&t=2333>
 191. Structured water, https://ru.wikipedia.org/wiki/Структурированная_вода
 192. Victor Lugovskoy, Doctor of Technical Sciences. The distributed brain of an ant family. "Science and Life", No. 3, 2007, https://elementy.ru/nauchno-populyarnaya_biblioteka/430445/Raspredeleenny_mozg_muravinoy_semi
 193. Kazhinsky B.B. Biological radio communications, <https://www.litmir.me/br/?b=61033&p=1>
 194. Stanislaw Lem. Solaris.
 195. K.V. Titov. Egregors and archetypes of energy-information civilization. Monograph, Scientific publication, Moscow, 2006.
 196. Alexander Kazakevich, "Thinking matter does not exist!", <https://cont.ws/post/193785>
 197. Khmelnik S.I. Reversibility of unipolar induction, DNA-48, 2020, <https://doi.org/10.5281/ZENODO.3707855>
 198. Khmelnik S.I. Energy flow and pulse of a static electromagnetic field, DNA-48, 2020, <https://doi.org/10.5281/ZENODO.3707863>
 199. Khmelnik S.I. Transmission of information in biological systems by water and air, DNA-48, 2020, <https://doi.org/10.5281/ZENODO.3712916>
 200. Khmelnik S.I. To the rationale for homeopathy, DNA-48, 2020, <https://doi.org/10.5281/ZENODO.3707863>
-

201. Khmelnik, S.I. Device for converting electromagnetic momentum to mechanical momentum, PCT/IL2019/050084, <https://patentscope.wipo.int/search/ru/detail.jsf?docId=W02019145942>, 2019.
202. Richard Fitzpatrick, Professor of Physics, Oscillations and Waves, <http://farside.ph.utexas.edu/teaching/315/Waves/Waveshtml.html>. Cylindrical waves, <http://farside.ph.utexas.edu/teaching/315/Waves/node47.html>
203. Cylindrical lenses: basic characteristics and applications, https://in-science.ru/library/article_post/cilindricheskie-linzy
- 204... Professor M. Dmitriev. Black Lightning, <http://n-t.ru/tp/mr/smb3.htm>
205. A. Bulygin. Investigations of the asymmetry of the magnetic field, NRNU MEPhI, Russia, 2018, <https://www.zeuthen.desy.de/students/2018/Summerstudents2018/Reports/Bulygin.pdf>
206. Bio-Savard-Laplace law, https://ru.wikipedia.org/wiki/Закон_Бю_—_Савара_—_Лапласа
207. Fresnel lens, https://en.wikipedia.org/wiki/Fresnel_lens; https://upload.wikimedia.org/wikipedia/commons/a/ab/Fresnel_lighthouse_lens_diagram.png