

## A study on load sensitive power generation in Hybrid Renewable Energy system using Evolutionary Algorithms based -Energy Management System control

Anindita Das Mondal<sup>1</sup>, Dr. Nasim Ali Khan<sup>2</sup>, Asif Ikbal<sup>3</sup>

<sup>1,2,3</sup>Department of Electrical Engineering, Aliah University, Kolkata 700156, India

E-mail: <sup>1</sup>aninditadasmondal1984@gmail.com, <sup>2</sup>knasim@gmail.com, <sup>3</sup>ikbalasif22@gmail.com

*Manuscript Received online 5/31/2020, Accepted 8/21/2020*

---

Electricity being an inevitable a non-substitutable demand of modern human society has always been an interesting domain to explore about. No doubt, in present day, a sustainable society and prospective human living can't be expected without sufficient electricity. Such significances lead industries to explore various source of energy and thus power system comes into existence to meet quality and reliability of power generation and transmission to the beneficiaries. On the contrary, exponentially rising demand in power requirements have put curves over the head of industries as well as governing agencies to enable optimal power supply for meeting the demands. To achieve this goal achieving novel and robust power generation, storage, transmission and allied control systems are of great significance. Undeniably, the exponential rise in population, industries and allied power demands has alarmed academia-industries to achieve eco-friendly and reliable sources of energy. Amongst major sustainable and eco-friendly energy sources, Renewable Energy Sources (RESs) like Wind-Turbine (WT), Photovoltaic (PV) cells, etc have emerged as the vital solutions. Realizing cost efficient and reliable power supply, integration of different RESs have gained immense attention globally, thus giving rise to a new power system concept named Hybrid RES (HRES) System. Amongst major HRES systems, WT-PV combination is the better option. However, non-linear nature of power generation makes overall HRES control intricate that demands robust control strategy by considering both non-linear power generation as well as dynamic load conditions. Load side variation often causes power outage and faults in the grid network. It motivates researchers to develop more efficient and reliable Energy Management System (EMS) to perform load and generation sensitive charging-discharging control for efficient EMS function. In this paper, the proposed PV-WT HRES model encompasses with variable speed controlled PMSG WT generator and EMS control units. For getting novel and robust EMS control function, the proposed model allows an Evolutionary Algorithm (EA) assisted PID controller to optimize PID gain parameters for efficient transient control. In this paper, Flower Pollination Algorithm (FPA) has been developed to be used for online PID tuning. The simulation results reveal that the proposed FPA based PID controller system showing better charging-discharging control even under dynamic load condition.

Keywords: Renewable Energy Sources, Hybrid-RES, Non-linear Load-Generation Sensitive EMS control, Metaheuristic Algorithm, Bi-directional Converter, Li-ion battery, Permanent Magnet Synchronous Generator, Wind Turbine, PID controller.

---

## Introduction

In recent years, the exponentially rise in electricity demand to meet residential, commercial and industrial power requirements have alarmed academia-industries to achieve more efficient source of energy while maintaining environmental sustainability. To fulfill such demands, Renewable Energy Sources (RESs) have emerged as the potential solution. Interestingly, features like eco-friendly, low cost, and sustainability make RESs the vital energy source for future. The future trends and new challenges for 2025 are briefly summarized for wind energy, solar energy, wave energy, fuel cells, and storage with batteries and hydrogen, separately [2]. The concept of Hybrid Renewable Energy Systems (HRES) is essential for today's scenario. Different types of the optimization tools and metaheuristic techniques can be used in renewable energies [7]. According to the BP statistical world review of world energy report -2018, is not satisfied demand as per today's need. It is an alarming condition that the world is on an unsustainable position [31]. The dynamic variation in load side might impose significantly huge change in energy consumption and hence can affect overall EMS. On the other hand, an inferior EMS system might lead sever damage of the infrastructure and may impose load shedding conditions. Under such circumstances developing a load sensitive EMS control model can be vital. Similarly, the non-linearity in power generation in HRES due to dependency on the local environmental conditions can make power transmission vulnerable. Thus, considering real-time dynamism in power generation, transmission and load conditions in the Hybrid-RES system containing PV cells and the Wind Turbine systems developing a

highly robust and efficient EMS control system is must.

A power grid with Hybrid-RESs requires battery storage units to store power generated from the individual RESs and make it at the reach of consumers [1][12]. To ensure optimal power distribution and transmission across the grid network, Energy Management System (EMS) and allied Battery Management System (BMS) are must. As stated, to enable quality power and reliable transmission enabling efficient charging and discharging of the battery system (i.e., BMS) can play significant role [16]. Developing a robust EMS and/or BMS solution by considering dynamic generation pattern as well as load variation can be of utmost significance to ensure reliable and safe power transmission for HRES power grid network [27]. To deal with such HRES non-linearity optimizing charging and discharging control in EMS by considering both power generation condition as well as load side variation can be stated as the driving force behind this research. Though, numerous efforts have been made for EMS control in RES systems [26], majority of the existing systems use traditional controllers such as PID controllers, Fuzzy controllers for state of charging and discharging control. Prominently, classical PID controllers use static gain parameters to perform charging-discharging control which may take more time in achieving convergence, especially for transient control. On the other hand, Fuzzy controllers require huge and precise membership functions to perform control that under exceedingly high non-linearity and dynamism seems highly complicate. Heuristic algorithm such as the Genetic Algorithm (GA), Particle Swarm Optimization, Ant Colony Optimization (ACO), etc. have been applied for PID gain parameter

estimation to be used in EMS control. Though, this metaheuristic algorithm assisted EMSs have augmented performance; however, the key issues like local minima and convergence makes them questionable to delivery optimal solution. It motivates authors to exploit and develop more efficient algorithms to perform enhanced PID assisted online EMS control in PV-WT based HRES systems. With this motivation, in this research paper, enhanced metaheuristic algorithm like Flower Pollination Algorithm (FPA) has been developed for PID gain parameter tuning that eventually leads more efficient and transient state of charging and discharging control. Unlike classical EMS control systems, proposed models apply ITAE error function as the objective function to perform algorithm (FPA) assisted PID gain parameter estimation that eventually perform generation and load-sensitive battery charging and discharging control. The MATLAB 2015b/SIMULINK based simulation with PV-WT HRES (photovoltaic-wind turbine Hybrid Renewable Energy System) system has revealed that proposed HRES model exhibits more swift charging-discharging control along with efficient WT speed control that as cumulative solution achieves maximum power generation while maintaining optimal power provision to the loads.

### Proposed method

This section primarily discusses about the functional components of the proposed PV-WT HRES system.

#### Power Grid Design:

Considering flexibility of the implementation and abundance in nature, our proposed HRES model encompasses PV-WT HRES system where WT power generator is selected for a power generation capacity of 3kW, while PV model with single diode design possesses

power generation capacity of 1kW. Here, we hypothesize that the difference in between the power generated by PV-WT HRES and the power demanded from load side over certain time period can be reduced by means of sizing. With this intend our proposed HRES power grid network embodies a stand-alone network with multi RESs. Here, the RESs considered functions independently and supplies power to the DC bus connected in series with PV-WT RESs. Furthermore, it can supply power to the Li-Ion batteries, as depicted in Fig. 1. As depicted in Fig. 1, considered PV-WT HRES design supplies power to the load continuously and facilitates load and generation non-linearity sensitive battery charging and discharging control.

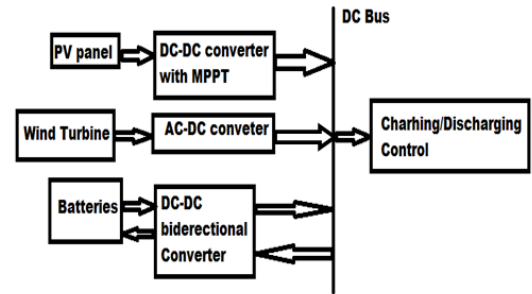


Fig. 1. PV-WT HRES power grid design

The detailed discussion of the above stated PV-WT design model is given as follows  
*Mathematical modelling of Single-Diode Photovoltaic (PV) Cell Based RES System*

Single-diode PV model contains a current source, one diode and two resistors, series and shunt resistor. Here, the photo generated current ( $I_p$ ) primarily replies on the output voltage ( $V_p$ ), which is mathematically derived as (1).

$$I_p = I_{sc} \left[ 1 - C_1 \left( e^{\frac{v_p - \Delta v}{c_2 v_{oc}}} - 1 \right) + \Delta I \right] \quad (1)$$

In equation (1), the constant parameters and state the constants, which can be obtained using equations (2) and (3), respectively

$$C_1 = \left(1 - \frac{I_{MPP}}{I_{SC}}\right) e^{\left(\frac{-V_{MPP}}{C_2 V_{oc}}\right)} \quad (2)$$

$$C_2 = \frac{\left(\frac{V_{MPP}}{V_{oc}} - 1\right)}{\ln\left(1 - \frac{I_{MPP}}{I_{SC}}\right)} \quad (3)$$

The current and voltage gradient parameters  $\Delta I$  and  $\Delta V$  can be estimated using equation (4).

$$\Delta T = T - T_{ref} \quad (4)$$

$$\Delta I = \alpha \left(\frac{L}{L_{ref}}\right) \Delta T + \left(\frac{L}{L_{ref}} - 1\right) I_{SC} \quad (5)$$

$$\Delta V = -\beta \Delta T - R_s \Delta I \quad (6)$$

As above equations, the parameters  $\alpha$  (5) and  $\beta$  (6) signify the temperature coefficients of the current and voltage, respectively. The other parameters and state the current solar radiation and solar radiation reference, respectively. These radiation parameters are measured in the unit of  $W/m^2$ . In equation (4), the temperature ( $T$ ) and the reference (cell) temperature ( $T_{ref}$ ) are measured in  $^{\circ}C$  units. In equation (5), the current components  $I_{SC}$  and  $I_{MPP}$  state the short-circuit current and the peak current at the Maximum Power Point (MPP) tracking condition. Meanwhile, voltage components and state the open-circuit voltage ( $V$ ) and the voltage at the MPP. The other parameter in equation (6) states the series resistance of the PV system ( $\Omega$ ).

#### Wind Turbine RES Generator

The mechanical output power of the wind turbine is represented by the cube law

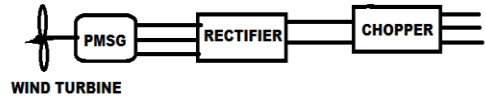
equation [27]

$$P_{wind} = \frac{1}{2} K C_p \rho A v^3 \quad (7)$$

Where  $\rho$  is air density ( $kgm^{-3}$ ),  $C_p$  is the power coefficient which is a function of tip speed ratio and blade angle. This relationship is basically provided by the turbine manufacturer.  $A$  is the wind turbine rotor swept area,  $v$  is the wind speed (m/s). The tip speed ratio is given by

$$\lambda = \frac{r \omega_t}{v} \quad (8)$$

In (8), the variable  $r$  refers the radius of the rotor (m), while the angular speed of the generator is denoted by  $\omega_t$  (rad/sec). Thus, the above stated WT design, the applied WT system can be symbolically presented as Fig. 2. Here applied WT model is designed based on the three-phase Diode Bridge armored with Buck converter that effectively transforms the rectified voltage.



**Fig 2** Rectifier and Chopper assisted WT RES system

In this research we have considered the work to design WT RES model. Mathematically it is estimated as (9),

$$\dot{x} = \begin{bmatrix} \dot{i}_q \\ \dot{i}_d \\ \dot{\omega}_e \end{bmatrix} = \begin{bmatrix} f_1 \\ f_2 \\ f_3 \end{bmatrix} + \begin{bmatrix} g_1 \\ g_2 \\ g_3 \end{bmatrix} u_w$$

$$= \begin{bmatrix} -\frac{r_s}{L} i_q - \omega_e i_d + \frac{\omega_e \Phi_{sr}}{L} \\ -\frac{r_s}{L} i_d + \omega_e i_q \\ \frac{P}{2J} \left( T_m - \frac{3P}{2} \Phi_{sr} i_q \right) \end{bmatrix} +$$

$$\begin{bmatrix} -\frac{\pi v_{DC} i_q}{3\sqrt{3}L\sqrt{i_q^2+i_d^2}} \\ \frac{\pi v_{DC} i_d}{3\sqrt{3}L\sqrt{i_q^2+i_d^2}} \\ 0 \end{bmatrix} u_w \quad (9)$$

$$i_w = \frac{\pi}{2\sqrt{3}} \sqrt{i_q^2 + i_d^2} u_w \quad (10)$$

As stated in above equation (10), the current components  $i_d$  and  $i_q$  signify the components homopolar which is nothing else but the direct and the quadrature three-phase currents, derived from the Park transformation. In equation (9),  $\omega_e$  states the electric angular velocity while  $r_s$  and  $L$  state the resistance and inductance parameters of the winding per phase the stator, correspondingly. Similarly,  $P$  states the total numbers of poles in the PMSG generator, while  $J$  states the inertia of the rotor component. Additionally,  $\Phi_{sr}$  signifies the flux generated due to the stator currents. The voltage component  $v_{DC}$  states the DC bus voltage while  $u_w$  signifies a duty cycle function (for the used converter). Mathematically it is estimated as  $u_w = 1/\delta$ . The current component  $i_w$  states the current generated from the turbine followed by injection to the DC bus as depicted in Fig. 1. The mechanical torque generated by the turbine is presented by the term  $T_m$ . Mathematically, torque generated can be defined as (11).

$$T_m = \frac{P_m}{\omega_e} \quad (11)$$

#### Energy Management in HRES Power Systems

Considering non-linearity in PVWT HRES system, assuring optimal EMS control is highly intricate task. It becomes more mammoth in case of exceedingly non-linearity in power generation, voltage depletion and drop across network, and varying load conditions. Considering it as motivation, in this research a

robust EMS control model is developed that considers both the dynamic load variation as well as generation pattern to perform charging-discharging control.

#### EA Assisted PID controller for Generation and Load Sensitive EMS Control

In fact, to exhibit optimal perform EMS control enabling optimal charging-discharging control is must; however, it turns out to be too complicate during exceedingly high non-linearity in load and generation. Typically, charging-discharging control functions based on system states like power generation patterns and the load variation. To achieve it, rules are applied on the basis of the instant system state requirements and thus the charging-discharging control is achieved. For example, in WT RES speed control unit applies the knowledge about motor speed and compares with the reference data which helps in executing rules for increasing or decreasing the motor power. Meanwhile, in charging-discharging control the load information can help in regulating charging discharging states and duration also called State of Charge (SOC) control. This research work applies both generation side non-linearity as well as load variation to perform charging-discharging control. We have applied PID based controller which has been further augmented with FPA assisted charging-discharging control. Primarily, here main focus on exhibiting PID gain parameter tuning to achieve better function.

Before discussing the proposed metaheuristics algorithms for PID control function, a snippet of PID controller is given as follows:

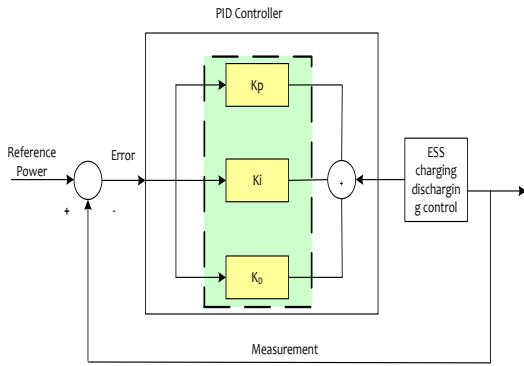
#### Proportional-Integral-Derivative(PID)Controller:

The function of a PID controller can be understood by equation (12). In EMS control

function, the following condition or gain parameter definition is applied in (13).

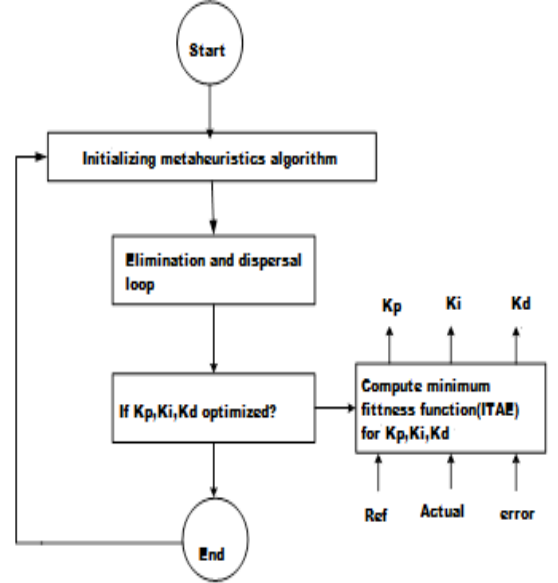
$$u(t) = K_p \left[ e(t) + \frac{1}{T_i} \int_0^t e(t) dt + T_d \frac{e(t)}{dt} \right] \quad (12)$$

$$G_{Controller} = K_p + K_d s + \frac{K_i}{s} \quad (13)$$



**Fig 3.** PID Controller for EMS control

In this research work emphasis is made on achieving optimal PID parameter tuning using metaheuristics algorithms. Here, flower pollination algorithm is used. The implementation strategy for the proposed algorithm assisted PID tuning is given in Fig. 4. Noticeably, for any heuristic based parameter optimization metaheuristics algorithms require achieving certain defined objective function for which error reduction (i.e., the difference between current value and the expected value) is the dominating measure. With this motivation, in this paper we have applied Integral Time Absolute Error (ITAE) function as the objective function to achieve optimal PID gain parameters.



**Fig.4** Metaheuristics Algorithm assisted PID parameter tuning for Generation and load sensitive EMS control

A snippet of the defined objective function is presented as follows

*Integral Time Absolute Error (ITAE)*

In this proposed metaheuristic based PID tuning model, the considered optimization algorithms intend to reduce ITAE iteratively so as to achieve optimal load and generation sensitive charging and discharging function. The robustness of ITAE in avoiding long duration transient and convergence makes our proposed ITAE-PID control function more efficient to assist real-time or online EMS control. Noticeably, in this proposed EMS model the difference between the load power and the generated power is considered to estimate error.

$$ITAE = \int_0^{\infty} t|e(t)|.dt \quad (14)$$

Once retrieving the minimum objective function  $e(t)$ , as stated in equation (14) the

gain parameters at that iteration is assigned to the PID controller to exhibit charging-discharging control.

*Flower Pollination Algorithm (FPA) Based Load and Generation Sensitive EMS Control*

In this paper, the aforesaid rules have been incorporated to perform update of the equations to be used for optimal solution. For illustration, in pollination phase gametes of the flower pollen are selected or taken by pollinators and thus the pollen can be capable of moving over a long distance. In this manner, as stated above the rule 1 of the FPA and flower dependability can be defined through (15).

$$x_j^{t+1} = x_j^t + \gamma L(\lambda)(x_j^t - \beta) \quad (15)$$

In above mentioned equation (15),  $x_j^t$  states the pollen  $j$  with the solution vector  $x_j$  at the step  $t$ . The other variable  $\beta$  signifies the current fittest solution amongst all feasible solution sets at the step or generation. Here, the variable  $\gamma$  controls the step size to perform best solution retrieval or movement towards the best solution.  $L(\lambda)$  refers the factor matching the pollination's potency and the step size. Since, insect can move and/or travel over a long distance or search space with different distance steps this feature has been incorporated through Levy's flight pattern (16).

$$L \approx \frac{\pi \tau(\lambda) \sin(\pi \lambda / 2)}{\pi} \cdot \frac{1}{s^{1+\lambda}}, (s) \gg s_0 > 0 \quad (16)$$

Where  $\tau(\lambda)$  signifies the gamma function to be applied for big steps  $s > 0$ .

On the other hand, to perform local pollination by

$$x_j^{t+1} = x_j^t + u(x_m^t - x_q^t) \quad (17)$$

In (17), the variable  $x_m^t$  and  $x_q^t$  signifies pollen belonging to the different flowers of the same plant (species). Noticeably, in case pollens,  $x_m^t$  and  $x_q^t$  belong to the same species or are taken from the same population, it turns out to be a local random walk if we draw  $u$  as of a standardized sharing in  $[0, 1]$ .

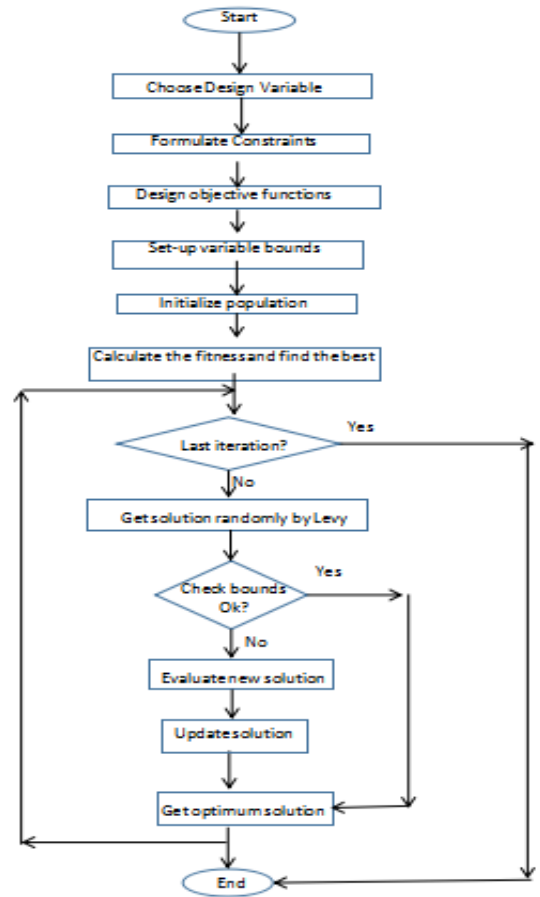
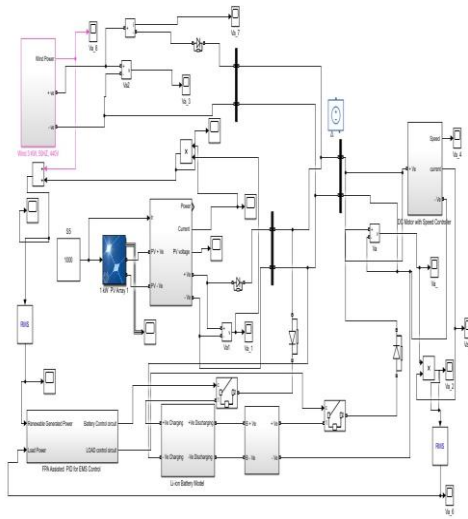


Fig.5 Workflow of FPA algorithm

This paper is assessed efficacy of the flower pollination algorithm for HRES design parameter estimation.

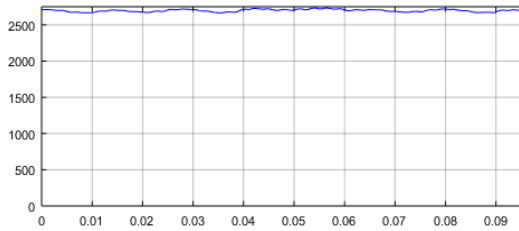
**Proposed model**

This research paper proposed a robust EMS control function for PV-WT HRES system where the emphasis was made on achieving load and generation sensitive EMS control under non-linear or dynamic conditions. Here, WT model with PMSG generator having maximum capacity of 3kW, while PV system was considered for single diode design with 1kW power capacity. A snippet of the developed HRES-EMS model is given in Fig. 6.

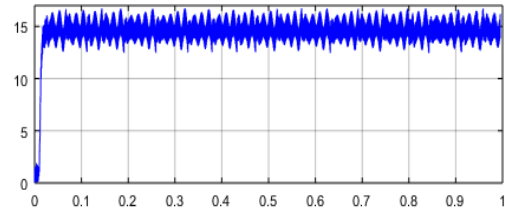


**Fig.6** Proposed PV-WT HRES EMS control model

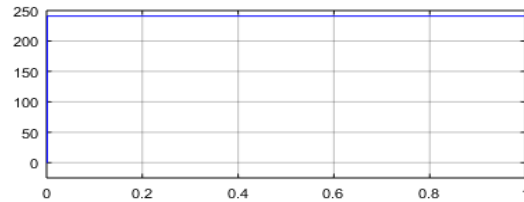
**Result and discussion**



**Fig.7** WT-RES Power generated with FPA-EMS control

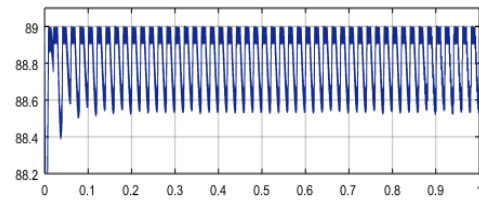


**Fig. 8** WT -RES current (A) generated with FPA-EMS control

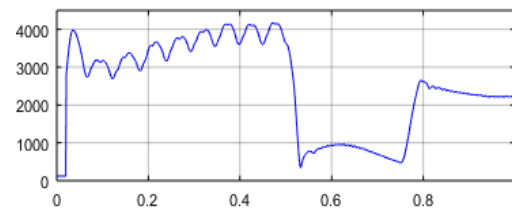


**Fig. 9** WT-RES voltage (V) generated with FPA-EMS control

In Fig. 7, the highest power generated was observed to be 2900 Watts by WT system, whose maximum capacity is 3000 W. Fig. 8 and Fig. 9 exhibit the current and voltage generated by WT, respectively.

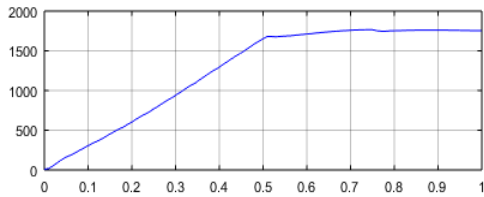


**Fig. 10** PV-RES generated power (W) with FPA-EMS control

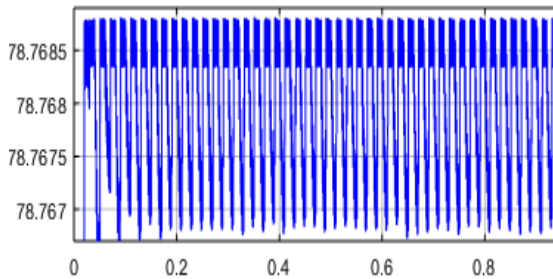


**Fig. 11.** Load side demand variations with FPA-EMS

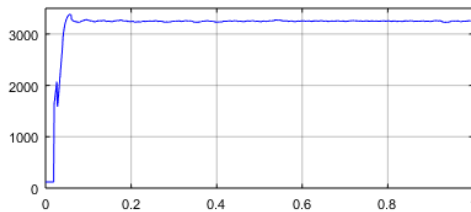




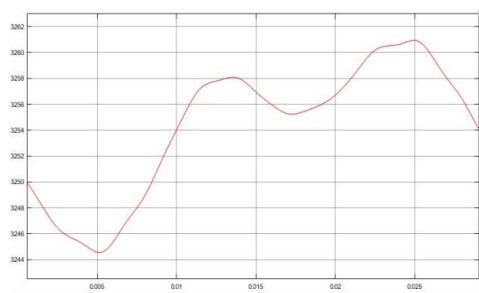
**Fig. 12.** Speed control variation with FPA-EMS



**Fig. 13** Switching control with FPA EMS model



**Fig.14** Proposed PV-WT HRES based overall power (W) generation with FPA-EMS control



**Fig.15** Hybrid generated power FPA-EMS Control

Fig. 10 exhibits PV RES generated power. Fig 11 shows non linear load side demand variations. Fig 12 shows speed control variation during dynamic load conditions. Fig. 13 shows switching control. Fig 14 exhibits the overall power generated by proposed PV-WT HRES system. The maximum power generated with FPA-PID based (load sensitive) EMS control was found to be 3840 Watts. In this paper hybrid generated power in Fig 15 also shows a better result compared to [20]. The maximum value reaches at the point (x=0.1) from 3240 Watt [20] to 3260 W. It can be observed that algorithm in paper [20] and FPA algorithm both near-similar performance however FPA gives slightly more output power under load and generation sensitive charging and discharging control. FPA-PID which emphasizes on retrieving optimal solution by exploiting search space, has depicted better and stable performance. However, superiority of these heuristics approaches for PID tuning in EMS control can't be ignored. As contribution, this research paper recognizes FPA based PID controller for EMS control in HRES system to ensure reliable and quality power delivery to the customers.

#### CONCLUSION

In this research work proposed metaheuristic algorithm based PID systems like flower pollination based PID tuning to perform swift and transient charging-discharging control for PV-WT HRES power system. One noticeable contribution is the inclusion of load and generation sensitive EMS followed by condition-awareness based WT speed control that helps in overall performance augmentation. Simulation results reveal that the proposed FPA based PID for EMS control can achieve more efficient performance and

hence can be applied for real-time power grid management for reliable quality power supply.

#### REFERENCES

- [1] Abbey C and Joos G, "Supercapacitor energy storage for wind energy applications," *IEEE Trans. Ind. Appl.*, vol. 43, no. 3, pp. 769–776, 2007.
- [2] Blaabjerg Frede and Ionel Dan M "Renewable Energy Devices and Systems –State-of-the-Art Technology, Research and Development, Challenges and Future Trends", *Electric Power Components and Systems*, 43(12):1319–1328, 2015.
- [3] Bellini A, Bifaretti S, Iacovone V and Cornaro, "Simplified Model of a Photovoltaic Module", *Applied Electronics*, 2009.
- [4] Carrasco J, Franquelo L, Bialasiewicz J, Galvan E, Guisado R, Prats M, Leon J, and Moreno-Alfonso N, "Power-electronic systems for the grid integration of renewable energy sources: A survey," *IEEE Trans. Ind. Electron.*, vol. 53, no. 4, pp. 1002–1016, 2006.
- [5] Deshmukh M.K, Deshmukh S.S", Modeling of hybrid renewable energy systems", *Renewable and Sustainable Energy Reviews* 12 (2008) 235– 249.
- [6] Ellabban Omar, FredeBlaabjerg Haitham Abu-Rub," Renewable energy resources: Current status, future prospects and their enabling technology" *Renewable and Sustainable Energy Reviews* 39(2014)748–764.
- [7] Fathima A. Hina, Palanisamy K," Optimization in microgrids with hybrid energy systems – A review", *Renewable and Sustainable Energy Reviews* 45(2015) 431–446.
- [8] Garcia Pablo, Torreglosa Juan P., Fernandez Luis M., Francisco Jurado, "Optimal energy management system for stand-alone wind turbine/photovoltaic/hydrogen/ battery hybrid system with supervisory control based on fuzzy logic", *International Journal of Hydrogen Energy* 38 (2013) ,14146-14158.
- [9] Guangqian Du, Bekhrad Kaveh, Azarikhah Pouria, Maleki Akbar "A hybrid algorithm-based optimization on modeling of grid independent biodiesel-based hybrid solar/wind systems", *Renewable Energy* 122 (2018) 551-560.
- [10] Gupta Anil, Shandilya Arun,"Challenges of Integration of Wind Power on Power System Grid-A Review", *International Journal of Emerging Technology and Advanced Engineering*, Volume 4, Issue 4, April 2014.
- [11] Garcia-Gonzalez J., de la Muela R., Santos L, and Gonzalez A., "Stochastic joint optimization of wind generation and pumped-storage units in an electricity market," *IEEE Trans. Power Sys.*, vol. 23, pp. 460–468, 2008.
- [12] Ibrahim H, Ilinca A, and Perron J, "Energy storage systems – characteristics and comparisons," *Renewable Sustainable Energy Rev.*, vol. 12, no. 5, pp. 1221–1250, 2008.
- [13] Lu T, Wang Z, Ai Q and Lee W. J, "Interactive Model for Energy Management of Clustered Microgrids," in *IEEE Transactions on Industry Applications*, vol. 53, no. 3, pp. 1739-1750, May-June 2017.
- [14] Maiti Deepyaman, Acharya Ayan, Chakraborty Mithun, Konar Amit,"Tuning PID and PI<sup>λ</sup>D<sup>δ</sup> Controllers using the Integral Time Absolute Error Criterion", *IEEE*, 978-1-4244-2900-4/08/\$25.00 @2008.
- [15] Martins Fernando G,"Tuning PID Controllers using the ITAE Criterion", *Int. J. Engng Ed.* Vol. 21, No. 5, pp. 867-873, 2005.

- [16] Marko Stefan, Darul'a Ivan, "Large Scale Integration Of Renewable Electricity Production Into the Grids," *Journal of Electrical Engg*, vol. 58, no.1, pp.58–60, 2007.
- [17] Oriti Giovanna , Anglani Norma, Julian Alexander L, "Hybrid Energy Storage Control in a Remote Military Microgrid with Improved Supercapacitor Utilization and Sensitivity Analysis", 2018 *IEEE*.
- [18] Olatomiwa Lanre, Mekhilef Saad, Ismail M. S, Moghavvemi M, "Energy management strategies in hybrid renewable energy systems: A review", *Renewable and Sustainable Energy Reviews* 62(2016)821–835.
- [19] Sikder Partha Sarothi, Pal Nitai, "Modeling of an intelligent battery controller for standalone solar- wind hybrid distributed generation system", *Journal of KingSaud University-Engineering-Sciences*.  
<https://doi.org/10.1016/j.jksues.2019.02.002>.
- [20] Shivakumar S. B., Kumar Sampatha. Patil V, "Enhancement of Energy Management System of Hybrid Renewable System by HSS", *IJIREICE*, Vol. 5, Issue 9, September 2017.
- [21] Tahani Mojtaba, Babayan Narek, Pouyaei Arman," Optimization of PV/Wind/Battery stand- alone system, using hybrid FPA/SA algorithm and CFD simulation, case study: Tehran", *Energy Conversion and Management* 106 (2015) 644– 659.
- [22] Taha M. S, Abdeltawab H. H. and Mohamed Y. A. R. I, "An Online Energy Management System for a Grid-Connected Hybrid Energy Source," in *IEEE Journal of Emerging and Selected Topics in Power Electronics*.
- [23] Zhou H, Bhattacharya T., Tran D., Siew T., and Khambadkone A., "Composite energy storage system involving battery and ultracapacitor with dynamic energy management in microgrid applications," *IEEE Trans. Power Electron.*, vol. 26, no. 3, pp. 923–930, 2011.
- [24] Bouharchouche E. M, Berkouk and Ghennam T, "Control and energy management of a grid connected hybrid energy system PV-wind with battery energy storage for residential applications," *201 Eighth International Conference and Exhibition on Ecological Vehicles and Renewable Energies (EVER)*, Monte Carlo, 2013, pp. 1-11.
- [25] Khadem S.K., Basu ,M.F.Conlon, "Power Quality In Grid Connected Renewable Energy Systems: Role Of Custom Power Devices" *International Conference On Renewable Energies and Power Quality, Spain*, vol.III, pp.23-25 March 2010.
- [26] Khalid M., SavkinA.. V. and Agelidis V.G., "Optimization of a power system consisting of wind and solar power plants and battery energy storage for optimal matching of supply and demand," 2015 *IEEE Conference on Control Applications, Sydney, NSW*, 2015, pp. 739-743.
- [27] Li X, Hui D, Xu M, Wang L, Guo G and Zhang L, "Integration and energy management of large-scale lithium-ion battery energy storage station," *2012 15th International Conference on Electrical Machines and Systems (ICEMS)*, Sapporo, 2012, pp. 1-6.
- [28] Trifkovic M, Sheikhzadeh M, Nigim K and Daoutidis P, "Hierarchical control of a renewable hybrid energy system," *2012 IEEE 51st IEEE Conference on Decision and Control*, Maui, HI, pp. 6376-6381, 2012
- [29] BP Statistical Review of World Energy 2019 | 68th Edition.
- [30] K. Ogata, *Modern Control Engg.*, 4th ed., New Jersey, Prentice Hall, 2001.