

Comparative Analysis of a Three-Phase Inverter with Different Loads



Meshari J. AlJandal, Muhammad R. Jamal, Khaled S. AlRasheed

Abstract: DC-AC inverters play a crucial factor in the modern era to satisfying the demand of energy conversion, which is definitely for a better lifestyle and developing smart facilities. In this paper a deeper study has been taken place to understand the behavior of the inverter base on three phase bridge inverters. The scenarios for the inverters respectively with pure resistive loads R and inductive resistive loads RL are both discussed. The term load is referring to the brushless DC motor (BLDC) which is more reliable than regular or permanent magnet DC motors, this study will help to understand the effect of these components in the inverters. These effects could be related to friction and other electrical problem such as spark which they are associated with the DC components' operation. Moreover, solving differential equations numerically using powerful software such as MATLAB, which certainly solidify the comprehension of the system operation. The inverter was simulated using MATLAB as a variable DC and AC power supply to in investigate the effect of varying the parameters of the reference input signals such as carrier frequency, duty cycle and the output load such as inductance. Finally, a flowchart of the system is included described both hardware and software.

Keywords: DC-AC converters; three-phase inverters; inverters; sinusoidal PWM; MATLAB/Simulink; Resistive-Inductive loads.

I. INTRODUCTION

A. Inverter simulation

The inverter was simulated numerically in MATLAB/Simulink as shown in (appendix A), and the motor impedance was represented by a series of connected resistor and inductor, demonstrating a real Brushless DC delta motor (Model no. DPM42BL41), labeled with values $R=47\Omega$ and $L=3.3mH$. The model of the inverter works as a singlephase variable DC power supply and a singlephase variable frequency AC power supply with fixed duty cycle pulse width modulation PWM. During the simulation the parameters of power supply were modified in order to understand the behavior of the inverter output response as the following simulation test:

B. Simulation 1 – Variable DC supply:

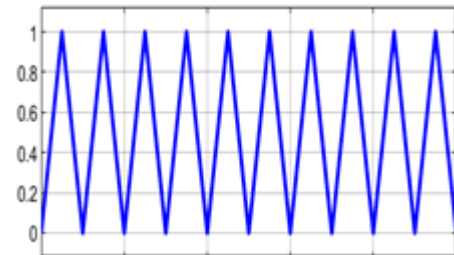

Figure (1.1): Triangle carrier waveform [0, 1] 50%

The triangular wave carrier was configured to generate a frequency of 20 kHz and varying the amplitude from 0 to 1, as shown in the (Figure 1.1). The reference value of the input was set to 0.5, corresponding to 50% of the duty cycle. The output waveform of the current produced from the system is presented in the Figure 1.2. It was observed that the output signal of the current converges to 0.2553 A at 0.3ms, the response follows the exponential function behavior. The waveform was fluctuating around the mean value of the current because of the triangle wave carrier generated form modulation algorithm of the embedded system.

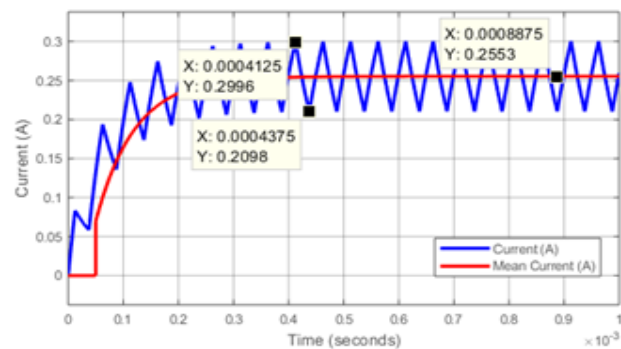

Figure (1.2): Current response (Blue) and the mean value of the current (Red)

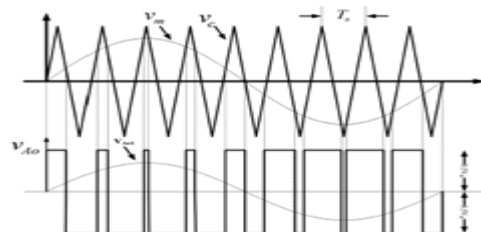

Figure (1.3): Modulation principle of the system

Manuscript received on September 09, 2021.
Revised Manuscript received on September 16, 2021.
Manuscript published on September 30, 2021.

* Correspondence Author

Meshari J AlJandal, Department of Electrical Engineering from Kuwait University, located in Kuwait

Khaled S AlRasheed, Department of Electrical and Electronics Engineering from New Mexico State University located in Kuwait

Muhammad R A A Jamal*, Member of Training Staff, Higher Institute of Energy PAAET, Kuwait

© The Authors. Published by Blue Eyes Intelligence Engineering and Sciences Publication (BEIESP). This is an open access article under the CC BY-NC-ND license (<http://creativecommons.org/licenses/by-nc-nd/4.0/>)

Comparative Analysis of a Three-Phase Inverter with Different Loads

According to Peddapelli (2016), these strategies are used for shaping the output waveform with respect to the target of the input reference. However, in the case of the inverter the fluctuating had caused a plenty of harmonics that affected the quality of the waveform output, or maybe it was reduced if a perfect switching was obtained. The working principle is ascertained by comparing the reference input with the triangle carrier through the relational operator. As a result, if the value of the triangle signal at instant time was lower than 0.5, the relational function output gives logic 1, otherwise logic 0 as shown in the above (Figure 1.3). Then, the output voltage was converted to a high level voltage, 0v and 24v according to the logic 0 and 1 of relational function, respectively. These voltage pulses fed to the RL load (equivalent to model of standard DC motor), led to a delay time in current output response was observed due to the effect of inductor. The effect of modifying the reference input value was also investigated, hence the reference input value changed to 10%, 50%, 80% and 100%. There was a reduction in output current waveform as the input value decreased as illustrated in Figure 1.4:

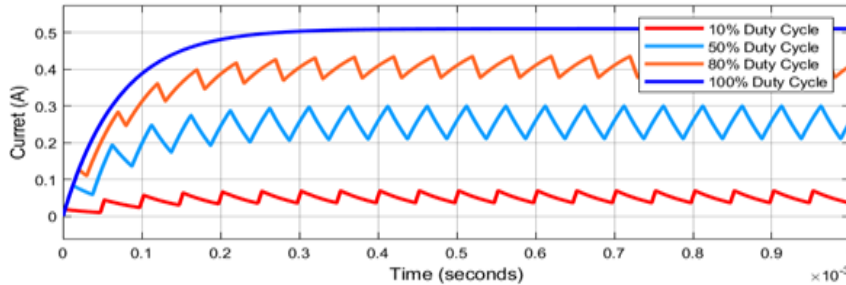

Figure (1.4): The current waveforms response of the system with different value of duty cycle (Volt vs Time ms)

Further investigation has been carried out in order to understand the behavior of the output response by changing the inductance value from 3.3mH to 15mH. The effect of decreasing the inductance caused an increase in the variation above the average of the current waveform and incline the peak value of the current Figure 1.5. This is because of the time constant is proportional to the inductance value $T = \frac{L}{R}$, which means it takes a long time to reach to steady state.

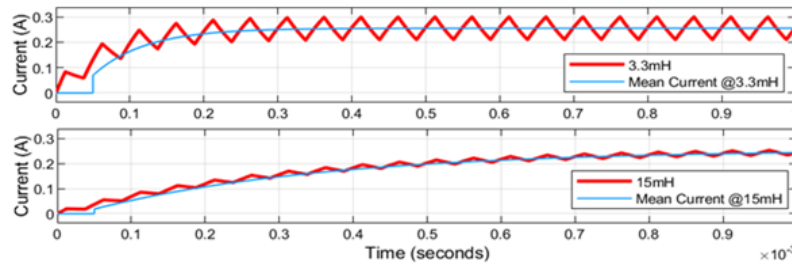

Figure (1.5): The current waveforms response of the system with respect to different inductance values

While reducing the frequency of the triangular waveform of the carrier to the following values 50 kHz to 10 kHz, the result of this caused the peak value of the current to increase as observed in the Figure 1.6, due to an increase in the switching frequency time $T = \frac{1}{f}$.

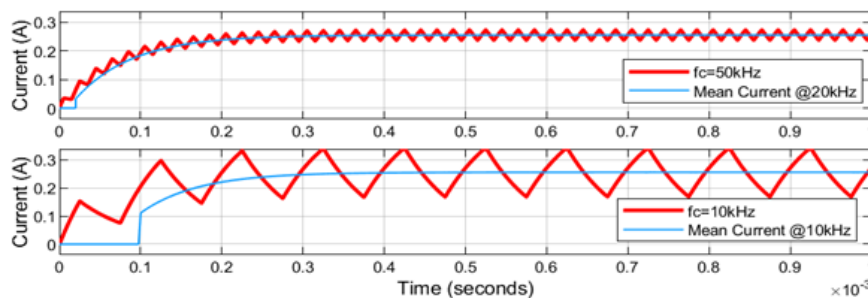

Figure (1.6): The current waveforms response of the system with respect to different value of frequency

Simulation 2 – Variable frequency AC supply:

The variable AC supply was simulated as single-phase waveform against the triangle carrier waveform. The value of the carrier was setup to an amplitude of -1 and +1 at a frequency of 10 kHz with respect to input reference of a sine wave input which is varying between -1 and +1 at a frequency of 50Hz. The output result of the system was obtained as illustrated in the Figure 1.7:

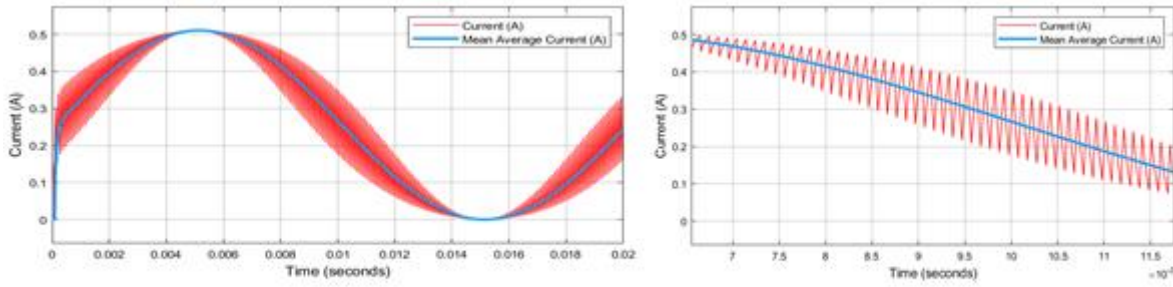

Figure (1.7): The output wave form as AC supply with respect to reference input single sine wave 50Hz

The pervious procedures which were applied in the variable DC supply were repeated to this analysis in order to study the effect on the output current. As the frequency of the sine wave input increased from 50Hz to 150Hz, this affected the number of cycles to increase as shown in the Figure 1.8:

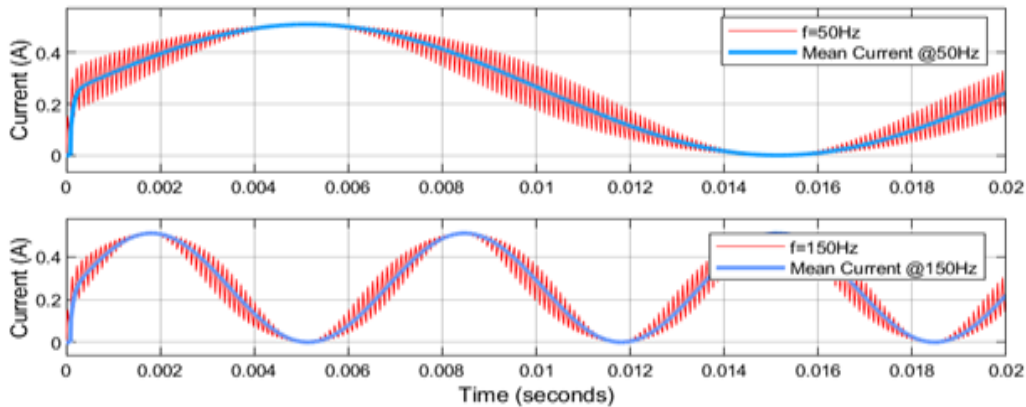

Figure (1.8): The effect of frequency of the sinewave frequency of Ac supply to output waveform voltage.

From the above figures it was observed that changing the frequency of the input reference changes the output frequency, while the carrier frequency remains unaffected. The fundamental frequency of the output is presented the first harmonic because it delivers the real power, and the carrier frequency represented the switching frequency. Therefore, the frequency modulation factor depends on the ratio of switching frequency to the first harmonic frequency $m_f = \frac{f_s}{f_1}$, so as the output frequency increased the modulation factor decreased and vice versa. Finally, the result of changing the inductance value was altered from 0.5mH to 5mH, where the output wave peak current reduces (Figure 1.9). The inductor value has an inverse relationship with the output current with less variation and a longer response. As discussed earlier, both of these investigations have the same results.

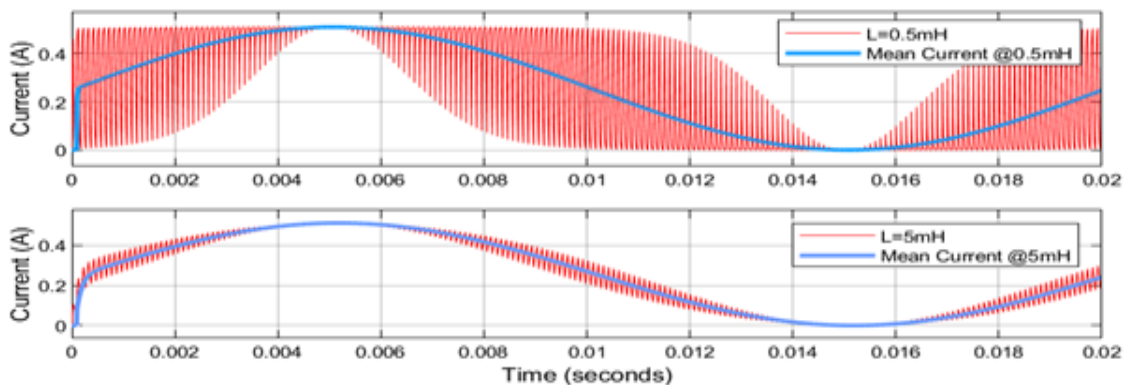
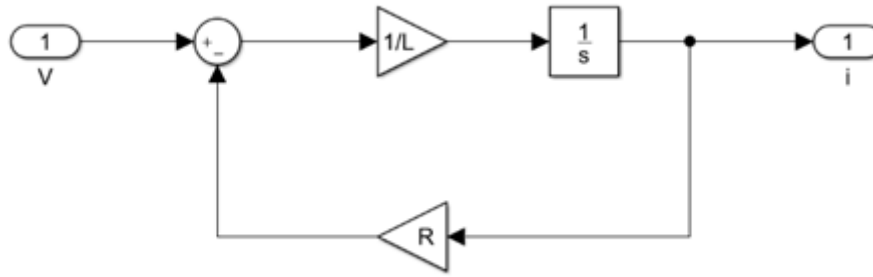

Figure (1.9): The effect of inductance load to output waveform voltage.

II. DESIGN ANALYSIS

Comparative Analysis of a Three-Phase Inverter with Different Loads

Load Model RL:



Parameters	Variable supply	DC	Variable supply	AC
Resistance	R=47 Ω			
Inductance	L= 3.3 mH			

Inverter simulation:

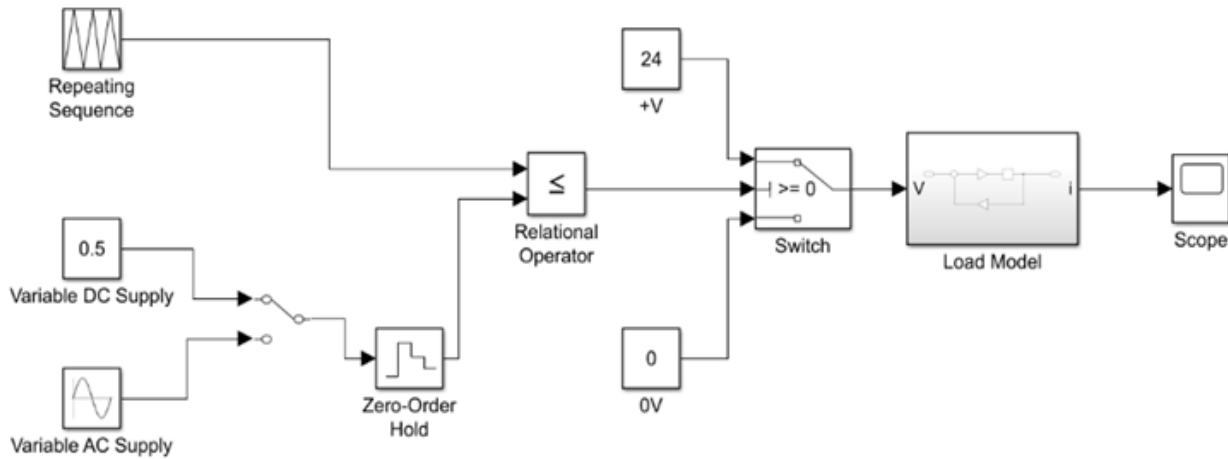

Parameters	Variable DC supply	Variable AC supply
Input Reference signal	Duty Cycle (0=0%, 0.5=50%, 1=100%)	50Hz Sine Wave [-1,+1]
Wave Carrier Input	Frequency=20kHz Amplitude [0,+1]	Frequency=10kHz Amplitude [-1,+1]

III. CONCLUSION

In this report, a deep investigation has been carried out to understand the concept of inverter in terms of the working principle both in hardware and software by enhancing the hands-on skill and applying different mode tests such as a fixed duty cycle drive, sinusoidal current generator, and brushless DC motor drive. The results obtained in this experiment were confirmed that an inverter embedded system was responsible to in generating six pulses with different phase shift at a constant frequency, which work as a gate driver. The gate driver isolated the signals (low voltage level) with MOSFET switches (High voltage level) where are they responsible, to form the output waveform. In addition, the drive system with motor were modelled and simulated in using base time software (SIMULINK) with different parameters as a variable DC/AC input power supply to standard BLDC motor represented as an RL load.

From the simulation result, this report confirms that the reference signal is proportional to the output current. The triangle waveform carrier has a direct effect to on the switching resolution around the average value of the current, and the load inductance was inversely proportional to variation of the current value to the mean average current. A further study could assess the long-term effects of harmonics and to eliminate them.

REFERENCES

- Han, J., & Yun, S. (2015). An analysis of the electricity consumption reduction potential of electric motors in the South Korean manufacturing sector. *Energy Efficiency*, 8(6), 1035-1047.

2. Learn.sparkfun.com. (2019). How to Solder: Through-Hole Soldering - learn.sparkfun.com. [online] Available at: <https://learn.sparkfun.com/tutorials/how-to-solder-through-hole-soldering/all> [Accessed 7 Jan. 2019].
3. Peddapelli, S. (2016). Pulse Width Modulation : Analysis and Performance in Multilevel Inverters. Berlin: De Gruyter.
4. Rashid, M., Kumar, N., & Kulkarni, A. (2014). Power electronics : Devices, circuits, and applications (Fourth edition, International edition / contributions by Narendra Kumar, Ashish R. Kulkarni.. ed.). Boston ; London: Pearson.
5. Shin, W., & Lee, S. (2010). An analysis of the main factors on the wear of brushes for automotive small brush-type DC motor. Journal of Mechanical Science and Technology, 24(1), 37-41.
6. Song, C. et al., 2015. Dead-time elimination SVPWM of six-leg inverter. IEEJ Transactions on Electrical and Electronic Engineering, 10(4), pp.465-473.
7. Tang Yiliang, Cui Wenjin, Xie Xiaorong, Han Yingduo, & Man-Chung Wong. (1999). 80C196MC microcontroller-based inverter motor control and IR2130 six-output IGBT driver. Electric Machines and Drives, 1999. International Conference IEMD '99, 655-657.
8. Uk.mathworks.com. (2019). Brushless DC Motor Fed by Six-Step Inverter- MATLAB & Simulink- MathWorks United Kingdom. [online] Available at: <https://uk.mathworks.com/help/physmod/sps/examples/brushless-dc-motor-fed-by-six-step-inverter.html> [Accessed 7 Jan. 2019].
9. Wu, H., Wen, M., & Wong, C. (2016). Speed control of BLDC motors using hall effect sensors based on DSP. System Science and Engineering (ICSSE), 2016 International Conference on, 1-4.

AUTHOR PROFILE



Meshari J AlJandal (B.Sc.Eng 2005-MS 2019), is currently a specialized engineer at Public Authority for Applied Education and Training-Higher Institute of Energy(HIE)-Electrical Power Department (PAAET). He received B. Eng. (V Good) in Electrical Engineering from Kuwait University, and later received MSc from University of Newcastle upon Tyne in Automation and control. He was working as maintenance engineer at wire cable manufacturing (2005-08), then promoted as senior production engineer (2008-2010), then a Leadership at product development firm Worked as consultant in prototypes development (since 2015).



Khaled S AlRasheed (B.Sc.Eng 1998-MS 2010, PHD 2021), is currently an Senior specialized engineer at Public Authority for Applied Education and Training-Higher Institute of Energy(HIE)-Electrical Power Department (PAAET). He received B. Eng. (V Good) in Electrical and Electronics Engineering from New Mexico State University (USA), and later received MSc from University of Mansour Egypt in Electrical Engineering. He was later Leadership at HIE-Students Affairs (2012-2016), then a Leadership at HIE-Training Committee, and Adviser in the scientific club in Kuwait (Since 2008). PHD in Islamic International University of Malaysia. Interest in Renewable Energy (solar), Power Electronics.



Muhammad R A A Jamal, B. Sc. in Electrical Engineering, M.Sc. in Embedded Systems and Instrumentations. Spent 6 years in the instrumentation and control engineering at Doha Power Station, Kuwait. Currently member of training staff in the Higher Institute of Energy PAAET, Kuwait, since 2008. Dedicated in industrial automation and sensors. Worked as embedded system consultant in prototypes development.