

Weir 1 - Duckbill

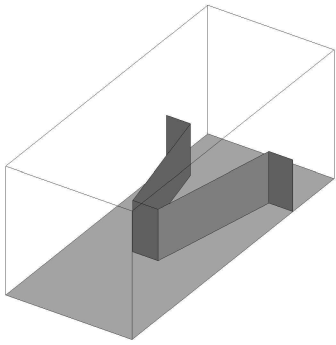

Test 1: Free

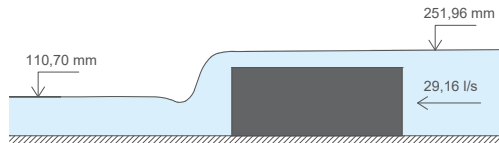

Test 2: Submerged

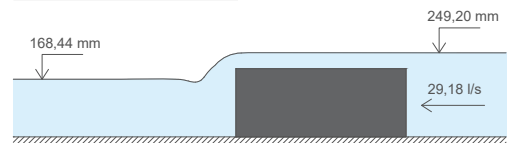

Weir 2 - Double rectangular

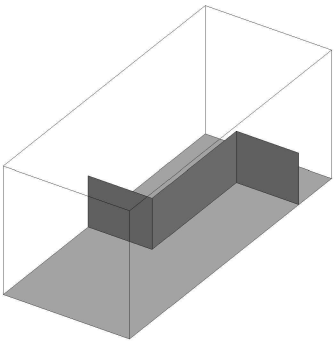

Test 1: Free

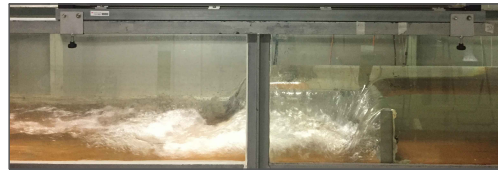
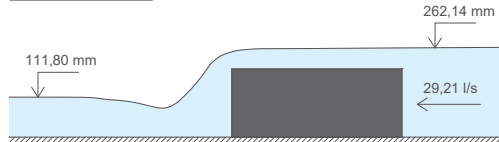

Test 2: Submerged

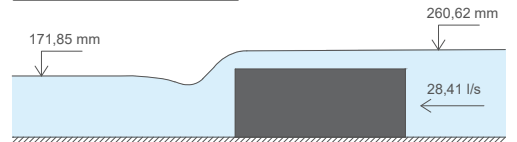

Weir 3 - Rectangular

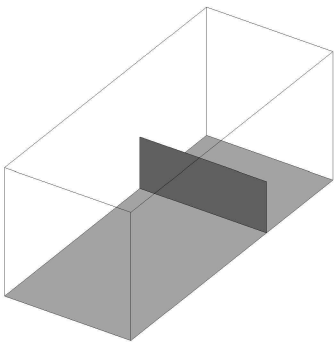

Test 1: Free

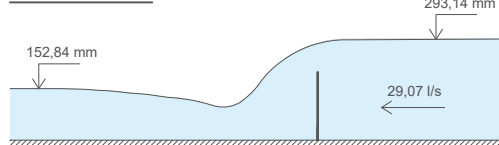

Test 2: Submerged

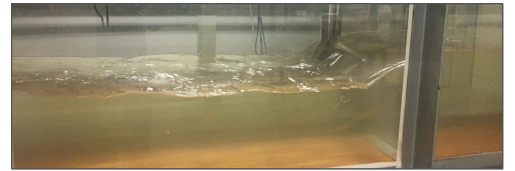
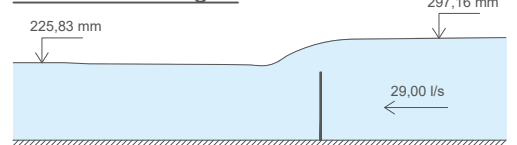

Weir 4 - Rectangular with slope

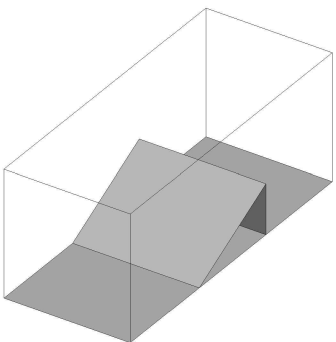

Test 1: Free

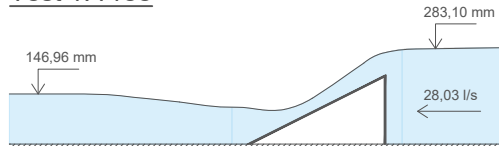

Test 2: Submerged

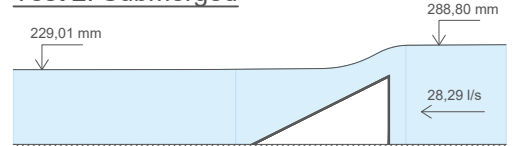

Weir 5 - Diagonal 30

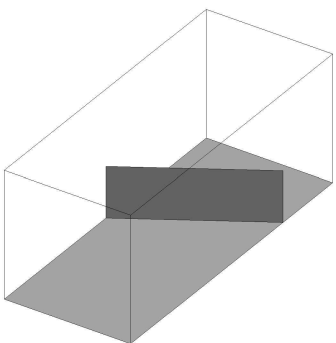

Test 1: Free

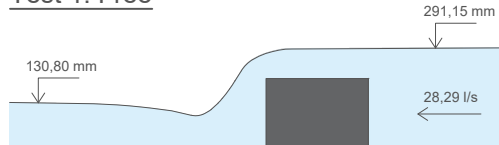

Test 2: Submerged

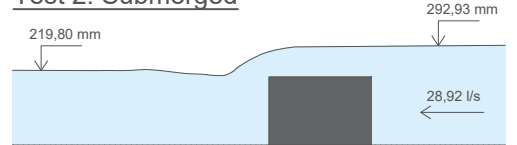

Weir 6 - Diagonal 45

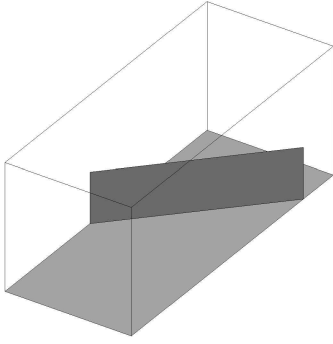

Test 1: Free

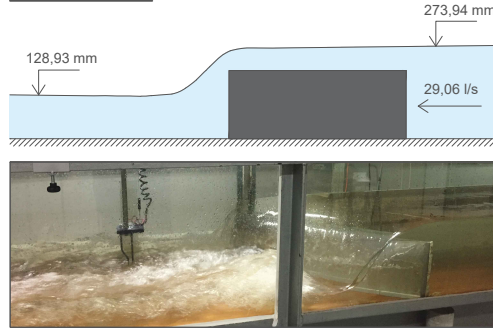

Test 2: Submerged

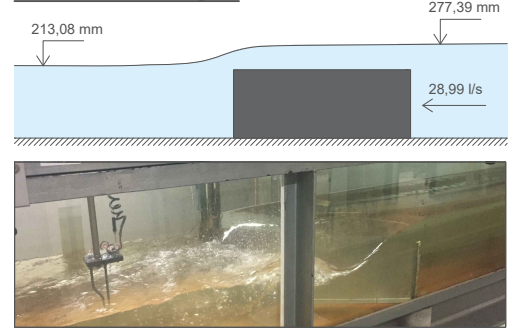

Weir 7 - Diagonal 60

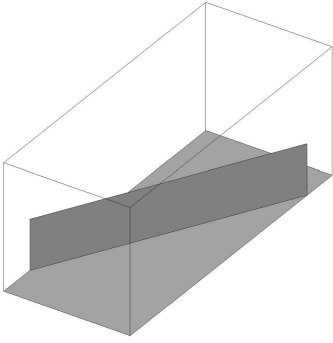

Test 1: Free

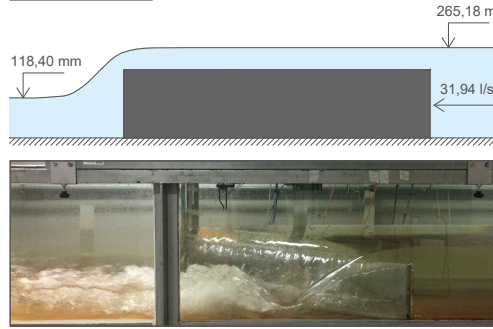

Test 2: Submerged

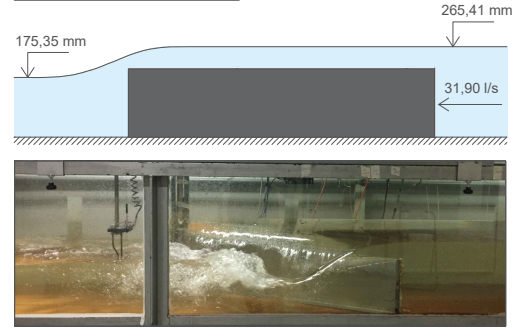

Weir 8 - Diagonal 30 with slope

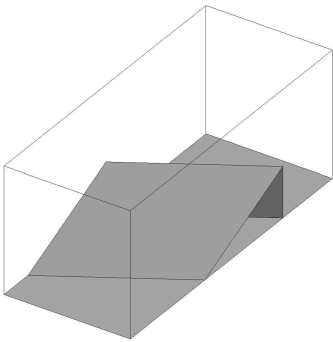

Test 1: Free

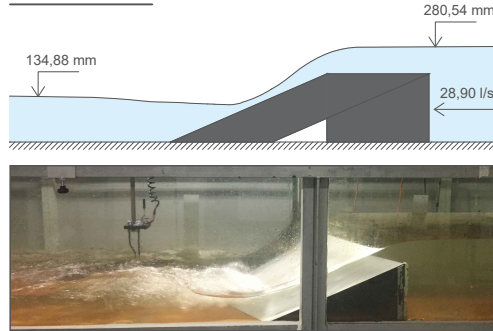

Test 2: Submerged

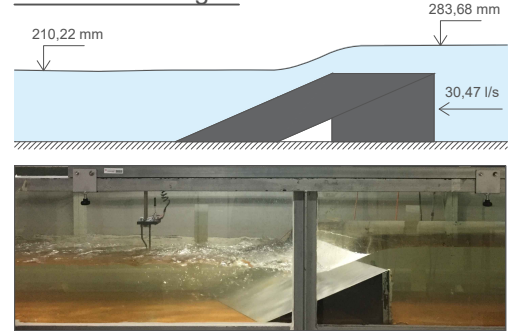

Weir 9 - Diagonal 45 with slope

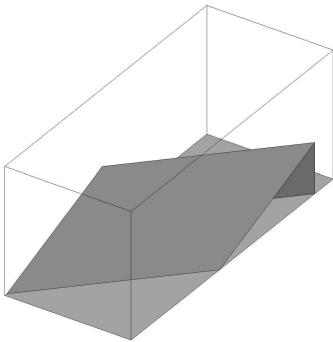

Test 1: Free

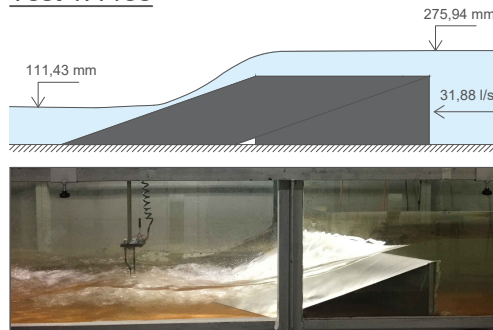

Test 2: Submerged

