

a) spedeSTEM - CR

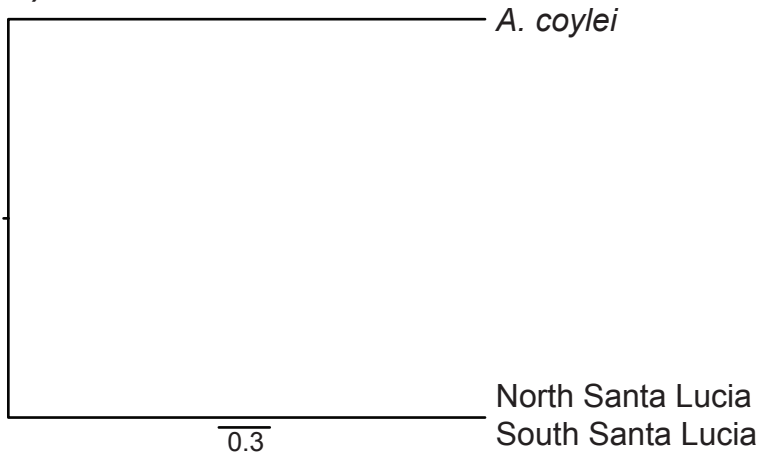

b) BPP - CR

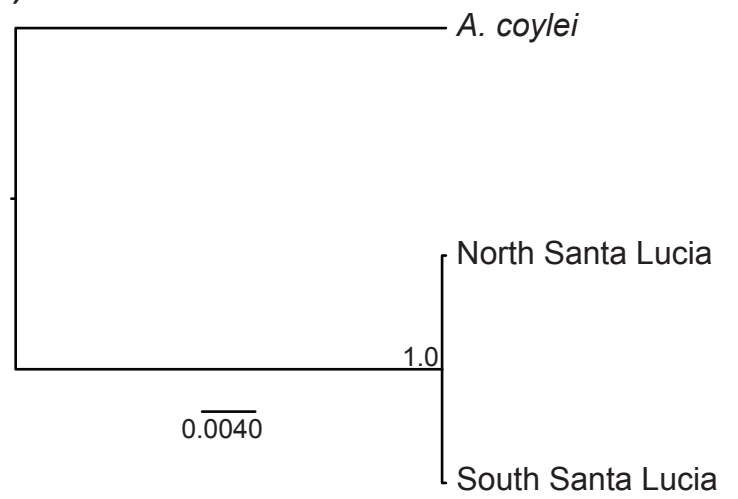

c) spedeSTEM - TR

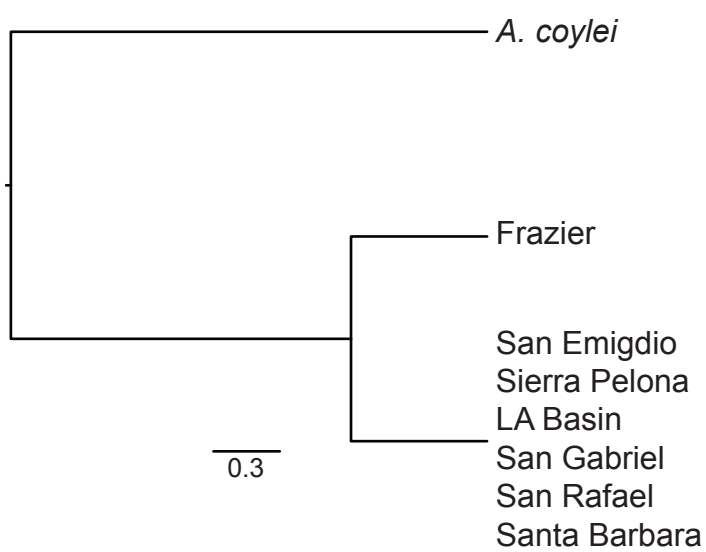

d) BPP - TR

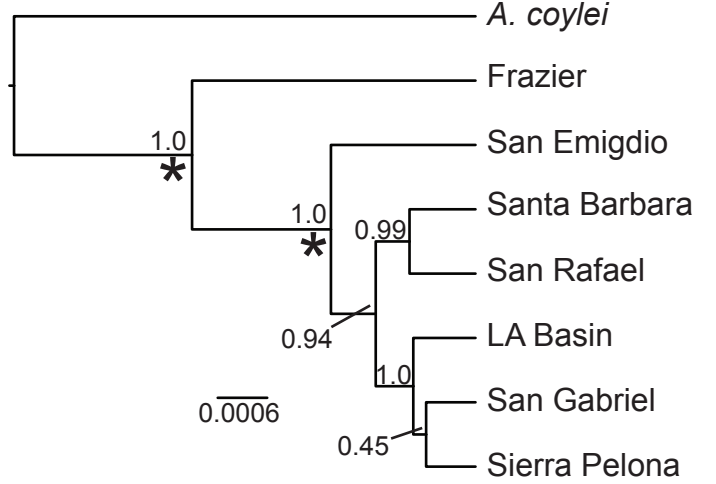

e) spedeSTEM - SN

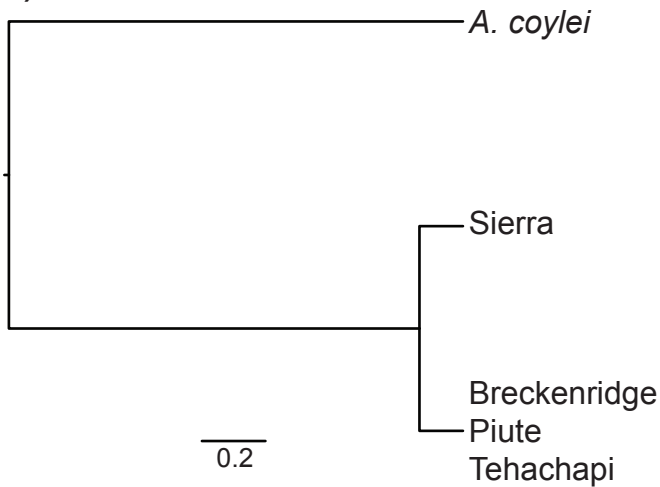

f) BPP - SN

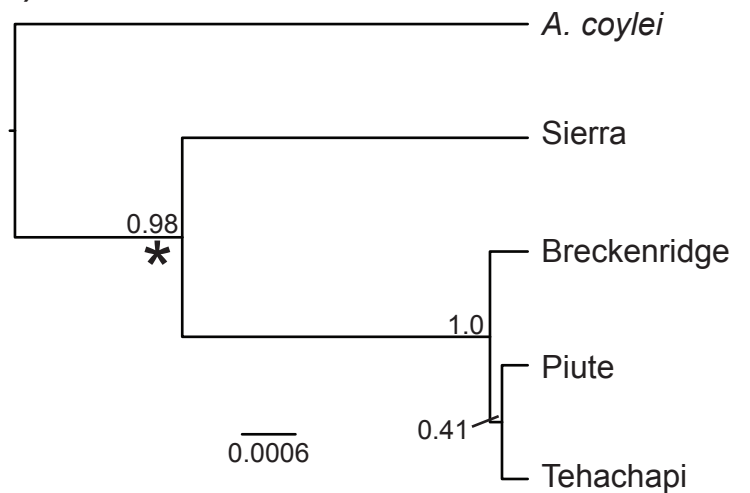

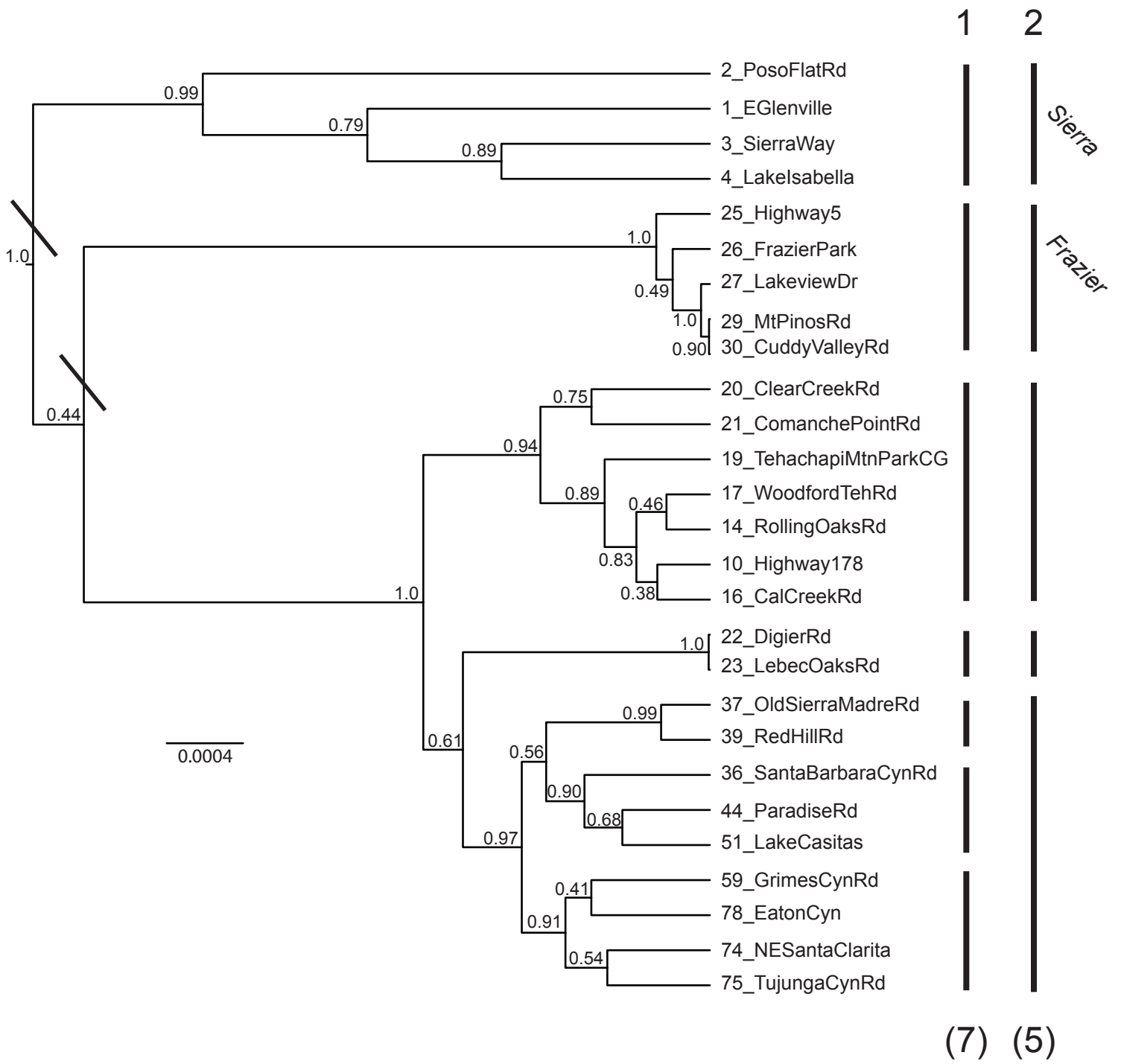

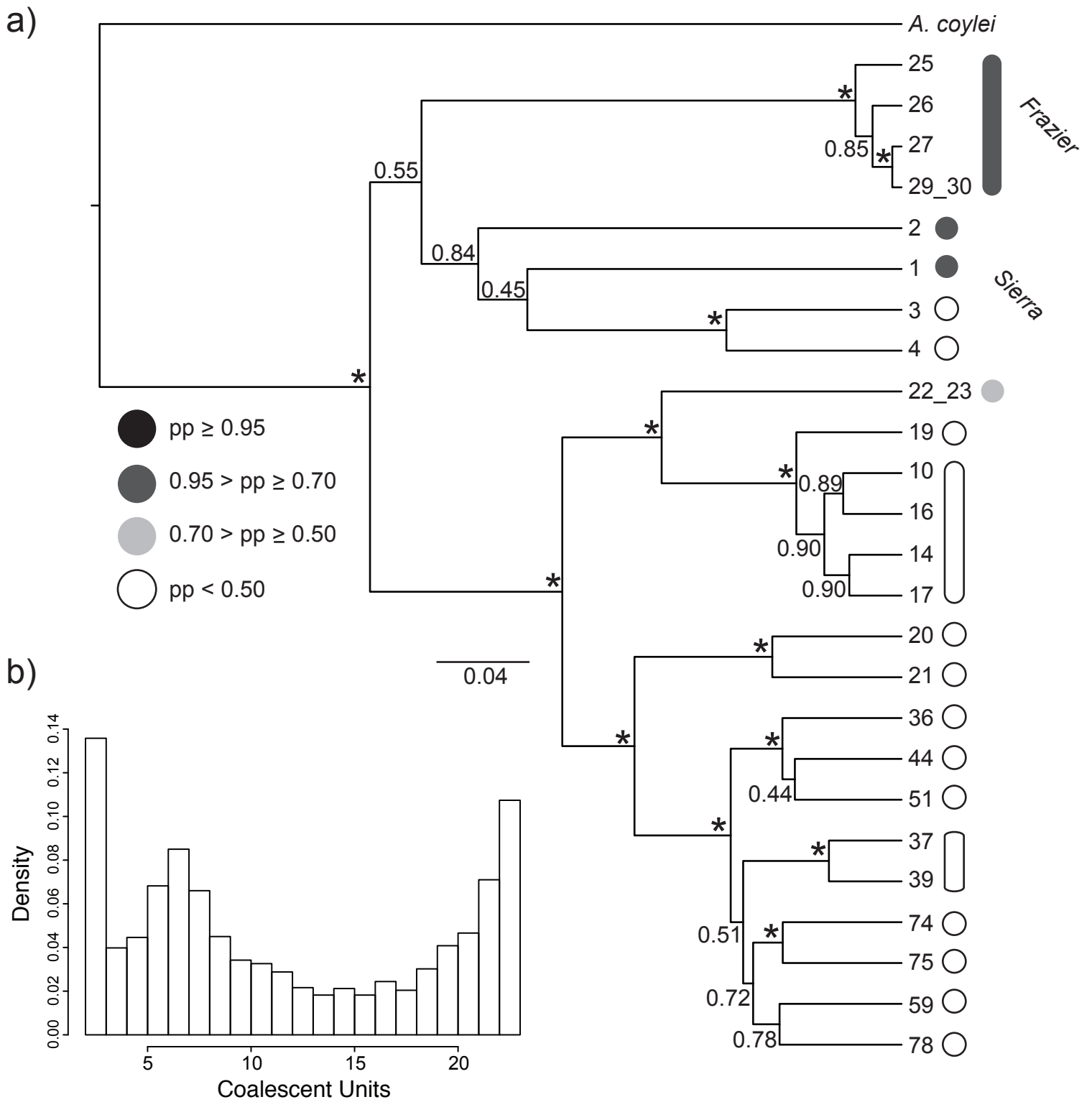

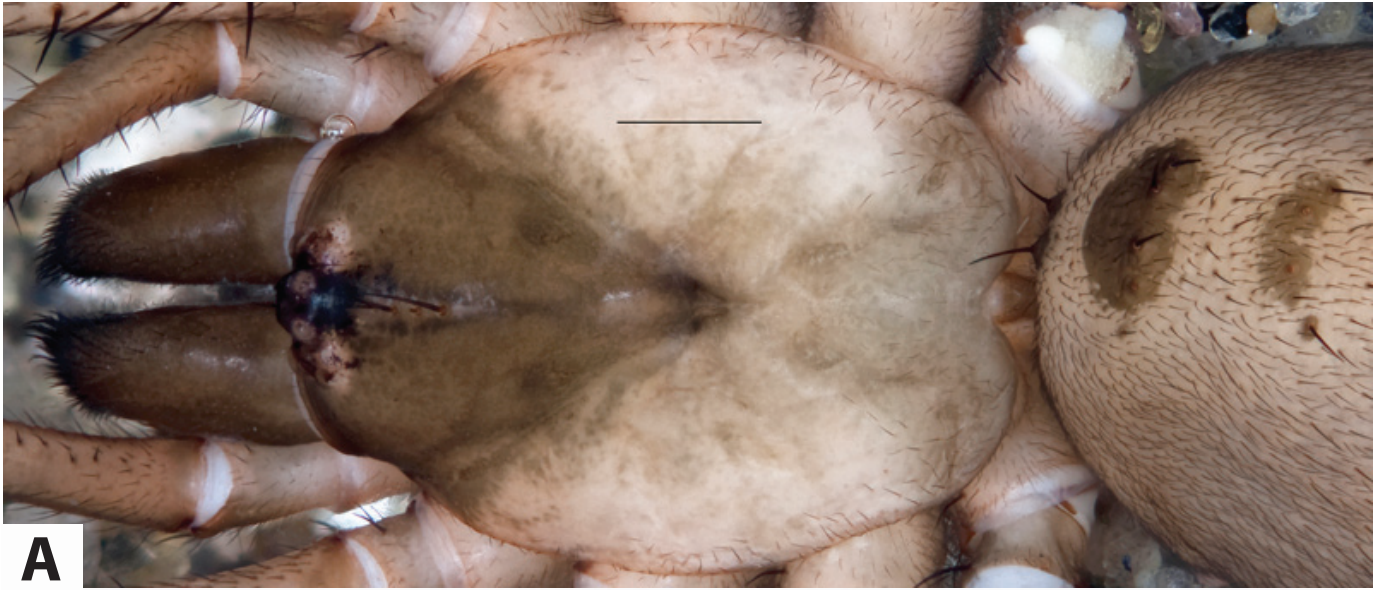

**A**



**B**

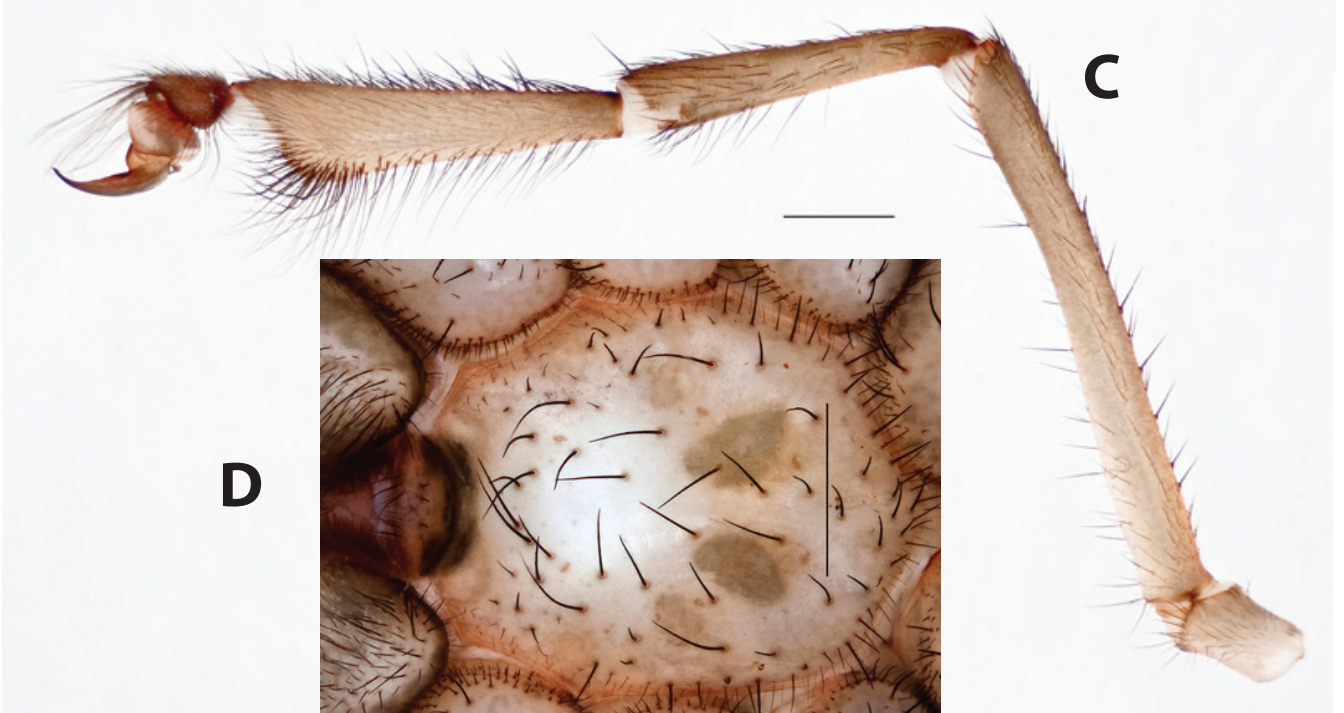

**C**

**D**

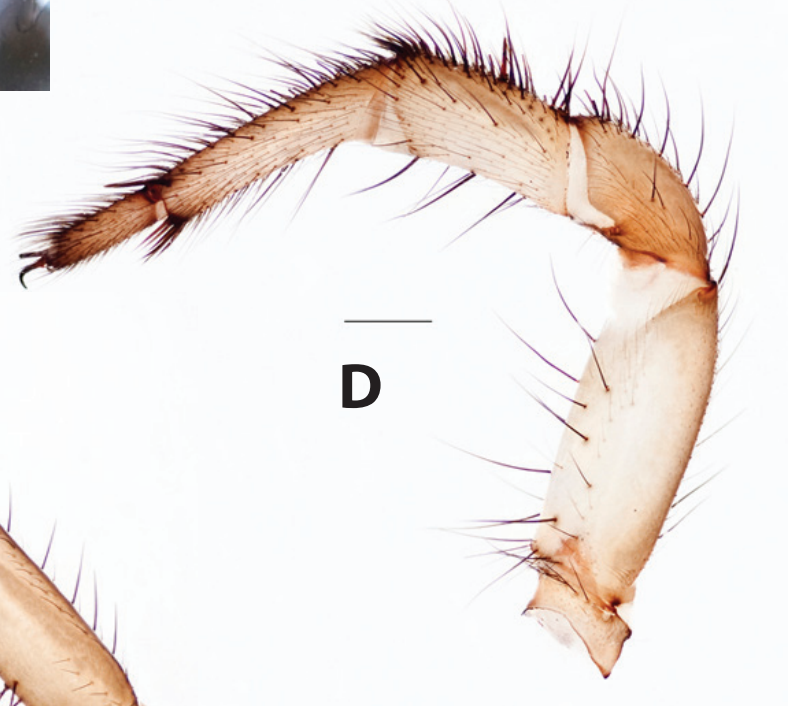
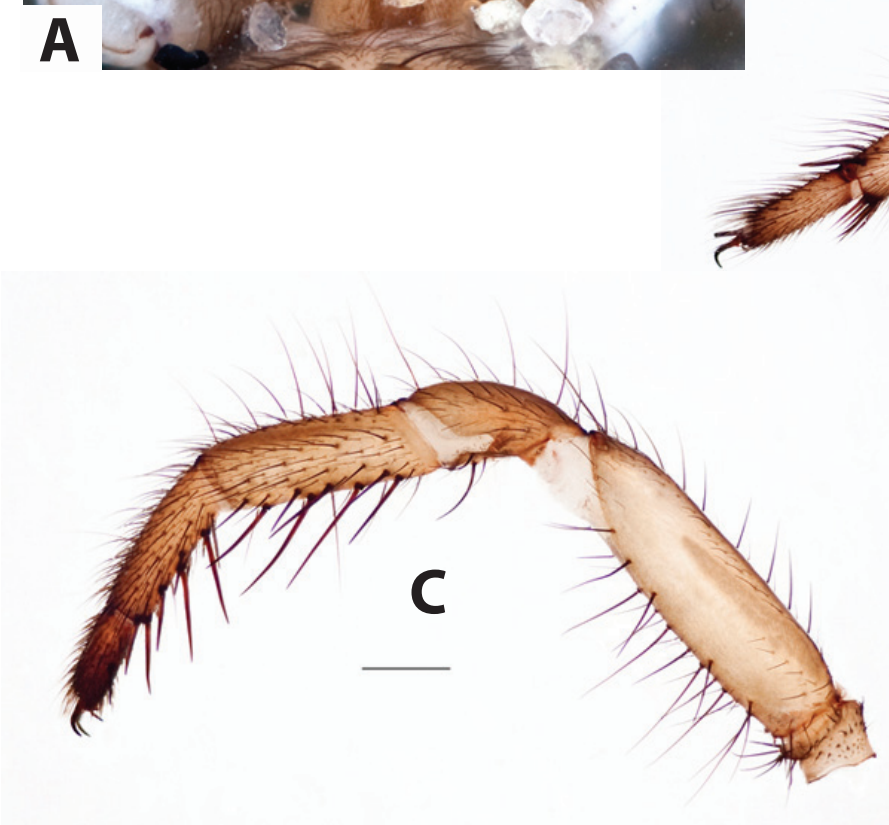
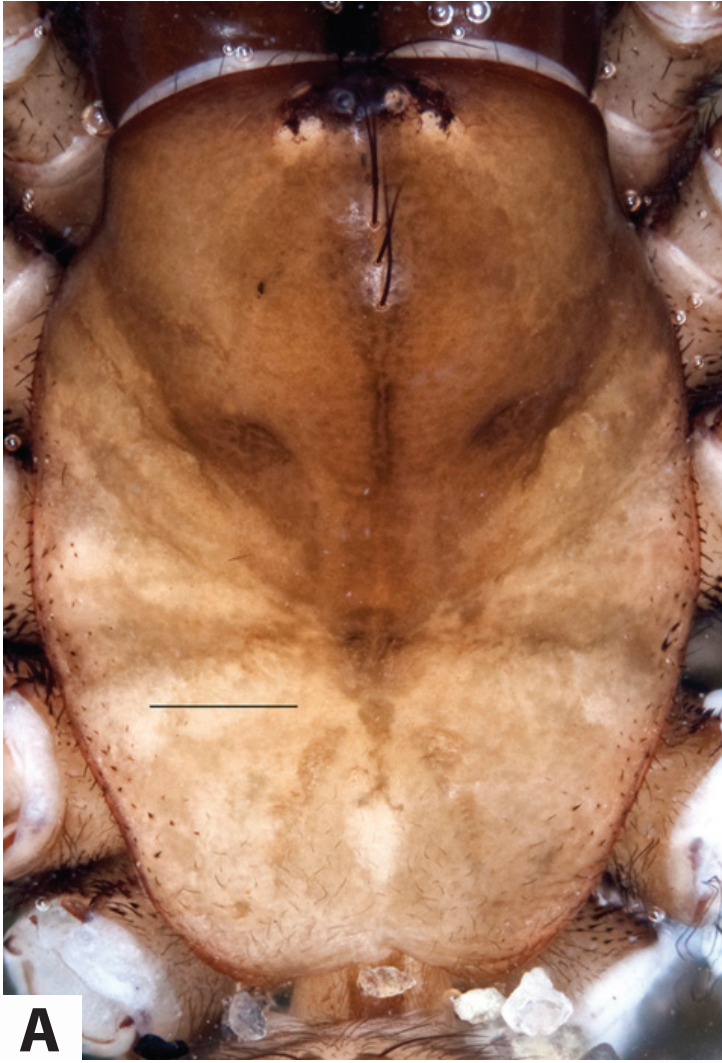

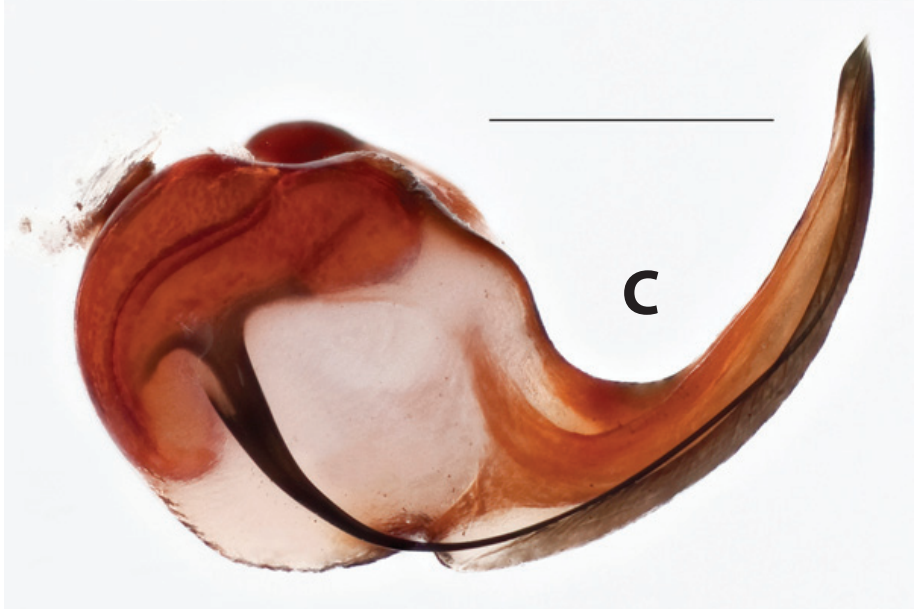
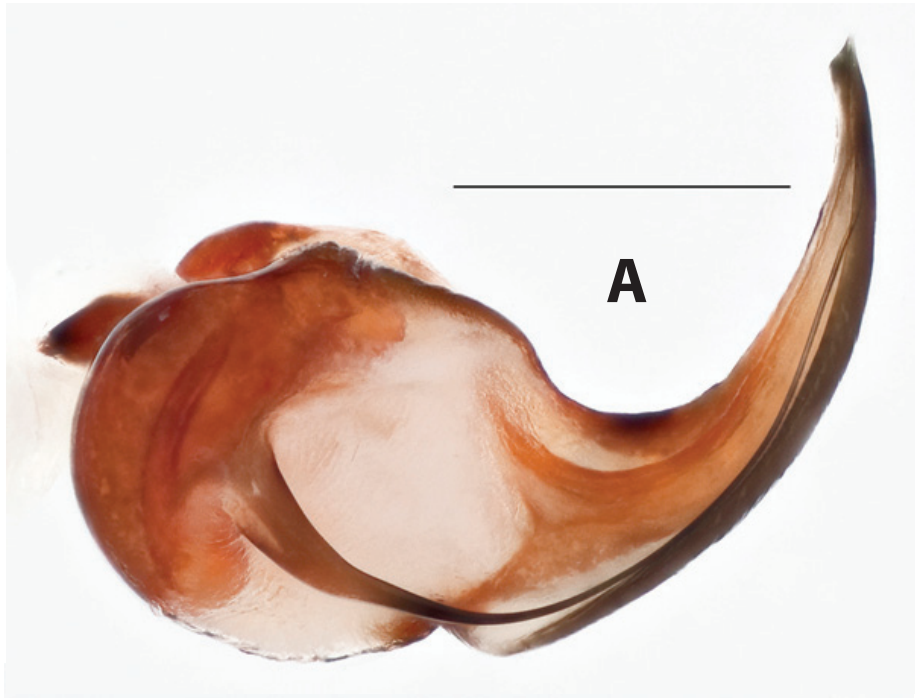

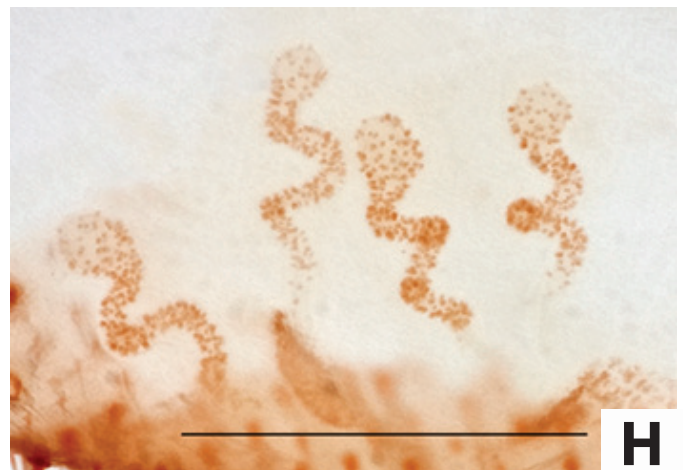
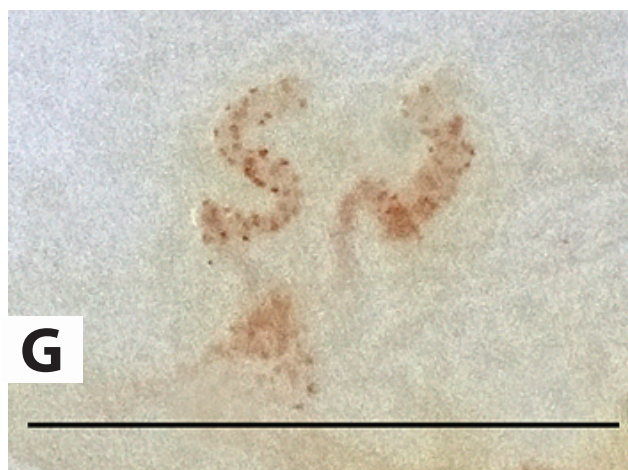
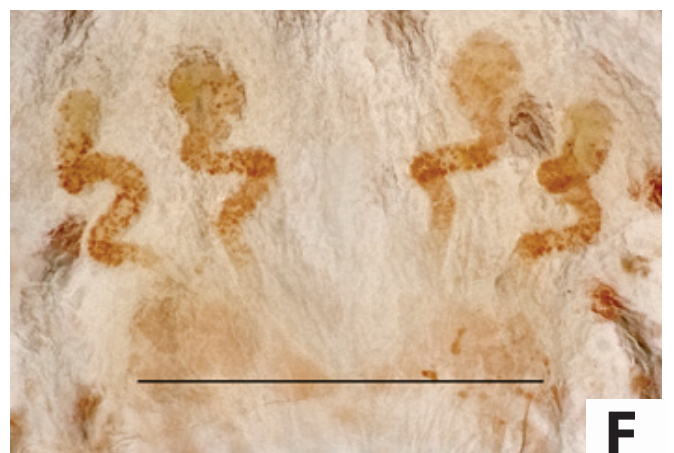
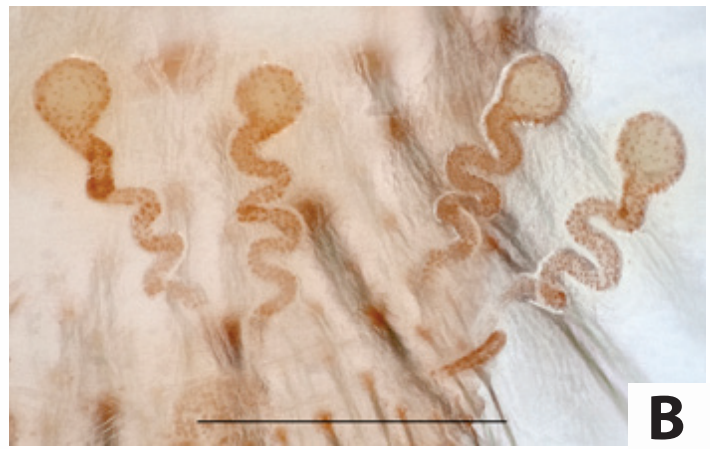
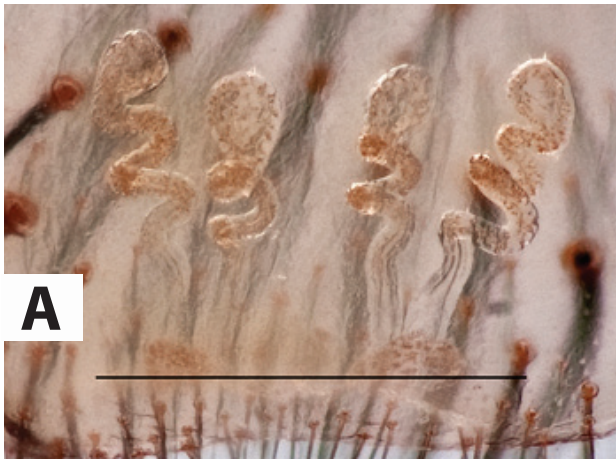



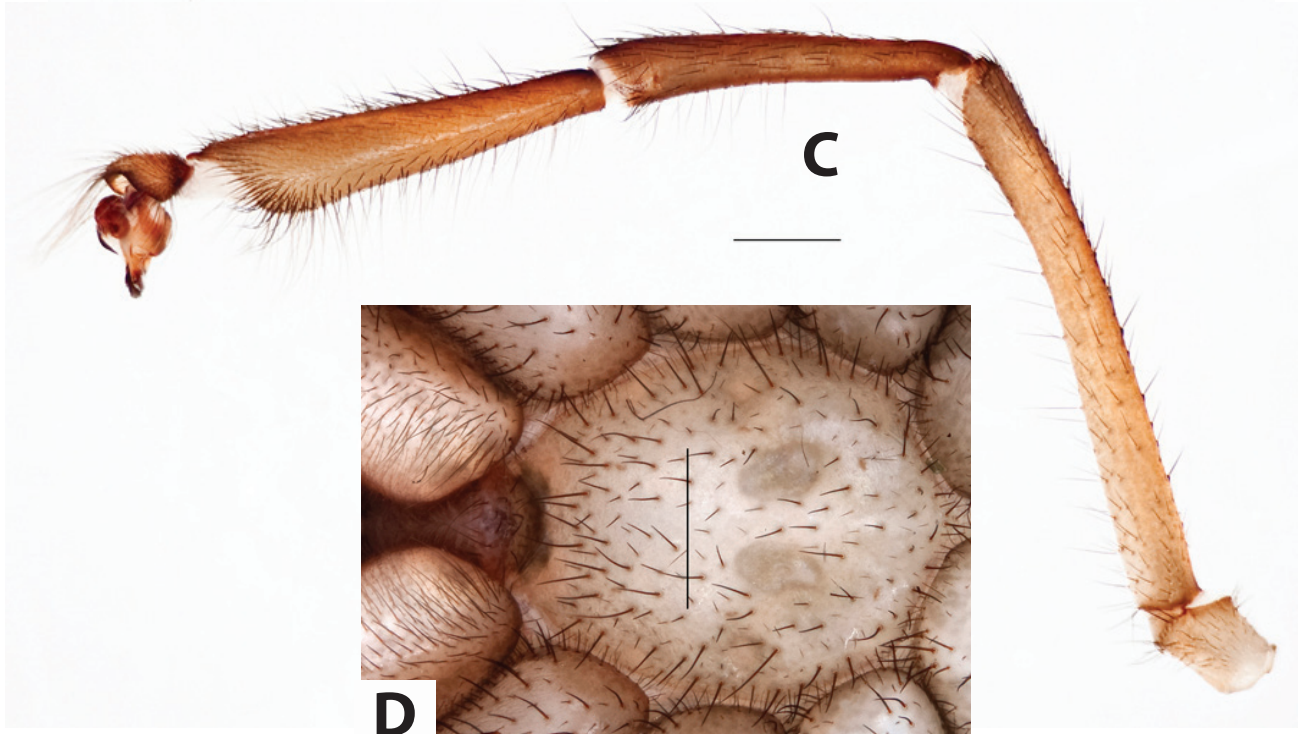
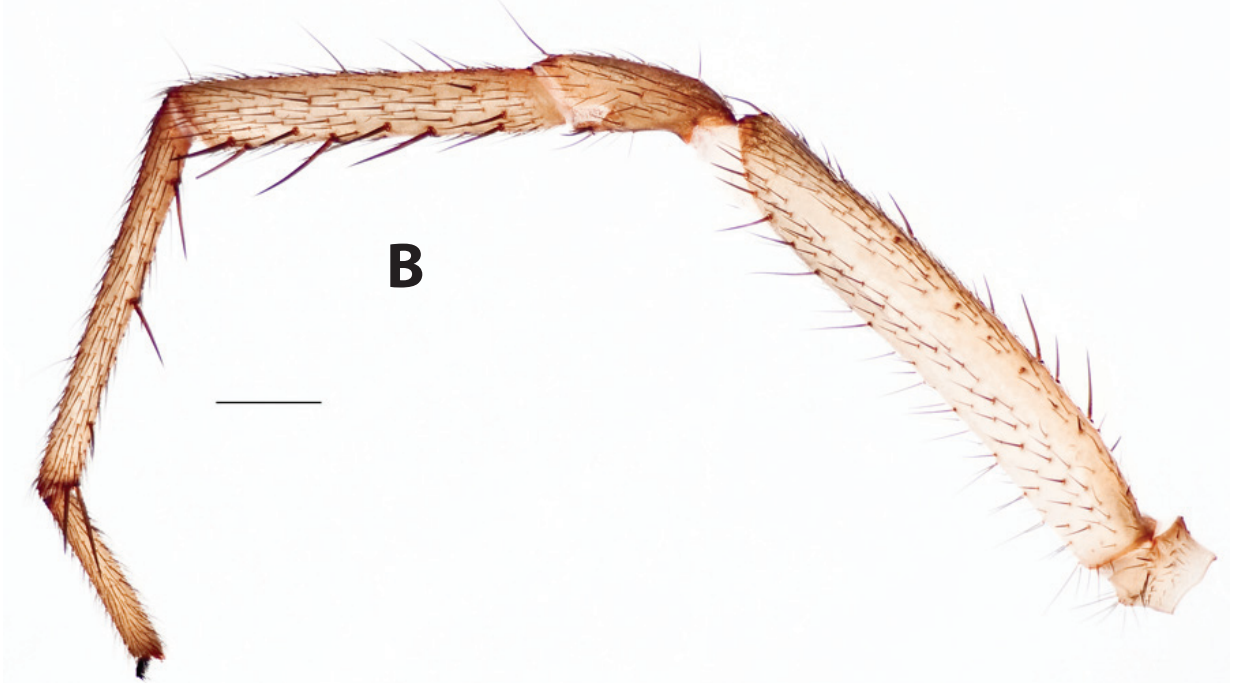
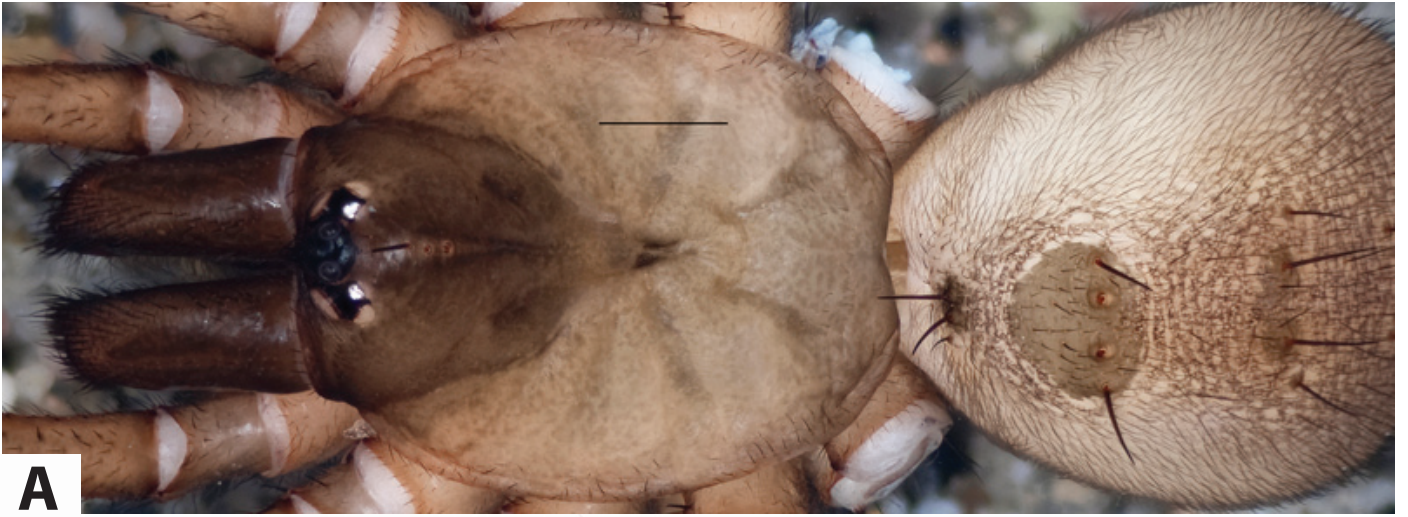



**A**



**B**

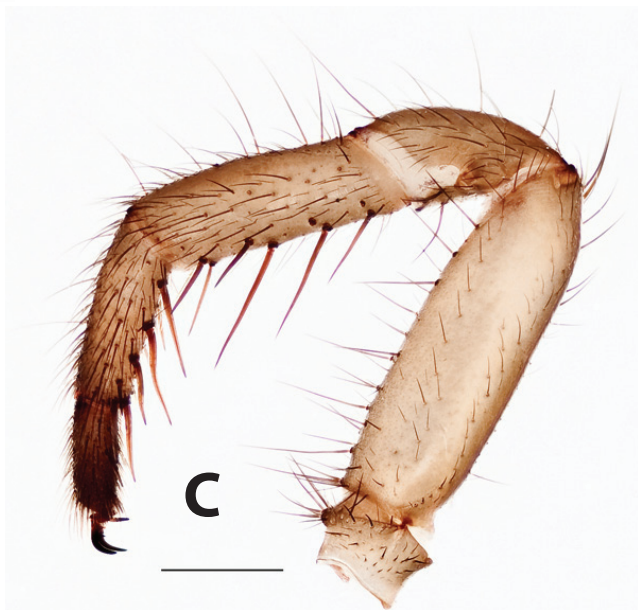

**C**

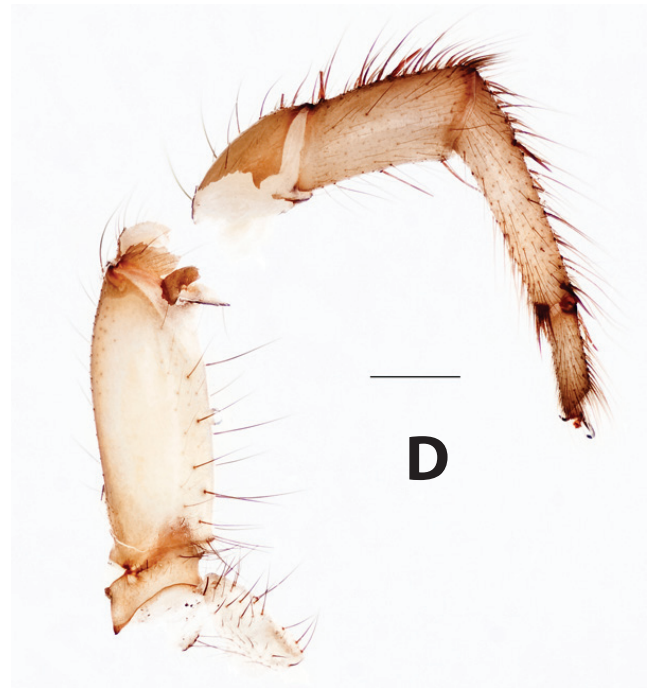

**D**