

**XIX International Workshop on Neutrino Telescopes**

18 – 26 February 2021

# Minimal scoto-seesaw mechanism for neutrino masses with spontaneous CP violation

**Déborá Barreiros**

debora.barreiros@tecnico.ulisboa.pt

CFTP/IST, U. Lisbon

In collaboration with: F. R. Joaquim, R. Srivastava and J. W. F. Valle

arXiv: **2012.05189** [hep-ph]



# Motivation

The Standard Model cannot explain:

- **Neutrino flavour oscillations** (imply existence of neutrino masses and lepton mixing)
- Observed **dark matter** abundance

**Straightforward** and **elegant** solutions:

## Type I Seesaw Model

Minkowski (1977), Gell-Mann *et al.* (1979), Yanagida (1979),  
Glashow (1980), Mohapatra *et al.* (1980)

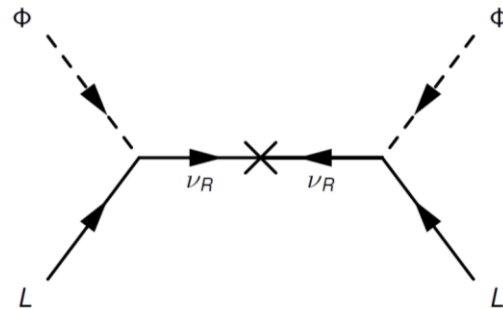

## Scotogenic Model

Ma (2006)

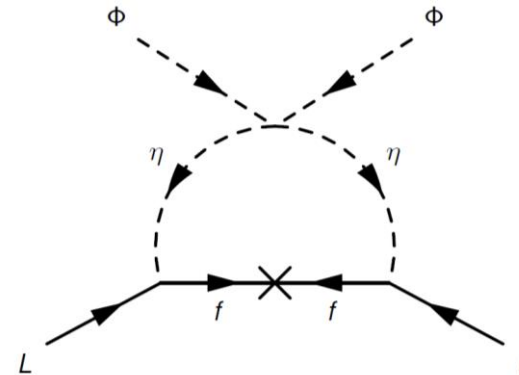

**Our solution:**

Consider a model where **both mechanisms** contribute to neutrino masses with a **single discrete symmetry** to accommodate: **neutrino oscillation data**, **dark matter stability** and **spontaneous CP violation**

# Simplest scoto-seesaw mechanism

Simple and elegant model where the **atmospheric mass scale** arises at tree level from the **type-I seesaw mechanism** and the **solar mass scale** emerges radiatively through a **scotogenic loop**

Rojas, Srivastava, Valle (2019)

Particle content:

	$\nu_R$	$\eta$	$f$
$SU(2)_L$	1	2	1
$U(1)_Y$	0	1/2	0
$Z_2$	+	-	-
Multiplicity	1	1	1

$$\mathcal{L} - \mathcal{L}_{\text{SM}} = \underbrace{-\bar{L}\mathbf{Y}_\nu^* \tilde{\Phi} \nu_R - \frac{1}{2} M_R \bar{\nu}_R \nu_R^c}_{\text{Generates the atmospheric neutrino mass scale}} - \underbrace{\bar{L}\mathbf{Y}_f^* \tilde{\eta} f - \frac{1}{2} M_f \bar{f} f^c}_{\text{Generates the solar neutrino mass scale}}$$

Generates the **atmospheric** neutrino mass scale

Generates the **solar** neutrino mass scale

Effective neutrino mass: 
$$\mathbf{M}_\nu = -v^2 \frac{\mathbf{Y}_\nu \mathbf{Y}_\nu^T}{M_R} + \mathcal{F}(M_f, m_{\eta_R}, m_{\eta_I}) M_f \mathbf{Y}_f \mathbf{Y}_f^T$$

Allowed diagrams:

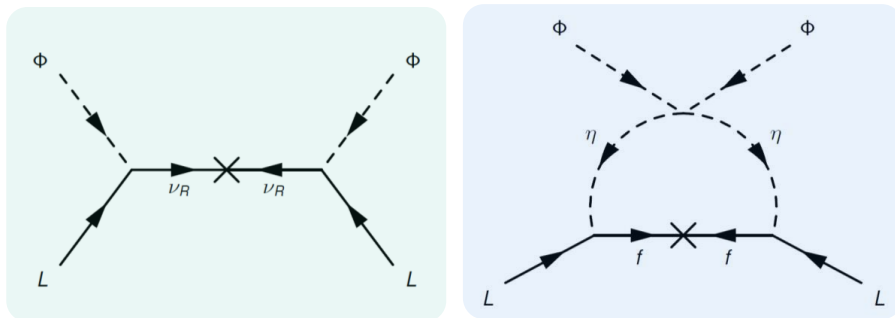

- Predicts **one massless neutrino**
- Accommodates **neutrino oscillation** and **LFV data**
- Provides a viable **WIMP dark matter candidate**
- **But lacks in predictivity!**

# Adding spontaneous CP violation

The number of parameters can be reduced by requiring the **Lagrangian to be CP symmetric** and invoking a **spontaneous origin** for leptonic CP violation

Introducing a **new scalar singlet** with **complex VEV**:  $\langle \sigma \rangle = ue^{i\theta}$

$$\frac{1}{2}(y_R\sigma + \tilde{y}_R\sigma^*)\overline{\nu}_R\nu_R^c + \frac{1}{2}(y_f\sigma + \tilde{y}_f\sigma^*)\bar{f}f^c + \text{H.c.}$$

SSB

$$|M_R|e^{i\theta_R}\overline{\nu}_R\nu_R^c + |M_f|e^{i\theta_f}\bar{f}f^c + \text{H.c.}$$

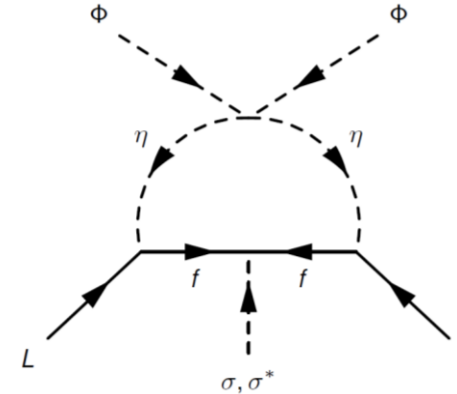
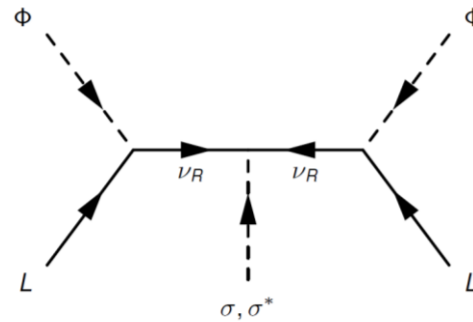

At the effective level:  $\mathbf{M}_\nu = -v^2 e^{i(\theta_f - \theta_R)} \frac{\mathbf{Y}_\nu \mathbf{Y}_\nu^T}{|M_R|} + \mathcal{F}(|M_f|, m_{\eta_R}, m_{\eta_I}) |M_f| \mathbf{Y}_f \mathbf{Y}_f^T$

- CPV is transmitted to the neutrino sector provided that  $\theta \neq k\pi$  ( $k \in \mathbb{Z}$ ) and  $y_{R,f} \neq \tilde{y}_{R,f}$
- A minimal scalar potential which allows to implement SCPV must contain a phase sensitive term of the type  $\sigma^4 + \text{H.c.}$

Branco *et al.* (1999, 2003)

The minimal scoto-seesaw model provides a template for neutrino masses, dark matter and SCPV!

# Adding a discrete flavour symmetry

DB, F. R. Joaquim, R. Srivastava, J. W. F. Valle (2020)

Consider the most restrictive textures for  $\mathbf{Y}_\nu$ ,  $\mathbf{Y}_f$  and  $\mathbf{Y}_\ell$  realizable by **minimal discrete flavour symmetry** in order to maximise predictability

Particle content:

	Fields	$SU(2)_L \otimes U(1)_Y$	$\mathcal{Z}_8^{e-\tau*} \rightarrow \mathcal{Z}_2$
Fermions	$L_e$	$(\mathbf{2}, -1/2)$	$\omega^6 \equiv -i \rightarrow +1$
	$L_\mu$	$(\mathbf{2}, -1/2)$	$\omega^0 \equiv 1 \rightarrow +1$
	$L_\tau$	$(\mathbf{2}, -1/2)$	$\omega^6 \equiv -i \rightarrow +1$
	$\nu_R^1$	$(\mathbf{1}, 0)$	$\omega^6 \equiv -i \rightarrow +1$
	$\nu_R^2$	$(\mathbf{1}, 0)$	$\omega^0 \equiv 1 \rightarrow +1$
	$f$	$(\mathbf{1}, 0)$	$\omega^3 \rightarrow -1$
Scalars	$\Phi$	$(\mathbf{2}, 1/2)$	$\omega^0 \equiv 1 \rightarrow +1$
	$\sigma$	$(\mathbf{1}, 0)$	$\omega^2 \equiv i \rightarrow +1$
	$\eta$	$(\mathbf{2}, 1/2)$	$\omega^5 \rightarrow -1$
	$\chi$	$(\mathbf{1}, 0)$	$\omega^3 \rightarrow -1$

$$\langle \Phi \rangle = v, \langle \sigma \rangle = ue^{i\theta}, \langle \eta \rangle = \langle \chi \rangle = 0$$

\*  $\mathcal{Z}_8^{e-\mu}$  and  $\mathcal{Z}_8^{\mu-\tau}$  are other possible charge assignments, with decoupled  $\tau$  and  $e$ , respectively

Contributions to neutrino masses:

• Tree level:

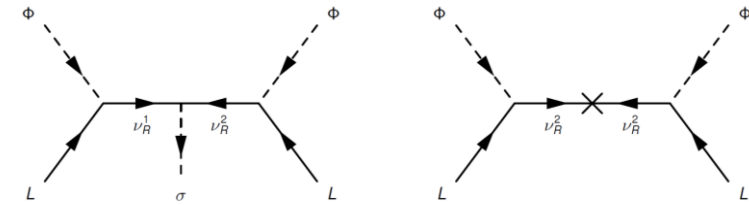

• One loop:

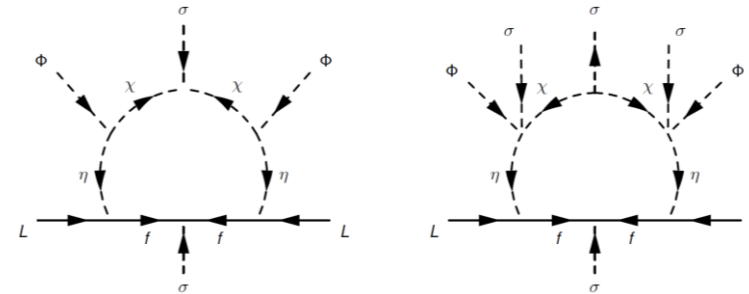

Maximally-restrictive textures:

$$\mathbf{Y}_\nu = \begin{pmatrix} x_1 & 0 \\ 0 & x_2 \\ x_3 & 0 \end{pmatrix} \quad \mathbf{M}_R = \begin{pmatrix} 0 & M_{12} e^{-i\theta} \\ M_{12} e^{-i\theta} & M_{22} \end{pmatrix} \quad \mathbf{Y}_f = \begin{pmatrix} y_1 \\ 0 \\ y_2 \end{pmatrix} \quad \mathbf{Y}_\ell = \begin{pmatrix} w_1 & 0 & w_2 \\ 0 & w_3 & 0 \\ w_4 & 0 & w_5 \end{pmatrix}$$



# Scalar sector

## Scalar Potential

$$\begin{aligned}
 V = & m_\Phi^2 \Phi^\dagger \Phi + m_\eta^2 \eta^\dagger \eta + m_\sigma^2 \sigma^* \sigma + m_\chi^2 \chi^* \chi + \frac{\lambda_1}{2} (\Phi^\dagger \Phi)^2 + \frac{\lambda_2}{2} (\eta^\dagger \eta)^2 + \frac{\lambda_3}{2} (\sigma^* \sigma)^2 \\
 & + \frac{\lambda_4}{2} (\chi^* \chi)^2 + \lambda_5 (\Phi^\dagger \Phi) (\eta^\dagger \eta) + \lambda'_5 (\Phi^\dagger \eta) (\eta^\dagger \Phi) + \lambda_6 (\Phi^\dagger \Phi) (\sigma^* \sigma) + \lambda_7 (\Phi^\dagger \Phi) (\chi^* \chi) \\
 & + \lambda_8 (\eta^\dagger \eta) (\sigma^* \sigma) + \lambda_9 (\eta^\dagger \eta) (\chi^* \chi) + \lambda_{10} (\sigma^* \sigma) (\chi^* \chi) \\
 & + \left( \frac{\lambda'_3}{4} \sigma^4 + \frac{m_\sigma'^2}{2} \sigma^2 + \mu_1 \chi^2 \sigma + \mu_2 \eta^\dagger \Phi \chi^* + \lambda_{11} \eta^\dagger \Phi \sigma \chi + \text{H.c.} \right)
 \end{aligned}$$



From the minimisation conditions for  $\langle \Phi \rangle = v$ ,  $\langle \sigma \rangle = u e^{i\theta}$ ,  $\langle \eta \rangle = \langle \chi \rangle = 0$

### CP violating solution:

$$m_\Phi^2 = -\frac{\lambda_1}{2} v^2 - \frac{\lambda_6}{2} u^2, \quad m_\sigma^2 = -\frac{\lambda_6}{2} v^2 - \frac{\lambda_3 - \lambda'_3}{2} u^2, \quad \cos(2\theta) = -\frac{m_\sigma'^2}{u^2 \lambda'_3}$$

corresponds to the global minimum for  $(m_\sigma'^4 - u^4 \lambda_3'^2)/(4\lambda_3') > 0$

**Existence of a non-zero vacuum phase at the potential global minimum  $\Rightarrow \theta \neq k\pi$  is allowed!**

DB, F. R. Joaquim, R. Srivastava, J. W. F. Valle (2020)

	Fields	SU(2) <sub>L</sub> $\otimes$ U(1) <sub>Y</sub>	$Z_8^{e-\tau} \rightarrow Z_2$
Fermions	$L_e$	(2, -1/2)	$\omega^6 \equiv -i \rightarrow +1$
	$L_\mu$	(2, -1/2)	$\omega^0 \equiv 1 \rightarrow +1$
	$L_\tau$	(2, -1/2)	$\omega^6 \equiv -i \rightarrow +1$
	$\nu_R^1$	(1, 0)	$\omega^6 \equiv -i \rightarrow +1$
	$\nu_R^2$	(1, 0)	$\omega^0 \equiv 1 \rightarrow +1$
	$f$	(1, 0)	$\omega^3 \rightarrow -1$
Scalars	$\Phi$	(2, 1/2)	$\omega^0 \equiv 1 \rightarrow +1$
	$\sigma$	(1, 0)	$\omega^2 \equiv i \rightarrow +1$
	$\eta$	(2, 1/2)	$\omega^5 \rightarrow -1$
	$\chi$	(1, 0)	$\omega^3 \rightarrow -1$

Other conclusions:

- $Z_8 \rightarrow Z_2$  after SSB, preventing the neutral dark scalars to mix with the neutral non-dark scalars:
  - $\phi - \sigma$  mixing
  - $\eta - \chi$  mixing
  - degenerate dark charged scalars  $\eta^\pm$
- The lightest of the mass eigenstates resulting from the  $\eta - \chi$  mixing is a **dark matter candidate** along with the dark fermion  $f$

# Low-energy constraints

Maximally-restrictive textures (for  $\mathcal{Z}_8^{e-\tau}$ ):

$$\mathbf{Y}_\nu = \begin{pmatrix} x_1 & 0 \\ 0 & x_2 \\ x_3 & 0 \end{pmatrix} \quad \mathbf{M}_R = \begin{pmatrix} 0 & M_{12} e^{-i\theta} \\ M_{12} e^{-i\theta} & M_{22} \end{pmatrix} \quad \mathbf{Y}_f = \begin{pmatrix} y_1 \\ 0 \\ y_2 \end{pmatrix} \quad \mathbf{Y}_\ell = \begin{pmatrix} w_1 & 0 & w_2 \\ 0 & w_3 & 0 \\ w_4 & 0 & w_5 \end{pmatrix}$$

At the effective level:

$$\mathbf{M}_\nu = -v^2 \mathbf{Y}_\nu \mathbf{M}_R^{-1} \mathbf{Y}_\nu^T + \mathcal{F}(M_f, m_{S_i}) M_f \mathbf{Y}_f \mathbf{Y}_f^T$$

$$= \begin{pmatrix} \mathcal{F}(M_f, m_{S_i}) M_f y_1^2 + \frac{v^2 M_{22}}{M_{12}^2} x_1^2 e^{i\theta} & -\frac{v^2}{M_{12}} x_1 x_2 & \mathcal{F}(M_f, m_{S_i}) M_f y_1 y_2 + \frac{v^2 M_{22}}{M_{12}^2} x_1 x_3 e^{i\theta} \\ \cdot & 0 & -\frac{v^2}{M_{12}} x_2 x_3 \\ \cdot & \cdot & \mathcal{F}(M_f, m_{S_i}) M_f y_2^2 + \frac{v^2 M_{22}}{M_{12}^2} x_3^2 e^{i\theta} \end{pmatrix}$$

In the charged-lepton mass basis:

$$\mathbf{M}'_\nu = \mathbf{U}_\ell^T \mathbf{M}_\nu \mathbf{U}_\ell = \mathbf{U}^* \text{diag}(m_1, m_2, m_3) \mathbf{U}^\dagger$$

$(\mathbf{M}'_\nu)_{11} = 0$  for  $\mathcal{Z}_8^{\mu-\tau}$   
(decoupled **electron**)

$(\mathbf{M}'_\nu)_{22} = 0$  for  $\mathcal{Z}_8^{e-\mu}$   
(decoupled **muon**)

$(\mathbf{M}'_\nu)_{33} = 0$  for  $\mathcal{Z}_8^{e-\tau}$   
(decoupled **tau**)

DB, F. R. Joaquim, R. Srivastava, J. W. F. Valle (2020)

- A **texture zero** in the effective neutrino mass matrix arises as a result of the imposed symmetry
- Contribution of the scotogenic loop is crucial to ensure the **existence of CPV**

e.g. for  $\mathcal{Z}_8^{e-\tau}$ :

$$\mathbf{U}_\ell = \begin{pmatrix} \cos \theta_\ell & 0 & \sin \theta_\ell \\ 0 & 1 & 0 \\ -\sin \theta_\ell & 0 & \cos \theta_\ell \end{pmatrix}$$

# Neutrino oscillation data

## Global fit of neutrino oscillation data:

	Normal Ordering (best fit)		Inverted Ordering ( $\Delta\chi^2 = 9.1$ )	
	bfp $\pm 1\sigma$	$3\sigma$ range	bfp $\pm 1\sigma$	$3\sigma$ range
$\theta_{12}$ ( $^\circ$ )	$34.3 \pm 1.0$	$31.4 \rightarrow 37.4$	$34.3 \pm 1.0$	$31.4 \rightarrow 37.4$
$\theta_{23}$ ( $^\circ$ )	$48.79^{+0.93}_{-1.25}$	$41.63 \rightarrow 51.32$	$48.79^{+1.04}_{-1.30}$	$41.88 \rightarrow 51.30$
$\theta_{13}$ ( $^\circ$ )	$8.58^{+0.11}_{-0.15}$	$8.16 \rightarrow 8.94$	$8.63^{+0.11}_{-0.15}$	$8.21 \rightarrow 8.99$
$\delta/\pi$	$1.20^{+0.23}_{-0.14}$	$0.8 \rightarrow 2.00$	$1.54 \pm 0.13$	$1.14 \rightarrow 1.90$
$\Delta m_{21}^2$ ( $\times 10^{-5}$ eV $^2$ )	$7.50^{+0.22}_{-0.20}$	$6.94 \rightarrow 8.14$	$7.50^{+0.22}_{-0.20}$	$6.94 \rightarrow 8.14$
$ \Delta m_{31}^2 $ ( $\times 10^{-3}$ eV $^2$ )	$2.56^{+0.03}_{-0.04}$	$2.46 \rightarrow 2.65$	$2.46 \pm 0.03$	$2.37 \rightarrow 2.55$

Salas et al. (2020)

## Normal Ordering (NO):

- $m_1 = m_{\text{lightest}}$
- $m_2 = \sqrt{m_{\text{lightest}}^2 + \Delta m_{21}^2}$
- $m_3 = \sqrt{m_{\text{lightest}}^2 + \Delta m_{31}^2}$

## Inverted Ordering (IO):

- $m_3 = m_{\text{lightest}}$
- $m_1 = \sqrt{m_{\text{lightest}}^2 + |\Delta m_{21}^2|}$
- $m_2 = \sqrt{m_{\text{lightest}}^2 + \Delta m_{21}^2 + |\Delta m_{31}^2|}$

$$(\mathbf{M}'_{\nu})_{ii} = (\mathbf{U}^* \text{diag}(m_1, m_2, m_3) \mathbf{U}^\dagger)_{ii} = 0$$



Corresponds to **two low-energy constraints**, testable against **neutrino data!**

Lepton mixing (standard parametrisation): Rodejohann, Valle (2011)

$$\mathbf{U} = \begin{pmatrix} c_{12}c_{13} & s_{12}c_{13}e^{-i\phi_{12}} & s_{13}e^{-i\phi_{13}} \\ -s_{12}c_{23}e^{i\phi_{12}} - c_{12}s_{13}s_{23}e^{-i(\phi_{23}-\phi_{13})} & c_{12}c_{23} - s_{12}s_{13}s_{23}e^{-i(\phi_{12}+\phi_{23}-\phi_{13})} & c_{13}s_{23}e^{-i\phi_{23}} \\ s_{12}s_{23}e^{i(\phi_{12}+\phi_{23})} - c_{12}s_{13}c_{23}e^{i\phi_{13}} & -c_{12}s_{23}e^{i\phi_{23}} - s_{12}s_{13}c_{23}e^{-i(\phi_{12}-\phi_{13})} & c_{13}c_{23} \end{pmatrix}$$

Dirac phase:  $\delta = \phi_{13} - \phi_{12} - \phi_{23}$

Majorana phases:  $\phi_{13}, \phi_{12}$



# $\theta_{23}$ and $\delta$ predictions

DB, F. R. Joaquim, R. Srivastava, J. W. F. Valle (2020)

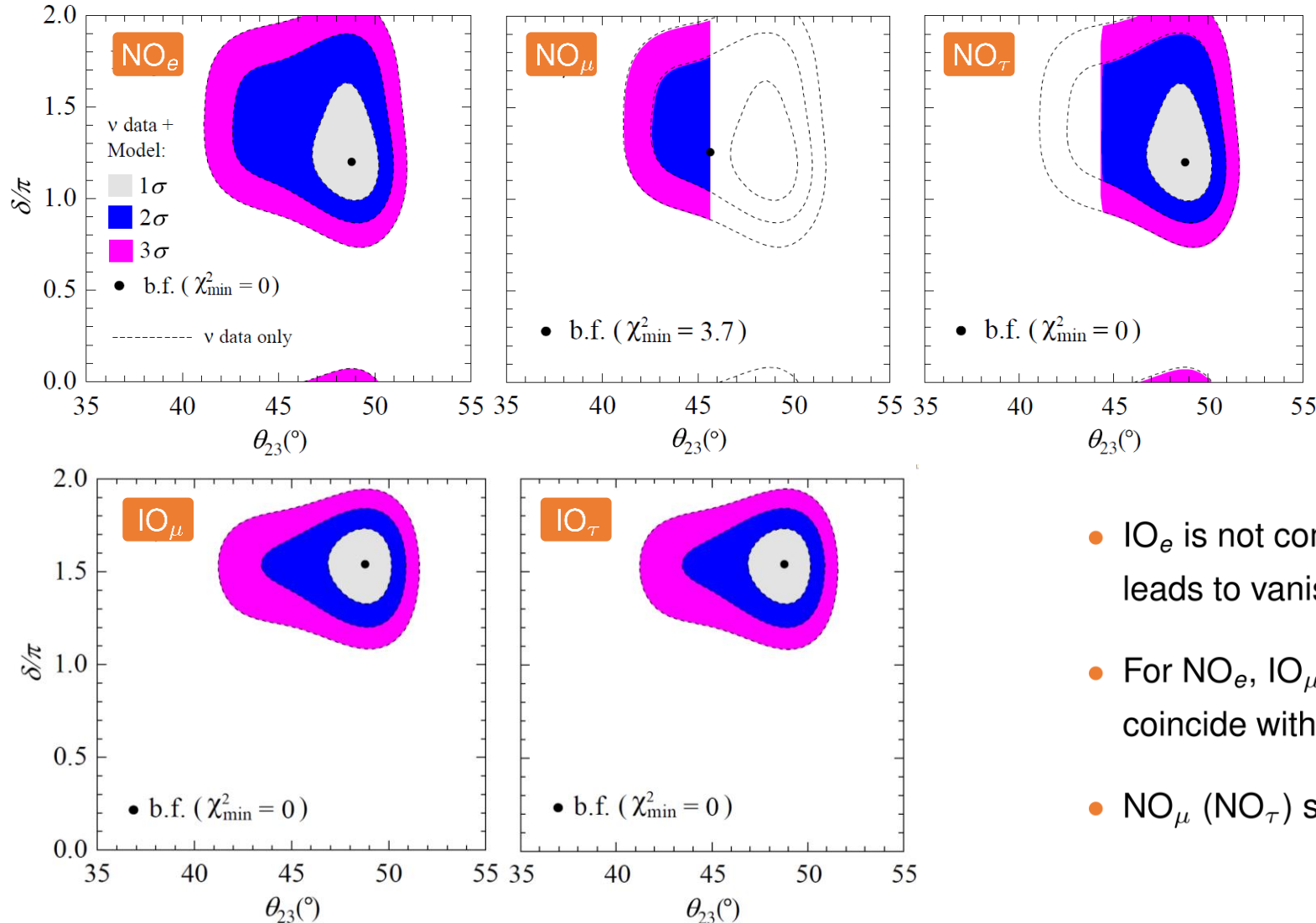

decoupled **electron**:  $(\mathbf{M}'_{\nu})_{11} = 0$   
 decoupled **muon**:  $(\mathbf{M}'_{\nu})_{22} = 0$   
 decoupled **tau**:  $(\mathbf{M}'_{\nu})_{33} = 0$

- IO<sub>e</sub> is not compatible with data since  $(\mathbf{M}'_{\nu})_{11} = 0$  leads to vanishing  $0\nu\beta\beta$  decay rate
- For NO<sub>e</sub>, IO <sub>$\mu$</sub>  and IO <sub>$\tau$</sub>  the model allowed regions coincide with the experimental ones
- NO <sub>$\mu$</sub>  (NO <sub>$\tau$</sub> ) selects the first (second) octant for  $\theta_{23}$

# Constraints on the lightest neutrino mass

DB, F. R. Joaquim, R. Srivastava, J. W. F. Valle (2020)

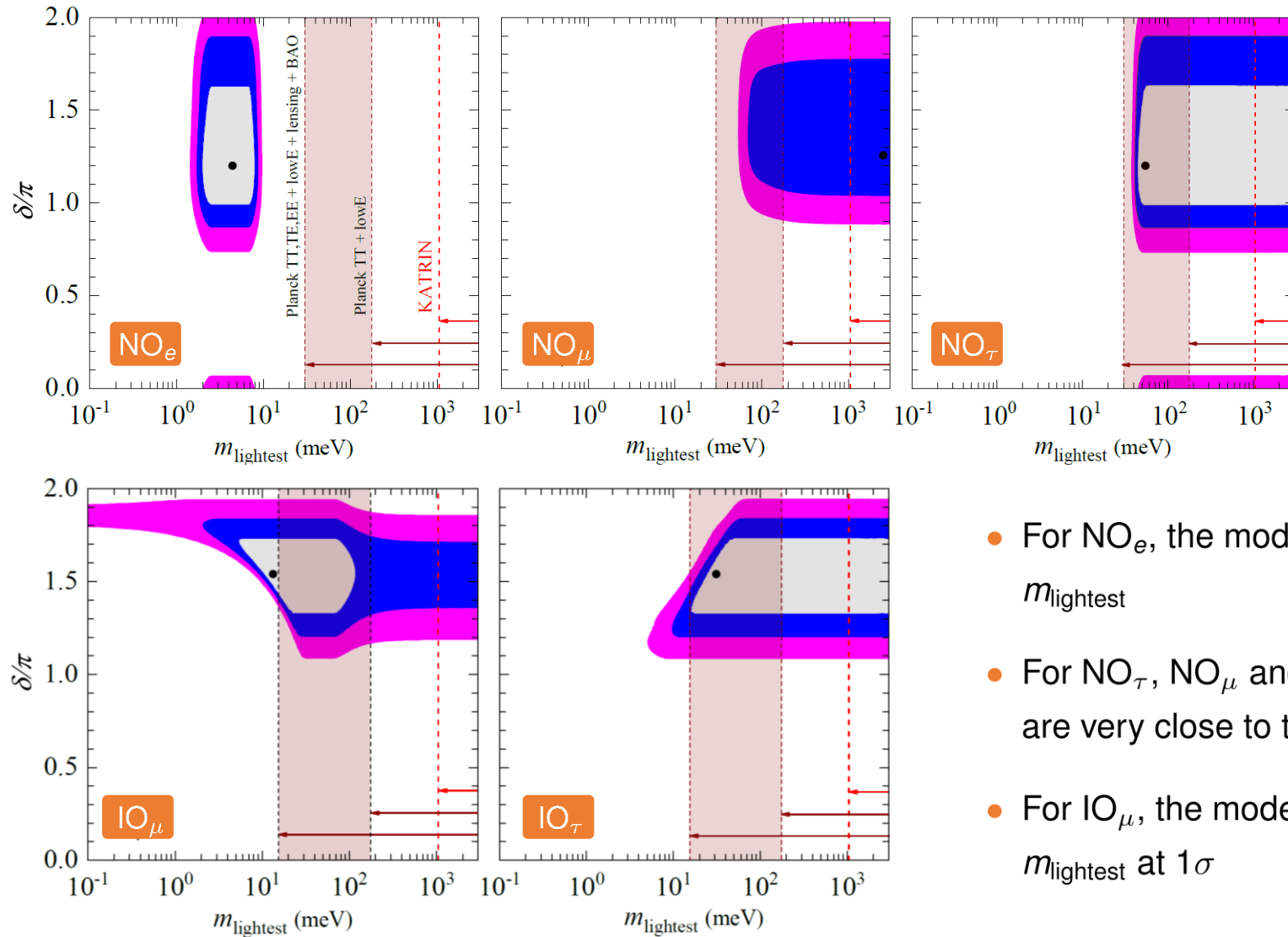

decoupled **electron**:  $(\mathbf{M}'_{\nu})_{11} = 0$   
 decoupled **muon**:  $(\mathbf{M}'_{\nu})_{22} = 0$   
 decoupled **tau**:  $(\mathbf{M}'_{\nu})_{33} = 0$

- For NO<sub>e</sub>, the model establishes upper and lower bounds for  $m_{\text{lightest}}$
- For NO<sub>τ</sub>, NO<sub>μ</sub> and IO<sub>τ</sub> we get lower bounds for  $m_{\text{lightest}}$  which are very close to the cosmological and KATRIN bounds
- For IO<sub>μ</sub>, the model establishes upper and lower bounds for  $m_{\text{lightest}}$  at  $1\sigma$

# Constraints on $m_{\beta\beta}$

DB, F. R. Joaquim, R. Srivastava, J. W. F. Valle (2020)

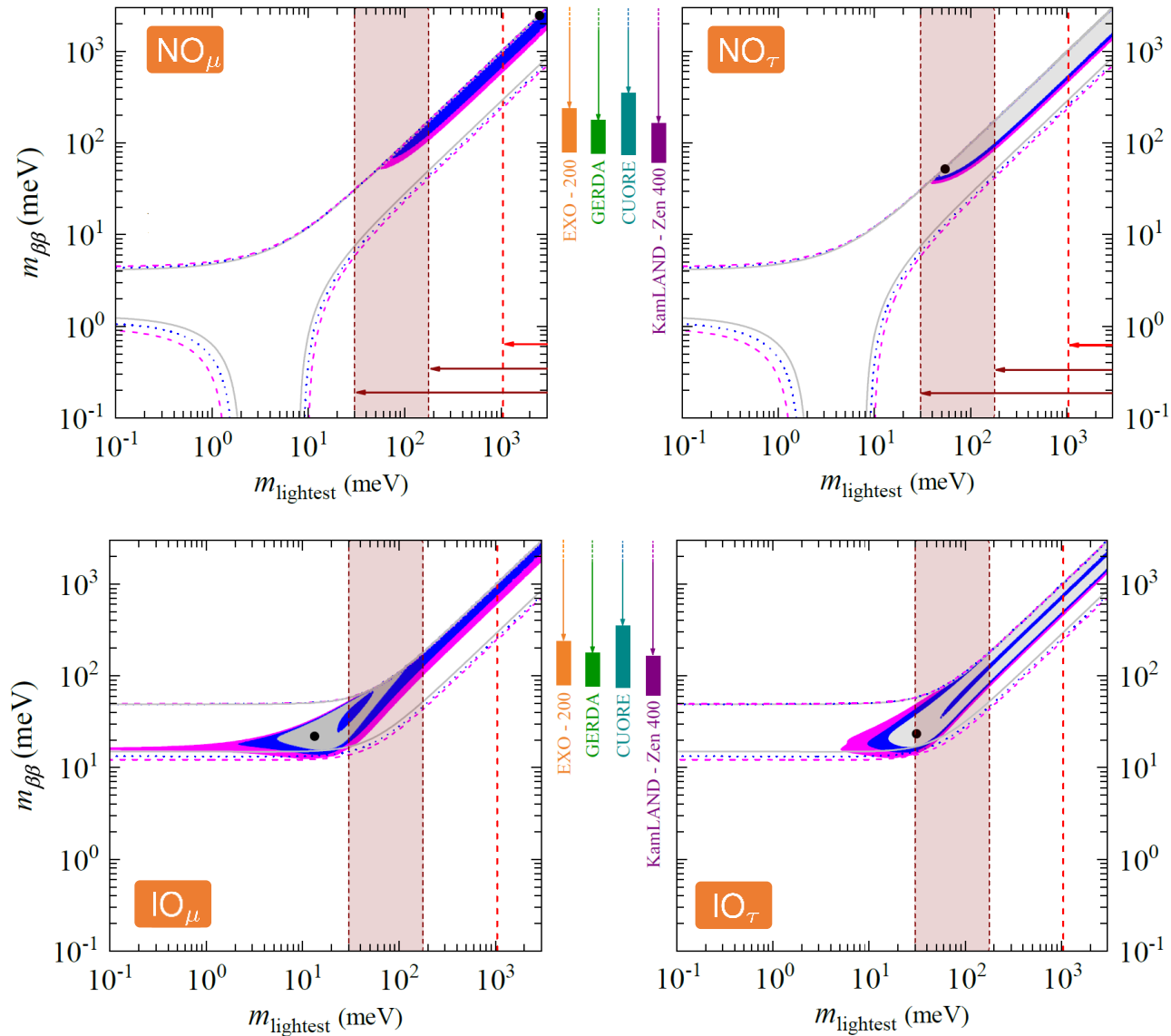

## $m_{\beta\beta}$ in terms of low-energy parameters

$$\text{NO: } m_{\beta\beta} = \left| c_{12}^2 c_{13}^2 m_{\text{lightest}} + s_{12}^2 c_{13}^2 \sqrt{m_{\text{lightest}}^2 + \Delta m_{21}^2} e^{2i\phi_{12}} \right|$$

$$\text{IO: } m_{\beta\beta} = \left| c_{12}^2 c_{13}^2 \sqrt{m_{\text{lightest}}^2 + \Delta m_{21}^2} + s_{12}^2 c_{13}^2 \sqrt{m_{\text{lightest}}^2 + \Delta m_{21}^2} + |\Delta m_{31}^2| e^{2i\phi_{12}} + s_{13}^2 m_{\text{lightest}} e^{2i\phi_{13}} \right|$$

- $\text{NO}_e$  predicts  $m_{\beta\beta} = 0$ , allowed by neutrino oscillation data and  $m_{\beta\beta}$  current experimental limits
- In all remaining cases the model establishes a lower bound on  $m_{\beta\beta}$
- Current KamLAND bound nearly excludes the NO cases

# Concluding remarks

- We propose a **simple scoto-seesaw model** where **neutrino masses**, **lepton flavour structure**, **dark matter stability** and **spontaneous CP violation** are accommodated with a single  **$Z_8$  flavour symmetry**
- This symmetry is **broken down to dark  $Z_2$**  by the VEV of a new **complex scalar singlet  $\sigma$**
- The complex VEV of  $\sigma$  is the **unique source of leptonic CP violation**, arising **spontaneously**
- The generated CP violation is **successfully** transmitted to the leptonic sector via **couplings of  $\sigma$  to  $\nu_R$  and  $f$**
- The  $Z_8$  symmetry leads to **low-energy constraints**, which translate into a **neutrino texture** that can be tested against neutrino experimental data
- For **NO**, the **predicted ranges on  $m_{\text{lightest}}$**  will be **fully tested** by near future  **$0\nu\beta\beta$ -decay** experiments and by improved neutrino mass sensitivities from **cosmology** and  **$\beta$  decay**
- For **IO**, better determination of the **Dirac phase** from neutrino oscillations and further improvement in expected sensitivities from upcoming  **$0\nu\beta\beta$ -decay** experiments is required to test the model

**Thank you!**

# Acknowledgements

This work is supported by the Spanish grants SEV-2014-0398 and FPA2017-85216-P (AEI/FEDER, UE), PROMETEO/2018/165 (Generalitat Valenciana), the Spanish Red Consolider MultiDark FPA2017-90566-REDC and Fundação para a Ciência e a Tecnologia (FCT, Portugal) through the projects UIDB/00777/2020, UIDP/00777/2020, CERN/FIS-PAR/0004/2019, and PTDC/FIS-PAR/29436/2017. D.B. is supported by the FCT grant SFRH/BD/137127/2018. R.S. is supported by SERB, Government of India grant SRG/2020/002303.