

Proposal of a progressive thermalization fusion reactor able to produce nuclear fusions with a mechanical gain superior or equal to 18

Patrick Lindecker

Maisons-Alfort (France)

21th of February 2021

Revision A

Email address: f6ctefusion@free.fr

Copyright © 2021 Patrick Lindecker All rights reserved

Shortened title: Proposal of a progressive thermalization fusion reactor which mechanical gain is ≥ 18

Abstract: in the standard fusion reactors, mainly tokamaks, the plasma, in thermal equilibrium, is heated up to an energy of about 15 keV with complicated devices. At the present time, the mechanical gain obtained by these reactors is below 1. In the other hand, there are colliding beam fusion reactors, as for example the « Fusor », for which, the particles are initially injected radially. The plasma not being neutral in these reactors, the space charge limits the number of fusions to a very small number. Consequently, for this reason and for others reasons, the mechanical gain is extremely low.

The proposed reactor is also a colliding beam fusion reactor using initial directed beams, but D+/T+ ions are injected in opposition, with electrons, at high speeds, so as to form a neutral beam. All these particles turn in a magnetic loop in form of figure of "0" ("racetrack"). The plasma is initially non-thermal but, as expected, rapidly becomes thermal, so all states between non-thermal and thermal exists in this reactor. The main advantage of this reactor is that this plasma after having been brought up near to the optimum conditions for fusion (around 68 keV), is then maintained in this state, thanks to low energy non-thermal ions (≤ 15 keV). So the energetic cost is low and the mechanical gain (Q) is elevated (≥ 18). There is no net plasma current inside this reactor, so no disruptive instabilities and consequently, the working is continuous. Moreover, the main plasma control by the particles injectors (I and U) is relatively simple. This reactor has been partly checked on a simulator.

CONTENTS

Page

1. Goal, presentation and notations used	3
2. Brief explanations of a few of the terms used	4
3. Simulator used	5
4. Principle of the fusion reactor	6
4.1 General state	6
4.2 Proposal	6
5. Description of the fusion reactor	9
5.1 Preliminary	9
5.2 Test reactor (figure of "8") using only a toroidal magnetic field	10
5.3 Fusion reactor (figure of "0") using toroidal and poloidal magnetic fields	15
5.4 About the beam and the particle energies circulating in the figure of "0"	16
5.5 About the pipe sizing	24
5.6 About collisions with neutrals	25
5.7 Losses compensation and balance of energies	27
5.8 Control of the reactor	31
6 Determination of the mechanical and electrical gains	32
6.1 Introduction	32
6.2 Deuterium/Tritium fusion	36
6.3 Deuterium/Deuterium fusion	42
6.4 Proton/Boron11 fusion	42
6.5 Deuterium/Helium 3 fusion	43
7 General conclusion	44
APPENDIX A Effect of electrons on the kinetic energy of ions	45
APPENDIX B D/T reactor energy balance and stability evaluation	50
APPENDIX C Evaluation of the maximum radial shift, with a poloidal magnetic field	52
APPENDIX D Equilibrium of ions energy under Coulomb collisions	55
8. References	56

1. Goal, presentation and notations used

The goal of this presentation is to describe a new type of colliding beam fusion reactor using magnetic confinement and hosting two opposed beams of electrons and two opposed beams of ions. All these beams, initially directed axially, circulate inside a figure of "0" configuration, also called "racetrack". The global injected current is nil.

This reactor would produce nuclear fusions with:

- a mechanical gain (Q), i.e. neutrons fusion power/ mechanical injection power, superior or equal to 18,
- an electrical gain (Ge), i.e. electrical energy supplied by the alternator/ electric energy consumed (auxiliary equipment included) superior or equal to 2.6, for the D/T fuel.

On this article, it is supposed the use of a Deuterium/Tritium (D/T) fuel as it is the sole fuel able to give a good electrical gain.

D/D, p/B11 and D/He3 are studied in §6. For D/D, p/B11, by taking reasonable hypothesis about radiations losses, it does not seem possible for the fusion power to pass these losses. D/He3 fuel cannot reach a sufficient mechanical gain to be interesting. However a possibility of hybrid reactor D/T/He3 could be, at least, envisaged (see §6.5 for D/He3).

This D/T reactor is mainly aimed to produce electricity. However, in §6.2.4, it is made proposals for a reactor permitting spatial propulsion.

The problems of tritium regeneration coupled with neutrons slowing down and heat extraction, cryogenic systems, ultra high vacuum, particles diversion in the "Divertor" (to "clear" the plasma), plasma/first wall interface, neutrons management relatively to materials, radiation hygiene and possible instabilities, etc are not addressed.

This article is only concerned by the fusion aspect, at the level of principles, the physics used being relatively simple.

This presentation relies on the Multiplasma simulator program version 1.18 developed by the author and used for the simulation of such reactor (limited to straight pipes).

In this paper, to simplify, the relativity is, in general, not considered even for electrons, because electrons energy remains relatively low, i.e. 100 keV maximum for the D/T fusion.

Notations

- the simple product is indicated with « x » or « . » or is not indicated if there is no ambiguity,
- the powers of ten are indicated with Ex or 10^x (for example 10^{-7} or E-7),
- "x^y" and "x ^ y" are equivalent
- "√" means square root
- "<<" for "very inferior" and ">>" for "very superior"
- |x|, absolute value of x
- "§" for "chapter"
- "≈" for "about"
- "∝" for "proportional"
- "∧" for "vectorial product" (vectors are in bold, scalar in standard font)
- <x> for "mean value" of x
- "COM" or "com" is worth for "center-of-mass" ("Ecom"=Energy of the center-of-mass).

SI units, multiples (km for example) and sub-multiples (mm for example) are only used, with the exception of the "eV" ("Electronvolt").

2. Brief explanations of a few of the terms used

- Deuterium (D) / Tritium (T): these are hydrogen isotopes comprising, besides one proton, either one neutron (Deuterium) or 2 neutrons (Tritium). As other elements, they are susceptible to produce fusions by collisions. The Deuterium is relatively abundant, in sea water, for example. It constitutes 0.01 % of hydrogen. The tritium is naturally present at traces amounts but it is produced (as a gaseous effluent) by fission nuclear centrals, in very small quantities. So tritium must be regenerated by the reactor itself.
- Interaction: it refers to the effect produced by two particles bumping each other: it can be an excitation, dissociation or a radiation (not considered by Multiplasma), a collision, an ionization, a fusion.
- eV: the eV is a unit of energy quantity used in the particles domain.
1 eV is equivalent to $1.602 \cdot 10^{-19}$ J. It is the energy of a single charge submitted to a potential of 1 V.
- Fusion: specific interaction where two particles (as D+) collide with sufficiently energy to be transformed in other particles with production of a certain quantity of kinetic energy (besides the initial kinetic energy of the particles colliding each other).
Several fusion reactions of interest are given below :
 - $D^+ + D^+ \rightarrow T^+ (+1.01 \text{ MeV}) + p (+3.02 \text{ MeV})$ (at 50%)
 - $D^+ + D^+ \rightarrow He3^+ (+0.82 \text{ MeV}) + n (+2.45 \text{ MeV})$ (at 50%)
 - $D^+ + T^+ \rightarrow He4^+ (+3.5 \text{ MeV}) + n (+14.1 \text{ MeV})$
 - $H^+ + B11^+ \rightarrow 3 He4^+ (+ 8,68 \text{ MeV})$ (aneutronic fusion)
 - $D^+ + He3^+ \rightarrow He4^+ (+ 3.67 \text{ MeV}) + p (+ 14.67 \text{ MeV})$ (aneutronic fusion)

Note that D/T and D/He3 fusions are around 17 million times more efficient than O2/H2 combustion (in quantity of dissipated energy by unity of mass).

- Ions: in our case, it refers to an atom (D, T, B11, He3...) having lost one or more electrons, to give an atomic ion (noted D+, T+, B11+ or He3+). It could also be a molecular ion if the molecule has lost an electron (D2+ or T2+). A molecule (D2) can be dissociated in atoms (D + D) and/or ionized (D+/ D+ or D2+).
- Cross section: it refers to the collecting surface of the interaction. The larger it is and the more it will be produced interactions. It can also be seen as an interaction probability.
- Space charge: each ion and each electron creates its own electrical field to which all other charged particles are submitted. So, the space charge is equal to the sum of all these individual micro-electrical fields. In total, the particles of the same polarity tend to deviate from one another.

3. Simulator used

The program, developed by the author, is called Multiplasma. It is a particle-in-cell 3D simulator under Windows, written in Delphi 6 (i.e. Pascal object). It is able to simulate particles trajectories and the main interactions between particles (see below).

About the model used: each particle submitted to an electrostatic force (but not present in this version) or a magnetic force evolves in a linear way during the time step. Moreover, a particle can:

- gain or lose energy (i.e. speed) and/or
- change of direction following a Coulombian collision, according to a diffusion angle,
- disappear (with its energy) in case of fusion, collision on the pipe wall or charge exchange with a neutral.

The diamagnetism effect is taken into account by the simulator, in a simplified way, so as to limit the CPU load (a Biot and Savard law application would take too much CPU load).

The present version (February 2021) is the 1.18 one. It is public but reduced to the limited set of functions used to simulate the reactor described in this paper. For this limited version, only ions trajectories are simulated and the interactions considered are the following:

- Coulombian collisions between ions (I/I).
- I/N elastic collisions: the loss of energy of the incident ion is taken into account.
- I/I and I/N fusions.
- I/N charge exchanges. For such interaction, the ion and its energy are lost (see [§5.6.3.1](#) for this hypothesis). The neutral is also considered lost.
- I/N ionizations. By (penalizing) hypothesis, the ion created by ionization is not taken into account because the real dynamic of the ion creation is not known, so it is supposed that this slow ion escapes the beam. However, the loss of energy of the incident ion is taken into account.

All the secondary collisions ($EI_N + N_N$) are ignored in this version. The turbulences and non-linearities are ignored. The toroidal magnetic field is supposed perfect (for example, no modulation of this one due to discrete toroidal coils). There is no poloidal field simulated (not necessary for a straight pipe).

Neutrons of the D2 gas are virtual. But their effects on ions are considered (see the interactions above).

Electrons are virtual. Their effects on ions are considered, as:

- bound and free electrons (see [Appendix A](#)),
- sources of radiations losses (see [§5.4.3](#)).

Alpha particles (called "Alphas") are virtual but their effect is considered to heat the plasma and, particularly, the replacement ions (i.e. ions lost and then re-injected) (see [§5.4.7](#)).

This simulator manages $D+T+$, $D+D+$ and $D+He3+$ fusions.

Note that simulations are limited to straight pipes (not the loops). Moreover, it is implicitly supposed, in this program, that energy exchanges between electrons and ions and between Alphas and electrons and ions are immediate. Electrons thermalization is also supposed immediate.

The Multiplasma version 1.18 is proposed to download in "freeware", from this direct link http://f6cte.free.fr/MULTIPLASMA_V_1_18_setup.exe.

4. Principle of the fusion reactor

4.1 General state

In the standard fusion reactors, mainly tokamaks, the plasma is in thermal equilibrium (i.e. the speeds follow a Maxwell Boltzmann isotropic distribution, function of the plasma energy), at a mean energy of about 15 keV. The plasma is heated with different devices (induction, radio frequencies, adiabatic compression, neutral atoms injection...). At the present time, the mechanical gain (i.e. kinetic fusion products energy / mechanical energy consumed) obtained by these reactors is a bit below 1, but it will, probably, pass 1 in the next years.

Less known are the "Colliding Beam Fusion Reactors" (CBFR), as, for example, the « Fusor » and the "Polywell". For these CBFR, the particles are initially injected radially, due to a local electrostatic field, with, ideally, a fixed sufficient magnitude. The natural evolution of the speeds distribution is a certain randomization due to collisions and space charge.

However the plasma not being neutral in these reactors, the space charge limits the maximum ions density and, consequently, the number of fusions is very small. Consequently, for this reason and for others reasons (as, for example, the problem of the elevated number of collisions with neutral particles), the mechanical gain is very low.

For more details about these CBFR reactors, refer to documents in reference [\[1\]](#) and [\[2\]](#).

4.2 Proposal

The proposed reactor pertains to the CBFR category of reactors, so it is much less complex than a Tokamak.

To have an important fusion power, the beam must be necessarily neutral so as to escape from the space charge problem which drastically prevents to have a reasonable density of ions (D+/T+). So a mix of electrons and ions is proposed for neutrality.

Ions and electrons are injected with relatively elevated currents, up to the moment when the currents circulating in the figure of "0" reach their nominal values (the global current being nil). In permanent working, the electrons and D+/T+ ions are injected at a rate permitting to cover losses and fusions, so as to keep the beam neutral. The working is continuous.

However injecting fast ions in a static electrons cloud with a sufficient energy will be useless, as most of the ions energy will be lost on electrons collisions. So the electrons must move at a sufficient speed, to reduce the stopping effect of these ones (see [Appendix A part 1](#)).

Moreover, if electrons are sufficiently fast, the Coulomb collisions between ions and electrons permit an equilibrium of energy between all these particles. See the [Appendix A part 2](#).

D+/T+ ions are injected in opposition at the same speed and form a neutral beam with the injected electrons. Ions produce, at least at the beginning, frontal fusions $D^+ \leftrightarrow T^+$, aside to Coulomb collisions. The beam turns in a magnetic closed loop in form of figure of "0" (see the [figure 1](#)).

After thermalization, the particles will turn on the loop in one direction or the other, randomly.

Note 1: there is no net plasma current in this reactor because sources of current of the same magnitude are opposed (D+ with T+, and the two injections of electrons). So it will not appear disruptive instabilities. However, it exists a bootstrap current (see [Appendix C](#)) which must be minimized.

Note 2: the reactor filling (electrons + ions) is made without any strong recommendations about the beam diameter (see [§5.4.6.2](#)). However, the replacement ions (for ions lost or fused) are injected at the center of the pipe, inside a 1 cm beam diameter as a first hypothesis, but in any case the most centralized possible, so to have the largest possible confinement time and a good probability of

fusion.

Ions fusions (between D+ and T+) are produced:

- for a very small part, by frontal collisions, at low mean ions energy E_i (i.e. E_i around 34 keV), between injected ions not yet thermalized,
- for the rest, by central collisions, at high mean ions energy (i.e. E_i around 68 keV), between ions thermalized (completely or not).

The plasma is slowly heated by Alphas (He4) particles (see [§5.4.7](#) and [§5.4.5.3](#)), up to energies ($E_i \approx 68$ keV) where the central fusions are made at a condition very close to the ideal one (i.e. at a center-of-mass energy of 65 keV, about 4 times higher than in Tokamaks).

Note that the first frontal fusions obtained from the non-thermal ions injected during the filling will heat the plasma thanks to Alphas more efficiently compared to only central fusions.

Once this state ($E_i \approx 68$ keV) reached, the replacement particles can be injected at relatively low energies as explained in [§5.7.3](#).

The fusion rate will be about 30 times better than in present tokamaks. Now, due to the relatively low cost of injection energy, the mechanical gain, for the D/T fuel, will be elevated (≥ 18). Consequently, the electrical gain will be also relatively good (≥ 2.6), so this reactor is able to produce electricity. Note that the electrical gain is inferior to 1 for the other fuels.

For about the plasma control, see the [§5.8](#).

The toroidal magnetic field (B) must be axial relatively to the pipe, and maximum to confine particles (electrons + ions). The present industrial maximum B limit for superconducting coils is 5 T (Tesla). So this 5 T field will be supposed all along this paper, as the default value.

Note 1: if it appears that the Beta limit (see [§5.1](#)) for this reactor could be raised up to a value higher than 0.1, it would be possible to consider a lower magnetic field. For example, for Beta max=0.82, it could be envisaged to work with a field of 1.4 T, i.e. with the maximum B field of permanent magnets (see [§5.4.6.3](#) and [§6.2.2.4](#)).

Note 2: the consumed cryogenic power for superconductive coils (and thermal shield) will probably be the biggest source of auxiliary power. Now as, roughly, the cryogenic electric power for superconductive coils depends on the pipe radius (R_p) and the power supplied by the reactor depends on R_p^2 , it will be advantageous to make big units.

At fusion densities, a poloidal field is indispensable to limit the particles shift inside loops (see [§5.3](#) and [Appendix C](#)).

Below, on the [figure 1](#), is displayed the principle diagram of this figure of “0” reactor.

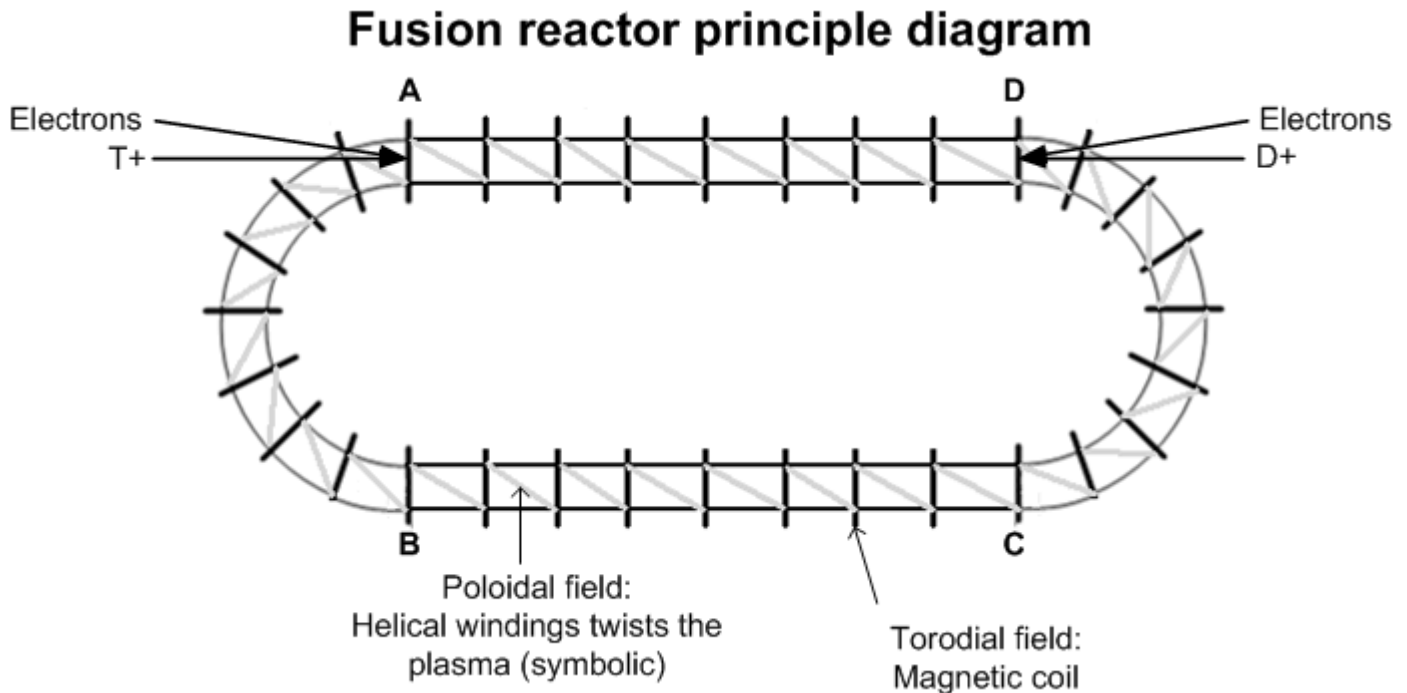

Figure 1

Once the equilibrium state (near $E_i=68$ keV) reached, replacement particles (ions in fact for the very big majority) are injected at relatively low energies. For example, as proposed in [§6.2.2.2](#), D^+ ions could be injected axially at 12 keV, T^+ ions at 18 keV but in the opposed direction and electrons at 14.4 keV, in both directions. In the straight pipes between A and D and B and C, D^+ ions, T^+ ions and electrons form an almost cylindrical neutral beam. In the loops, due to the shift, the neutral beam section is not circular and ions D^+/T^+ are slightly separated. At a minimum, at 5 T, the pipe diameter is equal to 0.38 m on straight pipes and 0.46 m on loops (see [§5.5](#)).

About this type of reactor, here are several problems (with their solutions):

- the radiation losses on electrons lead to an electrons energy decrease and, consequently, through Coulomb collisions between ions and electrons, to a global plasma energy decrease. This problem is solved thanks to the Alphas heating (see [§5.4.7](#) and [§5.7](#) for details).
- the collisions and charge exchange with gas neutrals. This leads to reduce the gas pressure in the UHV domain (10 nPa) (cf. [§5.6](#)).
- the Coulomb collisions between ions (D^+ and T^+) lead to a quick thermalization of ions in the plasma (in less than 0.3 s) and, consequently, to central collisions instead of frontal collisions between ions, which makes drastically decrease the fusion rate. It is solved by elevating the mean ions energy to a magnitude for which the fusion cross-section is maximum in this configuration (cf. [§5.7](#)). Note that the number of Coulomb collisions decreases when the ions energy increases.

Note that the name given to this machine is “Progressive Thermalization Fusion Reactor”, because, in this type of reactor, all types of ions are present, from not thermalized (when injected) to completely thermalized, one of the advantages of this reactor being due to this small part of not thermalized ions which can fuse at relatively low energies ([§5.7.2](#)).

Note that the mean thermalization level is about 85%, considering all the plasma (i.e. the ions mean radial energy is equal to 57% instead 66.7% of the total energy).

In this document, the electrons are supposed:

- to thermalize immediately, due to their very high speed,
- consequently, to make an electrostatic screen to ions outside the electrons Debye sphere.

5. Description of the fusion reactor

5.1 Preliminary

The plasma density will be limited to $2E20$ ions/m³ so as to be compatible with the standard industrial structure materials. Therefore, the ions and electrons densities (n_i and n_e) will be limited to $1E20$ particles/m³.

The Beta factor (related to the diamagnetism of particles rotating around the axial magnetic field lines) will be limited to 0.1 which is the present maximum value for tokamaks and stellarators. The author ignores if this limit of 0.1 really applies to this reactor. It is taken by precaution.

Note that disruptive instabilities occur in tokamaks due to their plasma current aimed to create a poloidal field. In the reactor proposed, the sum of all the currents is nil, so there is no net current through the plasma (except the bootstrap current, see [Appendix C](#)), and so no such drawback. Consequently, the Greenwald and Troyon limits don't apply, and so the pipe radius and the magnetic field will not be sized according to these limits.

However, it is clear that other possible instabilities can occur (probably in the loops, if any).

The plasma in the reactor presented here is heterogeneous because it is received axially directed replacement ions at the center of the section. These ions are going to thermalize and to slowly diffuse towards the pipe wall.

Note: the diamagnetism field is, at the center, a bit higher, due to the injection of replacement ions. The local Beta decreases slowly with the distance to the center. So here the "Beta factor" is a mean Beta factor calculated over the entire beam.

For a maximum Beta factor of 0.1, the particles mean energy used for this reactor will be limited to 93 keV and n_e and n_i will be limited to $5E19$ instead $1E20$. So it will used $n_i=n_e=5E19$, all along this document. Note that a Beta factor double would permit to increase the particles densities by 2 and consequently the fusion rate by 4.

Below ([§5.2](#) and [§5.3](#)), it is proposed:

- In [§5.2](#), a test reactor (figure of "8") using only a toroidal magnetic field (no poloidal magnetic field), for a low plasma density. However, the principles described apply also to the figure of "0" reactor.
- In [§5.3](#), a fusion reactor (figure of "0"), using toroidal and poloidal magnetic fields, for a relatively high plasma density.

5.2 Test reactor (figure of “8”) using only a toroidal magnetic field

5.2.1 Drift

5.2.1.1 Curve drift speed

When particles turn, the centrifugal force will produce a cycloidal drift perpendicular to the figure plane (see reference [7] page 129). This drift is perpendicular to the magnetic field direction.

Precisely the curve drift speed D_{cs} , with the magnetic field B perpendicular to the radial centrifugal force

$$F = \frac{m \times Va^2}{r} \text{ is equal to } D_{cs} = \frac{F}{q \times B} = \frac{m \times Va^2}{r \times Z \times q \times B}$$

r is the curve (loop) radius, m is the particle mass and Va the particles axial speed (i.e. parallel to the B magnetic field), $Z \times q$ is the particle electric charge, with $q=1.602E-19$ C, and Z the number of charges of the ion. As, for D/T fusion, Z is always equal to 1, Z will not be mentioned all along the §5. So $D_{cs} = \frac{m \times Va^2}{r \times q \times B}$

Note: in a vectorial form (in bold) $D_{cs} = \frac{F \wedge B}{q \times B^2}$ which means that D_{cs} evolves in the same direction for $D+$ and $T+$ ions, as it does not depend on their direction of circulation (but on the direction of F and B). However for an electron, q is negative so the direction of D_s is opposed (effect which tends to separate ions and electrons). See the [figure 2](#).

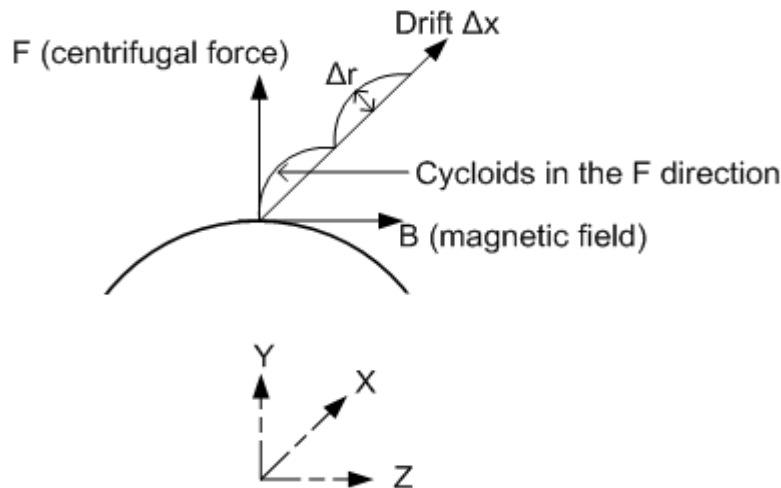

Figure 2 (drift along x and cycloids along F)

5.2.1.2 Magnetic field drift speed

There is another drift acting in the same direction and called “magnetic field drift”. It is due to the magnetic field which is not constant on a section, as the B field decreases from the internal radius (“low field” side) to the external radius (“high field” side) of the loop. It depends on the radial speed Vr of the particles, Vr being perpendicular to the magnetic field. The magnetic drift speed is equal to:

$$D_{ms} = \frac{m \times Vr^2}{2 \times r \times q \times B} \text{ Now, due to thermalization, } \langle Vr^2 \rangle = 2 \times \langle Va^2 \rangle, \text{ so this drift cannot be neglected.}$$

5.2.1.3 Total drift speed

The sum of these two drift speeds (of the same direction) gives a total drift speed, equal to:

$$D_s = \frac{m}{r \times q \times B} \left(\frac{Vr^2}{2} + Va^2 \right)$$

The total drift speed (m/s) for electrons and ions are respectively called D_{se} and D_{si} .

5.2.1.4 Charges separation and electric drift speed

Due to these initial drift speeds, electrons and ions will be separated as they drift in opposed directions, creating two opposed currents ($n_i \times q \times D_{si}$ and $n_e \times q \times D_{se}$). These opposed currents are going to create an electric field and so an attractive Coulomb force between electrons and ions. Using the Maxwell-Ampere theorem with a non-rotational magnetic field, it will be found that the electric field E is equal to (cf. [10] page 130):

$$E = \frac{-n \times q \times (D_{se} + D_{si}) \times t}{\epsilon_0}$$

With $n (=n_i = n_e)$ the electrons or ions density and ϵ_0 the vacuum permittivity (8.854×10^{-12} F/m)

The electric field E and the magnetic field B being perpendicular, an electric drift speed V_{out} is generated.

$$V_{out} \text{ is equal to (cf. [10] page 130): } V_{out} = \frac{E \times B}{B^2}$$

Both electrons and ions are radially ejected towards the exterior of the loop at the same speed V_{out} (for example towards Y relatively to the [figure 2](#)).

Now supposing that the mean ions energy E_i is equal to the mean electrons energy E_e , which is true within several percent, it can be written: $V_{out} = \frac{8 \times n \times q \times E_i (eV) \times t}{3 \times r \times \epsilon_0 \times B^2}$ With E_i expressed in eV and t the time (s) elapsed

from the beginning of the loop circulation. Moreover, the acceleration is equal to: $\gamma_{out} = \frac{8 \times n \times q \times E_i (eV)}{3 \times r \times \epsilon_0 \times B^2}$

5.2.1.5 Maximum drift ΔR

The maximum radial drift ΔR (m) along the loop is equal to $\Delta R = \gamma_{out} \times \frac{t^2}{2}$ with $t = \frac{C}{V_a}$

With C the circumference travelled by the particle on one of the bottom or top circular part (radius r) of the loops (supposed to be located on the YZ plane of the [figure 2](#)) and V_a the axial speed of the particle through the loop.

If the density n is small (i.e. $n < 1 \times 10^{13}$), ΔR remains small (<3 cm). It will be taken this hypothesis below.

5.2.2 Trajectory of a particle in a figure of "0"

Below ([figure 3](#)) is an example of trajectory for a figure of "0" (one loop). It is clear that the radial drift will make escape the particles from the figure of "0".

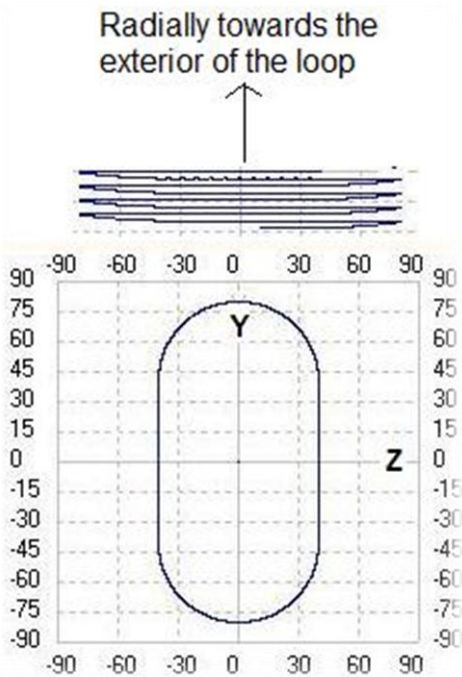

Figure 3 (radial drift on a figure of "0")

5.2.3 Trajectory of a particle in a figure of "8"

One solution is to make circulate particles in a figure of "8" configuration, as the first form of Stellarator model by Lyman Spitzer (see reference [\[3\]](#) for this model and also for the different stellarators). In this case, the radial drift in one loop equilibrates the radial drift in the other loop, and globally there is no drift, as shown in the example below ([figure 4](#)).

Radial drift towards the exterior of the loop

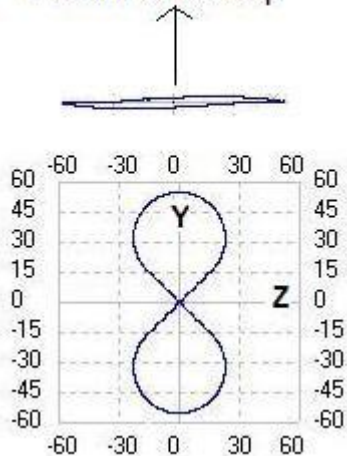
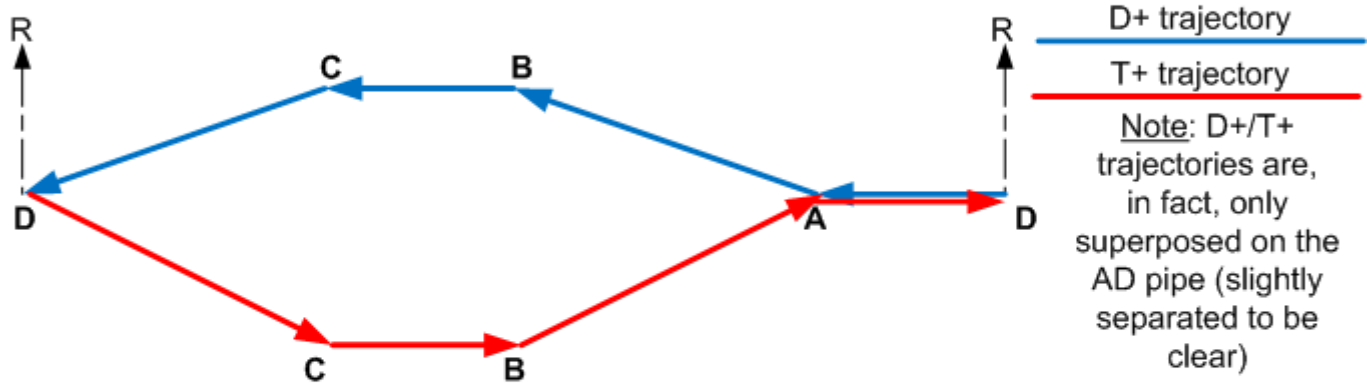
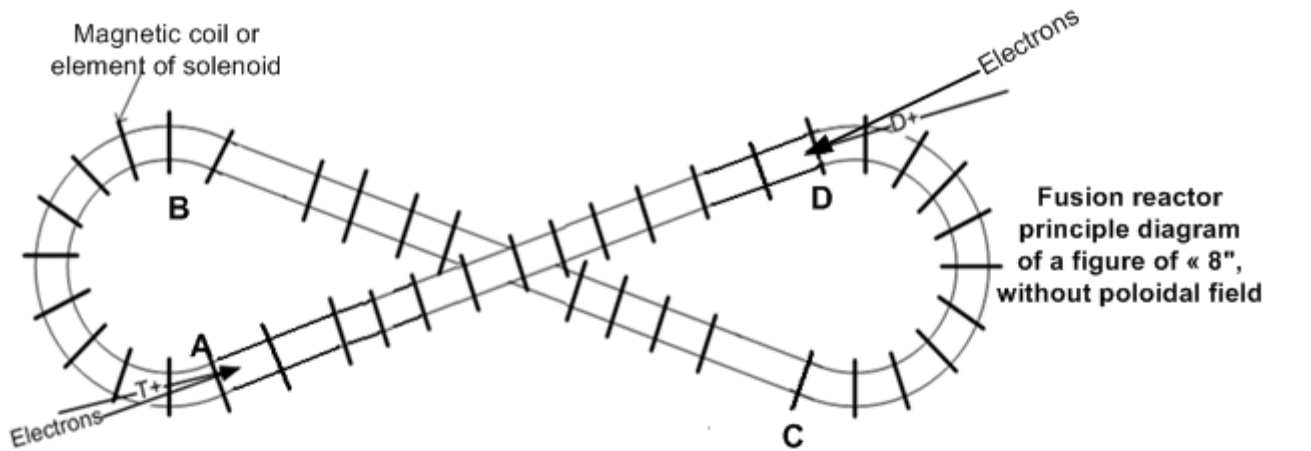

Figure 4 (radial drift on a figure of "8")

Below, for information (in [figure 5](#)) is given the theoretical evolution of the D+ and T+ trajectories (drifts), for not-thermalized ions. A, B, C and D are the positions on the figure of «8», at the interface between loops and straight pipes. It is reminded that this applies only in a case where no poloidal magnetic field is required, so for very small plasma density.



R is the radial position with R=0 on the figure of « 8 » axis, and R>0 if the trajectory is on the left of the axis for D+ or on the right of the axis for T+.

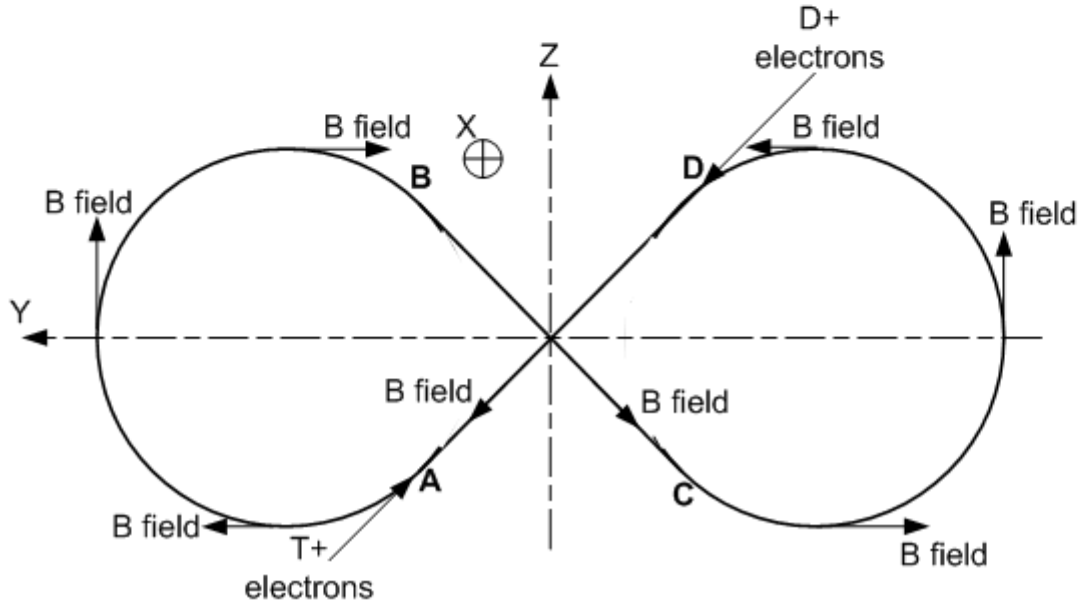

Figure 5

Note also that electrons circulate on both separated beams, independently of their initial direction. It will be considered that, statically, the electrons currents will be the same on the two separated

beams. So any ion will have to collide with as many frontal electrons as rearward ones (this is valid in all cases, i.e. with or without poloidal field).

5.2.4 Geometry of the figure of “8”

Below ([figure 6](#)) is the face view of an example of figure of “8”.

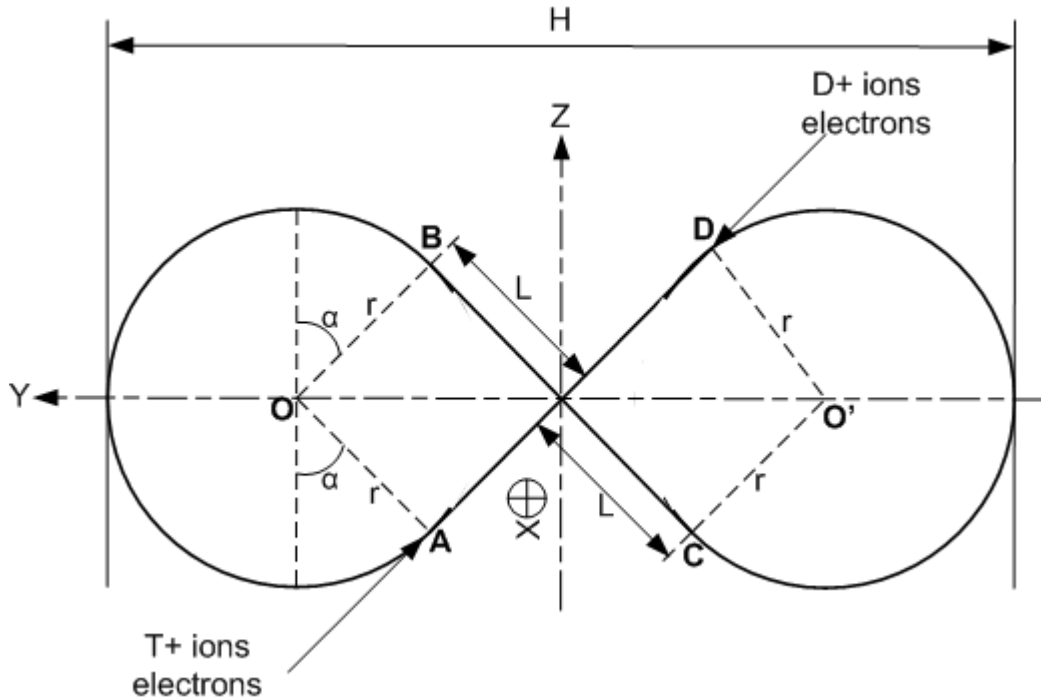

Figure 6 (example of figure of “8” on YZ)

The general shape of the figure of “8” is defined by λ (from $C = \lambda \cdot \pi \cdot r$, with C the circumference of a loop). In this example, $\lambda = 3/2$, $r = L$, $\alpha = 45^\circ$.

It must be also considered the ratio μ equal to “Straight length / Perimeter of the figure”. It is equal to 0.298 on the [figure 6](#). Because the sole pipe on which beams are superposed is the AD one, μ must be the highest possible so as to increase the straight pipe AD length relatively to the other parts of the figure.

From the [figure 6](#) and a bit of geometry, it can be shown that for an α angle (in rd) given:

- $L = \frac{r}{\tan \alpha}$, r being the radius of the two loops
- $P = r \times \left(\frac{4}{\tan \alpha} + 2 \times (\pi + 2 \times \alpha) \right)$, P being the figure of “8” perimeter
- $\mu = \frac{4 \times L}{P}$
- $H = 2 \times r \times \left(\frac{(\sin \alpha) + 1}{\sin \alpha} \right)$, H being the overall height of the reactor
- $\lambda = \frac{\pi + 2 \times \alpha}{\pi}$

If the ratio μ is known, then the α angle can be determined with the equation:

$$\tan \alpha \times (\pi + 2 \times \alpha) = \frac{2}{\mu} - 2$$

For example, given the ratio $\mu = 0.6$, using the last equation in a recursive loop (inside a program), we found that $\alpha = 0.3363$ rd (or 19.27°) and hence $\lambda = 1.214$.

The radius r must not be too small, due to the necessity to twist the pipe to form a “8”, one pipe passing over the other at the center of the figure of “8”. Now, let’s suppose that the pipe AD (length = $2 \times L$) is 10 m length. This will give, still for $\mu = 0.6$, $L = 5$ m, $r = 1.75$ m, $H = 14.1$ m and $P = 33.33$ m.

5.2.5 Usefulness of the figure of “8”

The working described above is ideal with a small density plasma ($<1E13$). Now once the plasma density is high, and the density used for fusion is relatively high ($n=5E19$, according to [§5.1](#)), the radial drift would be enormous (in km) and this solution would not be possible.

However, for tests at very low plasma density, so with low ions and electrons currents, the figure of “8” is the most simple. Now for real fusion densities, a poloidal magnetic field is necessary.

5.3 Fusion reactor (figure of “0”) using toroidal and poloidal magnetic fields

5.3.1 Working with a plasma density for fusion – Poloidal magnetic field

To solve the problem of important drift for high plasma density, it must be added a poloidal magnetic field by twisting several wire(s) around the loops, for example as shown on the plate 11-3 of reference [\[3\]](#). It exists different techniques to create this field externally (see [\[12\]](#)).

The calculation of the maximum shift with a poloidal magnetic field is shown in [Appendix C](#). It is obvious that, in that case, there is no more compensation between loops (and no need to). So a figure of “8” is useless and it is preferable to select a simple figure of “0” (“racetrack” layout Stellarator) to confine particles according to this principle, i.e. a toroidal and a poloidal magnetic fields. For a figure of “0”, look for example the one shown on the plate 11-5 of reference [\[3\]](#), which is abstracted in the [figure 1](#).

Moreover:

- It is easier (compared to a figure of “8”) and recommended to increase, the most possible, straight pipes relatively to loops on a figure of “0”, as it is reminded, first, that the fusion rate in the loops is inferior to the fusion rate in the straight lines (see [Appendix C](#)), and, secondly, the diffusion regime is certainly very unfavorable on loops compared to straight pipes (see [§5.4.6.3](#)).
- In a figure of “0” there is no to pipes to cross, so all pipes pertain to the same plane.

So from now, it will be supposed this simple layout ([figure 1](#)).

Note1: looking at the reference [\[3\]](#), it is clear that this initial model has evolved to prevent different problems (up to the “racetrack”). For example, it has been added stabilizing windings permitting to twist (for a poloidal field) but also to shear the magnetic lines of force, so as to inhibit the development of instabilities. The figure of “0” is implicitly supposed to be equipped to the different improvements, even if not described.

Note 2: the very complex but efficient magnetic field of a modern Stellarator layout (as for example the Wendelstein 7-X model) would be certainly optimum. However it is not the subject of this paper, which remains at level principles.

5.3.2 Geometry of the figure of “0”

Below ([figure 7](#)) is the face view of an example of figure of “0”.

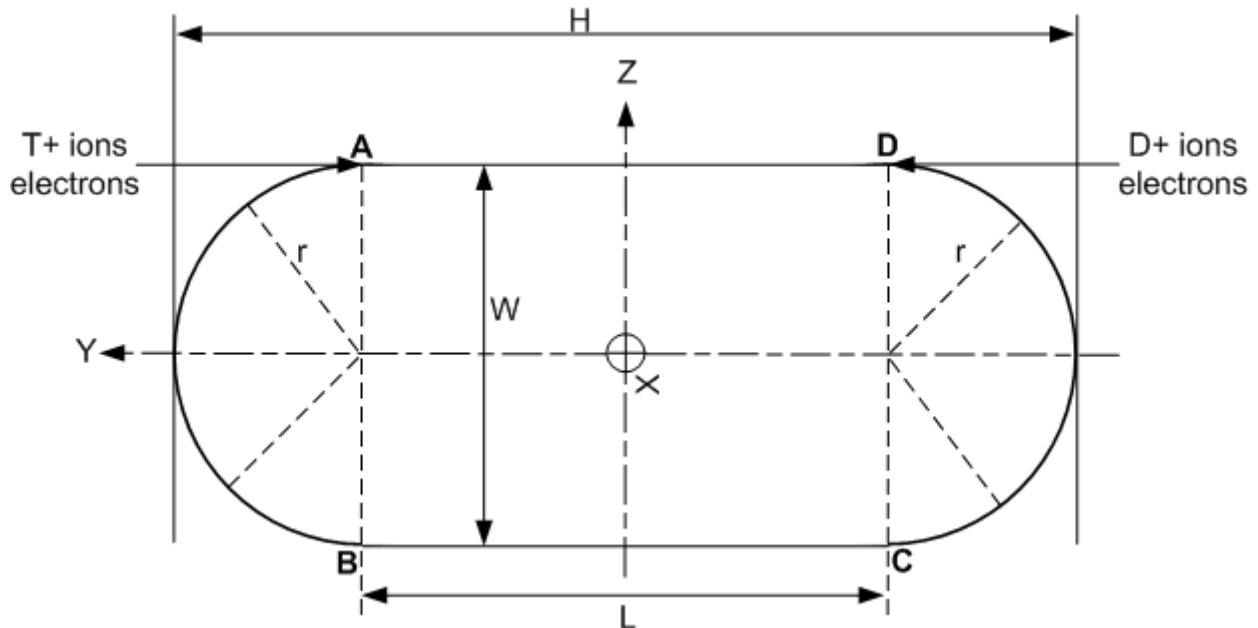

Figure 7 (example of figure of “0” on YZ)

Here C the circumference of a “loop” (left or right) is equal to $C = \pi \cdot r$.

As explained in the [Appendix C](#), μ (“Straight length / Perimeter of the figure”) must be the highest possible, so the figure of “0” must be elongated.

The ratio μ tends to 1, if H tends to infinity with a finite radius r .

From the [figure 7](#):

- $P = 2 \times (\pi \times r + L)$, P being the figure of “0” perimeter
- $\mu = \frac{2 \times L}{P}$
- $H = L + 2 \times r$, H being the overall height of the reactor
- $W = 2 \times r$, W being the reactor width

If the δc_{max} shift ([Appendix C](#)) is roughly independent of the radius r , it is not the case for the δb_{max} shift ([Appendix C](#)). The radius must not be too small relatively to the trapping condition, nor too large relatively to the δb_{max} magnitude.

For example, given the same ratio $\mu=0.6$ and the same radius $r=1.75$ m as for the figure of “8” ([§5.2.4](#)), using $L = \frac{\pi \times r \times \mu}{1 - \mu}$, it is found that $L=8.25$ m and $P=27.5$ m.

5.4 About the beam and the particle energies circulating in the figure of “0”

5.4.1 Generalities

Note: further, to avoid an ambiguity with the “+” ion sign of $D+$ and $T+$, “D” is worth for “D+” (examples: “mD” for “mD+” the $D+$ ion mass and “vD” for the $D+$ ions speed) and “T” for “T+”.

The preliminary values at equilibrium state ([§5.7.2](#)) of E_D , E_T and E_e are respectively equal to 54.2 keV, 81.2 keV ($E_T=1.5 \times E_D$, see [Appendix D](#)) and 65 keV ($1.2 \times E_D$, see [Appendix A part 2](#)).

As the $D+$ and $T+$ ions, after thermalization, collide in all directions and given that $V_D=V_T$ (see [Appendix D](#)), the mean relative energy between ions (called also “Center-of-mass energy” or E_{com}) is equal to 0.96 times the mean injection energy, so $E_{\text{com}}=65$ keV in the example.

Note that at these conditions the theoretical fusion cross section σ is maximum and equal to $5E-28 \text{ m}^2$.

5.4.2 Type of diffusion

Due to the high particles density of this plasma, it is considered that the particles diffusion is ambipolar (see criteria in [7] pages 195 and 196). In these conditions, inside the beam, ions and electrons movements are coupled by their attractive space charge called “ambipolar potential”. So there is no charges separation and the radial diffusion speed and flow of ions and electrons is the same. However, note that under the common axial magnetic field, the own radial diffusion coefficient (written D^\perp) of ions is much superior to the one of electrons by a factor equal to about $\sqrt{(m_i/m_e)}$ so around 68 (Reference [7] page 198).

To abstract the behavior of each particle:

- ions diffuse towards the wall due to collisions with the other ions (i.e. from high density plasma towards low density),
- electrons catch up ions through the ambipolar potential.

Now at wall level (i.e. very close to the inner surface of the pipe), the ions diffusion mode will be rather a “freefall” one, because ions individual movements due to collisions will not be caught up by electrons. So, there are two possibilities:

- Either the pipe wall is electrically conductor and connected to ground (0 V), so losses (in terms of radial flow towards the wall) of electrons and ions will be proportional to their radial diffusion coefficient D^\perp . In other words, electrons losses (about 1/68 of the ions losses) are negligible in front of ions losses and will not be considered to simplify.
- Or the pipe wall is electrically isolated (insulating or conductor matter not connected). In this case, the wall will impose an ambipolar regime, by elevating its floating potential and forming an electrons sheath layer. At equilibrium, the ions and electrons losses will be the same, i.e. the electrons losses will have increased and the ions losses decreased. Now the total particles losses in this regime will be, probably, comparable to the losses in the previous case.

From now on, it will be chosen the first configuration (pipe conductor connected to 0V) which corresponds to the simplest way for simulation (no ions or electrons sheath layer).

Notes:

- The potential at which the pipe conductor is submitted could be different from 0 V, but without being isolated. This one could be used as a possible control of the particles lost, and, consequently also, as a control of the electrons/ions densities. A positive potential will create an electrons sheath layer with more electrons lost than ions lost. Reversely, a negative potential will create an ions sheath layer with more ions lost than electrons lost.
- Collisions of ions (and Alpha particles) with the pipe wall can introduce impurities in the plasma, which must be limited to the minimum (see §5.4.3), however taking into account the reactor control necessity (§5.8 and §5.4.3.5).

5.4.3 Radiation losses and, particularly, the Bremsstrahlung effect

Radiations losses can be due to synchrotron radiated power (due to electrons turning in the loops), to cyclotronic radiated power (due to electrons turning on their orbits around axial magnetic lines), to Bremsstrahlung (braking radiation when electrons collide ions or matter) and to impurities.

5.4.3.1 About the synchrotron radiated power

The reference [8] gives the Larmor formula for this power: $P = \frac{q^2 \times a^2 \times \gamma^4}{6 \times \pi \times \epsilon \times c^3}$. So with the centrifugal acceleration $a = \frac{v^2}{R}$, a simple calculation with realistic pieces of data shows that this radiated power is negligible and will not be considered further.

For example, for an electron at 100 keV ($V=1.64E8$ m/s, $\gamma=1.2$) and $R=0.5$ m, the power lost is equal to $3.4 E-20$ W. All the electron energy would be lost in $4.7E5$ s. So this radiation will be neglected.

5.4.3.2 About the cyclotronic radiated power

The reference [10] page 21 gives the approximated following formula for electrons (with P in W/m^3):

$$P = \frac{ne \times q^4 \times B^2 \times vr^2}{6 \times \pi \times \epsilon \times me^2 \times c^3}$$

This formula comes from the Larmor formula taking into account the cyclotronic acceleration and neglecting relativity. The reference [10] proposes the simplified formula:

$$P = 6E - 17 \times ne \times B^2 \times Te \text{ (keV)}$$

With $Te=2/3 \times Ee$, it can be written $P = 4E - 17 \times ne \times B^2 \times Ee \text{ (keV)}$

Note that this power depends strongly on the magnetic field (B^2). Let's suppose electrons at $Ee=65$ keV, a density $ne=5E19$, a magnetic field of 5 T. This gives a cyclotronic radiated power of $3.25 E6$ W/m^3 whereas the Bremsstrahlung power is only equal to 11100 W/m^3 . However, as the cyclotronic frequency is the same for all electrons, they are all, as "receivers" for each other, in cyclotronic resonance. Consequently, the radiated power emitted by one electron is absorbed by the other electrons. According to reference [10], the absorption is much better than 99% for tokamaks. So it will be made the penalizing hypothesis that 1% of the cyclotronic radiation is lost. The applicable formula for the cyclotronic power lost by m^3 (P_{cym3}) will be:

$$P_{cym3} = 4E - 19 \times ne \times B^2 \times Ee \text{ (keV).,}$$

It must be noted that ions, due to their weight, produce negligible cyclotronic radiated power. Because they are not resonant relatively to the electrons cyclotronic frequency and because they are not able to follow the electric field of the radiated waves (the natural ions frequency being much lower than the electrons cyclotronic frequency), they don't absorb the power radiated by electrons.

5.4.3.3 About the Bremsstrahlung

The reference [1] gives on page 23, a formula (2.25) to estimate the Bremsstrahlung loss in W/cm^3 (P_{brm3}) which depends on ne , Te and a coefficient Z_{eff} equal to 1 for the D/T fusion. It seems to be a more precise extension of the reference [9] formula:

$$P_{Brm3} = 1.691E - 38 \times ne^2 \times \sqrt{Te} \times K_{eff} \text{ with } P_{brm3} \text{ in } W/m^3, ne \text{ in electrons}/m^3, Te \text{ in eV}$$

($Te = 2/3 \times Ee$ (eV)) and $K_{eff} = 1$ for the D/T fusion.

The power lost by Bremsstrahlung is also given by the formula 2.5 of the reference [10]. The result of this formula is coherent with the formula of the reference [1] for D/T fuel.

The formula of reference [1] will be chosen from now on, for all fusions.

Note that for certain fusions reactions (as p/B11), the Bremsstrahlung is the main source of losses.

5.4.3.4 Radiation losses due to impurities

Now, it might be taken into account impurities, mainly due to sputtering of wall by ions of the plasma ($D+$, $T+$, $He4+$...). Due to their height Z number and due to bound electrons on these impurities, they increase the Bremsstrahlung effect and induce a particular "lines radiation" (see [10] page 21 and 22). The impact could be very strong (see [10] page 22). Some device will have to clear the plasma from them (Divertor or equivalent). This function is beyond the subject of this article. However, it cannot be supposed a total absence of impurities. It will be supposed, as an hypothesis, that the losses on impurities (called P_{imm3}) are equal to the Bremsstrahlung losses ($P_{imm3}=P_{brm3}$), which supposes, however, a very low density of impurities.

5.4.3.5 Control of the radiations power

Even it seems counterproductive at first glance, it can be of big interest to control the radiations power and, possibly, to increase the radiations power. Indeed, it's a way to control the equilibrium energy (Ei_{equi}). A too much elevated one would lead to a slight mechanical drop, an increase of the shift in the loops (see [Appendix C](#)) and a certain instability. By increasing the radiations power, the equilibrium power could be adjusted around the ideal level (close to 68 keV, and preferably a bit above, cf. [§5.8](#)). For example, in

[§6.2.2.2](#), 10 % more radiations power permits to stabilize the equilibrium energy down to a reasonable value (≤ 93 keV), the working being stable.

Another example is given by the simulation presented in [§6.2.2.3](#): it is supposed that the radiations power has been multiplied by 2 (for example by injecting impurities). It can be observed that the mechanical gain obtained is higher than the one obtained in the nominal conditions ([§6.2.2.2](#)). Without this control, the equilibrium energy would have been extremely elevated ($\gg 93$ keV) and the working instable.

5.4.4 About the neutralization of the ions beam by electrons

To create a neutralized beam the density of electrons n_e must be equal to the density of ions n_i . Moreover, it can be demonstrated that the fusion power, which is proportional to $n_D \times n_T$ (with n_D the density of D+ ions and n_T the density of T+ ions), is maximum if $n_D = n_T$. Consequently we must have $n_D = n_T = n_i / 2$ ($= n_e / 2$).

However, the densities are not directly controlled. Only the currents of electrons and ions are controlled. It is supposed that electrons and ions are injected at a precise energy magnitude.

The general equation for the current I is the following: $I = n \times q \times v \times S$, with n the density, q the charge (1.6 E-19 C), v the particle speed and S the beam section area (common to electrons and ions).

So for electrons $I_e = n_e \times q \times v_e \times S$, for D+ ions $I_D = \frac{n_e}{2} \times q \times v_D \times S$ and for T+ ions $I_T = \frac{n_e}{2} \times q \times v_T \times S$ with $v_T = v_D$ so $I_D = I_T$.

By hypothesis, the injection of replacement ions is made on a section S of diameter equal to 1 cm, so $S = 0.78 \text{ cm}^2$ (not critical). In permanent working (at plasma equilibrium), the goal is to have the highest confinement time ([§5.4.6.3](#)). So, the ions density will decrease from the center (where injection is made) to the wall. Note that half of the plasma particles is concentrated at the center, in 30 % of the pipe section (see [§5.4.7](#)).

Note that the ratio between I_e and I_i (total ions current) is equal to:

$$\frac{I_e}{(I_D + I_T)} = \frac{2 \times v_e}{(v_T + v_D)} = \frac{v_e}{v_D}$$
 For example, in the injection conditions of [§5.7.2](#), $v_D = 1.61 \text{ E6 m/s}$ (at 27.1 keV) and $v_e = 1.02 \text{ E8 m/s}$ (at 32.5 keV), this ratio is equal to 63.4 ($I_e = 63.4 I_i$).

5.4.5 About the expected fusion power and necessary currents

In parallel, it will be given an example so to have an idea of the orders of magnitude of parameters.

5.4.5.1 Fusion power

An ion has a certain probability to fuse with another ion in a collision (D+/T+). Let's calculate the mean fusion power P_f supplied by an ion.

The fusion frequency γf for an ion (let's suppose D+) fusing with another ion (T+) is equal to:

$$\gamma f = n_T \times \langle \sigma v \rangle$$

So the fusion power P_f (in W) can be written as

$$P_f = E_f \times n_D \times \gamma f \times V = E_f \times n_D \times n_T \times \langle \sigma v \rangle \times V$$

With:

- E_f the energy per D+/T+ fusion in J, i.e. 14.1 MeV (neutrons) + 3.5 MeV (He4) = 17.6 MeV. To this one, the kinetic energies of the ions (D+/T+) just before their fusion, must normally be added. They will be neglected here.
- $n_D = n_T = n_i / 2$ ($= n_e / 2$) so $n_D \times n_T = n_i^2 / 4$
- $\langle \sigma v \rangle$ is the fusion reaction rate which can be put in the simplified and optimistic form: $\langle \sigma \rangle \times \langle v \rangle$. Here we will suppose that $\langle \sigma \rangle$ the mean fusion cross section is ideal and equal to 5 E-28 m^2 for a center-of-mass energy (E_{com}) of 65 keV (as proposed in [§5.7.2](#)). So, for central fusions (frontal fusions are neglected), E_D at equilibrium = 54.2 keV and E_T mean = 81.2 keV (so $v_D = v_T = 2.277 \text{ E6}$

m/s). v is the relative speed between D^+ and T^+ . $\langle v \rangle$ can be determined as $\langle v \rangle (\text{m/s}) = 13835 \times \sqrt{ED}$ (with ED in eV), so here $\langle v \rangle = 3.22 \text{ E}6 \text{ m/s}$.

Note that for thermalized ions: the best condition for $\langle \sigma v \rangle$ could be such that it does not correspond to $E_{com} = 65 \text{ keV}$. It can be slightly different, according to the variation of σ with E_{com} and to the Maxwell-Boltzmann distribution of ions speeds. This possible difference will be neglected here.

However, it is necessary to apply a certain coefficient to have a more realistic value of $\langle \sigma v \rangle$.

Experimentally, around $E_{i_equi} = 67.7 \text{ keV}$ (so around $E_{com} = 65 \text{ keV}$), it can be written:

$\langle \sigma v \rangle \approx 0.73 \times \langle \sigma \rangle \times \langle v \rangle = 10100 \times \langle \sigma \rangle \times \sqrt{ED}$ (with ED in eV)

This gives a preliminary value of $1.18 \text{ E}^{-21} \text{ m}^3/\text{s}$ for the best $\langle \sigma v \rangle$.

- V is the fusion beam volume, i.e. $V = L_f \times S$, with L_f the equivalent length for fusion (with $L_f = 0.8 \times P$, see [Appendix C](#)). From the example of figure of "0" in [§5.3.2](#), let's suppose that $L_f = 22 \text{ m}$ (for a perimeter P of 27.5 m). The beam radius is supposed equal to 0.19 m , so S (beam section area) $= 0.113 \text{ m}^2$ and $V = 2.50 \text{ m}^3$.

$$\text{So } Pf(W) = \frac{Ef(J) \times ni^2 \times \langle \sigma v \rangle \times L_f \times S}{4}$$

Note that D/D and T/T fusions are neglected in front of D/T fusions.

5.4.5.2 Necessary currents

The goal is to obtain a sufficient beam density. As explained in [§5.1](#), $ni = ne$ is limited to $5 \text{ E}19$.

So $nD = nT = 2.5 \text{ E}19$.

In our example, the fusion power P_f would be equal to $1.44 \text{ E}6 \text{ W}$ (1.44 MW).

The electrons current would be equal to, in these conditions ($ne = 5 \text{ E}19$), in our example ([§5.7.2](#)):

$I_e = ne \times q \times v_e \times S = 1.26 \text{ E}8 \text{ A}$ (so an ions current in the beam of about $1.98 \text{ E}6 \text{ A}$).

It can be observed that electrons and ions intensities inside the beam will be necessarily very high.

5.4.5.3 Density of fusion power

It is interesting, at this level, to estimate the mean density of fusion power (P_{fm3}) in W/m^3 :

$P_{fm3} = P_f / V = P_f / (P \cdot S)$ with P the perimeter and S the beam section area.

So $P_{fm3} = \frac{Ef \times ni^2 \times \langle \sigma v \rangle \times L_f}{4 \times P}$ with Ef in J equal to $17.6 \text{ E}6 \times q$.

$\langle \sigma v \rangle \approx 10100 \times \langle \sigma \rangle \times \sqrt{ED_{equi}}$ (cf. [§5.4.5.1](#)) with ED_{equi} the mean value of ED at equilibrium.

$$\text{So } P_{fm3} \left(\frac{W}{m^3} \right) = \frac{2525 \times Ef(J) \times ni^2 \times \langle \sigma \rangle \times ED_{equi} (eV)^{0.5} \times L_f}{P}$$

Note that between 40 and 65 keV of E_{com} energy, interval of interest for this reactor, the fusion cross section is almost linear and σ could be written as: $\sigma (\text{m}^2) = 7.6 \text{ E}^{-33} \times ED (\text{eV})$

So a simplified formula is: $P_{fm3} \left(\frac{W}{m^3} \right) = \frac{Ef(J) \times ni^2 \times 1.92 \text{ E}^{-29} \times ED (eV)^{1.5} \times L_f}{P}$

It is clear that increasing ni or ED_{equi} (from an energy $< 54.2 \text{ keV}$) increases rapidly the density of fusion power.

5.4.5.4 Plasma concentration

It must be noted that, in the previous formulas, it is supposed a flat ions density ni in any section, so ni represents the mean ni (with $ni = 5 \text{ E}19$ aimed). In fact, the plasma is concentrated in the center, so the plasma density decreases, more or less rapidly, from the center to the pipe wall.

As P_{fm3} depends on ni^2 and not on ni , it would be normally necessary to correct ni^2 with a factor $\lambda_m(t)$ to take into account this concentration, so as to replace ni^2 by $ni^2 \times \lambda_m(t)$.

$\lambda_m(t)$ could be expressed by:
$$\lambda_m(t) = \frac{\int_0^{r_p} n_i(r,t)^2 \times 2 \times \pi \times r \times dr}{\pi \times r_p^2}$$

With t the time from the reactor start up, r the radius considered, r_p the interior pipe radius and $n_i(r,t)$ the ions density at r and t . Of course, there is no simple way to estimate $n_i(r,t)$.

However, the simulations show that, at equilibrium, the λ_m factor is equal to about 1.27.

Note that the factor λ_m applies to the Bremsstrahlung cooling because it also depends on n_i^2 .

However, for about the density of power fusion calculation, we will neglect this factor λ_m . Note that λ_m is displayed by the simulator Multiplasma for information.

5.4.6 About the beam formation and confinement time

5.4.6.1 Problem of the axial space charge of an injected beam

As it is not possible to directly inject such very high electrons/ions current, the way to do is to “slowly” inject electrons and ions in the loop. Of course the ratio between electrons and ions intensity will be kept constant so as to keep the neutrality of the beam (i.e. the ionic charge injected being equal to the electronic charge).

However, between the ions/electrons sources and the neutral beam, during the transportation, the particles will be submitted to their space charge on a small length. Probably, the neutralization of ions by electrons will be very fast with only a small effect, but it is difficult, a priori, to be sure.

The space charge has not only a radial effect but also an axial effect (i.e. on the direction of the beam). So, a high current of particles could be strongly slowed down. Due to their very high speed, electrons are very little subject to this problem (the induced potential is weak). Reversely, for ions it is more problematic due to the relatively low ions speed.

There are two solutions to reduce the ions axial space charge (i.e. the potential induced by the injected ions themselves):

- either the distance L , before reaching the neutral beam or simply neutralizing ions by injected electrons, is small (several mm maximum),
- or the beam diameter is large compared to the distance L .
The filling ions (and electrons) could be injected inside a beam of diameter equal, for example, to the interior pipe radius.

5.4.6.2 Filling of the reactor

From now on, it will be supposed that the transport of ions between the ions source and the neutral beam is made without too much loss (in terms of energy and particles).

The filling must be done in 0.3 s maximum, i.e. in a time very inferior to the confinement time. As written above, the filling ions (and electrons) can be injected inside a large beam, so as to limit the axial space charge. But the filling beam must not be too large, so as to limit particles losses during the filling. For example, the Multiplasma simulator fills the reactor in 0.3 s with a beam which diameter is equal to the interior pipe radius.

Note that, afterwards in the permanent working, electrons and ions currents must be sufficient to replace the particles lost, included the ions fused, so as to keep the beam neutral. Normally, there will be much more ions to replace than electrons to replace (see [§5.4.2](#)). The replacement particles must be injected in a narrow beam (1 cm diameter as a first hypothesis) at the center of the pipe, so as to have the maximum confinement time.

The ions source extracted power (V beam \times I beam) can be relatively elevated to fill the reactor in 0.3 s maximum. For example, the JET Tokamak has sources of 8 MW. These big ions sources have a very good efficiency (>0.9). The injection diameter is around 1.2 cm.

The D+ (T+) ions source will be such to minimize the D2+/D3+ (T2+/T3+) ions compared to the D+ (T+) ions. This because after quick dissociation ($D2^+ \rightarrow D^+ + D$, for example), the kinetic energy given to the D or T atoms or to the D2 or T2 molecules will be lost. From now on, it will be considered that the loss of energy due to D2+/T2+/T2+/T3+ is negligible.

Let's calculate the electrons charge Q_e when the figure of "0" is filled at the nominal electrons current (so as to have the nominal density n_e):

$Q_e = q \times n_e \times V = q \times n_e \times P \times S$, with P the perimeter of the figure of "0", equal to 27.5 m in our example and S the interior pipe section. Of course, $Q_i = Q_e$ for neutrality.

To introduce a charge Q_e with a current I_{ef} , this one must be established during Δt (s), time to determine: $Q_e = I_{ef} \times \Delta t$ so $\Delta t = Q_e / I_{ef} = q \times n_e \times P \times S / I_{ef}$.

For example, using the data proposed in [§5.7.2](#), let's suppose that we dispose of ions and electrons sources able to inject 45 A of ions at 27.1 keV for D+, 45 A at 40.6 keV for T+ and 2 x 45 A of electrons at 32.5 keV. It is reminded that 2 ions sources and 2 electrons sources are used as shown in the [figure 1](#). The total injection power ($= \sum U \cdot I$) is equal to 6.0 MW.

Now, supposing an interior pipe radius of 0.19 m, for electrons or ions, $\Delta t = 0.28$ s.

So in $\Delta t = 0.28$ s, the electrons and ions currents will have filled the figure of "0". It is supposed that the confinement time (C_t) is much superior to Δt (let's say ≥ 1 s), so as to neglect the ions losses.

It can also be interesting to determine the electric energy necessary to charge the reactor (W_{le}) which is equal to $W_{le} = \frac{(Q_e \times U_e) + (Q_i \times U_{imean})}{\eta_i}$, with $Q_e = I_e \times \Delta t$ (and $Q_i = Q_e$). U_e is the acceleration voltage of the injector, numerically equal, here (i.e. for one charge/particle), to the electron energy in eV.

U_{imean} is the mean acceleration voltage between D+ and T+: $U_{imean} = (U_D + U_T)/2$, equal to the mean ions energy numerically. The efficiency η_i for the particle injectors is supposed equal to 0.8.

In our example, we have $W_{le} = 1.66$ MJ.

5.4.6.3 Confinement time

The closest reference for the confinement time is the Tokamak. Experimentally it varies from 0.005 s on the first Tokamaks up to 20 s on the KSTAR reactor. The mean interval for modern Tokamaks is between 1 to 3 s.

The confinement time here is related to the mean time, for a particle, from its injection to its loss on the wall, through diffusion due to Coulombian collisions between ions. The particles diffusion across the magnetic lines leads to slowly enlarge the beam, up to the wall.

In this reactor ([figure 1](#)), as the beams are injected in the center of the pipe, a particle, before being lost, must diffuse from the center towards the wall (the diffusion being the biggest source of losses). This process is relatively long, depending on the wall radius. The confinement time of this reactor is, according to simulations, similar to the Tokamak one (but with smaller radiuses). Tests on the Multiplasma simulator have been conducted (taking into account diamagnetism). It has been considered the neutral beam in the straight pipes (AD or BC on [figure 6](#)), where D+ and T+ beams are perfectly superposed.

An initial radial speed has been introduced through the maximum angle for injection. This one has been taken equal to 0.08 Rad (4.58°). It is not critical, but the less elevated it is, the less the beam carries initial radial energy, which is positive for the first frontal fusions.

The author has determined, after a certain number of simulations, an experimental formula, for about the confinement time (C_t) in s:

$$C_t = 1.29 \times \left(\frac{R_p}{0.15}\right)^{2.27} \times \left(\frac{B}{5}\right)^2 \times \left(\frac{E_i}{70000}\right)^{0.72} \times \left(\frac{n_i}{5E19}\right)^{-1.16}$$

With C_t in s, E_i the ions mean energy in eV, B the magnetic field in T, R_p the interior pipe radius in m, n_i in ions/m³. Note that this formula has been determined for B between 1.4 and 5 T, R_p between 15 and 40 cm, E_i from 17.5 to 70 keV and n_i from 2.5E19 to 1E20 ions/m³. It is a rough formula but sufficient for an estimation. For example, for the conditions B=5 T, $R_p=0.19$ m, $E_i=67700$ eV, $n_i=5E19$, C_t is equal to 2.15 s.

It is clear that to increase Ct , B and R_p must be the highest possible (E_i and n_i are more or less fixed). A magnetic field of 5 T (or more) is here compulsory for a small radius of about 0.19 m, to limit diffusion. It is also clear that a large pipe radius limits the diffusion losses and so increases the confinement time, but this radius is also determined by the Alphas heating ([§5.4.7](#) and [§5.7.3](#)).

This formula about Ct is probably optimistic, for two reasons:

- due to a very big time amplification factor ($\times 10000$) for simulations, the ions diffusion is minimized by at least 30 %,
- in the loops, the transport regime is not certainly a classical ambipolar one (Braginsky) with the transport factor $D^\perp \sim 1/(B^2 \times E_i)$, which approximately corresponds to the formula above. It must rather be a non-linear diffusion linked to turbulences (Bohm) with $D^\perp \sim E_i/B$, which is very different and unfavorable. However, it can be thought that in the straight pipes (which are privileged for this type of reactor), the diffusion is close to the classical one as there are much less turbulences.

However, even if the mean confinement time is lower than expected in the formula above, the principle of this reactor is not affected, as it is enough to increase the pipe radius, so as to come back to a lower value of the confinement time.

Test at $B=1.4$ T

In this document, the magnetic field is supposed equal to 5 T which strongly minimize the losses. It would be interesting to make a test of sensibility, by increasing the losses rate by around 10. In other words, to divide the confinement time by 10. One solution is to replace the magnetic field of 5 T by a field of 1.4 T, this because the reduction factor on Ct will be equal to $(5/1.4)^2=12.8$. This case corresponds, in fact, to a toroidal magnetic field produced by the best permanent magnets (1.4 T). In this case, the Alpha heating ([§5.4.7](#)) is also reduced. The only way to compensate this drawback is to increase the pipe radius. This configuration is simulated in [§6.2.2.4](#). The Beta factor will have to be estimated.

5.4.6.4 Estimation of the density of power lost by ions due to diffusion

From the knowledge of the confinement time Ct ([§5.4.6.3](#)), it is possible to evaluate the density of power lost by ions due to diffusion (P_{dm3}) in W/m^3 , as: $P_{dm3} = n_i \times E_i(J) \times \gamma d$ or $P_{dm3} = n_i \times E_i(eV) \times q \times \gamma d$
 γd the loss by diffusion frequency is equal to $1/Ct$ so $P_{dm3} = \frac{n_i \times E_i(eV) \times q}{Ct}$

5.4.7 About the Alphas heating

It is reminded the D/T fusion: $D+ + T+ \rightarrow He4+ (+3.5 \text{ MeV}) + n (+14.1 \text{ MeV})$

The He4 nucleus, composed of 2 neutrons and 2 protons (so $Z=2$), is also called an "Alpha" particle.

The maximum Larmor radius R_l , when the He4 trajectory is purely radial, for this Alpha at 3.5 MeV is equal to $R_l (m) = 0.541 / B(T)$. For an axial trajectory, R_l is equal to 0.

So according to the magnetic field chosen ($B=5$ T a priori), the Larmor radius R_l compared to the pipe radius can be such that a given part of the Alpha particles (also called "Alphas") will remain in the pipe, confined by the magnetic field and the other part will collide the pipe wall.

So the part of Alpha particles remaining in the pipe (ratio called " λ_a ") will depend on the pipe diameter and on the B field. This part will be reduced for a small pipe diameter (8 cm for example) or a small B (1 T for example).

It has been, first, determined by simulation that the "mean beam radius/pipe radius" ratio is equal to about 0.55 at equilibrium. Note that it means that half of the plasma particles are concentrated at the center, in 30 % of the pipe section. The other half is located in the periphery of the pipe, so in 70 % of the pipe section. Note that this difference of density means that 70% of the fusions occur at the center of the pipe (i.e. 30% of the section).

It is supposed that a mean Alpha is created at $0.55 R_p$ and is lost if it reaches R_p , with R_p the interior pipe radius. It is also supposed that the Alphas trajectories are not modified by collisions with electrons and ions.

So from any Rp and B values, it can be determined the probabilistic value of λ_a , for a straight pipe. For information, this λ_a follows the following experimental formula:

$\lambda_a = 0.118 \times [10 - 1.6 \times (B \times R_p)^2] \times B \times R_p$, with Rp between 0.04 to 0.25 m and B between 1 and 5 T. Of course, the physical range of λ_a is between 0 and 1.

Let's consider, as a first hypothesis, that $\lambda_a=0.8$, for an example.

Inside the beam, Alpha particles will lost their kinetic energy (3.5 MeV + the initial energy of two neutrons and two neutrons), first mainly with electrons and at the end mainly with ions down to the plasma energy. This process lasts about 0.25 s in the conditions of a Tokamak, and longer in this reactor. So it comes to heat the plasma. For a sole mean Alpha particle, it will be brought an energy (E_a) equal to 3.5 MeV $\times \lambda_a=2.8$ MeV (=4.5 E-13 J) to the plasma. The reminder 3.5 MeV $\times (1- \lambda_a)=0.7$ MeV will be considered lost on the pipe wall or inside the Divertor.

The Alphas heating density of power (P_{am3}) can be written similarly to the P_{fm3} formula (see [§5.4.5.3](#)), replacing E_f by E_a .

$$P_{am3}\left(\frac{W}{m^3}\right) = \frac{2525 \times E_a(J) \times n_i^2 \times \langle \sigma \rangle \times ED (eV)^{0.5} \times Lf}{P} \quad (\text{with } E_a(J)=3.5E6 \times q \times \lambda_a)$$

This strong heating will compensate the losses (radiations...) and so will permit to maintain the ideal conditions for D/T fusion, i.e. an energy E_{com} equal to 65 keV.

It must be noted that Alpha particles once cooled (i.e. in thermal equilibrium with the plasma) are useless, as they are just "fusion ash" for the plasma. Some device will have to clear the plasma from them (Divertor or equivalent). This function is beyond the subject of this article.

5.5 About the pipe sizing

About the pipe sizing, there are two parameters to take into account:

- the radial shift on each loop (inferior and superior) which tends to spread the ions (see [Appendix C](#)),
- the Alphas heating targeted.

5.5.1 About the radial shift

For about the two loops, as described in [Appendix C](#), it will be generated a shift called " δm " on the beam radius.

If the toroidal magnetic field B is too low, δm is large and the pipe diameter must also be large which is problematic relatively to the magnetic equipment which must also be large. So this also justifies the choice of a magnetic field of 5 T, value which limits the maximum δm to about 6 mm for D+ and 10 mm for T+. Shift on electrons is negligible. However the shift on Alpha particles is equal to 32 mm. As the maximum shift, it is selected for the pipe sizing.

5.5.2 About the Alphas heating

In [§5.4.7](#), we saw that for a targeted λ_a ratio (necessary to bring the optimum Alphas heating), a certain pipe radius Rp is required. In [§6.2.2.2](#), the main simulation uses $R_p=0.19$ m, corresponding to λ_a equal to 0.895. It will be our hypothesis.

Moreover, it is taken the simplifying hypothesis that this factor λ_a does not depend on the pipe location, i.e. loops or straight pipes (AD and BC on the [figure 1](#)). It is the basic data for the pipe sizing.

5.5.3 Final pipe sizing

On the AD and BC straight branches, the pipe radius Rp must be equal to 190 mm with our hypothesis. On the loops, the pipe radius Rp must be equal to 190 mm plus the maximum shift (32 mm), so a rough value of 230 mm, with some margin.

Note that, due to the magnetic twist, the plasma is not circular in the loops (see [\[12\]](#)). So, it might also be taken into account the real section of the plasma.

5.6 About collisions with neutrals

5.6.1 Gas pressure

The gas pressure (D2) must be the weakest possible. It is just an inconvenience because the targeted fusions are only the ones between ions nucleus, but, in no way, the ones between ion nucleus and neutral nucleus.

However, it must be considered a certain pressure. It is good to have some values in mind (not guaranteed...):

- 10 pPa is the minimum value of pressure obtained in laboratory. It is also the pressure at an altitude of 10000 km,
- 1 nPa is the minimum obtained industrially,
- 10 nPa is the vacuum obtained in the particles accelerators and on tokamaks. It is also the pressure at an altitude of 1000 km,
- below 100 nPa is the Ultra High Vacuum domain,
- 10 μ Pa is the vacuum obtained relatively easily with a turbo-molecular pump. It is also the pressure at an altitude of 400 km.

Note: in this document and in the simulations, it is supposed, that the dynamics of ionization ([§3](#)) and charge exchange ([§5.6.3.1](#)) are such that the slow ions created by these interactions are lost.

5.6.2 Energy losses induced by the D2 gas

It is expected a degradation of the reactor performance due mainly to the ions-neutrals charge exchanges but, also at several orders lower, to ions-neutrals elastic collisions, ionizations, etc.

Charge-exchange interactions are widely the worst problem, because:

- the charge exchange cross section is very large compared to the Coulomb collisions one,
- all the ion kinetic energy is lost for the benefit of an atom which kinetic energy is also lost and supposed unrecoverable.

This loss of energy will be taken into account in the energies balance. The other interactions with neutrals are neglected.

This degradation will be estimated by calculation and then by simulation.

No electrons energy losses on gas are considered, because the cross-sections of free electrons interactions with neutrals are weak. Ionization of the D2 molecules by electrons is neglected.

5.6.3 Estimation of the mean power lost by ions due to the charge exchange interactions

5.6.3.1 Interaction

The charge exchange interaction taken into account is given here: $\underline{D^+} + D_2 \rightarrow D_2^+ + \underline{D}$

Note that a symbol underlined means "with energy", and if not underlined it means "almost without any energy (almost stopped)".

Finally, a fast D⁺ is "transformed" in a very slow D₂⁺, after an exchange of charge.

The behavior is supposed the same between T⁺ and D₂.

The new neutral (D) is obviously lost (i.e. it leaves the neutral beam). For the former neutral (D₂) become

ion (D2+), it is uncertain as it depends on the dynamic of the interaction. If it remains on the plasma, this D2+ ion will quickly be collided by other ions and dissociated: $D2^+ \rightarrow D^+ + D$. The D atom will be lost with its negligible kinetic energy and the D+ ion will be heated (indirectly by Alpha particles) and thermalized by the other ions. Independently of their future (escaping the beam or not), the result is the same: a loss of energy. In the other hand, if it is replaced by a new ion, the loss of energy will be much superior because the new ion must be injected and it costs 3.5 times more energy (for the 3.5 ratio, see §6.1.3) than a simple heating. In this document and in the Multiplasma simulator, it will be supposed, as a probably penalizing hypothesis, that these slow ions escape the beam, and so they must be replaced by new ions.

Note that another gas than D2 could be selected, H2 for example, to decrease the charge exchanges rate. However, the H+ ions are without interest. So, it will be better to remain with D2 or perhaps, with a gas mixture of D2 and T2.

5.6.3.2 Charge exchange power lost

The charge exchange frequency γ_{ce} for an ion circulating at V_i in a D2 gas having a density n_{D2} , the interaction cross section being σ_{ce} , is equal to $\gamma_{ce} = n_{D2} \times \sigma_{ce} \times V_i$. This interaction applies all along the figure of "0". The mean ions speed V_i is equal to $(V_D + V_T)/2$. Due to our hypothesis about the D+ and the T+ ions energy ($E_T = 3/2 \times E_D$, see Appendix D), it comes: $V_i = V_D = V_T$ (V_D being the D+ ion speed in m/s).

The charge exchange cross section σ_{ce} depends on the ions energy. This one is very large, for example $1.79E-20 \text{ m}^2$ at $E_i = 40 \text{ keV}$.

The density of D2 molecules at 293.15 °K (20°C) can be summarized by the following formula: $n_{D2} = 2.471E20 \times P_r$, P_r being the gas pressure in Pa (Pascal).

$$\text{So } \gamma_{ce} = 2.471E20 \times P_r \times \sigma_{ce} \times V_D$$

The mean power (W) lost by an ion (P_{ce}) due to charge exchanges is equal to $P_{ce} = E_i \times \gamma_{ce} = 2.471E20 \times E_i \times P_r \times \sigma_{ce} \times V_D$ with E_i the mean ions energy in J. Note that $E_i = (E_D + E_T) / 2$, so $E_i = 1.25 \times E_D$. Note also that $E_i(\text{J}) = E_i(\text{eV}) \times q = 1.25 \times E_D(\text{eV}) \times q$

In our zone of ions energy (between 30 to 80 keV), $\sigma_{ce} \approx 1.79 \text{ E-}20 \times (40000 / E_i(\text{eV}))$

$$\text{Or } \sigma_{ce} \approx 1.43 \text{ E-}20 \times (40000 / E_D(\text{eV})) \text{ and } V_D = \sqrt{\frac{2 \times q \times E_D(\text{eV})}{m_D}}$$

Consequently:

$$P_{ce} (W) \approx 2.471E20 \times 1.25 \times E_D(\text{eV}) \times q \times P_r \times 1.43E-20 \times \frac{40000}{E_D(\text{eV})} \times \sqrt{\frac{2 \times q \times E_D(\text{eV})}{m_D}}$$

$$\text{So } P_{ce} (W) \approx 2.77E-10 \times P_r (Pa) \times \sqrt{E_D(\text{eV})}$$

The mean power per m^3 of plasma (P_{cem3}) in W/m^3 is equal to:

$$P_{cem3} \left(\frac{W}{m^3}\right) = P_{ce} \times (n_D + n_T) = P_{ce} \times n_i = 2.77E-10 \times P_r (Pa) \times \sqrt{E_D(\text{eV})} \times n_i$$

with n_i the density of ions (i.e. per m^3 of plasma).

5.6.3.3 Estimation of the ratio between fusion and charge exchange powers

We know from §5.4.5.3 that the density of fusion power P_{fm3} is equal to:

$$P_{fm3} \left(\frac{W}{m^3}\right) = \frac{E_f(\text{J}) \times n_i^2 \times 1.92E-29 \times E_D(\text{eV})^{1.5} \times L_f}{P}$$

The goal would be that the mean energy lost by charge exchanges be very inferior to the fusion power. Let's defined the ratio $R_{fec} = P_{fm3}/P_{cem3}$ which might be superior to 100 to make negligible the energy loss on gas.

$$R_{fec} = \frac{E_f(J) \times n_i^2 \times 1.92E - 29 \times ED (eV)^{1.5} \times L_f}{2.77E - 10 \times Pr(Pa) \times \sqrt{ED(eV)} \times n_i \times P}$$

$$R_{fec} = 6.93E - 20 \times \frac{E_f(J) \times n_i \times ED(eV) \times L_f}{Pr(Pa) \times P}$$

It's clear that the undesirable effect due to gas increases when the gas pressure (Pr) increases. Reversely, increasing the plasma density ($n_i=ND+NT$) or the ions energy (ED) will decrease this effect (by increasing the fusion power).

For the D+/T+ fusion, $E_f=2.26E-12$ J (for $E_f=14.1$ MeV, without taking into account Alpha particles). Taking the same values of our example described in [§5.7.2](#) (equilibrium state), $ED=54200$ eV, $L_f/P=0.8$ and $n_i=5E19$, we have: $R_{fec} = \frac{3.39E-7}{Pr(Pa)}$

5.6.3.4 Determination of the required maximum gas pressure

For $R_{fec} \geq 100$, it would be necessary to limit the pressure to 3.39 nPa, which is not possible. For 10 nPa which is the minimum industrially acceptable, $R_{fec}=33.9$, which is not so good.

So the maximum gas pressure will be fixed to 10 nPa.

Note that the ratio R_{fec} deduced from simulation is better by more than 40% compared to the theoretical R_{fec} . This because due to the gradient of density inside the pipe (i.e. the density is bigger at the center than at the pipe periphery), the fusion power is bigger than expected (i.e. calculated with a flat density) (see [§5.4.5.3](#)). The multiplier factor of the fusion rate is about 1.3. Moreover, due the big difference between injected energies and equilibrium energies, this ratio is finally not so critical.

5.7 Losses compensation and balance of energies

5.7.1 Introduction

As explained in [§5.4.3](#), the Bremsstrahlung, cyclotronic and impurities radiation losses make electrons energy decrease. However, due to Coulomb collisions between ions and ions, electrons and ions, electrons and electrons, the particles finish to be equilibrated at a certain level:

- $E_T = 3/2 \times ED$ (see [Appendix D](#)), so $E_i=(ED+E_T)/2 = 1.25 \times ED$,
- $E_e = 1.2 \times ED$ (see [Appendix A part 2](#)), or $E_e=0.96 \times E_i$ (E_i the mean ions energy).

A loss in the electrons energy (E_e) will be communicated to the ions. Consequently the radiation losses will be shared by electrons (directly) and ions (with a delay).

Note: the ions cooling by bound electrons (of the D2 gas) is, here, neglected.

Reversely, part of the Alpha particles (see [§5.4.7](#)) will heat the plasma.

Moreover, the particles (initial and then replacement) are injected with an energy which can be controlled through the acceleration voltages. So, for a given Alphas heating, by choosing the right injection energies, the equilibrium state could be close to the ideal conditions for fusion.

Below the suffix “_equi” corresponds to the equilibrium energies, whereas the suffix “_inj” corresponds to the injected energies.

5.7.2 Principle

Alphas heating (see §5.4.7) is a powerful source of heating the plasma, in permanent working, much superior in magnitude than the radiations cooling (for the D/T fusion).

During the permanent working, it will be lost ions which will have to be replaced.

The replacement ions are:

- the two ions lost after each fusion (i.e. D+ and T+) (see §2),
- the ions lost on the pipe wall (see §5.4.6.3 and §5.4.6.4),
- the ions lost after charge-exchanges with neutrals of the D2 gas (see §5.6).

In §5.4.2, it has been supposed that electrons losses are very weak and, consequently, the replacement electrons are neglected.

The injection of filling ions will be done at energies below the equilibrium energies so that the E_{com} energy be ideal (i.e.=65 keV) for frontal collisions of particles having the same speed (see Appendix D) but opposed. It is reminded that particles are injected with a small radial speed. So before being thermalized, they behave as particles colliding frontally.

It can be shown that, in that case $E_{com} = 1.92 E_i$ and the injection energies would be equal to $E_{D_inj}=27.1$ keV, $E_{T_inj}=40.6$ keV ($E_{i_inj}=33.9$ keV). Electrons would be injected at $E_{e_inj}=1.2 \times E_{D_inj}=32.5$ keV, in coherence with the ions energies.

Note that this level of injected energies is the (minimum) ideal level to initially fill the reactor and to permit a quick Alphas heating. Of course, an energy E_{i_inj} a bit superior to 33.9 keV will heat the plasma quicker. For example, in the simulation of §6.2.2.3, $E_{i_inj}=37.5$ keV for filling ions. However, for replacement ions injection, once the equilibrium energy reached, a much lower level will be preferred due to the small energy consumption which will increase the mechanical gain (see §5.7.3.3). For example, in the simulation of §6.2.2.3, $E_{i_inj}=13.3$ keV for replacement ions, this one giving a mechanical gain equal to 28.3.

After the reactor filling, the plasma will be heated by the Alphas heating and will reach an equilibrium state. Ideally this equilibrium state will be such that the E_{com} energy be ideal (i.e.=65 keV) for central collisions. It is reminded that after thermalization, ions behave as particles colliding centrally. It can be shown that, in this case, $E_{com} = 0.96 E_i$, so the ideal $E_{i_equi}=65$ keV/0.96=67.7 keV. These conditions would correspond to the following ions energies: $E_{D_equi}=54.2$ keV and $E_{T_equi}=81.2$ keV. Electrons energy would stabilize at $E_{e_equi}=1.2 \times E_{D_equi}=65$ keV.

Note that in §5.8, it will be shown that ideal equilibrium energy is, in fact, higher than 67.7 keV.

In conclusion, at equilibrium state, the Alphas heating will permit to compensate the radiation losses and to carry the particles, injected at low energies, to the permanent high conditions of working.

5.7.3 Balance of energies and estimation of the particle injection energy

Relatively to the equilibrium state described above, there are:

- an heating source (by Alpha particles),
- three cooling sources due to replacement ions (see above), the injection energies being inferior to the equilibrium energies,
- three cooling sources due to Bremsstrahlung, cyclotronic effects and radiation losses due to impurities.

Note that below, by agreement, an heating power is positive, and a cooling power is negative.

The balance of energy, at the equilibrium state, between all these sources can be roughly estimated from the seven terms (for D/T fusion):

- The Alphas heating density of power (Pam3 in W/m³) is defined in [§5.4.7](#) as:

$$Pam3\left(\frac{W}{m^3}\right) = \frac{2525 \times Ea(J) \times ni^2 \times \langle \sigma \rangle \times ED_equi (eV)^{0.5} \times Lf}{P}$$

Here ED_equi is the mean ED at equilibrium and $\langle \sigma \rangle$ the fusion cross section for Ecom at equilibrium (Ecom = 0.96 x Ei_equi).

Ea(J)=3.5E6 x q x la (see [§5.4.7](#))

- The cooling density of power (Pifm3 in W/m³) due to replacement ions issued from fusion (2 ions per fusion). It is similar to Pfm3 ([§5.4.5.3](#)), except that Ef(eV) must be replaced by 2 x (Ei_inj-Ei_equi), where, for one ion:
 - Ei_inj (eV) is the mean ions energy at injection level,
 - Ei_equi (eV) is the mean ions energy at equilibrium (superior to Ei_inj).

$$Pifm3\left(\frac{W}{m^3}\right) = \frac{5050 \times (Ei_{inj} - Ei_{equi})(eV) \times q \times ni^2 \times \langle \sigma \rangle \times ED_equi (eV)^{0.5} \times Lf}{P}$$

- The cooling density of power (Phcem3 in W/m³) due to replacement ions issued from charge exchanges. It is similar to Pcem3 ([§5.6.3.2](#)). It is enough to multiply Pcem3 by (Ei_inj-Ei_equi) (eV)/Ei_equi(eV).

$$\text{So } Phcem3\left(\frac{W}{m^3}\right) = 2.77E - 10 \times Pr(Pa) \times \sqrt{ED_equi(eV)} \times ni \times \frac{(Ei_{inj}-Ei_{equi})(eV)}{Ei_{equi}(eV)}$$

- The cooling density of power (Phdm3 in W/m³) due to replacement ions issued from losses on the pipe wall. It is similar to Pdm3 ([§5.4.6.4](#)). It is enough to multiply Pdm3 by (Ei_inj-Ei_equi) (eV)/Ei_equi(eV).

$$\text{So } Phdm3\left(\frac{W}{m^3}\right) = \frac{ni \times Ei_{equi}(eV) \times q}{Ct} \times \frac{(Ei_{inj}-Ei_{equi})(eV)}{Ei_{equi}(eV)} = \frac{ni \times (Ei_{inj}-Ei_{equi})(eV) \times q}{Ct}$$

- The cooling power Pcym3 in W/m³ due to Cyclotronic losses, is given by the formula in [§5.4.3](#): $Pcym3 = -4E - 19 \times ne \times B^2 \times Ee (keV)$
- The cooling power Pbrm3 in W/m³ due to Bremsstrahlung (see [§5.4.3](#)), is given by the formula (2.25) of the reference [1] (page 23), multiplied by -1 to be negative, with Te = 2/3 x Ee (eV), and: Ee (eV)=1.2 x ED_equi = (1.2 /1.25) x Ei_equi = 0.96 x Ei_equi (=Ecom)
- The cooling power Pimm3 in W/m³ due to radiation losses on impurities, called Pimm3, is taken equal to the cooling power due to Bremsstrahlung: Pimm3=Pbrm3 (see [§5.4.3](#)).

The balance of energies is given by:

$Pam3 + Pifm3 + Phcem3 + Phdm3 + Pcym3 + Pbrm3 + Pimm3 = 0$ (Pam3 is positive, the other terms are negative).

Note that some losses might be taken into account, but they are difficult to determine:

- loss of electrons on the pipe wall. It is supposed to have a negligible impact (see [§5.4.2](#)),
- partial inhibition of the fusion due to Alpha particles. This impact will be neglected considering that a device (Divertor or equivalent) clears the plasma from them. Ideally, Alpha particles would be removed once they reach the mean energy of the plasma (around Ei_equi).

Reversely, note that this calculation is a bit pessimistic at Pam3 level, because fusions issued from frontal collisions of replacement ions are neglected and only fusions issued from central collisions are considered.

Below are three examples which are going to show ways to make work this reactor.

5.7.3.1 First example

Let's suppose that:

- the reactor filling is not yet made,
- λa (part of Alphas confined in the pipe, cf. [§5.4.7](#))=0.8. For 5 T, a pipe radius R_p equal to 0.15 m is necessary for $\lambda a=0.8$.

The goal of this example is to know which is the injection energy (E_{i_inj}) permitting to stabilize the plasma mean energy at E_{i_inj} . In other words, at which E_i , the Alphas heating just compensates the radiations losses.

After calculation, the result is $E_{i_inj\ min}=25.9\ keV$.

This shows that a stabilized state could be obtained at a value of E_{i_inj} not very high. Of course, this state would be without interest, as no power will be produced.

Now, if the injection is made from an energy slightly superior to $E_{i_inj\ min}$ (25.9 keV+1 keV for the example), the Alphas heating will pass the radiation losses and the plasma energy will very slowly increase up to an equilibrium energy.

So, it is not strictly compulsory to inject ions at $E_{i_inj}=33.9\ keV$ (best energy for frontal collisions), as proposed in [§5.7.2](#). Filling the reactor can be done from an inferior energy. However, if the injectors are able to inject at $E_{D_inj}=27.1\ keV$, $E_{T_inj}=40.6\ keV$ ($E_{i_inj}=33.9\ keV$) and $E_{e_inj}=32.5\ keV$, this will permit to rapidly reach the equilibrium state, from a not too elevated energy.

5.7.3.2 Second example

Let's have the same hypothesis as in [§5.7.3.1](#)

The reactor filling will be made at the nominal injection energy (defined in [§5.7.2](#)).

The goal of this example is to know which is the minimum pipe radius (R_p), for which the ideal equilibrium energy E_{i_equi} (defined in [§5.7.2](#)) will be just reached, without being passed.

The result is $R_p=158\ mm$ ($\lambda a=0.821$). So this minimum pipe radius permits to just reach the ideal equilibrium state from the ideal injection state (all defined in [§5.7.2](#)).

This means that the replacement ions must also be injected at this energy E_{i_inj} (and not below). In this case, the mechanical gain is equal to 6.2, which is not much. For a better gain, it will be necessary to have a pipe radius superior to 158 mm, so as to have less ions losses and a higher Alphas heating, which will permit to inject replacement ions at an injection energy lower than injection energy used during the filling (cf. [§5.7.2](#)), which will reduce the mechanical energy cost.

Consequently, in permanent working, the lower the injection energy is, the higher the mechanical gain is. This is shown in the third examples, below.

5.7.3.3 Third examples

Let's suppose that:

- the pipe radius is equal to 170 mm ($\lambda a=0.85$),
- the filling has been done, the ideal equilibrium state at 67.7 keV ([§5.7.2](#)) has been reached and then passed.

The goal of this example is to determine at which energy (E_{i_inj}) the replacement ions can be injected so as to stabilize at the ideal equilibrium state (67.7 keV).

The result is $E_{i_inj\ min}=26.4\ keV$ (instead the 33.9 keV for the filling ions). The mechanical gain is equal to 9.2 instead 6.2, which is better.

Note that with a pipe radius of 190 mm ($\lambda a=0.895$) and $E_{i_inj\ min}=15.0\ keV$, the mechanical gain is equal to 20.2 (see [§6.2.1](#)).

This confirms that a large pipe radius leads to a low injection energy cost and an elevated mechanical gain.

5.7.4 Conclusion

Using a part of the Alpha particles to heat the plasma will permit to compensate the radiation cooling and to inject replacement ions at low energies to work on higher and good conditions, for a final elevated mechanical gain.

Here is abstracted the reactor working:

- In the first stage, the reactor is filled with particles at medium level of energies ($E_{i_inj}=33.9$ keV as proposed in [§5.7.2](#)) or a bit above, so as to rapidly reach, thanks to the Alphas heating, the ideal equilibrium conditions ($E_{i_equi} \approx 67.7$ keV, for $E_{com}=65$ keV) and to pass them.
- In the second stage, replacement ions (and possibly replacement electrons) are injected at low energies, to finally stabilize near the ideal equilibrium conditions or better, a bit above (cf. [§5.8](#)).

5.8 Control of the reactor

The plasma control will be made by:

- The particles injectors, by adjusting the current injected and the acceleration voltage. It is reminded that there are two phases of particles injection: the reactor filling (cf. [§5.4.6.2](#)) and, in permanent working, the replacement of particles lost, mainly ions (cf. [§5.7](#)). Note that stopping the replacement particles injection will also slowly stop the reactor.
- Possibly, by the adjustment of the magnetic field magnitude (fixed, by default, see [§4.2](#)).
- Possibly, by the adjustment of the pipe wall potential (0 V by default, see [§5.4.2](#)).
- By injection of impurities to increase the radiations power if the stabilized equilibrium energy is too high, so as to decrease it down to a value near the ideal one (i.e. E_{i_equi} close to 68 KeV). See [§5.4.3.5](#), [§6.2.2.2](#) and [§6.2.2.3](#) for details.
- By the adjustment of the Divertor rate of extraction, particularly to decrease the impurities level. Finally, the impurities level (and so the equilibrium energy) will be controlled by either injecting or extracting these ones.
- Controlling the gas pressure. For example to stop rapidly the reactor, it could be possible to increase the D2 gas pressure and, consequently, the number of interactions of ions with neutrals (see [§5.6](#) for details).

About the real ideal equilibrium energy (E_{i_equi})

Up to now we have considered that both the fusion cross section σ and the reactivity $\sigma \times V$, are maximum for an E_{i_equi} equal to 67.7 keV (cf. [§5.7.2](#)).

However as shown in the [§5.4.6.3](#), the confinement time (Ct) depends on $(E_i/70000)^{0.72}$, which means that when E_{i_equi} increases, the losses decreases. Consequently, the E_{i_equi} which permits the best mechanical gain will not be necessarily 67.7 keV.

A test has been done, based on the example given in [§5.7.3.3](#): $R_p=0.19$ m and $E_{i_inj}=15$ keV. According to E_{i_equi} , it has been calculated the mechanical gain Q . Here are several results, with E_{i_equi} in KeV:

E_{i_equi}	Q	E_{i_equi}	Q	E_{i_equi}	Q	E_{i_equi}	Q
30	1.8	68	20.2	93	21.6	170	18.7
40	5.9	70	20.3	104	22.2	200	17.7
50	10.4	80	20.9	120	21.1	260	16.2
60	15.5	90	21.5	136	20.2	290	15.5

Relatively to the mechanical gain Q , it can be seen that:

- the best one is obtained at 104 keV and not at 68 keV,
- from $E_{i_equi}=68$ keV, this gain decreases very fast when E_i decreases,
- from $E_{i_equi}=104$ keV, this gain decreases very slowly when E_i increases.

Note that simulations show that the maximum Q is obtained for an energy E_{i_equi} above 104 keV and rather around 118 keV, this probably due to the mean speed distribution of ions which is not discrete (as supposed in the calculation) but rather close to a Maxwell Boltzmann one.

It is reminded that to limit the Beta factor to 0.1, E_{i_equi} must be limited to 93 keV (cf. [§5.1](#)). Consequently, the equilibrium energy will be limited between 60 to 93 keV, and preferentially a bit above 68 keV.

Note about the equilibrium energy (E_{i_equi}) control

When the equilibrium energy E_{i_equi} is really stabilized, simulations show an oscillation of about +/- 2 keV (for the D/T fuel). It is acceptable. Now, it can happen that E_{i_equi} slowly increases up to a very elevated value. For example, see the first simulation of the [§6.2.2.2](#).

During a simulation there is no control of the plasma.

Now, in a real reactor the equilibrium energy will be adjusted to the optimum conditions.

To limit the magnitude of E_{i_equi} , one solution is to increase the particles losses, for example, by increasing the gas pressure or decreasing the magnetic field. But the mechanical gain will decrease. A better solution is to increase the impurities level so as and to increase the losses without making decrease the mechanical gain (see the simulations on [§6.2.2.2](#) and [§6.2.2.3](#)).

Note that simulations show that the magnitude of E_{i_equi} increases,

- when the energy of the filling ions increases (evolution not linear but monotone),
- when the magnetic field increases (evolution not linear and roughly monotone).

In both cases, the increase is probably due to a decrease of the particles losses on the pipe wall.

So it seems not so difficult to find parameters permitting to work at a definite equilibrium energy.

6 Determination of the mechanical and electrical gains

6.1 Introduction

The [Appendix B](#) summarizes the way to calculate the mechanical gain Q .

It will be shown below that the fuel giving the best results in term of mechanical and electrical gains is the D/T one, this due to a high maximum fusion cross-section obtained at a relatively low ions energy, a high fusion products energy, and despite the need of a thermodynamic conversion .

The 3 other fuels are disqualified:

- The D/D fuel has a small maximum fusion cross-section obtained at very high ions energy and a small fusion products energy. It is the worst of these 3 fuels. However, it could possibly permit to predict D/T results from D/D results.
- The p/B11 fuel has a medium maximum fusion cross-section obtained at high ions energy, a medium fusion products energy and a very problematic high electric charge for B11 ($Z=5$), relatively to Coulomb collisions and radiation losses.
- The D/He3 fuel has a medium maximum fusion cross-section obtained at medium ions energy, a high fusion products energy, unfortunately a high electric charge for He3 ($Z=2$), but with a possibility of direct conversion. It is the best among these 3 fuels.

6.1.1 Generalities

In this paragraph, it will be determined the expected:

- mechanical gain Q , i.e. the ratio “mechanical output power / mechanical input power”. It is also called “power amplification factor” in the technical literature about tokamaks, with a different mechanical input power nature,
- electrical gain G_e , i.e. the ratio “electrical energy supplied / electric energy consumed”.

The word “yield” (or “efficiency”) refers, here, to:

- either an “electrical energy to primary (thermal) energy” ratio of any form,
- or the “mechanical to electrical energy ratio” for the particles injectors.

A “yield” (or “efficiency”) value is comprised between 0 and 1. Note that a “gain” has, here, any value.

6.1.2 Types of conversion to electricity

In what follows, it is considered two main sorts of conversion of the kinetic energy of fusion products in electricity: the thermodynamic one and the direct one.

6.1.2.1 Thermodynamic conversion to electricity for the D/T fusion

The fusion energy being mainly carried by neutrons, the conversion is thermodynamic with a yield $\mu_c = 0.36$, which corresponds to the yield of modern fission reactors as EPR for example (for a primary water temperature around 310 °C). In a first approach, all the kinetic energy of the fusion products (except the part of Alpha particles used to heat the plasma), will be transformed in heat at high temperature, by stopping them in matter and, afterwards, transformed in electricity in the standard way (with a boiler, steams generators, a turbine, a condenser, an alternator, etc). At the condenser output, the fluid at relatively low temperature carrying 64 % of the initial fusion energy is not used and is evacuated by the heat sink (sea, river, cooling tower...).

According to [§5.4.7](#) and [§5.7.3](#), it is considered that a part of the Alpha particles heats the plasma, at a magnitude of $\lambda_a \times 3.5$ MeV per Alpha.

The reminder $3.5 \text{ MeV} \times (1 - \lambda_a)$ is considered lost either on the pipe wall or extracted by the Divertor (just before colliding the wall), and transformed in heat, in all cases. For the Alphas part lost in the pipe wall (Beryllium), normally the heat produced by stopping these Alphas inside this wall, is transmitted to the blanket (Lithium) where it is extracted towards the boiler. Now, the heat produced by the Alphas part lost in the Divertor cannot be used easily. So, it will be considered the penalizing hypothesis that the heat developed by the Alpha particles colliding the reactor first wall or the Divertor is unused.

So, in the following, it will be only referred to the gains obtained without taking into account the Alpha (He4) particles. In this case, $E_{pf} = 14.1$ MeV.

This means that if “ R_n ” is the rate of fusion neutrons delivered each second by the reactor, the ideal power delivered by these fusion neutrons (P_{fni}) is equal to: $P_{fni} = R_n \times 14.1$ MeV/s

Unfortunately, it is not possible to recover all the neutrons at 14.1 MeV on specific locations, as the Divertor, the different openings for measuring devices, pipes, etc. So a part called “ a_n ” (around 1/3) of these neutrons cannot be recovered and is lost. This means that the real number of neutrons used will be equal to $R_n \times (1 - a_n)$, and the real power delivered by these fusion neutrons (P_{fnr}) is equal to:

$$P_{fnr} = R_n \times (1 - a_n) \times 14.1 \text{ MeV/s}$$

Now, it must be considered the beryllium/lithium blanket aimed to slow down the neutrons and to regenerate tritium, via the fission reaction: $n + {}^6\text{Li} \rightarrow {}^4\text{He} + \text{T} + 4.78 \text{ MeV}$, the beryllium having the task to multiply by 2 the number of neutrons.

It will be supposed that the TBR (Tritium Breeding Ratio) is equal to 1, which means that the rate of neutrons used by the Lithium blanket is equal to R_n , and the additional power (P_{ln}) delivered by this Lithium blanket is equal to $P_{ln} = R_n \times 4.78 \text{ MeV/s}$.

The total thermal power (P_t in MeV/s) delivered is equal to $P_t = P_{fn} + P_{ln} = R_n \times (((1 - a_n) \times 14.1) + 4.78)$.

To simplify, it will be further supposed that this total power P_t is equal to the theoretical power delivered by all the fusion neutrons (P_{fni}). So $R_n \times 14.1 = R_n \times (((1 - a_n) \times 14.1) + 4.78)$

This leads to $a_n = 33.9 \%$. So it will be considering that 33.9 % of the fusion neutrons are lost.

Consequently, the mean energy submitted to the thermodynamic cycle will be for one fusion equal to $E_{pf}(eV) = 14.1 \text{ MeV}$.

The ratio between the productive power and the total fusion power will be equal to $14.1/17.6 = 0.80$ (80%).

Now in terms of density of power, the “productive” fusion power P_{pfm3} (i.e. transferred to the boiler) is

defined, from P_{fm3} (§5.4.5.3), by: $P_{pfm3} \left(\frac{W}{m^3} \right) = \frac{2525 \times E_{pf}(J) \times n_i^2 \times \langle \sigma \rangle \times ED (eV)^{0.5} \times L_f}{P}$ with $E_{pf}(J) = E_{pf}(eV) \times q$

Or $P_{pfm3} = P_{fm3} \times (14.1/17.6)$.

6.1.2.2 Thermodynamic conversion to electricity for the D/D fusion

As for the D/T fusion, ions issued from the fusion will not be considered as a source of heat able to be used. Only the 1.225 MJ issued from the fusion neutrons (see §2) will be used. Considering 33.9 % of neutrons loss as for the D/T fusion, the ratio between the productive power and the total fusion power will be equal to 0.22 (22%).

6.1.2.3 Direct conversion to electricity for the aneutronic fusions

In the case of aneutronic fusions, the fusion energy is only carried by ions, and the conversion to electricity of the ions beam kinetic energy could be done directly, with a supposed yield equal to $\mu_c = 0.7$ (but it could reach 0.9). Of course, this way to do is only theoretical as there is no easy way to install such device.

However, a modified Divertor able to canalize ions, could be a solution (see §6.2.4). So this possibility is simply suggested, as the thermodynamical cycle is the sole industrially feasible, at the moment.

The productive power considered will be equal to the kinetic energy of ions issued from the fusion at which it will be subtracted the energy necessary to heat the plasma (as the Alpha particles for the D/T fusion).

6.1.3 Electrical consumers

Relatively to the fusion reactor itself (auxiliary equipment being apart), the sole source of energy consumption is the particle injectors. The yield of these injectors, i.e. kinetic energy of the particles injected / electric power consumed (called “ P_{elec} ”) to inject them, is supposed equal to 0.8, which is possible for powerful injectors. So 20% of the energy of these injectors is lost in the form of heat at low temperature. This heat cannot be used and is evacuated by the heat sink.

The injectors have only to compensate for the ions lost in fusions, charge exchanges and losses in the pipe wall (electrons losses are neglected, see §5.4.2).

So for a mechanical injection power P_{m_injm3} (see §6.1.4), the consumed electrical power is equal to P_{e_injm3} : $P_{e_injm3} = (P_{m_injm3} / 0.8) = 1.25 \times P_{m_injm3}$

Note that the electric power P_{e_injm3} is supplied by the alternator through the yield $\mu c = 0.36$. This means that to supply 1 W of mechanical injection power, it is consumed $1/(\mu c \times 0.8) = 3.5$ W of fusion power (neutrons).

Now to make work the reactor, a certain number of auxiliary pieces of equipment are necessary. For a fission reactor (PWR) about 4 % of the electric power delivered by the alternator is used, mainly for the many pumps which permit to make circulate water in the primary, secondary and condenser circuits. In a fusion reactor, there will be the same type of equipment but also cryogenic equipment for vacuum, magnetic coils, thermal shield and equipment to process Tritium.

It will be supposed that 20 % of the electric power delivered by the alternator will be used:

- 10 % for the cryogenic equipment aimed to cool the magnetic coils and the thermal shield.
- 2 % for the ultra high vacuum (included the cryogenic equipment for the cryogenic pumps),
- 2 % for the Tritium processing,
- 6 % for the other auxiliary equipment.

Note that in the case of permanent magnets ([§6.2.2.4](#)), only 10% of the electric power (instead 20%) will have to be considered.

6.1.4 Calculation of the mechanical gain

According to the [Appendix B](#), the mechanical gain (Q) is equal to the neutrons fusion power which divides the mechanical injection power, i.e. in our case: $Q = P_{pfm3} / P_{m_injm3}$. Note that $P_{m_injm3} = P_{pfm3} / Q$.

P_{pfm3} is calculated in [§6.1.2.1](#).

P_{m_injm3} is the mechanical power consumed for particles injection (see [§6.1.3](#)).

Below are calculated the required injection power, for one m^3 of plasma (so in W/m^3), for each source of ions loss.

- To replace ions lost after fusions (2 ions per fusion), the necessary power P_{rfm3} is similar to P_{fm3} ([§5.4.5.3](#)) except that $E_f(eV)$ must be replaced by $2 \times E_{i_inj}$, where E_{i_inj} (eV) is the mean ions energy at injection level, so:

$$P_{rfm3} \left(\frac{W}{m^3} \right) = \frac{5050 \times E_{i_inj}(eV) \times q \times n_i^2 \times \langle \sigma \rangle \times ED_{equi}(eV)^{0.5} \times Lf}{P}$$

- To replace ions lost after charge exchanges interactions, the necessary power P_{rcem3} is similar to P_{cem3} ([§5.6.3.2](#)). It is enough to multiply P_{cem3} by E_{i_inj} / E_{i_equi} .

$$\text{So } P_{rcem3} \left(\frac{W}{m^3} \right) = 2.77E - 10 \times Pr(Pa) \times \sqrt{ED_{equi}(eV)} \times n_i \times \frac{E_{i_inj}(eV)}{E_{i_equi}(eV)}$$

- To replace ions lost on the pipe wall, the necessary power P_{rdm3} is similar to P_{dm3} ([§5.4.6.4](#)). It is enough to multiply P_{dm3} by E_{i_inj}/E_{i_equi} .

$$P_{rdm3} \left(\frac{W}{m^3} \right) = \frac{n_i \times E_{i_equi}(eV) \times q}{Ct} \times \frac{E_{i_inj}(eV)}{E_{i_equi}(eV)} = \frac{n_i \times E_{i_inj}(eV) \times q}{Ct}$$

The total mechanical injection power is equal to: $P_{m_injm3} = P_{rfm3} + P_{rcem3} + P_{rdm3}$ so $Q = P_{pfm3} / (P_{rfm3} + P_{rcem3} + P_{rdm3})$.

6.1.5 Calculation of the electrical gain

From the mechanical power P_{pfm3} , the total electrical power at the output of the alternator P_{om3} is equal to: $P_{om3} = P_{pfm3} \times \mu c$ (for μc and P_{pfm3} see [§6.1.2.1](#)), so $P_{pfm3} = P_{om3} / \mu c$.

The electrical power P_{e_injm3} necessary to produce P_{m_injm3} is equal to:

$P_{e_injm3} = 1.25 \times P_{m_injm3}$ (see [§6.1.3](#)).

So $P_{e_injm3} = 1.25 \times P_{pfm3} / Q$ (see [§6.1.4](#)) so $P_{e_injm3} = 1.25 \times P_{om3} / (\mu c \times Q)$

The power (P_{e_aux}) necessary to supply auxiliary equipment is equal to $P_{e_aux} = P_{om3} \times 0.2$ (see [§6.1.3](#)).

The total electric power (P_{e_tot}) consumed is equal to $P_{e_tot} = P_{e_injm3} + P_{e_aux}$

So $P_{e_tot} = P_{om3} \times ((1.25 / (\mu c \times Q)) + 0.2)$

The electrical gain G_e is the ratio between the electrical energy supplied by the reactor (P_{om3}) and the electric energy consumed (P_{e_tot}). It is equal to $G_e = P_{om3} / P_{e_tot} = 1 / ((1.25 / (\mu c \times Q)) + 0.2)$

Note that G_e is, at maximum, equal to 5. The goal is to have $G_e > 1$.

The electrical power P_{netm3} delivered by the reactor to the electrical net (by m^3 of plasma) will be equal to: $P_{netm3} = P_{om3} - P_{e_tot} = P_{om3} - P_{om3} / G_e = P_{om3} \times (G_e - 1) / G_e$.

Note that $(G_e - 1) / G_e$ is the coefficient to switch from the electrical power supplied by the alternator to the electrical power delivered to the net.

6.2 Deuterium/Tritium fusion

6.2.1 Calculation

The proposed configuration, is based on the example exposed in [§5.7.3.3](#):

- The pipe radius R_p is equal to 170 mm ($\lambda a = 0.85$),
- The injection of replacement ions is made at $E_i = 26.4$ keV. So the injection energies are: $E_{D_inj} = 21.1$ keV, $E_{T_inj} = 31.7$ keV.
Note that, implicitly, the filling ions have been injected at $E_{i_inj} = 33.9$ keV as defined in [§5.7.2](#)
- The equilibrium state will be "ideal" (as defined in [§5.7.2](#)) for central collisions. So the equilibrium energies are: $E_{D_equi} = 54.2$ keV, $E_{T_equi} = 81.2$ keV ($E_{i_equi} = 67.7$ keV), $E_{e_equi} = 65$ keV.
- The other parameters are $P_a = 10$ nPa ([§5.6.3.4](#)), $B = 5$ T ([§5.1](#)) and $n_i = n_e = 5E19$ ([§5.1](#)).

From these conditions, we can calculate the different terms and determinate the mechanical gain, as follows :

- Fusion power ([§5.4.5.3](#)): $P_{fm3} = 1657$ kW/m³
- "Productive" fusion power ([§6.1.2](#)): $P_{pfm3} = 1328$ kW/m³,
- Required injection power to replace the lost ions ([§6.1.4](#)): $P_{m_injm3} = 143.9$ kW/m³
 - by fusion: $P_{rfm3} = 5.0$ kW/m³
 - by charge exchanges: $P_{rcem3} = 12.6$ kW/m³
 - on the pipe wall: $P_{rdm3} = 126.4$ kW/m³
- Mechanical gain ([§6.1.4](#)): $Q = 9.2$
- Electrical gain ([§6.1.5](#)): $G_e = 1.7$
- Net electrical power ([§6.1.5](#)): $P_{netm3} = 202.3$ kW/m³.

It can be seen that the term P_{rdm3} is elevated. It could be interesting to increase the pipe radius.

There are many possible configurations. For example, the configuration with $R = 0.19$ m, $\lambda a = 0.895$ and $E_{i_inj} = 15.0$ keV, is more than twice better than the previous one, due to a low injection energy (15.0 instead 26.4 keV) and lower ions losses on the pipe wall:

- Required injection power to replace the lost ions ([§6.1.4](#)): $P_{m_injm3} = 65.8$ kW/m³
 - by fusion: $P_{rfm3} = 2.8$ kW/m³
 - by charge exchanges: $P_{rcem3} = 7.1$ kW/m³
 - on the pipe wall: $P_{rdm3} = 55.8$ kW/m³
- Mechanical gain ([§6.1.4](#)): $Q = 20.2$
- Electrical gain ([§6.1.5](#)): $G_e = 2.7$
- Net electrical power ([§6.1.5](#)): $P_{netm3} = 407.3$ kW/m³.

This reactor could work as an electric power generator.

6.2.2 Simulations

6.2.2.1 Introduction

All the simulations have been done, with the following conditions, the same as the calculation ones in [§6.2.1](#):

- $P_a=10$ nPa and $B=5$ T (except $B=1.4$ T in [§6.2.2.4](#)),
- $ED_{inj}=2/3 \times ET_{inj}$ and $Ei_{inj}=1.25 \times ED_{inj}$,
- An ions current so as to obtain $n_i=n_e=5E19$, as expected ([§5.1](#)).

The reactor filling lasts 0.3 s, as defined in [§5.4.6.2](#). The replacement ions are injected at a low injection energy after one second, time supposed to reach a high mean energy from 60 to 93 keV. Ideally it would be a bit above 68 keV as proposed in [§5.8](#).

Compared with the calculation, simulations take into account:

- A ions slowdown induced by bound electrons (even if it is a very weak effect).
- A radial speed introduced through the maximum angle for injection, equal to 0.08 Rad (4.58°), this to be more realistic.

Note that the quality of the simulation is not excellent due to the necessity to limit the simulation time: a simulation can last 1 day for 15 sec simulated, with 1112 ions circulating, on a familial PC. So the number of simulations has been limited and the uncertainty is not negligible. Moreover there is a certain variability of results when starting on the same conditions but with a different set of random values.

Note: to be sure to have the same results for the same configuration, it is necessary to stop and re-start Multiplasma at each new configuration.

Consequently, all simulation results must be considered are rough but sufficient to make up an idea.

Note that simulations show an oscillation of crest magnitude equal to about 2 keV for D/T fusion and 4 keV for D/He3 fusion, around the equilibrium energy, when the plasma is really stabilized.

It is only simulated a straight pipe (of 1.8m long on the simulation) where D+/T+ trajectories are superposed (plasma not twisted). So the mechanical gain from the simulation must be normalized, multiplying it by 0.80 (hypothesis from [Appendix C](#)). Moreover Multiplasma gives a gain based on the total fusion power: $17.6-3.5 \cdot \lambda_a$. So, to normalize, the Multiplasma gain will be multiplied by $0.80 \times 14.1 / (17.6-3.5 \cdot \lambda_a)$.

The main goals of these simulations are:

- to compare results with the calculations ones,
- to determine which are the problems and to give a solution.

Further are presented three simulations: the main one with the nominal magnetic field (5 T) and a quasi-normal (+10%) radiations power. The second one is obtained by doubling the radiations power. The third one is obtained by using a small magnetic field (1.4 T). Note that these penalizing cases (second and third) give better mechanical and electrical gains than the first one, due to the larger pipe radius used.

6.2.2.2 Main simulation

A first simulation has been made on a pipe radius $R_p=0.19$ m, taken into account in [§6.2.1](#). The goal is to determine a configuration for which the mean equilibrium energy (Ei_{equi}) is close to 67.7 keV (see [§5.7.2](#)) or, better, a bit above (cf. [§5.8](#)) with replacement ions injected at the lowest energy.

The following results are extracted (or determined) from the data given by the simulator while in equilibrium

state, i.e. after 12 to 14 s.

The filling ions are injected at $E_{i_inj}=37.5$ keV. With an injection energy E_{i_inj} for replacement ions equal to 15 keV and $B=5$ T (as in §6.2.1), the working is never stable according to the criteria of the Appendix B, i.e. the equilibrium energy E_{i_equi} does not stop increasing. If we consider the state at 12 sec, we have $E_{i_equi}=136$ keV (which is much too high), the normalized mean mechanical gain (Q) is equal to about 36, with a fusion power of $1.6E6$ W/m³.

However this configuration is outside the design wished ($E_{i_equi} \leq 93$ keV, cf. §5.1).

This behavior is due to the fact that the confinement time increases with E_{i_equi} (cf. §5.4.6.3), so the losses on the pipe wall decrease, which makes increase E_{i_equi} , up to a very high equilibrium energy (see §5.8). The gain increases due to the weak losses.

This configuration is called “D_T_fusion_5_T_R_19_cm_12_18_keV_Rad_x_1.0.SER” for the Multiplasma simulator (inside the “Configurations” sub-directory).

A way to limit E_{i_equi} to a reasonable magnitude (i.e. ≤ 93 keV) is to slightly increase the radiation losses. After several tests, it has been found that 10 % more radiations losses permits to stabilize the equilibrium energy E_{i_equi} around 92 keV. The filling ions are injected at $E_{i_inj}=42.5$ keV.

The normalized mechanical gain (Q) is equal to about 18.5, with a fusion power of $1.5E6$ W/m³. The electrical gain is equal to $G_e=2.6$. It is considered as the main test configuration.

Taking into account that, at 92 keV, the gain might be superior than the one at 68 keV (see §5.8), it must be considered that the gain Q (18.5) is 14% inferior to the theoretical gain (20.2 in §6.2.1).

Note that this power corresponds to a surface power of 0.14 MW/m², which is a low density of power, relatively to materials.

This configuration is called “D_T_fusion_5_T_R_19_cm_12_18_keV_Rad_x_1.1.SER” for the Multiplasma simulator (inside the “Configurations” sub-directory). It is the “official” configuration file (“CONF_PLASMA.SER”).

Problem of the inferior energy limit to inject replacement ions

Simulations show that the injection energies cannot be as low as possible, unfortunately. For example, for a pipe radius $R_p=19$ cm and a high $E_{i_equi} (\geq 92$ keV), the minimum injection energy E_{i_inj} must be equal to 15 keV. Below this value, it appears that after a certain time (for 8 to 12s for $R_p=19$ cm), the fusion rate decreases and the losses on the wall rapidly increases, which makes strongly decrease the mechanical gain. This effect is maximum for very low energy ($E_{i_inj} = 1$ keV) and decrease when E_{i_inj} increases, up to 15 keV for which this effect is not perceptible. It seems that the low energy injected ions diffuse rapidly towards the wall without being sufficiently heated to produce fusions.

This inferior limit slowly decreases:

- when the pipe radius increases (and reversely), probably because replacement ions have more time to be heated,
- when the equilibrium energy increases, probably because losses on the wall are less numerous.

6.2.2.3 Simulation by doubling the radiations power

As proposed in §5.4.3.5, the radiations power will be doubled. In this case, the pipe radius R_p must be wider than previously ($R_p=0.19$ m), to supply more Alphas heating to compensate the radiation power in excess. It has been found that $R_p=0.22$ m is sufficient.

The filling ions are injected at $E_{i_inj}=37.5$ keV. With an injection energy E_{i_inj} for replacement ions equal to 13.3 keV, the normalized mechanical gain (Q) is equal to about 28.3, with a fusion power of $1.4E6$ W/m³. The electrical gain is equal to $G_e=3.1$.

This configuration is called “D_T_fusion_5_T_R_22_cm_10.67_16_keV_Rad_x_2.SER” for the Multiplasma simulator (inside the “Configurations” sub-directory).

Note that the gain is much superior to the one obtained in the main simulation (§6.2.2.2) which is logical as the confinement time of particles is higher whereas the replacement ions are injected at a lower energy.

Problem of the inferior energy limit to inject replacement ions

For $R_p=0.22$ m, the minimum injection energy E_{i_inj} is equal to 13.3 keV.

6.2.2.4 Simulation with losses on wall multiplied by 12.8

As proposed in §5.4.6.3, it is interesting to multiply losses on the pipe wall by a factor around 10 (i.e. the confinement time is divided by about 10), by switching the toroidal magnetic field from 5 T to 1.4 T (supposed supplied by the best permanent magnets). The effective factor will be equal to 12.8.

After several tests, it has been defined the following possible configuration.

The filling ions are injected at $E_{i_inj}=67.5$ keV. For $R_p=0.50$ m ($\lambda a=0.773$) and $E_{i_inj}=12.5$ keV, the normalized mechanical gain (Q) is equal to about 20.8, with a mean equilibrium energy $E_{i_equi}=60$ keV and a fusion power of $1.7E6$ W/m³. The working is not very stable, due to strong oscillations of +/- 10 keV. Moreover, the Beta factor is equal to 0.82, which is not compatible with the maximum Beta factor of 0.1 (see §5.1).

In that case, there is no cryogenic equipment aimed to the magnetic coils and the thermal shield.

So $Ge = 1 / ((1.25 / (\mu c \times Q)) + 0.1)$ and is equal to 3.7.

This last configuration is called “D_T_fusion_1_4_T_R_50_cm_10_15_keV.SER” for the Multiplasma simulator (inside the “Configurations” sub-directory).

So even with a very low magnetic field, it would be possible (supposing that a Beta factor of 0.82 be acceptable) to have elevated mechanical and electrical gains. However, note that for $R_p=0.50$ m, the particles currents are extremely elevated.

6.2.3 Improvement of the mechanical and electrical gains

To increase the mechanical gain, the replacement ions must be injected at the lowest injection energy possible, with an inferior limit E_{i_inj} depending on the pipe radius (see §6.2.2.2).

The main way to increase the mechanical gain is to increase the pipe radius (R_p) so as:

- to decrease the rate of ions lost on the pipe wall (see §5.4.6.3) and, consequently, the energy lost by collisions on the wall,
- to slightly decrease the inferior energy limit of injection.

This solution is shown in the §6.2.1, where the mechanical gain at $R_p=0.19$ is more twice higher than at $R_p=0.17$ m, with the minimum injection energy possible ($E_{i_inj}=15$ keV).

Now as the Alphas heating (see §5.4.7) is going to increase (with R_p increasing), the way to compensate this excess of energy is to increase the radiations power (see §5.4.3.5 and §5.8).

As shown in the first simulation of the §6.2.2.2, it is also possible to increase the equilibrium energy so as to decrease the losses on the pipe wall and to increase the gain, but the design will have to be reviewed regarding the Beta limit (cf. §4.2) and the shift on the loops (cf. Appendix C). Moreover, the energy equilibrium between electrons, ions and Alphas will be even more problematic (see Appendix A part 2).

The other ways to improve the mechanical gain are:

- a higher magnetic field to reduce the loss of ions (§5.4.6.3),
- a higher ions density and/or a lower gas pressure to reduce the ratio between fusion and charge exchange powers (§5.6.3).

The ways to improve the sole electrical gain are:

- a better thermodynamic conversion yield (see §6.1.2.1) or a higher temperature of the vapor,
- a better injectors efficiency (§6.1.3),
- a reduced auxiliary equipment power (§6.1.3).

6.2.4 Reflections about a possible spatial application

In this document, it is referred to electricity production. Now another application of this reactor could be spatial propulsion. Below are some reflections about this application:

- The minimum altitude to use this reactor would be of about 1000 km, to get directly the ideal vacuum conditions (10 nPa maximum). This will permit to avoid the UHV equipment.
- Such D/T reactor would need a magnetic field based on the best permanent magnets (see [§4.2](#), [§5.1](#) and [§5.4.6.3](#)), as it is not possible to use superconducting coils in space, because due to the heating by the Sun radiations, a heavy cryogenic equipment associated to immense heat radiators would be necessary. Consequently, with a small magnetic field, the pipe diameter will be necessarily large (see the results of [§6.2.2.4](#)). Moreover, to remain compatible with the same particles density ($n_i=5E19$), the acceptable Beta factor might reach 0.82 (see [§5.1](#) and [§6.2.2.4](#)). The twist of the plasma will be made with not superconducting helical coils, supplied in electricity by the reactor.
- The reactor would be widely separated from the vessel so that the protection of the vessel against neutrons be reduced.
- For the electric generator, it will be used a Stirling cycle (or equivalent), to avoid the heavy machinery which would be necessary with a water-steam cycle. Due to the foreseeable relatively high temperature of the heat sink (necessary for radiators), the cycle would have to work at the maximum temperature possible, i.e. higher than on a PWR fission reactor (310°C). The heat not used will be evacuated to the heat sink, in the form of radiations. A large area of radiators will be necessary.

Note: for about the electricity production from the neutrons fusion power, without UHV, cryogenic and Tritium equipment, the necessary auxiliary equipment power switches from 20 % of the output power (cf. [§6.1.3](#)) to 6% (included the helical coils electricity supply). So, this will strongly increase the electrical gain: $Ge=1 / ((1.25/(\mu c \times Q)) + 0.06)$.

- The electricity at the output of the alternator will have to supply a very powerful ion thruster. The propellant gas will be Xenon or equivalent (or even air). This ion thruster will be able to eject ions at a speed of 50 km/s, with a supposed yield of 0.8.

Note 1: the exchange between particles kinetic energy from the ion thruster and the vessel kinetic energy is theoretically perfect if the ejection speed is equal to the vessel speed. However, in this case, the weight of propellant to carry would be extremely important. So a compromise is necessary, which justifies the 50 km/s speed.

Note 2: regarding this application, it might, necessarily, exist means to reload the vessel with propellant gas at a low economical cost.

- To avoid the heavy equipment necessary to produce Tritium, this one, which half-life is equal to 12.32 years, will be loaded (with the Deuterium) in the vessel before departure.

Example

Let's suppose a vessel which weight (without the propellant gas) is 1000 tons, such weight due to the fusion reactor. The vessel rotates around the Earth at 7.35 km/s, at an altitude of 1000 km. The goal is to accelerate the vessel up to reach the Earth escape velocity (10.4 km/s). So the ΔV is equal to 3.05 km/s (10.4 – 7.35).

The reactor is supposed able to supply a mechanical power (Ppf) of 300 MW. For a pipe radius $R_p=0.5$ m and a fusion power (neutrons only) density of 1.63 MW/m³ (based on [§6.2.2.4](#)), the circumference of the figure of "0" will be about 295 m. The mechanical gain Q is equal to 20.8 (cf. [§6.2.2.4](#)). The yield μc is

supposed equal to 0.36.

The total electrical power at the output of the alternator P_o ($P_o = P_{pf} \times \mu c$) is equal to 108 MW.

The electrical gain G_e ($G_e = 1 / ((1.25 / (\mu c \times Q)) + 0.06)$) is equal to 4.4.

The electrical power P_{net} ($P_{net} = P_o \times (G_e - 1) / G_e$) delivered by the reactor to the vessel electrical net is equal to: 83.5 MW. The mechanical power transmitted to ions by the ion thruster, this one having an efficiency of 0.8, is equal to 66.8 MW. Ions are ejected at $V_e = 50$ km/s.

In this case, it can be shown (cf. [\[13\]](#) for formulas used) that the vessel will reach 10.4 km/s in 14 days, after having consumed 63 tons of propellant gas (but only 1.35 kg of D/T fuel).

6.2.5 Points to deepen about this proposal of D/T fusion machine

Below is given a non exhaustive list of points to deepen:

- The real magnitude of particles losses. In other words, the real confinement time (cf. [§5.4.6.3](#)).
- The real magnitude of the Alphas heating, according to B and R_p (cf. [§5.4.7](#)), taking into account all the figure of "0" and not only the straight pipes (cf. [§5.5.2](#) and [Appendix C](#)).
- The industrial ability to inject particles at the required conditions, with a good efficiency taking into account radial and axial space charge (cf. [§5.4.6](#)).
- The real magnitude of radiation losses, especially cyclotronic radiated power and losses due to impurities (cf. [§5.4.3](#)).
- The real particles dynamic during an exchange of charge and a ionization, which, possibly, would permit to remove the penalizing hypothesis made in [§5.6.3.1](#).and [§3](#).
- A calculation taking into account the real progressive distribution of speeds, i.e. from an almost discrete one when particles are injected, to a Maxwell-Boltzmann one when particles are thermalized.
- The determination of the real ability of electrons to exchange energy with ions, because as indicated in the [Appendix A part 2](#), the rate of energy exchange between ions (+ Alpha particles) and electrons decreases rapidly as the electrons energy increases. So the equilibrium between ions (+Alphas) and electrons could be long to establish, and perhaps too long to achieve (it has supposed to be instantaneous in the simulations), with a risk of unwanted "Runaway" electrons in case of appearance of an electric field and, at worst, a decoupling between energies of ions, electrons and Alphas.
- The real behavior of particles in the loops (half-torus) (see [Appendix C](#)), this relatively to the pipe sizing and to the reduced fusion rate (1/2), taking into account the possible instabilities (cf. [§5.1](#)).
- The real diffusion regime in the loops and in the straight pipes, which determines the mean confinement time (cf. [§5.4.6.3](#)).
- The real permanent consumption of the electric equipment, especially to supply the magnetic field and to permit an UHV vacuum (cf. [§6.1.3](#)). The goal would be to reduce the necessary auxiliary equipment power. In [§6.1.3](#) this one is supposed equal to 20 % of the output power, which limits the electrical gain to 5. It will be useful to move closer to 4 %, as on fission reactors (PWR).

6.2.6 Conclusion

The D/T fusion is able to give a mechanical gain ≥ 18 and an electrical gain ≥ 2.6 , for a thermodynamic conversion. These values of gains can be improved.

6.3 Deuterium/Deuterium fusion

6.3.1 Introduction

The D/D fusion has a low fusion cross section compared to the D/T fusion, about 100 times lower than D/T in the 50 keV center-of-mass energies. Its cross section increases slowly up to 3 MeV. The radiation losses power increases with the plasma energy. The fusion energy is low (3.65 MeV per fusion).

It is not possible to confine 3 MeV ions at a density of $n_i=5E19$. Moreover, Bremsstrahlung would be simply enormous at 3 MeV.

This reactor could not work as an electric power generator. The sole advantage is that Deuterium is a common fuel and expected results on other fuels could be, possibly, deduced from results on D/D fusion. However due to the very small number of fusions, the heating is negligible, so the plasma is going to rapidly cool. This behavior has been checked with a simulation.

6.3.2 Simulation

This fuel has been simulated in the same conditions as the D/T fuel with $R_p=19$ cm ([§6.2.2.2](#)), except that all the filling and replacement ions D^+ are injected at 42 keV. As expected, the heating due to a part of the ions issued from the fusion is very low and not able to avoid a slow loss of the plasma energy (from 42 keV): after 4 sec, the mean energy of ions is equal to 31.9 keV and after 8 sec it is equal to 29.5 keV. This configuration is called "D_D_fusion_5_T_R_19_cm_42_keV.SER" for the Multiplasma simulator (inside the "Configurations" sub-directory).

6.3.3 Conclusion

One can conclude that:

- The D/D fusion is not a solution for an electric power generator.
- However, this fuel is interesting for possible experimentations (for example, about real losses), which results could be, possibly, used to deduce probable results on D/T fuel.

6.4 Proton/Boron11 fusion

6.4.1 Introduction

This fuel is not as good as the D/T fuel for the following reasons:

- The maximum cross section for p/B11 is equal to $1.2E-28$ m² against $5E-28$ m² for D/T. This maximum is located at a center-of-mass energy of 600 keV (versus 65 keV for the D/T fuel).
- The fusion energy ($E_f=8.68$ MeV per fusion) is about half the one of D/T (17.6 MeV).
- The electric charge of B11 is very high ($Z=5$), which leads to much more Bremsstrahlung losses (and Coulomb collisions).

However, this fusion is interesting as it is an aneutronic one.

According to the reference [\[1\]](#) (page 43), it appears that the ratio between the Bremsstrahlung losses and the fusion power is equal to 1.73, for ions at an energy of 450 keV. So a sole term of loss is yet superior to the fusion power.

Note that this fusion is not simulated by Multiplasma.

6.4.2 Conclusion

The p/B11 fusion is not a solution for an electric power generator.

6.5 Deuterium/Helium 3 fusion

6.5.1 Calculation

This fuel is not as good as the D/T fuel for the following reasons:

- The maximum cross section for D/He3 is equal to $8E-29 \text{ m}^2$ against $5E-28 \text{ m}^2$ for D/T. This maximum is located at a center-of-mass energy of 250 keV (versus 65 keV for the D/T fuel).
- For about the same mass as Tritium, Helium3 has two charges against one for the Tritium, which leads to more Bremsstrahlung losses (and more Coulomb collisions).

However, the big advantage of this fuel is that energy is supplied in the sole form of ions (no neutrons): one Alpha at 3.67 MeV and a proton at 14.67 MeV (so a total of 18.34 MeV). It is an aneutronic fusion. So a direct conversion to electricity with a yield of 0.7 would be possible.

Note that it is possible that secondary fusions occur between D ions and bring neutrons. But this will remain probably residual and very inferior in part of energy to the 2,4 % of the neutron part in term of energy of the well-known fission reactors (for which material technology is ready).

The big disadvantage is that He3 is very rare on Earth.

It is important to know that, for the equilibrium conditions and the same particles density $n_i+n_e=1E20$, the mean Beta factor might be equal to 0.28, which would be much higher than the experimental limit of 0.1. So there would be a major risk of instabilities.

The maximum fusion energy is obtained for $x=nD/nHe3=Z=2$ (i.e. one ion He3 for 2 D+ ions). However, below, it will be considered one ion D+ for one ion He3+ (i.e. 3 electrons for 2 ions), to simplify the simulation. This leads to a pessimistic result (on the fusion power and consequently on the gain) by about 11 %. Ions are injected in a configuration where $E_D=2/3 \times E_{He3}$ (as for D/T and explained in [Appendix D](#)). For $E_{com}=250 \text{ keV}$ and $E_{com} = 0.96 E_i$, $E_{i_equi}=250 \text{ keV}/0.96=260.4 \text{ keV}$. These conditions would correspond to the following ions energies: $E_{D_equi} = 0.8 \times E_{i_equi}=208.3 \text{ keV}$ and $E_{He3_equi} = 1.5 \times E_{D_equi} = 312.5 \text{ keV}$. Electrons energy would stabilize at $E_{e_equi} = E_{com} = 260.4 \text{ keV}$. Let's suppose $n_e=7.5E19$, $n_i=5E19$ and $B=5 \text{ T}$.

At $E_e=260.4 \text{ keV}$, the Bremsstrahlung loss is equal to $1.27 E5 \text{ W/m}^3$ (5 times higher than for DT at 67.7 keV). Radiation from impurities is taken equal to the Bremsstrahlung loss. The cyclotronic loss is estimated to $1.95 E5 \text{ W/m}^3$. The total radiation losses are estimated to $4.49E5 \text{ W/m}^3$.

With a mean ion speed equal to $4.47 E6 \text{ m/s}$, the fusion power is equal to $4.27E5 \text{ W/m}^3$. It is inferior to the radiation losses. And it is not yet estimated the ions part aimed for heating the plasma and the losses due to replacement ions.

Note: the calculation and the simulation for D-He3 are, in fact, pessimistic because a big part of the radiations will be stopped by the matter around the plasma and will be transformed in heat which could be used in the thermodynamic cycle.

6.5.2 Simulation

Here the mechanical gain from the simulation must be normalized, multiplying it by 0.80 (hypothesis from [Appendix C](#)).

6.5.2.1 Test at full radiations power

As expected, for many cases, the mean equilibrium energy slowly decreases.

However for a very large pipe radius ($R_p=0.5$ m), it is possible to maintain a D-He3 plasma at very high conditions injecting ions at $E_{i_inj}=216.7$ keV, but with a very low normalized mechanical gain (around $Q=0.24$).

This last configuration is called "D_He3_fusion_5_T_R_50_cm_217_keV_Full_radiations.SER" for the Multiplasma simulator (inside the "Configurations" sub-directory).

6.5.2.2 Test at half radiations power

It can also be considered the case where radiations power has been divided by 2, which supposes very few impurities and a very low level of cyclotronic radiations, assumptions which can be yet envisaged. With this hypothesis, the "best" configuration is obtained with an ions injection energy $E_{i_inj}=50$ keV and $R_p=0.3$ m: the normalized mechanical gain (Q) is equal to about 1.6, with a fusion power of $2.2E5$ W/m³. So the electrical gain is inferior to <1 in all cases of conversion in electricity.

This last configuration is called "D_He3_fusion_5_T_R_30_cm_50_keV_Half_radiations.SER" for the Multiplasma simulator (inside the "Configurations" sub-directory).

6.5.3 Possibility of an hybrid reactor D/T/He3

As shown in [§5.8](#), the mechanical gain of the D/T decreases very slowly when the equilibrium energy increases. For example at 260 keV, it is still equal to 16.2, for a maximum of 22.2.

A simulation has been performed to confirm that this reactor can work, with D/T fuel, up to very high energies. With the full radiation power, $R_p=0.3$ m, filling made with ions at 225 keV and replacement ions injected at 50 keV, it appears that the D/T plasma stabilizes at around 250 keV with a comfortable normalized mechanical gain of 32.

This last configuration is called "D_T_fusion_5_T_R_30_cm_225_keV.SER" for the Multiplasma simulator (inside the "Configurations" sub-directory).

So it is imaginable to mix a small part of T ions with the D/He3 ions. The goal would be to define the minimum quantity of tritium able to permit reasonable mechanical and electrical gains, with a final part of neutrons energy compatible with present material technology. This hybrid reactor is not simulated by Multiplasma.

6.5.4 Conclusion

The D/He3 fusion is not a solution for an electric power generator.

The main difficulty of this fusion is the strong radiation losses.

However, an hybrid reactor D/T/He3 would, perhaps, be an intermediate solution permitting to limit the flow of neutrons down to acceptable constraints on materials.

7 General conclusion

This reactor works well for the D/T fuel ([§6.2](#)): the mechanical gain (Q) is superior or equal to 18 and the electrical gain (G_e) is superior or equal to 2.6, using a thermodynamic conversion. The D/T fusion is a solution for an electric power generator.

It does not work for the D/D and p/B11 fuels ([§6.3](#) and [§6.4](#)). It does not work either with the D/He3 fuel ([§6.5](#)), but a possibility of hybrid reactor D/T/He3 could be considered.

APPENDIX A

Effect of electrons on the kinetic energy of ions

Part 1 - Analysis of the stopping effect of bound and free electrons on ions (isotropic collisions)

This first part is based on the references [5] and [6] and concerns the stopping effect on injected ions D+ and T+.

1. Stopping effect of bound electrons on injected ions in a gas

The main problem with electrons bound to atoms or molecules (gas D2 in our case, with very low random speed) is that the ions stopping effect is important. Its effect is described by the non-relativistic Bethe formula (see reference [6]):

$$\frac{-dE_{be}}{dx} = \frac{4\pi neZ^2}{me.vi^2} \cdot \left(\frac{e^2}{4\pi\epsilon_0}\right)^2 \cdot L_{be} \quad \text{with } L_{be} \text{ defined by } L_{be} = \ln\left(\frac{2me.vi^2}{I}\right)$$

dE_{be}/dx (J/m) is the loss of ions (D+ or T+) energy (J) by meter due to bound electrons.

“me” (kg) is the electron mass=9.1E-31 kg

“vi” (m/s) is the mean speed of ions (D+ or T+).

“e” is the elementary charge=1.6 E-19 C.

“ε0” is the vacuum permittivity=8.85E-12 F/m

“ne” (electrons/m³) is the electrons density in the gas (twice the D2 molecules density).

“I” (J) the average excitation energy is equal to 19.2 eV for H2 and this value is supposed applicable to D2.

So “I” is equal, in J, to 19.2.e = 19.2 . 1.6E-19 = 3.07 E-18 J

Note 1: the atomic number Z (number of protons by atom) is equal to 1 in our case (D/T fusion), so it will not be considered further.

Note 2: it can be calculated that an ion T+ injected at 230 keV in a D2 gas will statically produce fusion energy before being stopped by electrons, with a very low mechanical gain of about 1.4 E-4, this in the best hypothesis (only collisions with bound electrons and none with gas molecules).

For example, for a D2 gas pressure of 0.1 μPa (high UHV) and D+ ions energy of 60 keV, the D+ ions energy loss rate is equal to 231 eV/s (which is weak but not negligible).

This stopping effect on bound electrons of gas might be taken into account, because it is not possible to have a perfect vacuum. However, an UHV (Ultra High Vacuum) (i.e. D2 pressure ≈ 10 nPa) is required for this reactor. So this effect will be neglected in this document, to simplify the analysis. However, it is taken into account by the Multiplasma simulator.

2. Stopping effect of free electrons on injected ions in a plasma

This chapter is given for information, because the domain of validity of this formula is for electrons between 0 and 1 keV, far away from our condition, i.e. electrons at energy $\gg 1$ keV.

Now let's suppose a gas totally ionized. The electrons are free and move in a random (thermal) way. The ions-ions collisions are neglected, the slowdown being supposed only done by free electrons.

The stopping effect is described by the following formula (see reference [5]):

$$\frac{-dE_{fe}}{dx} = \frac{4.\pi.n_e}{m_e.v_i^2} \cdot \left(\frac{e^2}{4.\pi.\epsilon_0}\right)^2 \cdot L_{fe} \quad \text{with } L_{fe} \text{ defined as } L_{fe} = G(x) \cdot \ln\left(\frac{4.\pi.m_e.v_{pe}^2}{h.w_{pe}}\right)$$

About $G(x)$, $x = 23.3 \cdot \sqrt{\frac{E}{T_e}}$ with E : ions energy in MeV and T_e : electron temperature in eV.

$$\text{Now } G(x) = \text{erf}(x) - \frac{2}{\sqrt{\pi}} \cdot x \cdot \exp(-x^2)$$

Note that $G(x) \approx 1$ for low electron energy and that $G(x) \approx \frac{3 \times (x)^3}{4}$ or $9487 \times \left(\frac{E}{T_e}\right)^{1.5}$ when $x \ll 1$

About w_{pe} (the electron plasma frequency in 1/s) $w_{pe} = \sqrt{\left(\frac{n_e.e^2}{m_e.\epsilon_0}\right)}$

dE_{fe}/dx is the loss of ions energy (J) by meter due to free electrons.

" h " is the Plank constant = $6.63E-34$ J.s

" v_{pe} " (m/s) is the average relative speed between electrons and ions.

" n_e " (electrons/m³) is the electron density equal to the ions density " n_i " is our case.

3. Global stopping effect of electrons on ions in a gas partially ionized

Let's call " Z^* " the average ionization degree as in the reference [5], so " $1-Z^*$ " is the proportion of not ionized gas.

The global effect dE/dx is the sum of both effects, with bound and free electrons as described above:

$$\frac{-dE}{dx} = \frac{4.\pi.n_e}{m_e.v_i^2} \cdot \left(\frac{e^2}{4.\pi.\epsilon_0}\right)^2 \cdot ((1 - Z^*) \cdot L_{be} + Z^* \cdot L_{fe})$$

It can be shown that the stopping effect of bound electrons is very strong compared to the effect due to free electrons at relatively high temperature (between 300 eV and 1 keV).

Note that:

- the stopping effect dE/dx tends to evolve as $\frac{n_e}{E_i \times T_e^{1.5}}$
- the stopping power in term of W (J/s) is equal to $dE/dt = dE/dx \times dx/dt$ where dx/dt is the relative speed of collision V_{pe} between electrons and ions (with $V_{pe} \approx V_i$ for bound electrons and $V_{pe} \approx V_e$ for energetic free electrons (1 keV, for example)).

Part 2 - Free electrons effect in a neutral plasma where collisions occur between ions and two opposed beams of electrons

+ Energy transfer hierarchy

It corresponds to the case where D+ and T+ ions circulate along the figure of "0" (or "8") with two beams of electrons injected in an opposed way (as shown on the [figure 1](#)).

Note: according to the Saha law and due to the high electrons energy (>1 keV), ions and electrons are not going to recombine in Deuterium or Tritium gas, or rather at a neglected rate.

Ions and electrons beams are supposed totally thermalized, i.e. 2/3 of the initial energy (mainly axial) have been transformed in radial energy (it remains 1/3 of the energy in the axial direction). The mean arithmetic speed of both ions and electrons beams is equal to 0 whereas the mean quadratic speed in the axial direction is equal to 1/√3 of the initial speed.

Note that it does not seem possible to control the radial energy of particles (ions or electrons) or the radial confinement. The author has tested (using simulations):

- a magnetic "corkscrew" device (see reference [4]) to try to transform radial energy in axial energy, without success,
- electrostatic lenses (see reference [11]) to confine peripheral ions but without success, either.

Note also that the ions thermalization is almost complete, in 0.3 sec.

Moreover, it will be supposed a perfect (statistically spoken) symmetry of the ions and electrons axial speed distribution.

About D+ and T+ ions, the tendency of such thermalization, is to have the same speed for both ions (see [Appendix D](#)). So the initial T+ energy is equal to 1.5 times the initial D+ energy (ET=3/2 x ED), and, afterwards, this ratio will be roughly naturally kept.

It will be considered D+ ions before considering T+ ions.

1. Interaction between D+ ions and electrons

According to the reference [7] page 52, the variation of energy ΔED, lost or won by a D+ ion when colliding an electron, is equal to:

$$\Delta ED = - \frac{(me \times \mathbf{Ve} + mD \times \mathbf{VD})}{(me + mD)} \times \frac{me \times mD}{me + mD} \times (1 - \cos \theta) \times (\mathbf{VD} - \mathbf{Ve})$$

With mD and me the respective masses of the D+ ions and electrons.

With \mathbf{VD} and \mathbf{Ve} the respective speed vectors of the D+ ions and electrons.

With $me \ll mD$ it comes:

$$\Delta ED = \frac{(me \times \mathbf{Ve} + mD \times \mathbf{VD})}{mD} \times me \times (1 - \cos \theta) \times (\mathbf{Ve} - \mathbf{VD})$$

$$\Delta ED = me \times (1 - \cos \theta) \times \left(\frac{me \times \mathbf{Ve}}{mD} + \mathbf{VD} \right) \times (\mathbf{Ve} - \mathbf{VD})$$

Note that the point of interest is the mean value of ΔED called < ΔED >. Now:

$$\mathbf{VD} \times \mathbf{VD} = VD^2$$

$$\mathbf{Ve} \times \mathbf{Ve} = Ve^2$$

$$\mathbf{Ve} \times \mathbf{VD} = Ve_{//} \times VD_{//} + Ve_{\perp} \times VD_{\perp}$$

"Ve_{//}" is the axial part of the electrons speed and "Ve_⊥" is the radial part.

"VD_{//}" is the axial part of the D+ ions speed and "VD_⊥" is the radial part.

Now <Ve_{//}> and <VD_{//}> are considered as nil after thermalization, so <Ve_{//} x VD_{//}>=0

<Ve_⊥ x VD_⊥> is nil because the radial collisions can be done in all the directions, even if the rotation

directions of electrons and ions are opposed.

So $\langle \mathbf{V_e} \times \mathbf{V_D} \rangle = \langle V_e // \times V_D // + V_e^\perp \times V_D^\perp \rangle = 0$ and, consequently

$$\langle \Delta E_D \rangle = \langle m_e \times (1 - \cos \theta) \times \left(\frac{(m_e \times V_e^2)}{m_D} - V_D^2 \right) \rangle$$

$$\langle \Delta E_D \rangle = \frac{2 \times m_e}{m_D} \times \langle (1 - \cos \theta) \rangle \times (\langle E_e \rangle - \langle E_D \rangle)$$

With $\langle E_e \rangle$ the mean electron energy ($= m_e \cdot V_e^2/2$ in J) and $\langle E_D \rangle$ the mean ion energy ($= m_D \cdot V_D^2/2$ in J).

Reversely the variation of energy ΔE_{eD} , lost or won by an electron when colliding a D+ ion is equal to :
 $\Delta E_{eD} = - \Delta E_D$

The exchange power rate dE_{eD}/dt , for an electron colliding γ_{ei} D+ ions in 1 s, is here equal to:

$$\frac{dE_{eD}}{dt} = \Delta E_{eD} \times \gamma_{ei}$$

The collisions frequency γ_{ei} of an electron colliding D+ ions at a density $n_i/2$ is equal to:

$$\gamma_{ei} = n_i/2 \times \sigma_{ei} \times |V_e - V_i| \approx n_i/2 \times \sigma_{ei} \times V_e, \text{ as } V_e \gg V_i.$$

The Coulomb collision cross section σ_{ei} between an electron and an ion is equal to:

$\sigma_{ei} = 4 \times \pi \times s_0^2 \times \ln(\Lambda_c)$ (see reference [7] page 453), with $\ln(\Lambda_c)$ the ‘‘Coulomb logarithm’’ around a value of 20 and s_0 the ‘‘critical impact parameter’’ equal to:

$$s_0 = \frac{e^2}{12 \times \pi \times \epsilon_0 \times k_b \times T_e} \quad \text{with } e = 1.602 \times 10^{-19} \text{ C and } k_b \times T_e = 2/3 \times E_e$$

So σ_{ei} is proportional to $\left(\frac{1}{E_e}\right)^2$, and γ_{ei} depends on E_e and n_i .

2. Interaction between T+ ions and electrons

Following the same reasoning, it will be found:

$$\langle \Delta E_T \rangle = \frac{2 \times m_e}{m_T} \times \langle (1 - \cos \theta) \rangle \times (\langle E_e \rangle - \langle E_T \rangle)$$

$$\text{As } m_T = 3/2 \times m_D \text{ then } \langle \Delta E_T \rangle = \frac{4 \times m_e}{3 \times m_D} \times \langle (1 - \cos \theta) \rangle \times (\langle E_e \rangle - \langle E_T \rangle)$$

Reversely the variation of energy ΔE_{eT} , lost or won by an electron when colliding a T+ ion is equal to :
 $\Delta E_{eT} = - \Delta E_T$

The collisions frequency γ_{ei} of an electron colliding T+ ions at a density $n_i/2$ is equal to:

$$\gamma_{ei} = n_i/2 \times \sigma_{ei} \times V_e, \text{ with the same value as for D+ ions.}$$

3. Interaction between electrons and ions

As the collisions frequencies of both previous interactions (e/D+ and e/T+) are the same, it can be considered that an electron will collide as many D+ ions as T+ ions. So the mean variation of energy of an electron colliding a ‘‘mean’’ ion $\Delta E_e = (\Delta E_{eD} + \Delta E_{eT})/2$ is equal to (E_e and E_D expressed in J):

$$\Delta E_e = - \frac{m_e}{m_D} \times \langle (1 - \cos \theta) \rangle \times ((\langle E_e \rangle - \langle E_D \rangle) + \frac{2}{3} \times (\langle E_e \rangle - \langle E_T \rangle))$$

$$\text{As } E_T = 3/2 \times E_D \text{ then } \Delta E_e = - \frac{m_e}{m_D} \times \langle (1 - \cos \theta) \rangle \times \left(\frac{5 \times \langle E_e \rangle - 6 \times \langle E_D \rangle}{3} \right)$$

Note that the equilibrium will be obtained for $\Delta E_e = 0$ and consequently for:

$$5 \times \langle E_e \rangle = 6 \times \langle E_D \rangle \text{ or } \langle E_e \rangle = 6/5 \times \langle E_D \rangle$$

$$\text{As } E_T = 3/2 \times E_D, \text{ the mean ions energy } E_i = 1.25 \times E_D, \text{ so } E_e = 1.2 \times E_i/1.25 = 0.96 \times E_i$$

The mean power P_{e1} (W) exchanged by an electron ($P_{e1} = dE_e/dt$), colliding D+ and T+ ions is equal to :

$$P_{e1} = \Delta E_e \times \gamma_{ei}$$

$$Pe1 = -\frac{me}{mD} \times \langle (1 - \cos \theta) \rangle \times \left(\frac{5 \times \langle Ee \rangle - 6 \times \langle ED \rangle}{3} \right) \times ni \times \sigma_{ei} \times |Ve|$$

$\langle 1 - \cos(\theta) \rangle$ (mean value of $(1 - \cos(\theta))$) is equal to about 0.1, after several calculations.

Note that in our zone of electrons energy, $\sigma_{ei} \approx 1.23E - 25 \times \left(\frac{40000}{Ee(eV)} \right)^2$

For example, for a density $ne=ni=5E19$ electrons/m³, with electrons energy at 40 keV ($Ve=1.12E8$ m/s) and D+ ions energy also at 40 keV (so T+ ions energy at 60 keV and $Ei=50$ keV), the electrons energy gain rate ($Pe1$) is equal to 250 eV/s by electron. The electrons energy will increase and the ions energy will decrease until a particles equilibrium be achieved (the total energy of particles being kept).

However it can be observed that 250 eV/s for a difference $Ei-Ee=10$ keV is weak. It means that equilibrium will be much longer than shown by the simulations, as the equilibrium between ions and electrons is supposed instantaneous in the simulations and only the equilibrium between ions is considered. So there is a risk that electrons energy be disconnected from ions and Alpha particles energies, which will prevent the good working of this reactor. Moreover there is a risk that "Runaway" electrons appear. A test could give an answer to this possible problem.

For an electrons density $ne(=ni)$, we have an electrons power gain rate ($Pem3$) in W/m³ equal to (Ee and ED in J):

$$Pem3 = ne \times Pe1 = -\frac{me}{mD} \times \langle (1 - \cos \theta) \rangle \times \left(\frac{5 \times \langle Ee \rangle - 6 \times \langle ED \rangle}{3} \right) \times ne^2 \times \sigma_{ei} \times |Ve|$$

Energy transfer hierarchy

Energy transfer hierarchy (i.e. dE/dt), for the same gap of energies between both particles:

- The dE_{ee}/dt power for electron-electron collisions is the highest and, consequently, the electrons will tend to rapidly share the same energy.
- The dE_{ii}/dt power for ion-ion collisions (for the same ions D+/D+ or T+/T+ and, by extension, roughly to D+/T+) is lower than dE_{ee}/dt by a rough factor equal to V_i/V_e (about 1/50, according to the ions and electrons energies),
- The dE_{ie}/dt or dE_{ei}/dt power for ion-electron or electron-ion collisions is still lower than dE_{ee}/dt by a rough factor of $\frac{4 \times m_e}{m_i}$ (about 1/1150, i.e. about 20 times lower than dE_{ii}/dt for ion-ion collisions). This interaction between ions and electrons is relatively slow (but indispensable). Since the collisions frequency (and so the ability to exchange energy) decreases rapidly when the electrons energy increases, this slowness, unfortunately, also applies to the Alphas heating, Alphas giving mainly their energy to electrons (before giving their energy to ions).

APPENDIX B

D/T reactor energy balance and stability evaluation

This Appendix shows, in a general way, how the D/T reactor energy balance is taken into account in this paper, for D/T fusion. The goal is to determine the mechanical gain (Q).

The following [figure B1](#) summarizes the reactor energy balance.

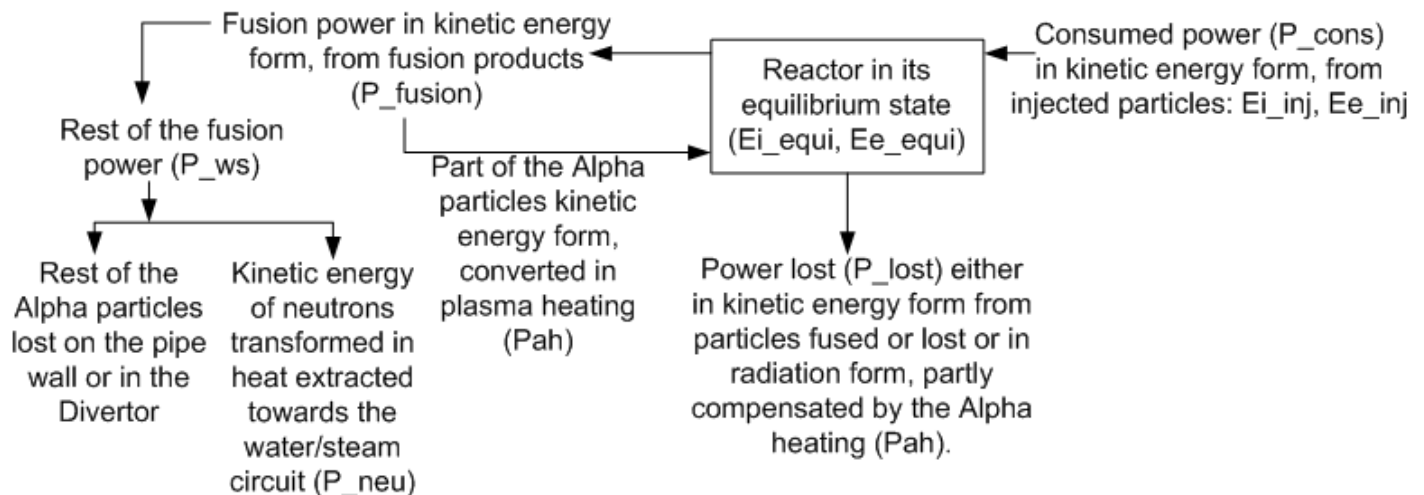

Figure B1

Note that powers, in this appendix, are implicitly referred as densities of power in W/m^3 .

At a steady-state of the reactor we have the equality:

Lost power (P_{lost}) = Consumed power (P_{cons}).

The fusion power (P_{fusion}) is exterior to this equality because taken from the ions density of mass dm_{ions} ($P_{fusion} = d(dm_{ions})/dt \times c^2$).

P_{fusion} represents the total kinetic energy of the reaction products: neutrons and Alpha (He^{4+}) particles, according to the fusion reaction: $D + T \rightarrow He^{4+} (+3.5 \text{ MeV}) + n (+14.1 \text{ MeV})$.

Now a part of the Alpha particles kinetic energy (P_{ah}) is used (see [§5.4.7](#)):

- to heat the plasma cooled by radiations and particles losses (see [§5.7.3](#)) and consequently,
- to bring the plasma to an equilibrium state.

The rest of the fusion power ($P_{ws} = P_{fusion} - P_{ah}$) is shared into 2 parts:

- the rest of the Alpha particles (unused) lost in the pipe wall or in the Divertor,
- the neutrons kinetic energy (P_{neu}) transformed in heat inside the Lithium blanket, this heat being used by the water/steam circuit (mainly boiler, steam generators and turbine), to finally supply electricity thanks to the alternator.

The mechanical gain (Q) is equal to the output power (P_{neu}) which divide the input power, i.e. in our case: $Q = P_{neu} / P_{cons}$.

Note that the electrical gain (Ge) is defined in [§6.1.5](#).

Consumed power (P_{cons} in W/m^3)

$$P_{cons} = nD \cdot \gamma_f \cdot 2 \cdot E_{i_inj} + n_i \cdot (\gamma_{ce} + \gamma_d) \cdot E_{i_inj}$$

n_i is the ions densities.

n_D is the density of the D+ ions with $n_D = n_T = n_i/2$.

γ_f , γ_{ce} and γ_d are respectively the frequency of fusions (cf. [§5.4.5.1](#)), charge exchanges (cf. [§5.6.3.2](#)), losses on wall (cf. [§5.4.6.4](#)).

Note that electrons losses are neglected ([§5.4.2](#)), so there are not considered in permanent working, in the balance of energy.

E_{i_inj} is the mean injection energy of ions (inferior to E_{i_equi}).

So, $P_{cons} = n_i \cdot (\gamma_f + \gamma_{ce} + \gamma_d) \cdot E_{i_inj}$

Lost power (P_{lost})

$P_{lost} = n_i \cdot [(\gamma_f + \gamma_{ce} + \gamma_d) \cdot E_{i_equi}] + P_{ra} - P_{ah}$

E_{i_equi} and E_{e_equi} are, respectively, the mean energy of ions and electrons, at equilibrium (i.e. in the stable state of the reactor).

P_{ra} is the radiation power lost due to Bremsstrahlung, Cyclotronic effects and impurities (cf. [§5.4.3](#) and [§5.7.3](#)).

P_{ah} (Alphas heating) here compensates partly the loss of power, so as to balance the plasma at the equilibrium (E_{i_equi}/E_{e_equi}) state: $P_{ah} = n_i \cdot [(\gamma_f + \gamma_{ce} + \gamma_d) \cdot (E_{i_equi} - E_{i_inj})] + P_{ra}$

This formulation is used in [§5.7.3](#).

Applications

The consumed power is used for calculations (cf. [§6.2](#) for example) whereas the lost power is mainly used for simulations (Multiplasma).

Criterion of stability for the simulator

Now it is important to have a criteria to appreciate the reactor stability. At the reactor starting up, due to the strong Alphas heating, P_{lost} will be negative, which will make increase E_{i_equi} . So P_{lost} will be very different from P_{cons} , P_{cons} being the effective loss.

Gradually, P_{lost} will become positive and, at stability, will be equal to P_{cons} .

However, by running a simulator (Multiplasma here), it can be observed that, at stability, there is a certain slow oscillation around E_{i_equi} (+/- 2 keV for the D/T fusion and +/- 4 keV for the D/He3 fusion).

The (Multiplasma) stability criterion will be estimated over the two last seconds.

It will be considered as obtained:

- if $|(P_{lost} - P_{cons}) / P_{cons}| < 0.1$ (10%),
- and if the difference between the mean energy E_{i_equi} calculated over the last second and the mean energy E_{i_equi} calculated over the penultimate second period, is between 0 and + 2 keV for the D/T fusion (+4 keV for the D/He3 fusion). Note that a negative difference, even limited to -2 keV, could, possibly, mean a slight regular decrease of E_{i_equi} , which is not acceptable.

APPENDIX C

Evaluation of the maximum radial shift in a loop, with a poloidal magnetic field

1. Introduction

As indicated in §5.2.5, with the sole toroidal magnetic field and big particles densities ($n=5E19$), the drift can be enormous. So it is necessary to “short-circuit” the electric field E (see §5.2.1.4) with a poloidal magnetic field so as to have magnetic field lines in form in helix. This comes to create an azimuthal current around the torus magnetic surfaces which inhibits the charges separation.

Note that a particle is now submitted to three rotations: along the loop due to the toroidal field, around the pipe axis due to the poloidal field and around the magnetic line (cyclotronic rotation).

Note also that the magnetic lines of force will not turn at the same “speed” according to the torus magnetic surface (i.e. according to the radius of this surface). This difference creates a shearing (see plate 11-3 of reference [3]) useful to reduce instabilities.

The “safety factor” “qs” is equal to the number of magnetic field big turns around the torus (i.e. the loop) for one small turn of the poloidal magnetic field.

In this Appendix, it will be taken a mean qs of 0.2, i.e. 5 small turns for one big turn as for the Wendelstein 7-X.

The calculation below is based on the reference [10] pages 130 to 142.

There are two sorts of orbits: the circulating ones and the trapped ones:

- The first ones are the “wished” ones, as they leave the circulation of particles on the loop with almost no modification of their speeds.
- The second ones are limited orbits inside the loop, acting according to the same principle as close orbits in a magnetic bottle. The particles are circulating in a small part of the loop . Their orbits shape look like “bananas” more or less wide. They quit these trapped orbits after collisions. These trapped orbits can't be avoided, in a loop.

The goal of this Appendix is to roughly determine the shift of these orbits so as to size the pipe radius. This includes the Alpha particles orbits. It will also be estimated a reduction coefficient to take into account the low fusion rate in the loops (i.e. the two “half-torus”), compared to the one in the straight lines.

2. Trapped orbits

The condition of orbit trapping is the following: $V_a \leq V_r \times \sqrt{\frac{2 \times R_p}{r}}$

With r the loop radius, R_p the interior pipe radius (of the straight lines), V_a the axial speed along the loop, V_r the radial speed.

As $V^2 = V_a^2 + V_r^2$ (V the particle speed), it can be shown that this condition can also be written:

$$V_a \leq V \times \sqrt{\frac{2 \times R_p}{r + 2 \times R_p}}$$

The “banana” width surrounds the original orbit, so it will be considered a “banana” shift δb equal to the half of this width. Considering the worst case, i.e. $V_{a_worst} = V \times \sqrt{\frac{2 \times R_p}{r + 2 \times R_p}}$, it can be written

$$\delta b_{max} = \frac{q_s \times r \times V_{a_worst} \times m}{R_p \times q \times B}$$

Note that the δb shift applies only to the exterior of the loop (low field side).

Bootstrap current

Due the radial density gradient of the plasma and the cyclic rotation of trapped orbits, a current called “bootstrap” appears, circulating along the torus (see [10] page 306 to 308). Unfortunately, this current is not negligible. For Tokamaks, this current consolidates the main plasma current but for Stellarators and consequently, for this reactor it is just a drawback, because it breaks the current equilibrium and so it can be a source of instabilities. Moreover, it distorts the expected magnetic field. This current must be canceled or kept as low as possible (beyond the objective of this paper). Note that it has been found a solution on the Wendelstein 7-X stellarator, with an optimized magnetic field geometry.

3. Circulating orbits

When an orbit is not trapped, it is a circulating one so the condition of circulating orbit is: $V_a > V \times \sqrt{\frac{2 \times R_p}{r + 2 \times R_p}}$

It will be considered the shift δc relative to the original circular orbit. Note that this shift applies on one side or the other side of the loop (low or high field) according to the direction of the particle in the loop. Both

sides will be taken into account. Considering the worst case, i.e. $V_{a_worst} = V \times \sqrt{\frac{2 \times R_p}{r + 2 \times R_p}}$, it can be

calculated the worst shift: $\delta c_{max} = \frac{q_s \times D_s \times r}{V_{a_worst}}$ with D_s the drift speed calculated in [§5.2](#).

Note that for $V_a = V_{a_worst}$, $V_r = V \times \sqrt{\frac{r}{r + 2 \times R_p}}$

4. Total shift on the pipe radius

It will be determined the maximum shift (δm) which must be taken into account in the radius pipe sizing of the loops.

4.1 Electrons shift

Considering that the mean electrons energy E_e is equal to the mean ions energy E_i , which is true within several percent, it can be seen that the shift of electrons (δb or δc) is about $\sqrt{\frac{m_i}{m_e}}$ (≈ 68) smaller than the D/T ions one. So the electrons shift will not be considered.

4.2 Ions shift

As the δc shift applies to both sides, this one concerns the pipe radius. As the δb shift applies to only one side, this one concerns the diameter or half of its value relatively to the radius.

Let δm be the maximum shift on the radius, among δc_{max} and $\delta b_{max}/2$.

Because the speeds of D^+ and T^+ are equal, the worst case between D^+ and T^+ will be the heaviest one, so the T^+ ion.

For our estimation, it will be supposed $r=1.75$ m, $R_p=0.19$ m (as in [§6.2.2.2](#)), $B=5$ T, $E_i=67.5$ keV (so $V=2.274E6$ m/s), $m_T=5.023E-27$ kg, $q_s=0.2$.

However, the maximum speed is about 1.4 times the initial axial speed (in fact, 1.1 to 1.4 were observed from simulations). So the maximum speed V to consider will be equal to $3.184E6$ m/s..

It is found for T^+ ions: $D_{si} = 2.14E4$ m/s, $\delta b_{max} = 0.015$ m, $\delta c_{max} = 0.006$ m and $\delta m = 0.008$ m

Note that the shift of the D^+ shift will be slightly different.

It is found for D^+ ions: $D_{si} = 1.42E4$ m/s, $\delta b_{max} = 0.010$ m, $\delta c_{max} = 0.004$ m and $\delta m = 0.005$ m

There is a small difference of shift (0.2 cm on δc_{max}), so D^+ and T^+ will be slightly separated.

4.3 He4 shift

The Alpha particles will also be submitted to a shift. The initial and maximum energy of these He4 particles

is equal to 3.5 MeV. So it will be supposed $V=1.312E7$ m/s, $m_{He4}=6.696E-27$ kg, $q_s=1.5$.
It is found: $D_s= 2.42E5$ m/s, $\delta b_{max} = 0.064$ m, $\delta c_{max} = 0.015$ m and $\delta m= 0.032$ m

So $\delta m = \delta c_{max} = 0.032$ m. This one being the largest δm shift, it will be chosen as the one covering ions and Alpha particles.

5 Consideration of the low fusion rate in the loops

It can be observed that the shift δc depends on the drift speed D_s which is nil for a straight pipe. So $\delta c=0$ for a straight pipe. Now, it is reminded that the condition of orbit trapping is the following: $V_a \leq V_r \times \sqrt{\frac{2 \times R p}{r}}$.

Plasma in straight pipes can also be slightly twisted, to reduce instabilities. As r is infinite, the probability to trigger a trapped orbit is nil. So there is no shift on straight pipes. It exists only in loops.

Now, in these loops, due to the shift which will reduce the mean density of ions, the slight separation of the D^+ and T^+ ions, the trapped orbits and the residual bootstrap current, the fusion rate will be supposed reduced compared to the fusion rate on the straight pipes ("AD" and "BC" on the [figure 1](#)).

Consequently, it will be made the following (probably penalizing) hypothesis: "In the loops, the fusion rate will be considered as equal to the half of the one in the straight pipes".

Consequently, the straight pipes must be the longest possible compared to the two half-torus.

If it is considered that the fusion rate in L_f (equivalent length for fusion) is the same as the one in the straight pipes, then $L_f = P \times \left(\frac{1+\mu}{2}\right)$ with P the "0" perimeter (see [§5.3.2](#))

As we supposed that $\mu=0.6$ (see [§5.3.2](#)), the reduction coefficient $\left(\frac{1+\mu}{2}\right)$ is equal to 0.8 and $L_f = 0.8 \times P$

Note that the Multiplasma simulator is not able to simulate the entire "0" figure but only a straight pipe.

APPENDIX D

Equilibrium of ions energy under Coulomb collisions

According to the reference [7] page 52, for a collision between two particles (here D⁺→T⁺), the energy ΔED, lost or won by the D⁺ ion, is equal to (both forms being equivalent):

$$\Delta ED = -\frac{(mD \times \mathbf{VD} + mT \times \mathbf{VT})}{(mD + mT)} \times \frac{mD \times mT}{mD + mT} \times (1 - \cos \theta) \times (\mathbf{VD} - \mathbf{VT})$$

$$\Delta ED = -\frac{mD \times mT}{(mD + mT)^2} \times (1 - \cos \theta) \times [2 \times ED - 2 \times ET + (mT - mD) \times (\mathbf{VT} \times \mathbf{VD})]$$

With mD and mT the respective masses of the D⁺ and T⁺ ions.

With \mathbf{VD} and \mathbf{VT} the respective speed vectors of the D⁺ and T⁺ ions.

Θ is the scattering angle (in the center-of-mass frame).

Note that:

- $\langle 1 - \cos(\theta) \rangle$ (mean value of $(1 - \cos(\theta))$) is equal to about 0.1, after several calculations.
- when D⁺/T⁺ ions collide, small scattering angles (Θ < 45°) are the most probable. With $\langle 1 - \cos(\theta) \rangle = 0.1$, the mean angle is equal to 26°.

Now let's suppose that ions are not thermalized which is the state of ions when they are injected. So ions collide in an almost perfect collinear way, or let's say with a weak radial speed. D⁺ and T⁺ are going to collide in strict opposition.

From the first form, " $\mathbf{VD} - \mathbf{VT}$ " cannot be equal to 0, because VD and VT are opposed along the pipe axis. So necessarily to get ΔED→0 at equilibrium, $mD \times \mathbf{VD} + mT \times \mathbf{VT} \rightarrow 0$, which gives $mD \times \mathbf{VD} = -mT \times \mathbf{VT}$ or $VD = -3/2 \times VT$. So, at equilibrium (ΔED = ΔET = 0), these particles will tend to stay at $ED = 3/2 \times ET$. This behavior, by forcing trajectories to stay axial, has been confirmed by simulation. However, as it is not possible to avoid thermalization, this behavior occurs only with the first collisions. It can be neglected. Note that in this configuration, the laboratory frame and the center-of-mass frame would be confused.

After several Coulomb collisions, the ions trajectories will also have a radial part. This thermalization of speeds will progressively takes place until the mean quadratic speed in each direction reaches 1/√3 of the initial speed (complete thermalization).

In that case, the term $mD \times \mathbf{VD} + mT \times \mathbf{VT}$ cannot be nil (or by coincidence).

Now let's suppose, that particles are thermalized. They will continue to collide but with a spectrum of center-of-mass energies (Ecom).

For elevated Ecom, all the orientations between the particles trajectories are possible with about the same probability so the scalar product $\mathbf{VD} \times \mathbf{VT} = 0$, and the particles will tend to share the same energy (ED=ET, from the second form).

For small Ecom, the D/T speed magnitudes and trajectories are close. So the collisions will tend to get ΔED=0 by equaling \mathbf{VD} and \mathbf{VT} , so that $\mathbf{VD} - \mathbf{VT} = 0$ from the first form. $|\mathbf{VD}|=|\mathbf{VT}|$ leads energies, at equilibrium, towards $ET=3/2 \times ED$.

However the probability of collisions is proportional to $1/(Ecom)^2$, so collisions at elevated Ecom are much less probable than the ones at weak Ecom. Consequently, the global behavior tends to $ET=3/2 \times ED$.

Several simulations have been done, with different initial ratios between ED and ET (ET=2/3 ED, ED=ET, ET=3/2 ED). In all cases, the final ET/ED ratio is about 1.45 (i.e. ET=1.45 ED), so very close to 1.5, as expected.

Note that the final equilibrium being obtained around ET=1.45 ED, the D⁺/T⁺ injection will be done with a ET/ED ratio of 1.5 to simplify the configuration, so $\mathbf{VD} = -\mathbf{VT}$ initially.

To simplify, this ratio of 1.5 will be supposed kept all along the permanent working, so as to have $\langle \mathbf{VD}^2 \rangle = \langle \mathbf{VT}^2 \rangle$.

8 References

- [1] "A general critique of inertial-electrostatic confinement fusion systems » by Todd H. Rider
Physics of Plasmas 2, 1853 (1995); <https://aip.scitation.org/doi/10.1063/1.872556>
- [2] "Fundamental limitations on plasma fusion systems not in thermodynamic equilibrium » by Todd Harrison Rider
Physics of Plasmas 4, 1039 (1997); <https://dspace.mit.edu/handle/1721.1/11412?show=full>
- [3] Book "Project Sherwood – The U.S. program in controlled fusion » by Amasa S. Bishop, edited by Anchor Books, 1960
- [4] Article "Usefulness of the magnetic « corkscrew » for particles beams" Rev. C by P. Lindecker.
http://f6cte.free.fr/Usefulness_of_the_magnetic_corkscrew.pdf
- [5] S. Chen, S. Atzeni, T. Gangolf, M. Gauthier, D. Higginson, et al.. Experimental evidence for the enhanced and reduced stopping regimes for protons propagating through hot plasmas. Scientific Reports, Nature Publishing Group, 2018, 8, pp.14586. 10.1038/s41598-018-32726-2. hal-01899151
<https://hal.sorbonne-universite.fr/hal-01899151/document>
- [6] "Bethe formula" https://en.wikipedia.org/wiki/Bethe_formula
and "Formule de Bethe" https://fr.wikipedia.org/wiki/Formule_de_Bethe by Wikipedia
- [7] Book « Plasmas collisionnels » by Michel Moisan and Jacques Pelletier, edited by EDP sciences, 2014
- [8] "Larmor formula" https://en.wikipedia.org/wiki/Larmor_formula by Wikipedia
- [9] « Rayonnement continu de freinage » https://fr.wikipedia.org/wiki/Rayonnement_continu_de_freinage by Wikipedia
- [10] Book « Physique des tokamaks » by Jean-Marcel Rax, edited by Editions de l'Ecole Polytechnique, February 2011
- [11] Article "Electrostatic lens sizing" Rev. C by P. Lindecker.
http://f6cte.free.fr/Electrostatic_lens_sizing_Rev_C.pdf
- [12] "Stellarator" <https://en.wikipedia.org/wiki/Stellarator> by Wikipedia
- [13] "Propulsion spatiale" https://fr.wikipedia.org/wiki/Propulsion_spatiale by Wikipedia
- "Fusion" Internet pages of the author:
- in English, http://f6cte.free.fr/multiplasma_english.htm
 - in French, http://f6cte.free.fr/multiplasma_francais.htm