

A two-part Seabed Geomorphology classification scheme: (v.2)

PART 1: MORPHOLOGY FEATURES GLOSSARY

October, 2020

Dove, D., Nanson, R., Bjarnadóttir, L.R., Guinan, J., Gafeira, J., Post, A., Dolan, M.F.J., Stewart, H., Arosio, R., Scott, G.

OPEN REPORT PREPARED BY THE MIM-GA GEOMORPHOLOGY WORKING GROUP

DOI: 10.5281/ZENODO.4071940

PART1: MORPHOLOGY FEATURES GLOSSARY

OPEN REPORT (October, 2020)

Authors: Dove, D.¹, Nanson, R.², Bjarnadóttir, L.R.³, Guinan, J.⁴, Gafeira, J.¹, Post, A.², Dolan, M.F.J.³, Stewart, H.¹, Arosio, R.⁵, Scott, G.^{4*}

¹ British Geological Survey (BGS), Edinburgh, UK – dayt@bgs.ac.uk, jdlq@bgs.ac.uk, hast@bgs.ac.uk

² Geoscience Australia (GA), Canberra, Australia - Rachel.Nanson@ga.gov.au, Alix.Post@ga.gov.au

³ Geological Survey of Norway (NGU), Trondheim, Norway - Lilja.Bjarnadottir@NGU.NO, Margaret.Dolan@ngu.no

⁴ Geological Survey Ireland (GSI), Dublin, Ireland – janine.quinan@gsi.ie, *formerly affiliated

⁵ Centre for Environment, Fisheries, and Aquaculture Science (Cefas), Lowestoft, UK - riccardo.ariosio@cefas.co.uk

Summary

This report updates the ‘Two-part Seabed Geomorphology classification scheme’ of Dove et al. (2016) and presents a new glossary (*Part 1*) of Seabed Morphology features. This Morphology glossary is intended to provide marine scientists with a robust and consistent way to characterise the seabed. Each glossary entry includes a feature definition and a representative schematic diagram to support clear and accurate classification. Feature terms and definitions are primarily drawn from the International Hydrographic Organization (IHO) guide for undersea feature names, which are herein modified and augmented with additional terms to ensure the final feature catalogue and glossary encompasses the diversity of morphologies observed at the seabed, while also minimising duplication and/or ambiguity. This updated classification system and new glossary are the result of a collaboration between marine geoscientists from marine mapping programmes/networks in Norway (MAREANO), Ireland (INFOMAR), UK (MAREMAP), and Australia (Geoscience Australia) (MIM-GA). A subsequent report will present the (*Part 2*) Geomorphology feature glossary.

Introduction and Background

Increasing activity in the Blue Economy, as well as efforts to better understand, manage, and conserve marine ecosystems, is driving national-scale (e.g. MAREANO in Norway - <https://www.mareano.no/en>, INFOMAR in Ireland - <https://www.infomar.ie/>, Aus Seabed in Australia - <http://www.ausseabed.gov.au/>), regional (e.g. EMODnet, 2018), and global efforts (e.g. Seabed 2030 – Mayer et al. (2018)) to map the seafloor. These initiatives are producing large volumes of high-resolution seafloor data that support the development of morphologic (spatial scale, shape, configuration through bathymetric analyses) and geomorphological (surface and subsurface analyses) mapping products. These geospatial products: 1) improve our understanding of the often complex range of environmental processes that are recorded at the seabed; enhance our knowledge of the physical properties of the seabed and shallow sub-surface, which in turn underpins the geotechnical use of the seabed; and 3) aid predictions of future change and impacts for a range of marine interests (e.g. habitats and ecosystems, coastal change, geohazards, resource development) (Micallef et al., 2018).

The first global geomorphology map of the ocean floor was presented by Harris et al. (2014), who utilised a Shuttle Radar Topography Mission (SRTM) derived bathymetry grid. Their digital compilation of broad-scale features (>10 km²) has proved an important resource for progressing marine ecosystem science (e.g. Bar-On et al., 2018; Clarao et al., 2020), for better understanding deep-sea mineral resources (e.g. Petersen et al., 2016), and for informing marine policy and management (e.g. Fernandez-Arcaya et al., 2017; Wright et al., 2019). The utilisation of their global-scale product also lends support to more detailed, regional mapping initiatives that are increasingly supported by higher spatial-resolution mapping datasets. As demonstrated by Harris et al. (2014) and Micallef et al. (2018), and as continuously re-affirmed by the habitat mapping community (e.g. Harris and Baker, 2020; Dove et al., 2020), understanding and characterising the geomorphology of the seafloor is a key activity that benefits a range of marine science disciplines and stakeholders.

With the proliferation of regional and location-specific mapping initiatives, many researchers will naturally develop customised analysis tools and approaches to describe and classify the geomorphology in their

areas of interest. While the science is progressed by such innovation, there is also clear demand for standards to ensure consistency between mapping regions (i.e. need for stocktake, and synthesis of clearly defined terms).

Recognising the value in the systematic approach employed by Harris et al. (2014), Dove et al. (2016) developed a two-part classification scheme to enable the consistent and standardised classification of seabed geomorphology, including smaller, finer-scale features that are observed in high-resolution bathymetry datasets. One novel aspect of the 'two-part' approach was to characterise features according to two semi-independent classification schemes: 1) Morphology, and 2) Geomorphology (Fig. 1). Morphology features are those characterised by the surface (seabed) expression of their physical attributes (i.e. size, shape, configuration, texture); Geomorphology features are defined by the environmental process(es) that created that morphology. As such, 'Morphology' provides the fundamental objective physical description of the feature(s), whereas 'Geomorphology' requires an interpretation of the genesis of the feature(s). This interpretive analysis by a mapping scientist(s) necessarily increases uncertainty in the mapping product, however it also adds value by providing further information and context to the features and/or areas of interest. Also, this uncertainty may be minimised by incorporating further seafloor (e.g. ground-truthing samples) and subsurface (e.g. seismic and sub-bottom profiler data) datasets into the geomorphological analysis (Fig. 2a). Using this two-part scheme, it is intended that all features mapped are assigned a 'Morphology' class but are only assigned a 'Geomorphology' class when the mapping scientist(s) has justification for their interpretation of the feature(s) origin. Dove et al. (2016) provide further details on the applications of this 'Two-part' approach.

Development of the Morphology features glossary

Here we present a new glossary of Morphology features, constituting v.2 of the Two Part Classification scheme for Seabed Geomorphology. This report thereby provides an update to the Morphology (Part 1) component only (Fig. 1). MIM-GA are in the process of preparing glossary entries for the Geomorphology terms (Part 2), and these will be presented in a subsequent report.

The new glossary includes: (1) a definitive list of feature names; (2) a definition for each feature (primarily modified from IHO (2019)); (3) representative diagrams for each feature, and; (4) an easy-lookup comparison between the profiles of each feature type. This glossary is primarily the result of collaborations within the MIM-GA partnership, but is also motivated by feedback from the Seafloor Geomorphology Workshop at the GeoHab – 2019 conference (co-ordinated by MIM-GA and local hosts in St. Petersburg) (Dove et al., 2020). It was recognised at the workshop that beyond the structured list of terms from v.1 of the classification scheme, feature definitions and representative diagrams would provide further clarity and specificity.

In this version (v.2) we have amended the original list of Morphology terms via the removal and addition of several features (see below). The overarching structure and hierarchy has also been slightly modified in v.2. These modifications were made to minimise duplication and/or ambiguity between terms (e.g. 'Depression' vs. 'Basin'), and to remove inference of geomorphic origin for some terms. For example, the term 'Wave/Dune' from v.1 can be classified as 'Ridge' (attributes: *smooth, curvilinear*) in v.2 of the 'Morphology' scheme, thereby removing the connotation of flow-induced formation. The process/origin aspects are covered in the separate 'Geomorphology' scheme, where their interpretation will also be attributed (e.g. 'palaeodune') (Fig. 2b).

Changes to list of Morphology features between v.1 (Dove et al., 2016) and v.2 (this report)

- **Added:** Centreline, Cone, Crest, Hummock;
- **Removed:** Bar, Basin, Deep, Dome, Furrow, Levee, Patch, Rise, Ripple, Scour, Sheet, Shelf, Shoal/Reef, Side-Canyon, Spur, Wave/Dune.

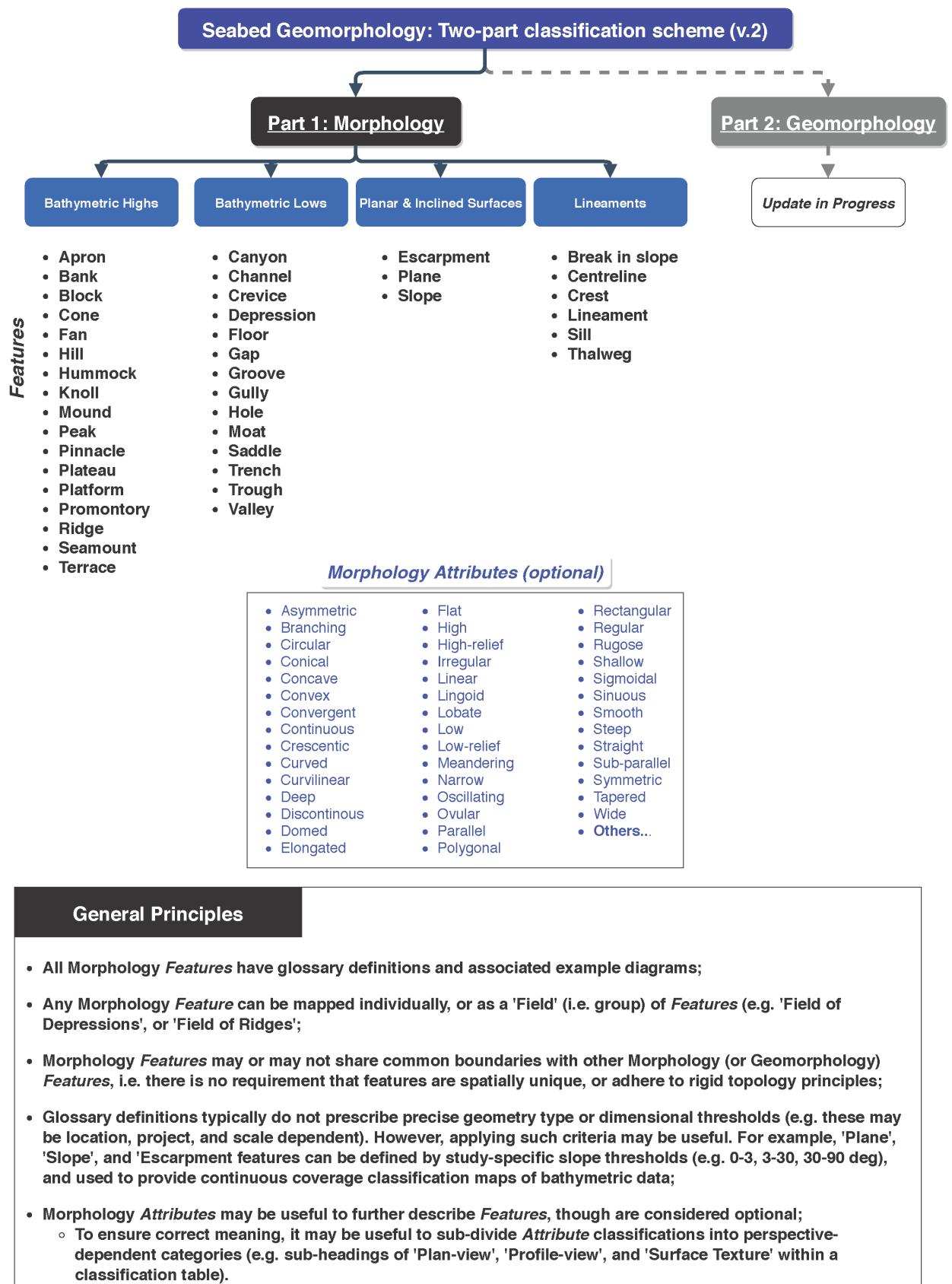

Figure 1: General structure, and feature list of the 'two-part' classification scheme (v.2), as well as 'general principles' of the classification framework.

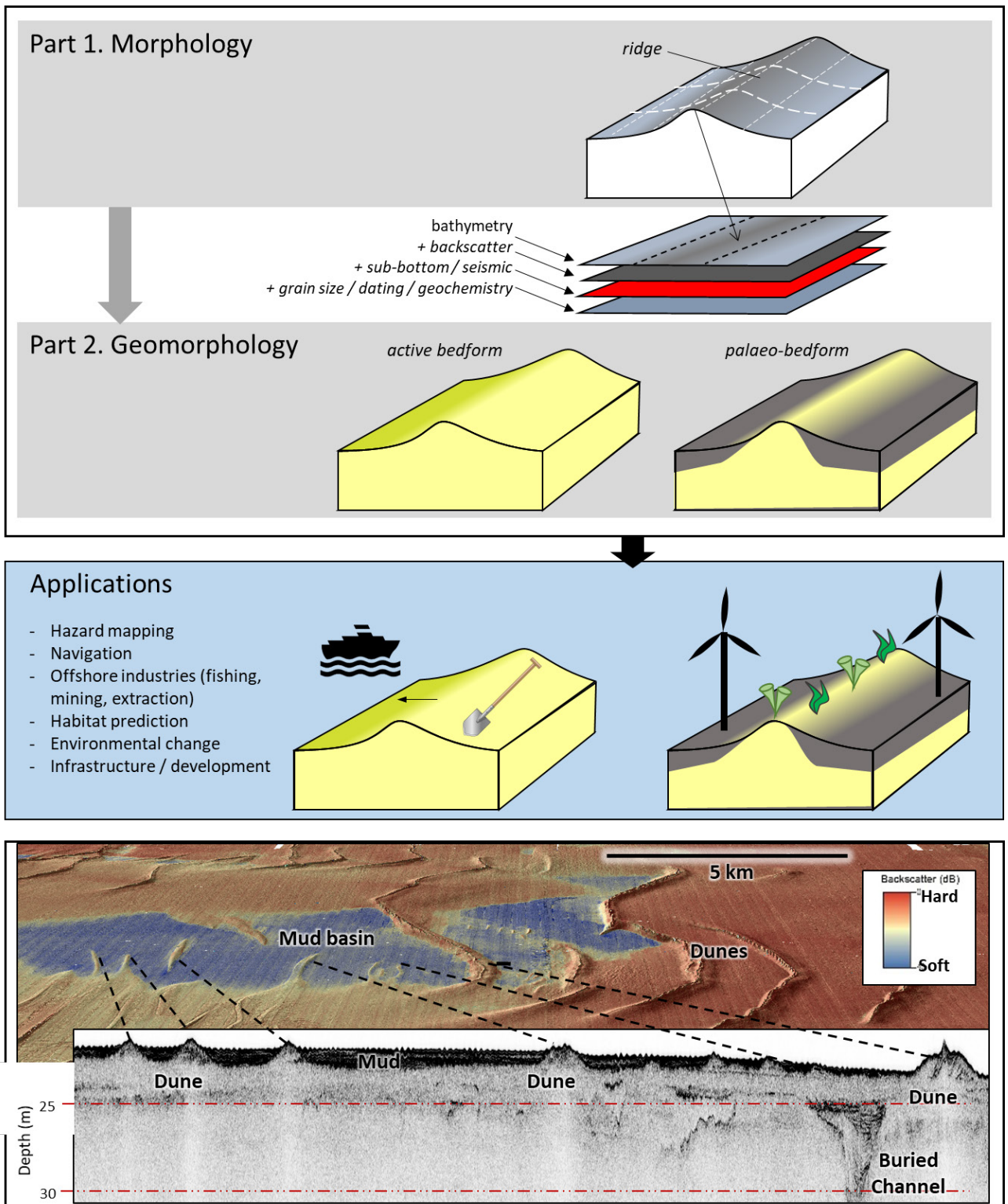

Figure 2: (A) The Morphology of the seafloor can be mapped using bathymetry data alone (Part 1 – this glossary report), however, additional data and expertise are sometimes required to extend the interpretation of these morphologies to determine their genesis and composition (Geomorphology: Part 2 – a forthcoming report). Some of the implications of different geomorphic interpretations for end user industries are illustrated (modified from Nanson and Nichol, 2018). (B) In this example from Darwin Harbour (Australia) the bathymetry revealed a series of Ridges and Depressions (Part 1 – Morphology), which may be active or relict. A subsequent sub-bottom profile through these features supported their interpretation as palaeodunes (vertical relief of approximately 1.3 m) and mud basins, respectively. Modified from Nicholas et al., (2019).

Feature definitions have been prepared with the overarching goal of describing each feature in a comprehensive way, while maintaining a concise and consistent format. Most definitions have been adapted and modified from the IHO's 'Standardization of undersea feature names' report which is regularly updated (e.g. IHO, 2019), though we have also developed several definitions from team expertise and published literature. Where we have modified definitions from IHO (2019) or Goudie (2014), we have done so to add further descriptive and discriminating detail. Figure 3 shows the cross-sections of all features, providing a general indication of the common size and shape characteristics to help distinguish between similar features.

For the most part we do not provide quantitative thresholds (e.g. size, slope, length-width ratio) to differentiate between features because these can vary according to geographic area, as well as with spatial scale. Some features also may have variable meaning, and spatial-scale connotations between disciplines (e.g. 'Trench'). By using a categorical and descriptive approach, and minimising scale-dependant definitions, this scheme is intended to provide a logical and reproducible classification framework that is applicable in diverse marine settings, for a broad range of marine disciplines. More quantitatively-based classification approaches clearly have value, offering time-efficient, continuous rule-based classification (for limited number of features) over broad spatial areas (e.g. Sowers et al., 2020). We recognise that by avoiding quantitative thresholds, this 'two-part' scheme retains an element of subjectivity, and that this is a limitation. At present however, we would argue that this is a justified trade-off because of the variable term usages between disciplines, and that approaches based on strict threshold rules often result in inaccurate delineation of features (i.e. under, or over-estimating spatial extent) across different geographic and/or survey areas, particularly for complex, aggregate, and superimposed features (which are common) (Sowers et al., 2020). It should be a continuing ambition of the seabed mapping community to develop approaches that offer unbiased and accurate classification (converging on specific, mutually exclusive definitions), but we think the classification framework and glossary presented here provide a practical and valuable resource that significantly improves on what is currently available.

Glossary entries:

Preceding the individual glossary entries, Figure 3 includes the representative cross-sectional diagrams of all Morphology Features, and is provided as a convenient look-up for rudimentary contrasting/comparing between Features. Following the glossary entries, Figure 4 illustrates the Morphology Attributes, which optionally may be used to further specify Feature morphology. Each glossary entry comprises three elements: 1) Feature Name, 2) Feature Definition, and 3) Representative Diagram

- **Feature Name:** The name of the Morphology FEATURE (e.g. RIDGE), which is always capitalised;
- **Feature Definition:** All FEATURES have a definition; some features also include further explanatory text in italics (e.g. to discriminate between other similar features);
- **Representative Diagram:** Profile and plan-view diagrams to illustrate key characteristics and their stylised form.
 - Profile (i.e. cross-sectional) schematics (top) symbolise the FEATURE location/extent with a bold line;
 - Plan-view schematics (bottom) show the lateral extent of an example FEATURE: contour lines are symbolised by small dashed lines, and the location of cross-sectional profile (e.g. A-A') are indicated by a larger dashed line.

Planar surfaces, inclined surfaces and lineaments

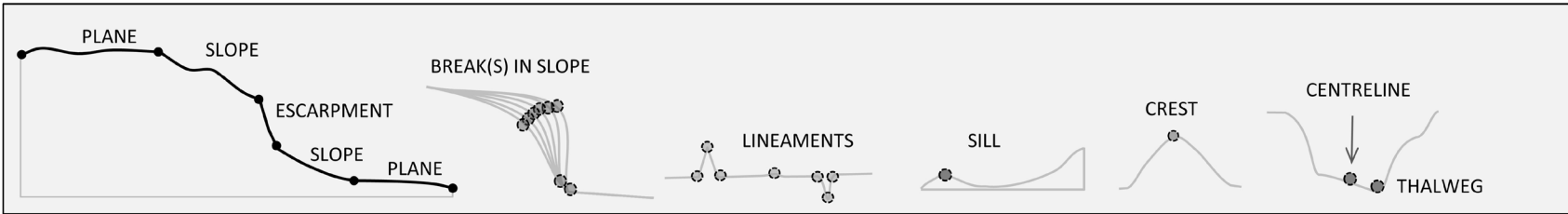

Highs

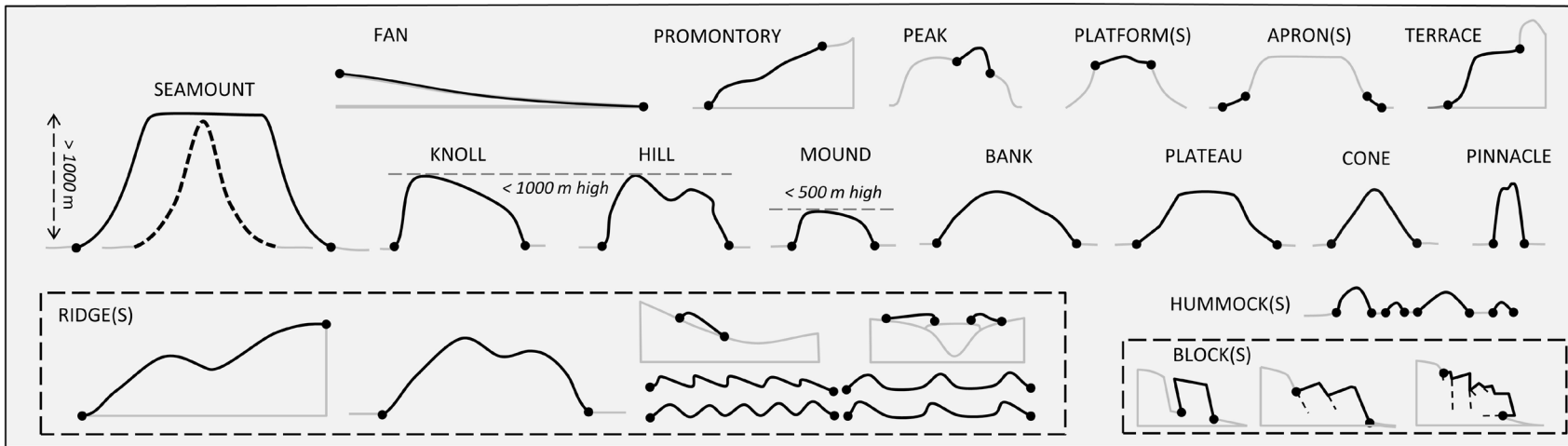

Lows

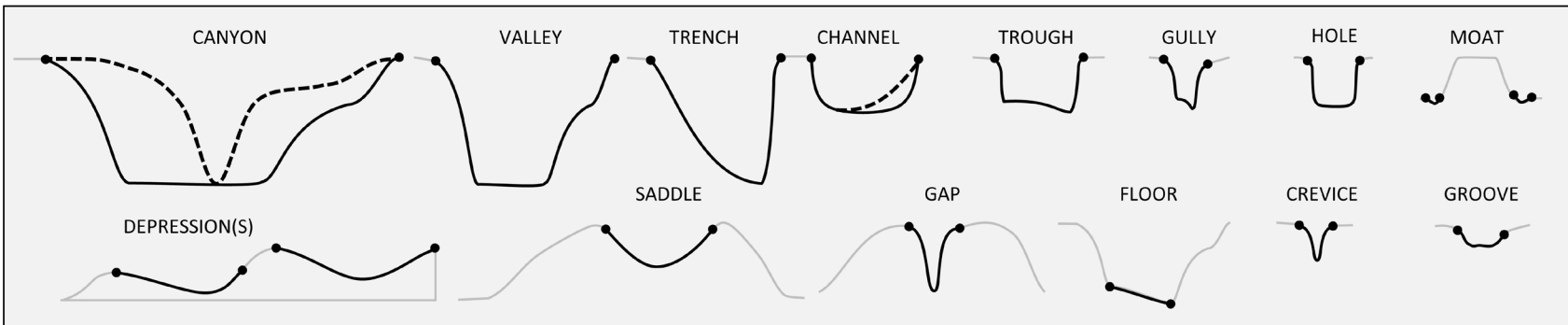
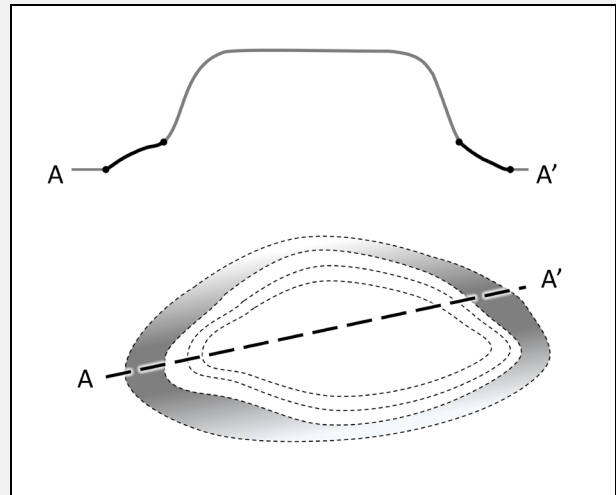

Figure 3: Representative cross-sectional diagrams of all Morphology Features.

APRON

A gently dipping surface, occurring at the base of a bathymetric high, that is elevated relative to the adjacent seafloor.



BANK

An elevation of the seafloor, often found in water depths less than 200 m (adapted from IHO, 2019).

BANKS are lower elevation than SEAMOUNTS, and tend to occur in shallower water.

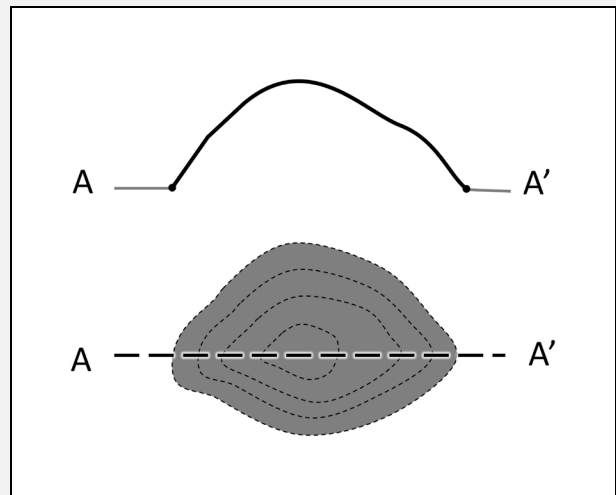

BLOCK

A discrete, usually angular mass comprising at least two relatively flat surfaces.

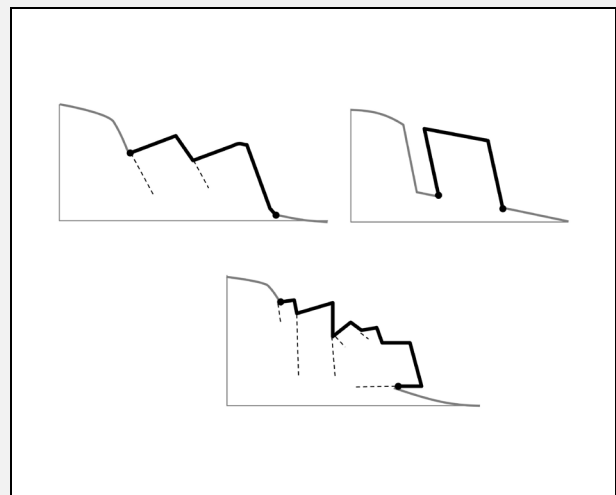

BREAK IN SLOPE

A marked and/or abrupt change in slope.

BREAK IN SLOPE can be used to define the limit of other features (e.g. SHELF, PLATFORM, ESCARPMENT).

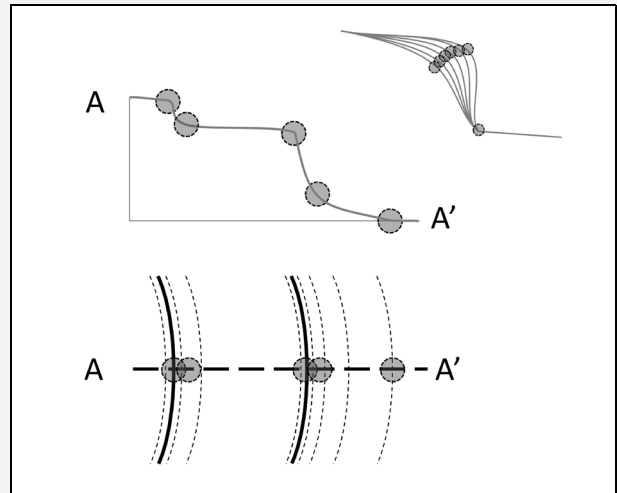

CANYON

A typically elongated, steep-sided bathymetric low that generally deepens down-slope (modified from IHO, 2019).

CANYONS tend to be higher gradient and more complex features than CHANNELS and are larger and more sinuous than GULLIES. VALLEYS tend to have a more limited depth range than CANYONS.

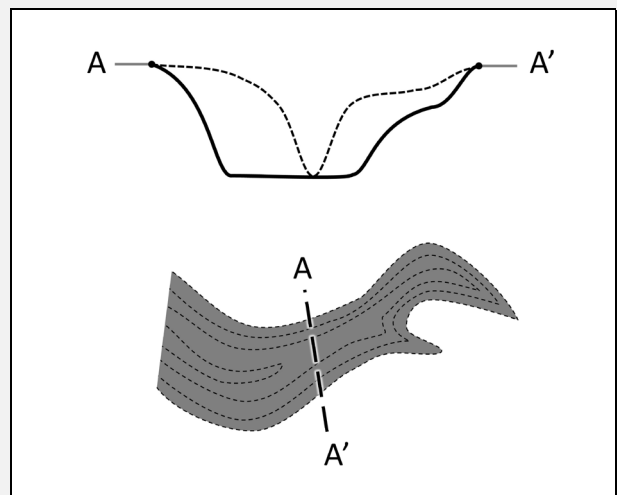

CENTRELINE

A line that represents the mid-line long axis of a feature.

Contrast CENTRELINE with THALWEG and CREST, which define the lines of lowest and highest elevation, respectively, along an elongate feature.

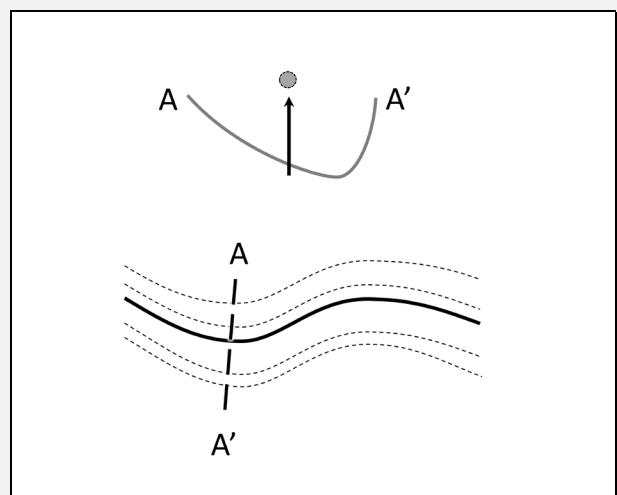

CHANNEL

A general term for an elongated bathymetric low (adapted from IHO, 2019).

CHANNELS tend to have flatter and lower gradient FLOORS than GULLIES and CANYONS, and usually have more variable cross-sections than TROUGHS.

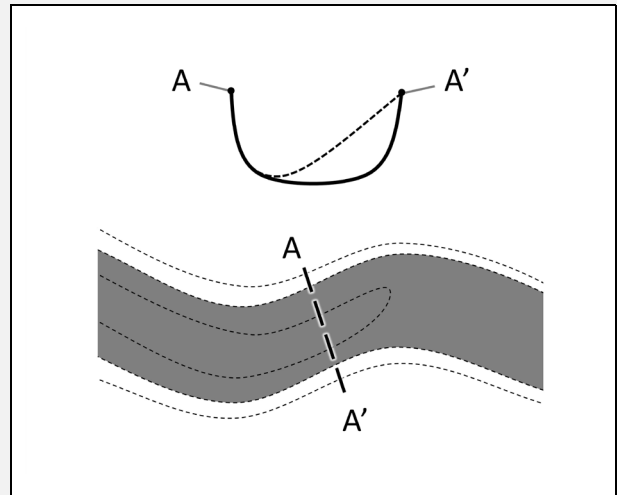

CONE

A topographic high of generally conical shape, which may have a truncated peak.

CONES have more pointed peaks and are more symmetrical than KNOLLS.

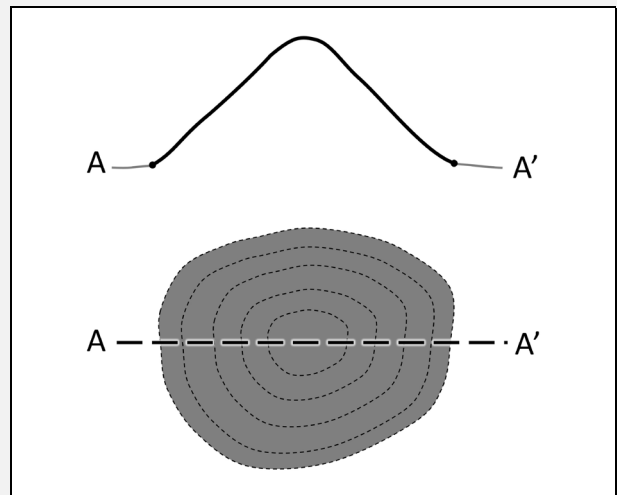

CREST

A line of highest elevation along a bathymetric high, the lateral position of which can vary longitudinally.

CRESTS contrast with CENTRELINES, which define mid-line axes along elongated features.

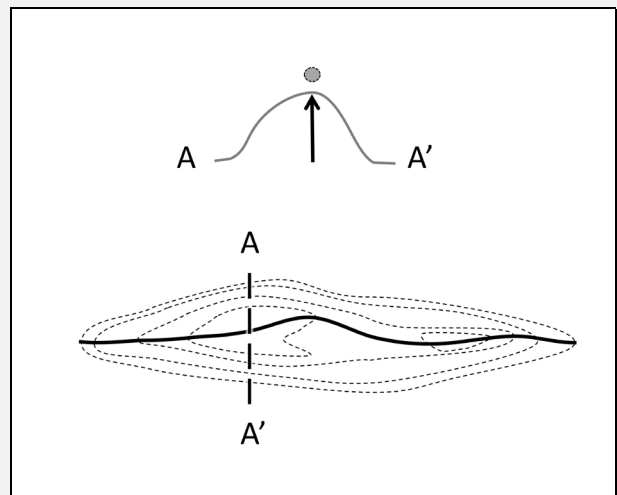

CREVICE

An elongated narrow opening (adapted from Goudie, 2014).

Unlike CANYONS, CREVICES do not necessarily deepen downslope, and unlike TROUGHS, they are not flat bottomed.

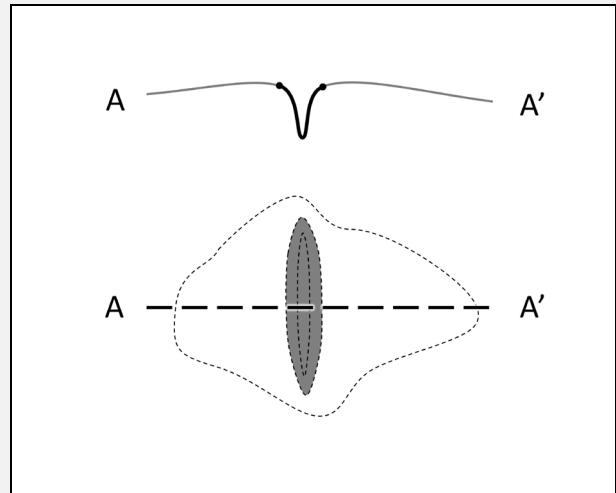

DEPRESSION

A general term for a closed-contour bathymetric low.

DEPRESSIONS vary in scale from small local features to larger basins. They generally have lower gradient sides than HOLES.

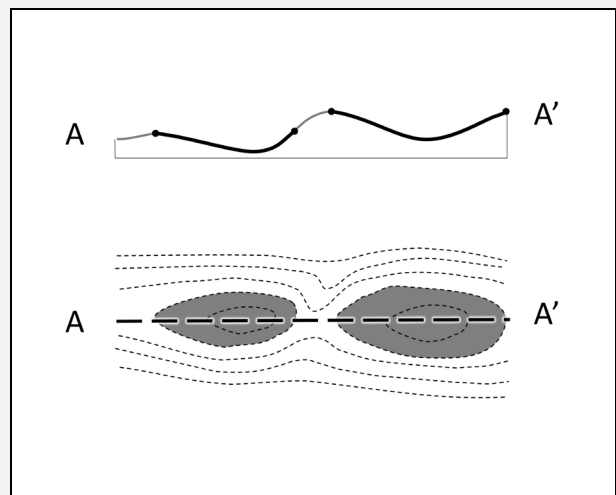

ESCARPMENT

A steep slope, separating areas of relatively lower slope (modified from IHO, 2019).

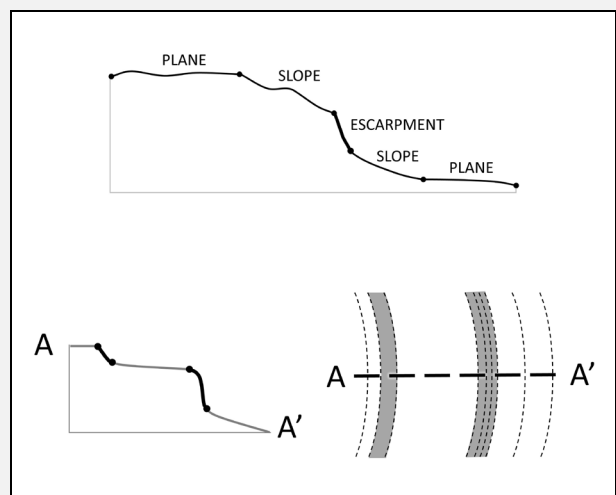

FAN

An elevated feature which expands (and typically descends) from a locus to a commonly curved outer margin.

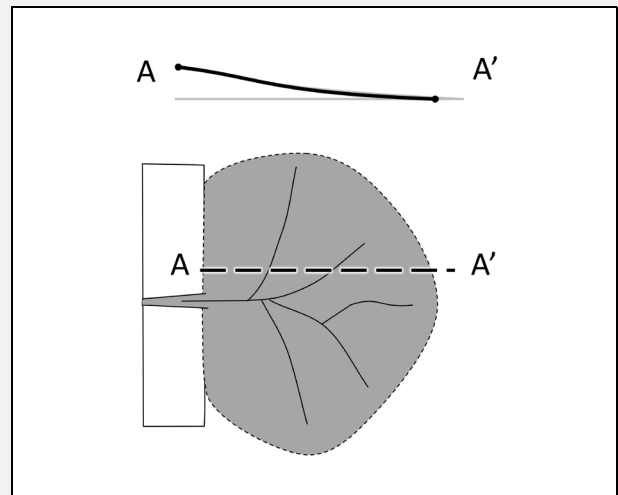

FLOOR

A relatively broad and lower gradient feature within a bathymetric low, flanked by higher and steeper gradient features.

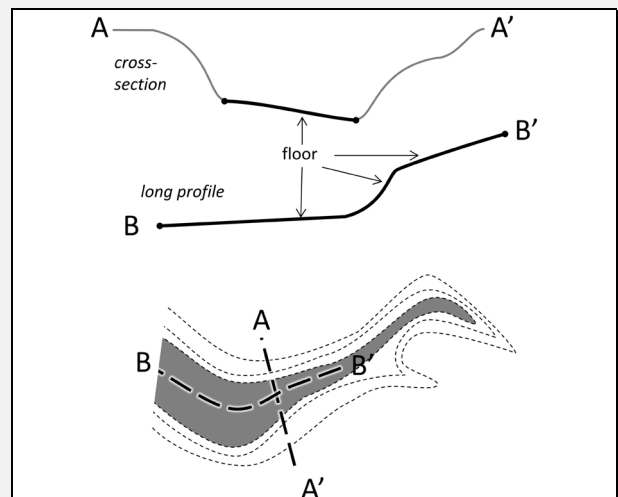

GAP

A narrow break in an elevated feature (modified from IHO, 2019).

GAPS are generally narrower than SADDLES.

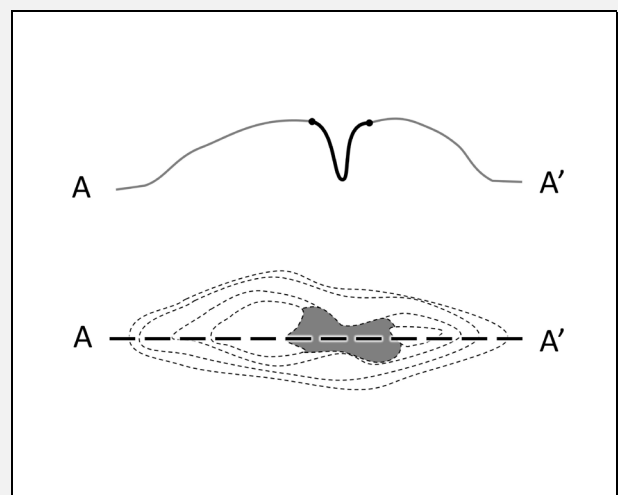

GROOVE

An elongated, narrow and relatively shallow bathymetric low which commonly occurs in parallel or sub-parallel groups.

Unlike GAPS, GROOVES are elongated features, and often occur in groups. GROOVES tend to have higher length/width ratios than CREVICES

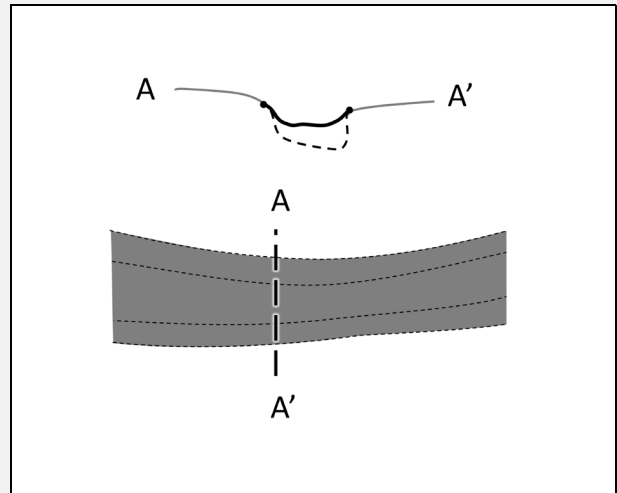

GULLY

A steep-sided, low sinuosity, relatively high-gradient channel.

GULLIES are typically smaller than CANYONS.

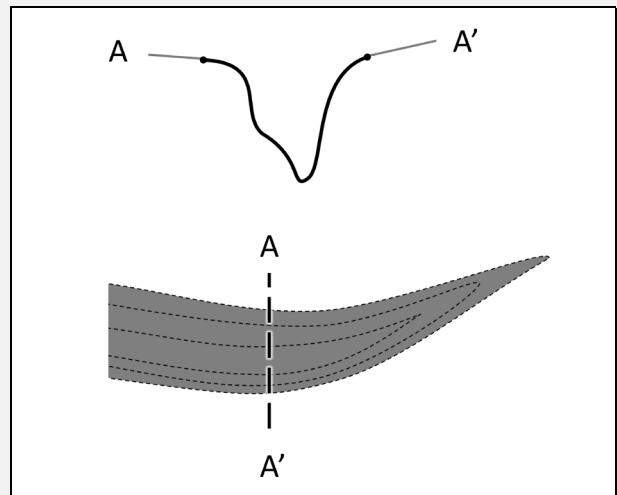

HILL

A distinct elevation generally of irregular shape, less than 1000 m above the surrounding relief as measured from the deepest isobath that surrounds most of the feature (IHO, 2019).

HILLS have more irregular profiles than KNOLLS, and their length generally exceeds their height (contrast with PEAKS). They are also smaller than SEAMOUNT, and larger than individual HUMMOCKS.

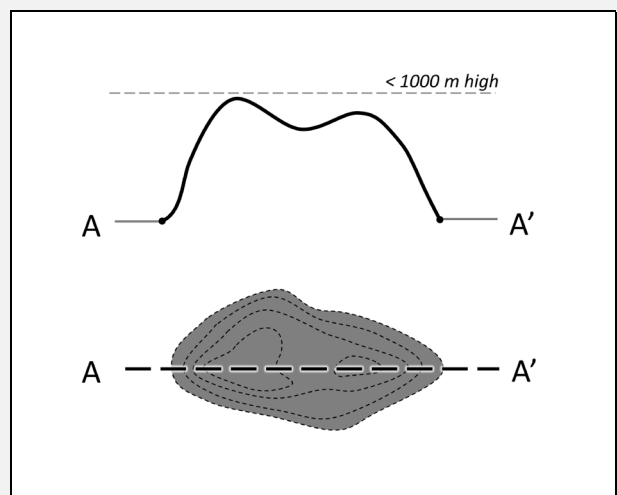

HOLE

A sub-circular (in planform) bathymetric low with steep walls and a generally flat FLOOR (modified from IHO, 2019).

HOLEs generally have steeper sides than DEPRESSIONS.

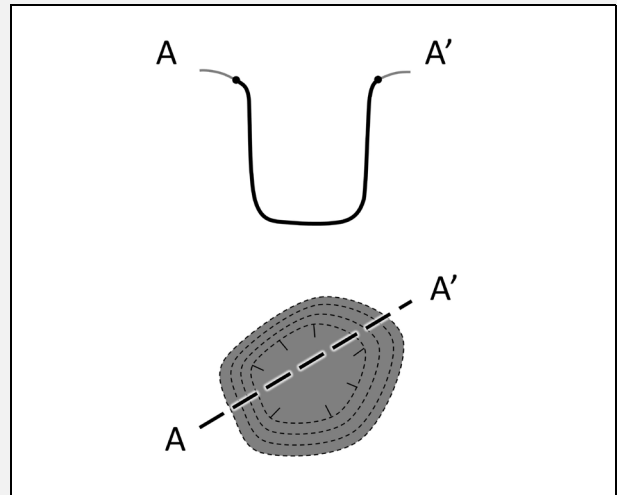

HUMMOCK(S)

A small KNOLL or MOUND, which commonly occurs in groups.

HUMMOCKs are generally smaller than KNOLLS and HILLS.

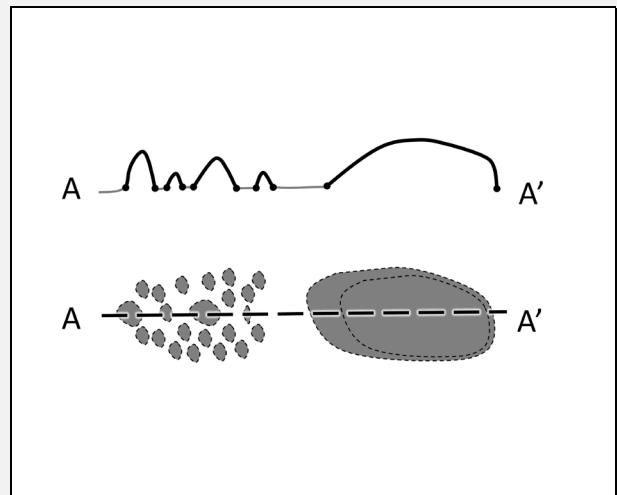

KNOLL

A distinct elevation with a smooth, commonly rounded profile, less than 1000 m above the surrounding relief (modified from IHO, 2019).

KNOLLS have more regular profiles than HILLS, and their width generally exceeds their height (contrast with PEAKS). They are also smaller than SEAMOUNTS, and larger than individual HUMMOCKS.

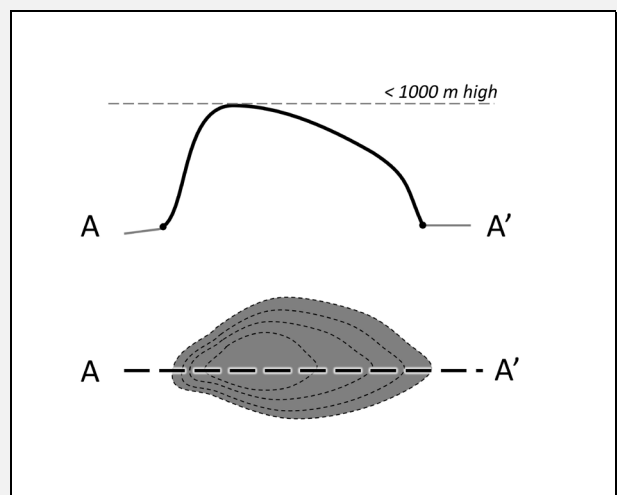

LINEAMENT

A linear to curvilinear topographic feature of positive, negative or indeterminate relief. May be discontinuous with variable relief (positive to negative) along its length.

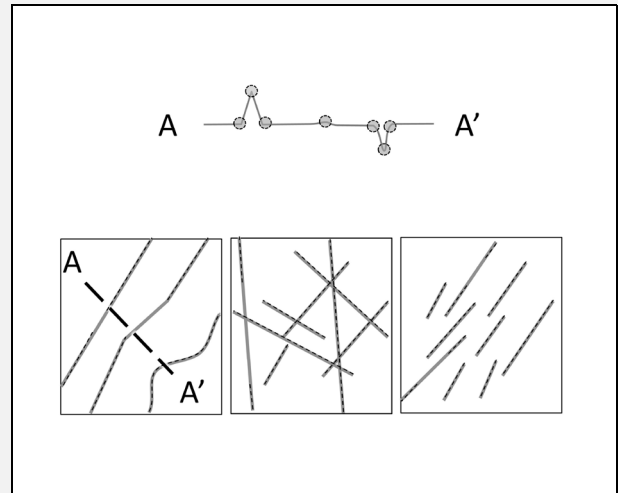

MOAT

An annular or partially annular bathymetric low typically located at the base of isolated raised features (modified from IHO, 2019).

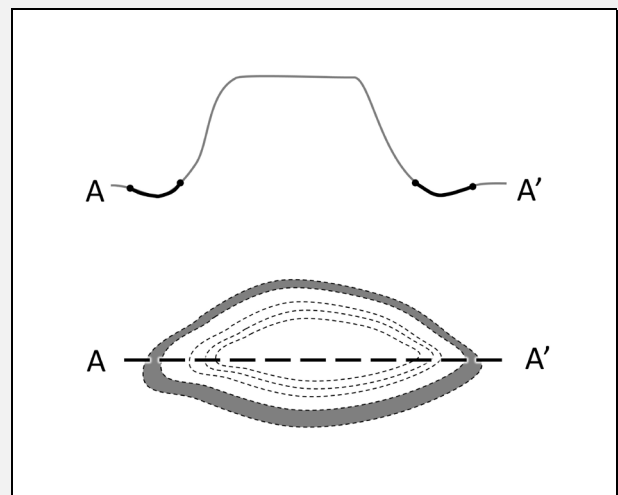

MOUND

A distinct elevation with a variable, sometimes rounded profile which is generally less than 500 m above the surrounding seafloor (modified from IHO, 2019).

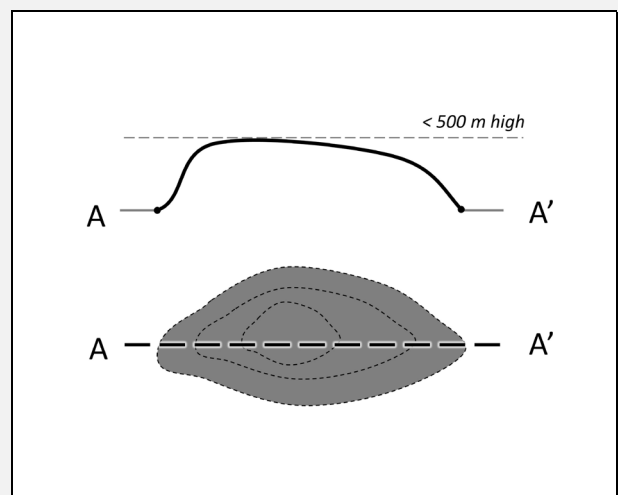

PEAK

A prominent, commonly pointed elevation rising from a larger feature (modified from IHO, 2019).

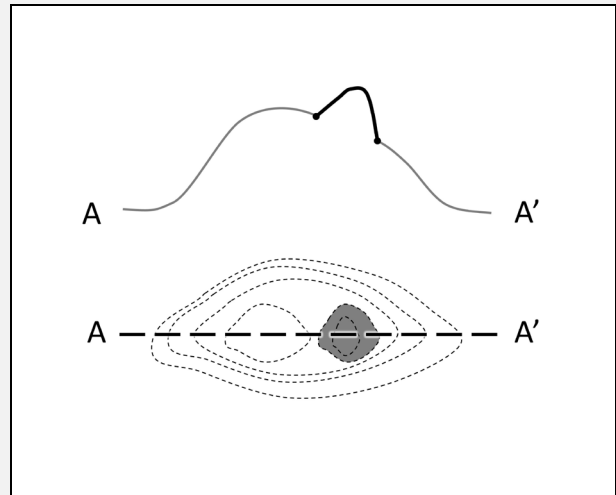

PINNACLE

A spire-shaped pillar, either isolated or rising from a larger feature (IHO, 2019).

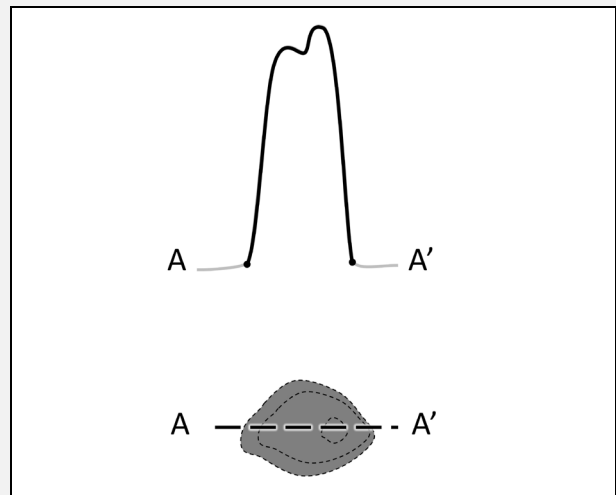

PLANE

A flat, or sub-horizontal surface.

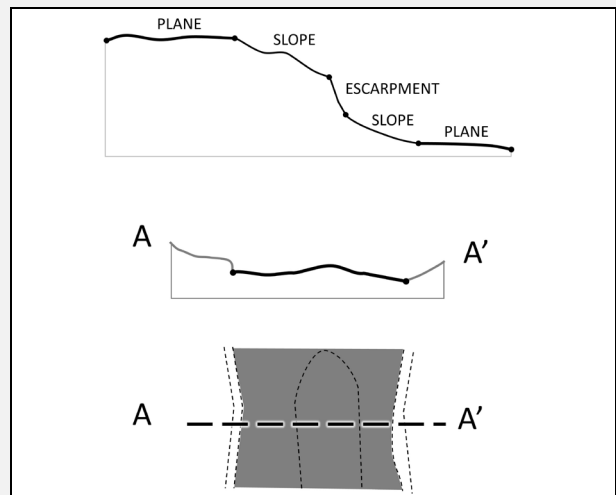

PLATEAU

A generally closed-contoured, relatively flat-topped bathymetric high with one or more relatively steep sides (modified from IHO, 2019).

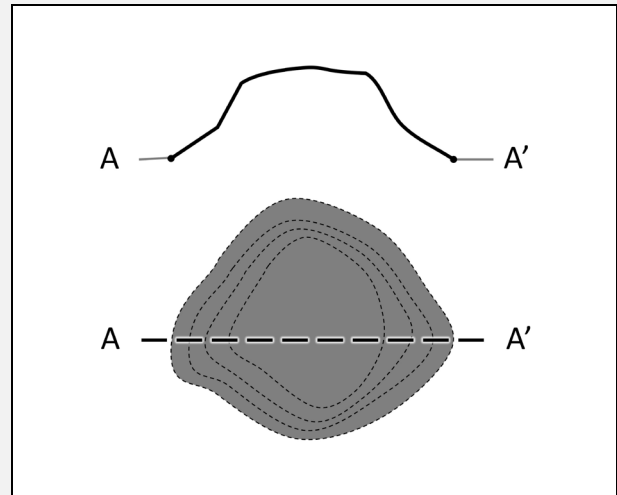

PLATFORM

A generally broad, planar surface that is at least partially elevated, and lower gradient, than the surrounding areas (adapted from Goudie, 2014).

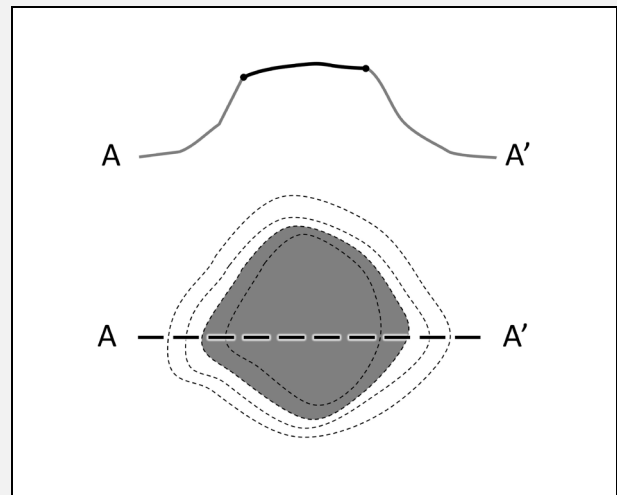

PROMONTORY

A protrusion extending from a bathymetric high into deeper water (adapted from IHO, 2019).

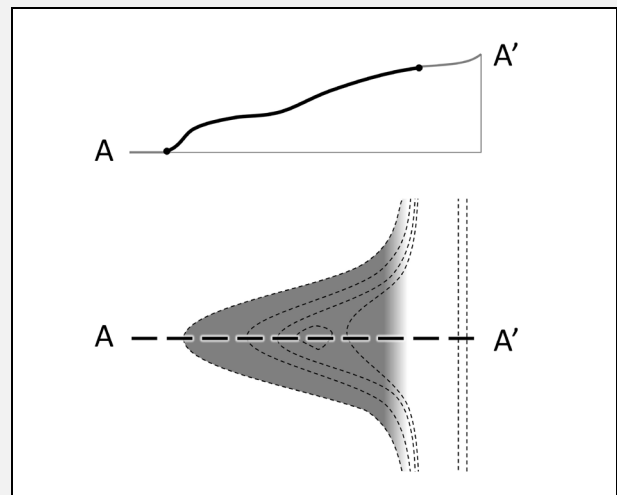

RIDGE

An elongated elevation of varying complexity, size and gradient (length > width) (modified from IHO, 2019).

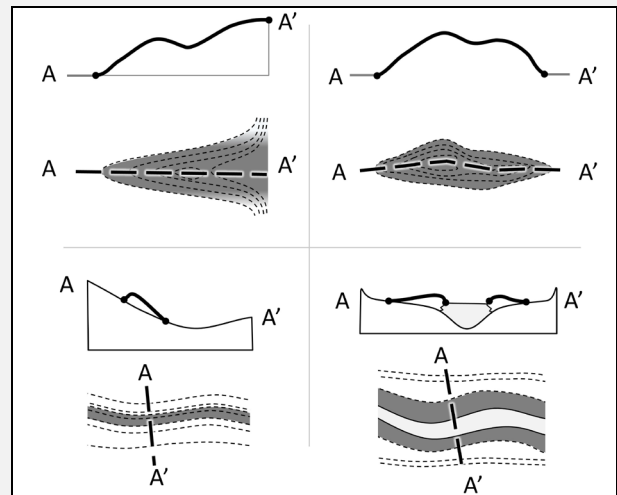

SADDLE

A broad pass in an elevated feature (modified from IHO, 2019).

SADDLES are generally broader (relative to their height) than GAPS.

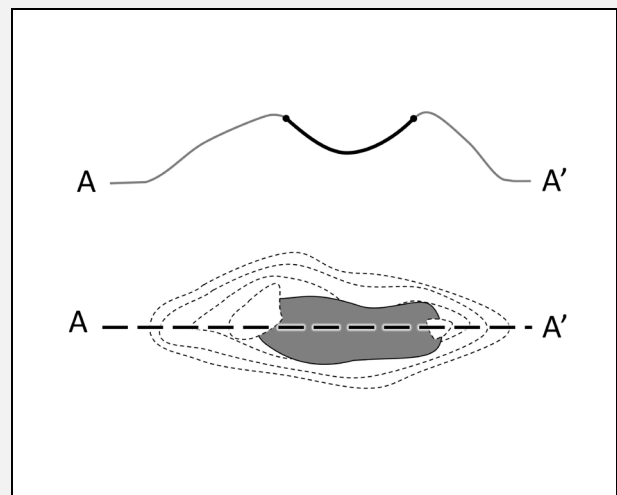

SEAMOUNT

A prominent feature rising more than 1000 m above the surrounding relief (modified from IHO, 2019).

SEAMOUNTS are larger than KNOLLS and HILLS (<1000 m) and may incorporate PEAKS (and other features).

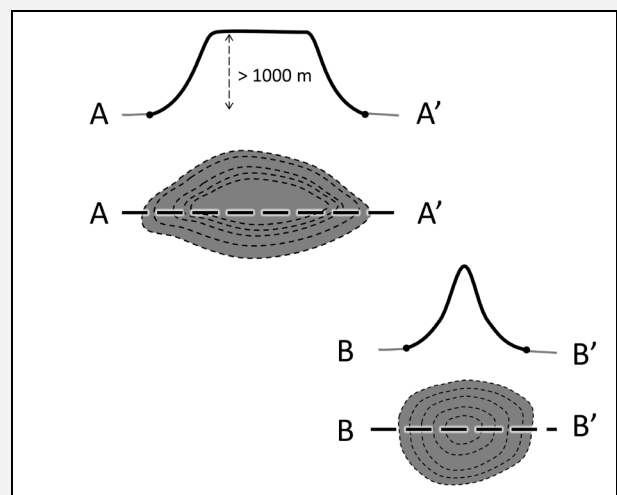

SILL

A relatively shallow elevated feature between (or adjacent to) bathymetric lows (e.g. DEPRESSIONS) (modified from IHO, 2019).

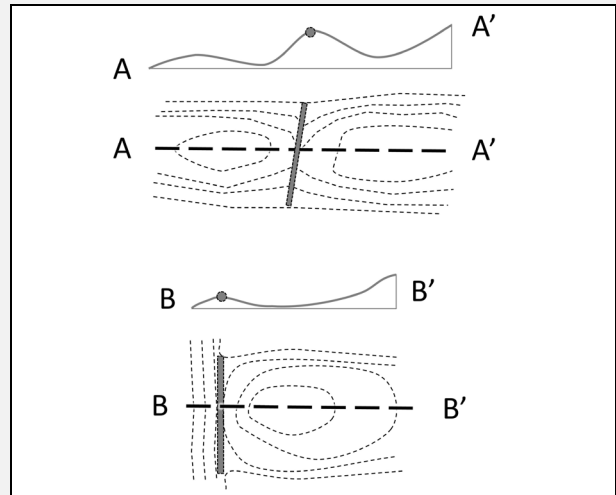

SLOPE

An inclined surface.

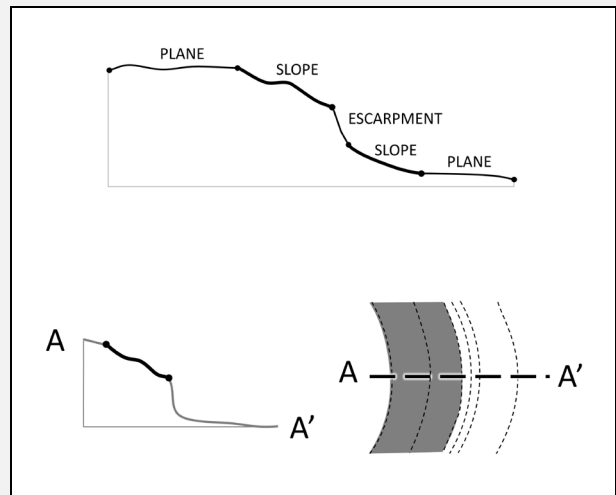

TERRACE

A generally elongated and planar feature consisting of an upper planar surface, and relatively steeper descending slope. The planar surface is bounded on one side by a steeper ascending slope (modified from IHO, 2019).

A TERRACE is not closed-contoured like a PLATEAU, and its lower-gradient surface can be mapped as a PLATFORM.

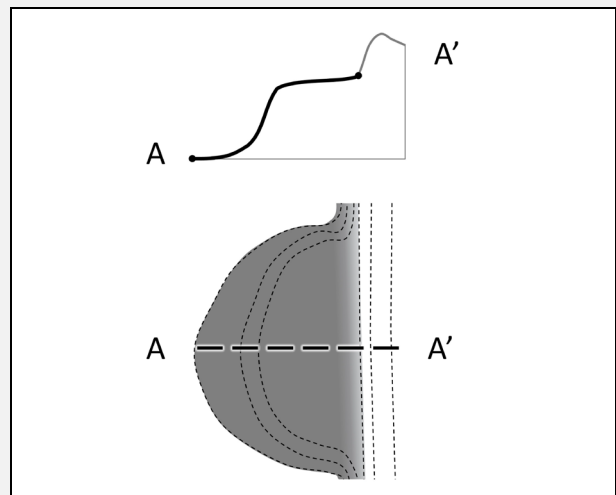

THALWEG

A line of lowest elevation along an elongate bathymetric low, the lateral position of which can vary longitudinally.

THALWEGS contrast with CENTRELINES, which define mid-line axes along bathymetric lows.

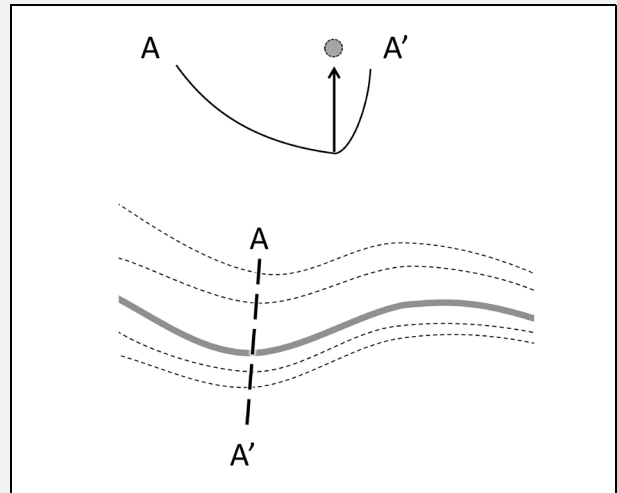

TRENCH

A long, deep, asymmetrical bathymetric low with relatively steep sides (adapted from IHO, 2019).

Unlike TROUGHS, TRENCHS are typically asymmetric in cross-section.

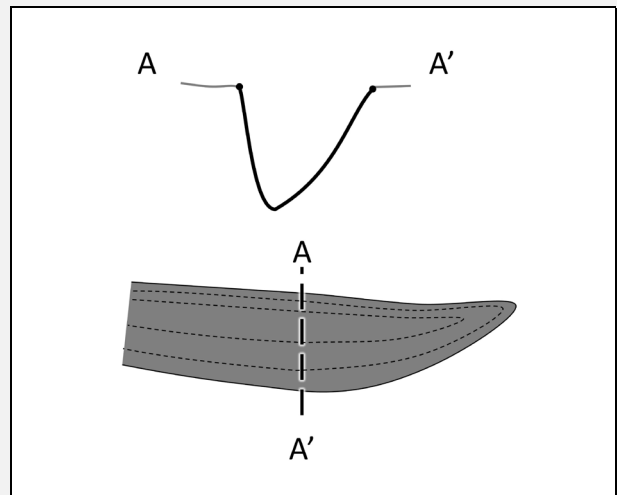

TROUGH

An elongate bathymetric low, generally wide and flat bottomed with symmetrical and sub-parallel sides (modified from IHO, 2019).

Unlike DEPRESSIONS, TROUGHS are not necessarily closed-contoured, and unlike VALLEYS, they do not always deepen down-slope.

Unlike TRENCHS, TROUGHS are typically symmetrical in cross-section.

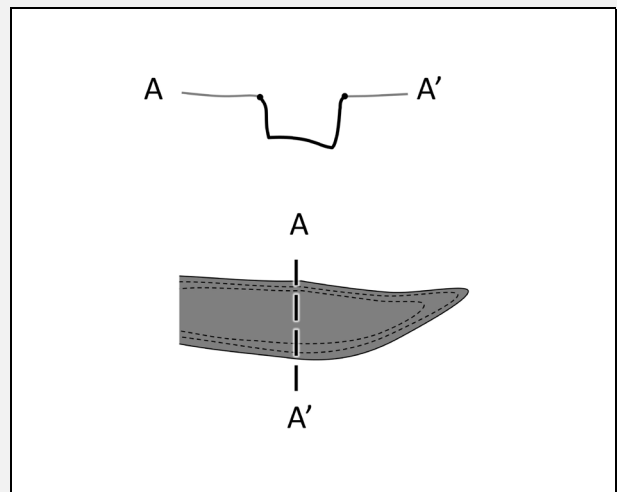

VALLEY

An elongated bathymetric low, typically occurring between prominent bathymetric highs, which generally widens and deepens down-slope (modified from IHO, 2019).

VALLEYS have more limited depth-ranges than CANYONS.

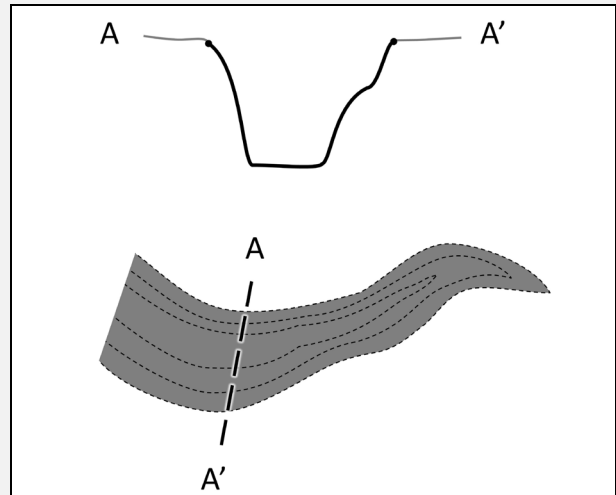

Morphology attributes (shapes)

Planform		Cross-section	
Curved		Crescentic	
Curvilinear		Circular	
Branching		Elongated	
Discontinuous		Irregular	
Linear		Lobate	
Lingoid		Ovular	
Parallel		Polygonal	
Sigmoidal		Rectangular	
Sinuuous		Tapered	
Sub-parallel			
		3D structure	
		Columnar	
		Conical	
		Domed	

Figure 4: Descriptive geometric attributes (e.g. convergent, continuous, deep, high, flat, high-relief, low, low-relief, meandering, narrow, regular, shallow, steep, straight, wide) as well as textures (e.g. oscillating, rugose, smooth) can be determined subjectively and/or calculated from the bathymetric data.

Acknowledgements

The authors of this glossary are grateful for the collective input (and multiple internal reviews of this report) by the scientists within the respective contributing agencies: MAREANO (Reidulv Bøe); British Geological Survey (Gareth Carter, Jeremy Everest, Andrew Finlayson, Jonathan Lee); Cefas (Peter Mitchell); Geoscience Australia (Scott Nichol, Kim Picard, Jodie Smith, Zhi Huang, Stephanie McLennan, and Brendan Brooke). DD, JG, and HS publish with the permission of the Executive Director, British Geological Survey (UKRI). RN and AP publish with the permission of the CEO of Geoscience Australia.

References

- Bar-On, Y.M., Phillips, R. and Milo, R., 2018. The biomass distribution on Earth. *Proceedings of the National Academy of Sciences*, 115(25), pp.6506-6511.
- Claroa, B., Pérez-Jorgeb, S. and Freya, S., 2020. Seafloor geomorphic features as an alternative approach into modelling the distribution of cetaceans. *Ecological Informatics*, p.101092.
- Dove, D., Bradwell, T., Carter, G., Cotterill, C., Gafeira Goncalves, J., Green, S., Krabbendam, M., Mellett, C., Stevenson, A., Stewart, H. and Westhead, K., Scott, G., Guinan, J., Judge, M., Monteys, X., Elvenes, S., Maeten, N., Dolan, M., Thorsnes, T., Bjarnadottir, L., Ottesen, D., 2016. Seabed geomorphology: a two-part classification system. *British Geological Survey*, Open Report OR/16/001.
- Dove, D., Bjarnadottir, L., Guinan, J., Le Bas, T., Nanson, R., Roche, M., Lecours, V., Stephens, D., Walbridge, S., Khadjinova, R., Di Stefano, M., Dolan, M., Debese, N., Jacq, J.J., Harris, P., Lamarche, G., Ryabchuk, D., 2020. Seafloor Geomorphology (GeoHab Workshop); Key Resources and Future Challenges, GeoHab-2019 Conference, St. Petersburg. *Zenodo*, <http://doi.org/10.5281/zenodo.3654320>.
- EMODnet Bathymetry Consortium (2018): EMODnet Digital Bathymetry (DTM). <http://doi.org/10.12770/18ff0d48-b203-4a65-94a9-5fd8b0ec35f6>.
- Fernandez-Arcaya, U., Ramirez-Llodra, E., Aguzzi, J., Allcock, A.L., Davies, J.S., Dissanayake, A., Harris, P., Howell, K., Huvenne, V.A., Macmillan-Lawler, M. and Martín, J., 2017. Ecological role of submarine canyons and need for canyon conservation: a review. *Frontiers in Marine Science*, 4, p.5.
- Goudie, A., 2014. Alphabetical glossary of geomorphology, version 1.0. *Electronic edition of the International Association of Geomorphologists (IAG)*.—2014.—84 p.
- Harris, P.T., Macmillan-Lawler, M., Rupp, J., Baker, E.K., 2014. Geomorphology of the oceans. *Marine Geology*, 352, pp.4-24
- Harris, P.T. and Baker, E.K., 2020. GeoHab atlas of seafloor geomorphic features and benthic habitats—synthesis and lessons learned. In *Seafloor Geomorphology as Benthic Habitat* (pp. 969-990). Elsevier.
- International Hydrographic Organization (IHO), 2019, Standardization of undersea feature names—Guidelines, proposal form, terminology (Edition 4.2.0 - Oct., 2019) Monaco, *International Hydrographic Bureau*, IHO Publication B-6.
- Mayer, L., Jakobsson, M., Allen, G., Dorschel, B., Falconer, R., Ferrini, V., Lamarche, G., Snaith, H. and Weatherall, P., 2018. The Nippon Foundation—GEBCO seabed 2030 project: The quest to see the world's oceans completely mapped by 2030. *Geosciences*, 8(2), p.63.
- Micallef, A., Krastel, S., Savini, A. (eds), 2018. Submarine geomorphology. *Springer Geology*. 556p.
- Nanson, R.A. and Nichol, S. 2018. National Seafloor Geomorphology (NSGM) mapping workshop 29th October 2018 - Summary and Actions. Distributed 19th November 2018. 12 p. www.ausseabed.gov.au/resources/publications.
- Nicholas W.A., Smit N., Siwabessy P.J.W., Nanson R., Radke I.L., Li J., Brinkman R., Atkinson R., Dando N., Falster G., Harries S., Howard F.J.F., Huang Z., Picard K., Tran M., Williams D. 2019. Characterising Marine Abiotic Patterns in the Darwin-Bynoe Harbour region: Summary report, Physical Environments, Darwin Harbour Mapping Project. *Department of Environment and Natural Resources*. Darwin, Northern Territory, Australia.
- Petersen, S., Krätschell, A., Augustin, N., Jamieson, J., Hein, J.R. and Hannington, M.D., 2016. News from the seabed—Geological characteristics and resource potential of deep-sea mineral resources. *Marine Policy*, 70, pp.175-187.
- Sowers, D.C., Masetti, G., Mayer, L.A., Johnson, P., Gardner, J.V. and Armstrong, A.A., 2020. Standardized Geomorphic Classification of Seafloor Within the United States Atlantic Canyons and Continental Margin. *Frontiers in Marine Science*, 7(9).
- Wright, G., Gjerde, K.M., Johnson, D.E., Finkelstein, A., Ferreira, M.A., Dunn, D.C., Chaves, M.R. and Grehan, A., 2019. Marine spatial planning in areas beyond national jurisdiction. *Marine Policy*.