

VTT Technical Research Centre of Finland

Sustainable District Cooling Guidelines

Calderoni, Marco; Dourlens-Qaranta, Sophie; Sreekumar, Bishnu B.; Lennard, Zia; Rämä, Miika; Klobut, Krzysztof; Wang, Zao; Duan, Xiaojian; Zhang, Yin; Nilsson, Joakim; Hargö, Lars

Published: 31/05/2019

[Link to publication](#)

Please cite the original version:

Calderoni, M., Dourlens-Qaranta, S., Sreekumar, B. B., Lennard, Z., Rämä, M., Klobut, K., Wang, Z., Duan, X., Zhang, Y., Nilsson, J., & Hargö, L. (2019). *Sustainable District Cooling Guidelines*. https://www.iea-dhc.org/fileadmin/documents/Annex_XII/2020_IEA_DHC_Sustainable_District_Cooling_Guidelines_new_design.pdf



VTT
<http://www.vtt.fi>
P.O. box 1000FI-02044 VTT
Finland

By using VTT's Research Information Portal you are bound by the following Terms & Conditions.

I have read and I understand the following statement:

This document is protected by copyright and other intellectual property rights, and duplication or sale of all or part of any of this document is not permitted, except duplication for research use or educational purposes in electronic or print form. You must obtain permission for any other use. Electronic or print copies may not be offered for sale.



INTERNATIONAL ENERGY AGENCY TECHNOLOGY
COLLABORATION PROGRAMME ON
DISTRICT HEATING AND COOLING
INCLUDING COMBINED HEAT AND POWER



SUSTAINABLE DISTRICT COOLING GUIDELINES



This project has been independently funded by
the International Energy Agency Technology Collaboration Programme on
District Heating and Cooling including Combined Heat and Power
(IEA DHC).

Any views expressed in this publication are not necessarily those of IEA DHC.
IEA DHC can take no responsibility for the use of the information within this
publication, nor for any errors or omissions it may contain.

Information contained herein have been compiled or arrived from sources
believed to be reliable. Nevertheless, the authors or their organizations do not
accept liability for any loss or damage arising from the use thereof. Using the
given information is strictly your own responsibility.



IEA DHC Operating Agent:

AGFW Projekt GmbH

Stresemannallee 30

60596 Frankfurt am Main

Germany

Phone: +49 69 630 434 4

E-mail: iea-dhc@agfw.de

© Copyright IEA DHC c/o AGFW Projekt GmbH 2019, © R2M Solution 2019, © VTT 2019, © SCUT 2019

All property rights, including copyright, are vested in IEA DHC represented by the Operating Agent for the IEA DHC Executive Committee. In 2019 AGFW Projekt GmbH (Germany) fills out that role, on behalf of the Contracting Parties of the International Energy Agency Technology Collaboration Programme on District Heating and Cooling including Combined Heat and Power. In particular, all parts of this publication may be reproduced, stored in a retrieval system or transmitted in any form or by any means, electronic, mechanical, photocopying, recording or otherwise only by crediting IEA DHC as the original source. Republishing of this report in another format is prohibited unless explicitly permitted by the IEA DHC Operating Agent in writing.

Citation:

Please refer to this report as:

Calderoni M, Babu Sreekumar B, Dourlens-Quaranta S, Lennard Z, Rämä M, Klobut K, Wang Z, Duan X, Zhang Y, Nilsson J, and Hargo L. Sustainable District Cooling Guidelines. IEA DHC/CHP Report, 2019.

Disclaimer Notice:

This publication has been compiled with reasonable skill and care. However, neither the authors nor the DHC Contracting Parties (of the International Energy Agency Technology Collaboration Programme on District Heating & Cooling) make any representation as to the adequacy or accuracy of the information contained herein, or as to its suitability for any particular application, and accept no responsibility or liability arising out of the use of this publication. The information contained herein does not supersede the requirements given in any national codes, regulations or standards, and should not be regarded as a substitute for the need to obtain specific professional advice for any particular application.

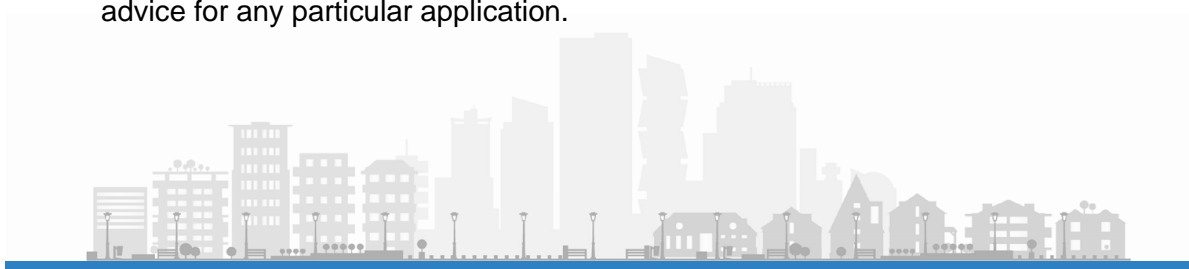

ACKNOWLEDGEMENTS

The enclosed report was co-authored by R2M Solution (www.r2msolution.com), VTT – Technical Research Centre of Finland (www.vttresearch.com), SCUT – South China University of Technology (www.scut.edu.cn/en/), and Devcco – District Energy Venture (www.devcco.se).

The responsible authors were Marco Calderoni, Bishnu Babu Sreekumar, Sophie Dourlens-Quaranta, Zia Lennard (R2M Solution); Miika Rämä, Krzysztof Klobut (VTT); Zao Wang, Xiaojian Duan, Yin Zhang (SCUT); Chapter 3 was provided by Joakim Nilsson, and Lars Hrago (Devcco).

Additional considerations, in support of the report: Ingo Wagner (EHP – EuroHeat & Power) for supporting the literature review; the INDIGO Project (www.indigo-project.eu, co-financed by the European Commission in the framework of Horizon2020 funding programme) for bringing together experts with a specific interest on district cooling; and Antonio Masoli (SIMM – società d'ingegneria Masoli Messi srl), for providing information about the neutral temperature District Heating and Cooling plant in Portopiccolo (Trieste, Italy).



INDEX

1	Introduction	13
2	Definition and benefits of District Cooling	16
2.1	Definition of district cooling.....	16
2.2	Why district cooling	17
2.2.1	Benefits of DC for the society	18
2.2.2	Benefits of DC for propriety owners/customers	18
2.2.3	Benefits of DC for energy services companies:.....	19
2.3	Sustainability assessment framework	19
3	Generic District Cooling Development Practice	24
3.1	Introduction.....	24
3.2	Development Process	24
3.3	Business Case Roadmap.....	26
3.3.1	System architecture and technology options	26
3.3.2	Initial market assessment	26
3.3.3	Stakeholder identification.....	26
3.3.4	Risks and permits identification	27
3.3.5	Identification of business models/ownership models.....	27
3.3.6	Rough order magnitude financial key-figures	28
3.3.7	Organization format	28
3.4	Feasibility Study	29
3.4.1	Development of system architecture	29
3.4.2	Sourcing and Energy balance.....	30
3.4.3	Phasing strategy	31
3.4.4	Distribution and ETS.....	32
3.4.5	Market demand development scheme.....	32
3.4.6	District cooling competitiveness versus business as usual.....	32
3.4.7	Technical and economic feasibility	33
3.4.8	Environmental impacts and permitting.....	34
3.4.9	Stakeholder analysis.....	34
3.4.10	Risk management and generic risks	34
3.4.11	Organization format.....	36

3.4.12	Business Models	36
3.5	Project Development	38
3.5.1	General	38
3.5.2	Contracting alternatives	38
3.5.3	Engineering.....	38
3.5.4	Procurement/contracting.....	39
3.5.5	Permitting.....	39
3.5.6	Financing	39
3.5.7	Developing customer concept and contracts.....	39
3.5.8	Marketing and sales.....	40
3.6	Construction	40
3.6.1	General	40
3.6.2	Key activities.....	40
3.6.3	Success factors	41
3.7	Operation.....	41
3.7.1	Continuous activities.....	41
3.7.2	Customer support and energy efficiency programs	42
4	Multi-energy sources for District Cooling systems	43
4.1	Compression chillers	44
4.2	Absorption and adsorption chillers	46
4.2.1	Absorption chillers	47
4.2.2	Adsorption chillers	48
4.3	Free cooling.....	49
4.4	Integration with heat and electricity production	50
4.4.1	Trigeneration.....	50
4.4.2	Solar cooling	51
4.4.3	Integration with renewable energy sources	52
4.5	Thermal energy storage	53
4.6	Future cooling technologies	54
5	Best practices of District Cooling systems	56
5.1	Free cooling (Seawater/river cooling).....	56
5.1.1	Zuidas International Business Hub (IBH) DC project.....	56
5.1.2	Copenhagen Opera	57

5.2	Tri-generation	59
5.3	District Cooling system with large-scale thermal storage	62
5.3.1	Cairns campus	62
5.3.2	Helsinki	64
5.4	District Cooling system with wastewater energy	66
5.4.1	Overview of Longhu Financial Centre DHC project	66
5.4.2	Major technical parameters	67
5.4.3	Environmental impacts and benefits	69
5.4.4	Evaluation of the overall experience	71
5.5	Combined District Heating and Cooling systems	71
6	Design of District Cooling systems	75
6.1	Assessing feasibility of a DC system	75
6.1.1	Necessity	75
6.1.2	Feasibility study	75
6.2	Building-level requirements for DC integration	79
6.3	Dimensioning a DC system	82
6.3.1	Cooling production	82
6.3.2	Thermal Energy storage	83
6.3.3	External connections and energy supply	86
6.3.4	Distribution network	88
6.3.5	Recommendations for ETS and cooling distribution at building level	90
6.4	Choice of refrigerants	92
6.5	Maintenance-related issues	94
6.5.1	Hardware components	94
6.5.2	Water treatment	95
7	Control, operation and maintenance of District Cooling systems	99
7.1	Control and monitoring instruments	99
7.2	Control strategies of DC systems	100
7.2.1	Basic control strategies	100
7.2.2	Advanced control strategies	103
7.2.3	Energy flexibility	104
7.3	Measuring, Reporting and Verifying framework of District Cooling system energy efficiency	105

7.4	Metering of generated and delivered cold energy, metering of consumed electricity	106
8	Quick methodology for estimating the cooling demand of a given district.....	108
8.1	Introduction.....	108
8.2	First approach based on electricity bills.....	109
8.3	Second approach based on Cooling Degree Days	111
8.4	Conclusion.....	114
9	Innovative concepts for District Cooling	115
9.1	Neutral temperature District Heating and Cooling systems.....	115
9.2	District Cooling sub systems coupled with sustainable District Heating systems nearby	117
9.3	District Cooling and District Heating combined systems	120
9.3.1	DHC system in Helsinki	120
9.4	Innovative thermal storage technologies.....	121
9.5	Demand response and flexibility services	122
9.5.1	How to implement Demand Response Strategies	123
9.6	District Cooling in 4GDH context.....	124
10	Business models for District Cooling projects	126
10.1	The District Heating and Cooling market.....	126
10.2	Ownership of DHC service providers	127
10.3	Contracting between customers and service providers.....	128
10.4	Ownership of ETS	130
10.5	Incentives framework	130
11	The role of public authorities in the District Cooling sector	133
11.1	The strategic value of District Cooling.....	133
11.2	District Cooling and Urban Planning.....	135



ABBREVIATIONS

4GDH	Fourth Generation District Heating
BAU	Business as usual
BOT	Build Operate Transfer
CAPEX	Capital expenditures
CCHP	Combined Cooling, Heating and Power
CDD	Cooling Degree Days
CEN/TC	European Committee for Standardization/Technical Committee
CFD	Computation Fluid Dynamic
CHP	Combined Heat and Power
COP	Coefficient of Performance
CSA	Customer supply agreements
DC	District Cooling
DH	District Heating
DHC	District Heating and Cooling
DR	Demand Response
DSM	Demand Side Management
DSO	Distribution System Operator
EC	European Commission
EIA	Environmental Impact Assessment
EPC	Engineer Procure Construct
ETS	Energy transfer station
EU	European Union
FTZ	Free Trade Zone Trigenation
GCC	Gulf cooperation council
GD&T	Geometric Dimensioning and Tolerancing

GHG	Greenhouse gases
GWP	Global Warming Potential
HC	Hydrocarbon
HCFC	Hydrochlorofluorocarbon
HFC	Hydrofluorocarbon
HFO	Hydrofluoroolefins
HSE	Health, safety and environment
HVAC	Heating Ventilation and Air Conditioning
IEA	International Energy Agency
IT	Information Technology
LCA	Life Cycle Analysis
LCI	Life Cycle Inventory
LCIA	Life Cycle Impact assessment
LNG	Liquefied Natural Gas
MID	Measuring Instruments Design
OPEX	Operational expenditures
PCM	Phase change material
PED	Pressure equipment design
PFC	Perfluorocarbons
PPP	Public-Private Partnerships
PRC	People's Republic of China
PV	Photovoltaic
RES	Renewable Energy Sources
RMB	Renminbi (Chinese yuan)
ROM	Rough order of magnitude
SCADA	Supervisory control and data acquisition systems

SWAC	Sea water air conditioning
TPA	Third Party Access
TSO	Transmission System Operator
UNDP	United Nations Development Programme
VRF	Variable refrigerant flow
VRV	Variable refrigerant volume



UNIT OF MEASUREMENT

dBA	Decibel Scale A
EJ	Exajoule
GW	Giga Watt
GWh	Giga Watt hour
J	Joule
kg	kilogram
kPa	Kilo Pascal
kWh	Kilo Watt hour
MW	Mega Watt
MWh	Mega Watt hour
Pa/m	Pascal per metre
RT	Refrigeration Tons
TWh	Terra Watt hour
Wh/m	Watt hour per metre



1 INTRODUCTION

'District Cooling has its roots in the early 1800s when plans were made to distribute clean, cold air to buildings through underground pipes. It is not known if these plans were actually carried out, and District Cooling was not introduced on a practical level until the Colorado Automatic Refrigerator Company was established in Denver in 1889. Many of the earlier systems used ammonia and saltwater to freeze meat and cool buildings used by the public such as restaurants, theatres etc. In the 1930s large cooling systems were built in the Rockefeller Centre in New York City and the United States Capitol buildings' [1].

A brief history of 'modern' District Cooling can be summarized using the following milestones:

1960s: first commercial District Cooling systems were installed in the USA in non-residential areas near cities.

1967: first district cooling system in Europe. Climadef began supplying District Heating and Cooling to the La Défense office complex in Paris.

1989: first District Cooling system in Scandinavia (Baerum, Oslo).

1992: Västerås Energi & Production initiated the production of District Cooling in Sweden.

1995: District Cooling was successfully established in Stockholm. In 2015, District Cooling in Sweden had an energy output of around 900 GWh [2].

Largest District Cooling systems today are operating in Asia (Singapore, Tokyo, Dubai, UAE, Qatar, Saudi Arabia), Central and Northern Europe (Stockholm, Paris, Helsinki, Vienna, Berlin, Copenhagen, Amsterdam and Barcelona) and North America (Chicago, Toronto). No information about the total number of District Cooling systems operating worldwide is available, while in Europe around 150 systems are in operation. Cold energy delivered by District Cooling systems can be estimated to some 83 TWh per year [3].

District Cooling is based on centralized production of cold water which is distributed to customers in a closed loop underground pipe network. Production can be based on various sources and technologies. Common renewable cold sources are seas, lakes, rivers and ground water. Where excess cold is available from industrial processes, it can be used directly in the District Cooling systems. Where excess heat is available, absorption chillers can be used to

produce cooling. Storage of cold water or ice can help increase energy efficiency and lower operation and maintenance cost. At the customer end of the system, the cooling is transferred to buildings in energy transfer substations.

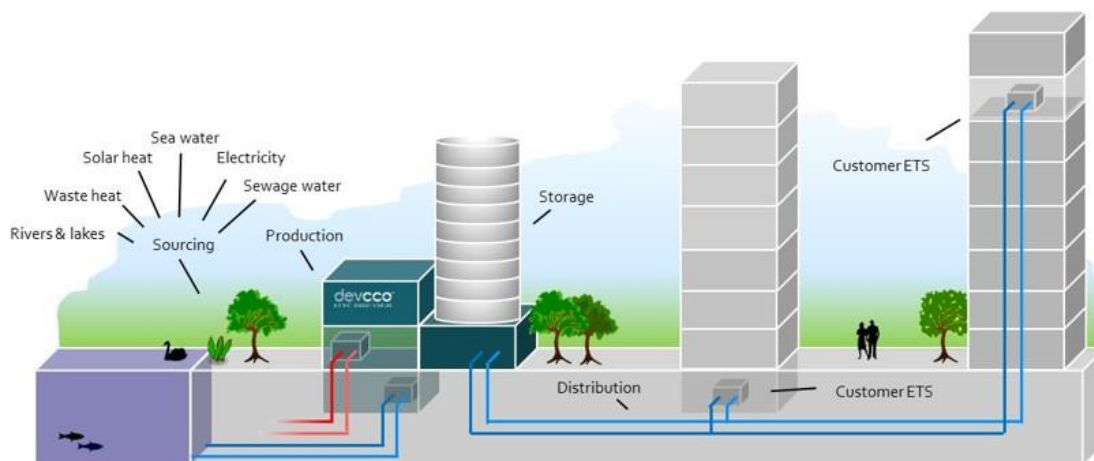

Figure 1: general scheme of a District Cooling system [4]

District Cooling systems can exploit renewable energy sources and excess energy from anthropic processes, significantly contributing to decarbonization of the heating and cooling sector. Furthermore, as they usually make use of thermal energy storage in order to meet peak cooling demand during warm summer days, they will in the future offer increasingly valuable flexibility to the electricity grid, which makes them economically appealing and attractive from the perspective of national and regional energy planning. Given the current energetic framework, which calls for greenhouse gas emission reduction [5] and for innovative approaches to face the issue of intermittent renewable energy sources, District Cooling is therefore increasingly raising interest among policy makers and municipalities.

Attention in this report is put on cooling sources and on cooling production technologies, with the intent of guiding readers through the many available options for implementing or expanding sustainable District Cooling systems that can meet sustainability requirements set at national, European and international levels.

The current guideline report first explains what District Cooling is, and why it can be beneficial for society and investors Chapter 2. Chapter 3 provides an overview of District Cooling development, followed by a detailed description of energy sources and cold generation technologies Chapter 4 and by a comprehensive list of best practices as case studies Chapter 5. Chapter 6 extensively considers design aspects of a DC system, from feasibility

evaluation to maintenance. Chapter 7 is about basic and advanced control logics and concludes the technical section. Chapter 8 provides a methodology for estimating the cooling demand of a district, which is the first action to be undertaken by project developers in order to assess whether District Cooling can be economically feasible. Chapter 9 shows a list of innovative District Energy concepts, whereas Chapter 10 is an overview of potential business models for District Cooling systems. Finally, Chapter 11 explains the role of public authorities in the development of District Cooling projects.

Further information is reported in the Appendixes:

- Appendix 1 shows a flowchart of the implementation process of District Cooling projects;
- Appendix 2 provides a checklist for designers and project developers;
- Appendix 3 lists relevant standards at European, American, Chinese and international levels;
- Appendix 4 provides information about heat losses in District Cooling piping.



2 DEFINITION AND BENEFITS OF DISTRICT COOLING

2.1 DEFINITION OF DISTRICT COOLING

District Cooling (DC) system is the general term for describing a centralized cooling system consisting of a pipe network filled with chilled water (DC system) and DC plants as cooling sources (chillers or residual heat for cooling). The chilled water is circulated by pumps from the DC plant to the customers' buildings and then back again to the DC plant through DC network. At building level, chilled water either flows directly in the building's own internal cooling system or transfers its thermal energy via a heat exchanger (ETS). The return water continues out through the return pipe and is pumped back to the DC plant, where it again is chilled.

DC aims to use local energy sources that otherwise would be wasted or not used, in order to offer for the local market a competitive and high-energy-efficient alternative to the traditional cooling solutions. The centralization of cooling production is a prerequisite to reach high energy efficiency as it makes possible to use 'free cooling' or waste heat sources. A DC system can reach an energy efficiency rate typically 5 or even 10 times higher than conventional standalone electricity-driven equipment.

A single DC system can meet the cooling needs of many buildings, using electricity or natural gas, and also utilizing freshwater, seawater or recycled water as the cooling source. The DC system can provide not only space cooling to buildings, including offices, hospitals, public buildings, residential buildings, commercial buildings and retail etc., but also process cooling to the industrial sector, including data centers, industrial processes, medical equipment etc. According to Euro Heat& Power report [6], the main five cooling sources and production combinations are:

- 1) Natural cooling sources from deep sea, deep lake, rivers or aquifers so called 'free cooling';
- 2) Industrial cooling sources where absorption chillers are used in combination with waste heat from industrial processes, waste incineration or cogeneration production plants;
- 3) Residual cooling from re-gasification of Liquefied Natural Gas (LNG);
- 4) Heat pumps in combination with e. district heating systems;

- 5) Highly energy efficient industrial chillers are often added as a part of the production mix to secure outgoing temperatures and redundancy.

To increase the energy efficiency and reliability, DC systems are often combined with night-to-day storage facilities where overcapacity during the night is stored for use during daytime. Seasonal storage can also be used in DC systems. Free cooling in winter is stored for use during the summer period.

The challenges for building owners and industrial process manufacturers to keep their occupants comfortable and their processes running at the right temperature are difficult in present day. Capital and operating costs, reliability, flexibility and environmental sustainability are the most-common considerations they face. DC is a highly energy efficient way for many owners and manufacturers to effectively address each of these challenges while meeting their comfort and process cooling and heating needs.

In some of the best practices in Chapter 5, supply of cooling is defined as a kind of public service in municipalities or specific regions, like electricity, fresh water supply and wastewater treatment etc. It refers to cooling, as a production of DC, which is commercially supplied through a cold/heat carrier medium against payment in the basis of a contract. It means the development of DC requires the commitment of the public sector (concession, subsidy etc.), but also suitable business models from private sectors, and buy-in from the customers (contracts or commitment to connect etc.).

2.2 WHY DISTRICT COOLING

Switching away from fossil primary energy for cooling production is an essential consequence of the fundamental idea of DC. Meanwhile, the centrally located model of DC also means developers benefit from reduced capital and operating costs, less frequent maintenance, space savings, and lower electricity usage over more traditional air-conditioning systems

In general, there are benefits of DC addressing the society, property owners and service providers.



2.2.1 BENEFITS OF DC FOR THE SOCIETY

1. Environment

- Adjustment to the Kyoto protocol and stricter, new environmental norms;
- Reduction of CO₂ and environmental hazardous refrigerants such as HCFC and HFC, as a support to Montreal Protocol and Kigali Amendment;
- Enhanced aesthetics and an improved local environment by reducing the noise.

2. Security of supply

- Avoided investments in summer electricity peak production, transmission and distribution;
- Higher local reliability of the electricity supply;
- Higher energy utilisation and reduced energy demand.

3. Competitiveness

- A new energy service that competes' freely with conventional alternatives and can be introduced without subsidies.

2.2.2 BENEFITS OF DC FOR PROPRIETY OWNERS/CUSTOMERS

1. More economical solution for cooling

- Less expensive in exploitation than alternatives, like compression cooling;
- Less price risks compared to alternatives;
- Clear cost profile, no 'hidden costs';
- Carefree service with a very high reliability

2. More social responsibility oriented

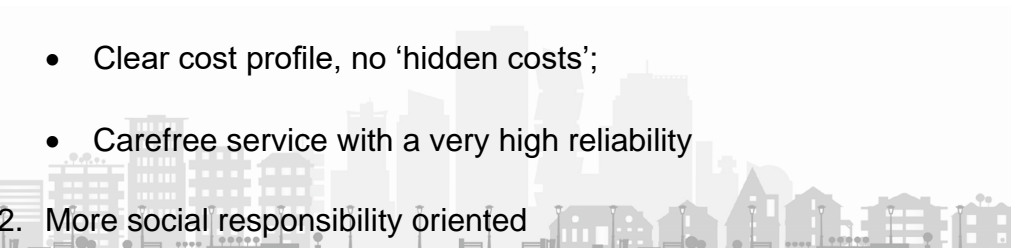

- Highly energy efficiency cooling option;
- Often cooling is provided from sustainable sources;
- Contributes to improved local environment (architectural freedom and quality; avoiding noise from cooling towers; avoiding use of cooling agents (chemicals) at the premises)

3. Improved value for the cooled building:

- Flexible adjustment of supply to demand, both comfort cooling and process cooling;
- Floor space savings;
- No use of cooling agents (chemicals) at the customers' site and thereby giving a solution for replacement of phased-out CFC/HCFC in cooling systems.

2.2.3 BENEFITS OF DC FOR ENERGY SERVICES COMPANIES:

- Fits perfectly into Corporate Social Responsibility (CSR) policy;
- A competitive product that gives a long term stable and profitable business;
- An innovative service to attract new and existing customers.

2.3 SUSTAINABILITY ASSESSMENT FRAMEWORK

There are no verified and uniform criteria for the assessment of sustainability at system level for local energy systems, such as DC. The assumption is that DC integrates a wide range of intermittent Renewable Energy Sources (RES) at larger scales than at building level. As local impacts may only represent a fraction of the total impacts, analytic methods covering the whole life DC cycle should be considered for socioeconomic or DC-related project impact measurement.

One framework developed in a study [7], which does not aim to be a detailed instruction for sustainability assessment, but rather provides a practical help for

decision-makers in sustainability assessment. The usage of this assessment framework for the purposes of DC pre-feasibility studies is intended to guide readers on how to compose or modify a DC to achieve the highest sustainability levels. The main indicator for sustainability depends on how effectively and efficiently the local energy demand needs are met. This framework consists of several steps, shown in Figure 2.

When applying this framework for assessing DC sustainability, the energy production selection starts with defining aims of the study. One example of such an aim could be to bring out the environmental benefits of certain energy production systems when compared to alternative systems or business as usual baselines.

For example, the aims could be to determine the energy production system which:

- provides the greatest reduction of greenhouse gases (GHG) emissions;
- increases the use of renewable energy with most cost-effective way;
- causes the lowest environmental impacts;
- boosts the local economy most;
- improves the continuity and reliability of energy supply;
- guarantees the affordable process for energy services;
- enjoys the widest public acceptance.



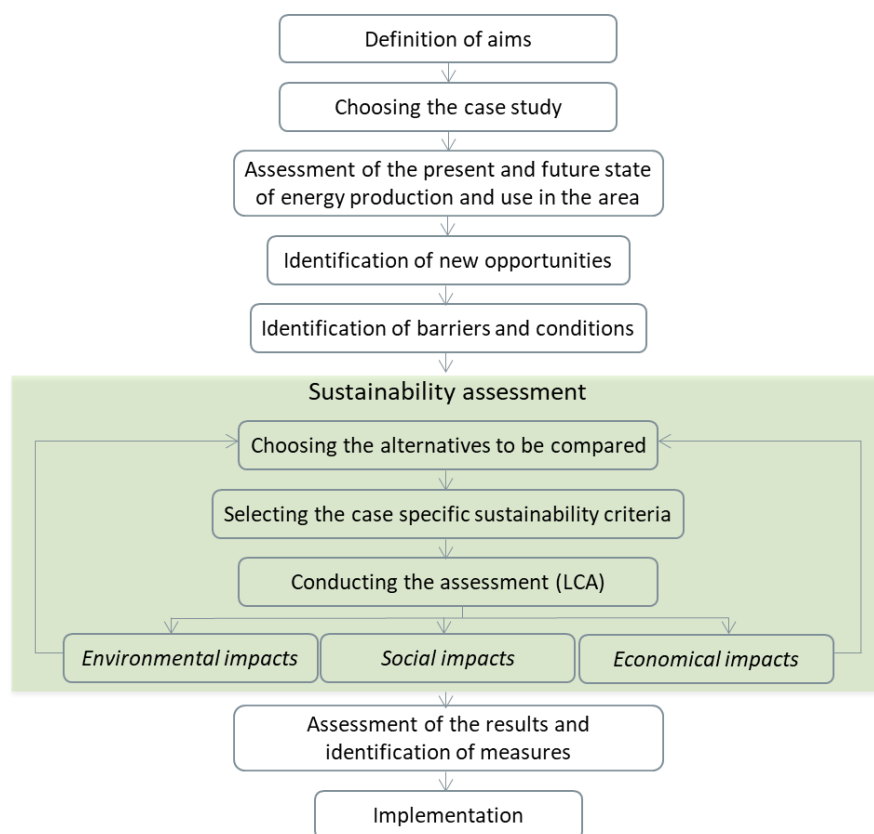

Figure 2: Proposed sustainability assessment framework [7]

The next step in the application of this sustainability assessment framework applied to DC is to choose the case study and system boundaries to be assessed. Setting the system boundaries properly is important for attaining a reasonable degree of confidence in the expected results of the study and reaching the desired targets of the study. The subject of the DC systems feasibility study can be a certain existing area or an area under planning.

In the next step of DC sustainability / pre-feasibility assessment, the balance of energy production and demand is hypothesized based on the information available from the intended ‘district’ boundaries. Assessing the present and future state of energy production within that defined district, gives a comprehensive understanding of the situation where changes are planned or in this case where DC shall be placed. If the assessment is made to a case with a single production unit, it is natural to outline the area in the sphere of influence of this unit. If the assessment is planned for the local area, the possibilities of integrating energy flows with a local industry sector should be also reviewed.

The following two steps of the DC sustainability assessment refer to new opportunities and barriers (Figure 2). The aim of identifying opportunities is to

widely map different solutions and gain a high level of understanding of the overall picture. For example, the possibilities for free cooling sources should be identified. Identification of barriers is important in excluding and outlining the unsuitable and infeasible options for more detailed consideration. For example, if an existing District Heating (DH) system is to be converted into a DH + DC system, proven technologies could involve e.g. heat pumps, geothermal, etc. By mapping the aforementioned variables to the local area for where the DC or single production unit are potentially intended, sustainability metrics can be formulated on a case by case basis.

In the next phase, DC sustainability assessment includes several stages with aims to provide more information about the impact of different options. The process is iterative in its nature (Figure 2). Assessment can be made, for example, by using life cycle assessment (LCA), system analysis, a check list approach or best of all a combination of these depending of the data availability and quality requirements. For a comparison of alternatives with technical and environmental sustainability criteria, LCA models can be used. An example set of the sustainability criteria that can be applied to DC pre-feasibility is shown in Table 1.



Table 1. Example of criteria for sustainability assessment [8]

Indicator	
<i>Technology</i>	
Adequacy	The extent to which an energy system can meet the energy needs of a community
Compatibility	The degree to which an energy system is compatible with the existing technological infrastructure
Energy return on investment (EROI)	The ratio of energy generated by the system to energy input
Exergy return on investment (ExROI)	The ratio of exergy generated by the system to exergy inputs
Reliability	The ability of an energy system to continuously deliver an uninterrupted supply of energy
Renewability	The amount of energy that comes from renewable resources
<i>Economy</i>	
Affordability	The production cost of energy generated relative to the median income of the community
Job creation	The number of local jobs created
<i>Society</i>	
Health	The number of illnesses as a result of the energy system
Local resources	The amount of energy inputs derived from local resources
Public acceptance	The fraction of the community that supports the construction and operation of the energy system
<i>Environment</i>	
Air pollution	Air pollutant emissions per unit energy production (NOX, SOX, PM)
Biodiversity	The effects on biodiversity over the life cycle of an energy system
Embodied water	Life cycle water use of the energy system
Greenhouse gas intensity	GHG emissions per unit energy production
Land area	The area of land required to meet the energy needs of a community.
Ozone depletion	
Solid waste	Solid waste generated per unit energy production
Water pollution	Wastewater production per unit energy production
<i>Institutional</i>	
Regulatory	Laws that support the construction and operation of a community energy system and accelerate their implementation
Policy	Subsidies or other benefits available to community energy systems.
Political	Support of local politicians in developing a community energy system.

OPTIONAL READING

The literature on 2.1 is done based on [6][9][10][11]

The literature on 2.2 is done based on [6]

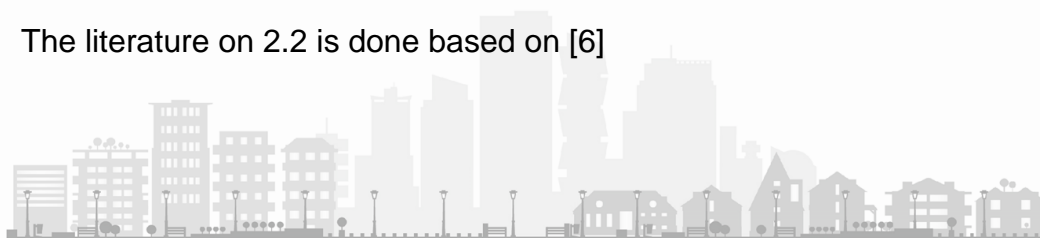

3 GENERIC DISTRICT COOLING DEVELOPMENT PRACTICE

3.1 INTRODUCTION

There are proven processes for developing District Cooling (DC) projects and business. In this chapter steps and activities necessary to implement a sustainable and profitable DC system are described. Common challenges, risks, opportunities and success factors are also high-lighted for each of the phases in the process.

3.2 DEVELOPMENT PROCESS

A generic development process consists of several steps in an array of activities that should lead to a successfully implemented DC system and business. These activities can be grouped together in several development phases in the overall development process.

Main subsequent phases in this process can be summarized to:



Figure 3: Development Process

A successful development process also requires knowledge about business project management. Business project management refers to managing each phase of the development process. Business project management can be divided into four pillars with risk management as a cross over discipline:

- Finance
- Organization
- Technology
- Market
- Risk Management





Figure 4: Business Project Management

A sound balance between the four pillars is recommended, since development of sustainable DC is a business and not only a technology. Expectations by a wide range of stakeholders such as investors, customers, local governments, local authorities, developers, operators and others must be met for a successful implementation of a DC business project.

Depending on the size of the DC business to be developed, which can be from a limited green field area to several mature districts in a city, it could be advisable to develop a master plan together with the main stakeholders. The master plan will identify the current and future energy needs and will serve as a tool to phase the development areas to mitigate technical and financial risks. Such a master plan can also create awareness and commitment among internal and external stakeholders.

Common challenges and experience from DC development in practice can be summarized to:

- Masterplan, business model and development strategy are essential, both to get started in the right way and to be able to develop the business successfully;
- Technology is one of several important parts of project development - but not everything;
- It is important to optimize the organization for each of the development phases;
- An implemented risk management process helps to focus and govern the project during the various phases of development.

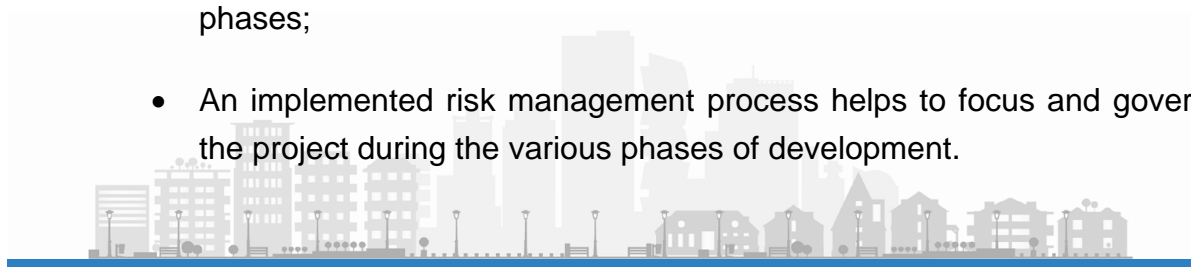

3.3 BUSINESS CASE ROADMAP

3.3.1 SYSTEM ARCHITECTURE AND TECHNOLOGY OPTIONS

Major benefits with DC systems are that they can operate with a multitude of sources and proven production technologies that can provide a basis for large scale advantages and energy efficiency. Crafting of system architecture and identification of technology options for a certain district or area also means taking local conditions and existing or new plans for other infrastructure into consideration.

The business case roadmap includes a rough analysis of different scenarios for sourcing, production and distribution of centralized chilled water. Technology options for future implementation will be identified with their pros and cons in line with local conditions and existing infrastructure. The selected system architecture and technology options should also include an analysis of the build-up of the entire DC system in phases to be able to match forecasted market demand development as efficiently as possible.

3.3.2 INITIAL MARKET ASSESSMENT

Establishing a relevant market potential is of great importance and one of the main activities to start with. Assessing the market potential in this early phase includes gathering and combining available data from several sources such as building and real estate registers, refrigerant registers, electricity demand profiles and climate data bases to the extend available. Benchmark analysis of the collected data is normally made with existing databases. These databases consist of information from previous DC developments. The result of the initial market assessment is a baseline energy demand and cooling load for the identified area, both for current and future markets.

3.3.3 STAKEHOLDER IDENTIFICATION

Stakeholder identification is of essence not only to identify the directly involved parties and those benefitting from the project, but also to identify those with major importance for a successful implementation of the project.

Performing stakeholder identification at this stage should include the following groups: owners, service providers, local authorities, permitting entities, potential clients and their associating organization, governmental bodies, landowners, local contractors and local environmental groups.

Identification of stakeholders is a time-consuming process, but a very important activity for a successful further development of the project.

3.3.4 RISKS AND PERMITS IDENTIFICATION

Risk management has become a vital part in business project management and project development including development of sustainable DC. Typically, risks are identified, analyzed, prioritized, and then adequate responses designed, appointed and then implemented.

Development of DC systems requires several and time-consuming permitting processes. Identification of necessary permits is of great importance to avoid the risk of delays in coming development phases which can result in high costs, or in the worst case, no permits and no project.

At this stage a rough identification of necessary permits is made based upon the selected system architecture and technology options. When identifying necessary permits existing local conditions which might be critical for success should also be considered.

3.3.5 IDENTIFICATION OF BUSINESS MODELS/OWNERSHIP MODELS

There are several dimensions or approaches to developing a business model for a large-scale DC project. Major questions to address are who is the present and future owner of the DC system and business, what financing is available, what contracting alternatives are available and what kind of resources and skills are required for the different alternatives?

Local markets offer various options and models for the structuring of a DC project, but generally the business models can be divided into two main groups:

- Non-concession structures;
- Concession structures.

Both models have their pros and cons and the choice of model is often linked to main stakeholders' financial, technical and operational abilities. At this stage a rough identification of available business models will be made which will be further developed in the next phase of the development process.

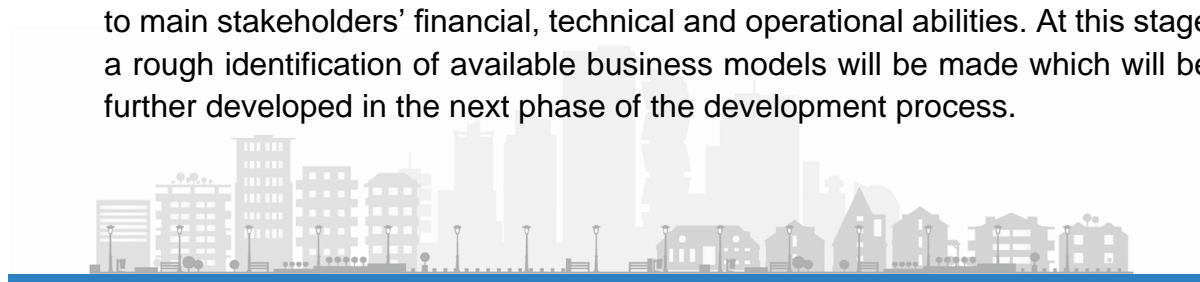

3.3.6 ROUGH ORDER MAGNITUDE FINANCIAL KEY-FIGURES

For the selected system architecture, the technology options and output of the initial market assessment ROM (rough order of magnitude), calculations of CAPEX (Capital Expenditures) and OPEX (Operational Expenditures) are made.

ROM revenues from potential customers will be calculated as a result of the performed market assessment and the identification of existing BAU (Business as Usual) technologies. Benchmark of BAU cost from previous development projects will be taken into consideration for the revenue calculations.

ROM financial key-figures will be calculated to establish a baseline and a rough profitability evaluation of the DC business case.

3.3.7 ORGANIZATION FORMAT

The format of the organization when developing DC business is of great importance and a critical success factor. Developing and establishing DC business from idea to operational system, poses a great challenge in many ways.

Developing and expanding the business requires short decision paths in which a number of people involved take responsibility for managing the business, with a focus on profitability and sustainably. A standardized decision-making process in each phase of the development process increases the probabilities for a successful project.

Successful development, construction and operation of a DC projects are made possible by the following organizational success factors:

- Clear responsibilities and mandates for what is expected of each function within the organization;
- The right skills with the necessary resources in each development stage, with a focus on achieving effective organization. Initially, a small dedicated organization is advocated with expertise in business development, market / sales, technology, and finance. As the plans and projects develop, the organization is also being expanded gradually;

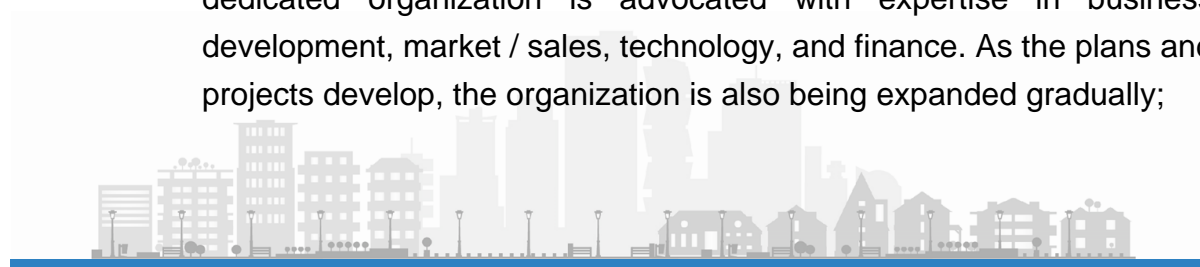

- Quick decision-making process by establishing and implementing routines for decision and control. A top management steering committee can be one way to achieve this;
- Encourage team spirit, provide strong internal support to the business and reward business drive;
- The development organization has a well-defined start and end point.

3.4 FEASIBILITY STUDY

3.4.1 DEVELOPMENT OF SYSTEM ARCHITECTURE

Development of system architecture for sustainable DC is essentially an optimization of several parameters where local conditions and different production, distribution and storage technologies are included. The outer frame is typically set by the market demand (with aspects including location, phasing, load, demand profiles, temperature requirements etc.) and available sources for cooling production. In this section we will focus on a few common themes and success factors in developing sustainable DC systems, i.e. system temperatures, energy balances and phasing.

System temperatures are vital for several reasons and depend on both customer demand and expectations and on available sources for cooling production.

Developers, building owners, advisors and contractors are typically used to standard design and operation temperatures for building internal systems. Such standard temperatures may vary depending on location, but in some parts of the world it is common with 7°C as supply temperature and 12°C as return temperature in building internal chilled water systems (BAU). When developing new buildings and districts, there is a greater level of freedom in designing building systems, while there are limited possibilities especially regarding supply temperatures in existing buildings.

When designing DC systems, it is generally desirable to distribute chilled water at a relatively high temperature and to receive as high a return temperature as possible. The difference between the supply and return temperatures is called delta T (or ΔT). A high ΔT is desired since the higher the ΔT the smaller the dimension of distribution pipes for a certain cooling capacity. The reasoning behind system temperatures is also that higher supply and return temperatures

normally allow for a larger amount of cooling to be produced from natural sources such as lake or sea water. Colder water is typically available at larger depths, resulting in longer and stiffer pipes at higher cost, and colder water is normally also available for shorter periods of the year compared to slightly warmer water.

When absorption chillers are an alternative, there are more temperature levels to consider. Absorption chillers reach higher energy efficiency and capacity with higher temperatures on the heat source which may be steam or hot water. In cases where absorption chillers are powered with heat from district heating there is normally an optimization required since a high heat temperature that is beneficial to the absorption chiller may have a negative impact on overall energy efficiency and electricity generation in the DH system. Absorption chillers are also more limited than compression chillers in how low DC temperatures they can deliver, which needs to be considered.

In conclusion, the challenges regarding system temperatures are to weigh in all the above factors and to find a compromise between what is technically/economically optimal from a total perspective and what is desirable and feasible to customers.

3.4.2 SOURCING AND ENERGY BALANCE

Energy balances are essential to calculate how aggregated customer demand is met with produced chilled water. In order to optimize the system design, it is at least for large DC systems important to consider different production alternatives for base load and peak load cooling production. Since base load production is in operation for a longer time than peak load units, higher investments can be motivated in return for lower operational costs and better environmental performance. When selecting peak load units, focus should on the contrary be on low capital expenditure. Air-cooled compression chillers are an example on peak load production, while absorption chillers and sea water cooling often serve as base load production.

Major benefits with district cooling systems are that they can operate with a multitude of sources and production technologies and that they provide a basis for large scale advantages and energy efficiency.

A basis for evaluating what sources and technologies that have relevance and applicability to the local case is carrying out detailed site surveys on physical infrastructure that exist for production and distribution of electricity, water and other public services.

In addition to existence of (and plans for) such physical infrastructure, a number of natural conditions are relevant to the feasibility study. E.g. sea water air conditioning (SWAC) is an optimization between onshore and offshore site specifics including bathymetry, seawater temperature profiles, access to sites for landing and pumping facilities and location of cooling load. Potential restrictions such as restricted areas, military facilities, existing cables and pipelines, marine sanctuaries etc. should be assessed. Efficiency in the preparation of such assessment will be greatly increased if primary stakeholders are able and willing to supply data and information.

In district cooling alternatives involving absorption cooling or large-scale compression chillers, access to water for condenser cooling purposes is valuable and assessments similar to those applicable for SWAC would be meaningful also for these alternatives.

Utilization of waste heat. Absorption cooling is a technique that normally uses surplus heat from electricity generation, district heating, waste heat from industry or from waste incineration.

The feasibility of such absorption cooling largely depends on the quality and quantity of existing or planned heat sources and on access to efficient condenser cooling.

3.4.3 PHASING STRATEGY

Even though DC normally is a large-scale technology, it often makes sense to develop DC systems in phases. It is often, but not always, preferable to start with small and customer dense areas creating DC-islands with local production, even if it means that highly efficient base load production cannot be realized until later in the development of the district. Reasons for such phased approach are that initial capital expenditures can be reduced, that the DC-technology can be locally demonstrated gaining customer confidence and that capital intense large-scale production investments can be made with lower risk once a solid demand for DC is established.



3.4.4 DISTRIBUTION AND ETS

Analysis of different scenarios for distribution of centralized chilled water will be made in this phase. Concept design of chilled water distribution network including pipe material, type of insulations, design pressure and preliminary layout with specifications on dimension, length and type of installations per stretch are activities normally undertaken in the feasibility study.

Typical challenges are that ground conditions can be very different depending on type of area (green field, brown field, existing city centers etc.), and that civil work markets are often very local.

Analysis of customer ETS including type of ETS (direct/indirect), material, design pressure and design temperatures (in and out) are also typical activities.

3.4.5 MARKET DEMAND DEVELOPMENT SCHEME

In the feasibility study phase, it can be very valuable undertake on-site surveys for a number of key clients in order collect high quality information as a complement to the market demand assessment made in the road map phase. At this point it is also relevant to assess the market from a phasing perspective making a plan on how the market can be developed in phases over time.

Readiness to change to a district cooling system service will largely depend on the existing type of air conditioning system installed by the potential clients, sometimes in combination with the remaining technical life of such installed systems.

A major barrier for introducing district cooling and also a major barrier for phasing out climate hazardous refrigerants is the use of BAU 'split systems' or VRV/VRF ('multi split' systems) in existing buildings and planned developments. The reason being that in such buildings there are no internal chilled water system or ducted ventilation systems that provides a connection point for DC.

3.4.6 DISTRICT COOLING COMPETITIVENESS VERSUS BUSINESS AS USUAL

In order to establish realistic expectations regarding DC price levels, an assessment of the BAU alternative to produce cooling is a success factor in the feasibility stage of a DC development project. The major cost drivers being CAPEX for installation, electricity prices and sometimes water costs are

relatively easy to establish. The challenges normally lie in assessing typical seasonal demand and energy efficiency ratios as well as service and maintenance costs.

Once the life cycle costs for the BAU alternative is established, the price level and price structure for a DC service to customers can be developed. Here the challenge is creating a price structure that is appealing to the customer and that secures a revenue stream that is sufficient to get the DC system financed and realized.

Price structures may vary, but since both customer BAU and DC require substantial up-front investments, it is common with an initial connection or access fee based on the connected cooling capacity. Other common price components are capacity fee, energy fee and flow fee. While capacity and energy fees are self-explanatory, a flow fee has the purpose to provide incentive to the customers to prioritize low flow and a high return temperature to the benefit of the energy efficiency of the entire DC-system.

3.4.7 TECHNICAL AND ECONOMIC FEASIBILITY

District cooling is a well-established technology and there are many successful examples using various technical solutions and system designs. The challenge is often to find a solution that is not only technically feasible, but also provides short- and long-term profitability and that meet initial financing requirements.

In order to optimize and evaluate different alternatives, a life cycle cost perspective is required. By adopting such perspective alternatives with different CAPEX and OPEX can be compared, and different development schedules and phases can be evaluated side by side. Typical time frames for such profitability analyses are 20-30 years, even though the technical lifetime can be longer for some parts of the DC systems. Typical output of profitability models are net present value ('NPV') and internal rate of return ('IRR') to mention a few.

From a system wide perspective, investment in electricity generation and distribution can be avoided when district cooling is introduced and sometimes this opportunity can be factored into the district cooling economic feasibility.

Typical challenges in analyzing DC profitability is forecasting future development speed and customer connections and normally also to make predictions regarding electricity prices. Fortunately, these are risks that to some extent can be managed already in the feasibility study phase. The sensitivity to future market expansion and sales can be reduced by a system design that

allows for a development of the DC system in phases. In an ideal situation the DC-system can then be expanded in pace with the actual market demand. The risk of volatile, and particularly of increasing electricity prices, can normally be shared with the customers since this risk is typically significantly higher with their alternative BAU technology.

3.4.8 ENVIRONMENTAL IMPACTS AND PERMITTING

For permitting reasons but also for PR-reasons it may be mandatory or advisable to conduct environmental impact assessments when developing sustainable DC. Especially when natural sources are utilized to produce cooling.

Such studies normally focus on potential local impacts and how to avoid or mitigate them, but they also offer an opportunity to communicate benefits of sustainable DC, which normally include reduced emissions of GHG through reduced electricity demand and reduced use and leakage of refrigerants compared to the baseline scenario with BAU. Other typical benefits are noise reductions and reduced risk of legionella by omitting or reducing the amount of installed cooling towers in the district.

Permitting processes might be very time consuming why they are normally initiated in this phase of development.

3.4.9 STAKEHOLDER ANALYSIS

Vital stakeholders are normally identified in the roadmap phase and then more thoroughly analyzed in the feasibility study.

Stakeholder analysis can be performed in different manners from desktop studies to actual meetings with the different parties, which also provides an opportunity to communicate the intentions with the sustainable DC development.

Opportunities that can surface in a stakeholder analysis are e.g. co-location opportunities with other service providers, identification of parties with common incentives to reduce electricity demand and initiating relations with potential DC champions.

3.4.10 RISK MANAGEMENT AND GENERIC RISKS

While risk identification is normally performed in the roadmap phase, the risks need to be analyzed and prioritized, and then adequate responses can be



crafted and implemented in this and in the following phases of the development process. Typically, the different steps in the risk management cycle are repeated in each following phase.

Examples of risks frequently encountered are listed and briefly discussed below.

When developing DC in a new local market there is a risk of lacking customer confidence in the product/service. Mitigative activities can be demonstrating the technology by implementation of a smaller scale pilot project and/or by study visits to DC systems in operation.

Development of district cooling on large scale require committed first tier stakeholders with an ability to finance, or to attract financing for, phases prior to the construction phase and also to structure the development in a way that attracts capable parties for owning, developing and operating the DC business and system. Lack of such financing and structure pose a potential risk in any large-scale DC development.

Access to sites for production facilities and underground space for distribution pipes is essential in developing a successful DC project. The most straight forward way to manage this risk is to address it as soon as possible since such processes may be time consuming.

The district cooling production facilities will require significant electricity supply which will have an impact on both existing and planned electricity distribution systems. However, this requirement is more of an opportunity than a barrier since the introduction of district cooling will result in very large reductions in electricity demand overall. This is due to the higher energy efficiency of district cooling as compared to individual cooling and air conditioning systems.

A major barrier for phasing out HFC and HCFC and also a major barrier for introducing District Cooling is as mentioned the wide use of 'split systems' or VRV/VRF ('multi split' systems). This barrier could be overcome by introducing building codes or similar stipulating centralized and ducted cooling systems for new developments.

Geo-technical conditions can have major impacts on construction costs especially when it comes to ground water table for construction of the distribution system, and conditions for trenchless construction of shore crossing for sea water pipes. Risk assessment typically start with conducting a geo-technical survey as a basis for engineering and construction of the distribution system.

The potential environmental risks using natural water sources for cooling are typically related to altering nutrient and temperature levels in the water body. Key in risk management is identifying potential environmental impacts and then to design to avoid or reduce such impacts.

Even though district cooling systems have proven to be very reliable, the risk of interrupted cooling supply should be prioritized in the design and operation of the system. Customers with exceptional reliability requirements, e.g. hospitals and data centers will typically install district cooling as their primary system with a local system as back up.

3.4.11 ORGANIZATION FORMAT

A common challenge in developing sustainable DC is implementing an organization with the ability to develop and establish a business, not just a technical system. In this phase it is critical to secure resources that cover all critical activities in the following project development phase. A critical success factor is having a marketing and sales team, in addition to the more traditional project disciplines, in place for the business development phase that follows.

3.4.12 BUSINESS MODELS

The business model for a district energy system is normally very project specific. It needs to ensure that all of the stakeholders involved – including investors, developers, owners, operators, utilities/suppliers, end-consumers and municipalities – can achieve financial returns, in addition to any other benefits that they seek.

In cases of city-wide developments with several potential DC districts, it can be helpful with a Master Plan as a strategic framework describing the long term and high-level perspective.

It is common that business models for district energy involve the public sector to some degree, whether as a local policymaker, planner, regulator or consumer, or more directly through partial or full ownership of projects. Public sector involvement can be critical in coordinating multiple, diverse projects around a broader citywide vision. Even projects with a high degree of private sector control are often still facilitated or supported in some way by the public sector.

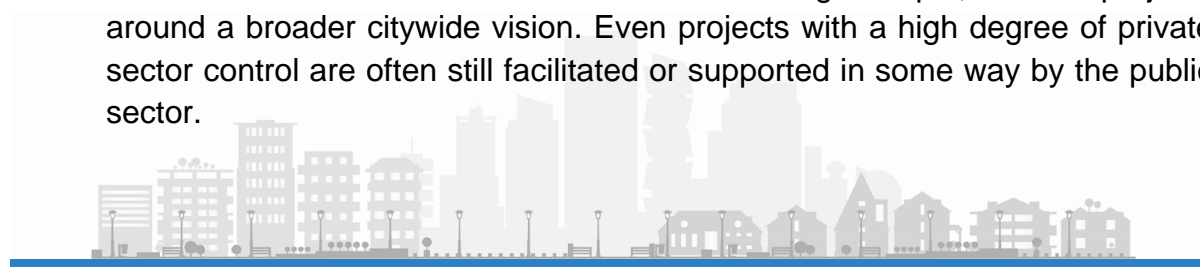

As previously described the business models can be divided into non-concession structures and concession structures. They are described in further detail below.

The non-concession models are based on a structure where the project owner/main project developer maintains the ownership and title to the district cooling project through all its development and operation phases. Design and construction of the system is typically contracted out under an EPC contract while the operation of the system is undertaken by a district cooling service provider. The structure is simple to execute and has relatively short lead times. Non-concession arrangements are common e.g. in Canada and in the UK.

Concession structures refer to structures where the project owner/main project developer issues a right towards a third party to supply district cooling to buildings within a development area on certain conditions. This agreement is normally referred to as concession agreement and in such cases the concession taker owns the district cooling system.

Benefits are that concession models bring considerable risk protection; cash savings and avoidance of liabilities to the project owner/main project developer. Critical to the business model are the conditions regarding off-take guarantee and consequential pricing. It also allows the service providers business (i.e. district cooling business) to be separated from the real estate development. In some cases, concession structures are used to acquire sufficient financial, technical and operational capabilities from external parties. Concession models are common e.g. in the GCC region.

Financing options will have to be initially assessed in the feasibility study phase since they have an impact on several other aspects of the DC development such as distribution of risks and acceptance of different contracting models. The typical debt alternatives are corporate based structures and project finance structures. A success factor especially in case of project financing is that a solid long-term revenue stream to the project is secured up front.

Regarding equity financing there are a wide variety of alternatives ranging from fully private to fully public ownership. There are also several examples of different ownership of different parts of DC systems.

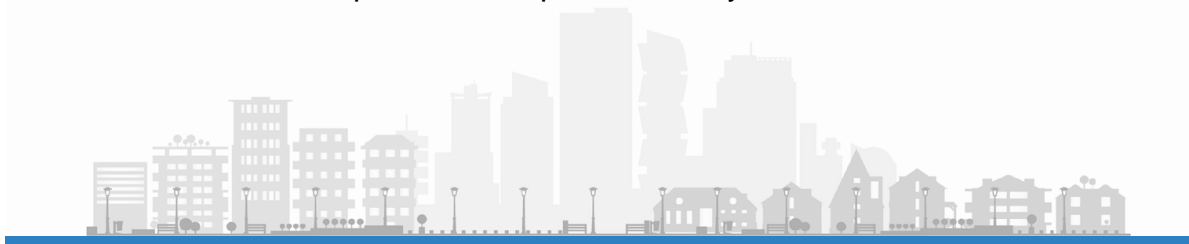

3.5 PROJECT DEVELOPMENT

3.5.1 GENERAL

The project development phase includes activities aiming at securing contracts at all ends of the project including revenue stream (i.e. customer contracts), financing, operation and construction.

Typical activities are structuring ownership and stakeholders, project management, engineering, procurement/contracting, permitting, securing land rights, financing, marketing and sales and risk management.

Business models are further developed to fit risk allocation and control requirements.

3.5.2 CONTRACTING ALTERNATIVES

Local markets offer various options for the structuring and construction of a DC project. Several well-defined contracting alternatives are available. In many cases, the choice of contracting alternative depends heavily on the financing model.

While several contracting alternatives are available, two common alternatives are highlighted here. The first alternative is a contract with a third party to design and build the DC facilities called EPC (Engineer, Procure, Construct). EPC contracting transfers the design and construction risk to a third party. Another frequently used model is BOT (Build Operate Transfer). BOT refers to a contract with a third party to design, build and also operate the DC facility for a defined period. The key driver is to transfer the operating risk in addition to transferring design and construction risk.

3.5.3 ENGINEERING

The level of engineering will be based on the decided ownership structure and contracting alternatives.

Typically, the engineering is divided into the following scopes: production plant, offshore and onshore pipeline routing and customer connections.

Operation & maintenance and HSE (Health, Safety & Environment) plans will be developed for the further construction of the system.



3.5.4 PROCUREMENT/CONTRACTING

Procurement and contract activities will include preparation of bid package documents, qualification documents, general terms & condition documents, bid issuing procedures, site visits, bid opening procedures, bid evaluation and analyses, clarifications and selection criteria.

Negotiations for procurement of contractors and equipment will be made in accordance with the selected ownership structure and the selected contracting alternatives.

Finally, as a result of the procurement and contracting activities, an update of previous CAPEX and OPEX calculations are made.

3.5.5 PERMITTING

In this stage of the project, if not sooner, all permit studies and permitting preparations previously performed should result in various permit applications to be presented to the relevant identified authorities.

Permitting activities will include meetings with different departments to inform them and get approvals of EIA (Environmental Impact Assessment) studies, shore and territorial permits and consents, building permits, easements and land lease agreements.

Other permits to be prepared and approved are working permits during construction and operation.

3.5.6 FINANCING

Development and construction financing include activities such as financial structure and financial model update, tax structure update, other subsidies and tax facilities updates.

Financing also includes loan arrangement, equity arrangement and other direct agreements with contractors, clients, governments etc.

3.5.7 DEVELOPING CUSTOMER CONCEPT AND CONTRACTS

Developing CSA (Customer Supply Agreements) including a price structure is prioritized activity to create stable long-term revenue to secure financing and to make competitive propositions to customers with stable and foreseeable costs.



In this phase the contractual aspects, including the conditions of sale of cooling to customers, are developed. The CSA is typically a 10-20 years contract between two parties which describes the terms and conditions for the supply of DC (provider) respectively the usage of DC (customer).

The delivery/supply boarder is an important variable. Typically, DC is delivered upstream of the ETS but depending on local conditions and customer technical and financial capabilities, the point of delivery can also be down stream of the ETS. In most of the mature systems in operation in Europe and the Middle East, the ETSs are owned by the customers. When introducing DC on a new market, the ETSs are sometimes operated and maintained by the DC provider during the first years of operation.

3.5.8 MARKETING AND SALES

Marketing and sales activities are of great importance to be able to secure as many customers as possible prior to the investment decision and construction finance. DC is a capital intense business with high up-front CAPEX, why a fair share of the market potential has to be secured by a number of signed CSA to reduce the investment risk.

3.6 CONSTRUCTION

3.6.1 GENERAL

Construction of all parts of the DC system is naturally the main activity in this phase, but in the sections below some less obvious key activities and success factors are mentioned.

3.6.2 KEY ACTIVITIES

Recruiting management and staff for the operational phase.

Impacts identified in the environmental assessment normally need to be monitored during construction.

Normally a certain level of customer commitment is required pre-construction, but marketing and sales activities need to be continued through construction in order to secure as much revenue as possible as soon as the DC system becomes operational. In the construction phase there is a good opportunity to attain interest from previously doubtful potential customers since there is now evidence that the system is being realized. At this point it is also relatively easy

for all parties to foresee when the service becomes operational, and thereby managing connected risks.

3.6.3 SUCCESS FACTORS

Keeping track of the overall schedule and profitability goals, continuing to evaluate proposed changes and improvements from an LCC project profitability perspective.

Quality control of underground and sub surface installations. Quality of construction and forging of pipes is critical to function and lifetime of installations.

During construction there is disturbance not only to the environment but also to stakeholders and traffic. Communication of long-term benefits to stakeholders and community helps creating a better acceptance of temporary disturbance during construction.

It is often a challenge to customers to procure and correctly install ETS. Therefore, it can be worthwhile to make resources available to assist customers or even to offer turn-key solutions through third parties.

3.7 OPERATION

3.7.1 CONTINUOUS ACTIVITIES

The operational phase is not time limited like the previous phases and less capital and labor intense. Focus is to maintain high reliability and quality of the DC service and to secure customer satisfaction and revenue stream.

Continuous activities in the operation phase are:

- General business administration such as customer billing;
- Technical operation and maintenance of the entire system;
- Marketing and sales;
- Customer support.

Properly managed DC systems are often very reliable. This is due to consolidation of assets and ability to cost-effectively introduce redundancy,

dedicated and highly skilled maintenance and operational staff, and the robustness of larger equipment and systems installed in plant environments.

One critical success factor to achieve an energy efficient and well performing DC system is to assist the customers with effective support programs. This activity is further described below.

3.7.2 CUSTOMER SUPPORT AND ENERGY EFFICIENCY PROGRAMS

Fundamental in the DC system is the temperatures at which the cooling is supplied to, and returned from, the customers. These temperatures have large impact on the performance of the system and on the dimensions of the distribution network.

A conventional DC supply temperature to clients is 5-7°C which is close to design temperatures for centralized BAU cooling systems. Such supply temperature makes conversion and adaption of buildings to be able to receive DC relatively easy. Return temperatures differ between 12-16 °C depending on local conditions and matureness of the system in operation.

The DC return temperature determines the dimensions of the DC distribution pipes and on the customer internal air conditioning system for a given capacity. A high return temperature creates a large difference to the forward temperature ('delta T') resulting in relatively small district cooling distribution pipes and relatively large e.g. ETS heat exchanger and air handling units in customer air conditioning systems.

The importance of keeping the differential temperatures as high as possible is obvious. By adjusting set points and eliminating short cuts in the customers' systems the return temperatures will increase to standard levels.

There are a lot of existing proven guidelines and handbooks to support customer energy efficiency programs.



4 MULTI-ENERGY SOURCES FOR DISTRICT COOLING SYSTEMS

A DC system is a combination of several parts, which must be correctly coupled in order to provide the required cooling services to customers.

- 1) Energy sources are explained in detail in Chapter 4. Those are electricity, heat from fossil fuels (e.g. natural gas to fuel trigeneration systems, excess heat from industrial processes), heat from natural sources (e.g. sun), natural cold sources (e.g. lakes, seawater etc.);
- 2) Cold generation technologies turn energy sources into cold energy. They are investigated in Chapter 4;
- 3) Thermal energy storage is used in many DC systems to match cold production and cold demand curves. They are described in Chapter 4.5;
- 4) Customer ETS are responsible for transferring cold energy from the main DC pipes to the buildings' internal chilled water distribution system and are explained in Chapter 6.2;
- 5) Chilled water distribution inside buildings is handled in Chapter 6.3.4.

DC cooling supply can be sourced from natural sources of free cooling such as sea water, excess cooling from industry, and compression or absorption chillers. General layout of a DC system is shown in Figure 5. Compression chillers are the most commonly used technology.

Compression chillers are not only common, but they are also potentially a flexible and efficient source of cooling. This is especially true if the condenser is equipped with a heat recovery system. Such an arrangement can coincidentally be used as a heat source (e.g. for DH systems, increasing the overall energy efficiency significantly). The same piece of equipment is in practice producing both heating and cooling. Absorption chillers are another application where a heating and cooling system can be combined on the supply side. Produced heat can therefore be used as such (e.g. in a DH system and alternatively as an energy source for an absorption chiller). These potential synergies are one of the key elements in developing a sustainable cooling system.



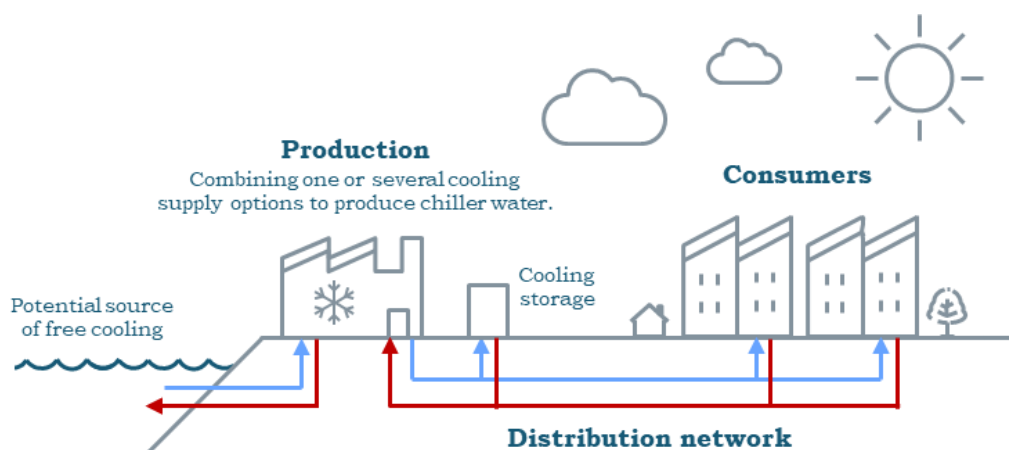

Figure 5: The general principle of DC operation.

4.1 COMPRESSION CHILLERS

Compression chillers were classified in 2016 by ASHRAE [12] according to:

- Heat rejection and heat sinks;
- Main energy source (electricity, heat, mechanical);
- Refrigerant and operational temperatures;
- Capacity.

Compression chillers can be either air- or water-cooled, in terms of their heat rejection systems. Air-cooled chillers are typically pre-assembled packages with the controls, compressors, evaporator, and air-cooled condenser all included. The capacity of such chillers may go up as high as 450 tons (1,600 kW).

Water-cooled chillers utilize water as the method to remove the heat from the chiller condenser. In this setup, the heat is carried by a water circuit and rejected into natural heat sinks such as bodies of water (i.e. rivers, lakes, and oceans) or through dry or wet cooling towers. Wet cooling towers can be further classified as open- or closed-circuit wet cooling towers. In an open-circuit cooling tower, water in the circulation evaporates into the air and releases heat. In a closed-circuit cooling tower, water is sprayed on the surface of the heat exchanger and then it evaporates, thus lowering the temperature level. Both types require a steady inflow of water. One limiting factor regarding the capacity of a wet cooling tower is the ambient wet-bulb temperature. Since a wet-bulb

temperature is lower than a dry-bulb temperature, using a cooling tower with a water-cooled chiller is more efficient at removing chiller heat. This is due to the lower condensing temperature of water-cooled chillers, when compared to air-cooled chillers. Typically, chiller plants with a wet cooling tower are a great deal more efficient than either air-cooled or plants with dry cooling towers, and they require less heat rejection area.

Some water-cooled chillers in the Gulf region have shown examples of specific electricity consumption of 0.2 kW/kW versus 0.5 kW/kW for the air-cooled [12] The heat rejection area excluding surrounding free spaces comprise an area of 0.04 m²/ton versus the 0.07 m²/ton for air-cooled. As a result, water-cooled plants are typically used in most large DC systems even though the water consumption can be an additional cost factor.

Water-cooled chillers may be as large as 10,000 tons (35,170 kW) per unit, depending on the refrigerant used. The most cost-effective capacity is around 2,500 tons (8,800 kW) as the larger units are of the industrial type and have higher costs per each unit of capacity. The expected life span of the units is around 25 years or longer.

The size and number of chillers chosen in a DC system depend on several parameters, including but not limited to the type of chiller (screw or centrifugal compressor, absorption, etc.), available commercial chiller capacities, maximum and minimum load, scheduling the plant construction, and part load operation requirements. *Table 2* provides a summary of typical chiller efficiencies and sizes, as well as their required monetary investment range in terms of CAPEX and OPEX.

Table 2: Summary of chiller characteristics [12]

Chiller Type	Size Range (kW)	Typical Efficiency (kW/kW)	CAPEX: Equipment Cost (€/kW)	OPEX: Estimated Maintenance Cost (€/year)
Electric Centrifugal (Standard Single Compressor)	1,760 – 5,280	0.17 - 0.20 (COP 4.7-5.4)	50 - 70	3,290



Electric Centrifugal (Standard Dual Compressor)	5,280 – 14,070	0.17 - 0.20 (COP 4.7-5.4)	60 - 90	3,920 – 4,450
Electric Centrifugal (Standard Dual Compressor)	5,280 – 14,070	0.17 - 0.20 (COP 4.7-5.4)	100 - 110	3,290 – 3,740
Electric Centrifugal (Single Compressor Industrial - Field Erected)	8,790 – 19,340	0.17 - 0.20 (COP 4.7-5.4)	160 - 200	4,270 – 4,900
Engine-Driven Centrifugal	350 – 10,550	(COP 1.5 - 1.9)	110 - 160	3,900 (without engine)
Direct-Fired (Double Effect) Absorption Chiller	<350 to >11,430	(COP 0.85 - 1.20)	100 - 510	4,270 – 4,900
HW Absorption Chiller (Single Effect)	<210 to >11,430	(COP 0.55 - 0.70)	110 - 250	4,270 – 4,900
Steam Absorption Chiller (Single Effect)	<210 to >11,430	(COP 0.60 - 0.75)	110 - 200	4,270 – 4,900

4.2 ABSORPTION AND ADSORPTION CHILLERS

Absorption and adsorption chillers provide a cost-effective and sustainable alternative to conventional refrigeration. Combining low-emission electricity generation with these types of chillers enables high energy efficiency, the elimination of high Global Warming Potential (GWP) refrigerants that are used in conventional chillers, and finally reduced overall carbon emissions.

Combined heat and power (CHP) units, also referred to as co-generation plants, can be integrated with cooling and refrigeration systems through different configurations. Absorption and adsorption chillers can make use of this produced heat or excess heat, while the compression chillers utilize mechanical energy or electricity. The hot exhaust gas from the gas engine can also be used as an energy source for steam generation, which can then be utilized as an energy source for absorption or adsorption. By integrating CHP with adsorption /absorption chillers, the yearly utilization rate and the overall energy efficiency of the cogeneration plant will increase.

Sorption technology has several advantages against conventional compression-based refrigeration:

- As the main input energy is heat, inexpensive excess heat sources can be exploited if available;
- Sorption reduces electricity consumption, therefore local excess electricity (e.g. from a CHP plant) that can be fed into the grid;
- Low noise pollution;
- Low operating and lifecycle costs if inexpensive excess heat is used;
- Use of natural refrigerants is possible (low GWP).
- On the other hand, main disadvantages in the same context are:
 - Lower COP (Table 2). That said, it is worth mentioning that the COP curve of sorption devices is less sensible to worsening of operating conditions (i.e. increase of outdoor the temperature, low requested cooling temperature).
 - Higher CAPEX compared to compression technology;
 - High need for heat rejection;
 - Refrigerants: Some working fluid couples are not harmful (e.g. LiBr-H₂O), but cannot go below 0°C. Water-ammonia can go below 0°C, but ammonia is harmful for human beings (refer 6.4);
 - Increased response time at start-up.

4.2.1 ABSORPTION CHILLERS

Absorption chillers produce cooling by evaporating and condensing a liquid solution, taking advantage of the changing properties of the fluid with different concentrations. The type of solution that can be used for absorption chillers must consist of a refrigerant and an absorbent, and together they act as a working fluid for an absorption process. The most common choices for absorbent-refrigerants are lithium bromide-water (LiBr-H₂O) and water-

ammonia ($\text{H}_2\text{O-NH}_3$). These two working fluids operate at different pressures, and therefore are suited for different temperature levels. LiBr- H_2O is generally suited for producing chiller water within the temperature range of 6-12°C. Alternatively, $\text{H}_2\text{O-NH}_3$ can operate both within the same range as LiBr- H_2O but can also achieve lower temperatures down to -60°C.

The energy efficiency of an absorption process depends on the temperature of the heat source and the sink. The process also has a threshold temperature on what is required for the chiller to work, e.g. in the LiBr- H_2O this is about 80°C and corresponds to an efficiency of approximately 80% (input of heat divided by the output of cooling). For a chiller supplied by hot water, the efficiency (COP_{th}) is 0.6 - 0.8 and for a double-effect chiller with steam used to input heat the efficiency is 1.2-1.3.

4.2.2 ADSORPTION CHILLERS

Unlike absorption chillers, adsorption chillers utilize solid materials as sorbents. This material adsorbs the refrigerant and subsequently releases heat in the process. The operating principle is visualized in Figure 6.

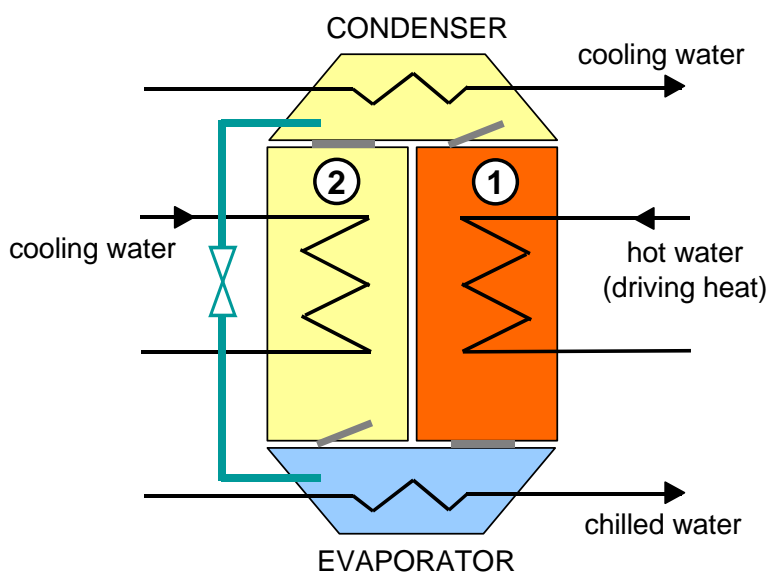

Figure 6: Principle schematic of an adsorption chiller[13]

Commercially available adsorption systems use water as the refrigerant and silica gel as the sorbent, but R&D on systems using zeolites as sorption materials are ongoing. An adsorption chiller, as illustrated in Figure 6, consists of two sorbent compartments 1 and 2, an evaporator and a condenser. While the sorbent in the compartment 1 is desorbing, the adsorbed water is removed

by utilizing an external heat source such as a solar collector. The sorbent in compartment 2 adsorbs the refrigerant vapor entering from the evaporator. The compartment 2 is then cooled, increasing the efficiency. The refrigerant is vaporized under low pressure in the evaporator, ultimately producing cooling. The functions of sorbent compartments are periodically switched over (by external valves) in order to maintain the long-term operational efficiency of the chiller.

Advantages of adsorption against absorption are [14]:

- lower required temperature compared to absorption: depending on the device, adsorption starts working with 60-70°C, whereas absorption requires some 75-80°C;
- noiseless operation and longer lifetime as no compressor is required;

Disadvantages of adsorption chillers against absorption chillers are mainly related to the lower COP of adsorption (usually in the range of 0.5-0.6) and to non-continuous output due to switch from one compartment to another.

4.3 FREE COOLING

Among all the renewable energy resources, bodies of water are frequently used as a source of cooling in DC [15]. Many DC projects located in coastal cities worldwide use seawater as the cold source via heat exchangers.

A study by Zhen et al [16] on DC system using sea-water heat pumps installed in the north of China demonstrated that such a system has low annual cost, significant energy savings, and environmental benefits. The DC system in Stockholm (Sweden), which uses free cooling from Baltic sea, is one of the largest DC systems in the world [17].

Natural cooling from a river is used by seven chiller plants supplying cooling to a DC in Paris [18]. Four of the plants are chillers with cooling towers and the other three utilize water from Seine to produce cooling or as a heat sink for the chiller condensers. When the water temperature is below 8°C, water from the Seine is used directly for cooling. By eliminating or bypassing chillers, the energy consumption of DC systems can be largely reduced.

A DC system using deep lake water was built in Canada in 2002 [19]. The cold water from a depth of 83 m is pumped and transported to the Toronto Island Filtration Plant. The DC system serves 51 high-rise buildings in a high

population density area of downtown Toronto. The chilled water is distributed to users after exchanging heat with the lake water.

Another DC [20], located at Cornell University in USA, extracts cold lake water from a depth of approx. 76 m and circulates that lake water through heat exchangers to provide heat to a district (or campus) chilled-water loop. Auxiliary chillers are used to supply additional cooling when needed.

4.4 INTEGRATION WITH HEAT AND ELECTRICITY PRODUCTION

4.4.1 TRIGENERATION

Trigeneration (Figure 7) is a concept where all heating, cooling and electricity is produced in a single facility. Some of the heat produced by a cogeneration plant can be used to generate chilled water for air conditioning or refrigeration. An absorption chiller can be linked to the CHP to provide this functionality. An absorption chiller can be linked to the CHP to provide this functionality.

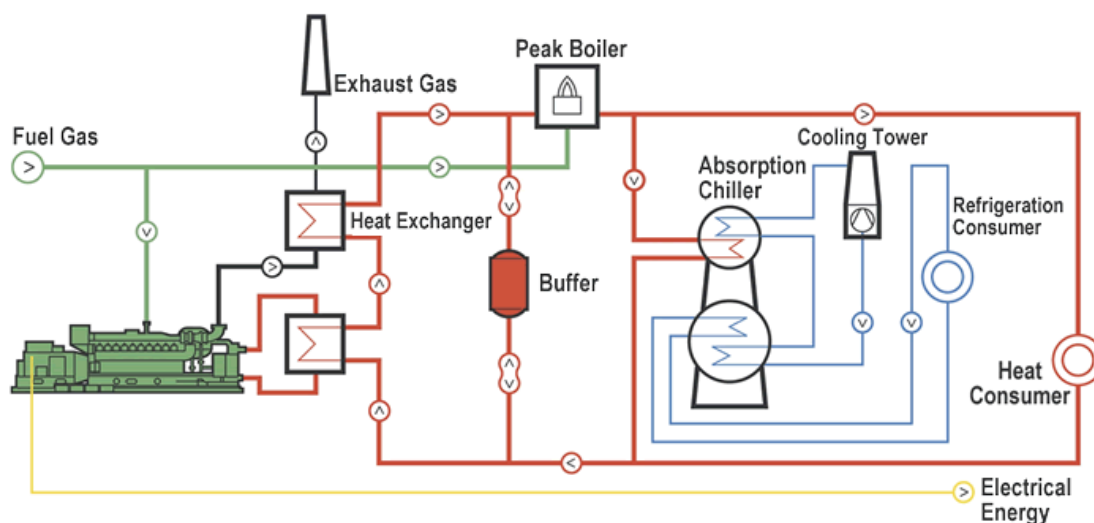

Figure 7: Trigeneration scheme [21]

Compared to plants with single or co-generation, there are several benefits of trigeneration, including:

- Onsite, highly efficient production of electricity and heat;
- Reduced fuel and energy costs;
- Lower electrical usage during peak summer demand;

- Engine heat can be used to produce steam or hot water for onsite use;
- Significant reductions in greenhouse gas emissions;
- No harmful chemical pollutants since water is used as the refrigerant;
- Beneficial for improving building's energy efficiency ratings.

Quad generation goes one step further by extracting carbon dioxide from flue gases. The captured carbon is then either stored ('carbon capture and storage') or stored and utilized as raw material e.g. for synthetic fuels ('carbon capture, storage and utilization').

4.4.2 SOLAR COOLING

Solar cooling is an emerging concept that provides a sustainable, energy-efficient and cost-effective source of cooling. The most important characteristic of solar cooling is that the peak solar production and the peak cooling demand often match well. Solar cooling can be implemented with both solar collectors and solar photovoltaics (PV) when supplying cooling by sorption or compression-based cooling units, respectively.

Regardless of the cooling technology, a solar cooling system can be adapted to produce heating as well. This can be done either by utilizing solar thermal production directly, or by condensing heat from the compression chiller. Excess heat sources, geothermal energy, District Heating and Cooling (DHC) and co-generation systems can also be combined to produce both heating and/or cooling.

By the end of 2015, an estimated 1,350 solar thermal cooling systems had been installed worldwide – around 80% of them in Europe, mainly in Spain, Germany and Italy [22]. At the same time, costs have fallen significantly (more than 50 %) mostly due to standardization.

Solar cooling systems tend to be small in capacity (a few kW), making plants relatively expensive in terms of specific investment costs (€/kW). Larger systems (MW scale) do exist and have been able to achieve better economics [23] mostly due to cheaper industrial size sorption chillers already used by the industry to utilize e.g. excess heat from processes. The market for smaller solar cooling systems is still small.



Flat plate or evacuated tube solar collectors are the most common types of solar cooling, although they represent only a fraction of the total installed solar collectors globally. Most are supplying heat.

Development of solar cooling technology both in terms of energy efficiency and costs are needed for sorption heat pumps to attain significant market share. In addition, backup cooling systems or more preferably cooling storage solutions are essential for solar cooling to cope with cooling demand during night-time.

4.4.3 INTEGRATION WITH RENEWABLE ENERGY SOURCES

By integrating local renewable energy sources (RES) into an electricity grid, the GHG emissions resultant from the usage of fossil fuels can be reduced. Energy efficiency can be improved by coupling the cooling with a combined cooling, heat and power system, as compared with dedicated single effect systems. The efficiency can be further improved operationally by thermal storage to cope with energy demand of DC during peak hours. These linkages are visualized in Figure 8.

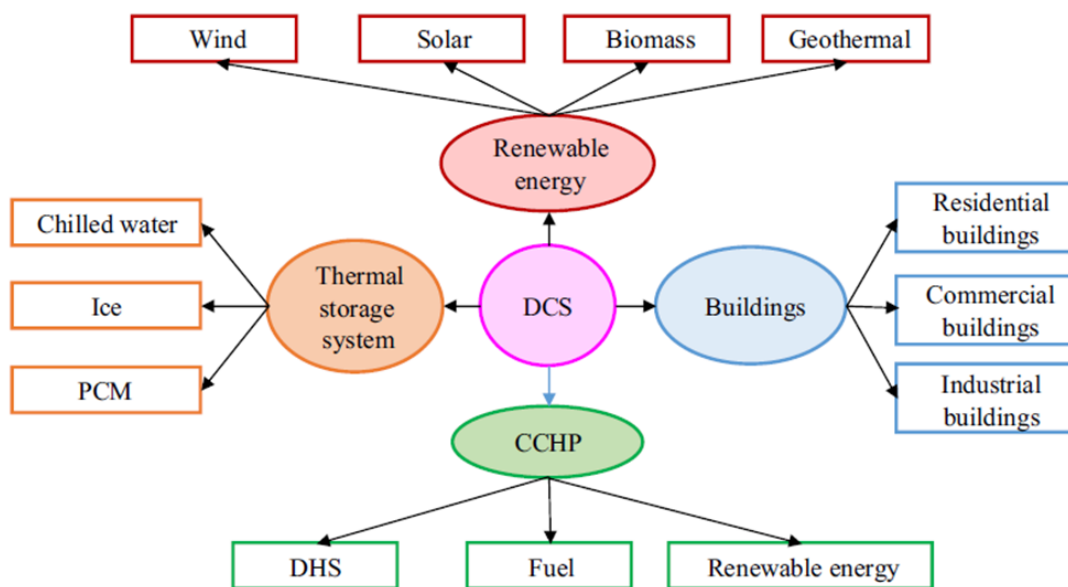

Figure 8: Integration possibilities of different technologies with DC system [15]

Heat gained from combustion of municipal solid waste can also be used to supply cooling to a DC system. Instead of depositing waste into landfills, waste incineration plants supply heat to absorption chillers.

Recovery of excess cooling energy from industrial sources is not as common as utilization of excess heat, but one specific source does exist: gasification of

LNG in e.g. specific terminal facilities for ship transport of LNG. Regasification absorbs large quantities of heat, thus acting as a source of cooling energy. There are two possibilities for recovering the cooling energy: directly, by cooling water through heat exchangers, or by producing ice to be transported to the location where a cooling supply is needed. The choice between the two depends on where the DC system is located.

4.5 THERMAL ENERGY STORAGE

Thermal energy storage is an important element of a cooling supply as cooling demand is characterized by a large variation between daytime and nighttime [3].

There are two types of storage, i.e. day-and-night storage and seasonal storage. Seasonal storage can be ground storage and aquifer storage that is charged during winter and then the cooling from the storage is used during summer. Several technological storage solutions are reviewed in a study by Lanahan et al.[24]. In the following, the solutions limited to short-term thermal storage are addressed.

Thermal storage in a DC system can help reduce both the operational costs and the peak cooling capacity, compared to a DC system without thermal storage. The different solutions for integrating thermal storage with a cooling system are shown in Figure 9.

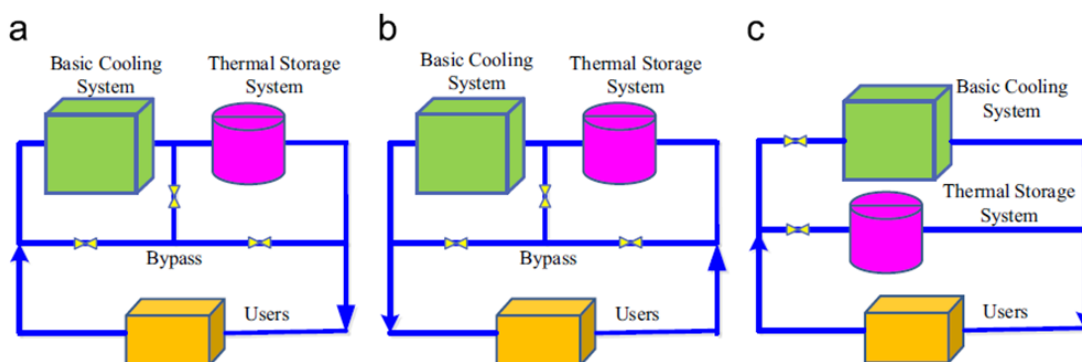

Figure 9: Schemas of DC with different thermal storage systems [15] : serial connection with chillers (a) upstream and (b) downstream; (c) parallel connection.

Thermal storage systems store cold energy during periods of low cooling demand and release the stored cold energy to meet the cooling load at a different time than it was produced. Therefore, cooling storage positively impacts electricity grids by reducing the peak electricity demand.

Simultaneously, cooling costs may be lowered by shifting the electricity consumption to off-peak hours when the energy prices are lower.

Storage is not always economically feasible or even required at all if the tariffs are not significantly different during peak and off-peak hours.

Water is a typical choice for thermal storage medium due to its low cost and high thermal capacity. The temperature of a water-based system is suitable for the evaporation temperature levels required by conventional chillers. Also, using water for thermal storage makes the connection from the storage to a DC system technically relatively simple.

Ice storage is another option, commonly seen in a DC system because it takes advantage of latent heat resulting in smaller required storage volumes. In Paris, both water and ice storage systems are utilized. Three units with a capacity of 140 MWh are used, two ice storage units and one chilled water storage [18]. In China, most of the DC system have ice storage systems.

To conclude, ice storage requires less space, but production of ice requires low evaporation temperatures that lower the energy efficiency of cooling production. Water-based storage can use higher temperatures benefiting from higher efficiencies, but the required storage volume is higher.

Thermal storage also needs to be properly maintained. Issues such as corrosion, scale deposition, and microbiological growth can become a risk if not controlled properly and preemptively.

4.6 FUTURE COOLING TECHNOLOGIES

As the global cooling demand grows [25], there is also a significant demand for new and improved cooling technologies. DC and combined DH&DC systems have significant potential for providing sustainable cooling to urban energy supply.

Trends point towards developing emission-free, renewable and secure energy, which underpins the demonstrated growth of DC system. The future DC system is expected to be more integrated. Connecting the most suitable resources with a city-wide network allows this integration to take place.

Laitinen et al. predict [26] that in the short term (i.e. less than 5 years) there are no signs of major disruptive changes with regard to the present DC system technologies. Moreover, it will take longer than 5 years for the less mature DC system technologies (e.g. magnetic or thermoelastic cooling) to become

integrated into the market of cooling for buildings. Compressor technologies will in the near future still play important role in cooling applications. It is expected that cooling capacities per unit will double and the achievable condensing temperatures will be higher than 100 °C.

Thermally driven cooling technologies (chapter 4.2) which include adsorption, adsorption, and desiccant cooling technologies have technically improved during the last years, especially concerning the temperature levels of the driving heat source. Applicable temperature levels for adsorption technology are as low as 65 - 70 °C, and 75 - 80 °C for absorption technology. The cooling efficiencies of the adsorption and absorption technologies are still relatively low (approx. 0.55 – 0.75) and the investment costs remain high.

There are some signs of mass production of solar cooling applications based on thermally-driven technologies which would decrease the investment costs and make these technologies more attractive [26].

Free cooling technologies (chapter 4.3) will play even more important role in cooling solutions in the future. District cooling solutions will gain popularity in urban areas due to dense volume of buildings.

In the near future, production of cooling energy will be based on existing technologies, i.e. heat pumps (compressors), free cooling, and tri-generation. In new or expanding DC systems, it is possible and will likely be a popular choice to utilise distributed cooling generation, e.g. existing excess cooling capacities of ice rinks, supermarkets, and industry that emanate from more than one source within a DC system.

In the long term, there are signs of the development of the so called 4th generation of smart district heating systems (4DHG) [26]. 4DHG combines all energy networks (heating cooling, electricity) and optimises the total system, e.g. by utilising low temperature technologies and advanced control and automation solutions (smart grids). This technology will be briefly addressed in the chapter 9.6.

OPTIONAL READING

The literature on 4.2.2 Adsorption chiller is done based on [13]

The literature on 4.3 Free cooling is done based on [15][27]

The literature on 4.4.2 Solar cooling is done based on [22][28]



5 BEST PRACTICES OF DISTRICT COOLING SYSTEMS

This chapter illustrates best practices of different innovative and eco-friendly technologies that support sustainable DC systems, including energy efficiency, water efficiency, and low-GWP refrigerants. By utilizing these technologies, high reliability, cost-effectiveness, and sustainability can be achieved in DC systems.

5.1 FREE COOLING (SEAWATER/RIVER COOLING)

The concept of free cooling refers to the use of available cold water to extract energy for cooling. Such cold water can be found in oceans, lakes, rivers or underground water basins. Through heat exchangers, the extracted energy from such water is transferred to the distribution network and delivered to the customers as chilled water for cooling a system inside a building.

Free cooling systems can be developed when the water temperature is cold enough and when the DC system, where the water is carried to, is close to the sea or river. The main advantages of free cooling are the sustainability of using a RES.

This section introduces two best practice cases of free cooling. The Zuidas International Business Hub (IBH) DC project reduces 75% of CO₂ emission by using the lake water as cooling source. The Copenhagen Opera project contributes to HFC/HCFC refrigerant phasing out by combining river cooling and ammonia chillers.

5.1.1 ZUIDAS INTERNATIONAL BUSINESS HUB (IBH) DC PROJECT

This project is located along the highway A10 between Schiphol Airport and the City of Amsterdam in The Netherlands. Zuidas is Amsterdam's international business hub where commercial buildings dominate the prospected areas. The largest finance corporations, international hotels, exhibition halls, a hospital, law firms and IT companies are among the contracted and potential customers.

About 2.5 million m² of office area was planned and constructed in this area and it's one of the densest building areas in the Netherlands. The first delivery of DC started in May 2006. Nuon's first contracted DC customer was head office of Algemene Bank Nederland and the Amsterdamsche-Rotterdamsche Bank (ABN Amro), with a peak cooling demand of 9.6 MW. The existing aquifer cooling system was replaced by DC.



Figure 10: View over the Zuidas area with ABM Amro on the left

The DC production then reached 100 GWh with a mixture of free cooling from the bottom of Lake Nieuwe Meer and chillers. Separate traditional chillers in buildings generally has a relatively low seasonal system EER (energy efficiency ratio) of 2.5, meaning that 1 kWh of electricity is required to produce 2.5 kWh of cooling. By using free cooling from Lake Nieuwe Meer twice that figure can be reached. The lake water temperature at a depth of 30 m is about 5-7°C and can be used for DC production. At periods when the temperature in the lake is too high, chillers adjust the distribution systems supply temperature to 6°C. The return temperature from the customers is 16°C. As a result, only 1 kWh of electricity is needed for producing 10 kWh of cooling. This DC system thus reduces CO₂ emissions by 75% compared to conventional chillers.

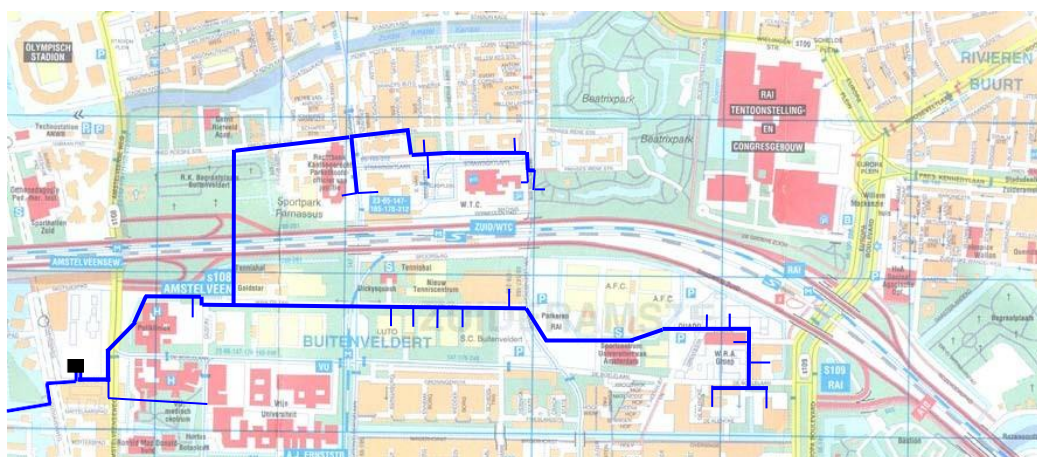

Figure 11: The DC system in Zuidas, Amsterdam

5.1.2 COPENHAGEN OPERA

Another best practice in free cooling was launched in August 2000, by the A.P. Møller and Chastine Mc-Kinney Møller Foundation who donated an opera house to the Danish state. The Opera House is located right up to the waterfront on the island of Holmen - specifically called the Dock Island, in Copenhagen Harbor.



Figure 12: Outlook of Opera Building

The Opera building is totally 41,000 m² and has more than 1,000 rooms including a sound-proof rehearsal auditorium for the orchestra. The Opera House can seat between 1,490 and 1,700 guests depending of the stage setup and size of orchestra to obtain the optimal performance. The indoor climate of the Opera House is controlled by a seawater cooled Heating Ventilation and Air Conditioning system (HVAC), based on free cooling and compression cooling using ammonia R717 as refrigerant, which can contribute to phase out HFC/HCFC.

When the seawater from Öresund River is cold enough the cooling is based solely on free cooling which can save the electricity for chillers and generate energy-savings. The seawater is pumped by the seawater pumps and passes through Bernoulli Filters, 3 x BSG 150, before entering the seawater plate heat exchanger to chill the cooling water. Bernoulli Filters protect the seawater plate heat exchanger from getting clogged up by dirt or organic growth from the

seawater. When the seawater is too warm to be used in free cooling, the seawater is used at the condenser in the chiller system.

Following the good example of free cooling from the same Öresund River, the Copenhagen service provider company Hovedstadsområdets Forsyningsselskab (HOFOR), has built a district cooling system, which also uses river and sea water to chill down the water supplied to the customers. The system supplies commercial buildings such as banks, department stores, and offices as well as data centres and other processes all year round. This district cooling system of HOFOR can help reduce CO₂ emissions by up to 30,000 tons each year. The cooling system now supplies the center of Copenhagen and is expanded in order to supply more customers in the future.

5.2 TRI-GENERATION

Tri-generation is a technology that can feed DC systems by using the waste heat from thermal power plants through absorption chillers and can also supply heating at the same time.

Located in Hengqin island in Zhuhai, People's Republic of China (PRC). The Hengqin Free Trade Zone Trigeneration (FTZ) project was planned since 2010. According to the 'Urban Planning and Development Regulation' for FTZ, which was authorized by the PRC government in 2009, the area is defined as an eco-friendly region as a pilot project. The major objectives in the Regulation include:

- 1) Primary energy efficiency. Common primary energy sources are coal, oil, natural gas, and biomass (such as wood). Other primary energy sources available include nuclear energy from radioactive substances, thermal energy stored in earth's interior, and potential energy due to earth's gravity. Primary energy efficiency in district cooling systems, also as primary energy factor (PEF), is the ratio between the primary energy input and the cooling energy at the primary side of all the ETS. The total primary energy efficiency in the newly built area, including electricity, heating/cooling and domestic hot water, should be at least 75%;
- 2) Green building. All the commercial and public buildings in the area should be at least certified by the Chinese green building rating system;
- 3) GHG emission. The energy consumption per GDP should be 20% lower than the average level of Zhuhai city in 2025. The CO₂ emission per

GDP in the New Area should be 30% less than the average level of Zhuhai City in 2025;

- 4) Heat island effect control. The term heat island effect is used to refer to any area that is relatively hotter than the surrounding. The main cause is from the modification of land surfaces. Heat generated by energy usage of human activities is a secondary contributor. The heat island effect in central business district in FTZ should not exceed 1°C.

As part of the smart city plan for this particular Chinese zone, a tri-generation system (also known as Combined Cooling Heating and Power, CCHP), is considered by the FTZ municipality to be a cost-effective solution to enhance sustainability and energy efficiency. Absorption chillers use waste heat from electricity generators for cooling, and the condensed heat from absorption chillers can be used for domestic hot water. Due to the unbalance in demand for heating and cooling, other kinds of cooling technologies, including conventional electricity chillers, storage of chilled water and ice, are to be integrated in the system as the addition of absorption chillers.

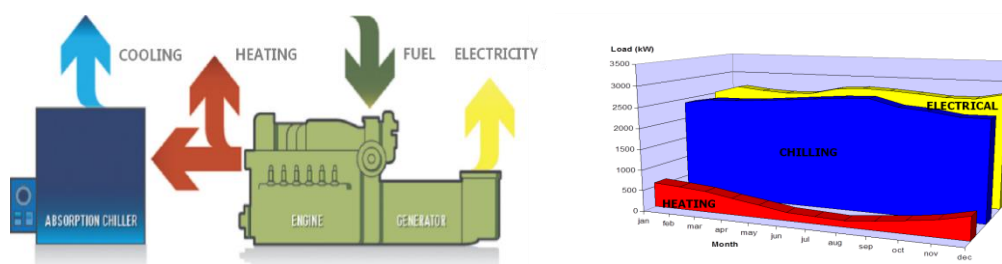

Figure 13: The CCHP system

The CCHP system in Hengqin includes a 390 MW power plant with Liquefied Natural Gas input and nine energy centers in different areas of the island. It supplies chilled water for HVAC cooling to a total area of 15 million m² comprised of commercial and public buildings, including shopping malls, office buildings, luxurious residential apartments, high-level hotels, and city complex (mixed used high-rise commercial buildings) etc.

Based on the development plan of the New Area, the CCHP system is also divided into different phases. As shown in the table below (from project feasibility study in 2010). The power plant has finished construction and has been in operation since 2015. For the energy stations of phase 1, station n.3 is operating since 2016, while the other stations are under construction and planned to operate between 2019 and 2020.



Figure 14: the DC system in Hengqin, PRC

By June of 2017, the DC system was providing chilled water for 11 building clusters with a total cooling capacity of 200,000 tons. The DC service provider had signed cooling/heating contracts with 11 customers for 76 building clusters.



Table 3: Cooling capacity

	Phase 1	Phase 2
	Energy station n. 1, 3, 7, 11	Energy station n. 2, 4, 5, 6, 8, 9, 10
Annual cooling supply (GWh)	467	951
Cooling capacity (RT)	85,700	17,4000
Annual steam consumption (tons)	398,000	890,000
Annual electricity consumption (GWh)	47	84
Annual water consumption (tons)	792,000	1,680,000
Investment (million RMB)	910	1,850

5.3 DISTRICT COOLING SYSTEM WITH LARGE-SCALE THERMAL STORAGE

Another emerging technology that contributes to DC is large-scale thermal storage. This section introduces two best practice of this technology in the level of a university campus and a city. It shows the benefits as lower operation cost, peak load shaving and higher energy efficiency.

5.3.1 CAIRNS CAMPUS

The Cairns campus of James Cook University (JCU) is located in the coastal tropics and peak summer air conditioning loads are high with a year-round requirement for cooling. Annual energy usage of air conditioning units is therefore high and represents a significant part of the University's operating costs. JCU's central chiller plant consumes 50% less energy compared to an air-cooled package plant. The thermal storage system can be charged when

cooling demand is lower than the average and released when cooling demand is higher than the average.

The aged chiller plant in the existing plantroom could not be upgraded without substantial capital cost as the plantroom and services were not capable of handling the larger chillers along with the higher electricity requirements and increased water flow. As it was not feasible to upgrade the chiller plantroom it was decided to future proof the campus by constructing a new Campus DC system including a Central energy plant to house high efficiency chillers and cooling towers and an adjacent thermal energy storage tank.

The central energy plant is the centralized plant for the DC system. It contains the chillers, cooling towers, pumps and the chilled water storage. It offers the benefits of high efficiency, reduced maintenance, ease of expansion and technological upgrades. For such large centralized plants ‘redundancy’ or back-up systems are included in the system architecture, which allows for continuous supply in the event of a component failure.



Figure 15: DC system with large scale thermal energy storage

Thermal energy storage makes use of periods of the day or night when the site demand for cooling is less than the average demand. During these times the central chilled water plant cools return water (15°C) back to chilled water (6°C). During times when the site demand exceeds the average demand (typically in the afternoon), the chilled water is drawn from the storage tank. From here, the pre-chilled water is then reticulated throughout the campus and delivered to air conditioning and air handling units within each building. The installation of air conditioning units within the buildings themselves remains essentially the same as any conventional chilled water system, except that the chiller plant takes the form of one efficient centralized plant rather than numerous different cooling plants. The central energy plant can be up to 2.5 times more efficient than the aged smaller chiller plant.

The central energy plant operates at a system Coefficient Of Performance (COP) between 5.5 and 7.5 compared with a conventional air-cooled package plant at 2.8 to 3.1. In addition to the energy savings, the reduction in site electricity demand provided further operating cost savings of 40% over traditional systems.

5.3.2 HELSINKI

DC customers in Helsinki include new construction or renovation managers for commercial buildings such as hotels, and shopping centers. The first DC-supplied residential buildings are also in process of being connected to the existing DC system. Both existing and new buildings are potential DC customers.

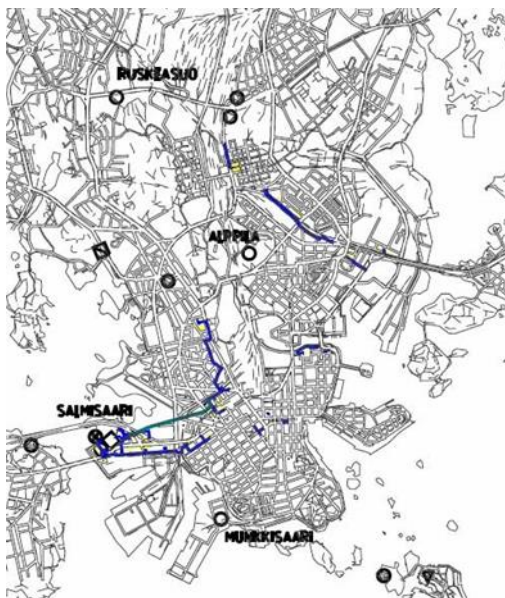

Figure 16: Map of network

When delivered to the customers, the DC water temperature is +8°C. The temperature of return chilled water is +16°C.

As compared to building-specific cooling solutions, DC has proved to be a competitive alternative to compression chillers and cooling towers, evidenced by its cost-effectiveness and technical capabilities. Building owners in Helsinki want to concentrate on their core business areas, which do not include investing in individual energy production or continuous maintenance of such equipment. Changes in the electricity market prices, restrictions to the use of cooling refrigerants, uncertainties about future taxes and other legislation factors make DC an attractive alternative. With DC the long-term cooling costs are

predictable and stable, which is also an important asset. Also, reduction of noise pollution due to absence of condensers adds value to the property. This, together with less required space for cooling production, is of interest to the building owners.

Helen Ltd. is a DC supplier in Finland, who produces electricity by cogeneration. In the winter, the heat from cogeneration is used for DH. In the summer, this heat demand is lower making excess heat available to absorption chillers to produce cooling energy. In the absorption processes, sea water is used for re-cooling. Helen now has 35 MW in absorption chiller capacity for DC production. A total of 10 chillers (3.5 MW each) are located in Salmisaari CHP plant. The heat source for the absorption technique is 85°C DH water.

Helen also has nine transportable cooling units, which enable a quick launch of cooling services in a totally new customer area. As soon as the final pipe connection is built from the DC center to the customer, the cooling unit is moved to a new location. The cooling units from Helsinki Energy have a cooling capacity between 400-1,500 kW.

Helen Ltd. also operates the world's largest combined DHC production facility using waste water as heat source. The DC capacity of the facility is 60 MW and the DH capacity is 90 MW. This heat pump facility is located underneath Katri Vala Park.

The facility was mainly in DH production, and in summertime it is used in normal load DC production together with the absorption chiller centers. In the future, cooling energy will also be produced in large compression chiller centers. The technique is at its best in peak load and backup electricity production. The centers will be operated to cut down the peak load energy demand and to re-cool the cooling water reserves. Cooling water reserves provide flexibility for cold energy production. At the moment, Helsinki Energy has one 1,000 m³ chilled water storage in Salmisaari and in total 300 m³ storage in Pitäjänmäki. New 10,000 m³ cooling water storage are planned to be built in Salmisaari, Hanasaari and in connection to the shared use service tunnels. The water storage is cooled during the night when the cooling demand is lower. The storages enable operating the coolers at maximum effective 100% drive. The stored water-cooling energy is then used during the next day peak load hours.

Helen also started the operation of a new heat pump facility under the Esplanadi park. The new facility is similar to Katri-Vala plant; producing heating and cooling. The total capacity of the heat pumps are 50 MW of cooling and 22 MW



of heating. Helen recently announced the development of a sea water-based heat pump facility in Vuosaari.

The continuing interest towards heat pump technology as a source of heating and cooling for the city of Helsinki is due to emission reduction targets. Finland is banning coal in energy use by 2029, thus closing the CHP plants. The first one (Hanasaari) will be decommissioned already in 2024. The effort to replace the heat production capacity is underway and using DC is part of this process.



Figure 17: Installations in Helsinki

5.4 DISTRICT COOLING SYSTEM WITH WASTEWATER ENERGY

This section introduces a best practice related to using wastewater as energy sources for DC in China. Even though the Chinese case is highlighted, this technology was actually utilized world-widely, like the Helsinki DC system developed by Helen Ltd. described in chapter 5.3.2.

5.4.1 OVERVIEW OF LONGHU FINANCIAL CENTRE DHC PROJECT

A project located in a new district of Zhengzhou in central PRC called Longhu Financial Centre. The Longhu Financial center is planned to be the regional headquarters of financial companies or organizations in the middle part of China. Due to its importance, the local government invited top urban planning and architectural design firms to bid for the DC project.

The 'Urban Planning and Development Regulation' for FTZ in 2009, as described in chapter 5.2, was fully studied by the municipality of Zhengzhou. The municipality considered the advantages of standards for urban planning and smart city and decided to move one more step further. During the early stage of urban planning of the Longhu Financial Center, several public service providers, including transportation, water and electricity supply, internet cable,

wastewater and heating/cooling suppliers, collaborated on the documentation. All the transportation should go underground, on top of a pipe corridor. Meanwhile, there are chapters of green buildings, building energy efficiency, DHC system and wastewater reuse etc.



Figure 18: Overview of the new district of Longhu Financial Center, Zhengzhou, PRC

5.4.2 MAJOR TECHNICAL PARAMETERS

According to the urban planning, there are three DHC systems on the island. The pipelines of treated wastewater are constructed together with the metro line beneath the lake. The heating/cooling pipelines on the island are connected among all the three plants to make a circle. All the main pipes on the island have been constructed inside of underground pipeline corridor. Heating/Cooling supply distance is no more than 650 m.

The DHC system in Longhu covers 3.1 million m² of built-up area. The total installed capacity for cooling reaches 234 MW, while heating capacity is 101 MW.

Table 4: Building area

Building type	Built-up area (m ²)	Percentage (%)
Commercial office	2,171,104	69.25
Entertainment/shopping mall	21,0945	6.73
Public Service	27,598	0.88



Hotel	725,744	23.15
Sum	3,135,391	100.00

According to Regulation of heating usage and management in Zhengzhou published by the municipality, heating supply in Zhengzhou is mandatory, while cooling supply is not, but it is commonly used to increase indoor thermal comfort. The regulated heating season is from 15th, November to 31st, March which is also regulated by the local government. The unregulated cooling season in this Longhu project is more flexible, normally from 15th, May to 30th, September. According to the climate in Zhengzhou, the swing season mainly lies on the months of April and October. In the swing season, the demand from customers should be heating or cooling. And it may differ day by day.

Due to the unbalanced heating and cooling demand, the distribution system shares the same 4-pipe network. In winter, two of the pipelines supply heating, while another works as stand-by or cooling supply. In summer, all the pipes supply cooling. The employment of wastewater heat reuse gives the DHC system more flexibility in providing heating or cooling or both at the same time to the customers. The wastewater is used to replace cooling towers for cooling in summer and operate as heat pumps for heating in winter.

Main settings of heating/cooling are:

- Heating water temperature: 41/51°C;
- Cooling water temperature: 4.5/12.5°C.

As all the supply temperature values are different from the standard conditions of HVAC equipment, a further calibration of actual heating/cooling supply ability is carried out.

According to the positions of different water treatment factories around the Longhu area, Matougang is the closest one, within 4 km. Parameters of hourly output flow rate, temperature and quality of treated waste water in that factory were measured for the whole year of 2015, as listed below. Based on these data, how much water to be distributed to the plants can be calculated, as listed below.

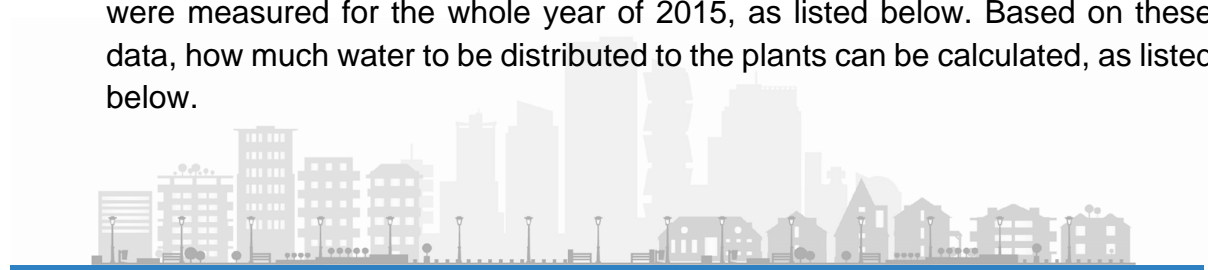

Table 5: Waste water usage

District energy plant	Cooling		Heating	
	Hourly max waste water usage (m ³ /h)	Daily waste water volume (m ³ /d)	Hourly max waste water usage (m ³ /h)	Daily waste water volume (m ³ /d)
1	5,209	96,276	4,799	73,347
2	5,209	96,231	4,824	73,615
3	5,209	99,986	4,086	69,888

5.4.3 ENVIRONMENTAL IMPACTS AND BENEFITS

5.4.3.1 EVALUATION OF NOISE LEVEL

Because noise from cooling towers may highly impact on the local environment, the Longhu DHC design team worked closely with an urban planning consulting team to choose locations based on noise simulations to make sure the noise level around those areas have less impacts on buildings nearby. According to the simulation results, the noise level on the façade of surrounding buildings is less than 55 dBA in day-time and 45 dBA in night-time.

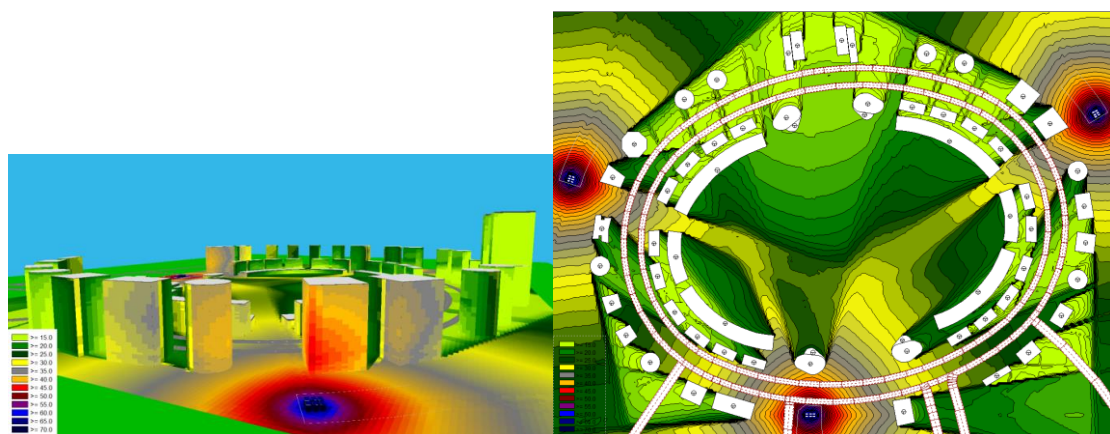

Figure 19: Evaluation of noise level



5.4.3.2 EVALUATION OF USING LAKE WATER FOR COOLING

The region is surrounded by Longhu Lake, which contains over 50,000 m² of water surface with average depth of 5 m. The discussion of using lake water for cooling began since very early stage of urban planning. Through a long-term (120 days) CFD simulation, the results show that the heat from cooling system into the lake increases the water temperature to 1.2°C and it is harmful to the bio systems. Based on the result, the project developers gave up the plan of using lake water for cooling.

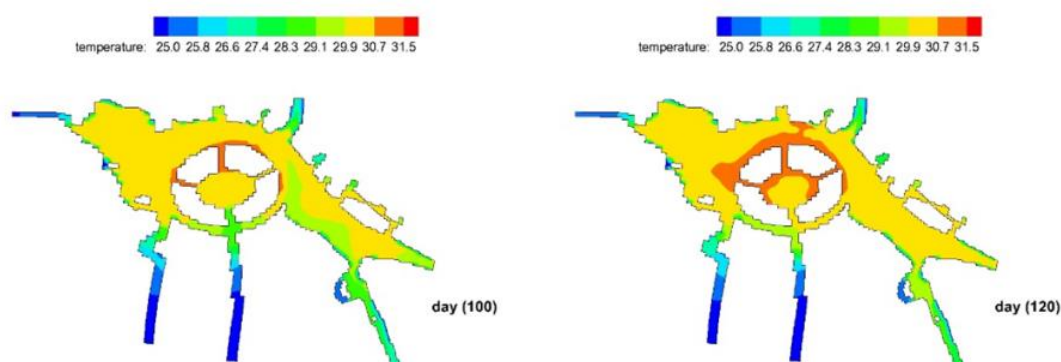

Figure 20: Water temperature

Compared with traditional standalone cooling systems of 3.1 million m² of buildings the DHC system in Longhu region brings following benefits to the environment as well as to customers:

- 1) Save electricity for cooling at 126 million kWh per year;
- 2) Save water for cooling tower at 1.2 million tons per year;
- 3) Reduce CO₂ emission of 0.14 million tons per year;
- 4) Reduce SO₂ emission of 871 tons per year;
- 5) Save mechanical rooms in the customers side of 40,000 m²;
- 6) Save investments in the customers side on the HVAC and electrical transformer equipment of 0.25 billion RMB.



5.4.4 EVALUATION OF THE OVERALL EXPERIENCE

Guidance of local government: The local government plays an important part on integrated the DHC system to urban planning. However, after urban planning, it handed to whole project to the market and changed its role from the lead to the assist. The local government helped in coordinating all the necessary regulations, design guidelines and policy to support the project development.

Technical solutions for affordable heating and cooling: In the area of Zhengzhou, heating and cooling season only cover 4 months respectively. Due to relative low demand for heating and cooling, it is very expensive if DHC system only supplies one of them. However, by using the heat from wastewater, it is possible to combine both of them to make the whole system cost-effective. The distributed network has 4 pipes. In the summer, all the 4 pipes are used for cooling. In the winter, 2 pipes are used for heating while the other 2 pipes are used for cooling as some of the buildings (such as computer server rooms) require cooling all year long.

Off-peak tariff for thermal energy storage: Even though thermal energy storage is applied to a large number of projects as one of the energy efficient solutions, the tariff of electricity in Zhengzhou is relative expensive. It does not consider lower price during the off-peak period. As a result, thermal energy storage is not cost-effective.

The quality of treated wastewater can achieve the requirement for washing, cleaning etc., not for drinking. However, the current DHC system only uses such water for heating and cooling via heat exchangers. Actually, it can be used widely as sewage water, landscaping water etc. after the heat exchanges, which reduces the demand for fresh water in the region.

5.5 COMBINED DISTRICT HEATING AND COOLING SYSTEMS

When combining DH and DC systems as one comprehensive DHC system, not only heating and cooling sources should be considered, also the distribution system. For heating and cooling, both tri-generation and wastewater energy can be considered as described in previous sections in this chapter. As for the distribution system, 2 pipes and 4 pipes can be considered. The 2 pipe system can only supply heating or cooling at once, whereas a 4 pipe system can supply both simultaneously. This depends on the customers' requirements, and also needs to consider financial parameters, including investment and pay-pack period to see if it is viable to supply both heating and cooling.

Starting in the early 1990's DC has had a rapid development in Sweden. The reason for the rapid development is because of the political decision to phase out CFC and HCFC-based products that – as established in Chapter 2 – are extremely aggressive to the ozone layer. Due to the fact that the cooling demand in southern Europe outweighs its southern counterparts, Sweden is a notable exception to the lack of penetration of large-scale DC systems in Europe. Sweden may also uptake DC easier than other EU Member States since property owners are well-versed in purchasing heat from DH suppliers, hence the learning curve is conceivably reduced.

One pleasing surprise regarding DC implementation in Sweden, is that the utilization period of cooling has turned out to be significantly longer than expected. Cooling is necessary not only because of Sweden's warm weather, but also because of significant year-round cooling demands required for process cooling of computers, refrigerating/freezing equipment, etc. Being that most, if not all energy systems experience summer electricity peaks, the electricity savings provided by DC brings about positive socioeconomic and technical impact.

The following Stockholm example shows that also in systems with winter electricity peaks, DC gives a sizable reduction. Stockholm Exergi presently sells 500 GWh of DC per year to its customers. **If that cooling had been produced conventionally, it would have required five times more electric energy. That is to say that DC means an 80% reduction of the electricity requirement for cooling.** The Stockholm scheme consists of different systems ranging from 3 MW to 228 MW. The largest system today is the DC system for the central parts of Stockholm. 228 MW of DC in customer connections is now integrated from earlier several smaller and temporary systems.



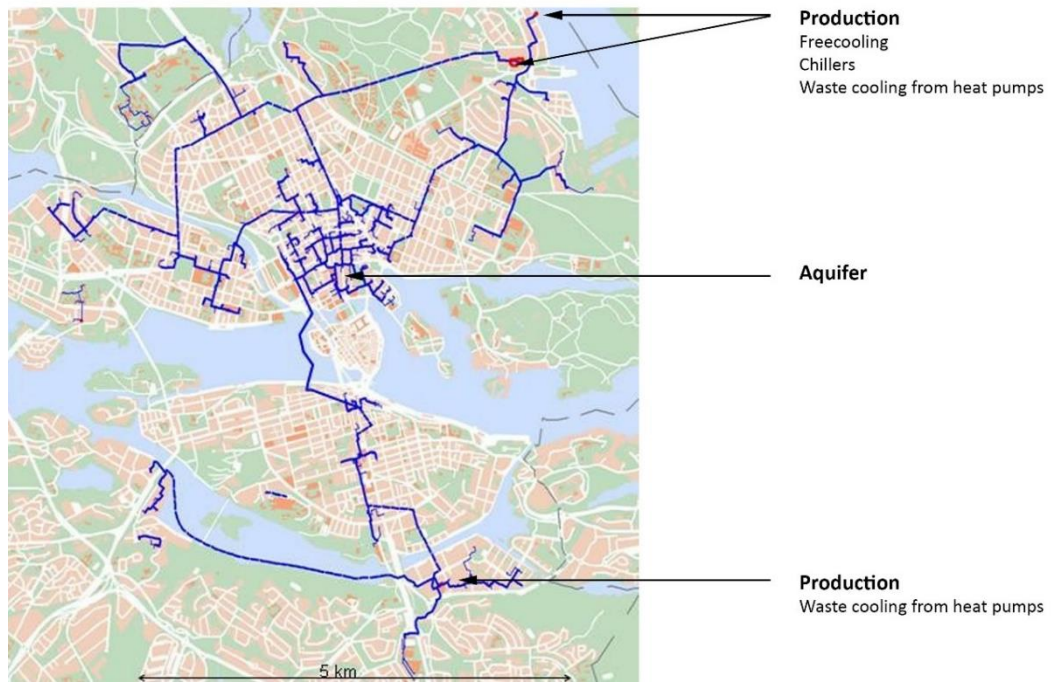
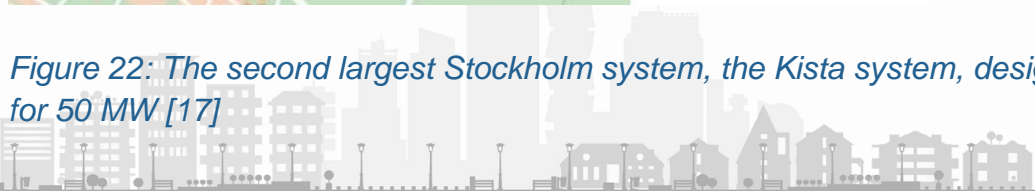

Figure 21: The Stockholm City DC system [17]



Figure 22: The second largest Stockholm system, the Kista system, designed for 50 MW [17]



OPTIONAL READING

The literature on 5.1.2 is done based on [29][30]

The literature on 5.3.2 is done based on [31][29][32][33][34][35]

The literature on 5.5 is done based on [29][36]



6 DESIGN OF DISTRICT COOLING SYSTEMS

6.1 ASSESSING FEASIBILITY OF A DC SYSTEM

6.1.1 NECESSITY

DC systems are generally built and operated by a separate service provider offering a cooling service for a number of buildings (chapter 10). The cooling supply is centralized and distributed through a network of pipes. This makes it different from conventional standalone cooling systems in buildings maintained and operated by building owners themselves or by another company. The large-scale cooling production and the distribution network also make the required investment reasonably high. Also, the cooling demand needs to be estimated in medium to long-term as the districts continue to develop and expand and need to be considered in planning of the system.

Therefore, analyzing the economic feasibility of a DC project at an early stage of the development is required.

6.1.2 FEASIBILITY STUDY

The main technical analysis in this feasibility study includes the steps discussed in the following chapters 6.1.2.1 – 6.1.2.3:

6.1.2.1 COOLING DEMAND PREDICTION

The purpose of predicting the cooling demand is to determine the total required capacity of the DC system. The results of cooling demand prediction directly relate to the size of the DC system, including pipe network, plant size and energy supply systems, as well as the total construction investment. Figure 23 outlines the basic operational steps of typical DC project development strategy, from energy planning to final technical solutions.



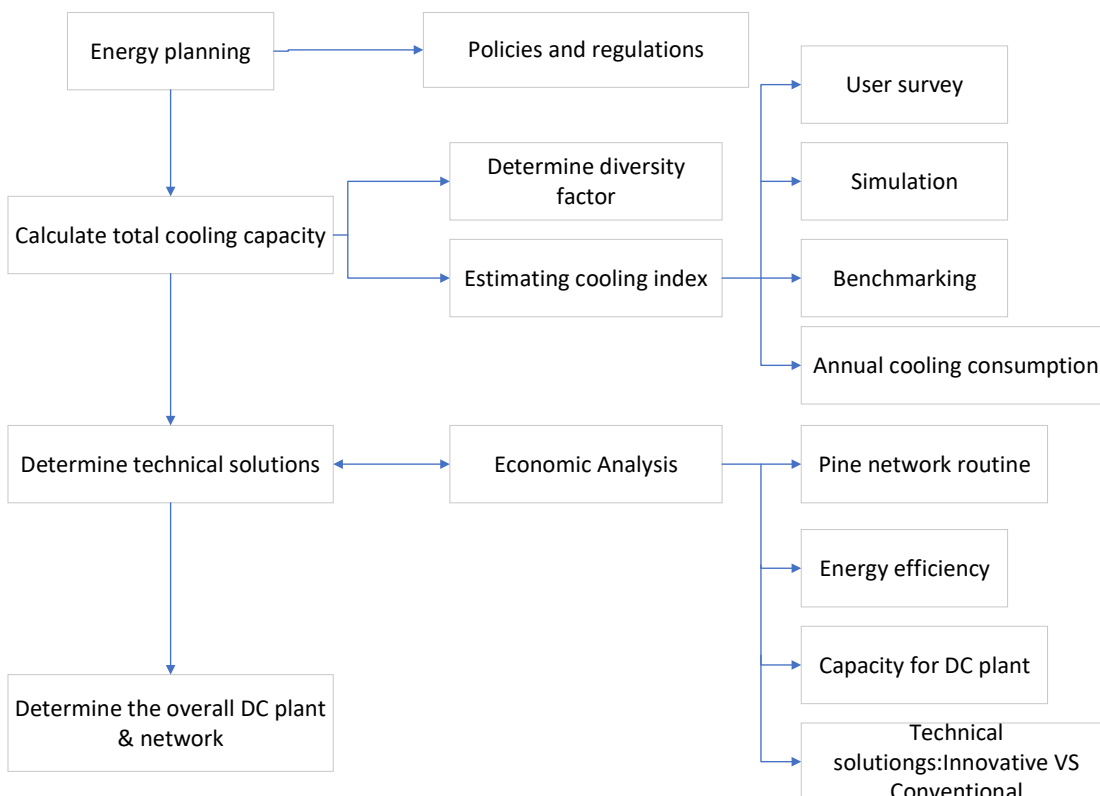

Figure 23: Basic steps to develop DC system from energy planning to final technical solutions

One challenge in DC project development is that the data required for predicting cooling demand is different for various building types. To finalize the system size, one must determine the annual cooling demand, which relates to how buildings were constructed, envelope energy efficiency and occupancy ratio, occupants' habits, and development plans for the DC system in general.

Two methodologies can be used to define cooling capacity depending on the DC system ownership:

- Type 1: The DC system is planned, constructed, and operated by a real estate company to supply chilled water to their own buildings. In this case the cooling demands are known and the DC system is planned at the same time. The key factor in determining the required capacity of the DC system is to verify the suitable diversity factors of cooling demand in the different buildings to be supplied. This type of DC system is common in areas with large public buildings, such as train terminals, airports.
- Type 2: The DC system is planned, constructed and operated by a separate company, who sells chilled water as a product to the customers

building(s). The number of customers building(s) connected to the DC system is not fixed at the beginning of the design process, so the system may need to expand as more and more customers decide to connect later. The total cooling capacity can therefore not be fully determined in this case, so it is necessary to consider possibilities for future expansion. The key point for this type of DC systems is to predict future cooling demand and verify the diversity factor. This scenario is common in multi-purpose commercial buildings, including central business districts, among others. Typically, the systems include many kinds of buildings.

6.1.2.2 DIVERSITY FACTOR

The most important dataset for determining cooling capacity and subsequent required size of the DC system to be installed, is diversity factor, especially in the case of multiple buildings of different end-use typology. The main elements to consider in diversity factors are:

- Building typology;
- Quantity and location of DC systems in urban planning;
- Occupancy habits of different building types;
- Climate and weather, indoor comfort requirements and local economic conditions.

The diversity factor can be calculated as

$$Diversity\ factor = \frac{Sum\ of\ cooling\ demand\ of\ all\ customers\ buildings}{Cooling\ demand\ in\ the\ design\ day\ of\ all\ customers\ buildings}$$

Table 6 summarizes diversity factors for different district types.



Table 6: Diversity factors for different district types [37]

District types	Diversity factor	Main building types and functions
University campus	0.49~0.55	Campus buildings including classrooms, laboratory, library, administrative offices, gymnasium, dormitory and canteens
Business district	0.7~0.77	Central business district, including office buildings, hotels, shopping malls and other types of commercial buildings
Mix-developed district	0.65~0.7	Mix of different building types, including commercial buildings, public buildings, campus buildings, etc.

6.1.2.3 CAPACITY, NUMBER AND LOCATION OF DC SYSTEMS

The capacity and number of DC systems are an example of inter-related parameters present in planning and design phases of DC, which require technical and economic analysis. Generally, as the cooling demand and required capacity grows, more investments for extending the distribution network are required. As a result, the share of energy consumption related to distribution is higher in the total energy consumption. Based on e.g. Chinese engineering practices, as a balance of investment and operation fee, the suggested radius covered by a DC system should not exceed 2~3 km.

The following three main parameters to be considered for assessing the distribution:

- Heat loss in the distribution network. The maximum temperature difference between a DC system and its ETS located in customers buildings should be less than 0.5 – 0.8°C, while heat/cold losses in the distribution network should be less than 6%;
- Distribution network investment. The investment should not exceed 12% of total investment (For brownfield or retrofit projects, this number can raise to 15%);
- Distribution energy consumption. For DC systems based on electric compression chillers, energy consumption for distribution should not exceed 15% of total energy consumption.

Locations for the DC system and planning the distribution network are part of the urban planning process. The best location for cooling supply is as close as possible to the demand. Initial investment, operational costs and possible future expansion needs to be considered.

6.2 BUILDING-LEVEL REQUIREMENTS FOR DC INTEGRATION

DC can be applied to a group of buildings that fulfill the following technical boundary conditions:

The first condition is on the cooling demand: since connecting a customer requires an economic investment (connection pipes must be installed to reach the building) and operation costs (pumping energy, maintenance of that specific branch, measuring of supplied energy etc.), the customer's demand must be high enough to cover those expenses along the lifetime of the system. This approach may vary according to local conditions, e.g. where the DC service provider is controlled by a public administration not prioritising pure economic performance. Nevertheless, even in such situation the DC system service provider must be aware of the economics, therefore a careful evaluation of a customer's energy demand is needed. It is not possible to give a general threshold in terms of cooling degree days (CDD) or equivalent full-load operation, as those parameters depend on many local factors (cost of energy, cost of men work, cost of equipment, cost of the operating license, if any, etc.). Some typologies of customers, though, can be considered more appealing than others: tertiary buildings are typically good customers, as they are used along the day, often have large portions of glass facades, have significant internal gains (computers, lighting etc.). Residential buildings are in general less appealing due to relatively low internal gains, limited glass surfaces, and because they are used especially in the morning and in the afternoon, when no or little solar gains increase cooling demand.

Another crucial condition for DC to be successfully applicable relates to the cooling systems installed in the buildings to be connected. In case of new buildings, interaction with project developers and designers should in general solve major issues, whereas when it comes to existing buildings a careful evaluation shall be made. In brief, one can state that some cooling systems are not suitable, for example room air conditioners with split technology and Variable Refrigerant Flow (VRF), because those systems base on refrigerants flowing around the building. DC is providing chilled water on the primary side of the network and needs a chilled water-based distribution in the

buildings. Chilled water systems are therefore suitable (fan-coils, chilled radiant floor, chilled ceiling, chilled beams etc.). Air-based air conditioning is also suitable if centralized air handling units are installed: in this case DC can provide cold water to the cooling section of the air handling unit. Besides the typology of cooling system, nominal operating conditions must also be checked: DC requires the ΔT along the distribution system to be as high as possible in order to decrease losses along the network. Typical values are around 10 K. If lower ΔT is found, a deeper analysis might show the possibility of regulating the distribution system in a way that it is increased to the desired value.

Additional conditions to be fulfilled by customers are related to available space in the technical premises: DC requires a ETS to be installed (usually in the basement), together with other technical equipment such as pipes, energy meters, insulation, electrical panel. In case no technical room exists, a building might not be suitable for connection to a DC system.

Table 7: Direct and indirect interconnections [12]

Issue	Direct Connection	Indirect Connection
Water Quality	DC system water is exposed to a building system which may have lower levels of treatment and filtering. Components within existing building systems may have scale and corrosion.	Water quality of the DC system is isolated from building system and can be controlled.
Water consumption	Leakage and consumption of DC system water within the building may be difficult to control and correct.	Water leakage is within the control of the district heating service provider.
Contractual	Demarcation of consumer's building system may not be clear.	Clear delineation between the consumer and district cooling service provider equipment.
Cost	Generally lower in overall cost due to the absence of a heat exchanger and possible deletion of building pumps and controls.	Higher cost due to a heat exchanger and additional controls.

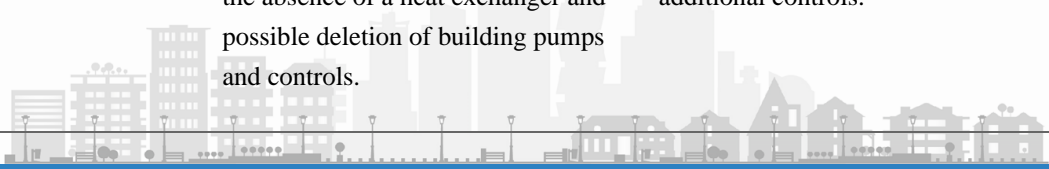

Reliability	Failures within the building may cause problems or potentially even outages for the district system.	The DC system is largely isolated of any problems in the building beyond the interconnection.
Pressure Isolation	Building systems may need to be protected from higher pressure in a DC system or for tall buildings, a DC system may be subjected to higher pressures by the building system.	The heat exchanger provides isolation from building system pressure from the DC system pressure and each may operate at their preferred pressures without influence from the other.
ΔT	Potential for greater ΔT due to absence of heat exchanger.	Approach temperature in heat exchanger is a detriment to ΔT .
In-building Space Requirements	Low space requirements.	Additional space required for heat exchanger and controls

Using multiple ETS increases the reliability of DC cooling services, but also increases the costs of the installation. The number of ETS depends on the profile, seasonal variation and type of the cooling demand. The following aspects should be addressed with regard to DC connections, especially concerning ETS:

- Match the cooling demand and the design capacity as closely as possible; number of units make operational optimization easier, but usually increase the costs and require more floor area;
- Consider building cooling system and DC system temperature levels in parallel;
- Identify the nature of individual cooling demand within the building, taking into account the reliability and maintenance needs of the envisaged DC cooling service; e.g. maintenance during uninterrupted service needs a full capacity backup unit;
- Consider the pressure difference requirements for all equipment e.g. in case of a high-rise building (over 20 floors), the design pressure may be over 10 bars.

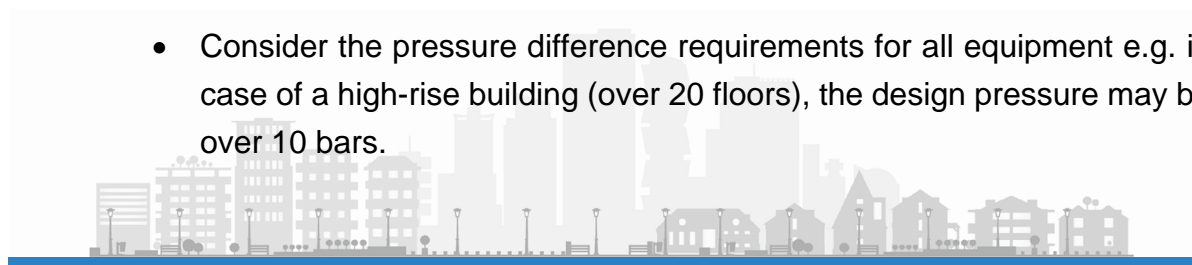

6.3 DIMENSIONING A DC SYSTEM

6.3.1 COOLING PRODUCTION

Several parameters affect the selection of technical solutions in a DC system and the output temperature of chilled water:

- Energy supply options, including possible access to electricity (high voltage), steam, natural gas, waste heat and free cooling etc;
- Recommendations of urban energy planning and guidance of regulations and policies;
- CAPEX, OPEX;
- Location and size of the DC system.
- Regardless which cooling technology is selected, reliability, economic viability and sustainability remain top priority.
- Cooling productions of different cooling technologies are summarized in *Table 8*

Table 8: Cooling production

Energy source	Cooling source	Chilled water temperature - Supply/Return (°C)	Advantages & disadvantages
Electricity	Electric-driven screw or centrifugal chillers (380V/6KV/10KV)	5-6 / 13-15	Low initial investment, simple management and maintenance
	Electric-driven chillers with thermal storage	1.1-3 / 13-15	Lower initial investment for electricity supply system and distribution network, less distribution energy consumption, higher energy consumption for chillers, complicated

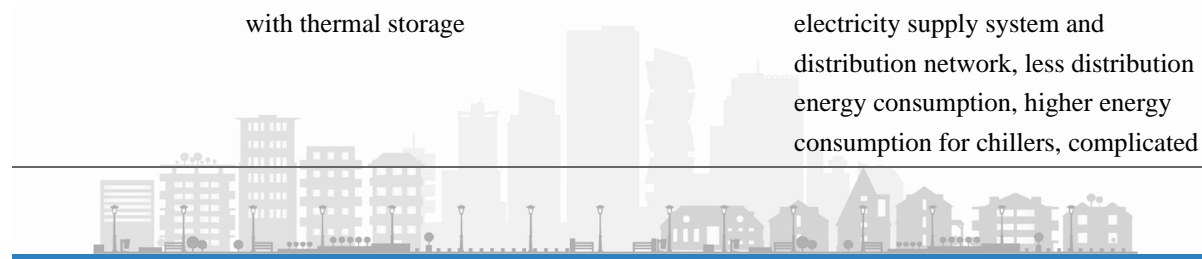

			operation, peak electrical load shifting
Natural gas, oil	Direct-fired absorption chiller	6.5-7 / 13-15	Requires steady supply (price and quantity) of primary energy
Access heat from power plants (Steam or hot water)	Absorption chiller	6.5-7 / 13-15	Requires to combine with the energy system in power plants for higher primary energy efficiency
	Steam driven centrifugal/screw chillers	3-4 / 13-15	Suitable for the areas with abundant supply of gas but lack of electricity
Geothermal	Ground-source/water-source chillers	6.5-7 / 13-15	Relatively higher initial investment
Free cooling			
Multiple energy sources	Combination of absorption chillers and electric chillers, free cooling etc.	3-4 / 13-15	Requires operation mode to benefit the incentive tariff of different energy source to reduce operation fee

6.3.2 THERMAL ENERGY STORAGE

Thermal energy storage systems (technologies addressed in chapter 4.5) have been proven to bring economic benefits for customers (due to lower cooling price), for service providers (due to competitive reduction in operating costs) and grid companies (due to reduction in overall investment on power plants and region-level transformers).

As the cooling demand of customers buildings connected to DC systems can be very high and fluctuating, the technologies of thermal energy storage are widely used to shave the peak loads and increase the reliability of chilled water supply. However, there are two critical questions in integrating thermal energy storage into DC cooling systems.

Firstly, it is necessary to determine what kind of thermal energy technologies to use. Looking through the best practices of DC systems across different countries, there are various types of storage technologies implemented. The most commonly-used ones include ice and chilled water

storage. However, even for ice storages, various technical solutions are available, including ice harvesting, external or internal melt ice coil and encapsulated ice. A comparison of these technologies on different technical parameters is shown in Table 9.

Table 9: Comparison of different thermal storage technologies [38]

	Ice harvesting	External melt ice coil	Internal melt ice coil	Encapsulated Ice	Stratified water	Multi tank
Chiller efficiency	Low	Medium	Medium	Medium	High	High
Tank Volume	Small	Small	Small	Shape-adaptable	Medium	High
Discharge fluid	Water	Water	Second coolant	Glycol	Water	Water
Tank interface	Open	Open	Closed circuit	Open or close	Open	Open
Chiller cost	High	Medium	Medium	Low	Low	Low
Tank cost	Low	Medium	Medium	Low to medium	High	High
Temperature supplied	High	Low	Low	Low	High	High



Table 10: Comparison of ice and chilled water storage

	Chilled water storage	Ice storage
Storage temperature (°C)	4-6	-3 - 6
Supply chilled water temperature (°C)	5-7	1-4
Tank volume (m ³ /kWh)	0.089-0.169	0.019-0.023
Cooling storage density	Low	High
Chiller types	Normal type	Dual conditioned
Chiller COP	5.2 (4/12°C)	4.6 (AC condition: 4/12°C) 4.1 (Storage condition: -2/-6°C)
Water system and circulating pumps energy consumption	Open system, high energy consumption for circulating pumps	Closed system, low energy consumption for circulation pumps

Secondly, the size of the storage must be determined. The total thermal energy storage capacity is directly related to the hourly cooling demand of the 'district' and to the pattern between baseload and peak load. One must consider the tariff of peak/off-peak periods, investment of chillers, plant structure and space, operation fee and total system efficiency in order to calculate its cost-effectiveness. However, based on the experience from existing DC systems, the total ice storage ratio normally accounts to approximately 25%-35% of the peak load requirement. Meanwhile, as time is needed before customers decide to connect, the systems are usually operating in part load for many years before achieving full load. To enlarge the storage capacity means to save operation fees during low cooling demand in the first 5-7 years.

Figure 24 shows the cost-effectiveness of increasing ice storage ratios. The investment for an ice storage equipment (coils, storage, heat exchangers etc.) increases almost linearly as ice storage ration increases. However, due to the ability to shave peak loads, the investment in chillers, cooling towers and water pumps of the overall DC system may decrease when ice storage ratio is less

than 60%. The total investment is constant for ice storage ratios lower than 35% and increases as ice storage ratio exceeds 35%.

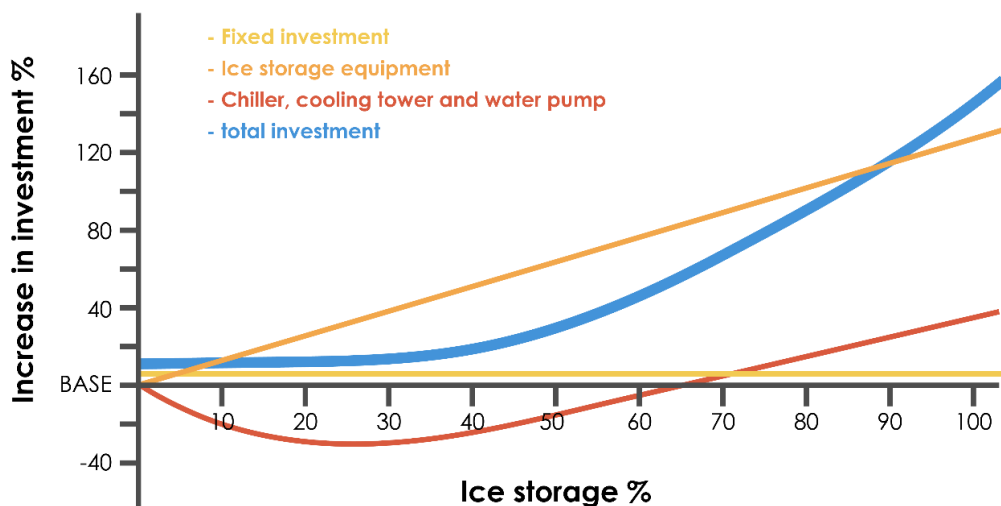

Figure 24: Cost-effectiveness of ice storage ratio [39]

6.3.3 EXTERNAL CONNECTIONS AND ENERGY SUPPLY

One of the many advantages of DHC (and in-turn DC) from the perspective of policy makers, is that it can collect excess thermal energy available along the network. Excess energy collected from medium/large size renewable plants and excess energy from industrial facilities is available relatively often in many urban contexts across the world. Collecting such excess energy has a two-fold advantage:

- Increasing energy efficiency of the DHC system by replacing energy which would otherwise have to be produced by the central production plant by excess energy which would otherwise be lost. Given that excess energy is available in a reliable and plannable manner, production plants at DHC system level can basically be undersized;
- Increasing energy efficiency of renewable plants installed locally (e.g. on building roofs) along the network. Given that the DHC system runs continuously, such local RES plants can then be basically oversized with regard to the energy demand of the user they are directly serving, covering a higher share of user's needs and selling overproductions to the DHC system.

This approach is usually called ‘Third Party Access’ and is widely applied in electricity infrastructures. In DHC systems it is not common yet, but several examples exist around the world, mainly in DH systems. According to the STRATEGO project *‘Large-scale district heating networks have some characteristics that are similar to the electricity market. Although there is no example of an urban district heating grid with full-feature Third Party Access (TPA) and competition between many suppliers, there are examples of unbundling between competing heat producers using a variety of primary fuels and technologies, a monopoly transmission company, and several local distribution companies. The latter may be subject to various elements of competition, in particular competition between local heat production and purchase from the transmission grid. Some experience has now been gained on the introduction of TPA for the electricity and gas networks. This is not an easy task, and it will be more difficult for an urban district heating grid. The geographical extension is limited to an urban region instead of Europe-wide networks, and the hydrological conditions in the district heating network are far more complicated than the flow conditions for electricity or gas [40]. The main objection to TPA is that it suggests a division between heat production, distribution and sales. This has been criticized arguing that there will be insufficient economic incentives to encourage new investments in DH infrastructure’ [41].*

Excess energy in form of heat is common, while excess energy in form of cold not so much. This can be the case especially where medium/large solar thermal cooling plants are installed. Large collector fields may have overproduction issues, which decrease systems’ energy efficiency at times where cold demand of the building they are installed on is low. A nearby DC system would be beneficial because, due to varying customers profiles of connected parties, a minimum cold demand should be available constantly, thus excess solar cooling energy can be sold back to the DC service providers.

The benefit of TPA in DC is even more evident in the case of hot networks with local sorption chillers. In this case, any excess production of heat by RES plants (solar thermal, biomass, micro co-generators etc.) is also beneficial to the production of cold by local chillers.

From the technical perspective, TPA in DHC poses some problems which must be carefully evaluated at preliminary stage when considering external connections and energy supply for DC:



- DHC systems are operated at relatively high pressures, therefore heat exchangers must be realized to withstand significant pressure differences between the two thermal streams;
- Third-parties (different from the DC service provider and the customers) willing to sell thermal energy (be it cold or heat) to a DHC system must meet given temperature levels, which may often be challenging;
- Excess energy should be available at agreed times, otherwise the DHC service provider might not meet the demand;
- Third party excess energy shall be paid by the DHC service provider enough to make the contract appealing to the third party, but still significantly less than the cost of thermal energy produced at the DHC production plant.

6.3.4 DISTRIBUTION NETWORK

As described in the previous sections, and summarized by the Handbook of Heating, Cooling, Ventilation Air Conditioning [37], the investigation of over 50 DC projects in Asian Pacific countries shows that the investment in distribution network accounts for approximately 10%-20% of CAPEX, while the electricity consumed by distribution pumps accounts for about 15% of OPEX. It is very important to optimize the distribution system so as to achieve high energy efficiency and sustainability for the whole system.

When designing the distribution network of a DC system, it is crucial to determine the pipe diameter based on friction (economical friction), thus balancing the initial investment in pipes and the consumed pumping energy, as well as the insulation thickness (economic insulation thickness), balancing the initial investment in insulation and the heat losses along the pipes. Meanwhile, the heat loss in the primary piping depends on pipe material, insulation and even on local skills in pipe construction. The recommended economic friction for different pipes is listed in Table 11.



Table 11: Recommended control friction for different pipe size

Pipe diameter	Recommended economic friction (Pa/m)
< DN200	200
DN200-DN400	150
> DN400	70-100

Due to the short period of full load and the large investment in the pipe network, it is also recommended to increase the flow rate in the primary pipelines to reduce the pipe size and related investment. In the DN800 pipeline for example, at the friction level of 150 Pa/m, the flow speed is approximately 4.0 m/s.

It is possible to increase the network capacity by increasing the temperature differences between supply and return chilled water. For example, it is possible to reduce the supply temperature as low as 1.1°C by using steel ice coils in ice storage systems. This kind of thermal energy storage technology is used globally in DC projects, especially for those with limited space for DC systems but high cooling capacity required, like in Japan, China and Singapore.

Heat losses and temperature increase of different pipe size and flow rates are listed in Appendix 4. The values are calculated under the conditions of 50 mm XPS insulation with the buried depth of 1 m beneath ground from the top of pipes.

The planned heat losses of the primary piping results from a balance of CAPEX and OPEX. However, in a sustainable DC system heat loss along piping shall not exceed 5% of the total distributed cooling energy. Higher losses may have a negative impact on chilled water price as a result of lower energy efficiency.

It is recommended to employ multi-level pumping systems for the purposes of long development time and different phases of DC systems. For each pump, it is recommended to have separate control systems on each routine of chilled water pipelines with variable flow rate control.



6.3.5 RECOMMENDATIONS FOR ETS AND COOLING DISTRIBUTION AT BUILDING LEVEL

The DC service provider should issue a design guideline to all the customers. The purpose of the guideline is to illustrate how to install metering and control systems for the ETS and how to design their own internal air conditioning systems to operate in a compatible way with the DC system, assuring good energy efficiency.

In order to achieve overall high energy efficiency of the DC systems and internal air conditioning systems, it is important to design, operate, control and manage all the systems on the same platform. However, internal air conditioning systems are difficult to manage by DC service provider. Therefore, cooperation between customers and service provider is crucial.

The design and operation of internal air conditioning systems should be in line with the supply and return temperature of chilled water, pressure and other requirements of DC systems.

It is the responsibility of the DC service provider to maintain the supply chilled water temperature as low as contracted or agreed with customers, which stands for the quality of cooling. It is also the responsibility of the customers to maintain their return chilled water temperature as high as contracted or agreed with the DC service provider, to maintain the ΔT and keep the energy efficiency of the whole DC system.

There are several options to define the boundary between DC system and customers' cooling distribution. This boundary can relate to initial investment, future management and operation. One common option is to set the boundary at the ETS. The advantage of this option is that the DC service provider can easier assure energy efficiency and effectiveness of ETS and of their control systems. Another option is to consider the building basement wall as the boundary to reduce CAPEX of DC service provider.

It is recommended to set ETS as a boundary between DC and internal cooling systems.

It is also recommended to set some abundant capacity as back-up for the heat exchangers in the ETS. The recommendations for ETS and heat exchanger setting are listed in Table 12.

There are innovative technologies and design in heat exchangers to enhance heat transfer. The efficiency of heat transfer should not be less than 90%. The

temperature difference for heat transfer between hot and chilled water is recommended to be less than 0.8°C. In some of the best practices of DC systems worldwide, the temperature difference of heat exchangers can be as low as 0.5°C.

Table 12: Recommendations for ETS and heat exchanger settings

Cooling demand	Built-up area covered by ETS (10,000 sq. m)				Requirements for ETS		
	Hotel	Office	Shopping mall	Residential	Area (m ²)	Height (m)	Heat exchanger quantity
3,500 kW (1,000 tons)	3.0	2.5	1.6	5.5	80	2.7	3-4 (with 1 back-up)
7,000 kW (2,000 tons)	6.0	5.0	3.2	11	140	3	3-4 (with 1 back-up)
10,500 kW (3,000 tons)	9.0	7.5	4.8	16.5	160	4	4-5 (with 1 back-up)
14,000 kW (4,000 tons)	15	12	7.5	28	160	4	4-5 (with 1 back-up)
17,580 kW (5,000 tons)	18	15	9.5	35	200	4.5	4-5 (with 1 back-up)
21,000 kW (6,000 tons)	21	18	12	43	200	4.5	4-5 (with 1 back-up)

In order to check the amount of heat transferred across ETS, meters and control valves should be installed. Recommendations of this installation is shown in Figure 25.

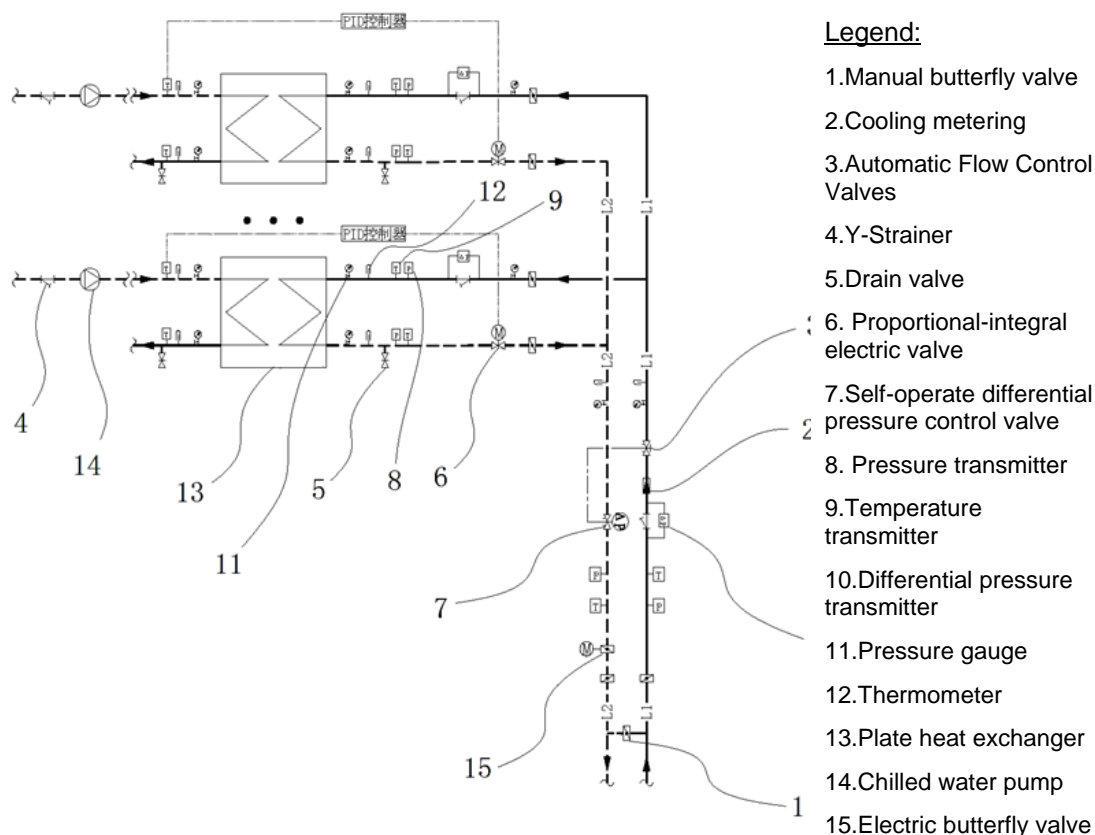

Figure 25: Installation of meters and valves of heat exchangers in ETS

When choosing the location of DC ETS (normally in the basement of a building), it is required to consider the maximum working pressure that the valves and pipelines in the DC system can withstand, which is usually 160 kPa or 200 kPa. However, in the case of high-rise buildings, it is common to put the ETS in the middle level of the building, for which the height would then be limited to 120 m.

6.4 CHOICE OF REFRIGERANTS

The emissions of HFCs, PFCs and HCFCs used as substitutes for ozone-depleting substances are rising worldwide, hence the market-shift towards DC acceptance.

The first generation of alternative refrigerants included HFCs, which had no ozone-depletion potential. But HFCs are potent greenhouse gases with high GWP and long lifetimes. Nowadays they are also replaced by either HFOs or 'natural' refrigerants under the October 2016 Kigali Amendment to the Montreal

Protocol. Regarding this aspect, the refrigerants currently used in low-medium capacity chillers are R-410A and R-407C, whereas R-134a and R-123 are the predominant refrigerants in larger applications. However, the phase-down of high GWP refrigerants and the accelerated increase in prices of HFCs are forcing manufacturers to look for alternative solutions [42].

Table 13: Refrigerants that can be used in countries under Montreal Protocol and Kigali Amendment [43]

	EU	USA	Japan	China	Canada
Propane	😊	😞	😊	😐	😊
Propylene	😊	😞	😊	😐	😊
Butane	😊	😞	😊	😐	😊
Isobutane	😊	😞	😊	😐	😊
NH ₃	😊	😊	😊	😐	😊
R-1234ze(E)	😊	😊	😊	😊	😊
R-1233zd(E)	😊	😐	😊	😊	😊
R-1234yf	😊	😞	😊	😊	😊
R-1336mzz(Z)	😊	😊	😊	😊	😊
R-513A	😊	😊	😊	😊	😊
R-450A	😊	😊	😊	😊	😊
R-454B	😊	😞	😊	😊	😊
R-452B	😊	😞	😊	😊	😊
R-32	😊	😞	😊	😊	😊
R-134a	😊	😐	😞	😐	😞
R-407C	😊	😐	😞	😐	😞
R-410A	😊	😐	😞	😐	😞

In DC systems, besides the low-GWP and eco-friendly refrigerants, commonly known as ammonia (R717), there are many other eco-friendly options to choose from. Firstly, DC uses absorption chillers instead of electric-driven chillers. Secondly, it is recommended to explore the possibilities of free cooling through energy mapping in the DC project development stage. The low-temperature cold water from nearby sea, rivers or even ponds can provide direct cooling or partial cooling for DC. Thirdly, ammonia (R717) is one of the 100% natural refrigerants with many applications in industrial and commercial projects if the above two options are not available due to locations and any other reasons. One of the main problems which needs to be considered with respect to DC is the issue of safety due to the flammability and toxicity of ammonia.

By phasing out high GWP refrigerants through DC implementation, the (existing) compressor or even the whole chiller needs to be (re-)designed. The cooling efficiency becomes one of the considerations when comparing DC to

the figures with respect to traditional refrigerants in a non-DC system. Table 14 lists the cooling efficiency of chillers with different refrigerants.

Table 14: Cooling efficiency of chillers with different kinds of refrigerants [44]

Refrigerant	Compressor Displacement cfm	Coefficient of Performance	Efficiency Penalty
507	3.427	4.18	-13%
404A	3.494	4.21	-12%
22	3.573	4.65	-3%
134A	6.076	4.6	-4%
717	3.450	4.77	0%

6.5 MAINTENANCE-RELATED ISSUES

Maintenance is a key tradeoff in any DC system. If well implemented, energy efficiency and safety issues are both positively impacted. Chapters 6.5.1 and 6.5.1 outline the key DC maintenance-related issues.

6.5.1 HARDWARE COMPONENTS

Maintenance processes are specific to each part of a DC system. For the main devices such as chillers, turbines, motors, cooling towers, ETS, and circulating pumps, maintenance protocols are manufacturer-specific and to be followed precisely. For smaller components such as valves or filters, maintenance requirements depend on each specific network (e.g. filters' maintenance occurs more often if water is dirty). Those parts of the DC system which are therefore constructed on-site (e.g. distribution network, consumer connections), they require a maintenance protocol which is influenced by the construction method and the type of components installed. Furthermore, such maintenance protocols may vary across time, as the system gets older.

According to ASHRAE Handbook—HVAC Applications [45] three main maintenance strategies can be considered: run-to-failure, preventative maintenance, and condition-based maintenance:



- Run-to-failure consists of minimum maintenance and bases on replacement of equipment;
- Preventive maintenance ensures that resources are available for proper operation of cooling systems, aiming at durability, reliability, energy efficiency, and safety;
- Condition-based maintenance relies on inspections (usually using non-disruptive techniques) and monitoring to assess equipment's condition.

It is important to consider suitable space accessible free of obstacles around each device to allow for maintenance and replacement. Space for data collection from meters shall also be considered.

It's also worth mentioning that in DC systems, hazardous substances may be used (e.g. ammonia), which leads to the need for risk assessment and dedicated safety procedures (see appendix 3 for safety-related standards).

6.5.2 WATER TREATMENT

Water treatment is crucial for ensuring safe operation, optimal lifetime and high energy efficiency of a DC system.

As for safe operation, the main concern in water treatment is Legionella pneumophila bacterium, which may cause Legionnaires' disease. This bacterium can be deadly if inhaled in the form of aerosols, which can happen where cooling towers are used. According to ASHRAE, experience shows that wet cooling towers can be transmitted over a distance of up to 3.2 km.

Paramount attention should be placed on projects in close proximity to healthcare facilities, where the majority of inhabitants can suffer from weakened immune systems already. In order to mitigate the risk for Legionella disease resultant from DC, the wet cooling towers must be kept clean, as Legionella bacteria are often found in biological layers. Moreover, material selection can help reduce potential safety hazards of DC, and it's important to remember that the smoother the material of pipes and cooling towers, the lower the risk for bacteria proliferation. Microbial control substances additionally help reducing the number of bacteria. Water flow of a DC system should be monitored periodically in order to make sure that the bacteria content is below given values, e.g. following the European Technical Guidelines [46]. This document



provides detailed information about designing and checking cooling towers to minimize the risk for Legionella proliferation.

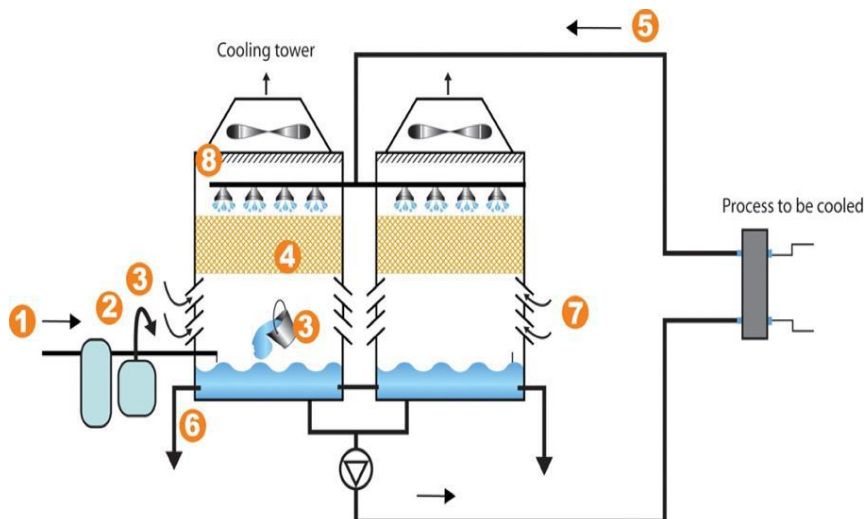

Figure 26: Schematic example of installation with cooling towers and the key components to review during risk assessments [46]

An preventative measure is to install dry cooling towers instead of wet ones, keeping in mind that heat rejection efficiency will be lower. The UK Health and Safety Executive guidance HSG274 Part 1 contains useful information on typologies and design of cooling towers and gives practical hints for good operation and management.

Table 15: Key points for auditing a cooling tower system [46]

1. Supply water	<ul style="list-style-type: none"> • Check the source and quality. Review any testing results and the incoming temperature.
2. Treatments against scaling and corrosion	<ul style="list-style-type: none"> • Check the system is working and dosing correctly (for further information see Part 3 and HSG274 Part 1 (Health & Safety Executive, 2013b, paragraph 1.40); • Check the surfaces for scale and the tower fabric for corrosion.
3. Treatments against microbial growth (biocides and bio dispersants)	<ul style="list-style-type: none"> • Check the dosing regime; • Are there regular checks to ensure the biocide is being used as expected on a daily basis (visual check on volume used)?

	<ul style="list-style-type: none"> • Check dip slide results and how these are done (e.g. are they incubated and read correctly?)
4. Tower fill or pack	<ul style="list-style-type: none"> • Check for slime, scale and corrosion (gently pull the pack apart; if available, check with a borescope inside the pack); • Check when the pack was last removed and cleaned.
5. Circuit of water cooled by cooling towers (exposed to air within tower)	<ul style="list-style-type: none"> • Check the distribution channels for debris, sludge and slime; • Is there evidence of uneven distribution? • Are the pumps working effectively? • Check the pond for clarity, debris, slime and sludge.
6. Blow-down/discharge network	<ul style="list-style-type: none"> • Check the number of concentration cycles before blow-down; • Check total dissolved solids (TDS) results.
7. Air inlet	<ul style="list-style-type: none"> • Check for dirt and debris.
8. Drift eliminator	<ul style="list-style-type: none"> • Check these are tightly fitting and not damaged.
Documentation	<ul style="list-style-type: none"> • Check there is an effective up-to-date written scheme for controlling exposure to Legionella which includes instructions for start-up, normal operation and shut down; • Is there an up-to-date schematic diagram? • Is there a logbook with up-to-date monitoring data, and are there any anomalies? • Have anomalies in results been addressed in a timely and effective manner?

For ensuring long lifetime and high energy efficiency of a DC system, electrochemical corrosion is a major risk to address. Corrosion-resistant

materials should be selected carefully and the coupling of metals with different electric potential should be avoided. If the latter cannot be avoided, at least direct coupling of the two metals can be excluded and suitable corrosion inhibitors may be used for the DC system. Other protection measures are the so-called cathodic protection, which are based on sacrificial anodes and protective coatings.

OPTIONAL READING

For further reference on chapter 6.1 Feasibility of a DC system [47]

For further reference on chapter 6.3.4 Distribution network [48]

For further reference on chapter 6.3.5 Recommendations for ETS and cooling distribution at building level [49]

For further reference on chapter 6.4 the Montreal protocol and the Kigali amendment [50]



7 CONTROL, OPERATION AND MAINTENANCE OF DISTRICT COOLING SYSTEMS

Control of a DHC system must operate the district network itself, be capable of adapting to building-level control, and ensure energy is correctly monitored both for energy efficiency assurance and for customer billing. The main challenges for either new or renovated DHC systems are the optimization of thermal production according to predicted demand profiles and energy prices, management of intermittent RES sources, peak shaving, and management of storage.

Control systems should be capable of providing a simple graphical user interface that can generate operational reports and activate alarms in the case of malfunction. This allows for detailed analyses of the DHC systems' main components (i.e. thermal energy generation, storage, circulation pumps, condensate and freshwater pumps, valves, ETS) by recording events and parameters. Supervisory control and data acquisition systems (SCADA) are often chosen for control of DC system due to their ability to automate various actions. SCADA systems are based on data acquisition and can therefore seek optimal responses to the measured data. Being fully automated, human errors are reduced as much as possible. Moreover, in the case of significant geographical extension for a DC system, the usage of SCADA for control heavily reduces the need for moving people from one place to another for maintenance reasons.

7.1 CONTROL AND MONITORING INSTRUMENTS

In a DC system some parameters should be monitored continuously and in an automated way: flow rate, temperatures and pressure. Energy is a crucial measurement, which is made possible by the combined use of a flow meter and temperature sensors. The main instruments required for DC control systems are listed in the following:

- Flow meters (e.g. ultrasonic or electromagnetic meters): should be selected based on pressure loss (turbine-based meters cause high pressure loss and are therefore not optimal), accuracy (0.5% accuracy can be considered as reasonable), and installation requirements (depending on the type of instrument, a certain length of straight pipes must be installed before and after the flow-meter);

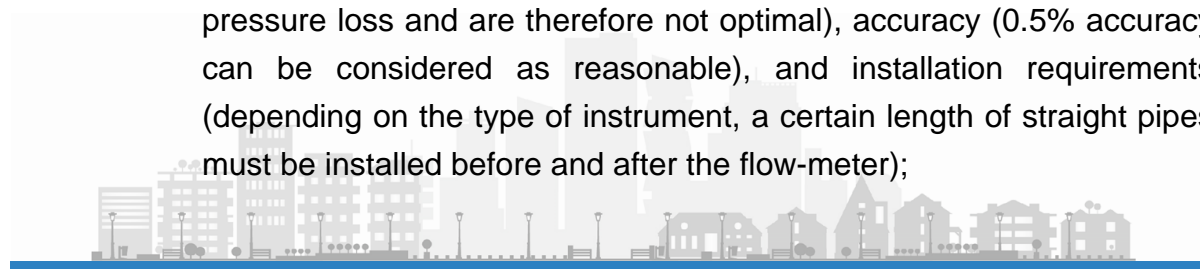

- Temperature sensors (e.g. RTD - resistance temperature detectors): should be selected according to required accuracy;
- Pressure sensors (e.g. Piezoresistance sensors): accuracy should be better than 1%;
- Energy meters: are electronic calculators that are connected to flow meters and temperature sensors. Based on flow rate and supply and return temperature, they calculate the thermal energy exchanged in a given process. Such meters should have an on-board storage capacity and be connected remotely to the central control panel of the DC system.

7.2 CONTROL STRATEGIES OF DC SYSTEMS

7.2.1 BASIC CONTROL STRATEGIES

Control is a major issue with regard to the control of DC system, as a high number of customers (i.e. buildings) are usually connected to a typical network. Such customers may have significantly different cooling needs for several reasons, such as:

- Building typology: how was the building envelop constructed? Typical examples are window area, building orientation, wall stratigraphy, building thermal mass, presence of shading devices etc.;
- Building usage: what activities occur inside the building? Residential buildings usually require cold energy in the evening, whereas office buildings need to be cooled more often during the day;
- Internal gains: what kind of devices are operating inside the building? Computers and servers, for example, reject lots of heat towards the environment;
- Cold emission devices: according to the typology of emission devices, the required supply temperature may vary significantly (e.g. fan-coils, radiant floor, chilled ceiling, chilled beams etc.);
- Mutual shading effect of buildings.

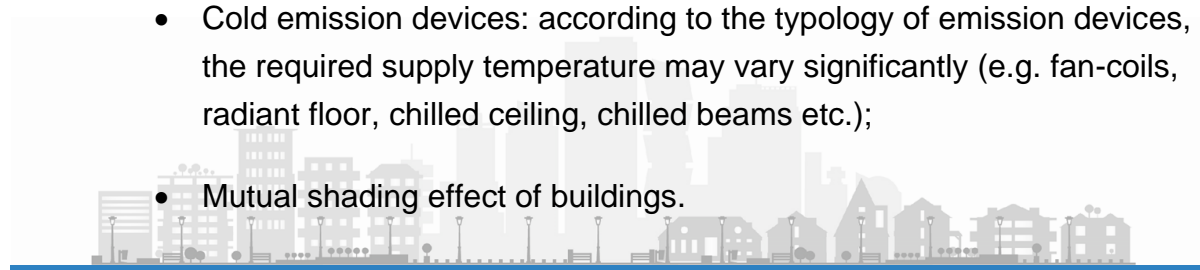

Furthermore, cooling demand is heavily influenced by weather conditions, making the load curve very much time-dependent along the day and along the season.

Such customer- and weather-dependent cooling needs must be managed effectively by the control system, to satisfy all connected parties, keeping generation plants' energy efficiency as high as possible.

Two levels of control of DC can be distinguished [51]

7.2.1.1 CENTRALIZED CONTROL IN THE CENTRAL COLD GENERATION PLANT

- Circulation pumps are controlled by differential pressure logic and check that enough pressure difference between supply and return pipes is available, thus ensuring effective operation of each ETS. Typically, 100-150 kPa is the optimal pressure difference that should be maintained across each ETS. The maximum pressure must be limited according to technical specifications of network's components (piping, ETS, valves etc.). In case only one cold generation plant is feeding the network, the maximum pressure depends only on the circulating pump, hence it is easily controlled. In case of more complicated networks additional control features must be set forth, for example installing more than one circulating pump at different spots along the network;
- Cold generation plants are usually controlled by supply temperature logic. Supply side temperature must usually be guaranteed by the DC service provider and is quantified based on the supply temperature required on the secondary side of ETS (which ultimately depends on the actual cooling demand). The set-point is not constant over time, it varies along the day and the cooling season according to climatic and other boundary conditions. On the other hand, the return temperature cannot be controlled, as it depends on demand conditions at each ETS: it is therefore the result of a complex mix of heat exchange processes. Additionally, when designing the control logic, one must consider heat gains along the network (even despite good insulation of the DC pipes, temperature will increase from the point it is generated to the ETS). Cold generation temperature must therefore be set according to required ETS temperature and to the estimated temperature increase;

- If multiple generation devices are installed (e.g. several compression chillers, or a mix of compression and sorption chillers), the control system must be capable of switching them on and off according to a pre-defined order of priority. Such order depends on availability and price of electricity and heat (the latter in case sorption chillers are installed): CHP plants, for example, are expected to run as much as possible along the year, therefore, if boundary conditions make it possible, it will be operated and the generated electricity will be used to drive compression chillers. However, if in a DC system a sorption chiller is installed, it will be likely run whenever inexpensive heat (e.g. from a nearby industrial process) is available.

For a centralized DC system (i.e. a single source of cooling as opposed to several), the control system must be designed in a way that it sends alarm signals in the case that any parameter exceeds the maximum value (especially return temperature, pressure, and flow rate).

7.2.1.2 LOCAL CONTROL AT THE LEVEL OF CUSTOMERS' ETS

- Supply temperature must be kept below a certain upper value at the peripheral branches of the network. If such upper values are exceeded, one can either decrease the supply temperature set-point (thus reducing cold generation plants' energy efficiency) or increase the flow rate (increasing pumping costs). Another solution is to operate on bypass valves in specific peripheral branches with no or little cooling demand;
- Actual cooling demand is determined by the chilled water distribution systems inside the buildings. The systems shall be operated by the building manager in a way that return temperature on the secondary (building) side of the ETS is kept to agreed values. If return temperature exceeds such value, the control system at central plant level shall modify the supply temperature, accordingly, seeking for efficient operation;

In order to avoid boiling of water in the network (for example in case it serves customers located at different heights), pressure must be kept above minimum thresholds. To this aim, a pressurization pump is required.

7.2.2 ADVANCED CONTROL STRATEGIES

Complex control logics can be designed for minimizing OPEX. Strategies can be purely software-based, using advanced digital systems and additional sensors, or based on specific hardware (e.g. thermal storages). Advanced control usually increases CAPEX, but in many cases life-cycle cost can be significantly reduced.

7.2.2.1 OPERATIONAL ANALYSIS

Digital control systems offer powerful data collection and management features. This enables service providers to plan maintenance in advance, potentially reducing end-use discomfort and maintenance costs. Furthermore, detailed operational data formulated by digital control systems is crucial for early detection such as when the network is possibly reaching its maximum flow rate or pressure. Consequently, the adoption of advanced control strategies allows for a more rationale management of the network and connecting new customers without the need for substituting parts of the network, such as pumps and piping.

Thanks to advanced control systems, effective detection of leakage is also possible: make-up water is often a significant cost for DC service providers: it has to be purchased from the aqueduct and must be cooled down to supply temperature. Besides, high water leakages increase negative environmental impact of DC systems, thereby reducing sustainability.

7.2.2.2 CONTROL OF COLD WATER STORAGE

Storage tanks are common in any DHC system. They enable generation plants (e.g. chillers) to operate more often at full load, thus keeping high energy efficiency values. If renewable energy technologies are installed (e.g. solar thermal, photovoltaics etc.), storage collects energy when it is available, and make use of it whenever customers need it. The control system must be capable of recognizing when a storage is completely charged or discharged, and consequently be able to stop charging or start the next charging cycle. This can be done with temperature sensors installed at incremental heights in the storage.

7.2.2.3 PEAK COLD SHAVING

Peaks are among the most critical topics when it comes to DE, as they can be significantly higher than the base load, leading to high installed capacity and low full-load operation hours. Peaks should therefore be reduced to the highest

extent possible. This can be done by cooling the network before the peak cold demand occurs, leading a twofold positive effect:

- 1) The chilled water mass in the network is cooled more gradually;
- 2) The building envelope is less hot when the peak time occurs.

The first point is always beneficial, whereas an envelope effectiveness depends on the thermal mass of the building. In 'heavy' buildings with modern windows, negative effect of direct sun irradiation through the glass surfaces is limited. Furthermore, cooling at building before peak load times requires the agreement of occupants, who may complain that temperature from e.g. fan-coils during hot hours is too high.

Peak shaving becomes much more effective if load forecasting features are embedded in the control system. Forecasting control is indeed gaining lots of attention, also considering that it offers demand response (DR) features (see chapter 9).

7.2.2.4 BIG-DATA COOLING PREDICTION AND OPERATION OPTIMIZATION

DC systems collect quite a large volume of data every day, including cooling demand from customer buildings, weather data, and energy consumption of the equipment. These datasets should always be hourly-based, precise, and reliable. Thus, employing different kinds of big data analysis to predict hourly or daily cooling load profiles can help to optimize operational processes that ensure thermal comfort and energy efficiency. Meanwhile, based on the approach of big data analysis, it is possible to predict the cooling demand in the coming hours or days and optimize the operation of cooling systems, especially thermal storage.

7.2.3 ENERGY FLEXIBILITY

With changing electricity markets and increased use of RES for heat and cold production, energy flexibility is becoming more and more important in DHC systems. Flexibility can be understood in two different ways, both applicable to DC: offering flexibility services to the electric grid and managing different heat sources.

Offering flexibility services to the electric grid



Due to an increasing share of RES in the electricity grid, flexibility services are becoming increasingly popular because RES cannot be switched on and off when needed (unprogrammable energy sources). DHC systems are a very good candidate, since they serve large numbers of customers with one (or few) centralized control systems. Given that thermal storage is installed, a DHC system can purchase energy (e.g. for compression chillers) at off-peak times. In the near future such flexibility will likely be paid by Distribution System Operators (DSO) with two main advantages:

- Better return on investment for the DC service provider;
- Better exploitation of RES in the electricity grid, thus better sustainability of the entire energy system.

Besides storage availability, demand side management (DSM) also contributes to the provision of flexibility services (chapter 9).

7.3 MEASURING, REPORTING AND VERIFYING FRAMEWORK OF DISTRICT COOLING SYSTEM ENERGY EFFICIENCY

DC systems usually supply multiple buildings typologies. It is normally difficult to achieve the designed peak load of a DC system, because not all the customers buildings achieve their peak load simultaneously. In other words, DC systems typically run at partial load for most of the time. Apart from usual part load tests on chillers, some standards and handbooks (e.g. in China) recommend measuring energy efficiency of the entire DC system at different part load conditions: 20%, 40%, 60% and 80%. The test period should last at least 3 months for each part load.

For DC systems with thermal storages, it is recommended to measure the amount of thermal energy being stored and released. In that case, measurement of the DC system should include the energy efficiency of all devices installed (pumps, heat exchangers, storage etc.) under different part load conditions.

The parameters to be measured directly, include:

- 1) Chillers: supply and return temperature, flow rate of chilled water and condensed water; electricity consumption; refrigerant refilling amount. For air-cooled chillers, external air temperature and relative humidity should be measured;

- 2) Electricity consumption of pumps (chilled water pumps, distributed pumps, condensed water pumps, thermal storage circulation pumps etc.);
- 3) Thermal storage tanks/equipment: input and output temperature, flow rate; temperature distribution inside the equipment; liquid (ice, chilled water) position for estimating the cold energy stored;
- 4) Cooling tower: input and output temperature, flow rate;
- 5) Customer side ETS: input and output temperature, flow rate;
- 6) On/off conditions of all the cooling source equipment and valves.

It is recommended that all meters are set up at the same time of equipment installation.

7.4 METERING OF GENERATED AND DELIVERED COLD ENERGY, METERING OF CONSUMED ELECTRICITY

Metering is a key issue in DHC systems: it is necessary to quantify the consumed energy at each ETS, thus billing each customer. Furthermore, by measuring the thermal energy fed into the network, service providers can calculate the distribution efficiency, or, in other words, the distribution losses. In order to correctly measure delivered energy, heat meters must be installed at the primary side of each customer ETS. Heat meters consist of the following components (see chapter.7.1):

- One flow meter;
- Two temperature sensors, one on the supply pipe and one on the return pipe;
- One energy meter.

Measurement instruments in DHC systems should be consistent with the Measuring Instruments Directive [52]. At customer level, meters are to be installed under the responsibility of the service provider and on the primary side of each ETS, measuring the cooling demand.



Collected data generated by a DC control system can also be used for providing useful feedback to customers. In the following, some examples are given:

- The DC service provider can compare energy consumption data of similar customers (similar customers typology, building construction technologies, building orientation, etc). This can inform customers who are consuming significantly more than customers with similar demand profiles. This may unlock improved management of air conditioning at building level;
- If energy consumption is recorded at times when no consumption is expected (e.g. at night, or during weekends in the case of tertiary buildings), it may be the HVAC control system at building level is running the air conditioning at times when it is not supposed to do so.
- By monitoring return temperature at ETS level (either on the primary, or on the secondary side of the ETS), the DC service provider can identify if a customer's chilled water distribution system is behaving sub-optimally. This is due to the fact that return temperature should be lower than expected at the DC systems design phase. Customers consequently can fine-tune chilled water distribution and emission systems to optimize the ΔT .



8 QUICK METHODOLOGY FOR ESTIMATING THE COOLING DEMAND OF A GIVEN DISTRICT

8.1 INTRODUCTION

The estimation of cooling demand is needed to evaluate whether a district is suitable for DC from the perspective of cooling demand. Based on cooling demand, project developers can estimate yearly revenues. On the other hand, by quantifying the required cooling capacity, they can estimate CAPEX of the investment (chillers and heat exchangers capacity, DC piping diameters).

The methodology presented in this chapter is extensively described in a feasibility study for a district in Morocco [53].

Estimating the cooling demand is quite complex, especially at district or city level, due to the complexity and uncertainty of influencing factors, such as the various types of buildings with different applications and schedules, effect of urban environment, internal gains, etc.

Three main approaches can be used to estimate the cooling demand relatively quickly:

- 1) The first approach is based on electricity bills and on actual cooling consumption, with the assumption that local cooling systems mainly work with electricity;
- 2) The second approach is based on CDD, a value which depends on the climate zone. This approach should be implemented if electricity bills cannot be collected in the district – for instance if the district is in a planning phase (buildings not existing yet);
- 3) In some cases, a third approach might be available, based on municipal registers of refrigerants. If such registers exist, they can provide useful information about the amounts and types of refrigerants that are used in individual buildings. With that information the order magnitude of installed chiller capacity can be made [54]. This approach will not be explained in detail.

Ideally, both approaches will be used, and their results compared, in order to obtain a robust estimation of the cooling demand in a district.

8.2 FIRST APPROACH BASED ON ELECTRICITY BILLS

This approach is implemented within three steps as illustrated in Figure 27.

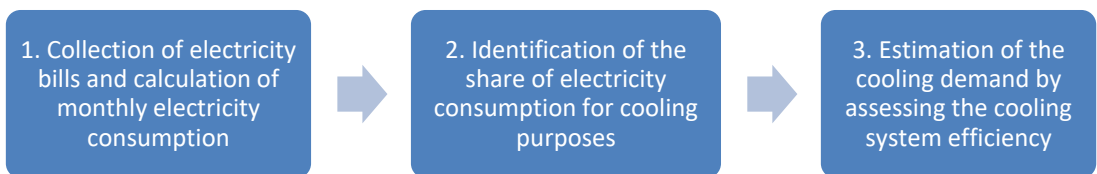

Figure 27: The three steps of the approach based on electricity bills

First, electricity bills have to be collected, ideally over several years in order to account for variations in weather conditions. Figure 28 represents as an example the electricity consumption of 40 hotels in Marrakech in 2016. In this case, since only hotels were studied, electricity consumption profiles are quite similar. In a district with several types of buildings (residential, offices, shops, schools, hotels, etc.), the electricity consumption profiles of the various buildings would vary significantly (for instance with schools closing in summer, etc.)

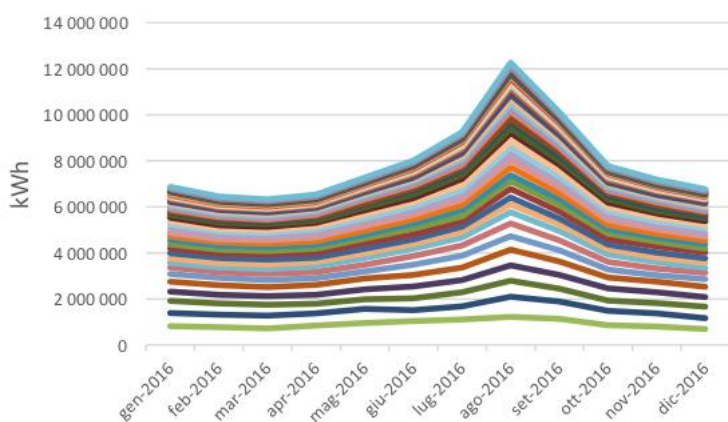

Figure 28: Monthly electricity consumption of hotels in Marrakech in 2016

Second, the electricity consumption for cooling purposes has to be identified based on these profiles. In moderate climate areas, during mid-season months with moderate outdoor temperature, the mechanical cooling and heating systems are rarely employed. Therefore, the baseload, meaning the electricity consumption of all uses except space heating and cooling (i.e. non-weather-dependent uses), corresponds to the electricity consumption in these mid-season months. Then, the additional electricity consumption in cooling season months above the baseload for space cooling. For instance, in the

Marrakech study, March has been considered as a ‘neutral’ month, the electricity consumption in March being the baseload (approx. 6.5 GWh for the

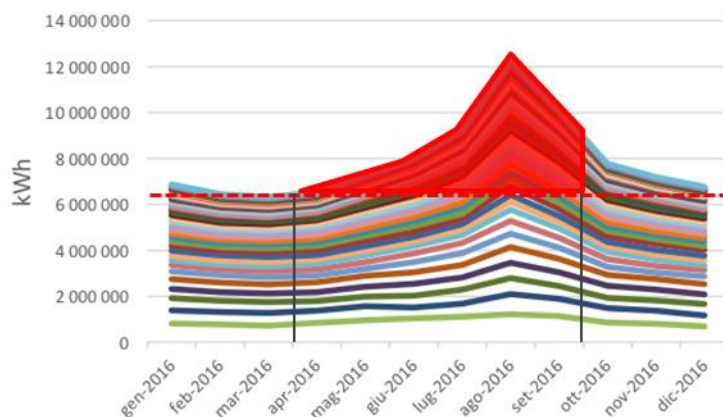

Figure 29: Identification of the electricity consumption for space cooling

40 hotels considered – represented by the dotted red line in Figure 29). In Marrakech, the cooling season period is from April to September. Therefore, the yearly cooling consumption can be easily estimated (as represented by the red area in Figure 29).

In other climate areas, especially in warmer areas where space cooling is employed all along the year, and in districts combining different types of buildings (contrary to the Marrakech study in which only hotels were considered), the identification based on electricity bills of the electricity consumption for cooling purposes is less straightforward. It will be estimated on a case by case basis, for each building or group of buildings. For instance, a survey would have to be conducted amongst building managers to identify the cooling patterns in the different buildings.

Third, the cooling demand is estimated by multiplying the electricity consumption for cooling purposes, as previously identified, by the cooling system energy efficiency. This coefficient has to be estimated on a case by case basis, depending on the types of cooling systems in place in the different buildings forming the district. The average nominal COP of the cooling devices has to be assessed by taking into account, ideally:

- the different technologies involved (generally provided by centralized air-cooled compression chillers or reversible heat pumps that are used for heating during winter and cooling during summer);

- the effect of condensation temperature variation;
- the partial load effect;
- the electricity consumption of fans and related auxiliaries and control;
- the effect of solar irradiation (since chillers are exposed to severe solar irradiation when installed on rooftops);
- maintenance and aging.

For instance, in the Marrakech study, existing air-cooled chillers of the hotel buildings considered have an average COP of 2.4 during the cooling season.

8.3 SECOND APPROACH BASED ON COOLING DEGREE DAYS

The second approach may be used as a validation of the first approach's results, or as the only approach possible if electricity bills cannot be collected in the district.

This approach is implemented within three steps as illustrated by Figure 30.

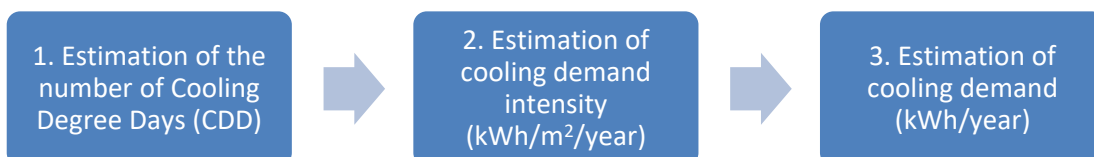

Figure 30: The three steps of the approach based on CDD

First, the number of CDD has to be estimated, depending on a base temperature to be chosen. The number of CDD varies by taking different base temperatures, corresponding to different desired levels of thermal comfort, building set-point temperatures, building envelope thermo-physical characteristics, internal gains, etc. The number of CDD for most cities in the world for the last 36 months can be downloaded for free at <https://www.degreedays.net>. Another well-known climate database is Meteonorm (<https://meteonorm.com/en/>). For example, according to the Marrakech study, for a base temperature of 22°C, the number of CDD in Marrakech is 650. In general, it is recommended to calculate the number of CDD within different scenarios in order to calculate a range of CDD rather than an exact value, since the base temperature, and therefore the number of CDD,

depend on building-specific parameters such as exposition to wind and sun, building orientation, patterns of occupancy, and many other parameters which are not taken into account by a standard CDD calculation [55].

Second, the number of CDD has to be turned into an average cooling demand intensity. For this, several approaches have been developed corresponding to various regions in the World:

- US proxy: Jakubcionis and Carlsson [56] have estimated service sector space cooling potential taking US consumption data as proxy. The following correlation based on CDD (with base temperature of 18°C) gives the cooling demand intensity in kWh/m²/year:

$$I_{cooling} = 0.6782 CDD - 0.7462$$

- European Cooling Index (ECI) [6]: The index is normalized, where 100 is equal to an average European condition, which occurs for example in Strasbourg and Frankfurt (where the average outdoor temperature is just above 10°C). European Cooling Index at level 100 (ECI-100) is 82 kWh/m²/year. For a given location, the cooling demand is assumed to be linearly proportional to the difference in CDD:

$$I_{cooling} = 82(CDD - CDD_{Strasbourg})$$

- Alternatively, for a more precise estimation of the cooling demand, the cooling intensity could be estimated depending on the different types of buildings considered in the district, since residential buildings, hotels, schools, offices and shops are likely to have different cooling needs.
- For instance, *Table 16* illustrates the differences in energy consumption for cooling purpose, not only between different Chinese cities (corresponding to different climatic zones) but also between different types of buildings. Similarly, *Table 17* illustrates the variations in the breakdown of electricity consumption per type of usage and per sector in Belgium (Brussels area).



Table 16: Estimation of annual cooling consumption of different buildings in Chinese cities (kWh/m²) [37]

CITIES	Shopping mall	Grade A office space	Ordinary office building	Five-star hotel	Four-star hotel	School building	Canteen	Stadium	Library	Students apartment	
Guangzhou	208	178	189	225	172	323	319	239	279	180	248
Wuhan	133	118	120	145	110	197	211	161	171	8	155
Shanghai	118	107	106	131	97	173	193	150	149	72	140
Lanzhou	72	92	63	95	56	85	71	111	70	5	788
Chongqing	129	121	114	145	105	186	202	160	156	94	160
Beijing	112	120	101	135	91	149	145	144	131	70	129
Jinan	118	124	106	141	96	161	157	152	138	80	142
Guiyang	103	102	89	120	82	139	156	140	112	7	127
Haikou	262	211	241	274	218	416	411	290	360	239	310
Nanjing	125	110	113	136	103	188	208	155	164	77	146



Table 17: Electricity consumption per usage and per tertiary subsector in Brussels area [57]

Share of consumption by end use				
Sectors	Lighting	AC, ventilation & cooling	Heating & hot water	Other
Health care and social services	47%	10%	2%	41%
Education	69%	7%	1%	24%
Offices and administrations	35%	7%	2%	56%
Trade	37%	13%	3%	47%
Culture and sports	25%	8%	4%	63%

Third, the cooling demand in the district is estimated by multiplying the cooling intensity by the floor area of the buildings included in the district.

8.4 CONCLUSION

Estimating cooling demand in a district is quite complex and depends on many factors. Data availability for estimating cooling demand will be key for choosing the method to be applied.

Therefore, no straightforward ‘one-size-fits-all’ methodology can be recommended. Ideally, a combination of a bottom-up approach (based on electricity bills) and of a top-down approach (based on CDD), and the consideration of the district’s specificities (types of buildings, consumption patterns, etc.) will allow for estimating a range of the cooling demand in the district.



9 INNOVATIVE CONCEPTS FOR DISTRICT COOLING

DC systems can be developed through several innovative concepts. Neutral temperature DHC (addressed in chapters 9.1 and 9.2) makes use of the same distribution network for both heating and cooling supply by employing heat pumps within the buildings. DHC systems can also be combined at the supply side (chapter 9.3). Storage capability is very important for cooling systems, and several technological options exist (chapter 9.4). Linked to this, the storages also enable exploitation of demand response flexibility (chapter 9.5). Cooling demand fluctuations may trigger attractive incentives for peak management. The 4th generation district heating (4GDH) is an overall concept that includes closer integration between different parts of an energy system, including cooling (chapter 9.6).

9.1 NEUTRAL TEMPERATURE DISTRICT HEATING AND COOLING SYSTEMS

Traditionally, DHC networks distribute energy from a centralized generation plant to a number of remote customers. As such, actual DHC systems are affected by relevant heat losses and unexplored integration potential of different available energy sources into the network [58].

A unique approach has recently been developed and applied to some newly built DHC systems. It reduces energy losses along the network by working at 'neutral'

(15-20°C) [58] temperature levels. Reversible heat pumps are the core of the generation system, being placed at building level to exchange thermal energy with the DHC system, thus providing heating and cooling to the buildings.

This innovative approach not only limits thermal losses significantly, but also increases energy efficiency since rejected heat from chillers (or heat pumps working in cooling mode) is fed into the network and possibly reused by other heat pumps which are producing heat for space heating or domestic hot water in other buildings. Such heat recovery is possible because the network temperature is very low, thus being capable of recovering rejection heat (which is usually at low temperature, e.g. 30°C). These neutral temperature systems can benefit from excess heat from other economic operators (third parties), such as industrial processes or small/medium renewable systems along the network (see chapter 6.3.3). Besides above-mentioned advantages, it must be considered that this approach requires heat pumps in each building, which



makes of neutral temperature systems a hybrid solution of DHC and autonomous heating at building level.

Neutral temperature systems can be considered after a careful evaluation of thermal demand; they can be attractive in districts where heating and cooling demands are similar and occur simultaneously. In that case the heat is rejected by cooling devices and can be reused by heating devices. Otherwise such heat must be rejected in cooling towers (if not even by a large centralized chiller) and heat pumps working in heating mode do not benefit from ‘warm’ water source.

Neutral temperature DHC have been applied only in a few cases, with one of the reasons probably being that it significantly changes the basic approach of DHC. Stated differently in traditional DHC, energy (heat or cold) is made available in one or more centralized plants and only ETS are installed at each building’s level. Neutral temperature DHC requires heat pumps at each building, thus increasing the need for maintenance at building level and requiring a specific business model for the purchase of distributed heat pumps.

An example of neutral temperature DHC is in Northern Italy, in the town of Duino Aurisina (Trieste) [59].



Figure 31: The touristic site of Portopiccolo, in the town of Duino Aurisina, Italy

This DHC system relies on sea water for keeping the district water at a desired temperature range. After two years of monitoring this sea water temperature, it was revealed to maintain between 28°C in summer and 9°C in winter.

The 3 km network is connected to 18 ETS, serving approximately 500 apartments including luxury hotels, shops, and offices. Each ETS serving apartments is equipped with two heat pumps, one for domestic hot water and one for space heating/cooling. Those ETS serving non-residential customers are equipped with three heat pumps to provide heating and cooling in response to the need. Nominal COPs of installed heat pumps are expected to be in the range of 4.4 – 4.9, if properly dimensioned

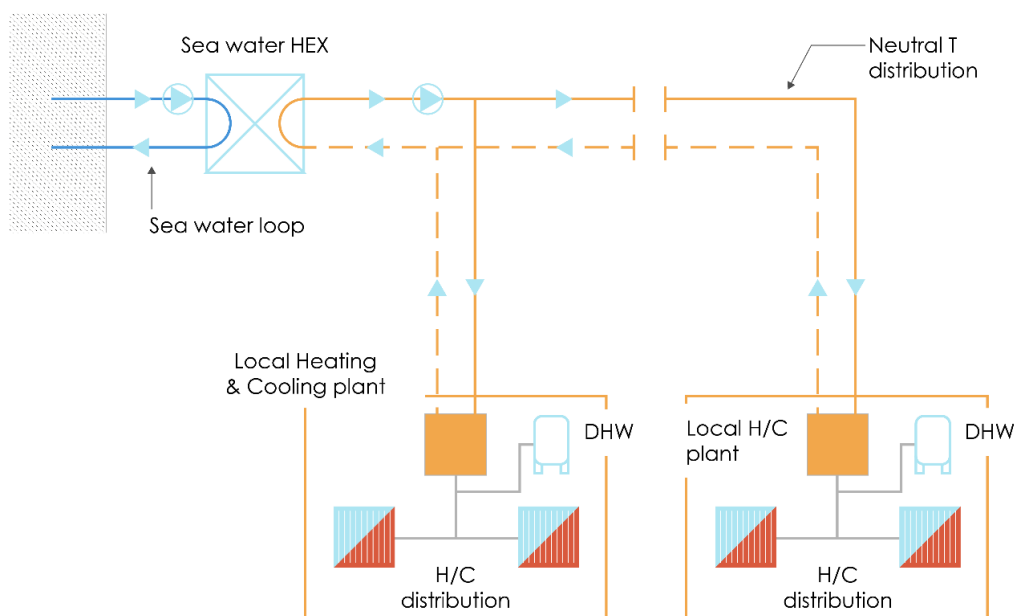

Figure 32: Simplified hydraulic scheme of the DHC system in Portopiccolo.

9.2 DISTRICT COOLING SUB SYSTEMS COUPLED WITH SUSTAINABLE DISTRICT HEATING SYSTEMS NEARBY

The FLEXYNETS concept consists of a distribution network that works at ‘neutral’ temperatures [60]. Reversible HPs exchange heat with the network on the demand side. Layout of the system is shown in Figure 33 and Figure 34. The FLEXYNETS concept has the following potential advantages:

- Simultaneous supply of heating and cooling;
- Recovery of condensing heat from cooling demand;
- Lower heat losses from the network;
- Lower installation cost for the network;

- Direct exploitation of low-temperature heat sources.

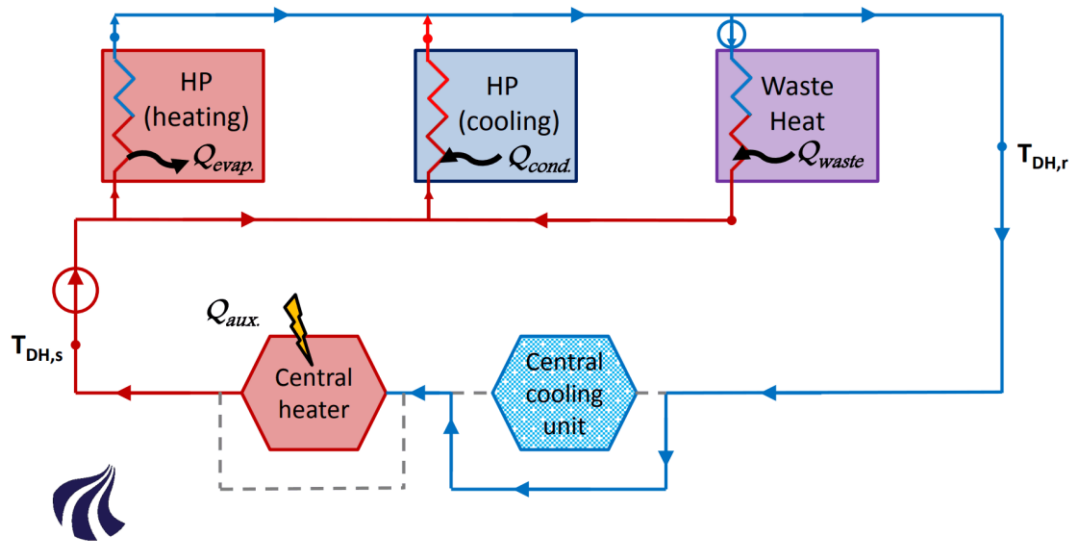

Figure 33: Principle scheme (winter)

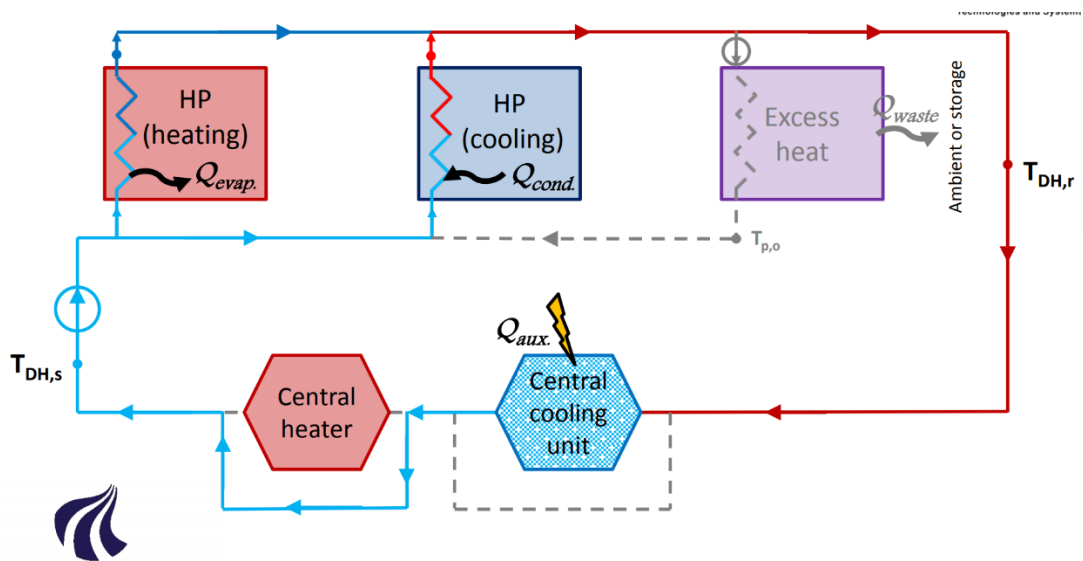

Figure 34: Principle scheme (summer)



The FLEXYNETS concept can be competitive with respect to conventional DH in the following scenarios:

- Low electricity prices;
- Lower HP installation prices;
- Presence of cooling demand;
- Abundant waste heat at low temperature.

The city of Chemnitz in Germany implemented a DC system in 1973. It is about 5 km long and distributes chilled water to various public buildings and shopping centers. The system was operated initially solely with electrical vapor compression coolers and refurbished in the beginning of the 1990s that included absorption chiller installations. In 2007, an innovative chilled water storage tank was additionally installed in order to cover peak loads. The storage is 17 m high, has a diameter of 16 m and a volume of 3,500 m³. The thermal energy storage capacity is 32 MWh. The central absorption chillers are operated with the heat from the CHP plant in Chemnitz. This incineration plant has three thermal power units which are fueled with lignite or oil. Although this energy is fossil based and not renewable, the example was included here to show the DC system. And conversion of heat sources to RES remains an option for the future. The hot water could be transported through pipes from the plant to the central absorption chiller unit. The absorption chillers would then use the heat to chill the water down to 5°C. This water is pumped through insulated pipes to 25 connection points where special ETS ensure the optimal cooling of the buildings and subsequent thermal comfort of occupants. The warmed water of about 13°C is finally transported back to the central chilling unit [61].

In Vienna waste heat produced in waste incineration power plants is used not only for DH, but also for DC. The service provider Wien Energie offers two solutions for customers who need cooling:

- 1) Decentralized solution: Here Wien Energie installs a refrigeration center directly at the customer;
- 2) Centralized solution: This concept uses a refrigeration center that supplies several customers at the same time via a DC system.

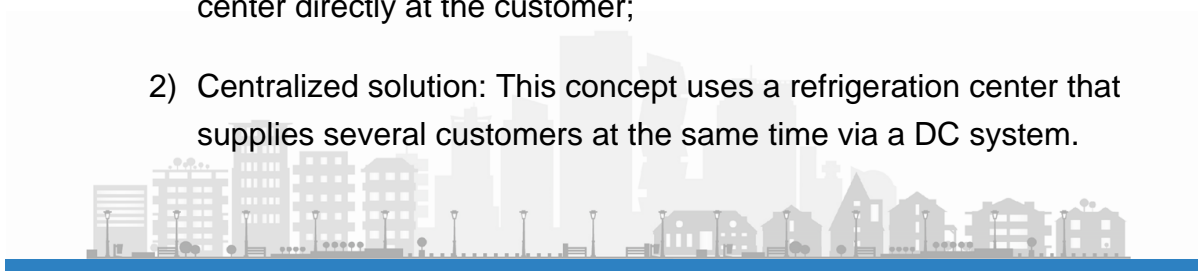

As shown in Figure 35, this DC system in Vienna comprises several small, interconnected cooling networks and individual cooling systems [61]. Different central cooling units are installed which involve absorption chillers, compression chillers, or a combination thereof. The different parts of the system include hospitals, shopping centers, railway stations, and settlements.

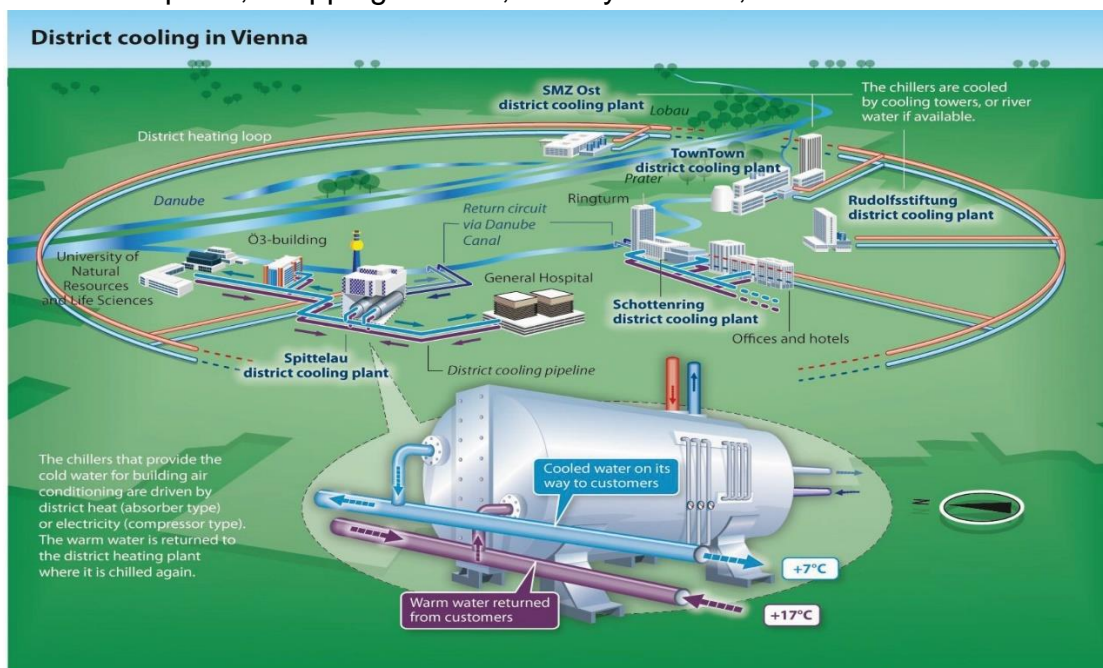

Figure 35: DC system in Vienna [62]

9.3 DISTRICT COOLING AND DISTRICT HEATING COMBINED SYSTEMS

9.3.1 DHC SYSTEM IN HELSINKI

As first introduced in chapter 5.3.2 of the current report, DC in Helsinki refers to commercial cooling energy supply based on a contract between HELEN and a customer. Cooling energy is delivered to the customers via a DC system. The principle arrangement of combination of DC and DH is illustrated in Figure 36.

About half of cooling production in Helsinki during the summer is based on absorption using surplus heat that would otherwise be wasted.



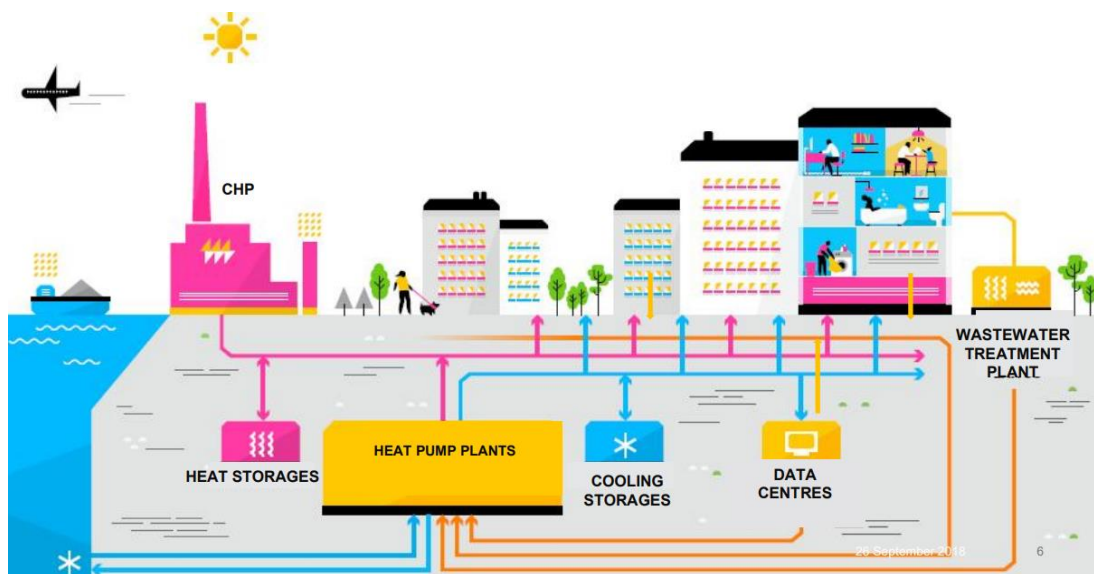

Figure 36: Modern DHC system of Helsinki combining DH and DC [63]

In addition to using seawater as a source of cold, another production method during the summer is based on heat pump technology. A heat pump is especially efficient when it produces DH and DC in the same process. In Helsinki, the world's largest combined production heat pump plant (in Figure 36) utilizes both seawater and treated sewage water. The overall COP is 5.0 or even higher [64].

9.4 INNOVATIVE THERMAL STORAGE TECHNOLOGIES

The most popular thermal storage solutions based on water or ice were covered in chapter 4.5 (system context) and chapter 6.3 (dimensioning). Here other technologies are mentioned.

Phase change materials (PCM) is one group of thermal energy storage medium, however still in the research and development phase. Most of PCM for cold storage are inorganic salt hydrates or mixtures of them (Figure 37). They are used due to their high latent heat during phase change, high density and low cost. A commercial salt hydrate PCM is used in DC system with a phase change temperature of 13°C. The major problem in using salt hydrates is that most of them melt incongruently. Another problem is corrosion, which implies short service life, as well as high packing and maintenance costs. Paraffin wax can also be used for cold storage for DC application. However, applications in real projects face the challenge of high cost [15].



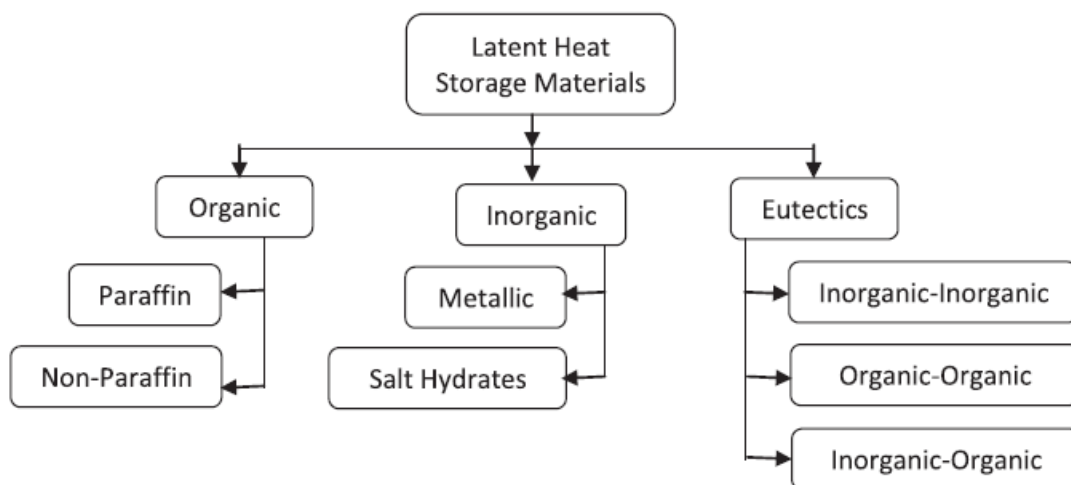

Figure 37: Classification of latent heat storage materials for thermal storage [65]

In general, phase transformation of the material can be solid–solid, solid–liquid, or liquid–gas. Transformation of crystalline nature from one to other will be observed in solid–solid latent heat storage material, whereas phase change of the material will be used to store thermal energy in the other two methods of the latent heat storage materials. Solid–solid has an advantage of small fluctuations in volume and greater design flexibility, but less latent heat compared to solid–liquid and liquid–gas which both have larger latent heat and larger volume changes. Latent heat storage materials can be classified based on temperature, phase transition and compounds used as shown in Figure 37.

9.5 DEMAND RESPONSE AND FLEXIBILITY SERVICES

The difference between DSM and DR (demand response) is in focus on demand flexibility and short-term customer action (in case of DR) and regular changes in the demand pattern (in case of DSM). In electricity and DH systems, interventions in customers’ energy demand can improve the profitability of cogeneration plants and help to avoid investments in additional generation as well as network capacities. By adjusting the demand to the present availability of fluctuating resources, curtailments can be reduced, and the overall RES share can be increased.

The rapid growth of RES, which tends to have variable and less predictable production profiles, is putting increasing stress on the management of the energy networks. The energy production and distribution system is therefore now moving from a highly centralized and controlled production infrastructure, towards decentralized, distributed and fluctuating production points. However,

the networks are still expected to be able to accept the energy generated, even at times and locations that are not necessarily ideal and meet the consumer expectations regarding energy supply.

DR has the potential to be a valuable strategy to shift/shave some of the load peaks and better match the production and demand curves, with multiple benefits for the those who offer DR services, for the national energy networks, and for the environment.[66]

DC is a very good candidate for DR services, because:

- DC service providers need large amounts of electricity for running their generation plants, especially when heat pumps are used. Even plants based on thermal devices (gas or biomass boilers, solar thermal plants) have significant electricity needs for operating circulating pumps and all auxiliaries. From this perspective, DC systems have a particularly large electricity consumption if they rely on compression chillers. As electricity is an expensive form of energy (be is purchased on the market, or self-produced via CHP systems), which in some cases may hinder the realization of DC systems, additional revenues from DR market can make DC investments profitable;
- DC systems often are equipped with large storage, which can help shifting the peaks, thus adapting to DR market needs.

On the other hand, it is true that many DHC systems have CHP systems installed as well and basically self-produce the required electricity.

If a DC system turns out to be suitable for offering DR services (undersized or missing CHP, storage installed, good knowledge of the cooling demand curve is available), the DC service provider can access an innovative market with additional economic benefits.

9.5.1 HOW TO IMPLEMENT DEMAND RESPONSE STRATEGIES

In order to successfully implement DR in DC system, the first step is to determine how users actually make use of cooling in time (consumer behavior). As a DC system typically connects different types of users (e.g. commercial malls, offices, hospitals etc.), cooling demand profiles of different customers may strongly differ one from the other, e.g. peaks may occur at different times of the day and of the year.

Once demand patterns and schedules are known, DR mainly consists of meeting such demand with available cold production plants. The main complexity here is that no recursive load schedule can be defined, as cooling demand depends on customer-related conditions which may vary (changing production needs, holidays, internal gains changing in time) and external conditions (mainly weather conditions). Demand forecasting therefore plays a crucial role in DR systems. It can be either made through detailed energy modelling of customer buildings and facilities, or by analyzing historical consumption data and correlating them with meteorological data.

Finally, forecasting of electricity prices is needed to make decisions at DC system level.

Once all above-mentioned information is available, DC service providers can plan when to purchase electricity from the market, possibly meeting DSOs and TSOs needs and generating additional revenues.

9.6 DISTRICT COOLING IN 4GDH CONTEXT

DH development has entered a new phase, on both system and technology levels, heading towards implementation of the so-called 4th generation district heating (4GDH) concept [67]. 4GDH focuses on integrating DHC systems with the surrounding energy system (Figure 38). In this context, using DHC systems e.g. for balancing excess electricity production from renewable sources represents a very attractive scenario and potential. A low distribution temperature is at the core because it enables low heat losses in distribution and, more significantly, an efficient integration of renewable and excess heat sources. Achieving adequate ΔT across the consumers' ETS is required. A future 4th generation of DC systems can be seen as new smart DC systems being more interactive with the electricity, district heating, and gas grids. Furthermore, combining design of energy supply design with long-term infrastructure planning processes, such as city planning, is also part of the concept.



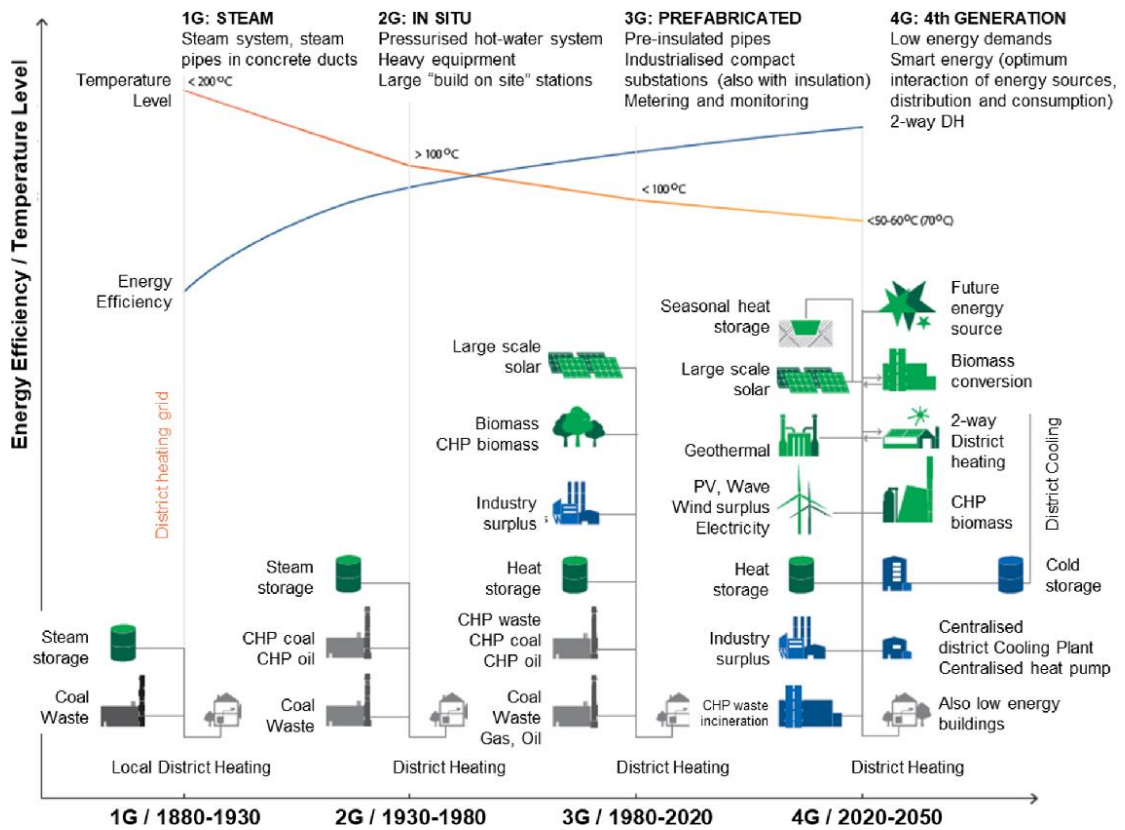

Figure 38: Progression of District Heating – 1st to 4th generation [68]

OPTIONAL READING

The literature on 9.3.1 is done based on [69]

Detailed studies of DR in DC systems can be found in literature [70].



10 BUSINESS MODELS FOR DISTRICT COOLING PROJECTS

10.1 THE DISTRICT HEATING AND COOLING MARKET

‘A district energy system business model includes a range of ownership, financing and revenue options along the value chain of energy services, from generation to transmission, distribution and consumption. System monitoring and system planning are both key to ensuring effective business model decisions on pricing, investment and management. Innovations in district energy system business models are achieved by analysing the impact of changing products, services and pricing to meet customer needs’ [71].

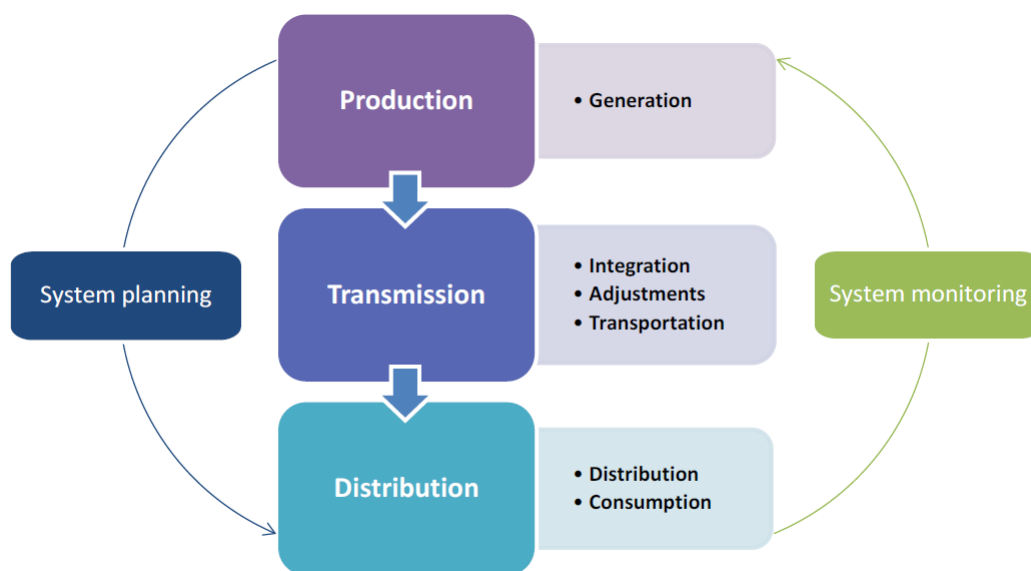

Figure 39: The DHC value chain [71]

According to the EU-funded project STRATEGO [41], *the main roles of a District Heating (DH) system are generation, transport, distribution, and retail. When all the roles are performed within a vertically integrated company, the market structure is bundled. In the other extreme, the unbundled market, all the roles are performed by different legal entities.*

In a bundled market, be is DH or DC, two players can be defined, namely the consumer and the heating/cooling (H/C) service provider. The latter can either be a public or private company, or a cooperative owned by consumers. The following table shows strengths and weaknesses of bundled markets.



Table 18: Strengths and weaknesses of bundled and unbundled DHC markets

Type of market	Strengths	Weaknesses
Bundled	<ul style="list-style-type: none"> Heat price can be regulated if needed Simple administrative structure (low administrative costs) 	<ul style="list-style-type: none"> Low competition (higher prices for customers)
Unbundled	<ul style="list-style-type: none"> Higher competition (lower prices for customers) 	<ul style="list-style-type: none"> Complex administrative structure (high administrative costs)

10.2 OWNERSHIP OF DHC SERVICE PROVIDERS

Municipal DHC companies that own and operating DC systems have been common in many countries, and still are in some European countries (e.g. Sweden and Finland).

A municipal service provider (Publicly-owned or a special purpose entity with a defined business plan) can be established separately from the municipality by creating a separate company owned by the municipality utilizing a ‘project financing’ strategy. In this case, debts flow into the municipal balance sheet. In order to mitigate risk, the business case should be robust [72].

There are also many private service providers with expertise in designing, constructing, operating and optimizing DHC systems. The main advantage is that they are technically skilled and have management capabilities, thus able to face higher risks than a municipality-owned company [72].

In many cases the DHC system is owned by the local authority and are managed by the service provider through a concession contract. The energy production facilities are usually owned by the service provider.

In case of Public-Private Partnerships (PPP), the most common, the participation of the municipality itself in the service provider managing the DHC system simplifies approval of the project (reducing risk, time and cost) and encourages confidence in the service, but at the same time can increase the risk. On the other hand, PPPs benefit from the technical expertise and from the capital of the private sector.



10.3 CONTRACTING BETWEEN CUSTOMERS AND SERVICE PROVIDERS

Contracts between DC service providers and customers should contain conditions to define the quality of service, the rights and responsibilities of both sides, and most importantly the price structure and adjustment methodologies. By reviewing some of the contracts developed by DC service providers, several critical points are outlined as following:

- I. Rights and responsibilities of DC service providers
 - 1) DC service providers define service parameters, including maintaining the agreed temperature and pressure of returned chilled water, operation hours, requirements of maintenance and management of all the control valves, and metering systems in customers buildings. It is their responsibility to maintain these parameters so as to assure the quality of chilled water supply;
 - 2) The DC service providers shall have the right to discontinue the service if the metering systems or piping connected to or within the customers buildings have been tampered with or altered in any manner to unlawfully use the service;
 - 3) DC service providers ensure proper connection between customers buildings to DC system pipelines. If there is more than one pair of chilled water pipelines near the buildings, the DC service provider has the right to determine which pair should be connected. Meanwhile, it's the DC service provider's responsibility to maintain the hydraulic balance in the network pipelines among buildings;
- II. Rights and responsibilities of customers (i.e. building owners)
 - 1) Customers should operate their internal centralized cooling systems in a manner that does not cause surges, water hammers, or any other problems or disturbances to the DC system or its customers receiving chilled water from the DC system. If such a condition is detected from the customers side, they must immediately correct, or discontinue operation until a correction has occurred;

- 2) Centralized cooling systems inside customers buildings should make sure that the returned chilled water should not be lower than a certain temperature, so as to make sure the temperature differences in the DC system can be maintained, and the energy efficiency of the whole DC system can be achieved;
- 3) Customers should give the DC service provider and their contractors access to the ETS inside their buildings for following maintenance and management reasons: a) install, inspect, read, repair, maintain, test or remove its metering equipment, b) install, operate, test, repair, maintain or remove other equipment owned or controlled by the DC service provider, c) inspect service installations and connections;
- 4) The customers or building owners should design their internal cooling systems fully compatible with the design guidelines published by DC service provider, including the location of ETS, connection, control and metering system etc.;
- 5) All building owners are required to carry out periodic water quality analysis on the secondary side (building chilled water circuit) at least once a year in order to ensure the integrity and performance of ETS connecting to DC systems;
- 6) Pricing structure and adjustment method.

Normally, there are several types of DC service charges that customers pay for. They are:

- 1) Connection. One-time initiation fee when customers connect to DC systems;
- 2) Monthly / Demand. Customers pay for the minimum required or guaranteed usage of a DC service;
- 3) Metering / Consumption. Customers pay for this charge as metered how much they consume chilled water monthly.

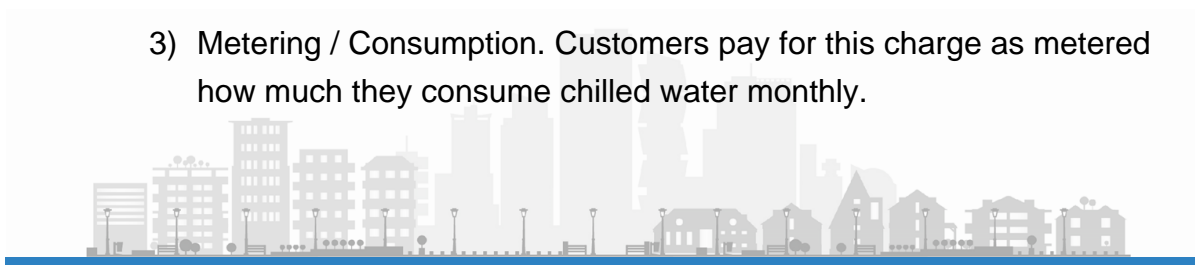

Investment or construction-related boundaries, as well as agreements between customers and DC service providers can impact pricing structures, even within various DC systems in a single city or region.

Another critical component of DC service pricing structure is how to adjust the service price. Generally, the price is directly related to energy price (electricity, water, natural gas etc.). However, the occupancy ratio of the region, real cooling consumption, and even labor fees can also have an impact on the final price. Thus, the pricing adjustment methodology usually contains weighting factors for some of these parameters and should be agreed in the contract.

10.4 OWNERSHIP OF ETS

ETS are the connection point between a DC system and cold distribution to the consumers. They are a crucial component of DC systems, since they must meet several requirements on both sides. For example, temperature and flow rates must satisfy the customer but also make sure the DC system runs under satisfactory conditions for the DC service provider. They can either be owned by the customers, or by the DC service provider. Mixed solutions are also possible, with all parameters being of a contractual nature: ETS owned by the building owner, with maintenance performed by the DC service provider. Higher DC (or, in the case of DH, lower) temperatures on the secondary side that are needed to adjust the network temperature, or that are a consequence of smart network management, often conflict with contractually guaranteed temperatures [73].

In China, with regards to the connection from ETS to DC Systems *'the approved consumer shall at their own cost design, provide, construct and install the ETS in accordance with the plans and specifications'* [74].

In Spain, one DHC service provider decided to incorporate the ETS maintenance service within their range of services to ensure that ETS follow adequately their maintenance procedures and avoid deficiencies in the supply due to lack of maintenance work. ETS are installed in the customer's building and its maintenance is the responsibility of the DC service client [75].

10.5 INCENTIVES FRAMEWORK

DHC can be supported by central or local governments in different ways, with various, financial and fiscal incentives being possible. UN Environment [75] lists the following options:

- Debt provision and bond financing;

- Loan guarantees and underwriting;
- City-financed revolving fund;
- Grants;
- Low-cost financing/loans;
- Rebates;
- Subsidies;
- Tax credits and exemptions within tax systems: (e.g. sales, property taxes, permitting fees, carbon taxes).
- Other support options which are not directly in the form of financing are:
 - Making city assets available (public land or buildings) for DHC installations;
 - Demonstration projects;
 - Facilitating permits (e.g. use of groundwater for heat pumps);
 - Connecting public buildings to the DHC system;
 - Raising awareness towards DHC (advocacy, help desks).

Out of the many support options listed above, one or more can be chosen for each project according to specific boundary conditions. Due to the high investments needed for DHC projects and considering that usual pay-back periods are long compared to other industrial sectors, stable and long-term revenues are crucial in order to make DC projects financially viable. Public support helps making this possible. At the same time, such stable revenues depend on a careful pre assessment of projects' feasibility.



OPTIONAL READING

For further reference on conditions of service of district cooling [76]

For further reference on district cooling acts [77][78]



11 THE ROLE OF PUBLIC AUTHORITIES IN THE DISTRICT COOLING SECTOR

11.1 THE STRATEGIC VALUE OF DISTRICT COOLING

‘Cooling energy use in buildings has doubled since 2000, from 3.6 EJ to 7 EJ (1 000 to 1 900 TWh), making it the fastest growing end-use in buildings, led by a combination of warmer temperatures and increased activity due to population and economic growth’ [79].

‘Sales are rising three times faster than energy efficiency improvements, and 10 air conditioners will be sold every second over the next 30 years. Final energy use for cooling is estimated to have increased by 5% globally in 2018, consuming around 2 100 TWh of electricity– or nearly as much as all the electricity consumed by G8 countries last year. More than 1.6 billion air conditioning units are now in operation globally, making space cooling the leading driver of new energy demand in buildings’ [80].

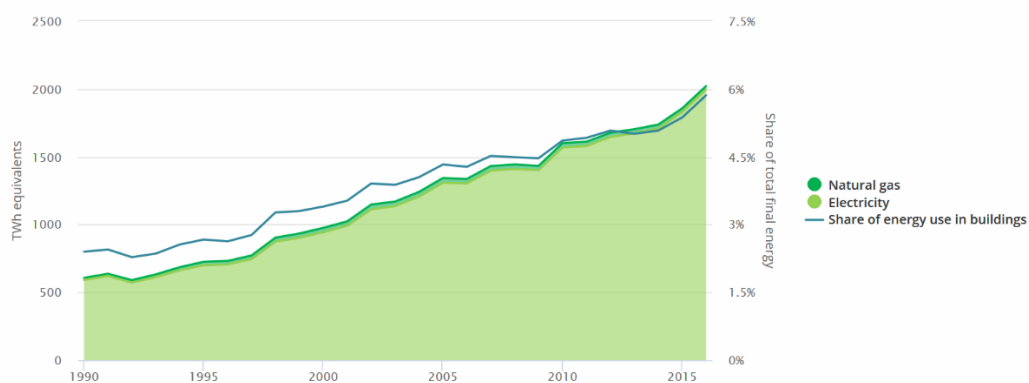

IEA. All rights reserved

Figure 40: Energy use from cooling worldwide [81]

In Figure 40 the high contribution of cooling to energy consumption is quantified, which is directly correlated to greenhouse gas emissions.



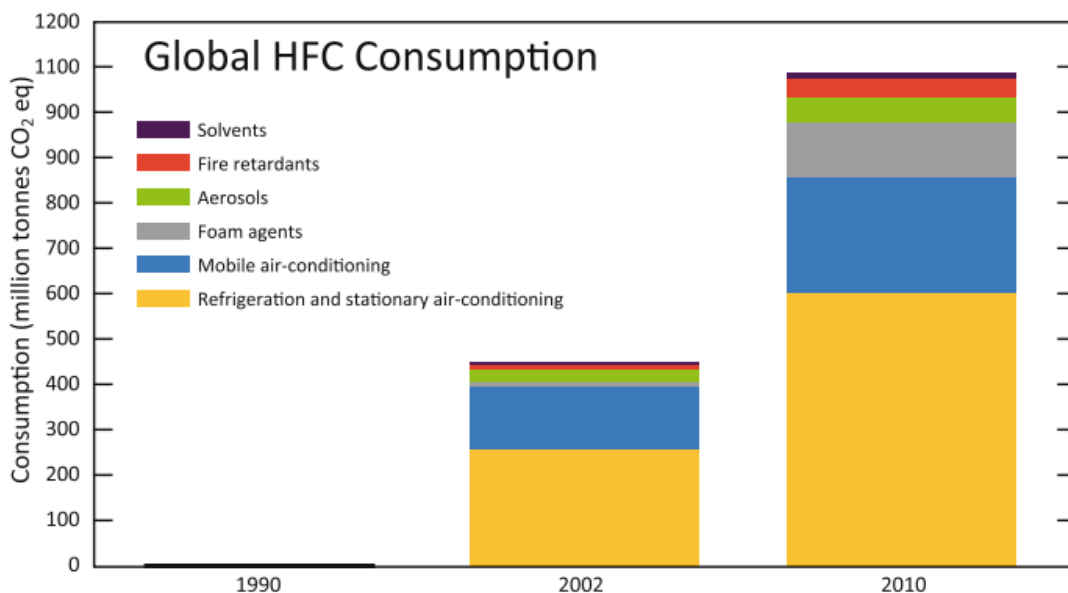

Figure 41: Global HFC consumption [82]

The tremendous impact of cooling to HFC emissions is shown in Figure 41. This problem has been addressed at international level (Montreal and Kigali agreements, see chapter 6.4), but time will be needed before existing equipment is replaced with new refrigerants.

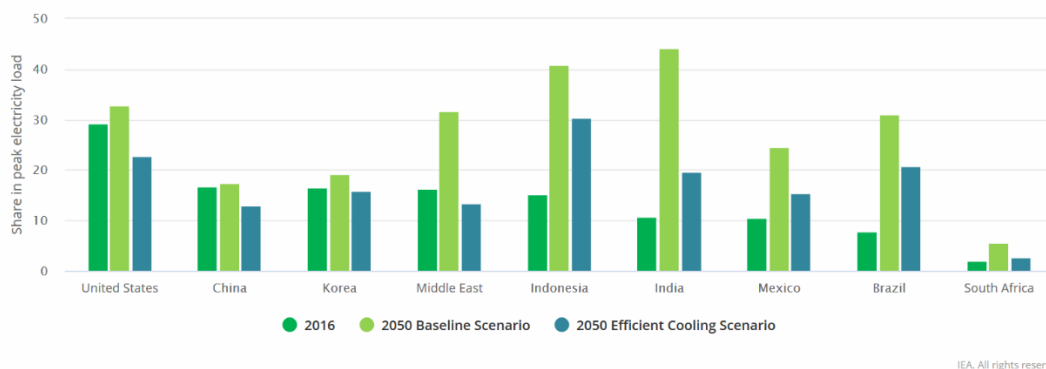

Figure 42: Share of cooling in electricity peak loads [83]

Figure 42 shows the significant impact of cooling on electricity peak, causing issues with the management of the electricity transmission grids in many countries and regions.

It is evident that cooling impacts heavily on society, from the perspective of climate change and of electricity transmission (the latter having large influence on economic development and access to energy). Cooling therefore deserves high attention by international, national and local authorities and administration,

who shall be interested in reducing the local and overall impacts of energy consumption for cooling.

In general, national and regional authorities shall put in place a legislative framework which supports DC as an alternative to autonomous cooling. This can be done in several ways as explained in chapter 10.5 Incentives framework. Given that such positive framework is in place, the active promotion of DC projects should happen at the local level, as this technology is directly impacting on local infrastructures (streets, underground service providers etc.).

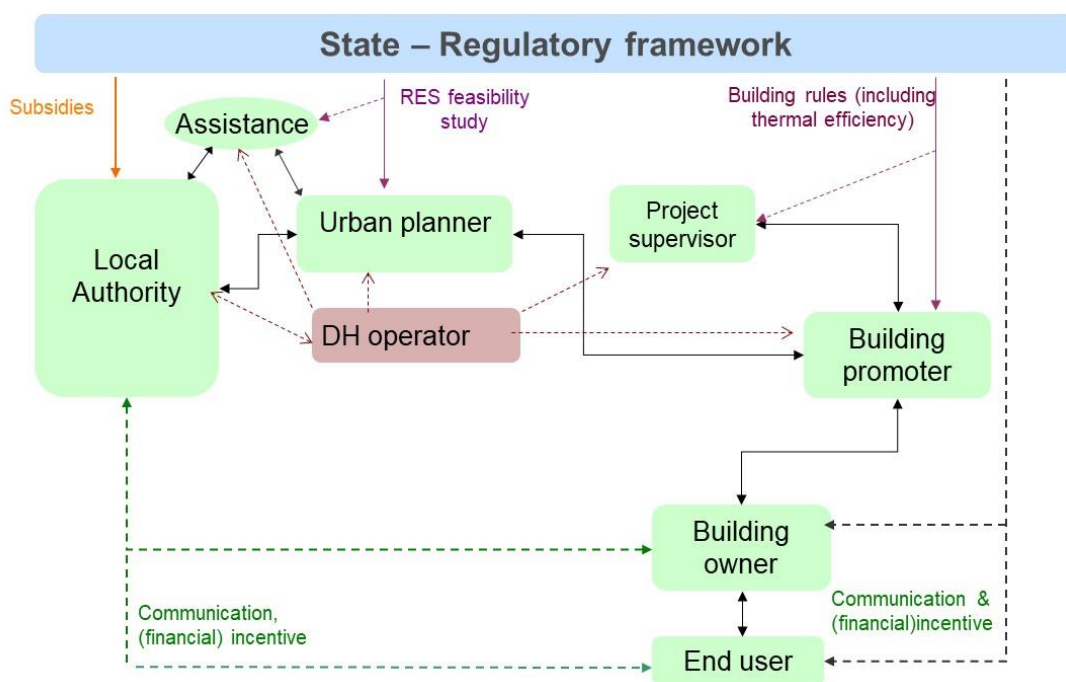

Figure 43: Stakeholders and decision making for DHC development

Figure 43 shows the relation of different stakeholders in the decision process of DHC projects. It is of utmost importance that the DHC service provider gets in touch with all stakeholders before new urban projects are initiated, in order to actively influence the decision-making process.

11.2 DISTRICT COOLING AND URBAN PLANNING

There is close connection between DC and urban planning. On the one hand, local urban planning offices must be aware of the benefits of DC in order to stimulate new projects and simplify the authorization process of DC projects initiated by third-parties. Authorization is indeed one of the main barriers to the take-off of DHC projects. On the other hand, local administrations need DC, as

this technology is one among few possible solutions for improving energy efficiency and reducing the local impact of cooling energy consumption.

If well trained, urban planners can evaluate whether DC is a possible alternative to autonomous cooling and, if it is, plan which parts of the territory should be served by the DC system. Moreover, they can influence the decision process about which cold generation technologies should be used. As an example, cooling generation from solar technologies (solar PV plus compression chillers, or solar thermal plus sorption chillers) requires large areas for installing solar panels. Such areas need to be found and their use for energy generation to be authorized. When it comes to the need for large seasonal storages (e.g. large solar thermal collector fields supplying energy to DHC systems), space for those storages must be found and authorized. One should consider that municipalities are more and more involved in sustainable energy planning, for example through the Covenant of Majors and Sustainable Energy Action Plans. From this point of view, municipalities may:

- Establish energy action plans and set targets for renewable energy penetration in heating and cooling;
- Evaluate different development scenarios and identify which areas best fit to DHC and which do not fit;
- Insert DHC net map in the local urban planning document
- Map heating and cooling demand across their territory (e.g. through open map applications);
- Map RES and excess heat sources across their territory (e.g. through open map applications);
- Influence the way new buildings are constructed with regard to cooling production and distribution (building codes);
- Influence the way existing buildings are renovated with regard to cooling production and distribution (building codes);
- Make connection to DC systems mandatory [84].

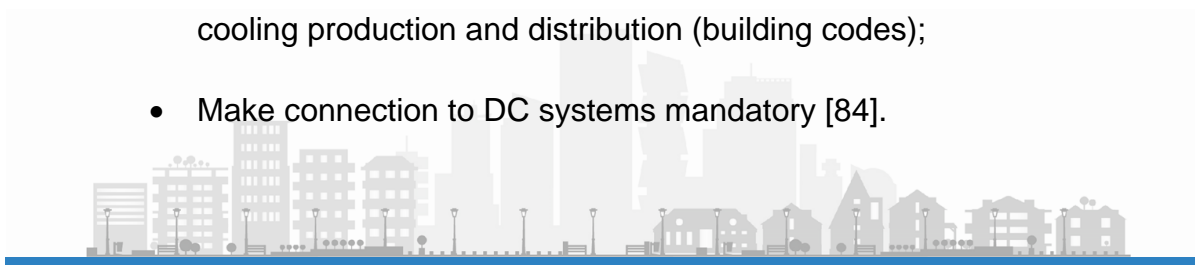

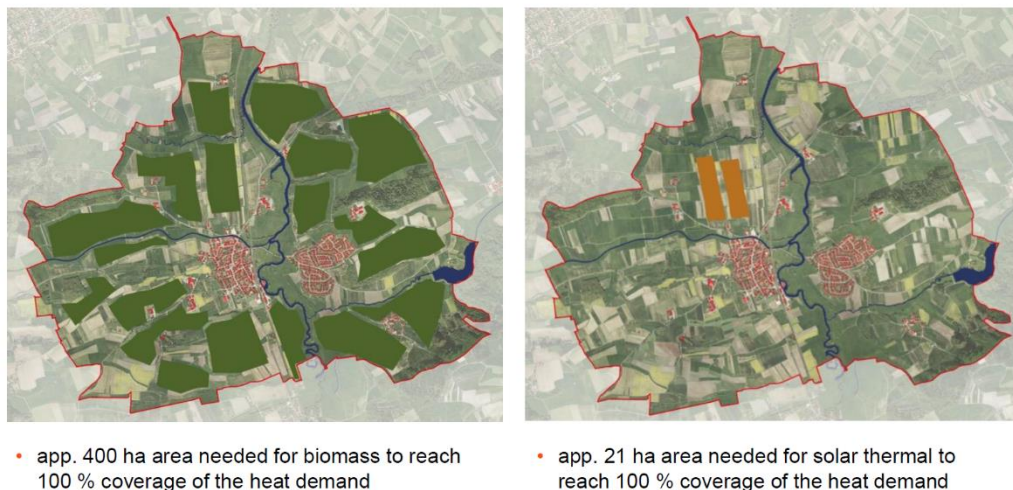

Figure 44: Urban planning example for a biomass + solar thermal supply of a DH system [85]

DC pipes are usually buried under streets of other public infrastructures, which calls for the need of careful planning by local administration. For example, DC pipes can be installed together with other service providers such as data cables, drinking water distribution, sewage water collection, gas distribution network, electricity cables. Installing pipes under streets and railways requires a good planning as well in order to minimize the impact on the all-day-life of citizens in a city, in a village or in any other district.



APPENDIX 1 FLOWCHART

A roadmap is provided here for quick reference in the form of flowchart that describes the steps for implementing a sustainable district cooling system. Please remember that the DC planning should start by considering ways to reduce the cooling demand and especially the demand during the national peak hours of electricity consumption.

In each step of the process, references are made to the respective section of the document that provide more detailed information.

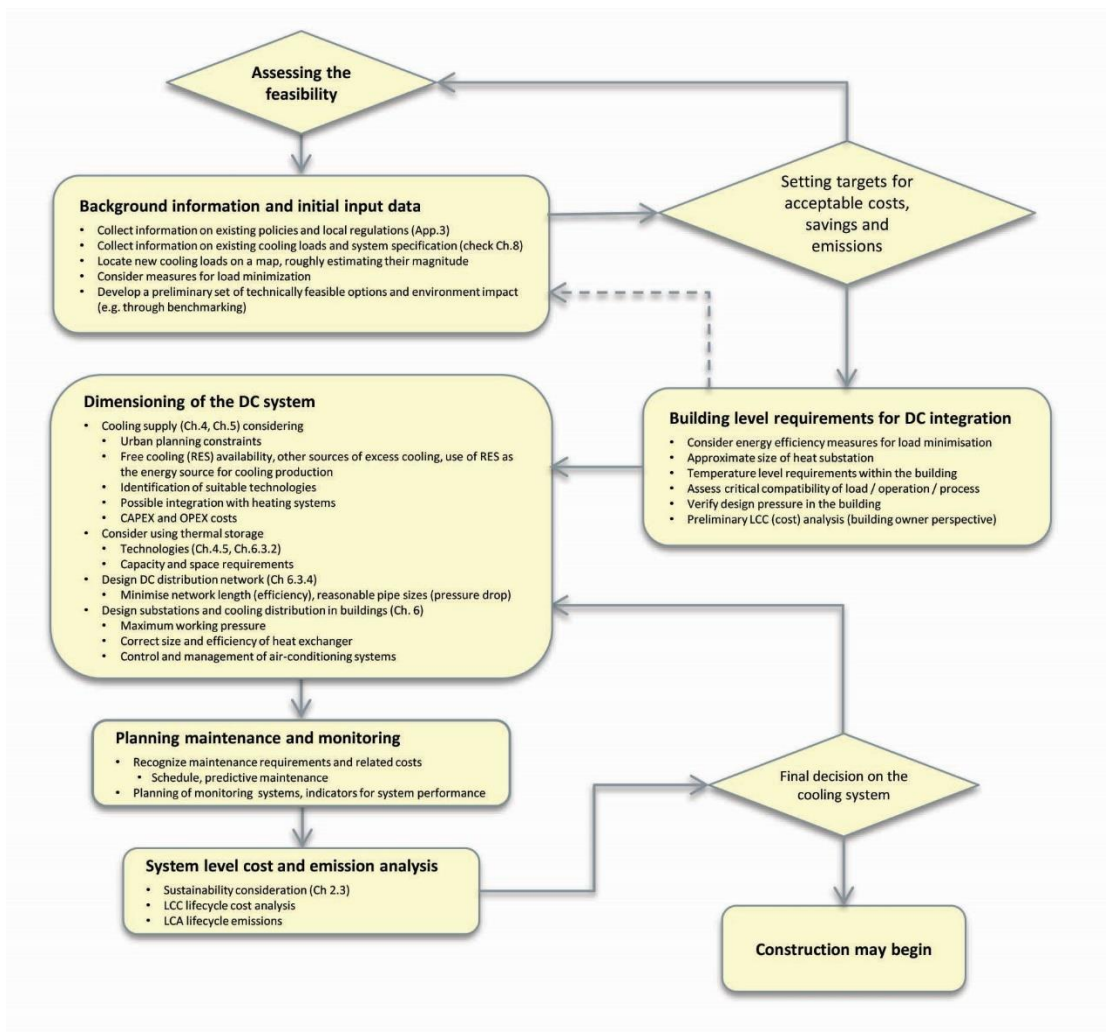

APPENDIX 2 PROJECT DEVELOPMENT CHECKLIST

	YES	NO	FOLLOWUP
Mapping & Planning:			
Is district cooling integrated into urban planning?			
Is the most potential area in the region for district cooling highlighted?			
Is free cooling considered in the district cooling planning and design?			
Is waste heat from industrial or power plant considered for cooling?			
Is the future expanding of the pipe network considered?			
Have maintenance requirements and procedures been considered?			
Have all relevant standards been considered?			
Site selection:			
Has the cooling demand been evaluated carefully?			
Can the site be integrated with other facilities, like landscaping fields or bus terminals?			
Is the site closed to the buildings with most cooling demand?			
Is it evaluated whether the noise from cooling towers affects nearby buildings?			
Energy efficiency:			
Does the following equipment fulfil the energy efficiency requirements in Building Energy Efficiency code or Green Building codes?			
1.Chiller			
2.Cooling tower			
3.Primary pump			
4.Secondary pump			
5.Heat exchanger			

6.System COP			
Water efficiency:			
Does the cooling tower achieve the water efficiency requirement in Building Energy Efficiency code or Green Building codes?			
Are there any metering systems to monitor the leakage in the distribution network?			
Refrigerant:			
Are the chillers using eco-friendly refrigerant? (Non-HFC/HCFC)			
Have measures been taken to reduce Global Warming Potential (GWP)?			
Thermal storage:			
Is the thermal storage considered and operated in the off-peak period?			
Is the thermal storage system shifting at least 3 hours of peak electricity load period?			
Is the cost-effective analysis applied to determine the size of the thermal storage system?			
Health-related issues:			
Has the Legionella risk been considered and have adequate measures been taken to minimize it?			
Have measures been taken to reduce the internal noise level of the mechanic room/district cooling system?			



APPENDIX 3 STANDARDIZATION AND REGULATORY REQUIREMENTS IN EUROPE AND WORLDWIDE

DC systems are complex environments involving mechanical devices, electric devices, hazardous substances, construction sites, different kinds of processes, data management, IT and control, liquids and gases and even more. For this reason, there are basically plenty of standardization areas which apply to separate parts of DC systems. Furthermore, there are standards which address DH systems and few ones, mainly in China, which consider DC systems specifically.

Aim of appendix 3 is to give an overview on main areas and mention most relevant standards, with no ambition of exhaustiveness.

Table 19 lists standards according to standardization areas. It is divided in European Directives, European standards, US standards, International standards, Chinese standards.

Table 19 Main relevant standards on DE

Standardization area	Standard n.	Brief description
European Directives		
Energy efficiency	Energy Efficiency Directive (2012/27/EU)	This Directive establishes a common framework of measures for the promotion of energy efficiency within the Union in order to ensure the achievement of the Union's 2020 20 % headline target on energy efficiency.
Energy efficiency	Energy Performance of Buildings Directive (EU 2018/844)	This Directive promotes the improvement of the energy performance of buildings within the Union, taking into account outdoor climatic and local conditions, as well as indoor climate requirements and cost-effectiveness.
Renewable energy sources	RES directive recast (EU 2018/2001)	This Directive establishes a common framework for the promotion of energy from renewable sources. It sets a binding Union target for the overall share of energy from renewable sources in the

		Union's gross final consumption of energy in 2030.
Measuring Instruments	MID (2014/32/EU)	This Directive applies to the measuring instruments defined in the instrument-specific Annexes concerning, among others water, gas, electrical, and thermal energy meters.
Machinery	Machinery Directive (2006/42/EC)	This Directive applies, among others, to safety components.
Energy Services	Energy Services Directive (2012/27/EU)	This Directive establishes a common framework of measures for the promotion of energy efficiency within the Union in order to ensure the achievement of the Union's 2020 headline target on energy efficiency. It lays down rules designed to remove barriers in the energy market and overcome market failures that impede efficiency in the supply and use of energy and provides for the establishment of indicative national energy efficiency targets for 2020.
Eco-design Directive	(2009/125/EC)	This Directive establishes a framework for the setting of Community eco-design requirements for energy-using products with the aim of ensuring the free movement of those products within the internal market
Pressure Equipment	PED (2014/68/EU)	This Directive shall apply to the design, manufacture and conformity assessment of pressure equipment and assemblies with a maximum allowable pressure PS greater than 0.5 bar.
European technical guidelines for the prevention, control and investigation of infections caused by Legionella species	European technical guidelines 2017	This directive establishes technical guidelines which have been prepared that reflects developments in clinical and environmental microbiology for the detection, control and prevention of Legionella infections and also from experience gained in investigating incidents and outbreaks of Legionnaires'

disease as a result of Legionella contamination and colonization in building water systems.

European Standards

Energy performance of buildings	EN 15316-4-5	Determination of energy indicators of DHC systems. DHC systems can be district heating, DC or other DHC carriers.
Energy performance of buildings	EN 15316-6-8	Refers to the EN 15316-4-5 standard. It contains information to support the correct understanding, use and national adaptation of the EN 15316-4-5 standard.
District heating pipes - Pipe assembly of steel service pipe, polyurethane thermal insulation and outer casting of polyethylene	EN 253+A2	This European Standard specifies requirements and test methods for straight lengths of prefabricated thermally insulated pipe-in-pipe assemblies for directly buried hot water networks, comprising a steel service pipe from DN 15 to DN 1200, rigid polyurethane foam insulation and an outer casing of polyethylene.
District heating pipes - Fitting assemblies of steel service pipes, polyurethane thermal insulation and outer casing of polyethylene	EN 448	This European Standard specifies requirements and test methods for fittings of prefabricated thermally insulated pipe-in-pipe assemblies comprising a steel service fitting from DN 20 to DN 1200, rigid polyurethane foam insulation and an outer casing of polyethylene for use in directly buried hot water networks with pre-insulated pipe assemblies in accordance with EN 253.
District heating pipes - Twin pipe assembly of steel service pipe, polyurethane thermal insulation and outer casing of polyethylene	EN 15698-1	This European Standard for DH Twin Pipes, specifies requirements and test methods for straight lengths of prefabricated thermally insulated pipe-in-pipe assemblies for directly buried hot water networks, comprising two steel service pipes from DN 15 to DN 250, rigid polyurethane foam insulation and one cylindrical outer casing of polyethylene.

<p>District heating pipes - Fitting and valve assembly of steel service pipes, polyurethane thermal insulation and outer casing of polyethylene</p>	<p>EN 15698-2</p>	<p>This European Standard specifies requirements and test methods for fittings of prefabricated thermally insulated twin pipe assemblies comprising steel service fittings and/or valves from DN 15 to DN 250, rigid polyurethane foam insulation and an outer casing of polyethylene for use in directly buried hot water networks with pre-insulated twin pipe assemblies in accordance with EN 15698 1:2009.</p>
<p>Classification, general requirements and test methods</p>	<p>EN 15632-1+A1</p>	<p>This European Standard provides classification, general requirements and test methods for flexible, pre-insulated, directly buried district heating pipe systems. It is intended to be used in conjunction with parts 2, 3, 4, and 5.</p>
<p>Bonded plastic service pipes - Requirements and test methods</p>	<p>EN 15632-2+A1</p>	<p>This European Standard provides requirements and test methods for flexible, pre-insulated, directly buried heating pipes with plastics service pipes and bonding between the layers of the pipes.</p>
<p>Non bonded system with plastic service pipes; requirements and test methods</p>	<p>EN 15632-3+A1</p>	<p>This European Standard provides requirements and test methods for flexible, pre-insulated, direct buried district heating pipes with plastic service pipes and no bonding between the layers of the pipes.</p>
<p>Bonded system with metal service pipes; requirements and test methods</p>	<p>EN 15632-4</p>	<p>This European Standard provides requirements and test methods for flexible, pre-insulated, directly buried district heating pipe assemblies with metallic service pipes and bonding between the layers of the pipes and thermal insulation materials of polyurethane or polyisocyanurate foam.</p>
<p>Oil repellency - Hydrocarbon resistance test</p>	<p>EN 14419</p>	<p>This International Standard is applicable to the evaluation of a substrate's resistance to absorption of a selected series of liquid hydrocarbons of different surface tensions.</p>

Thermal energy meters	UNI EN 1434-1:2019	This European Standard specifies the general requirements for thermal energy meters. Thermal energy meters are instruments intended for measuring the energy which in a heat-exchange circuit is absorbed (cooling) or given up (heating) by a liquid called the heat-conveying liquid. The thermal energy meter indicates the quantity of heat in legal units.
Energy Management and related services - General requirements and qualification procedures	CEN/CLC/JWG 3	Energy Management Systems: definition and requirements. Energy Service Companies (ESCO): definition, requirements and qualification procedures. Energy Managers and Experts: roles, professional requirements and qualification Procedures.
Energy efficiency and saving calculation	CEN/CLC/JWG 4	Standards for common methods of calculation of energy consumption, energy efficiencies and energy savings and for a common measurement and verification of protocol and methodology for energy use indicators.
Heating systems and water based cooling systems in buildings	CEN/TC 228	Standardization of functional requirements for all types of heating systems, including domestic hot water production, water based cooling emission and distribution systems in buildings and electricity generation systems in the direct environment of the building.
Heat pumps and air conditioning units	CEN/TC 113	Standardization of testing and requirements for the performance of factory assembled heat pumps, air conditioning units (ducted and non-ducted), hydronic room fan coil units, and liquid chilling packages whether vapor compression or sorption, regardless of energy used, for domestic or commercial purposes excluding industrial processes and also excluding the rational use of gas

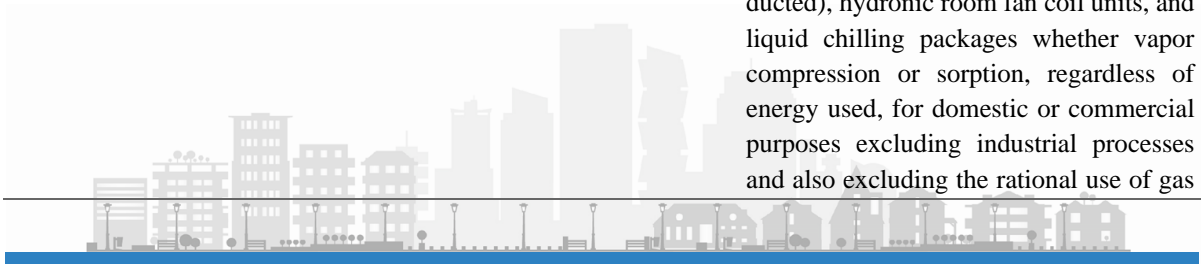

		energy which is within the scope of CEN/TC 299.
Refrigerating systems, safety and environmental requirements	CEN/TC 182	Standardization of requirements in the field of safety and environment for the design, construction, installation, testing, operation, maintenance, repair and disposal of refrigerating systems used for cooling and/or heating.
Heat exchangers	CEN/TC 110	This European Standard specifies requirements for test methods and acceptance conditions for the thermal, hydraulic and acoustic performance of natural draught wet cooling towers.
Water wells and borehole heat exchangers	CEN/TC 451	Standardization in the field of design, environmental aspects, drilling, construction, completion, operation, monitoring, maintenance, rehabilitation and dismantling of wells and borehole heat exchangers for uses of groundwater and geothermal energy. Oil, gas and other mining activities in these fields are excluded from the scope
Safety of household and similar electrical appliances	CLC/TC 61	To harmonize recognized international standards dealing with safety requirements for electrical appliances for household and similar purposes and, where necessary, to prepare harmonized standards for such appliances. Health and environmental requirements are to be considered.
Eco-efficient Substations for District Heating	CWA 16975:2016	The scope of these certification guidelines covers eco-efficient substations for district heating manufactured according to the CEN Workshop Agreement 16975:2016 'Eco-efficient Substations for District Heating'.



International Standards

Evaluation of energy savings	ISO/TC 257	This International Standard aims to provide standards used to determine the energy savings covering regions, cities, organizations and projects.
Testing and rating of air-conditioners and heat pumps	ISO/TC 86/SC 6	Standardization in the fields of refrigeration and air conditioning, including terminology, mechanical safety, methods of testing and rating equipment, measurement of sound levels, refrigerant and refrigeration lubricant chemistry, with consideration given to environmental protection.
Cogeneration systems - Technical declarations for planning, evaluation and procurement	ISO 26382:2010	This international standard describes the technical declarations for a CHP that simultaneously supplies electricity and heating and/or cooling, for planning, evaluation and procurement.
Life Cycle Analysis	ISO 14040:2006 ISO 14044:2006	These international standard describes the principles and framework for LCA including: definition of the goal and scope of the LCA, the LCI phase, the LCIA phase, the life cycle interpretation phase, reporting and critical review of the LCA, limitations of the LCA, the relationship between the LCA phases, and conditions for use of value choices and optional elements.

US Standards

Construction of Pressure Vessels	ASME 2007	Requirements applicable to the design, fabrication, inspection, testing, and certification of pressure vessels.
Dimensioning and Tolerancing	ASME 2009	The Y14.5 standard is considered the authoritative guideline for the design language of GD&T. It establishes uniform practices for stating and interpreting GD&T and related requirements for use on engineering drawings and in related documents.

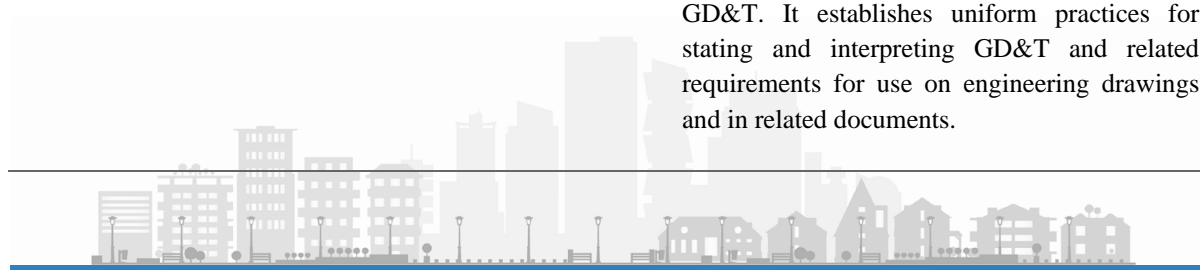

Performance Rating Of Thermal Storage Equipment Used For Cooling	ANSI/AHRI 901-SI-2014	This standard applies to Thermal Storage Equipment used for cooling which may be charged and discharged with any of a variety of heat transfer fluids. The equipment, as further described in Sections 3 and 4, may be fully factory assembled; assembled on site from factory supplied components; or field erected in accordance with pre-established design criteria.
Chinese Standards		
Technical code for gas-fired combined cooling, heating and power engineering	GB51131-2016	This standard applies to the design, construct and operate of tri-generation systems, which provide heating, cooling and electricity and use natural gas as the primary energy. It outlines the major technical considerations, energy efficiency indicators and must-do list during the whole period.
Design guideline for district cooling systems	2018-01-G02	This guideline applies to state-of-the-art considerations from the project development, feasibility study to detailed design.
Design guideline for thermal storage of cooling systems	JGJ 158-2008	This guideline outlines the state-of-the art rules for applying different types of thermal cooling storage in building or district level.
Handbook for heating, ventilation and air conditioning design (second edition)	China Building Industry Press	This handbook is a summary of different steps, technologies applied in heating, ventilation and air conditioning. There are chapters on how to design district cooling distribution network as well as the overall system from project development stage to detailed design.
Evaluation method and testing method for energy performance of refrigerating systems— Part 1: Energy-storage air conditioning systems	GB/ GB/T 37227.1-2018	The standard describes how to measure the energy efficiency of cooling systems with thermal storage. It gives out the requirements for data collection, part load test period and data quality.



APPENDIX 4 TEMPERATURE INCREASE AND HEAT LOSSES WITH RESPECT TO PIPE DIAMETERS

Table 20: Calculated results of temperature increase and heat losses in supply chilled water (1.1°C)

DN	Temperature increase (°C/1,000m)						Heat loss (Wh/m)					
	Flow rate (m/s)						Flow rate (m/s)					
	1.5	2	2.5	3	3.5	4	1.5	2	2.5	3	3.5	4
100	0.26	0.20	0.16	0.13	0.11	0.10	13.02	13.02	13.02	13.02	13.02	13.02
150	0.17	0.13	0.10	0.08	0.07	0.06	18.43	18.43	18.43	18.43	18.43	18.43
200	0.12	0.09	0.07	0.06	0.05	0.05	23.82	23.82	23.82	23.82	23.82	23.82
250	0.10	0.07	0.06	0.05	0.04	0.04	29.20	29.20	29.20	29.20	29.20	29.20
300	0.08	0.06	0.05	0.04	0.03	0.03	34.58	34.58	34.58	34.58	34.58	34.58
350	0.07	0.05	0.04	0.03	0.03	0.03	39.95	39.95	39.95	39.95	39.95	39.95
400	0.06	0.04	0.03	0.03	0.02	0.02	45.32	45.32	45.32	45.32	45.32	45.32
450	0.05	0.04	0.03	0.03	0.02	0.02	50.69	50.69	50.69	50.69	50.69	50.69
500	0.05	0.03	0.03	0.02	0.02	0.02	56.06	56.06	56.06	56.06	56.06	56.06
550	0.04	0.03	0.03	0.02	0.02	0.02	61.43	61.43	61.43	61.43	61.43	61.43
600	0.04	0.03	0.02	0.02	0.02	0.01	66.80	66.80	66.80	66.80	66.80	66.80
650	0.04	0.03	0.02	0.02	0.02	0.01	72.17	72.17	72.17	72.17	72.17	72.17
700	0.03	0.02	0.02	0.02	0.01	0.01	77.54	77.54	77.54	77.54	77.54	77.54
800	0.03	0.02	0.02	0.01	0.01	0.01	88.28	88.28	88.28	88.28	88.28	88.28
900	0.03	0.02	0.02	0.01	0.01	0.01	99.01	99.01	99.01	99.01	99.01	99.01

1,000	0.02	0.02	0.01	0.01	0.01	0.01	109.75	109.75	109.75	109.75	109.75	109.75
1,100	0.02	0.02	0.01	0.01	0.01	0.01	120.48	120.48	120.48	120.48	120.48	120.48
1,200	0.02	0.01	0.01	0.01	0.01	0.01	131.22	131.22	131.22	131.22	131.22	131.22
1,300	0.02	0.01	0.01	0.01	0.01	0.01	141.95	141.95	141.95	141.95	141.95	141.95
1,400	0.02	0.01	0.01	0.01	0.01	0.01	152.68	152.68	152.68	152.68	152.68	152.68
1,500	0.02	0.01	0.01	0.01	0.01	0.01	163.42	163.42	163.42	163.42	163.42	163.42

Table 21: Calculated results of temperature increase and heat losses in return chilled water (13°C)

DN	Temperature increase (°C/1,000m)						Heat loss (Wh/m)					
	Flow rate (m/s)						Flow rate (m/s)					
	1.50	2.00	2.50	3.00	3.50	4.00	1.50	2.00	2.50	3.00	3.50	4.00
100	0.12	0.09	0.07	0.06	0.05	0.04	5.68	5.68	5.68	5.68	5.68	5.68
150	0.07	0.05	0.04	0.04	0.03	0.03	8.05	8.05	8.05	8.05	8.05	8.05
200	0.05	0.04	0.03	0.03	0.02	0.02	10.40	10.40	10.40	10.40	10.40	10.40
250	0.04	0.03	0.03	0.02	0.02	0.02	12.75	12.75	12.75	12.75	12.75	12.75
300	0.03	0.03	0.02	0.02	0.02	0.01	15.10	15.10	15.10	15.10	15.10	15.10
350	0.03	0.02	0.02	0.01	0.01	0.01	17.45	17.45	17.45	17.45	17.45	17.45
400	0.03	0.02	0.02	0.01	0.01	0.01	19.79	19.79	19.79	19.79	19.79	19.79
450	0.02	0.02	0.01	0.01	0.01	0.01	22.14	22.14	22.14	22.14	22.14	22.14
500	0.02	0.02	0.01	0.01	0.01	0.01	24.48	24.48	24.48	24.48	24.48	24.48
550	0.02	0.01	0.01	0.01	0.01	0.01	26.83	26.83	26.83	26.83	26.83	26.83

600	0.02	0.01	0.01	0.01	0.01	0.01	29.17	29.17	29.17	29.17	29.17	29.17
650	0.02	0.01	0.01	0.01	0.01	0.01	31.52	31.52	31.52	31.52	31.52	31.52
700	0.01	0.01	0.01	0.01	0.01	0.01	33.86	33.86	33.86	33.86	33.86	33.86
800	0.01	0.01	0.01	0.01	0.01	0.01	38.55	38.55	38.55	38.55	38.55	38.55
900	0.01	0.01	0.01	0.01	0.01	0.00	43.24	43.24	43.24	43.24	43.24	43.24
1,000	0.01	0.01	0.01	0.01	0.00	0.00	47.92	47.92	47.92	47.92	47.92	47.92
1,100	0.01	0.01	0.01	0.00	0.00	0.00	52.61	52.61	52.61	52.61	52.61	52.61
1,200	0.01	0.01	0.01	0.00	0.00	0.00	57.30	57.30	57.30	57.30	57.30	57.30
1,300	0.01	0.01	0.00	0.00	0.00	0.00	61.99	61.99	61.99	61.99	61.99	61.99
1,400	0.01	0.01	0.00	0.00	0.00	0.00	66.67	66.67	66.67	66.67	66.67	66.67
1,500	0.01	0.01	0.00	0.00	0.00	0.00	71.36	71.36	71.36	71.36	71.36	71.36



LIST OF FIGURES

Figure 1: general scheme of a District Cooling system [4].....	14
Figure 2: Proposed sustainability assessment framework [7].....	21
Figure 3: Development Process.....	24
Figure 4: Business Project Management	25
Figure 5: The general principle of DC operation.	44
Figure 6: Principle schematic of an adsorption chiller[13].....	48
Figure 7: Trigeration scheme [21]	50
Figure 8: Integration possibilities of different technologies with DC system [15]	52
Figure 9: Schemas of DC with different thermal storage systems [15] : serial connection with chillers (a) upstream and (b) downstream; (c) parallel connection.	53
Figure 10: View over the Zuidas area with ABM Amro on the left	57
Figure 11: The DC system in Zuidas, Amsterdam	57
Figure 12: Outlook of Opera Building.....	58
Figure 13: The CCHP system	60
Figure 14: the DC system in Hengqin, PRC	61
Figure 15: DC system with large scale thermal energy storage	63
Figure 16: Map of network	64
Figure 17: Installations in Helsinki	66
Figure 18: Overview of the new district of Longhu Financial Center, Zhengzhou, PRC	67
Figure 19: Evaluation of noise level.....	69
Figure 20: Water temperature.....	70
Figure 21: The Stockholm City DC system [17]	73

Figure 22: The second largest Stockholm system, the Kista system, designed for 50 MW [17]	73
Figure 23: Basic steps to develop DC system from energy planning to final technical solutions.....	76
Figure 24: Cost-effectiveness of ice storage ratio [39].....	86
Figure 25: Installation of meters and valves of heat exchangers in ETS	92
Figure 26: Schematic example of installation with cooling towers and the key components to review during risk assessments [46]	96
Figure 27: The three steps of the approach based on electricity bills	109
Figure 28: Monthly electricity consumption of hotels in Marrakech in 2016.....	109
Figure 29: Identification of the electricity consumption for space cooling	110
Figure 30: The three steps of the approach based on CDD	111
Figure 31: The touristic site of Portopiccolo, in the town of Duino Aurisina, Italy.....	116
Figure 32: Simplified hydraulic scheme of the DHC system in Portopiccolo.	117
Figure 33: Principle scheme (winter)	118
Figure 34: Principle scheme (summer)	118
Figure 35: DC system in Vienna [62]	120
Figure 36: Modern DHC system of Helsinki combining DH and DC [63]	121
Figure 37: Classification of latent heat storage materials for thermal storage [65]	122
Figure 38: Progression of District Heating – 1st to 4th generation [68]	125
Figure 39: The DHC value chain [71].....	126
Figure 40: Energy use from cooling worldwide [81]	133
Figure 41: Global HFC consumption [82].....	134
Figure 42: Share of cooling in electricity peak loads [83].....	134

Figure 43: Stakeholders and decision making for DHC development 135

Figure 44: Urban planning example for a biomass + solar thermal supply of a DH system
[85] 137



LIST OF TABLES

Table 1. Example of criteria for sustainability assessment [8]	23
Table 2: Summary of chiller characteristics [12]	45
Table 3: Cooling capacity	62
Table 4: Building area	67
Table 5: Waste water usage	69
Table 6: Diversity factors for different district types [37]	78
Table 7: Direct and indirect interconnections [12]	80
Table 8: Cooling production	82
Table 9: Comparison of different thermal storage technologies [38]	84
Table 10: Comparison of ice and chilled water storage	85
Table 11: Recommended control friction for different pipe size	89
Table 12: Recommendations for ETS and heat exchanger settings	91
Table 13: Refrigerants that can be used in countries under Montreal Protocol and Kigali Amendment [43]	93
Table 14: Cooling efficiency of chillers with different kinds of refrigerants [44]	94
Table 15: Key points for auditing a cooling tower system [46]	96
Table 16: Estimation of annual cooling consumption of different buildings in Chinese cities (kWh/m ²) [37]	113
Table 17: Electricity consumption per usage and per tertiary subsector in Brussels area [57]	114
Table 18: Strengths and weaknesses of bundled and unbundled DHC markets	127
Table 19 Main relevant standards on DE	141



Table 20: Calculated results of temperature increase and heat losses in supply chilled water (1.1°C)..... 149

Table 21: Calculated results of temperature increase and heat losses in return chilled water (13°C)..... 150



BIBLIOGRAPHY

- [1] AREA, “Guidelines: How to Approach District Cooling,” 2014.
- [2] EuroHeat & Power, “Country Profiles Archives: District Energy in Sweden,” 2017.
- [3] S. Werner, “International review of district heating and cooling,” *Energy*, vol. 137. pp. 617–631, 2017.
- [4] “Devcco – District Energy Venture.” [Online]. Available: <https://www.devcco.se/>.
- [5] “Directive (EU) 2018/2001 of the European Parliament and of the Council of 11 December 2018 on the promotion of the use of energy from renewable sources,” 2018.
- [6] “The European Cold Market, Final Report, Ecoheatcool and Euroheat & Power,” *ECOHEATCOOL Proj.*, 2006.
- [7] M. Sipilä, K., Rämä, “Distributed Energy Systems - DESY.,” *VTT Tech. Res. Cent. Finl.*, vol. 224, 2015.
- [8] K. Hacatoglu, M. Rosen, and I. Dincer, “An Approach to Assessment of Sustainability of Energy Systems,” 2013, pp. 363–387.
- [9] “DISTRICT HEATING AND COOLING.” [Online]. Available: <https://celsiuscity.eu/district-heating-and-cooling/>.
- [10] Seimens, “Factsheet: District Cooling Plants.”
- [11] “District Energy Explained.” [Online]. Available: <https://www.euroheat.org/knowledge-hub/district-energy-explained/>.
- [12] ASHRAE, *District Cooling Guide*. ASHRAE, 2013.
- [13] SOLAIR Project, “WP2-SOLAIR-Best Practice Catalogue on Successful Running Solar Air-Conditioning Appliances,” 2009.
- [14] Bryair, “Adsorption Chiller Advantages.” [Online]. Available: <https://www.bryair.com/news-and-events/articles/adsorption-chiller-advantages/>.
- [15] G. D. Gang W, Wang S, Xiao F, “District cooling systems: Technology integration, system optimization, challenges and opportunities for applications. Renewable and Sustainable Energy Reviews,” vol. 53, pp. 53: 253-264, 2016.
- [16] Zhen L, Lin D, Shu HW, Jiang S, Zhu YX, *District cooling and heating with seawater as heat source and sink in Dalian, China*. 2007.
- [17] Fortum, Capital cooling, “Showcase of district cooling systems in Europe – Stockholm,” *Int. Energy Agency*.
- [18] Poeuf P, Senejean B, Ladaurade C, “District cooling system: the most efficient system for urban application,” in *Sustainable refrigeration and heat pump technology conference-KTH Royal Institute of Technology, Sweden*, 2010.

- [19] Cities Climate Leadership Group, “Lake Water Air Conditioning Reduces Energy Use by 90%,” [Online]. Available: https://www.c40.org/case_studies/lake-water-air-conditioning-reduces-energy-use-by-90.
- [20] Zogg R, Roth K, Brodrick J, “Lake-source district cooling systems,” in *ASHRAE*, 2008, pp. 50(2):55–6.
- [21] Clarke Energy, “Clarke Energy Company.” [Online]. Available: <https://www.clarke-energy.com/gas-engines/trigeneration/>.
- [22] IEA, “The Future of Cooling Opportunities for energy-efficient air conditioning,” 2018.
- [23] S. O. L. I. D. G. für S. und D. MbH, “Solar Cooling.” [Online]. Available: <https://www.solid.at/en/references/solar-cooling>.
- [24] Lanahan M, Tabares-Velasco PC, *Seasonal Thermal-Energy Storage: A Critical Review on BTES Systems, Modeling, and System Design for Higher System Efficiency. Energies*. 2007.
- [25] Airaksinen M, Vainio T, Vesanen T & Ala-Kotila P, “Rakennusten jäähdytysmarkkinat (Finnish),” *VTT*, p. 48, 2015.
- [26] Laitinen A, Rämä M, Airaksinen M, “Jäähdytyksen teknologiset ratkaisut (Finnish),” *VTT*, 2016.
- [27] W. Gang, S. Wang, G. Augenbroe, and F. Xiao, “Robust optimal design of district cooling systems and the impacts of uncertainty and reliability,” *Energy Build.*, vol. 122, pp. 11–22, 2016.
- [28] Dietrich Schmidt and Anna Kallert, “FUTURE LOW TEMPERATURE DISTRICT HEATING DESIGN GUIDEBOOK,” 2017.
- [29] Euroheat and Power, “Cooling More with Less,” p. 32, 2006.
- [30] Bernoulli System AB, “CASE STORY Seawater cooled HVAC-system COPENHAGEN OPERA HOUSE.” [Online]. Available: http://www.bernoulli.se/images/downloads/Case_story_HVAC.pdf.
- [31] Tropical Green Building Network and James Cook University, “CASE STUDY: Cairns Campus District Cooling System,” 2014. [Online]. Available: <https://www.tropicalbuild.com.au/case-studies/district-cooling-system-with-large-scale-thermal-energy-water-storage>.
- [32] S. Uusitalo and C. Team manager, “NEW, UNIQUE HEAT PUMP UTILISING SEA WATER HEAT TO BE BUILT IN VUOSAARI,” 2019. [Online]. Available: <https://www.helen.fi/en/news/2019/heat-pump-sea-water-heat-Vuosaari/>.
- [33] M. Galkin-Aalto and Journalist, “CONSTRUCTION OF FINLAND’S LARGEST ROCK CAVERN HEAT STORAGE FACILITY STARTS,” 2018. [Online]. Available: <https://www.helen.fi/en/news/2018/Construction-of-rock-cavern-heat-storage-facility-starts/>.
- [34] Helen Ltd, “ENERGY PRODUCTION IN HELSINKI,” 2018. [Online]. Available: <https://www.helen.fi/en/company/energy/energy-production/energy-production2/>.

- [35] Helen Ltd, “ESPLANAD HEAT PUMP.” [Online]. Available: <https://www.helen.fi/yritys/energia/energiantuotanto/voimalaitokset/esplanadin-lampöpumpulaitos/>.
- [36] DANISH BOARD OF DISTRICT HEATING, “District heating and cooling in Denmark.” [Online]. Available: <https://dbdh.dk/dhc-in-denmark/characteristics/>.
- [37] China Architecture & Building Press, *Handbook of Heating, Ventilation and Air Conditioning design (in Chinese)*. 2008.
- [38] ARANER, “ARANER TES Tank Reference Book.”
- [39] TRANE, “TRANE ICE STORAGE HANDBOOK.”
- [40] P. E. Grohnheit and B. O. Gram Mortensen, “Competition in the market for space heating. District heating as the infrastructure for competition among fuels and technologies,” *Energy Policy*, 2003.
- [41] STRATEGO project, “Enhanced Heating & Cooling plans,” 2014.
- [42] Tatum R, “What you need to know about the HFC refrigerant phase-out.” [Online]. Available: <https://www.facilitiesnet.com/hvac/article/What-You-Need-To-Know-About-the-HFC-Refrigerant-Phase-Out--17286>.
- [43] S. C. M, “Chillers: what are the trends in refrigerants?,” 2018. [Online]. Available: https://www.carel.com/blog/-/blogs/chillers-what-are-the-trends-in-refrigerants-;jsessionid=CC8CC45FF30E66CFB1A378AB22613353?_33_redirect=http%253A%252F%252Fwww.carel.com%252Fblog%253Bjsessionid%253DCC8CC45FF30E66CFB1A378AB22613353%253Fp_id%253D33%2526p.
- [44] J. Ansbro, “Packaged Ammonia Chillers with Variable Frequency Drives.”
- [45] ASHRAE, *HVAC Applications*. ASHRAE, 2015.
- [46] S. Lee, “ An Overview of the European Technical Guidelines for the Prevention, Control and Investigation of Infections Caused by Legionella species ,” *Perspect. Public Health*, vol. 138, no. 5, pp. 241–247, 2018.
- [47] United Nations Environment Programme (UNEP), “The Montreal protocol on substances that deplete the ozone layer.,” 2000.
- [48] *District Cooling System Engineering Design Specification*. 2011.
- [49] *Regional Cooling System Engineering Design Specification in China for Substations and cooling distribution at building level Section*. .
- [50] S. US EPA, OAR, OAP, “Significant New Alternatives Policy (SNAP) Program,” 2016. [Online]. Available: <http://www.epa.gov/snap>.
- [51] S. Frederiksen, S. Werner, *District heating & cooling*. 2013.
- [52] THE EUROPEAN PARLIAMENT AND THE COUNCIL OF THE EUROPEAN UNION, “Measuring Instruments Directive 2014/32/UE,” *EUR Lex*, 2014.

- [53] Politecnico di Milano and United Nations Environment Program, “DISTRICT ENERGY IN CITIES - Implementation in Morocco - Marrakech Rapid Assessment Report,” 2018.
- [54] Joakim Nilsson, “‘Devcco – District Energy Venture’ based on EU regulation EU/517/2014 on F-gases.” .
- [55] BizEEenergylens, “Problems with common degree-day-based methods.” [Online]. Available: <https://www.energylens.com/articles/degree-days#cdd>.
- [56] M. Jakubcionis and J. Carlsson, “Estimation of European Union service sector space cooling potential,” *Energy Policy*, vol. 113, pp. 223–231, 2018.
- [57] “Brussels Capital Energy Balance report 2013,” 2013.
- [58] “H2020 FLEXYNETS project.” [Online]. Available: <http://www.flexynets.eu/en/Home>.
- [59] I. Bottio, “Visit of Airu to the sea water conditioning system of Portopiccolo,” *SIMM srl*, 2017. [Online]. Available: <http://www.airu.it/visita-di-airu-al-sistema-di-climatizzazione-ad-acqua-di-mare-di-portopiccolo/>.
- [60] B. F., “Recommendations for Combined District Heating and Cooling Networks,” in *4th International Conference on Smart Energy Systems and 4th Generation District Heating Aalborg*, 2018, pp. 13–14.
- [61] R. Z. Dominik Rutz, Christian Doczekal and L. L. J. Morten Hofmeister, *Small Modular Renewable Heating and Cooling Grids*, vol. 1. WIP Renewable Energies, Munich, Germany, 2017.
- [62] Robert Grüneis, “Wien Energie and a strategic overview.”
- [63] Marko Riipinen, “FORERUNNER OF RECYCLING WASTE HEAT, CASE HELSINKI, Global District Energy Days,” 2018.
- [64] Marko Riipinen, “District Heating & Cooling in Helsinki,” in *Clean Energy Ministerial CHP/DHC Working Group International Energy Agency CHP/DHC Collaborative Joint Workshop*, 2013, p. 28.
- [65] G. Raam Dheep and A. Sreekumar, “Influence of nanomaterials on properties of latent heat solar thermal energy storage materials - A review,” *Energy Conversion and Management*, vol. 83, pp. 133–148, 2014.
- [66] “H2020 DR-BOB project.” [Online]. Available: <https://www.dr-bob.eu/>.
- [67] S. S. J E Thorsen, F Hvelplund, B V Mathiesen, H Lund, S Werner, R Wiltshire, “4th Generation District Heating (4GDH),” vol. 68, pp. 1–11, 2014.
- [68] Mathiesen Brian Vad, Jan Eric Thorsen, Lund Henrik, “Progression of District Heating – 1st to 4th generation,” 2018.
- [69] W. N. Riipinen M., “DHC in Helsinki - The Ultimate Heating and Cooling Solution for a Large Urban Area,” in *Proceedings of the World Energy Congress*, 2010, p. 18.
- [70] S. M. M. Rifai, “Demand-Response Management of a District Cooling Plant of a Mixed

- Use City Development,” KTH - Royal Institute of Technology, School of Industrial Engineering and Management, 2012.
- [71] IEA, *DISTRICT ENERGY SYSTEMS in CHINA Options for optimization and diversification*. 2017.
- [72] Capital Cooling, “Guidelines with impact calculator, RESCUE – Renewable Smart Cooling for Urban Europe.”
- [73] X. Z. Wolfgang Birk, Alessandro Capretti, Rodolphe de Beaufort, Roland Hellmer, Christian Johansson, Milan Jungic, Morten Karstoft Rasmussen, Viki Kaasinen, Fredrik Martinson, Stefan Montin, Matteo Pozzi, Simone Rossi, André Schache, Steen Schelle Jensen, Ralf-, “Digital roadmap for district heating & cooling.”
- [74] EMSD, “Technical Guidelines for Connection to District Cooling System,” 2015.
- [75] UN Environment, “Waste for heating and cooling: how district energy transforms losses into gains,” 2017.
- [76] EMPOWER, “EMPOWER: Conditions of service of district cooling.” [Online]. Available: <https://www.empower.ae/downloads.php>.
- [77] “Singapore District Cooling Act,” 2002. [Online]. Available: <https://sso.agc.gov.sg/Act/DCA2001>.
- [78] “Hongkong District Cooling Act,” 2015. [Online]. Available: https://www.emsd.gov.hk/en/energy_efficiency/district_cooling_system_at_kai_tak_development/legislation/index.html.
- [79] IEA, “Energy Efficiency: Cooling - The global exchange for energy efficiency policies, data and impacts.” [Online]. Available: <https://www.iea.org/topics/energyefficiency/buildings/cooling/>.
- [80] IEA, “Cooling in buildings - Tracking Clean Energy Progress,” 2019. [Online]. Available: <https://www.iea.org/tcep/buildings/cooling/>.
- [81] IEA, “Energy use from cooling.”
- [82] EIA, “HFCs: Super Greenhouse Gases.” [Online]. Available: <https://eia-global.org/campaigns/Climate/what-are-hydrofluorocarbons>.
- [83] IEA, “Share of cooling in electricity peak loads.”
- [84] JRC Science Hub, “Efficient district heating and cooling systems in the EU Case studies analysis, replicable key success factors and potential policy implications,” 2016.
- [85] SOLITES, “Urban planning example for a biomass + solar thermal supply of a DH network.”

