

Irregular light scattering properties of innovative fenestration for comfortable and energy-efficient buildings

Lars Oliver GROBE

Lucerne University of Applied Sciences and Arts
Technikumstrasse 21, 6048 Horw, Switzerland
larsoliver.grobe@hslu.ch

Abstract

The irregular reflection and transmission properties of innovative fenestration components allow to redirect, and to selectively admit or block solar irradiation based on its incident direction. Compared to e.g. systems that implement adaptivity to external conditions by mechanical transformations, such tailored light scattering properties promise to reduce the complexity of installation, operation and maintenance as well as the impact on outward view and the aesthetical appearance of buildings. Examples of such innovative fenestration techniques, e.g. light redirecting films and Venetian blinds featuring irregular reflection properties, are presented with their gonio-photometrically measured light scattering properties. Techniques to model such innovative, optically complex fenestration in building simulation software to support product development and planning are presented. The effects on daylight availability, glare and solar gains are demonstrated for exemplary cases. Preliminary results indicate the potential of such innovative fenestration technology to control and modulate rather than to block solar irradiation with minimal interventions in the design of buildings aiming at high performance in terms of comfort and energy efficiency.

Keywords: Complex fenestration, solar control, glare, daylight redirection.

Introduction

Optically complex fenestration in high performance building

The quest for solutions to utilise daylight as a natural, energy-efficient resource for lighting buildings that provide a pleasant, and comfortable, environment to their occupants (Konis & Selkowitz, 2017; Leslie, 2003; Shishegar & Boubekri, 2017), has driven the development and refinement of fenestration techniques over past decades. Better insulation, mandatory in face of energy targets, increased coverage of transparent façade areas, as well as the increasing frequency of extreme weather events lead to an increased sensitivity of buildings to solar gains, and therefore the need for solar shading (Bellia et al., 2013; Brembilla et al., 2020; Laouadi et al., 2020; Lomanowski & Wright, 2012).

An abundant variety of fenestration techniques exist (Konis & Selkowitz, 2017; Kuhn, 2017; Tsangrassoulis, 2016) that, with different prioritisation, aim to not only protect buildings from overheating and thermal discomfort, but to balance the positive and negative effects of daylight in buildings for improved visual comfort, formalised just recently in a European standard of the same name (CEN, 2018). The latter distinguishes the needs for supply and protection, and thereby reveals the ambivalent effect of solar irradiation on buildings. In particular requirements for the supply and even distribution of daylight, and a visual connection to the outside often collide with the needed protection from sunlight and glare, when solar shading devices such as Venetian blinds and roller shades are employed.

The shortcoming of either supply or protection by conventional fenestration motivated the emergence of fenestration systems that are capable to not only block or attenuate solar irradiation, but modulate its spatial distribution. In its most general meaning, the term optically Complex Fenestration System (CFS) refers to “any window product that incorporates a non-clear (non-specular) layer in the glazing assembly or in its attachments” (Laouadi & Parekh, 2007) and diffusing devices. It is, however, the directionally selective admission of incident irradiation, and its controlled deflection and distribution in the attached space, that allows for the deliberate engineering of solar transmission through the building skin (Lars Oliver Grobe, 2019a; Ruck et al., 2000). Directional selectivity and deflection are caused by the formation of geometries, often periodical, into macro-structures that are visible from a typical viewing distance, or micro-structures that are perceived as a homogenous surface property due to their small dimensions (Klammt et al., 2012).

The effects of conventional fenestration depend on geometrical variables, such as the size, position and orientation of apertures, and are commonly addressed by design guides such as the daylight factor and the window-to-wall ratio. Contrarywise the irregular optical properties of CFS introduce effects that are often counter-intuitive. Yet, these effects should be qualitatively understood by architects and engineers, and need to be quantitatively considered in building design and the selection of technologies since they effect energy efficiency and comfort, and the load on building systems. Simulation software can inform and guide such decisions, but requires reliable models and therefore the accurate characterisation of CFSs.

Manuscript accepted for publication. Licensed under a Creative Commons Attribution 4.0 International License.

Lars O. Grobe (2020). Irregular light scattering properties of innovative fenestration for comfortable and energy-efficient buildings. *Proceedings ATI 2020: Smart Buildings, Smart Cities*, Izmir, pp. 34 – 43. DOI:10.5281/zenodo.4049475

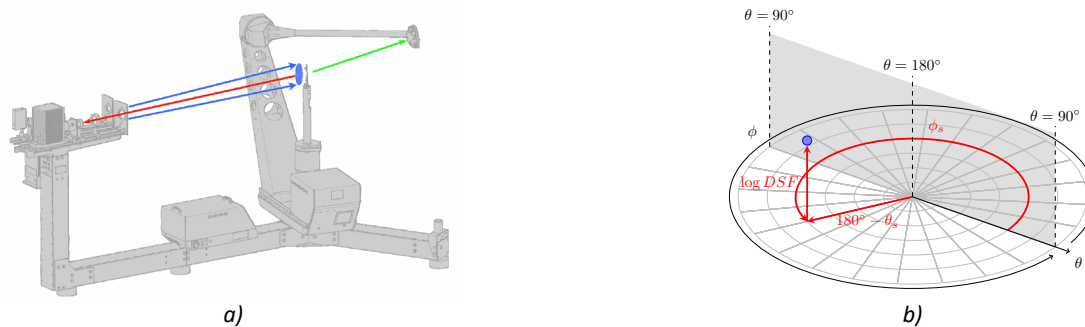

Figure 1. Scanning goniophotometer pgl at Lucerne University of Applied Sciences and Arts (a, image courtesy pab advanced technologies). Projection of data-points θ_s, ϕ_s, DSF to a polar coordinate system with logarithmically scaled z-axis for illustration of outgoing distributions.

The Bidirectional Scattering Distribution Function as a description of irregular light scattering by fenestration

At the scale of the fenestration layer, any selectivity and redirection represent cases of irregular light scattering, e.g. directional reflection to other than the mirrored incident direction, or directional transmission beyond the line of sight. Light scattering is described by the Bidirectional Scattering Distribution Function (BSDF) as a continuous function of incident and outgoing, scattered directions typically in an angular notation $\theta_i, \phi_i, \theta_s, \phi_s$ (Stover, 2012). The data-driven BSDF model in RADIANCE provides a general means to model CFS by their effect rather their complex internal composition (Lars Oliver Grobe, 2019a; Ward et al., 2014).

As an average optical property of a defined region on a specimen, the sampling aperture A , the BSDF can be computed e.g. by ray-tracing (A. Kostro et al., 2016; Molina et al., 2015), if the underlying geometric structures are known, or goniophotometrically measured by sampling at given directional resolution. This sampling is commonly implemented by two classes of instruments. Image-based, or parallel, goniophotometers capture the distribution of scattered light instantaneously. Typical designs employ reflective or refractive optics to relate scattered directions to the elements of sensor arrays. Scanning goniophotometers acquire scattered light sequentially. In such instruments, the geometric arrangement of light source, detector, and sample is varied by mechanical movement (Apian-Bennewitz, 2010).

Objectives

This research shall discuss selected CFSs, market available products as well as technologies that are under active development, with the irregular light scattering properties that define their effect on shading and glare control. The measurement and computation of these properties are discussed, and the data-driven modelling of CFS to evaluate their effect on the admission and spatial distribution of day- and sunlight in an exemplary cellular office is demonstrated. Groups of devices are distinguished – micro-structured and macro-structured CFS employing refraction and reflection to deflect light.

Methods to evaluate light scattering by fenestration

Gonio-photometric measurement

The average BSDFs of samples of selected CFSs were acquired by a scanning goniophotometer (Figure 1 a) with a distance $D \approx 1000 \text{ mm}$ between detector and sample. The incident direction (red in Figure 1 a) is set by rotation of the sample, while the movement of the detector by a robotic arm determines the outgoing, scattered direction (green). The illumination system, configured for operation under far-field conditions, limits the sampling aperture under normal illumination to a circular area of diameter $d_o \approx 70 \text{ mm}$ (blue ellipse in Figure 1 a). Since one diameter of the elliptical sampling aperture under oblique illumination increases to $d_o / \cos \theta_i$ but must not exceed the sample size, the sampling aperture under normal incidence was further decreased to $d_o \leq 25 \text{ mm}$. This configuration results in a maximum diameter of $d_{82.5} \leq 200 \text{ mm}$ well within the common A4 size of typical samples at the highest measured $\theta_{i,max} = 82.5^\circ$. To arrive at a representative description of the light scattering properties with this reduced sampling aperture, most commonly samples with typical periodical feature sizes of $\Delta p \leq 6 \text{ mm}$ were characterized, ensuring that at least 4 features were covered by the measurements. This effectively limits the goniophotometric measurement in this research to micro-structured CFSs.

Most CFSs aim to minimize effects on the transmitted spectrum within the wavelength range of visible light, e.g. to maintain natural rendition of color. A coarse spectral separation of the measurements into visible light (Vis, $\lambda \approx 380 \text{ nm}$ to 780 nm photometrically weighted) and the near infrared (Nir, $\lambda \approx 800 \text{ nm}$ to 2500 nm) was therefore considered as sufficient. For photometric measurements, an incandescent halogen lamp was employed, while a Xenon arc lamp emitted a wider spectrum for radiometric measurements in the solar spectrum. Monochromatic light can be provided by an experimental source comprising a laser diode with integrated focus lens, with a central wavelength close to the maximum of human photopic response, and allows to increase the directional resolution and minimize the sampling aperture e.g. in the case of small samples.

For few incident directions, set as sub-sets of the Klems directional basis, a dense set of randomly distributed datapoints covers the outgoing distribution at adaptive resolution. This assumes that a high resolution of scattered directions is required to cover

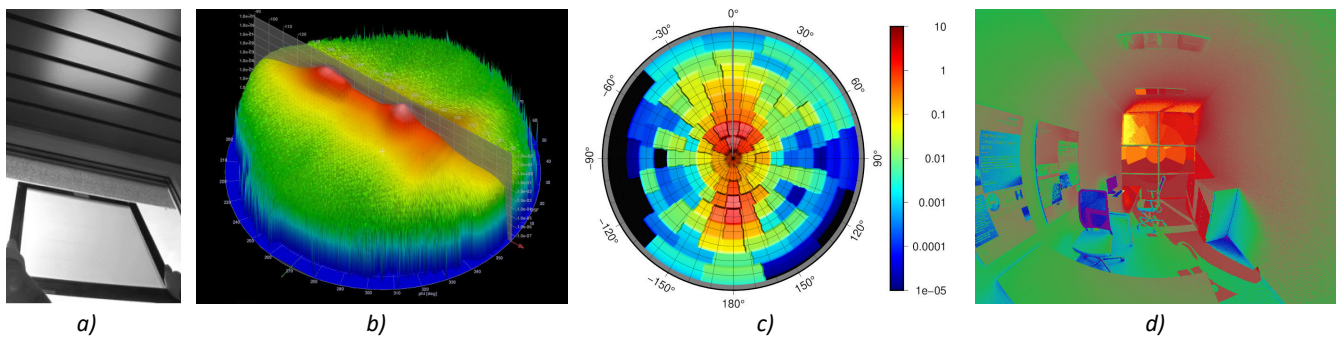

Figure 2. Light deflection by a prismatic micro-structure with diffusing layer. Light incident at an elevation angle of 40° is split into two peaks, one being in the line of sight, the other deflected upward, on a diffuse background (b). The effect is described by a discrete, data-driven model (c), that can be applied e.g. in daylight simulation with RADIANCE (d). Image a) from Grobe et al., 2017.

peaks and other pronounced features, which change only gradually with the incident direction. Integration of the distributions to e.g. solve for the illuminator power, or common integral quantities such as direct-hemispherical transmission and reflection, is implemented by Delaunay triangulation in the software mountain. The same software allows for illustration of the measured distribution by projection into a polar coordinate system (Figure 1 b), and the export of measured data-points into a tabular format (ASTM, 2019). By interpolation and subsequent data-reduction, data-driven anisotropic reflection and transmission models with an adaptive directional resolution of up to 1.4° are generated by a tool-chain distributed with RADIANCE (Ward et al., 2014).

Computation of the Bidirectional Scattering Distribution by ray-tracing

In the case of macro-structured CFS, as well as when the geometry of micro-structures is precisely known, the BSDF can be computationally solved. The reflection and transmission properties of the elements comprising the CFSs were attributed to detailed geometrical models. The RADIANCE command `genBSDF` (Molina et al., 2015) employs ray-tracing with a high number of samples, that are arbitrarily distributed over a defined sampling aperture in the center of the model. The same data-reduction as in the model-generation from measurements is applied to achieve a compact model of high, adaptive directional resolution.

Deflection by refraction

Prismatic micro-structures

Prismatic panels can be effective sun-shades for particular incident direction by total internal reflection, or by reflection from highly reflective coatings on selected surfaces (Baker & Steemers, 2014; Tsangrassoulis, 2016). The miniaturization into micro-structures, applied on window glass as an adhesive film, fosters the integration of the technique into fenestration and can significantly improve daylight supply by upward-deflection of incident light (Tsangrassoulis, 2016) as illustrated by Figure 2 (a), but does not provide the shading functionality. The combination of an upward-deflecting prismatic film with a second refractive layer limiting the horizontal distribution of transmitted light further guides light into the depth of the attached space (Müller, 2019; Tsangrassoulis, 2016). The combination of prism films with a diffusive layer spreads the upward deflected light (Figure 2 b) evenly over the ceiling (Basurto et al., 2015; Padiyath et al., 2018). Such films can improve the utilization of transmitted daylight and, compared to clear glazing, achieve equivalent or better daylight autonomy even with a reduced window-to-wall ratio. This effect allows to design well daylighted buildings with less transparent façade areas, therefore to reduce solar gains (Kazanas et al., 2016). Light deflection poses a challenge to daylight simulation.

Although RADIANCE provides models for ideal specular scatter by prismatic structures, data-driven modelling (Figure 2 c, d) lends itself to account for the convolution of specular, forward-scattered, and diffuse transmission (Lars Oliver Grobe, 2019b; Lars Oliver Grobe et al., 2017). Geometric modelling of the micro-structure is not feasible due to the geometric complexity, and problematic since even minimal error in the acquisition of geometry can lead to significant error.

Deflection by reflection

Laser Cut Panels

Laser Cut Panels (LCPs) have been proposed for a variety of applications as coplanar fenestration layers, e.g. embedded in glazing assemblies (Edmonds, 1993; Tsangrassoulis, 2016; Weibye & Matusiak, 2019), as well as external and internal window attachments. LCPs form arrays of parallel dielectric interfaces. These are produced by cutting in a thermoplastic, and deflect a fraction of incident sunlight by total internal reflection. The ratio between deflection and regular transmission depends on the interval between the cuts (z in Figure 3 a), the thickness of the panel (w), and the elevation of the sun. Thickness and interval, typically in the millimeter range, are small enough to qualify LCPs as micro-structured when seen from a distance. On the other hand, they are clearly visible in a close-up view and can be geometrically described accurately, as typical for macro-structured CFS.

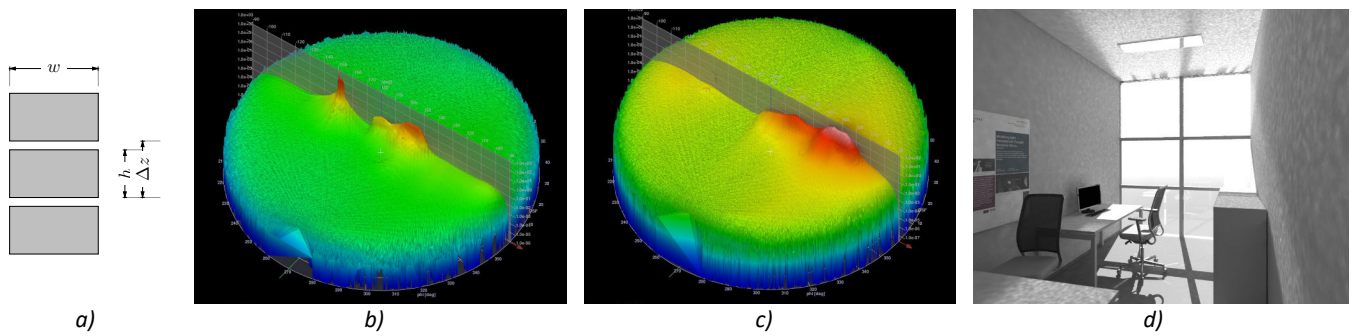

Figure 3. Main parameters defining a laser cut panel (a). Light scattering for incident elevations 30° (b) and 60° (c). Deflection of sunlight to the ceiling by a LCP in daylight simulation employing bidirectional photon-mapping in RADIANCE (d).

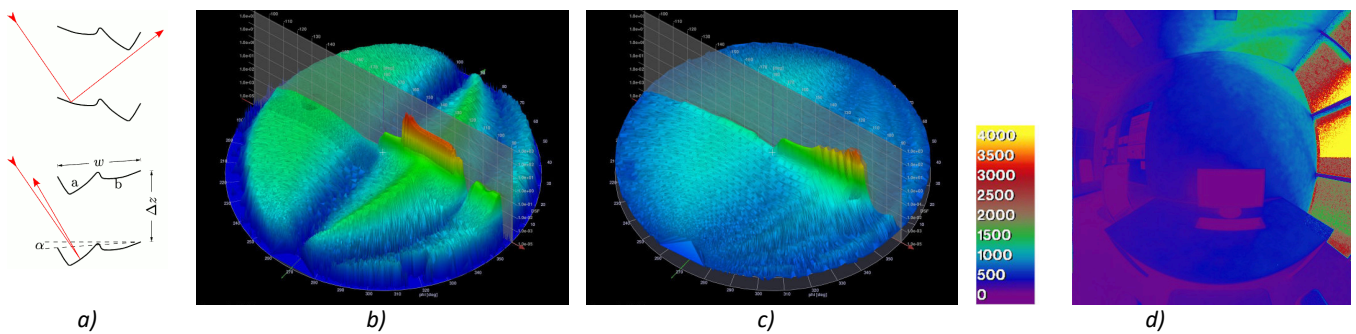

Figure 4. Main parameters defining the redirecting (top) and retro-reflecting (bottom) configurations of the RetroLuxTherm slats (a). Section a retro-reflects incident light by its inclined, mirror-like surfaces, while section b acts as a light shelf. The redirecting configurations deflects light upward along the scatter plane for an incident elevation angle of 50° (b). For the same incident direction, the retro-reflecting configuration exhibits minimal direct transmission and upward deflection. The effect is apparent on the wall and ceiling of a South oriented room (d).

Since the cuts are perpendicular to the panel, and horizontal when installed, deflected light is leaving the system toward the direction of the mirrored incident elevation angle. This may decrease the capability of the technique to extend the daylighted perimeter in particular when the sun elevation is high. The directional transmission toward to primary directions is accompanied by a diffuse background, that can be mostly attributed to scattering by imperfections of the cuts. LCPs do not act as shading devices; the reduction of transmission is minimal.

The upward deflection is particularly effective with moderate sun elevations and sunny sky conditions, as illustrated by Figure 3 d). Since the panel distorts the view to the outside and potentially causes glare when seen from above, it is typically installed only in the upper window zone above eye level. The lower window zones should be equipped with a shading system not occluding the LCP to control solar gains and glare.

In simulations, LCPs can be modelled by analytical models (Greenup et al., 2000), by computationally generated as well as measured BSDF (Basurto et al., 2015; Lars O. Grobe, 2019). Geometric modelling is possible, i.e. with bidirectional photon mapping, but leads to highly detailed models. Figure 3 c) was generated by photon mapping with a computationally generated, data-driven model of the LCP.

Profiled mirror blinds

Highly reflective Venetian blinds have been proposed as a means to deflect incident light upward rather than to block it for improved daylight supply (Kolås, 2013). To avoid negative effects, e.g. glare by upward reflection from the lower window zone or excessive solar gains, profiles have been designed that selectively block transmission according to the season, and allow the reliable exclusion of transmission from given, determined or adjustable elevation angles (Kuhn, 2006; Tsangrassoulis, 2016).

The combination of prismatic profiles with tilted segments acting as light shelves allows to control the ratio of inward-deflected and outward retro-reflected irradiation depending on the incident elevation by RETROLuxTherm 12 mm (Figure 4 a). Flipping the geometry over the vertical axis furthermore switches from predominantly shading to redirecting configurations (Figure 4 b, c), allowing to achieve different functionalities with the same profile (Köster, 2015; Tsangrassoulis, 2016). Comparing the measured and computed light scattering properties reveals the sensitivity of the latter to even slightest geometrical deviations (Noback et al., 2016). The CFS's effect on incident sunlight is illustrated by Figure 4d). A simulation study employing the computationally generated BSDF of the CFS, that covers an entire year for the exemplary case of a South oriented office in Izmir, Turkey, demonstrated the system's capability to control glare while the slats were kept in a constant, almost horizontal position, so that the occlusion of the view to the outside was minimized (Lars Oliver Grobe, 2019b).

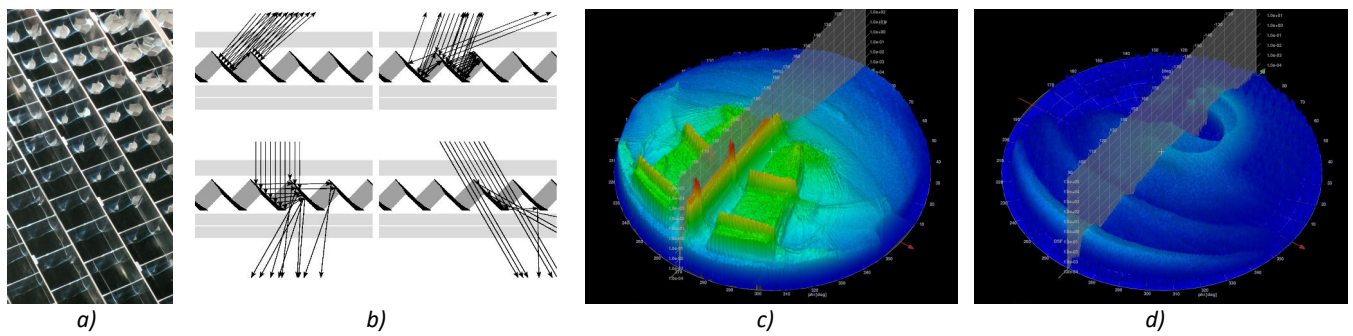

Figure 5. The inclined acceptance angle of the “micro-grid” of mirror shaft (a) either completely excludes or admits incident light (b) depending on the elevation angle. This is reflected by the measured BSDF for $\theta_i = 40^\circ$ toward the intended North ($\phi_i = 0$, c) and South ($\phi_i = 180^\circ$, d).

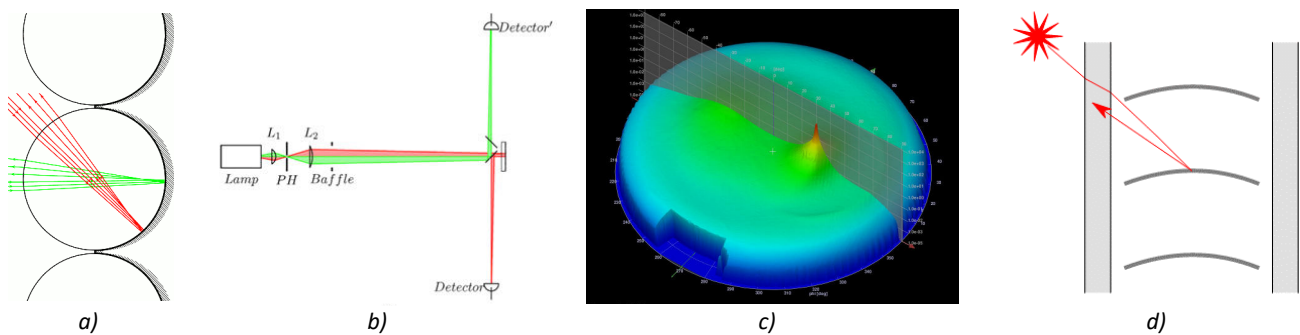

Figure 6. Retro-reflection by glass beads (a). The BRDF of the coating, characterized by an extension of the gonio-photometer (b), shows a distinct peak toward the incident direction $\theta_i = 40^\circ$ (c). Applied to Venetian blinds, this allows to block incident sunlight without occluding view (d). Illustrations b) and d) from Grobe, 2018 and Papaiz et al., 2020.

Mirror grids

Composed of highly reflective mirror-like surfaces, Compound Parabolic Concentrators (CPCs) employ the principles of non-imaging (or anidolic) optics to admit practically all incident light from a defined acceptance angle, and effectively block transmission from any other directions (Welford & Winston, 1989). Tilting such CPCs allows for the design of optimized, directionally selective daylighting devices. A CPC that is tilted so that the sky’s zenith is within the acceptance angle, with the latter configured so that all possible sun directions are excluded, provides a diffuse daylight harvesting devices. Coupling CPCs with de-concentrators allows to control the acceptance angle as well as the range of directions toward which admitted light is emitted (Scartezzini & Courret, 2002; S. Wittkopf et al., 2010). Implemented as external façade attachments, CPCs have been demonstrated as an efficient means to increase daylight availability and supplement electrical lighting (S. K. Wittkopf et al., 2006). The challenging integration of the technology in the building skin has been addressed by the miniaturization and multiplication of CPCs into an array of tilted mirror shafts forming a grid-like structure, that can be embedded in double glazing (Tsangrassoulis, 2016).

The measured BSDF of a panel comprising such a “micro-grid” produced by Siteco reflects the exclusion of a defined range of incident directions. Due to the high optical quality of the mirror coating, stray light is minimized. Sunlight is effectively blocked to control solar gains and glare. Diffuse sky-light from within the acceptance angle is admitted. From the inside, the sky is visible either directly or by reflection. The system lends itself to vertical and horizontal installation in facades or sky-lights.

Modelling the selectivity of the CFS and its effect on the distribution of transmitted light is a challenge in building simulation due to the complex optical light paths within the panel, and the resulting irregular distribution of transmitted light. A data-driven model, computationally generated from a detailed CAD model of the system, externalised this complexity from building simulation to genBSDF as a dedicated tool, and thereby allowed the assessment of daylight autonomy achieved by sky-lights in an airport terminal in Calgary, Canada (Lars Oliver Grobe et al., 2015).

Reflective micro-structures

The design principles of macro-structured CFS based on reflection have been transferred to micro-structures. Switchable micro-mirrors achieve control of solar gains and light redirection similar to mirror blinds without motors and other mechanical components, but have not reached market availability so far (Viereck et al., 2011). Window films featuring corner cubes, that are reflective only in the invisible near infrared spectrum, reduce solar gains but not daylight provision. Other than coatings that reduce transmission by regular transmission of solar energy, retro-reflection by such micro-structures reduces heat island effects that are of particular importance in densely built urban environments (Ichinose et al., 2017).

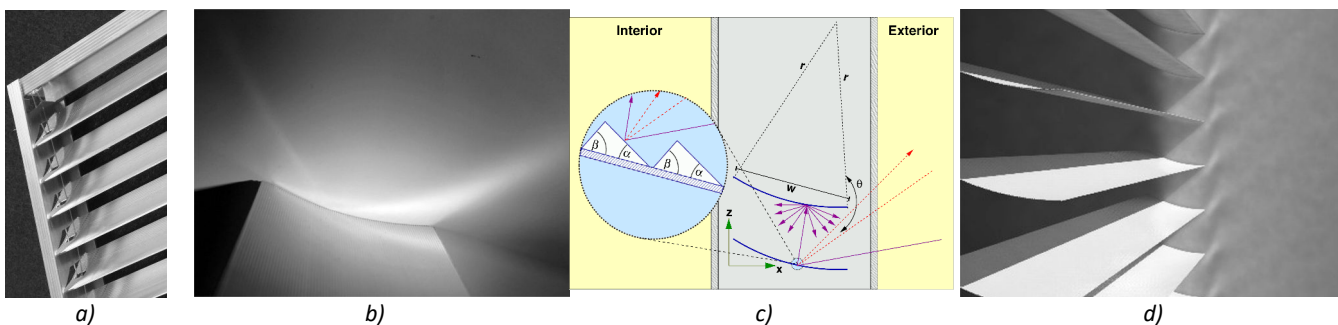

Figure 7. Venetian blinds (a) retro-reflecting light (b) due to a prismatic micro-structure applied to their surface (c). Progressive photon mapping allows to model the effect by geometric modelling (d). Illustrations b), c), and d) from Schregle et al., 2015.

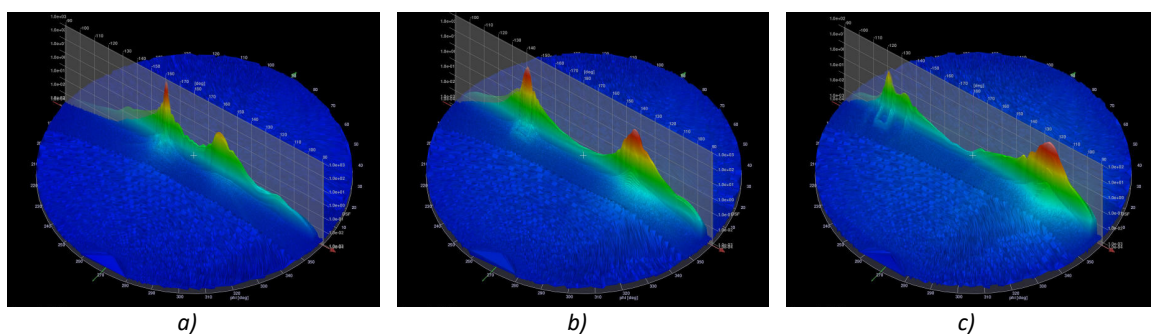

Figure 8. Film with embedded micro-mirrors. Measurements for off-normal angles $\theta_i = 20^\circ$ (a), 40° (b) and 60° (c) show the low diffuse stray-light achieved by the film. With increasing incident off-normal angle, transmission shifts from direct to upward deflected.

The directional reflection to the outside avoids solar gains by specular reflection, and reduces the blinds temperature compared to diffuse reflection. A highly reflective coating featuring glass beads (Figure 6 a) achieves retro-reflection with arbitrarily shaped blind profiles. Other than techniques employing prismatic structures, that retro-reflect light only in two dimensions toward the incident elevation angle θ_i , the glass beads retro-reflect light in three dimensions toward the source direction θ_i, ϕ_i (Papaiz et al., 2020). To guide the development of the coating process, an extension for the gonio-photometer was developed that allows to measure the Bidirectional Reflection Distribution Function (BRDF) of retro-reflective samples in the peak region (Figure 6 b). The characterisation of the coating allowed its data-driven modelling. The reflection model was subsequently applied to the geometry of Venetian blinds in the comparative evaluation of effects on glare, daylight supply and solar gains (Lars Oliver Grobe, 2018). The application of prismatic micro-structures on mirror-like surfaces achieves retro-reflection and daylight redirection, similar to the effect illustrated by Figure 4, but with simplified profiles of Venetian blinds as illustrated by Figure 7 (Schregle et al., 2015). In analogy to Fresnel optics, the segmentation of the reflectors allows to decrease the height of the profile, and thereby provides a better view to the outside while controlling solar gains and glare. The effect has been geometrically modelled with the RADIANCE photon mapping algorithm. To avoid the resulting geometric complexity of the simulation model, the irregular reflection can be replicated by data-driven modelling, e.g. based on a computationally generated BRDF model, as a uniform surface property. Arrays of parabolic micro-mirrors embedded into an adhesive film achieve light redirection (Figure 8), and can improve daylight availability by increasing the depth of the daylighted building perimeter. Compared to micro-structures employing refraction, the mirrors minimize stray-light and dispersion and maintain a view to the outside. The technology originated at EPFL (Gong et al., 2016, 2018). Further development at BASF was accompanied by frequent measurements on samples for intermediate performance assessments and improvement of the technology. Combined with a layer of secondary mirrors, it can form an angular selective light redirecting component aiming both at increased visual comfort and the seasonal modulation of solar gains without any moving parts (A. G. Kostro, 2015). Other than adhesive films employing refractive micro-structures, the micro-mirrors aim at low stray-light to provide a view to the outside and incorporate shading functionality.

Transparent insulation

Transparent insulation materials (TIMs) promise to reconcile daylight supply and low heat losses (Sun et al., 2018). They typically scatter light in an irregular manner due to periodic structures. An exemplary TIM comprises a capillary structure orthogonal to the fenestration. The tube-like elements transmit light partially by multiple reflection, similar to hollow light pipes. Figure 9 shows a close-up photograph of the capillary structure (a), and the measured distributions for three off-normal angles direction $\theta_i = 20^\circ$ (b), 40° (c), and 60° (d). The diffuse background produces the white appearance of the TIM. A distinct, specularly transmitted peak (Figure 9 b) gradually turns into a ring shape with increasing off-normal angle θ_i (Figure 9 c, d).

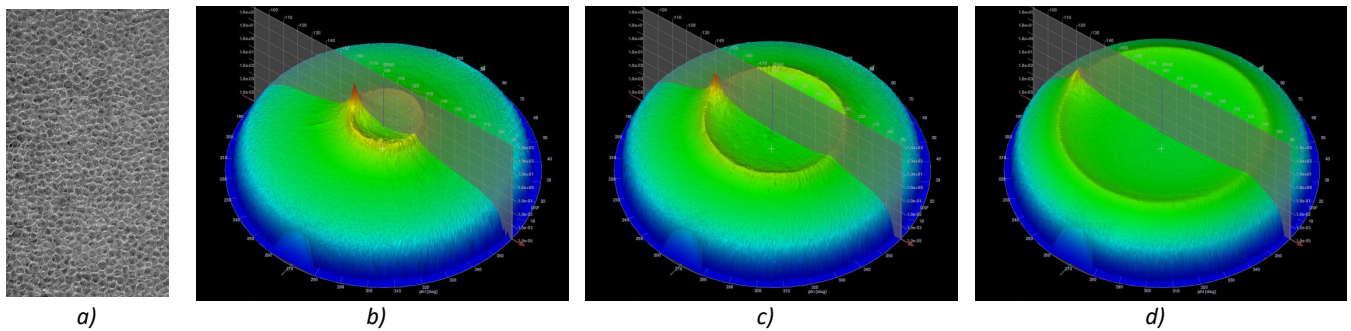

Figure 9. Capillary structure of an exemplary TIM (a). The BSDF comprises a diffuse background, combined with directional reflection that is gradually transformed from a peak to a ring-shaped feature with increasing incident elevation angles $\theta_i = 20^\circ$ (b), 40° (c), and 60° (d).

Conclusions, challenges and needs for research

Advanced daylighting devices employ irregular light scattering, e.g. the deflection, selective transmission, and retro-reflection by micro- and macro-structures to improve visual comfort and daylight supply, and to mitigate solar gains. Miniaturization efforts continue to support the integration of daylighting devices into fenestration. Besides purely functional aspects, the provision of a view to the outside as required by new standards poses challenges in the development of CFSs.

The characterization of CFSs by their BSDF allows to describe their effects on light scattering as an average property. It is an indispensable support for the development of CFSs, and required to either validate geometric models or directly generate data-driven models for daylight simulations that guide architects and planners.

Data-driven modelling is a general means to replicate in particular micro-structured CFSs in daylight simulation, and – at lower directional resolution – in building energy simulation. It hides the complex internal mechanisms from the simulation. In the case of macro-structured CFSs, such averaging is problematic since it eliminates local highlight by e.g. specular reflection. Furthermore, data-driven modelling of operated shades has to reflect all possible states of the device. Further research is required to arrive at a general means to model such systems, that may have to account for states as well as the spatial non-uniformity of the devices.

Acknowledgements

This research was financially supported by the Swiss Innovation Agency Innosuisse, and is part of the Swiss Competence Center for Energy Research SCCER FEE&D. The prismatic panel shown in Figure 2 a) was kindly provided by EPFL LESO, the LCP shown in Figure 3 by Chantal Basurto and Ian Edmonds, the Venetian blinds in Figure 4 and Figure 7 by Retrosolar, the micro-grid in Figure 5 by Siteco, and the TIM sample in Figure 9 by Okasolar. The characterization and modelling of the retro-reflective coating with EURAC was supported by Pellini. The author is grateful to all collaborators for their valuable support.

References

- Apian-Bennwitz, P. (2010). New scanning gonio-photometer for extended BRDF measurements. *Proceedings SPIE, Reflection, Scattering, and Diffraction from Surfaces II*, 7792, 779200. <https://doi.org/10.1117/12.860889>
- ASTM. (2019). *Standard practice for goniometric optical scatter measurements* (Standard ASTM 2387-19). 19. ASTM International SC E12.03.
- Baker, N., & Steemers, K. (2014). *Daylight design of buildings: A handbook for architects and engineers*. Routledge. <https://doi.org/10.4324/9781315073750>
- Basurto, C., Kämpf, J. H., & Scartezzini, J.-L. (2015). Annual performance assessment of complex fenestration systems in sunny climates using advanced computer simulations. *Journal of Daylighting*, 2(2), 32–43. <https://doi.org/10.15627/jd.2015.6>
- Bellia, L., De Falco, F., & Minichiello, F. (2013). Effects of solar shading devices on energy requirements of standalone office buildings for Italian climates. *Applied Thermal Engineering*, 54(1), 190–201. <https://doi.org/10.1016/j.applthermaleng.2013.01.039>
- Bremilla, E., Hopfe, C. J., Mardaljevic, J., Mylona, A., & Mantesi, E. (2020). Balancing daylight and overheating in low-energy design using CIBSE improved weather files. *Building Services Engineering Research and Technology*, 41(2), 210–224. <https://doi.org/10.1177/0143624419889057>
- CEN. (2018). *Daylight in buildings* (Standard EN 17037:2018). 11. European Committee for Standardization TC 169.
- Edmonds, I. R. (1993). Performance of laser cut light deflecting panels in daylighting applications. *Solar Energy Materials and Solar Cells*, 29(1), 1–26. [https://doi.org/10.1016/0927-0248\(93\)90088-K](https://doi.org/10.1016/0927-0248(93)90088-K)
- Gong, J., Kostro, A., Motamed, A., & Schüler, A. (2016). Potential advantages of a multifunctional complex fenestration system with embedded micro-mirrors in daylighting. *Solar Energy*, 139, 412–425. <https://doi.org/10.1016/j.solener.2016.10.012>
- Gong, J., Kostro, A., Scartezzini, J.-L., & Schüler, A. (2018). Feasibility study on a novel daylighting system with embedded micro compound parabolic concentrators (CPCs). *Nonimaging Optics: Efficient Design for Illumination and Solar Concentration XV*, 10758, 1075807. <https://doi.org/10.1117/12.2320478>

- Greenup, P. J., Edmonds, I. R., & Compagnon, R. (2000). Radiance algorithm to simulate laser-cut panel light-redirecting elements. *International Journal of Lighting Research and Technology*, 32(2), 49–54. <https://doi.org/10.1177/096032710003200201>
- Grobe, Lars O. (2019). Photon mapping in image-based visual comfort assessments with BSDF models of high resolution. *Journal of Building Performance Simulation*, 12(6), 745–758. <https://doi.org/10.1080/19401493.2019.1653994>
- Grobe, Lars Oliver. (2018). Characterization and data-driven modeling of a retro-reflective coating in Radiance. *Energy and Buildings*, 162, 121–133. <https://doi.org/10.1016/j.enbuild.2017.12.029>
- Grobe, Lars Oliver. (2019a). *Data-driven modelling of daylight redirecting fenestration at variable directional resolution* [Izmir Insitute of Technology]. <https://openaccess.iyte.edu.tr/handle/11147/7510>
- Grobe, Lars Oliver. (2019b). Photon-mapping in climate-based daylight modelling with high-resolution BSDFs. *Energy and Buildings*, 205, 109524. <https://doi.org/10.1016/j.enbuild.2019.109524>
- Grobe, Lars Oliver, Müllner, K., & Meyer, B. (2015). A novel data-driven BSDF model to assess the performance of a daylight redirecting ceiling panel at the Calgary Airport Expansion. *PLDC 5th Global Lighting Design Convention*, 240–243.
- Grobe, Lars Oliver, Wittkopf, S., & Kazanasmaz, Z. T. (2017). High-resolution data-driven models of Daylight Redirection Components. *Journal of Facade Design and Engineering*, 5(2), 101–113. <https://doi.org/10.7480/jfde.2017.2.1743>
- Ichinose, M., Inoue, T., & Nagahama, T. (2017). Effect of retro-reflecting transparent window on anthropogenic urban heat balance. *Energy and Buildings*, 157, 157–165. <https://doi.org/10.1016/j.enbuild.2017.01.051>
- Kazanasmaz, T., Grobe, L. O., Bauer, C., Krehel, M., & Wittkopf, S. (2016). Three approaches to optimize optical properties and size of a South-facing window for spatial Daylight Autonomy. *Building and Environment*, 102, 243–256. <https://doi.org/10.1016/j.buildenv.2016.03.018>
- Klammt, S., Neyer, A., & Müller, H. F. O. (2012). Redirection of sunlight by microstructured components – Simulation, fabrication and experimental results. *Solar Energy*, 86(5), 1660–1666. <https://doi.org/10.1016/j.solener.2012.02.034>
- Kolås, T. (2013). *Performance of daylight redirecting Venetian blinds for sidelighted spaces at high latitudes*. Norges Teknisk-Naturvitenskapelige Universitet, Fakultet for Arkitektur og Billedkunst.
- Konis, K., & Selkowitz, S. (2017). *Effective daylighting with high-performance facades: Emerging design practices*. Springer International Publishing. <https://doi.org/10.1007/978-3-319-39463-3>
- Köster, H. (2015). *Daylight modulation*. Witag-Verlag.
- Kostro, A. G. (2015). *Microstructured glazing for daylighting, glare protection, seasonal thermal control and clear view* [EPFL]. <http://dx.doi.org/10.5075/epfl-thesis-6465>
- Kostro, A., Geiger, M., Scartezzini, J.-L., & Schüler, A. (2016). CFSpro: Ray tracing for design and optimization of complex fenestration systems using mixed dimensionality approach. *Applied Optics*, 55(19), 5127–5134. <https://doi.org/10.1364/AO.55.005127>
- Kuhn, T. E. (2006). Solar control: Comparison of two new systems with the state of the art on the basis of a new general evaluation method for facades with venetian blinds or other solar control systems. *Energy and Buildings*, 38(6), 661–672. <https://doi.org/10.1016/j.enbuild.2005.10.001>
- Kuhn, T. E. (2017). State of the art of advanced solar control devices for buildings. *Solar Energy*, 154, 112–133. <https://doi.org/10.1016/j.solener.2016.12.044>
- Laouadi, A., Gaur, A., Lacasse, M. A., Bartko, M., & Armstrong, M. (2020). Development of reference summer weather years for analysis of overheating risk in buildings. *Journal of Building Performance Simulation*, 13(3), 301–319. <https://doi.org/10.1080/19401493.2020.1727954>
- Laouadi, A., & Parekh, A. (2007). Optical models of complex fenestration systems. *Lighting Research & Technology*, 39(2), 123–145. <https://doi.org/10.1177/1365782806072671>
- Leslie, R. P. (2003). Capturing the daylight dividend in buildings: Why and how? *Building and Environment*, 38(2), 381–385. [https://doi.org/10.1016/S0360-1323\(02\)00118-X](https://doi.org/10.1016/S0360-1323(02)00118-X)
- Lomanowski, B. A., & Wright, J. L. (2012). The Complex Fenestration Construction: A practical approach for modelling windows with shading devices in ESP-r. *Journal of Building Performance Simulation*, 5(3), 185–198. <https://doi.org/10.1080/19401493.2011.552735>
- Molina, G., Bustamante, W., Rao, J., Fazio, P., & Vera, S. (2015). Evaluation of Radiance’s genBSDF capability to assess solar bidirectional properties of complex fenestration systems. *Journal of Building Performance Simulation*, 8(4), 216–225. <https://doi.org/10.1080/19401493.2014.912355>
- Müller, H. F. O. (2019). Application of micro-structured sunlighting systems in different climatic zones. *Journal of Daylighting*, 6(2), 52–59. <https://doi.org/10.15627/jd.2019.7>
- Noback, A., Grobe, L. O., & Wittkopf, S. (2016). Accordance of light scattering from design and de-facto variants of a daylight redirecting component. *Buildings*, 6(3), 30. <https://doi.org/10.3390/buildings6030030>
- Padiyath, R., Hao, B., & Marttila, C. A. (2018). *Hybrid light redirecting and light diffusing constructions* (European Patent Office Patent No. EP 2 691 798 B1).
- Papaiz, L., Grobe, L. O., & De Michele, G. (2020). Retroreflective coating for window blinds: Reconciling view, solar control and visual comfort. *Proceedings Facade Tectonics 2020 World Congress*.

- Ruck, N., Aschehoug, Ø., Aydinli, S., Christoffersen, J., Courret, G., Edmonds, I., Jakobiak, R., Kischkoweit-Lopin, M., Klinger, M., Lee, E., Michel, L., Scartezzini, J.-L., & Selkowitz, S. (2000). *Daylight in Buildings—A source-book on daylighting systems and components*. IEA SHC Task 21 / ECBCS Annex 29.
- Scartezzini, J.-L., & Courret, G. (2002). Anidolic daylighting systems. *Solar Energy*, *73*(2), 123–135. [https://doi.org/10.1016/S0038-092X\(02\)00040-3](https://doi.org/10.1016/S0038-092X(02)00040-3)
- Schregle, R., Grobe, L. O., & Wittkopf, S. K. (2015). Progressive photon mapping for daylight redirecting components. *Solar Energy*, *114*, 327–336. <https://doi.org/10.1016/j.solener.2015.01.041>
- Shishegar, N., & Boubekri, M. (2017). Quantifying electrical energy savings in offices through installing daylight responsive control systems in hot climates. *Energy and Buildings*, *153*, 87–98. <https://doi.org/10.1016/j.enbuild.2017.07.078>
- Stover, J. C. (2012). *Optical scattering: Measurement and analysis* (3rd ed.). SPIE Optical Engineering Press Bellingham, WA, United States.
- Sun, Y., Wilson, R., & Wu, Y. (2018). A review of Transparent Insulation Material (TIM) for building energy saving and daylight comfort. *Applied Energy*, *226*, 713–729. <https://doi.org/10.1016/j.apenergy.2018.05.094>
- Tsangrassoulis, A. (2016). Shading and daylight systems. In S.-N. Boemi, O. Irulegi, & M. Santamouris (Eds.), *Energy Performance of Buildings: Energy Efficiency and Built Environment in Temperate Climates* (pp. 437–466). Springer International Publishing. https://doi.org/10.1007/978-3-319-20831-2_21
- Viereck, V., Jäkel, A., Neumann, U., Schwank, A., Hillmer, H., & Schmid, J. (2011). *Active windows with micro mirror arrays for improved utilization of daylight in buildings*. 757–765. <https://doi.org/10.18086/swc.2011.04.09>
- Ward, G., Kurt, M., & Bonneel, N. (2014). Reducing anisotropic BSDF measurement to common practice. In R. Klein & H. Rushmeier (Eds.), *Eurographics Workshop on Material Appearance Modeling*. The Eurographics Association. <https://doi.org/10.2312/mam.20141292>
- Weibye, A., & Matusiak, B. (2019). Towards new design of laser cut acrylic panels for windows. *Journal of Daylighting*, *6*(1), 1–10. <https://doi.org/10.15627/jd.2019.1>
- Welford, W. T., & Winston, R. (1989). *High collection nonimaging optics* (1st ed.). Academic Press.
- Wittkopf, S., Grobe, L. O., Geisler-Moroder, D., Compagnon, R., Kämpf, J., Linhart, F., & Scartezzini, J.-L. (2010). Ray tracing study for non-imaging daylight collectors. *Solar Energy*, *84*(6), 986–996. <https://doi.org/10.1016/j.solener.2010.03.008>
- Wittkopf, S. K., Yuniarti, E., & Soon, L. K. (2006). Prediction of energy savings with anidolic integrated ceiling across different daylight climates. *Energy and Buildings*, *38*(9), 1120–1129. <https://doi.org/10.1016/j.enbuild.2006.01.005>