

DESIGN AND DEVELOPMENT OF A LEAD SCREW GRIPPER FOR ROBOTIC APPLICATION

Krithikanand Krishnamoorthy

Engineering services professional & Individual researcher, India

Email: krithik44@yahoo.com

ABSTRACT

This paper gives details on the electromechanical design concept and prototype development of a lead screw linear actuated, parallel robotic gripper. Robotic applications are known to be catering to many industries from a range of tasks namely pick & place, material handling, as fixtures, tool & instrument holders etc. These application specific robots are equipped with end effectors customised with design appropriate for the application. In this paper, presented are the details for the design of an end effector also known as the gripper which works on a lead screw linear mechanism actuated by a dc motor. The gripper of stroke 100 mm is designed to hold bottles, tools or pick and place objects of rectangular section of 90mm x 90mm or of circular section of 90mm diameter and up to 3kg weight. Mechanical assembly comprises a sheet metal fixture plate holding the actuating components and a sheet metal gripper plate performing the gripping action. The motor is driven by a 24V, 2A dc motor driver. The gripping action is sensed and signalled by a force sensitive resistor. Prototype development of the gripper and on/off testing for the gripping action is investigated. The mechanical construction for this unique lead screw gripper is observed to be robust and can be used as an end effector to a suitable robotic arm.

KEYWORDS

Lead screw, dc motor driver, sheet metal fabrication, force sensitive resistor

1. INTRODUCTION

Robotic technology has become a purely interdisciplinary field with embedded electronics, computer algorithms & mathematical models and mechanical design being the major contributing domains for research. Nowadays, a lot of research work is being executed with the advent of artificial intelligence in robotics. The scope of this paper is to describe the mechanical system development of a robotic end effector called the lead screw gripper - "l.s.gripper". The design is complimented by the principles of mechatronic design. Among the broad category of grippers, the l.s.gripper comes under the type of electric actuated parallel jaw grippers [1]. A novel method of lead screw linear actuation of 100 mm stroke is implemented in the development of the gripper. The specification of the l.s.gripper is to hold and grip objects of up to weight of 3kg and 90 mm² sectional area or in the range of 5 - 90 mm diameter. This gripper is expected to be integrated to a robotic arm as a possible option of an end effector which can be used to hold and assist with tools or pick & place bottles as demanded by the application.

2. MECHANICAL DESIGN

2.1. Mechanical Function & Component Definition

The design of robotic end effectors is progressed to a high level wherein more importance being given to the shape, form and aesthetic features resembling human like hands & fingers. This involves construction of complex mechanical systems as demanded by the level of dexterity required by the end application [2]. This paper describes a simple construction of a parallel gripper which will grip and hold objects efficiently.

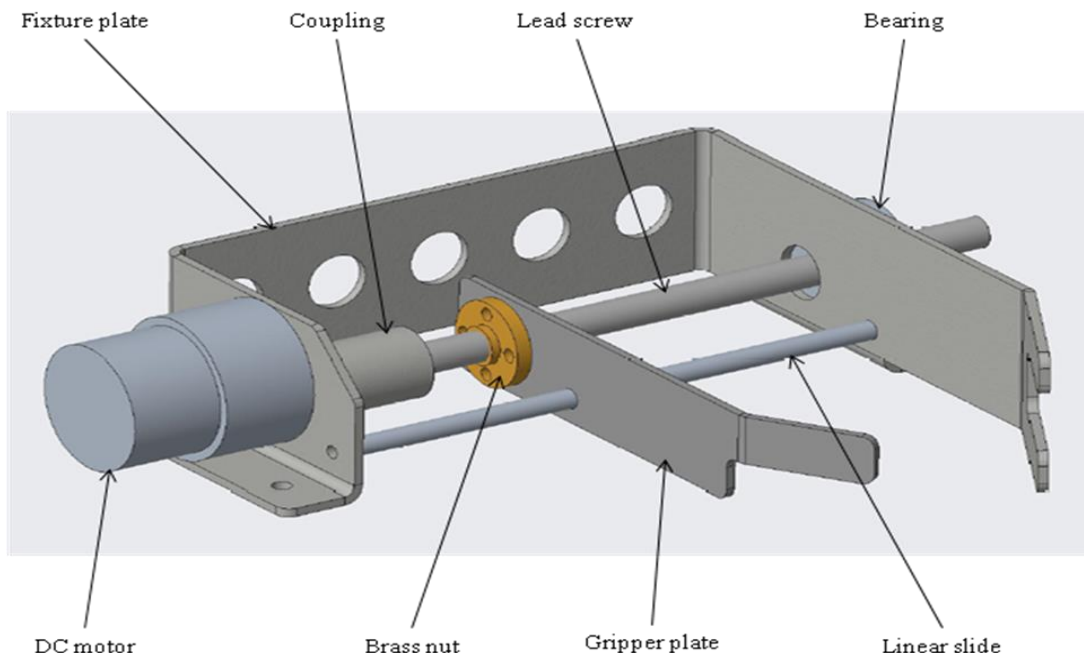

Figure 1. CAD assembly model of l.s.gripper

An overview of the mechanical design of the l.s.gripper is shown in the CAD assembly model picture as in figure 1. A popular CAD software tool is used for the CAD modelling. The gripper plate is designed hold the object against the fixture plate with force exerted by the nut moving on the lead screw. The lead screw is driven by a geared dc motor coupled with a flexible coupling. The lead screw rotates in the bearing housed in the fixture. There is a guide rod attached to the fixture along which the gripper plate moves linearly. The l.s.gripper system design starts off with the basic calculation needed to grip and effectively hold bottles of weight 3kg by the linear lead screw mechanism.

The condition for effective grip for the parallel jaw gripper during normal object pick & movement is mathematically given by

$$\text{Gripping force, } F(\text{grip}) > (m \cdot g / \mu(\text{grip})) \cdot \text{f.o.s, N}$$

m = weight of the object being gripped, kg

g = acceleration due to gravity, m/s^2

$\mu(\text{grip})$ = coefficient of friction between the object and gripping surface [11]

f.o.s = factor of safety recommended based on motion

The f.o.s is generally taken to be 2 for normal movement of the gripper and could be around 5 to 6 for accelerative movements.

Mass to be gripped & held, Ml	= 3	kg	design consideration
Gripping force, $F_g > (mg/ugrip)*f.o.s$	$(mg/ugrip)*f.o.s$	N	
Gravitational acceleration, g	= 9.81	m/s ²	
Co-efficient of gripping friction between steel and plastic, u _{grip}	= 0.5		considering plastic bottle
Factor of safety for normal operation	= 2		
Therefore, $(mg/ugrip)*f.o.s$	$= (3*9.81/0.5)*2$		
(i.e. the external force which will act on lead screw Fl)	= 58.86	N	
Length of Lead Screw, Ls	= 0.15	m	
Radius of Lead Screw, Rs	= 0.004	m	
Lead, L	= 0.002	m/rev	
Material of lead screw, Steel density, p	= 7858	kg/m ³	
Efficiency of Lead Screw, n	= 0.85		
Coefficient of linear slide friction, u	= 0.5		
Linear force applied to the mass by gripping	= 58.86	N	
Linear speed of gripper plate, Vl	= 0.02	m/s	design consideration
Time required to reach the linear speed, t	= 0.5	s	design consideration
Mass of Lead Screw, Ms	= $p.pi.Rs^2.Ls$		
	= 0.059	kg	
Inertia of Lead Screw, Js	= $Ms.Rs^2/2$		
	= 4.737E-07	kgm ²	
Reflected Inertia of Load to Lead Screw, Jl = $Ml(L/2pi)$	= 9.55E-04	kgm ²	
Total inertia, Jtotal = [Js + Jl]	= 9.56E-04	kgm ²	
Torque required to grip the object against the external & frictional force, T _{grip}	= $[Fl/2pi + L.ml.g.u/2pi]/n$		
	= 0.0243	Nm	
Input speed is given by, Nl	= Vl/L		
	= 10	rev/s	
	= 600	rpm	
	= 2pi	rad/s	
Input torque considering acceleration of the gripped object, T	= $(Nl/t)*Jtotal + Tgrip$		
	= 0.0303	Nm	

Figure 2. Theoretical calculation for gripping force & motor torque

Mathematical formulations of the gripping are made in earlier studies for the intended compliance and dexterity of the end effector [6]. However, the scope and simplicity of the parallel l.s.gripper allows us to make use of straight forward engineering calculations. Objects of various shapes are often handled by modular robotic grippers [3]. The calculation shown in figure 2. helps to select the lead screw size & motor for the torque & current specifications required for the specified weight and size that can be handled by the l.s.gripper.

2.2. Mechanical Construction - A Novel Approach

Parallel grippers are made with internal rotating gear linkages and have been commonly found to be used in the industrial factory floors. Prior studies on ball screw/lead screw actuated electric grippers have been conducted wherein the mechanism is constructed with end fingers attached to pivoted links which are connected to the sliding block and operates to grasp or un-grasp objects with the motion of the sliding block [7]. Not many lead screw actuated electric grippers with end finger directly connected to the sliding block are available in the industrial market [10]. Few research studies have been devoted to this type of gripper. Here the advantage is that the number of linkages is reduced and thereby the gripping action is performed by low cost sheet metal parts which also decrease the weight of the gripper. This improves the robustness and the design methodology is followed keeping in view of enhancing the system reliability as well [8]. The fixture plate is designed to have a feature which will easily enable it to be attached to the wrist joint of a robotic arm. Therefore, the method of lead screw based direct gripping action along

with minimal number of functional components is considered to be a unique and novel feature in this end effector development presented in this paper.

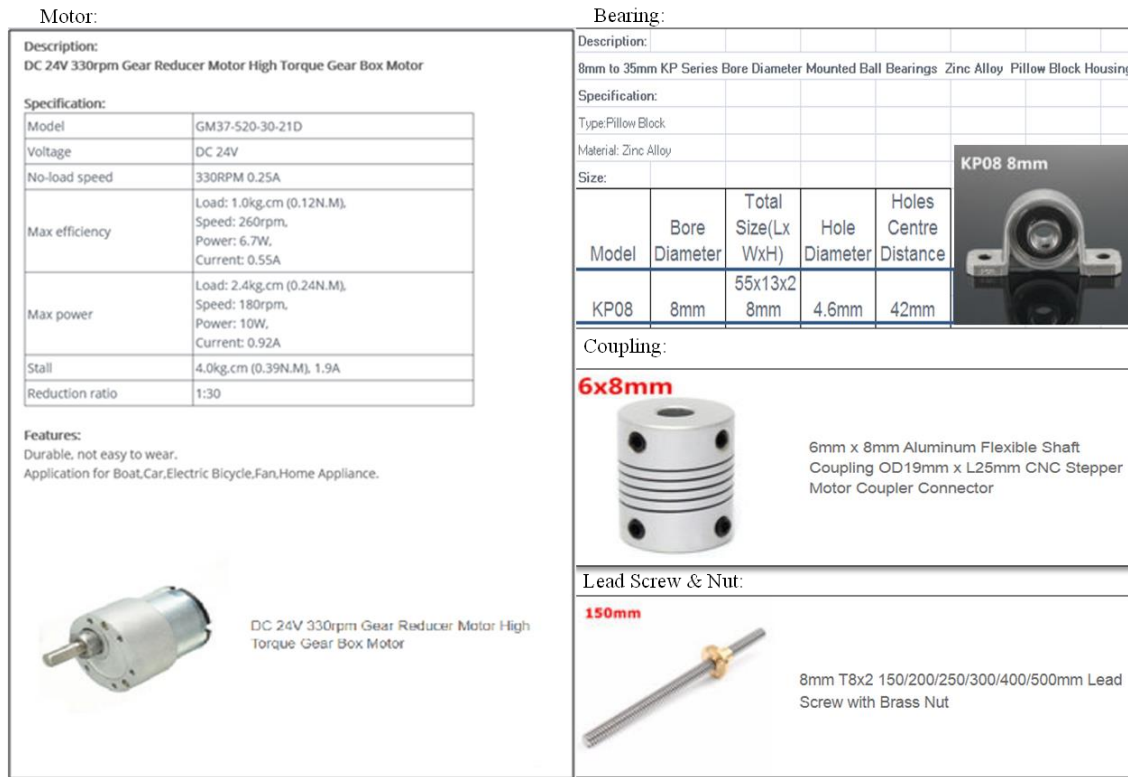

Figure 3. Component selection & specification

2.3. Component Selection

Based on the theoretical calculation, and also keeping in mind the sourcing & cost criteria, components are selected. The dc motor is of 24V, 330 rpm capable of delivering a torque of 0.12 Nm at maximum efficiency and stall torque of 0.39 Nm with 1.9 A current. This gives a factor of safety of 4 on the load torque perspective when operating at maximum efficiency. Lead screw is selected for a nominal diameter of 8mm, 2 mm lead and 150 mm length. The Brass nut offers a low friction when it turns over the stainless steel lead screw. The coupling selected is of flexible type capable of taking up small angular misalignment of shafts. It couples the motor shaft of 6 mm diameter to the 8 mm nominal diameter lead screw. The bearing selected is a pillow block housing type of 8 mm internal diameter. For the radial load of 3kg, the L10 life of the bearing is calculated to be around $3.6e^9$ revolutions. The linear guide rod is a polished steel rod of 6mm diameter. Standard cap head steel screws are used for fastening and assembly of the components.

3. MECHATRONIC SYSTEM CONCEPT

The mechatronic approach gives a blend of sensing, actuation and control to the mechanical design. The level of intelligence needed by the system is limited by the degree of sophistication required and cost of development for the intended application. Figure 4 gives an overview of the mechatronic concept for the l.s.gripper design.

Along with the objective to design & develop a robust mechanical construction for the l.s.gripper, we understand the performance of the lead screw by means of on/off signal given to the motor actuator and also observe the output of the tactile sensor during gripping. As quoted earlier the lead screw actuator is powered by the 24V dc motor. Also shown in the figure 5, is a dc motor driver is employed which is based on the integrated chip L298 and is capable of bidirectional control of dc and stepper motors.

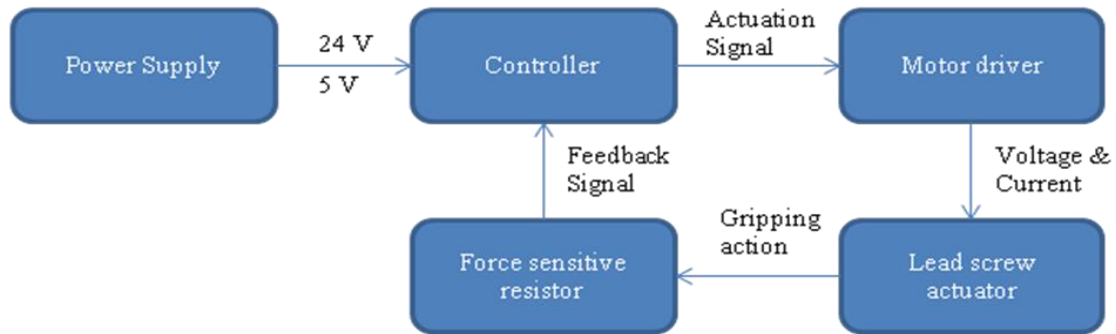

Figure 4. Mechatronic system concept for the l.s.gripper

The tactile sensor which is a force sensitive resistor, f.s.r of size 40 mm x 40 mm as shown in the figure 6, gets compressed by the object held between the gripper [5]. The resistance output of the f.s.r is converted to a voltage output via a voltage divider circuit made on the bread board. The full scale output of the f.s.r can thus be calibrated to give a 24V feedback signal indicating the gripping action. The controller part of the system is not investigated in the system prototype development. This could be an embedded controller which should take the feedback signal from the f.s.r for further processing and control.

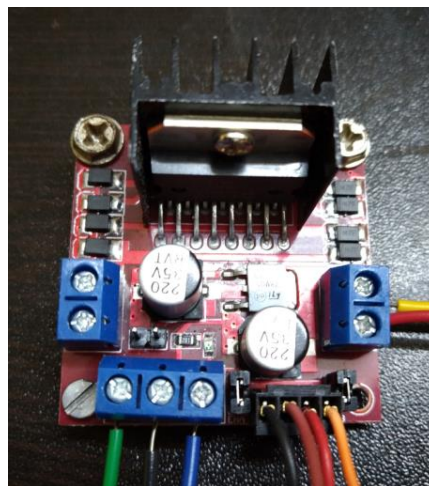

Figure 5. L298 DC motor driver board

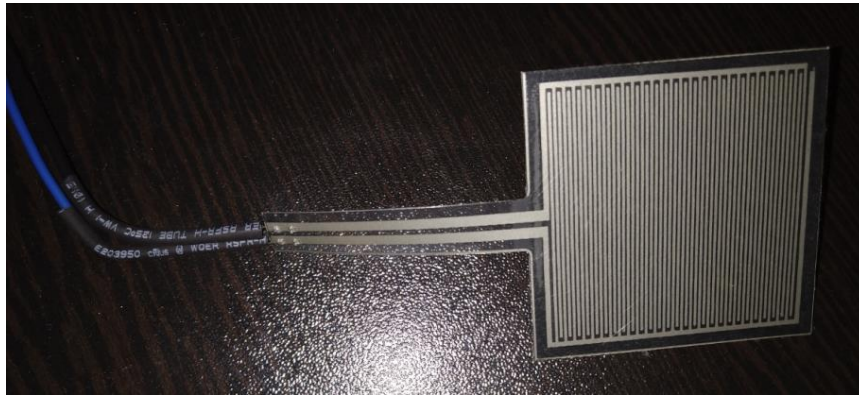

Figure 6. Force sensitive resistor, 40x40 mm area

4. SYSTEM DEVELOPMENT & TESTING

Engineering manufacturing drawings are developed for the sheet metal fabrication process through which the fixture & gripper plates are developed. Again, the manufacturing drawings are created with the help of the CAD tool. 'Design for manufacturing' principle is employed in designing these sheet metal parts wherein standard bend features, standard uniform hole sizes and addition of slots for weight reduction are considered in the design. Finger-like features are added to the parts to give them look typical to a hand shaped robotic end effector. Figure 7 and figure 8 show the manufacturing drawings created for the fixture plate and gripper plate models which were made and sourced from a sheet metal fabrication shop. The 'design for assembly' practice is adopted while designing the assembly of the l.s.gripper in CAD. The sequence of assembly is as follows. The motor with coupling is first fastened to the fixture plate. The gripper plate is fastened to the nut mounted on the lead screw with standard M2 screws. The linear guide rod is inserted into the hole provision in the gripper plate. The lead screw assembly is then coupled to the coupling along with the guide rod to be fastened to the fixture plate. The bearing being the finally assembly component is mounted to the fixture plate while locating the screw rod in the bearing. All fastenings with the fixture plate is made uniform with standard M3 screws.

Figure 9 shows the assembled l.s.gripper and the motor-driver wiring & operation is depicted in figure 10. The f.s.r is attached to the fixture plate in a sandwich manner between a foam piece and fixture plate and held by an adhesive tape. As seen in figure 10, operating the motorised system via the motor driver moves the gripper plate linearly until it touches and holds the object, a 200 ml coke bottle in this case. The foam piece provides a cushioning effect while gripping the bottle which subsequently sets on the f.s.r. The f.s.r full scale reading gives a voltage close to 24V as per its specification which is around 21.3V as observed in the voltage meter in figure 10. This is indicative that the bottle has been gripped and held tightly and at this point, the motor actuation can be stopped. Again when the bottle needs to be un-gripped the motor is rotated in the opposite direction by means of the motor driver.

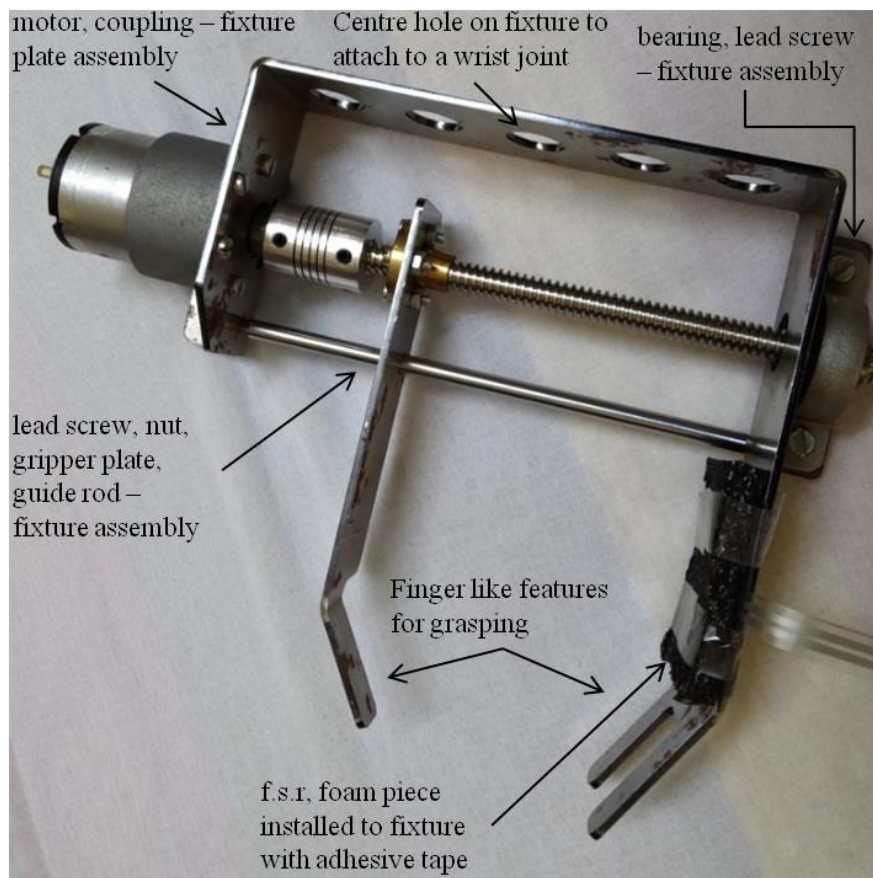

Figure 9. L.S.Gripper assembly construction

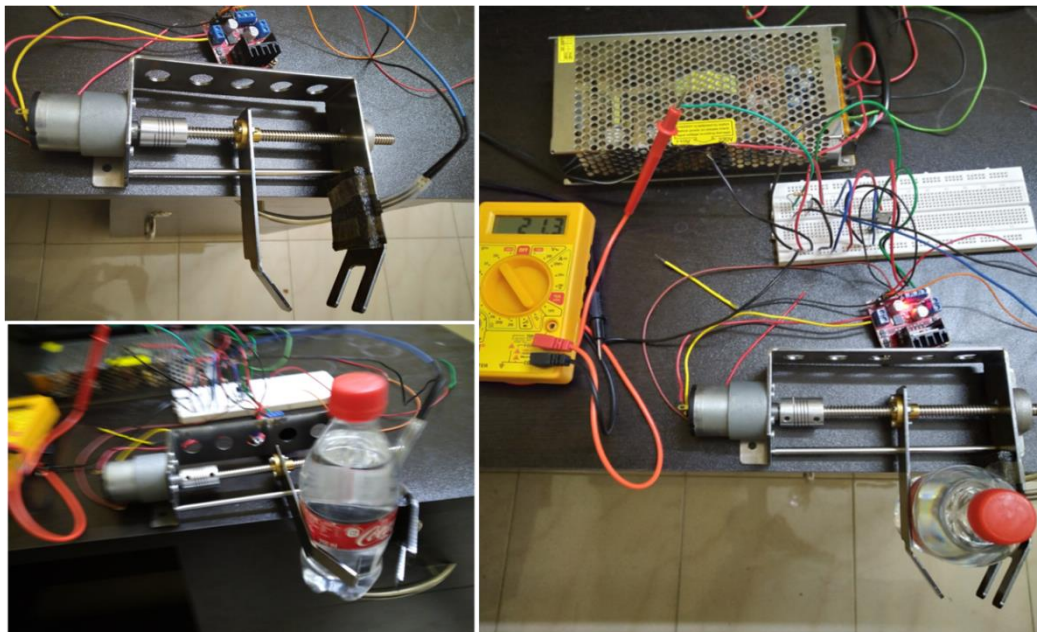

Figure 10. L.S.Gripper assembly operation

4.1. Functional Verification

To ascertain whether the l.s.gripper performs the gripping action as expected, further verification experiments are performed. The object is held between the gripper plates by slowly actuating the lead screw until a point where the object does not move when pulled out manually. This is visually indicative of the well-gripped condition which is also confirmed by the full scale 24V reading output of the f.s.r. Once the object is gripped, the motor is switched off and the l.s.gripper is disconnected from the driver board and can be made standalone with the gripped object.



Figure 11. Analog weighing scale & gripper weight measurement

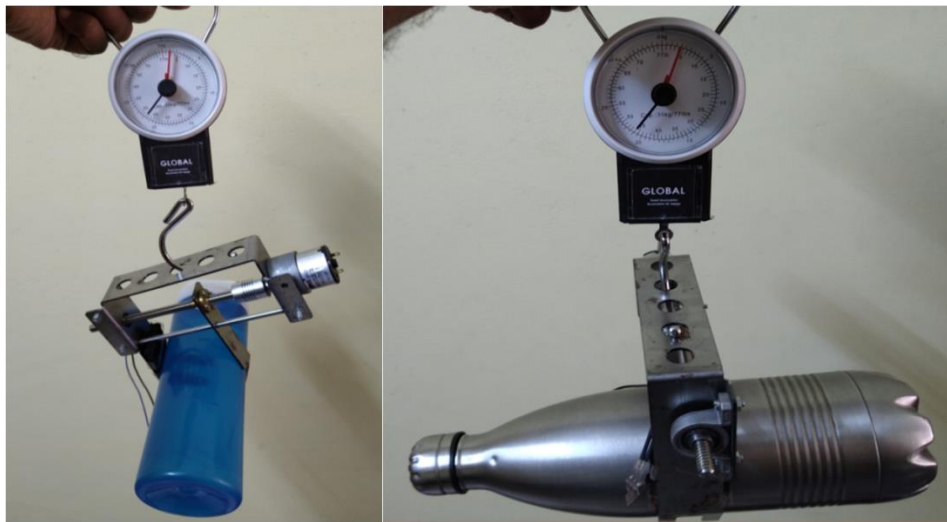

Figure 12. Weight measurement of water filled Quechua & Milton bottles

In this condition, experimental verification is taken up for evaluating the gripping performance of the l.s.gripper for gripping 2 bottles, wherein the gripper is shaken and visually inspected for slipping of the bottles. Similar verification studies have been conducted earlier which are seen to be a simple evaluation method for studying the gripping action [9]. The individual weight of the gripper is measured to be 0.25 kg. A standard analog gauge is used to measure the weight and

also the respective weights of the bottles are measured and evaluated which are shown by the red needle in figures 11 & 12.

Figure 13 shows the first case of gripping a 750 ml Quechua water bottle of diameter 81mm. Snapshots are taken while shaking the bottle held by the gripper. As was measured, the weight of this bottle is 3 times the weight of the l.s.gripper. The l.s.gripper holding the bottle is repeatedly shaken and thereby good gripping is thus observed.



Figure 13. L.S.Gripper performance verification with Quechua bottle

Figure 14 shows the second case of holding a stainless steel Milton bottle of 1 litre capacity and diameter 88mm. This steel bottle when completely filled with water is 1.25 kg which is around 5 times the weight of the gripper. Since the steel bottle is rigid as compared to the plastic one, the gripper plate showed some sliding while holding the bottle standalone. The shaking test is therefore performed holding the bottle instead of the gripper wherein the moments are observed to be lesser to cause slippage. The gripping was rather satisfactory and in this case, attaching a gripper pad to the gripper plate would result in better grip on the metal surface is understood.



Figure 14. L.S.Gripper performance verification with Milton bottle

5. CONCLUSION

The l.s.gripper working and performance gave positive results in holding bottles of 750 ml, 1 litre capacities and 81mm, 88mm diameter sizes respectively. The robustness of the mechanical design involving the fixture & gripper plates is understood. Observing the performance of the motor actuated lead screw and the force sensitive resistor gave satisfactory results on gripping action since the lead screw is known have negligible backlash. Functional verification of the l.s.gripper by manual shaking experiments by gripping the bottles gave satisfactory results on the gripping performance. Using the PLC (programmable logic controller) or an embedded controller to interpret the f.s.r feedback signal and close the control system loop will be a matter of further scope from a control engineering standpoint. The mechanical design is made keeping in view of attaching this standalone end effector to a robotic arm. This could be a standard pick & place robotic application in industry.

ACKNOWLEDGEMENTS

The author would like to thank his family & the scientific and engineering community!

REFERENCES

- [1] Jernej Preseren, Dejan Avgustin, Tadej Mravlje (2005) "Guidelines for the design of robotic gripping systems", Ljubljana.
- [2] Thomas Wurtz, Chris May, Benedikt Holz, C. Natale, G. Palli, C. Melchiorri (Aug 2010) "The twisted string actuation system, modeling & control", IEEE/ASME Transactions on Mechatronics.
- [3] Anna Maria Gil Fuster (Jun 2015) "Gripper design and development for a modular robot", Bachelor thesis, Technical University of Denmark.
- [4] Krishnaraju A, Ramkumar R, Lenin V R (2015) "Design of three fingered robot gripper mechanism", International Journal on Mechanical Engineering and Robotics. (IJMER)
- [5] Albert Aparisi I Escriva (Jun 2016) "Design of a smart gripper for industrial applications", Master of Science thesis, Tampere University of Technology
- [6] Xuance Zhou, Carmel Majidi, Oliver M. O'Reilly (2015) "Soft hands: An analysis of some gripping mechanisms in soft robot design", International Journal of Solids and Structures
- [7] Byoung-Ho Kim (2012) "Design and Analysis of Ball screw-driven Robotic gripper"
- [8] N. Bensaid Amrani, L. Saintis, D. Sarsri, M. Barreau (May 2016) "Evaluating the Predicted Reliability of Mechatronic Systems: State of the Art", Mechanical Engineering: An International journal (MEIJ), Vol. 3, No. 2
- [9] Tae-Jin Jung, Jun-Ho Oh (April 2013) "Design of a Robot Gripper for a Rapid Service Robot", 6th IFAC Symposium on Mechatronic Systems, Hangzhou, China
- [10] Elisabeth Eitel (Jan 2010) "A history of gripping and gripper technologies and the available options for today's engineer", <https://www.machinedesign.com/print/26685>
- [11] UK3H Angular Grippers-Technical Catalogue, Parker

Author

Krithikanand Krishnamoorthy is a post graduate engineer and professional, he is employed in the engineering services industry. He has been associated with R&D and mechanical product design services for 11+ years. Being an enthusiast in the field of mechatronics, he spends his leisure time working on hobby projects and concept developments. He is currently residing in Coimbatore, India.

Email: krithik44@yahoo.com

LinkedIn: <https://www.linkedin.com/in/krithikanand-krishnamoorthy-0993b014/>

