

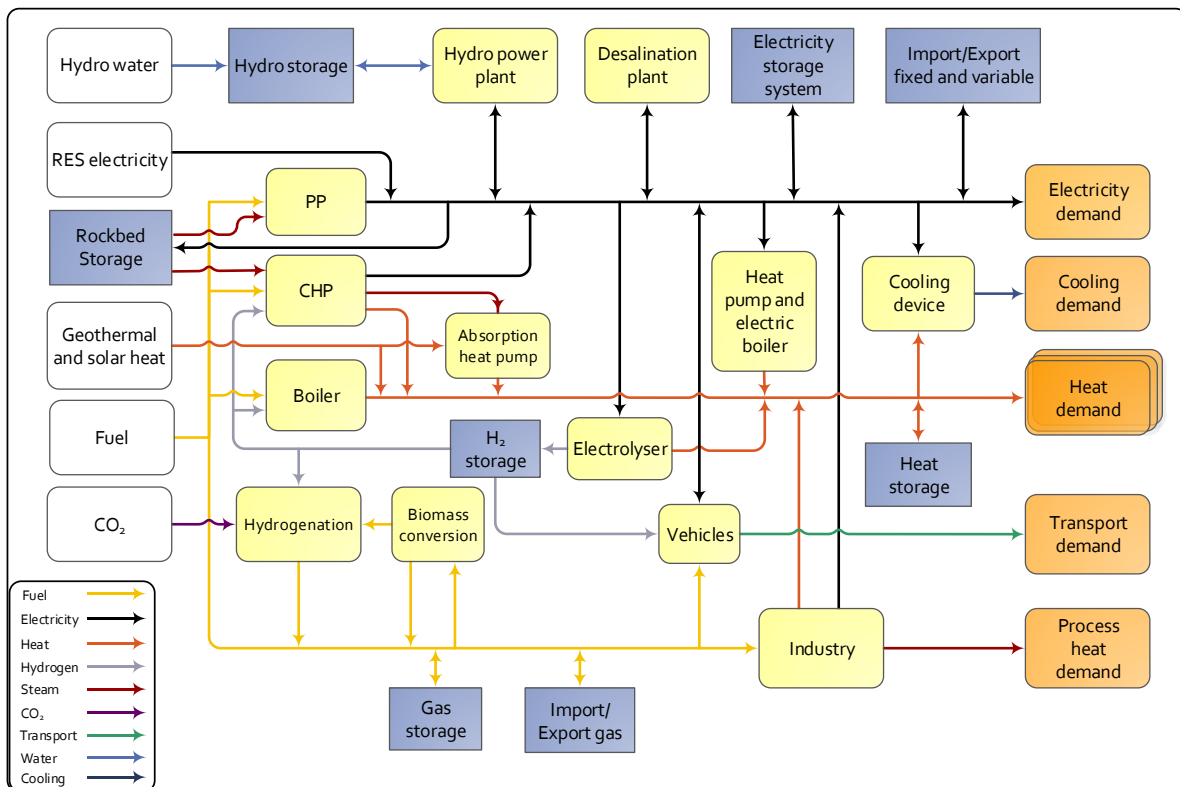

EnergyPLAN

Advanced Energy Systems Analysis Computer Model

Documentation Version 15.1



Henrik Lund and Jakob Zinck Thellufsen

September 2020

www.EnergyPLAN.eu

© Sustainable Energy Planning Research Group, Aalborg University, Denmark
Published online at www.EnergyPLAN.eu

Documentation Maintained By the EnergyPLAN Development Team

Henrik Lund

Jakob Zinck Thellufsen

Peter Sorknæs

David Connolly (until 2017)

Brian Vad Mathiesen

Poul Alberg Østergaard

Rasmus Lund (until 2018)

Iva Ridjan Skov

Kenneth Hansen (until 2018)

Dave Maya-Drysdale

Miguel Chang

Andrei David

Preface

The EnergyPLAN model has been developed and expanded into the present version 15.1 in the period since year 1999. Initially, the model was developed by Henrik Lund and implemented in an EXCEL spreadsheet. Very soon, the model grew huge, and consequently, in 2001, the primary programming of the model was transformed into visual basic (from version 3.0 to 4.4). At the same time, all the hour-by-hour distribution data were transformed into external text files. Altogether, this reduced the size of the model by a factor 30. This transformation was done in collaboration with Leif Tambjerg and Ebbe Münster (PlanEnergi consultants).

During 2002, the model was re-programmed in Delphi Pascal into version 5.0. And during 2003, the model was expanded into version 6.0. This transformation was implemented by Henrik Lund with the help and assistance of Anders N. Andersen and Henning Mæng (Energy and Environmental Data). In version 6.0, the model was expanded with a possibility of calculating the influence of CO₂ emissions and the share of renewable energy sources (RES) when the electricity supply is seen as a part of the total energy system of a region. Further possibilities of analysing different trade options on the external electricity market were added.

During the spring of 2005, the model was expanded into version 6.2 in a comparative study with the H2RES model with a focus on energy system analysis of renewable islands. The comparative study was done together with Neven Duic and Goran Krajacić from University of Zagreb. As part of the work, two new possibilities of storing/converting electricity storage facilities were added to the EnergyPLAN model. The one is an electricity storage unit, which can be used for modelling, e.g., hydro storage or battery storage. The other is electrolyzers which are able to produce fuel (e.g. hydrogen) and heat for district heating. Moreover, the facility of modelling V2Gs (Vehicle to grid) was implemented in corporation with Willet Kempton from University of Delaware.

During the autumn of 2005 and the spring of 2006, the model was expanded further into version 6.6. The main focus was to be able to model the energy systems of six European countries as part of the EU project DESIRE. Consequently, the possibility of selecting more renewable units, nuclear power and hydro power with water storage and reversible pump facilities was added to the system.

During the summer and autumn of 2006, the model was expanded further into version 7.0. New components such as different transport options and different individual heating options were added. A detailed model of Compressed Air Energy Storage (CAES) was implemented by the help of PhD student Georges Salgi. Different options of waste utilisation were added and tested by the help of PhD student Marie Münster. However, the primary achievement was to implement a new economic simulation of the total energy system on the basis of the simulation of the business-economic marginal production costs of each component in the system. An option to calculate total annual socio-economic costs was also added. The new options were tested and applied to an Energy Plan 2030 for Denmark by the help of PhD student Brian Vad Mathiesen. Diagrams of the expanded energy model were made and implemented into the user interface with the assistance of Mette Reiche Sørensen, Aalborg University, who has also assisted in the writing of this documentation.

In the beginning of 2010, version 8 included new facilities of waste-to-energy technologies in combination with geothermal and absorption heat pumps developed by the help of Poul Østergaard, new facilities of Pump-Hydro-Energy-Storage helped by David Connolly together with a number of small improvements initiated by Poul Østergaard and Brian Vad Mathiesen. Among others, it became an option to store COST data alone.

The upgrading to version 9.0 by the end of 2010 was primarily the combined result of two research projects, namely CEESA (Coherent Energy and Environmental System Analysis) partly financed by the Danish Council for Strategic Research and EnergyTown Frederikshavn partly financed by the European Regional Development Fond and Public Service Obligation funds from the Danish TSO Energinet.dk.

The major new development was the inclusion of various Biomass Conversion Technologies together with the calculation of a balance of the gas grid including import/export and storage and regulation strategies to minimise exchange. The gas grid may be natural gas with and/or without inclusion of inputs from biogas and syngas. Additional to biomass-to-gas conversion technologies, version 9.0 also included biomass-to-biofuel technologies, which are used for transport. The above-mentioned new technologies were included as a result of the input from two work packages in CEESA with a focus on transport and biomass in collaboration with Brian Vad Mathiesen and Davide Tonini.

Additional to the biomass conversion technologies, the model was expanded by new grid stabilisation measures, i.e., the inclusion of V2Gs and transmission lines as part of the stabilisation options. Such expansion was the result of input and analyses from a work package in CEESA with a special focus on the development of future electric grid structures.

Moreover, a number of improvements were made, i.e.

- further improvements of the inclusion of Pump Hydro Storage Systems in collaboration with David Connolly, Limerick University, Ireland.
- further improvements of V2G simulation options in collaboration with Nina Juul Andersen, DTU-Risø, Denmark.
- further improvements of the inclusion of micro heat pumps in the integration of wind power in collaboration with Carsten Hedegaard, DTU-Risø, Denmark.
- further improvements in the inclusion of geothermal sources in combination with steam from waste CHP plants in collaboration with Poul Østergaard (as a part of EnergyTown Frederikshavn).

In version 10, the following changes were made to the model:

- A whole new tab sheet and section of synthetic gas and fuel was added, including the hydrogenation of Biogas and Gasified biomass, as well as synthetic gas made out of carbon recycling and Hydrogen from electrolysis.
- Cooling was improved by adding natural cooling and a graphic presentation
- The transportation tab sheet was restructured to better include electrofuels

Finally, in the development of both versions 9.0 and 10.0, I acknowledge the help of David Connolly, Poul Østergaard and Brian Vad Mathiesen in providing valuable inputs and testing the improvements during the development period.

In version 11, the following changes were made:

- The most significant improvement in this version was the new appearance. This includes a new colour scheme, buttons, and graphics thanks to a huge effort by David Connolly and Iva Ridjan Skov. As part of the facelift the homepage was completely redesigned by Maja Taghdissi Jani Gierringe, Christina Jensen, Søren Kristensen Gravesen and Jeppe Dejgaard Hansen under the guidance of David Connolly and Brian Vad Mathiesen. The new website included a support forum to help you with your questions.

- Next, the model could now facilitate additional help tools. These help tools were add-on programs which aid the user when creating a model in EnergyPLAN. Three new help tools were included in version 11:
 - A “Distribution File Editor” tool in which one can load, change and save distribution files as well as show them in diagrams of hour-by-hour and duration curves. These graphs can be copied into your documentation when reporting your results.
 - A “Compare Version” tool in which one can compare the results of a model from different versions of EnergyPLAN. This help tool may assist when a new version is released to identify any changes in previous models and calculations.
 - A “Compare Input” tool in which one may compare different input data to identify any differences. This tool was created and is maintained by Poul Østergaard.
- Finally a new technology was added to the model, which is a desalination unit. This was carried out as part of the EU financed project JORIEW, with the valuable inputs of Tomislav Novosel and from the rest of the participants.

The development of help tools is part of activities within the Strategic Research Centre for 4th Generation District Heating Technologies and Systems (4DH) financed partly by the Danish Strategic Research Council.

During the spring of 2014 and with assistance from Jakob Zinck Thellufssen the model was updated to Version 11.4 with some new features relating to Carbon Capture, Nuclear, and Electric Boilers. The most significant changes related to the methodology used to estimate the cost of individual heating solutions.

- **Old Method:** In the previous version of EnergyPLAN, the cost of individual boilers was related to the peak heat demand. Based on the annual heat demand and the corresponding hourly distribution, the peak heat demand was obtained for each type of individual boiler (MW_{th}). The price of individual boilers was then inputted in relation to capacity i.e. $M€/MW_{th}$. However, this method underestimated the costs, since it did not represent the amount of surplus capacity installed for individual boilers.
- **New Method:** In the new method, the cost of individual boilers was based on the number of boilers. There was now a new input for the average heat demand per building (kWh/year). Using the total annual heat demand per boiler type, EnergyPLAN now estimated the number of different boilers by fuel (in 1000 units). The cost for individual boilers was then inputted as $M€/1000$ units of boilers.

Please note that due to this change the cost calculation of previous input-data models will NOT come to the same/right result in the new EnergyPLAN unless you correct these numbers in the Cost/Investment input TabSheet.

In version 12, a number of major updates were made to the user-interface of EnergyPLAN, including:

- A new structure was implemented. In the past, EnergyPLAN was divided by 1) technical ‘Inputs’, 2) ‘Simulation’ strategy, 3) Costs, and 4) Outputs. However, many new technologies and simulation options have been developed over the past 15 years, so a new structure was implemented to improve the flow through the tool. The new structure encouraged the users to: 1) Specify the ‘Demand’, 2) Design the ‘Supply’ to meet these demands, 3) Identify ‘Balancing & Storage’ options which would allow, 4) Input the ‘Costs’, 5) Pick a ‘Simulation’ strategy and 6) Investigate the results/‘Outputs’ from the model.
- There was also a new TreeView Navigation: In addition to the tab navigation that has always existed in EnergyPLAN, there was now also a TreeView navigation. This appears on the left side of the model. Both the TreeView and Tab navigation systems can be turned on or off. The TreeView allows you to switch between different EnergyPLAN tabsheets faster than before.

- The appearance was also updated. For example, EnergyPLAN now contained the same ‘ribbon’ layout as many Microsoft applications, along with a new dropdown menu: this is located on the top-left of the model where you can click the EnergyPLAN/AAU logo to see the new dropdown menu.
- Due to these new menus, extra buttons were added. For example, there is now a ‘New’ button to create a model from scratch, a new settings button so that the settings now appear as a pop-up, and a range of new ‘Run’ buttons. Two new buttons with new features are the ‘Notes’ and ‘Show Hints’ buttons. The notes feature allows you to add notes about your model and the ‘show hints’ checkbox allows you to get some help if you do not understand an EnergyPLAN input.
- The Investment tabsheet was expanded, so that new costs are now included. For example, the cost of road vehicles was added and the number of additional cost inputs was doubled from 10 to 20.
- There was also a new ‘Help Tool’ included with Version 12 called ‘Input Documentation’, which was developed by Rasmus Lund. This new add-on interprets EnergyPLAN scenario-files and presents all the relevant input data in a way that is easy to understand.
- A short video about these updates is available here: <https://c.deic.dk/p8ppfplsnn/>

The new interface was updated in the existing EnergyPLAN exercises and the support manuals by Jan-Henrik Wunsch and Dominik Dominkovic under the guidance of David Connolly.

Version 13 was implemented in the spring and summer of 2017 and included the following improvements:

- Flexibility of Nuclear production within certain limitations was added
- More details in the modelling of district cooling
- Pumped Hydro Power and V2G could now be activated to reduce import as well as power plants
- One could chose between whether V2G should be activated before or after Pumped Hydro
- PP, CHP and Boilers could now request electro fuel inputs
- The regulation of hydro power was improved to handle countries with very high hydro power productions leading to high shares of net export.
- CO2 hydrogenation was changed so that the electrolyzers were better integrated with the other electrolyzers in the system.

I appreciate input and testing from

- the following participants in the PhD course in April 2017: Robert Fischer, Raquel Figueiredo, Gauthier Limpens, Hrvoje Dorotic, Antun Pfeifer and Pedro Cabrera, and
- the Electro fuels and Heat Roadmap Europe teams: Brian Vad Mathiesen, Iva Ridjan Skov, Kenneth Hansen, Susana Paardekooper, David Connolly and Rasmus Lund.

Version 14 was implemented in the summer of 2018 and includes the following minor improvements and changes:

- Market economic simulation strategy has been changed slightly, so that the electric boilers first operate according to their marginal cost and the electricity market price, and then according to the CEEP regulations, if possible.
- Heat storage can now use Heat Pumps to reduce not only CEEP but also export in general.
- Excess heat can be stored in the solar heat storage (you have to activate a button)
- Excess heat can also be stored in the other heat storage (but only if it helps reduce PP/Import and CEEP/EEEE)
- The print now also includes RES4-RES7 and sort all after type

- Option to specify year start and end values of the hydro power water storage has been added so that one can model yearly variations in the water dam storage of big systems such as in Norway.
- A small correction in RES prices in economic simulation when there is no bottleneck
- Fixed so CHP and HP do not overproduce and create an imbalance in the heat production under market operation.
- An option of Zero price strategy added for operation of RES in market operation:

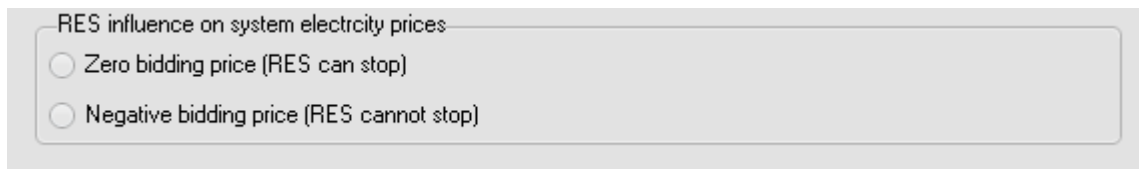

Zero bidding price is the new operation where negative bidding price is the old interpretation of VRES in market operation.

Moreover, in version 14 the Electrofuels tab sheet has been changed so that hydrogenation can be used for both direct production of liquid electrofuels and green gas. Note: This means that minor adjustments in the input in this tab sheet might be needed if wanting to use input-files from the previous versions of EnergyPLAN.

In Version 14, the following new technologies have been added:

- Concentrated Solar Power (CSP) with a storage: It works in technical simulation to reduce PP/import and KEOL/EEOL, i.e. to level out differences between electricity demands and RES productions. In economical simulations it optimizes the profit of the CSP production.
- Rockbed (High Temperature Thermal storage): It consumes electricity to produce steam for PP and CHP3 and thereby reduces fuel demands. It operates to reduce CEEP and EEEP
- Hydrogen for Industry

Finally, in the development of version 14.0, we acknowledge the help of Peter Sorknæs and Iva Ridjan Skov in providing valuable input and testing the improvements during the development period as well as the support from the following research projects: “Strategic Research Centre for 4th Generation District Heating Technologies and Systems (4DH)”, “RE-Invest - Renewable Energy Investment Strategies - A two-dimensional interconnectivity approach”, “I-REMB – Innovative re-making of markets and business models for a renewable energy system based upon wind power” and “CITIES – Centre for IT-Intelligent Energy Systems in Cities” partly financed by Innovation fund Denmark or the Elforsk program.

Version 15 was made during the spring of 2019 and includes the following changes mainly based on requests and requirements of the RE-Invest, CITIES and I-REMB projects (see above), alongside the project Coordinated Operation of Integrated Energy Systems (CORE) financed by EUDP:

Two additional options in the regulation have been added:

The first is an option to operate the thermal storage for district heating as a seasonal storage instead of a weekly storage. Depending on the size of the storage, the user can choose between the two options.

The next is a new option to make the model iterate its way to a solution of utilizing the electrolyzers and hydrogenation units better in the electricity balancing. In the previous versions, one could activate

CEEP strategy no. 8 to produce green gas out of available critical excess electricity production due to available capacities in the electrolyzers and the hydrogenation units. However, such extra production would maybe lead to too much green gas in the balancing of the gas sector. This option is still available. However, the model can now be asked to find a solution in which CEEP is lowered without increased the resulting green gas production. Such solution is found by iteration and takes additional computation time, but still typically less than a minute.

Further, in version 15 two additional technologies/components have been added:

The first is an extra electricity storage unit, so that one can include two. The second is production and demand of ammonia, e.g. for fueling ships or similar transportation.

Finally, changes have been made in the market economic simulation. Previously, the setting of prices on the external electricity market did not take into account the influence of the bottlenecks when determining the prices. This has been changed in version 15, where it is possible to choose whether bottlenecks should be taken into account.

Version 15.1 was made during the spring of 2020 and includes the following changes mainly based on requests and requirements of the RE-Invest and CORE projects (see above), alongside the Sustainable Energy Transitions Laboratory (SENTINEL) project, funded by the European Union's Horizon 2020 research and innovation programme under grant agreement No 837089.

- New feature to express an external request for the system to produce a certain import/export. In this way, the EnergyPLAN model can quantify the system's ability to provide balancing for an external system. The purpose is to make it possible for one country/system to assist in the balancing of another country/system, e.g. to use the flexibility of Norwegian hydropower to balance a Swedish, Danish or European system.
- Expansion of the use of "Electricity storage" to include also PP2.
- Expansion of the option to specify electricity storage market operation strategies in terms of adding a potential profit margin and choosing the number of hours for the prognosis. These new options turned out to be relevant for very large electricity storage facilities.
- Rockbed storage now uses percent loss per hour instead of share loss per hour to facilitate very small loss rates.
- The scenario and distribution files included when downloading the tool have been updated to reflect the latest research. The previous files are still available by downloading one of the previous versions.

Moreover, a few bugs have been detected and corrected related to V2G grid stabilisation, solar thermal storage and desalination. Updates to the GUI have also been made to make sure units update correctly and that TAB switches between spaces in the right order.

Henrik Lund and Jakob Zinck Thellufsen, Aalborg University, September 2020

Contents

Preface.....	3
Contents	9
Nomenclature.....	12
1. Introduction.....	15
1.1. Purpose and application.....	15
1.2. Smart Energy Systems (www.SmartEnergySystem.eu).....	16
1.3. Energy Systems Analysis in the EnergyPLAN model.....	19
1.4. Energy Demands.....	22
1.5. Overview: Components and Simulation.....	23
2. Navigation	31
2.1. Main Menu	31
2.2. Home	32
2.3. Add-On Tools.....	38
2.4. Help	39
3. Libraries and settings	40
3.1. Input data set	40
3.2. Distribution.....	43
3.3. Cost database	47
3.4. Settings.....	49
4. Energy System Definition (Inputs).....	50
4.1. Demand	50
4.2. Supply	63
4.3. Balancing and Storage	89
4.4. Cost.....	95
4.5. Simulation.....	101
5. Initial analyses without electricity balancing	103
5.1. Fixed import/export of electricity	103
5.2. District heating demands incl. heat demands from absorption cooling.....	103
5.3. District heating and electricity productions from Industry and Waste.....	103
5.4. Fixed Boiler production subtracted from the district heating demand	104
5.5. Boiler production in district heating group 1	104
6. Technical Energy System Analysis	105
6.1. Condensing power and import/export including CEEP and EEEP	105
6.2. CHP, heat pumps and boilers in groups 2 and 3 (simulation 1 or 4).....	106

6.3.	Flexible electricity demand (including dump charge BEV)	107
6.4.	CHP, heat pumps and boilers in groups 2 and 3 (simulation 2 or 3).....	110
6.5.	Hydro power.....	112
6.6.	Individual CHP and heat pump systems	117
6.7.	Electrolyser for micro CHP, Transport, Hydrogenation and DH groups.....	121
6.8.	Heat storage in groups 3 and 2	125
6.9.	Transport (Smart charge and V2G).....	128
6.10.	Electricity storage	134
6.11.	Desalination.....	135
7.	Market-Economic Simulation	138
7.1.	Net import and resulting external market price	138
7.2.	The overall procedure	139
7.3.	CHP3 minimum production.....	142
7.4.	District heating supplied by solar thermal and boilers	143
7.5.	Hydrogen and electricity demands for transport and micro CHP	143
7.6.	Electricity consumption of heat pumps and DH electrolysers	148
7.7.	Hydro Power.....	151
7.8.	Electricity production from CHP and power plants.....	153
7.9.	Electricity storage (hydro or battery or CAES storage)	157
7.10.	Resulting electricity market prices (External, Domestic and bottlenecks).....	160
7.11.	Grid stability	160
8.	Fuel, CO ₂ emissions and Feasibility Study (calculations).....	161
8.1.	Fixed boiler production is added to the boilers in groups 2 and 3.....	161
8.2.	Reducing Critical Excess Electricity Production.....	161
8.3.	Grid stabilisation.....	165
8.4.	Heat balances in district heating systems	165
8.5.	Fuel consumptions	165
8.6.	CO ₂ emissions	166
8.7.	Balancing of Gas Grid	166
8.8.	Share of Renewable Energy.....	169
8.9.	Cost.....	169
9.	Output	171
9.1.	The screen function.....	171
9.2.	The print	173
9.3.	Graphics.....	175
9.4.	Run serial calculations function.....	176

9.5.	Export Screen Data to Clipboard and e.g. Excel	176
10.	Business-economic optimisation of CAES plants	177
10.1.	Theoretically optimal strategy.....	178
10.2.	Practical operation strategies.....	182
11.	List of Error Messages	184
12.	List of Warning Messages.....	187

Nomenclature

Variables are used for demands, productions, and efficiencies and similarly for various components, such as electricity demands, boiler productions, etc. The demand and production unit specifications are given as indexes to the demands and productions.

Annual demands and productions are written in capital letters such as Q and E. The hourly value is written in small letters such as q and e, using the same alphabetic letters for the same demands. E.g., the capital letter D is used for annual electricity demands and the small letter d is used for hourly values of electricity demands. Such notation is short for the relation that the sum of 8784 hours of d's during a year adds up to the value of capital D:

$$D_E = \sum_{x=1}^{8784} d_E(x)$$

Examples: D_E, d_{FXDAY}, h_{DH2},			
Annual Demands		Hourly demands	
D	Annual electricity Demand	d	hourly electricity demand
H	Annual Heat demand	h	hourly heat demand
F	Annual Fuel demand/consumpt.	f	hourly fuel demand
C	Annual Cooling demand	c	hourly cooling demand
Index			
E	Electricity demand	M-Coal	Individual Coal boilers
EH	Electricity heating demand	M-Oil	Individual Oil boilers
EC	Electricity cooling demand	M-Ngas	Individual Natural gas boilers
EX	Fixed Exchange electricity demand	M-Bio	Individual Biomass boilers
FXDay	Flexible demand (1 day)	M-H2CHP	Micro Hydrogen CHP
FXWeek	Flexible demand (1 week)	M-NgasCHP	Micro Natural gas CHP
FX4Week	Flexible demand (4 weeks)	M-BioCHP	Micro Biomass CHP
DH1	District Heating group 1	M-HP	Individual Heat Pump
DH2	District Heating group 2	M-EH	Individual Electric heating
DH3	District Heating group 3	T	Transport
Cool	Cooling (electric grid)	BEV	Battery Electric Vehicle
Cool1	Cooling in DH1	V2G	Vehicle to Grid
Cool2	Cooling in DH2	W1	Waste in DH1
Cool3	Cooling in DH3	W2	Waste in DH2
I	Industry	W3	Waste in DH3
V	Various		
CSHP	Industrial Combined Heat & Power		

Examples: C_{CHP2} , e_{HP2} , Q_{B2} , μ_{CHP2} , α_{ELC2} ,			
Annual Productions		Hourly productions	
E	Annual electricity production	e	hourly electricity production
Q	Annual Heat production	q	hourly heat production
F	Annual Fuel demand/consumption	f	hourly fuel demand or produc.
W	Annual Water supply to Hydro	w	hourly water supply
		s	hourly energy content in storage
Capacities		Efficiencies	
C	Capacity (Electric)	μ	electric (=electric/fuel)
T	Capacity (Thermal)	ρ	thermal (=heat/fuel)
S	Capacity storage (Energy)	ϕ	COP (=heat/elec) for HPs
LOSS	Loss from storage	α	fuel (=fuel/elec) for electrolyser
SHARE	Share of e.g. DH with Solar	ψ	waste/biomass to fluid biofuels
FAC	Correction Factor (e.g. RES prod.)	η	waste/biomass to solid biofuels
LIMIT	Capacity limit of micro CHP etc.	τ	w./biom. to non energy prodct.
Stab	Grid stabilisation share	κ	gas to gas grid quality
		λ	steam (steam/fuel)
		γ	Cold gas (gas/biomass)
Index		Various factors	
B1	Boiler in DH group 1	Hydro	Hydro power
B2	Boiler in DH group 2	HydroPump	Reversible Hydro power
B3	Boiler in DH group 3	Nuclear	Nuclear
CHP2	Combined Heat Power in DH gr. 2	Geo	Geothermal
CHP3	Combined Heat Power in DH gr. 3	Elc2	Electrolyser in DH group 2
HP2	Heat Pump in DH group 1	Elc3	Electrolyser in DH group 3
HP3	Heat Pump in DH group 2	ElcT	Electrolyser for transport
PP	Power plant (Condensing)	ElcM	Electrolyser for micro CHP
Solar1	Solar thermal in DH group 1	Pump	Electricity storage charging unit
Solar2	Solar thermal in DH group 2	Turbine	Electricity stor. discharge unit
Solar3	Solar thermal in DH group 3	CAES	Compressed Air Energy Storage
Res1	Renewable Energy Source 1	Bio	Biogas plant
Res2	Renewable Energy Source 2	GASI	Gasification plant
Res3	Renewable Energy Source 3	BioDiesel	Bio Diesel plant
Res4	Renewable Energy Source 4	BioPetrol	Bio Petrol plant

Examples: $P_{\text{Coal-WM}}$, $P_{\text{Coal-TaxI}}$, $\text{CO}_2_{\text{Coal}}$,			
Annual Demands and prices		Hourly demands	
P	Average Annual price	p	hourly prices
A	Annual Cost	n	lifetime
CO₂	CO ₂ emissions	i	interest rate
Index			
WM	World Market	TaxIndv	Fuel Taxes for individuals
HCen	Handling Costs to central level	TaxI	Fuel Taxes for industry
HDec	Handling Costs to decentralised	TaxB	Fuel Taxes for Boilers
HIndv	Handling Costs to individual	TaxCHP	Fuel Taxes for CHP
HRoad	Handling Costs to road transport	TaxCAES	Fuel Taxes for CAES
HAir	Handling Costs to air transport	VOC	Variable Operational Costs
Unit	Per unit prices	FOC	Fixed Operational Cost

1. Introduction

The EnergyPLAN model is a computer model for Energy Systems Analysis. The model has been developed and expanded on a continuous basis since 1999. The analysis is carried out in hourly steps for one year. And the consequences are analysed on the basis of different technical simulation strategies as well as market-economic simulation strategies.

1.1. Purpose and application

The main purpose of the model is to assist the design of national energy planning strategies on the basis of technical and economic analyses of the consequences of different national energy systems and investments. However, the model has also been applied to the European level as well as to a local level such as towns and/or municipalities. From the first version, the model has emphasised the analysis of different operation strategies with a focus on the interaction between combined heat and power production (CHP) and fluctuating renewable energy sources. Moreover, the model emphasises the synergies of including the whole energy system and, through the various versions, the model has been expanded to include a wide range of technologies with a focus on analysing the cross-sectoral interaction between the electricity, gas, district heating and cooling grids.

The model is an input/output model. General inputs are demands, renewable energy sources, energy plant capacities, costs and a number of optional different simulation strategies emphasising import/export and excess electricity production. Outputs are energy balances and resulting annual productions, fuel consumption, import/exports and total costs including income from the exchange of electricity.

The model can be used for different kinds of energy system analyses:

Technical analysis

Design and analysis of large and complex energy systems at the national level and under different technical simulation strategies. In this analysis, input is a description of energy demands, production capacities and efficiencies, and energy sources. Output consists of annual energy balances, fuel consumptions and CO₂ emissions.

Market exchange analysis

Further analysis of trade and exchange on international electricity markets. In this case, the model needs further input in order to identify the prices on the market and to determine the response of the market prices to changes in import and export. Input is also needed in order to determine marginal production costs of the individual electricity production units. The modelling is based on the fundamental assumption that each plant optimises according to business-economic profits, including any taxes and CO₂ emissions costs.

The Market economic simulation strategy is based on a short-term marginal price market model similar to the NordPOOL market design, so it focuses solely on bids to the electricity market while minimizing short-term electricity consumer costs and minimizing short-term district heating costs. As a result, this simulation strategy only uses variable costs and does not optimise based on the long-term costs of different energy supply technologies. Furthermore, it only optimises the supply side of the energy system, and not the demand side (although the user can manually change the demand and analyse the resulting impact of a market economic simulation). While mathematically it is possible using the price elasticity feature in EnergyPLAN to simulate 100% renewable energy scenarios using this current

market design, represented by the market economic simulation, this may not accurately represent how future energy supply and demand markets should be designed. Today's markets are primarily designed for dispatchable plants, whereas 100% renewable energy systems will most likely depend on very high levels of non-dispatchable renewable energy. Therefore, using the technical simulation strategy is typically more accurate at simulating energy systems with very large penetrations of intermittent renewable energy, which in combination with the cost data for the technologies, makes it possible for the user to identify least cost solutions over their total lifetime.

Feasibility Studies

Calculation of feasibility in terms of total annual costs of the system under different designs and simulation strategies. In such case, inputs such as investment costs and fixed operational and maintenance costs have to be added together with lifetime periods and an interest rate. The model determines the socio-economic consequences of the productions. The costs are divided into 1) fuel costs, 2) variable operational costs, 3) investment costs, 4) fixed operational costs, 5) electricity exchange costs and benefits, and 5) possible CO₂ payments.

1.2. Smart Energy Systems (www.SmartEnergySystem.eu)

The principle of the energy system of the EnergyPLAN model is shown in the diagram on the front page. Basically, the input of the energy system consists of the following:

- Energy demands (heat, electricity, transport, etc.)
- Energy production units and resources (wind turbines, power plants, oil boilers, storage, etc.) including energy conversion units such as electrolysers, biogas and gasification plants as well as hydrogenation units.
- Simulation (defining the simulation and operation of each plant and the system including technical limitations such as transmission capacity, etc.)
- Costs (Fuel costs, taxes, variable and fixed operational costs and investment costs)

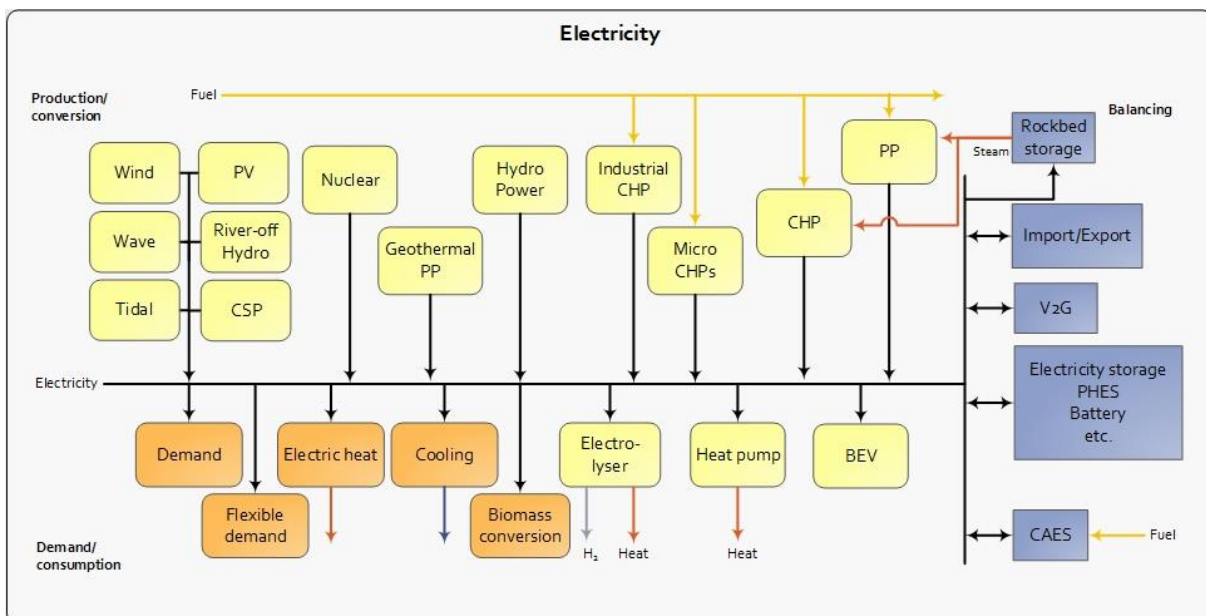

Illustration of components involved when the EnergyPLAN model calculates hourly balancing of the ELECTRICITY system including interactions with other parts of the whole system

The design of EnergyPLAN emphasises the option of looking at the complete energy system as a whole. E.g., the challenge of integrating fluctuating power from renewable energy sources into the electricity grid by the use of smart grids should not be looked upon as an isolated issue, but should be seen as one out of various means and challenges of approaching sustainable energy systems in general. Therefore, EnergyPLAN is designed to be a tool in which, e.g., electricity smart grids can be coordinated with the utilisation of renewable energy for other purposes than electricity production. In the tool, renewable energy is converted into other forms of carriers than electricity, including heat, hydrogen, synthetic gases and biofuels, as well as energy conservation and efficiency improvements, such as CHP and improved efficiencies, e.g., in the form of fuel cells. All such measures have the potential for replacing fossil fuels or improving the fuel efficiency of the system. The long-term relevant systems are those in which such measures are combined with energy conservation and system efficiency improvements. Consequently, the EnergyPLAN tool can be used for analyses which illustrate, e.g., why electricity smart grids should be seen as part of overall smart energy systems.

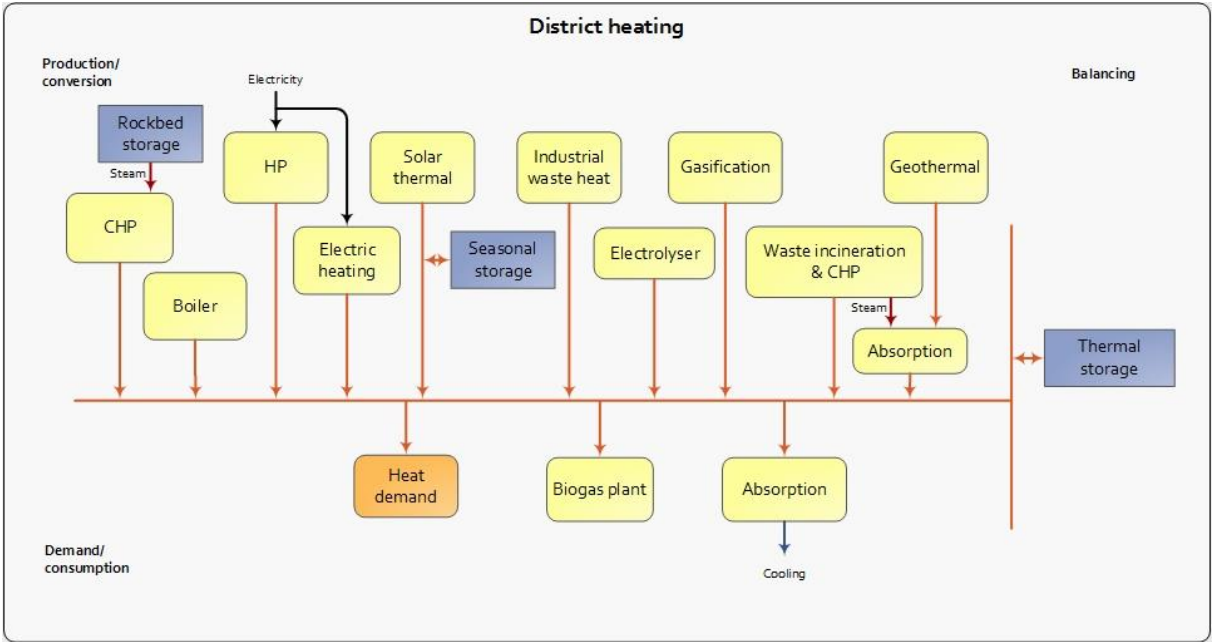

Illustration of components involved when the EnergyPLAN model calculates hourly balancing of the DISTRICT HEATING system including interactions with other parts of the whole system. In the model, district heating is divided into three separate systems: One meant for Boiler-alone systems; one meant for small CHP systems, and one meant for large CHP and extraction plants.

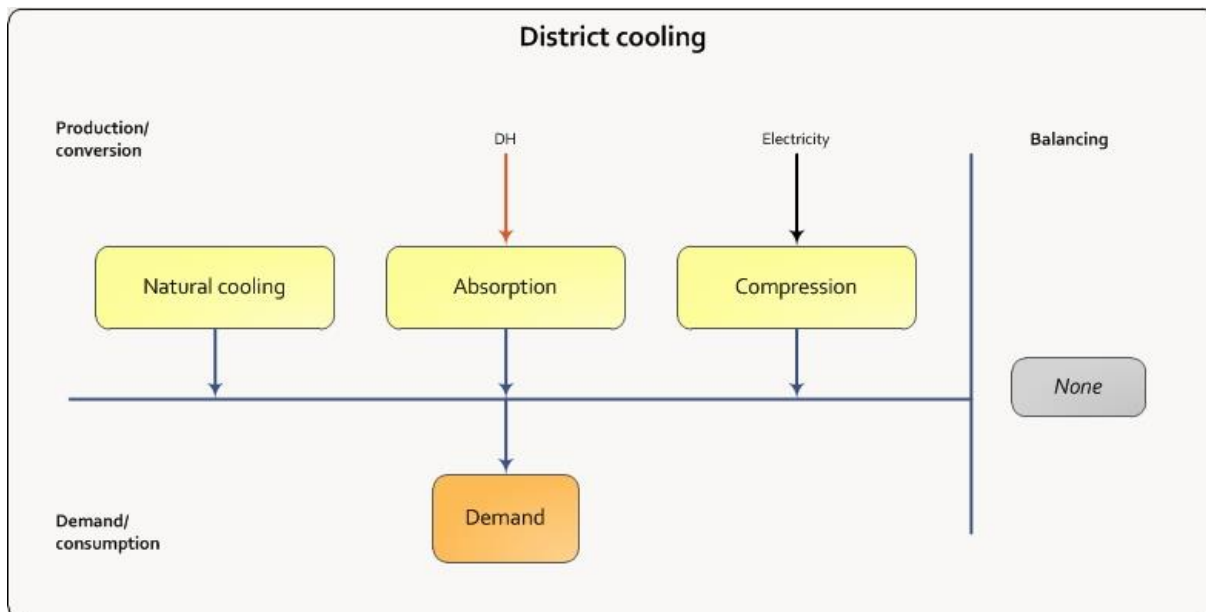

Illustration of components involved when the EnergyPLAN model calculates hourly balancing of the DISTRICT COOLING system including interactions with other parts of the whole system.

As a consequence, the EnergyPLAN tool does not only calculate an hourly electricity balance, but also hourly balances of district heating, cooling, hydrogen and natural gas, including contributions from biogas, gasification as well as electrolysis and hydrogenation. The following diagrams present a view of the production and conversion units involved in the balancing of the different grid structures.

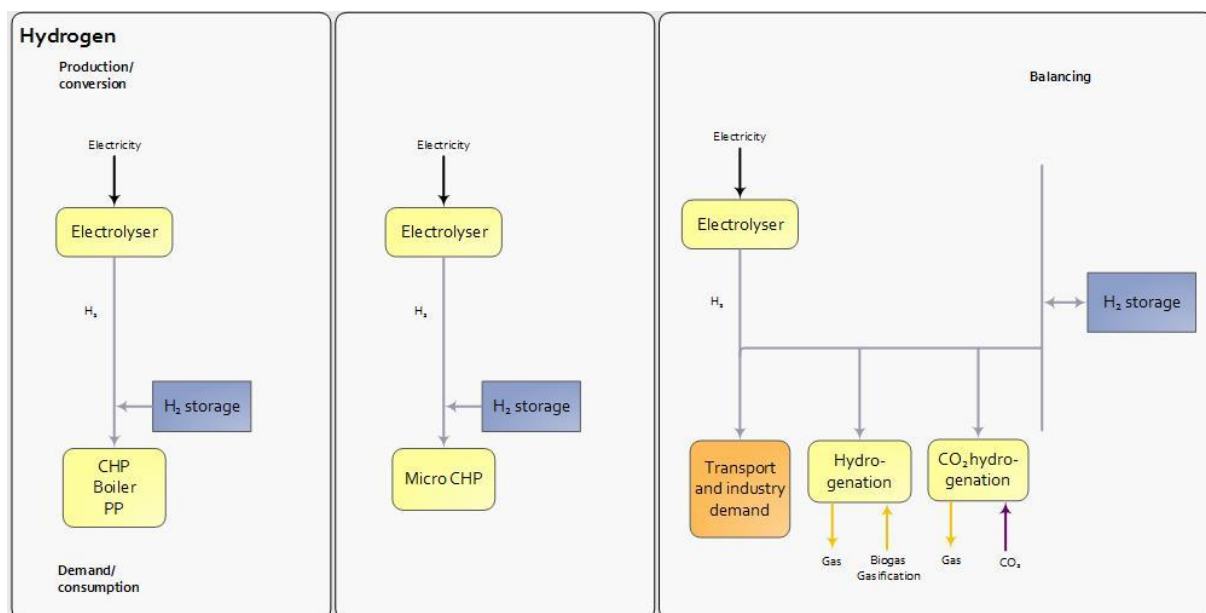

Illustration of components involved when the EnergyPLAN model calculates hourly balancing of the HYDROGEN system including interactions with other parts of the whole system. In the model, Hydrogen is calculated as three separate systems: One for CHP and Power plants; one for micro CHPs, and a joint system for the production of hydrogen for transportation and hydrogenation.

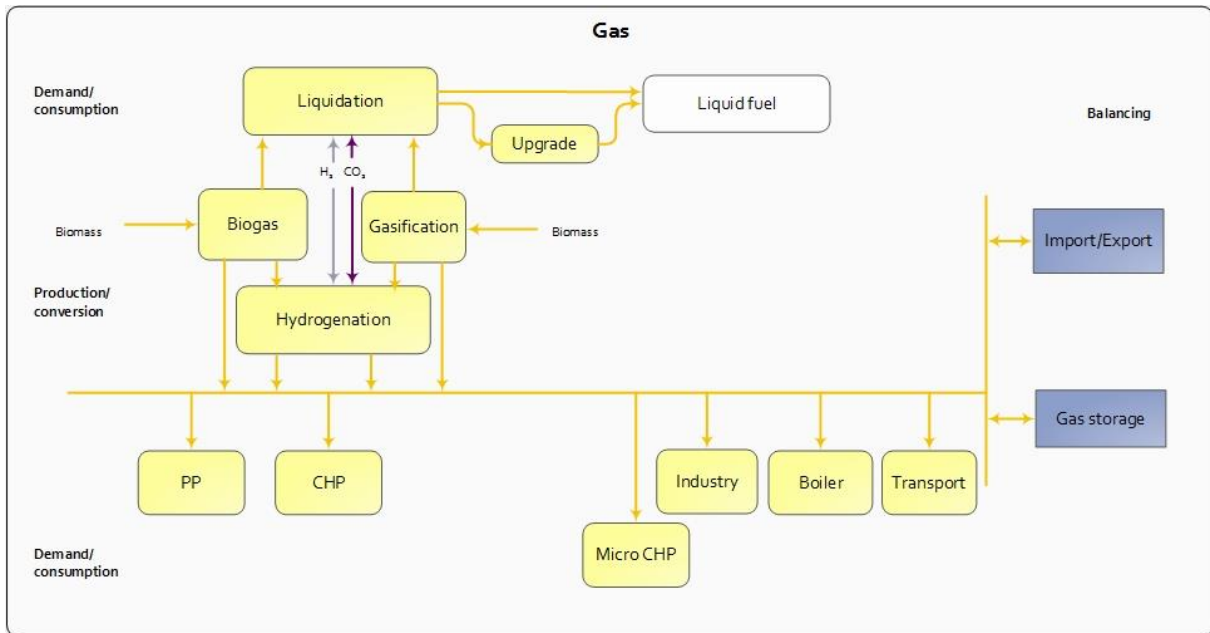
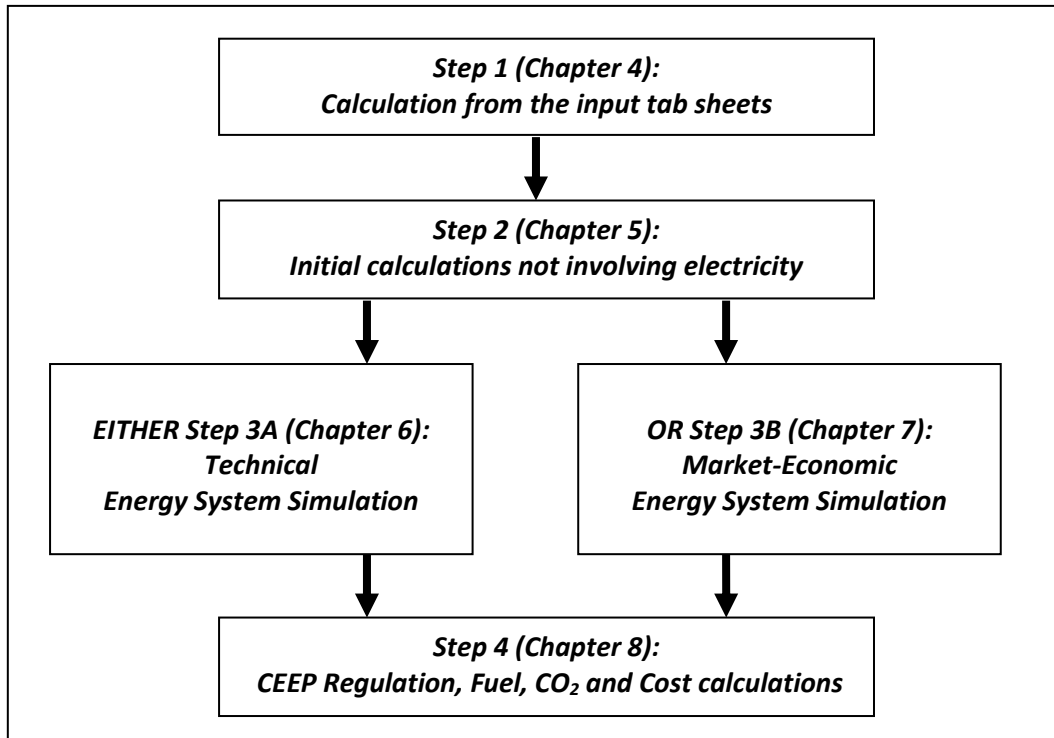

Illustration of components involved when the EnergyPLAN model calculates hourly balancing of the GAS GRID system including interactions with other parts of the whole system.

Basically, the model distinguishes between technical simulation and market-economic simulation. In the following, a list of energy demands is presented as well as an overview of all components in the model together with a short description of how they are operated in the two different simulation strategies. Also the main inputs of each component are listed.

1.3. Energy Systems Analysis in the EnergyPLAN model

The procedure of the energy system analysis is shown in the diagram. The calculations are based on the small calculation described in chapter 4, which is made simultaneously with the typing of input data in the input and cost tab sheets. Next step consists of some initial calculations, which do not involve electricity balancing. Then the procedure is divided into EITHER a technical OR a market-economic simulation. The technical simulation minimises the import/export of electricity and seeks to identify the least fuel-consuming solution. On the other hand, the market-economic simulation identifies the least-cost solution on the basis of the business-economic costs of each production unit.



Step 1: Calculation from the input tab sheets:

1. Electricity demand is calculated as in input tab sheet section 4.1.1.1
2. Solar thermal as in section 4.2.4.1
3. RES1, ... RES4 as in section 4.2.3
4. Hydro Power input as in section 4.2.2.3
5. Nuclear Power or Geothermal as in section 4.2.2.2
6. Hourly distribution between cooling produced from natural cooling and/or district heating and electricity as in section 4.1.3
7. Individual solar thermal, boilers, CHPs and heat pumps are calculated as in section 4.1.2 (If electrolysers for hydrogen productions are not specified, then the model will identify a minimum capacity and define an electrolyser)
8. Biofuels for transport and CHP/Boilers produced on waste as in section 4.2.6.1
9. Biogas, gasification and biofuel outputs as in section 4.2.7.1
10. Synthetic grid gas and biofuels as in section 4.2.7.4
11. Market prices of external market as in section 4.4.5

Step 2: Initial calculations not involving electricity balancing

1. Fixed import/export of electricity specified in the Electricity demand tab sheet (section 5.1).
2. District heating demands incl. heating demands from absorption cooling (section 5.2).
3. Industrial and Waste district heating and electricity productions (section 5.3).
4. Fixed Boiler production subtracted from the district heating demand (section 5.4).
5. Boiler production in district heating group 1 (section 5.5).

EITHER Step 3A: Technical Energy System Analysis

1. CHP, heat pumps and boilers in groups 2 and 3 (simulation 1 or 4) (section 6.2).
2. Flexible electricity demand (including dump charge BEV) (section 6.3).
3. CHP, heat pumps and boilers in groups 2 and 3 (simulation 2 or 3) **If chosen** (overrules production of simulation 1 or 4) (section 6.4).

4. Hydro power (section 6.5).
5. Individual CHP and heat pump systems (section 6.6).
6. Electrolyser for micro CHP, transport, hydrogenation and CHP and Boilers in DH group 2 and DH group 3 (section 6.7).
7. Heat storage in groups 3 and 2 (section 6.8).
8. Transport (Smart charge and V2G) (section 6.9).
9. Electricity storage (section 6.10).

The calculation of condensing power and import/export including CEEP and EEEP (Critical and Exportable Excess Electricity production) are calculated continuously more or less after each of the sequences in the technical energy system analysis procedure (section 6.1).

OR Step 3B: Market-Economic Energy System Analysis

1. Net Import and resulting external market price as in section 7.1
2. Market economic simulation as in section 7.2
3. CHP3 minimum production as in section 7.3
4. Boilers and solar thermal in district heating as in section 7.4
5. Hydrogen and electricity demands for electrolysis for transport, micro CHP and hydrogenation as in section 7.5
6. Electricity consumption for heat pumps and electrolysers for hydrogen to CHP and boilers in district heating groups 2 and 3 as in section 7.6
7. Hydro Power as in section 7.7
8. Electricity production from CHP and Power Plants as in section 7.8
9. Electricity storage as in section 7.9

Step 4: CEEP Regulation, Fuel, CO₂ and Cost calculations

1. Fixed boiler production is added to the boilers in groups 2 and 3 as in section 8.1
2. Critical Excess Regulation as in section 8.2
3. Grid stabilisation as in section 8.3
4. Heat balances in district heating systems as in section 8.4
5. Fuel consumptions as in section 8.5
6. CO₂ emissions as in section 8.6
7. Balancing of Gas Grid as in section 8.7
8. Share of Renewable Energy as in section 8.8
9. Cost as in section 8.9

1.4. Energy Demands

Energy demands include the following:

Electricity demand divided into

1. Fixed demand
2. Three types of flexible demands, and
3. Fixed import/export if any.

District heating demand divided into

2. District heating demand in systems without CHP (Boiler systems),
3. District heating demand in decentralised CHP systems and
4. District heating demand in centralised CHP systems (Typically extraction plants or similar).

Cooling demand divided into:

1. Cooling based on electricity supply (air conditioning etc.)
2. Cooling based on heat supply from district heating from the three DH groups mentioned above (based on absorption technologies)
3. Contribution to district cooling from natural cooling

Heat demand in individual houses divided into

1. Coal, oil, natural gas and biomass boilers
2. Micro CHP on either hydrogen, natural gas or biomass
3. Electric heating or heat pumps

Industry divided into coal, oil, natural gas, hydrogen and biomass

Various divided into coal, oil, natural gas, hydrogen and biomass

Transport divided into

1. Jet fuel, diesel, petrol, natural gas and biomass
2. Biofuels, electrofuels and hydrogen (produced by other components in the system)
3. Electric transport including smart charge and V2Gs (Vehicle to Grid)

Industry, Various and Transport (except from electric transport) are defined by an annual demand, while all other demands are defined by both an annual demand (TWh per year) and an hourly distribution data set (name of data set from the data bank).

Additional to the demands above productions units mentioned below may add further to the demand such as e.g. heat demands for biogas plants, electricity demands for large heat pumps etc. Such demands are specified along with the definition of the production and conversion units as well as the resulting operation identified in the energy system analysis carried out by the EnergyPLAN tool.

1.5. Overview: Components and Simulation

Renewable Energy Sources

Component	Input	Technical simulation	Market-economic simulation
Wind power Offshore wind Photovoltaic Wave power River Hydro	Electric capacity and Hourly distribution	Are given priority in the electricity production	Are given priority in the electricity production. Marginal production costs are defined as zero.
Hydro power	Electric capacity Efficiency Storage capacity Annual Water supply Hourly distribution of water Variable operational costs	First, best possible utilisation of all water input given limitations on capacities is calculated and used as input. Secondly, Hydro power is relocated in the best possible way to avoid excess electricity production.	Identify highest possible production given water input and distribution, turbine capacity and water storage capacity. Sell such maximum production at the highest possible market prices to achieve the highest possible income.
Reversible Hydro Power	Same input as Hydro plus Pump Capacity Pump Efficiency Pump variable opr. Costs	Same as Hydropower plus In the end, the Pump is used in order to avoid excess electricity production and the Turbine to avoid production on condensing power plants.	Same as Hydro power plus The hydro power pump and turbine are used to optimise the profit of the plant based on marginal costs and losses in the energy conversion
Geothermal Power	Electric capacity Efficiency Hourly distribution Variable operational costs	Is given priority in the electricity production.	Produce whenever the electricity price is higher than the variable operational costs.
Solar thermal in district heating system	<i>For each three DH groups:</i> Annual production Hourly distribution Heat storage capacity Losses in heat storage	Is given priority in the district heating supply.	Is given priority in the heat production. Marginal production costs are defined as zero.
Solar thermal in individual houses	<i>For each nine groups:</i> Annual production Hourly distribution Heat storage capacity	Is given priority in the heat supply.	Is given priority in the heat production. Marginal production costs are defined as zero.
Concentrated solar power (CSP)	Annual solar input Storage capacity Storage efficiency Hourly distribution Power capacity Power efficiency Stabilisation share	First, best possible utilisation of all solar thermal input given limitations on capacities is calculated and used as input. Secondly, CSP is relocated in the best possible way to avoid excess electricity production. Note: In case of CEEP the CSP production is lost	Identify highest possible production given solar input and distribution, power capacity and solar storage capacity. Sell such maximum production at the highest possible market prices to achieve the highest possible income. Note: In case of CEEP the CSP production is lost

Waste utilisation and conversion and industrial electricity and heat production for district heating

Component	Input	Technical simulation	Market-economic simulation
Industrial CHP	Annual production and Hourly distribution	Is given priority in the electricity production	Is given priority in the electricity production. Marginal production costs are defined as zero.
Industrial waste heat for district heating	<i>For each three DH groups:</i> Annual production and Hourly distribution	Is given priority in the district heating supply secondary to solar thermal.	Is given priority in the heat production secondary to solar thermal. Marginal production costs are defined as zero.
Waste incineration	<i>For each three DH groups:</i> Annual waste input and Hourly distribution Plant efficiency (thermal)	Is given priority in the district heating supply secondary to solar thermal.	Is given priority in the heat production secondary to solar thermal. Marginal production costs are defined as zero.
Waste CHP production	<i>For each three DH groups:</i> Annual waste input and Hourly distribution Plant efficiency (thermal) Plant efficiency (electric)	Electricity production is given priority in the supply Heat production is given priority in the district heating supply secondary to solar thermal.	Is given priority in both electricity and heat production secondary to solar thermal. Marginal production costs are defined as zero.
Waste for biofuel for CHP and boilers	<i>For each three DH groups:</i> Annual waste input and Hourly distribution Plant efficiency (biofuel)	Biofuel is utilised to replace fuel in relevant CHP units and boilers.	Biofuel is utilised to replace fuel in relevant CHP units and boilers.
Waste for biofuels for transport	<i>For each three DH groups:</i> Annual waste input and Hourly distribution Plant efficiency (biofuel)	Biofuel is transferred as input to the transport tab sheet.	Biofuel is transferred as input to the transport tab sheet.

Natural Cooling

Component	Input	Technical simulation	Market-economic simulation
Natural cooling	Annual potential Hourly distribution	Is given priority in the cooling production.	Is given priority in the cooling production.

Nuclear power

Component	Input	Technical simulation	Market-economic simulation
Nuclear Power	Electric capacity Efficiency Hourly distribution Variable operational costs Part load share	Is given priority in the electricity production. Can operate in part load as a CEEP regulation strategy.	Produce whenever the electricity price is higher than the variable operational costs.

Power plants, CHP units, heat pumps, electrolysers, heat storage and boilers for DH production

Component	Input	Technical simulation	Market-economic simulation
Boilers	<i>For each three DH groups:</i> Thermal capacity Thermal efficiency Variable operational costs Fuel specification	Are given last priority. If district heating cannot be supplied from any other unit (Solar thermal, industrial waste heat, CHP, heat pump or heat storage) then the boiler is used.	The marginal operational cost, including fuel costs and taxes, is compared to relevant options (such as CHP, heat pump and heat storage) and the business-economically least-cost solution is selected.
CHP units	<i>For DH groups 2 and 3:</i> Electric capacity Thermal efficiency Electric efficiency Variable operational costs Fuel specification	<i>Technical simulations 1 (and 4)</i> Are given priority after solar thermal and industrial waste heat to cover the heat demand. <i>Technical simulations 2 (and 3)</i> Are given priority after solar thermal and industrial waste heat to cover the heat demand only when electricity production is needed.	The marginal operational cost including fuel costs and taxes is compared to relevant options (such as boiler, heat pump, electrolysers and heat storage) and the business-economically least-cost solution is selected.
Heat Pumps	<i>For DH groups 2 and 3:</i> Electric capacity COP (Co-efficiency of performance.) Variable operational costs	<i>Technical simulations 1 (and 4)</i> Are given priority after CHP units to cover the heat demand. <i>Technical simulations 2 (and 3)</i> Are used in combination with CHP units to cover the heat demand and balance electricity supply and demand.	The marginal operational cost, including fuel costs and taxes, is compared to relevant options (such as boiler, CHP, electrolysers and heat storage) and the business-economically least-cost solution is selected.
Heat Storage	<i>For DH groups 2 and 3:</i> Heat storage capacity	Identify and implement changes in the use of CHP and heat pumps which can decrease excess electricity production and production on condensing power plants, and decrease heat production on boilers.	The heat storage is used in order to implement changes in CHP, heat pump and boilers, which will lead to better business-economic profits. One can choose between a weekly and a seasonal focus in the regulation strategy.
Electric boiler	No inputs	Only used as part of Critical Excess Electricity regulation if specified in the regulations strategy	Only used as part of Critical Excess Electricity regulation if specified in the regulations strategy
Electrolysers	<i>For DH groups 2 and 3:</i> Electric capacity Efficiency (fuel/hydrogen) Efficiency (heat) Variable operational costs	Are activated in the case of excess electricity production to produce fuel for the CHP and boilers. When activated the electrolysers replace heat production from CHP and heat pumps.	The marginal operational cost, including fuel costs and taxes, is compared to relevant options (such as boiler, CHP, heat pumps and heat storage) and the business-economically least-cost solution is selected.
Power plants	Electric capacity Efficiency (electric) Variable operational costs Minimum capacity Fuel specification	Are given priority after all other electricity production units if the demand is still higher than the supply. (Or if production is requested for reasons of grid stability).	Produce whenever the electricity price is higher than the variable operational costs.

Individual house heating and micro CHP

Component	Input	Technical simulation	Market-economic simulation
Coal boilers Oil boilers Ngas boilers Biomass boilers	Efficiency Hourly distribution (Fuel consumption is defined as demand)	Are given priority after solar thermal.	Are given priority after solar thermal.
H2 micro CHP Ngas micro CHP Biomass micro CHP	Heat demand Hourly distribution capacity (in % of max heat) (Reserve boiler with boiler efficiency of natural gas or biomass boilers is assumed) Thermal efficiency Electric efficiency Variable operational costs of both CHP and boilers Heat storage capacity	Is given priority after solar thermal and before boiler. Heat storage (if any) is used first in order to utilise solar thermal and, secondly, to relocate CHP production with the aim of decreasing excess electricity production and the quantity of condensing power in the overall system.	The marginal cost, including fuel costs and taxes of electricity production on CHP, is compared to boiler only production. CHP is activated if the marginal cost is below the market price. Heat storage is used in order to achieve best market prices of electricity produced on CHP.
Heat pumps in individual houses	Heat demand Hourly distribution capacity (in % of max heat) (Reserve electric boiler is assumed) COP Variable operational costs of both heat pump and electric heating Heat storage	Are given priority after solar thermal and before electric boiler. Heat storage (if any) is used first in order to utilise solar thermal and, secondly, to relocate heat pump consumption with the aim of decreasing excess electricity production and the quantity of condensing power in the overall system.	The marginal cost of producing heat on heat pumps including taxes is compared to electric heating and the least-cost option is chosen. Heat storage is used in order to achieve lowest market prices of the electricity consumed by heat pumps.
Electric heating in individual houses	Heat demand Hourly distribution Heat storage	Is given priority after solar thermal. Heat storage (if any) is used first in order to utilise solar thermal and, secondly, to relocate electric heating consumption with the aim of decreasing excess electricity production and the quantity of condensing power in the overall system.	Heat storage is used in order to achieve lowest market prices of the electricity consumed by heat pumps.

Transport

Component	Input	Technical simulation	Market-economic simulation
Airplanes on JP	Are defined as fuel demands.	None	None
Vehicles on petrol Vehicles on diesel Vehicles on Ngas Vehicles on biofuels Vehicles on electrofuels Vehicles (ships) on ammonia	Are defined as fuel demands.	None	None
Vehicles on biofuels from waste conversion	None (Are defined as fuel output from conversion of waste)	None	None
Vehicles on Hydrogen	Hydrogen fuel demand and Hourly distribution (additional input data for electrolyzers are needed, see below)	None (However, the electrolyser is subject to regulation)	None (However, the electrolyser is subject to regulation)
BEV (Battery Electric Vehicle). Dump charge	Electricity demand and Hourly distribution	None (Is included as a fixed electricity demand defined by the hourly distribution.	None (Is included as a fixed electricity demand defined by the hourly distribution.
BEV (Battery Electric Vehicle). Smart charge	Electricity demand and Hour distribution of demand Max share of parked cars Share of cars connected Efficiency of charge Battery capacity Capacity of grid to battery	Electricity charging is used with the aim of decreasing excess electricity production and the quantity of condensing power in the overall system.	Battery storage is used in order to achieve lowest market prices of the electricity consumed.
V2G (Vehicle to grid).	<i>Same as BEV smart plus</i> Efficiency of discharge Capacity of battery to grid	Electricity charging and discharging is used with the aim of decreasing excess electricity production and the quantity of condensing power in the overall system.	Battery storage is used in order to achieve lowest market prices of the electricity consumed and to optimise profits from selling and buying electricity.

Electrolysers and electricity storage systems

Component	Input	Technical simulation	Market-economic simulation
Electrolysers for hydrogen for transport and for electrofuels	Capacity (electric) Efficiency Storage capacity (Demand is defined by hydrogen vehicles) (Demand is defined by demand for electrofuels)	Hydrogen production is determined by hydrogen demand for transport and electrofuels. Hydrogen storage is used in order to relocate electricity consumption with the aim of decreasing excess electricity production and the quantity of condensing power in the overall system.	Hydrogen production is determined by hydrogen demand for transport and for electrofuels. Hydrogen storage is used in order to achieve lowest market prices of the electricity consumed by electrolysers.
Electrolysers for hydrogen for micro CHP	Capacity (electric) Efficiency Storage capacity (Demand is defined by hydrogen micro CHP)	Hydrogen production is determined by hydrogen demand for micro CHP. Hydrogen storage is used in order to relocate electricity consumption with the aim of decreasing excess electricity production and the quantity of condensing power in the overall system.	Hydrogen production is determined by hydrogen demand for micro CHP. Hydrogen storage is used in order to achieve lowest market prices of the electricity consumed by electrolysers.
Battery storage Hydro pump storage Hydrogen FC storage	Capacity (charge) Efficiency (charge) Capacity (discharge) Efficiency (discharge) Variable operational costs of both charge and discharge	Charge in case of excess electricity production (and export if specified) Discharge in case of condensing power production. Make sure that the storage content is the same at the beginning and at the end of the year.	The charging and discharging is used in order to optimise the profit of the plant based on marginal costs and losses in the energy conversion
CAES (Compressed Air Energy Storage)	<i>Same as battery storage plus</i> Fuel-ratio (defined as fuel input / electric output)	Load in case of excess electricity production (and export if specified) Unload in case of condensing power production. Make sure that the storage content is the same at the beginning and at the end of the year.	Optimise the profit of the plant based on marginal costs and losses in the energy conversion
High temperature electricity storage (Rockbed Storage)	Charge capacity (electric) Discharge capacity (steam) Storage capacity Storage loss rate (share per hour) Share of PP1/CHP3 connected to storage Steam/fuel ratio	Charge in case of excess electricity production (and export if specified) Discharge in case of condensing power or CHP3 production on units with high temperature storage. Make sure that the storage content is the same at the beginning and at the end of the year.	Not yet implemented in market-economic simulation

Biomass Conversion Technologies

Component	Input	Technical simulation	Market-economic simulation
Biogas Plant	Annual Biogas production and hourly distribution Annual heat and electricity demands Annual inputs of wet and solid biomass Biogas-to-GasGrid efficiency	Electricity demand is added to the system demand Heat demands are added to demand in relevant DH groups Biogas is subtracted in Ngas consumption resulting in changes in import/export	Same as technical simulation
Gasification Plant	Annual Biomass input Relative biomass for steam demand and electricity demand Relative heat output Max Capacity Syngas-to-GasGrid efficiency	Electricity demand is added to the system demand Heat productions are subtracted heat demand in relevant DH groups Syngas is subtracted in Ngas consumption resulting in changes in import/export. Max Capacity is used to minimise exchange of gas via gas grid.	Same as technical simulation
BioDiesel Plant	Annual BioDiesel output Relative electricity demand DryBiomass-to-BioDiesel efficiency DryBiomass-to-Biomass efficiency	Electricity demand is added to the system demand BioDiesel is transferred to the Transportation Tab Sheet (demand) Biomass output is subtracted in biomass fuel for power plants, etc.	Same as technical simulation
BioPetrol Plant	Annual BioPetrol output Relative biomass for steam demand and electricity demand Biomass-to-BioPetrol efficiency Biomass-to-Food efficiency Per unit value of food by-product Relative heat output	Electricity demand is added to the system demand Heat productions are subtracted heat demand in relevant DH group BioPetrol is transferred to the Transportation Tab Sheet (demand) Food by-product is subtracted in biomass fuel for power plants, etc. Value of food by-product is included in fuel cost calculation	Same as technical simulation
BioJP Plant (Jet Petrol)	Annual JP output Relative biomass for steam demand and electricity demand Biomass-to-BioJP efficiency Biomass-to-Food efficiency Per unit value of food by-product Relative heat output	Electricity demand is added to the system demand Heat productions are subtracted heat demand in relevant DH group BioJP is transferred to the Transportation Tab Sheet (demand) Food by-product is subtracted in biomass fuel for power plants, etc. Value of food by-product is included in fuel cost calculation	Same as technical simulation

Synthetic Gas and Liquid Fuel Production Plants

Component	Input	Technical simulation	Market-economic simulation
CO ₂ Hydrogenation	<p>Annual Synthetic Grid gas production and/or annual liquid fuel demand</p> <p>Hydrogen ratio and CO₂ ratio.</p> <p>Sequestration efficiencies (Elec./CO₂ and CO₂/syngas)</p> <p>Relative heat output</p> <p>Max Capacity</p>	<p>The plant produces the specified amount of synthetic gas in a way in which it tries to minimise the critical excess electricity production of the whole system as well as the production on power-alone plants.</p> <p>If activating CEEP reduction strategy 8, the excess electricity produced is used for the production of additional synthetic gas when the plant has available capacity</p>	Same as technical simulation
Ammonia production	<p>Annual ammonia production</p> <p>Hydrogen ratio and nitrogen ratio</p> <p>Sequestration efficiencies (Elec./N₂ and N₂/ammonia)</p> <p>Relative heat output</p>	<p>The plant produces the specified amount of ammonia in a way in which it tries to minimise the critical excess electricity production of the whole system as well as the production at power-alone plants.</p>	Same as technical simulation
Biomass hydrogenation	<p>Annual Synthetic Grid gas production and/or annual liquid fuel demand</p> <p>Efficiency (From gasification and Hydrogen to Synthetic gas)</p> <p>Hydrogen share</p> <p>Max Capacity</p>	<p>The plant produces the specified amount of synthetic gas as base load.</p> <p>Hydrogen is being used to minimise the excess electricity production of the system given the limitations in capacities of electrolyzers and hydrogen storage used as part of the electrolyzers for transport.</p>	Same as technical simulation
Biogas hydrogenation	<p>Annual Synthetic Grid gas production and/or annual liquid fuel demand</p> <p>Efficiency (From biogas and Hydrogen to Synthetic gas)</p> <p>Hydrogen share</p> <p>Max Capacity</p>	<p>The plant produces the specified amount of synthetic gas as base load.</p> <p>Hydrogen is being used to minimise the excess electricity production of the system given the limitations in capacities of electrolyzers and hydrogen storage used as part of the electrolyzers for transport.</p>	Same as technical simulation
Liquid Electrofuel Synthesis	<p>Annual production of jet petrol, methanol and DME</p> <p>Efficiencies (additional conversion efficiency not accounted before)</p>	<p>Production of electrofuels (methanol, DME and jet petrol) is transferred to the transport tab sheet.</p> <p>The production for liquid electrofuels is subtracted from transport electrofuel demand</p>	Same as technical simulation

2. Navigation

There is one main menu and three ribbons in the EnergyPLAN navigation.

2.1. Main Menu

The main menu can be found by clicking the AAU logo in the top right of the window, as highlighted below. This allows the user to select between a number of standard options such as creating a new file, opening an existing file, saving a file, and exiting the program. There are also buttons to run a model and access your settings.

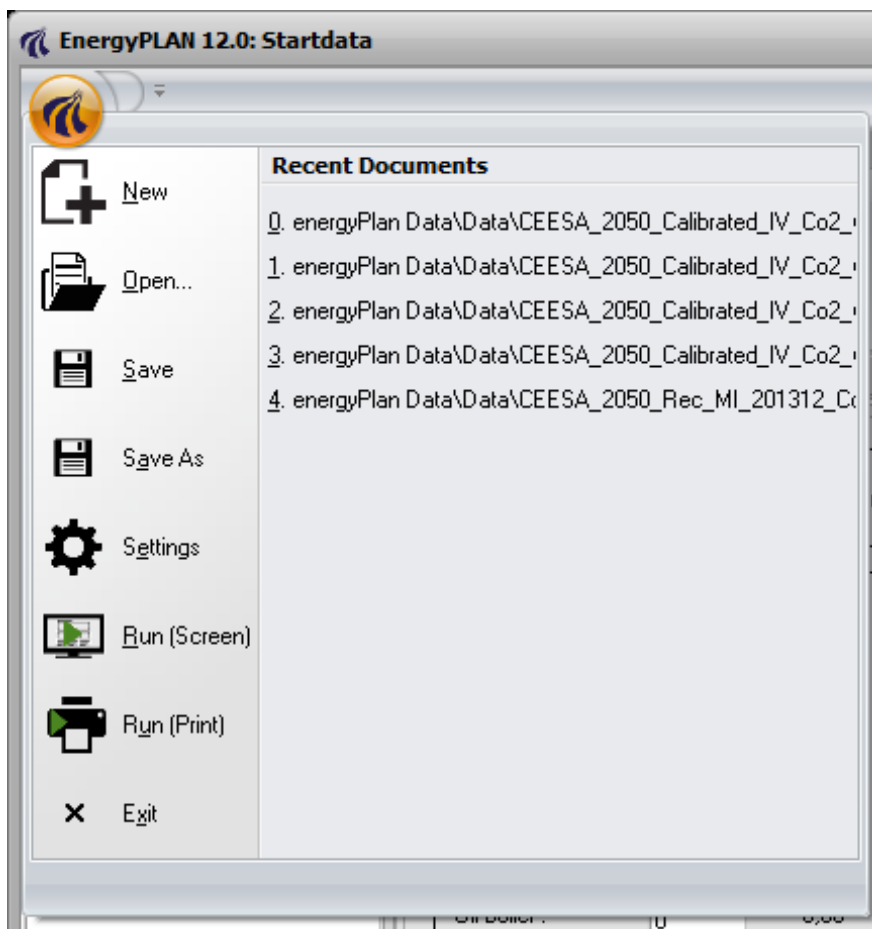

The three ribbons in EnergyPLAN are: Home, Add-On Tools, and Help. In the section below, some of the key features on the main menu and ribbons are described.

2.1.1. Opening a new file

When you click the 'New' button on the main menu or the ribbon, EnergyPLAN will automatically open the "initialize.txt" file and name this new file as "energyplan_new.txt". This will ensure that you do not save over the original "initialize.txt" file.

2.2. Home

The Home button on the home menu gives the user an overview of the components and synergies included in the EnergyPLAN model, as described in section 1.2. It also describes the latest version and most recent date that EnergyPLAN was updated.

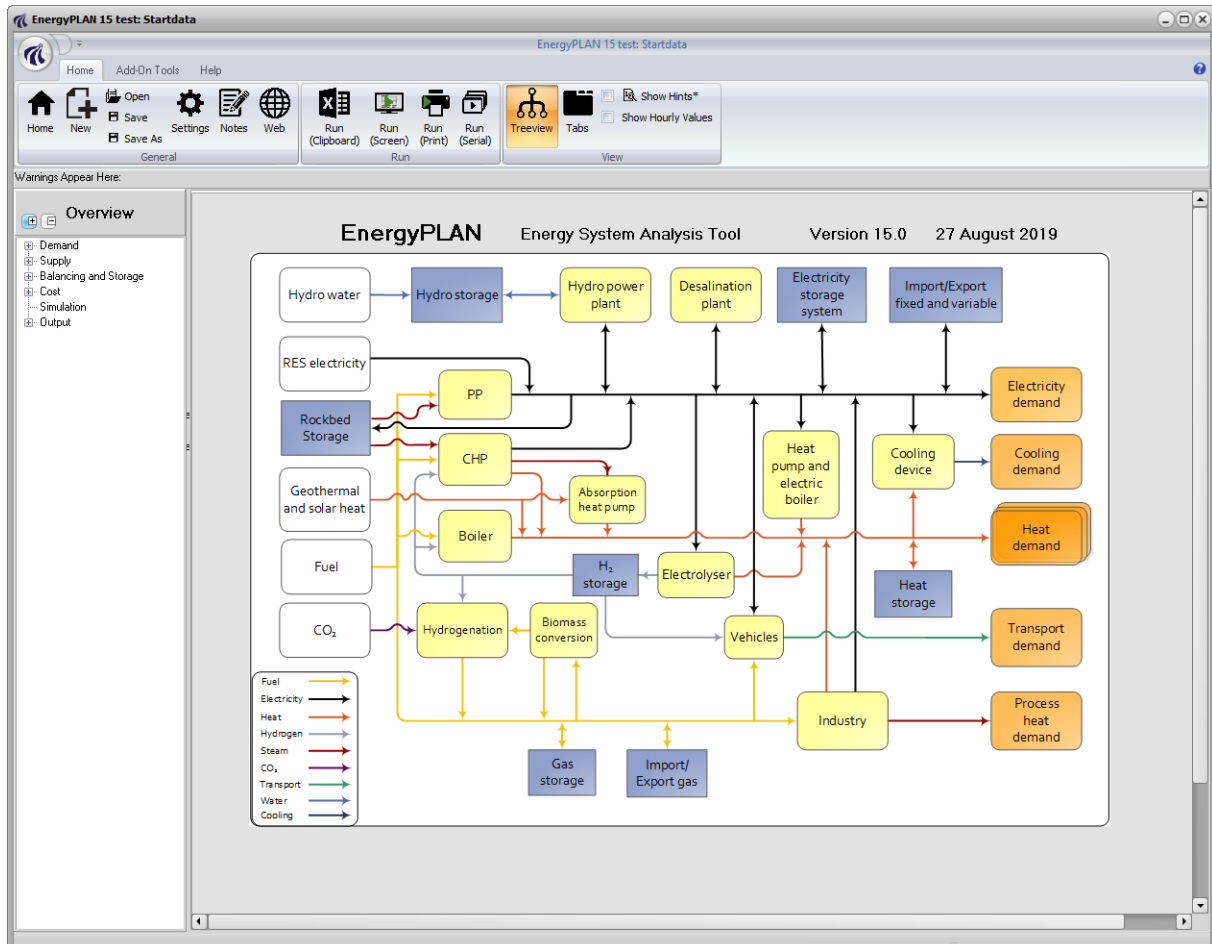

2.2.1. Notes

Under the notes page, the user can add some comments and notes about the tool being developed. Some standard inputs are available such as the model area and year, but there is also space to provide general notes if required.

Model Area (e.g. country) <input type="text" value="Ireland"/> Model Year <input type="text" value="2050"/> Year Developed <input type="text" value="2015"/>	This is a general note. The efficiency for my biomass boiler is from the energy agency
---	---

2.2.2. Import from Excel

The screenshot shows a dialog box titled "Import from Excel". It contains the following elements:

- Select excel file:** A button labeled "Select excel file" and a text field showing the path: "C:\OfflineDavid\Work\Delphi\EnergyPLAN 20150114\Run\energyPlan Data\Data\Excel\EnergyPLA".
- Select dataset:** A dropdown menu with "HR Step 1 savings" selected.
- Save dataset file path:** A button labeled "Save dataset file path" and a text field showing the path: "C:\OfflineDavid\Work\Delphi\EnergyPLAN 20150113\Run\energyPlan Data\Data\Excel".
- Save data as:** A text field showing the path: "C:\OfflineDavid\Work\Delphi\EnergyPLAN 20150113\Run\energyPlan Data\Data\Excel\HR Step 1 savings.txt".
- Import, Save and Load dataset:** A large button at the bottom.

If you have a range of different EnergyPLAN files saved in MS Excel, then it is possible to import them using the 'Import from Excel' tool. In the tool, you specify:

1. The location of your excel sheet
2. The name of the file you want to import (see more details below)
3. The place you would like to save the new EnergyPLAN file, once it is imported from excel
4. Click the 'Import, Save and Load Dataset' button to complete the action.

The EnergyPLAN files must be saved in the first sheet of the excel file and each data file must be a single column, see below. Furthermore, the word 'Name' must appear at the top of the EnergyPLAN file so it will be recognised in the 'Select Dataset' dropdown menu. A dataset column is recognized if "Name" is found in any cell in the first 20 rows of a column. A sample excel sheet is presented below.

	A	B
1		
2		
3	Name	Name
4	HR 2010	HR BAU
5	EnergyPLAN version	EnergyPLAN version
6	698	698
7	EnergyUnit=	EnergyUnit=
8	TWh/year	TWh/year
9	CapacityUnit=	CapacityUnit=
10	MW	MW
11	MonetaryUnit=	MonetaryUnit=
12	EUR	EUR
13	Input_el_demand_Twh=	Input_el_demand_Twh=
14	18.50027778	25.96072949
15	Input_EI_demand_elec_heating_share=	Input_EI_demand_elec_heating_share=
16	0.85833474	0.960390204
17	Input_EI_demand_cooling_share=	Input_EI_demand_cooling_share=
18	0.423973234	0.44917831
19	input_dh_demand_TWh=	input_dh_demand_TWh=
20	21.21	21.21
21	input_RES1_capacity=	input_RES1_capacity=
22	89	628.545791
23	input_RES2_capacity=	input_RES2_capacity=

2.2.3. Run Options

There are three different run options in EnergyPLAN:

- Run Clipboard
- Run Screen
- Run Print

If you run to the screen, then a pop-up window appears with the results from the analysis, as below.

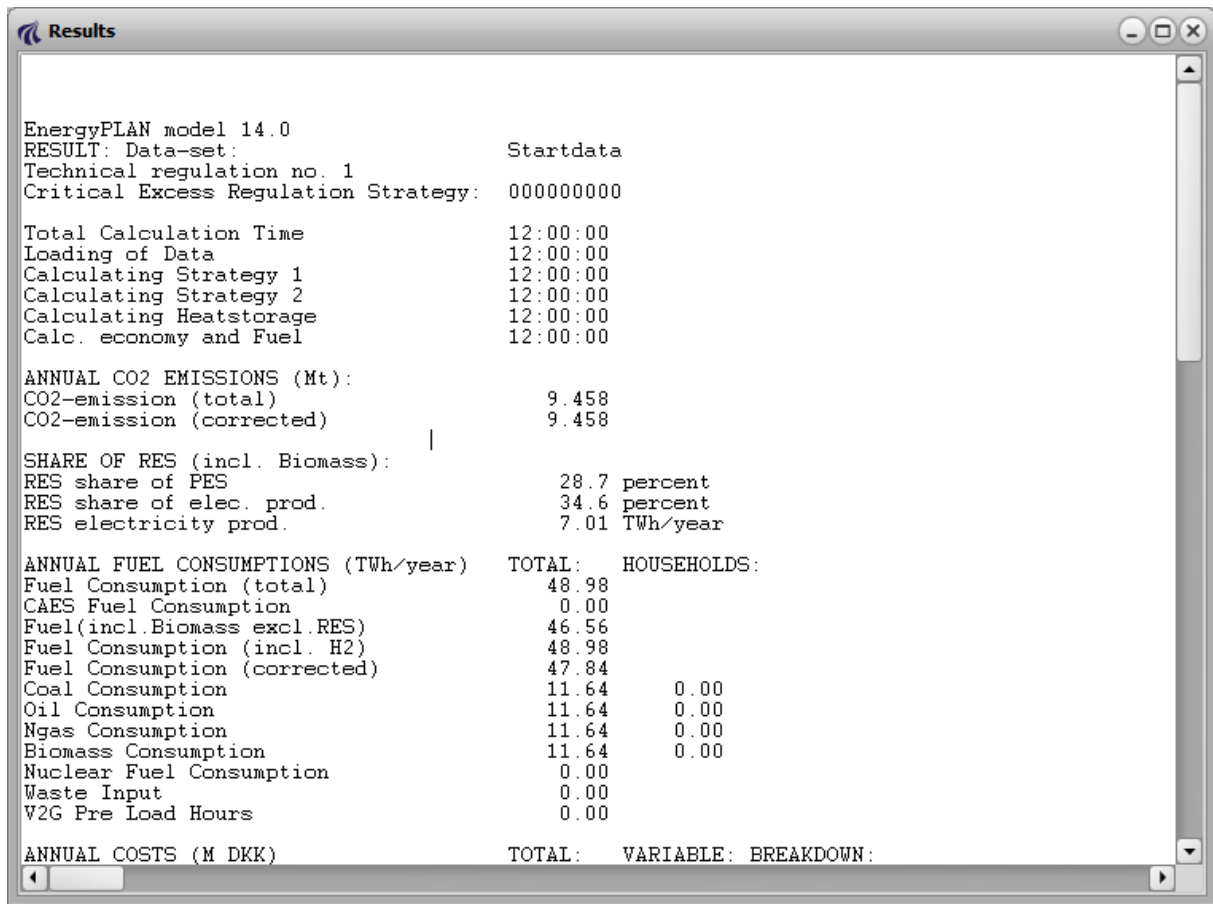

If you run to the clipboard, the same results are provided, but this time they are saved on your clipboard. Therefore, you can go to a spreadsheet, like MS Excel, and paste in the results, like below.

	A	B	C	D	E	F	G	H	I	J	K	L	M
1													
2													
3													
4			EnergyPLAN model 12.0				OVERVIEW	Interest	0.00%				
5			RESULT: energyplan_new.txt										
6			Technical regulation no. 1				COSTS (M	Total Inv.	Annual In: Fixed				Total Inv.
7			Critical Excess Regulation Strategy: 00000000				Costs	Costs	O&M				Costs
8							Solar therm	0	0	0			
9	Total Calc	00:00:00					Small CHF	0	0	0			0
10	Loading o	00:00:00					Heat Pump	0	0	0			
11	Calculatin	00:00:00					Heat Stora	0	0	0			0
12	Calculatin	00:00:00					Large CHF	0	0	0			
13	Calculatin	00:00:00					Heat Pump	0	0	0			0
14	Calc. ecor	00:00:00					Heat Stora	0	0	0			
15							Boilers gr.	0	0	0			0
16			ANNUAL CO2 EMISSIONS (Mt):				Large Pow	0	0	0			
17	CO2-emis	0					Wind	0	0	0			0
18	CO2-emis	0					Wind offs	0	0	0			
19							Photo Volt	0	0	0			0
20			SHARE OF RES (incl. Biomass):				Wave pow	0	0	0			
21	RES share	0 percent					River of hy	0	0	0			0
22	RES share	100 percent					Hydro Pow	0	0	0			
23	RES elect	0 TWh/year					Hydro Stoi	0	0	0			0
24							Hydro Pur	0	0	0			

If you run to the printer, then you will obtain an overview of the results on A4 pages. This is a different set of results compared to the Screen and Clipboard. It is usually most convenient to send these results to a pdf or xps printer so you can save the files on your computer. The result should appear like below.

Input		Startdata		The EnergyPLAN model 13.0																										
Electricity demand (TWh/year):		Flexible demand	0.00	Group 2:		Capacities		Efficiencies		Regulation Strategy: Technical regulation no. 1										Fuel Price level:										
Fixed demand		20.00	Fixed imp/exp.	0.00	CHP		MW-e	MJ/s	elec.	Ther	CEEP regulation										Capacities Storage Efficiencies									
Electric heating + HP		0.00	Transportation	0.00	Heat Pump		1000	1250	0.40	0.50	Minimum Stabilisation share										MW-e GWh elec. Ther.									
Electric cooling		0.00	Total	20.00	Boiler		0	0			Stabilisation share of CHP										Hydro Pump:									
District heating (TWh/year):		Gr.1	Gr.2	Gr.3	Sum	Group 3:		CHP		Minimum CHP gr 3 load										Hydro Turbine:										
District heating demand		0.00	10.00	10.00	20.00	CHP		1500	1875	0.40	0.50	Minimum PP										Electrol. Gr.2:								
Solar Thermal		0.00	0.00	0.00	0.00	Heat Pump		100	300			Heat Pump maximum share										Electrol. Gr.3:								
Industrial CHP (CSHP)		0.00	0.00	0.00	0.00	Boiler		5000		0.90		Maximum import/export										Electrol. trans.:								
Demand after solar and CSHP		0.00	10.00	10.00	20.00	Condensing		4000		0.45		Distr. Name -										Ely. MicroCHP:								
Wind		1000 MW	2.07 TWh/year	0.00 Grid		Heatsstorage: gr.2:		10 GWh	gr.3:	10 GWh	Addition factor										CAES fuel ratio:									
Photo Voltaic		500 MW	0.35 TWh/year	0.00 stabili-		Fixed Boiler: gr.2:		0.0 Per cent	gr.3:	0.0 Per cent	Multiplication factor										(TWh/year) Coal Oil Ngas Biomass									
Offshore Wind		0 MW	0 TWh/year	0.00 sation		Electricity prod. from		CSHP	Waste	(TWh/year)	Dependency factor										Transport 0.00 0.00 0.00 0.00									
River Hydro		0 MW	0 TWh/year	0.00 share		Gr.1:		0.00	0.00		Average Market Price										Household 0.00 0.00 0.00 0.00									
Hydro Power		0 MW	0 TWh/year			Gr.2:		0.00	0.00		Gas Storage										Industry 0.00 0.00 0.00 0.00									
Geothermal/Nuclear		0 MW	0 TWh/year			Gr.3:		0.00	0.00		Syngas capacity										Various 0.00 0.00 0.00 0.00									
Geothermal/Nuclear		0 MW	0 TWh/year			Gr.3:		0.00	0.00		Biogas max to grid																			
Output		District Heating										Electricity										Exchange								
Demand		Production								Consumption										Balance				Payment						
Distr. heating	Solar	Waste+ CSHP	DHP	CHP	HP	ELT	Boiler	EH	Ba-	Elec.	Flex.& Transp.	HP	Electrolyser	EH	Hydro Pump	Turbine	RES	Hydro	Geo-thermal	Waste+ CSHP	CHP	PP	Stab-Load %	Imp	Exp	CEEP	EEP	Imp	Exp	
MW	MW	MW	MW	MW	MW	MW	MW	MW	MW	MW	MW	MW	MW	MW	MW	MW	MW	MW	MW	MW	MW	MW	MW	MW	MW	MW	MW	MW	MW	
January	3856	0	0	0	2984	198	0	678	0	-4	2573	0	66	0	0	0	0	318	0	0	0	2387	165	180	0	231	0	231	0	32
February	3644	0	0	0	2889	184	0	572	0	-1	2546	0	61	0	0	0	0	317	0	0	0	2311	117	172	0	138	0	138	0	15
March	3140	0	0	0	2674	150	0	320	0	-4	2450	0	50	0	0	0	0	261	0	0	0	2139	143	166	0	42	0	42	0	5
April	2346	0	0	0	2200	127	0	13	0	6	2159	0	42	0	0	0	0	282	0	0	0	1760	193	150	0	33	0	33	0	4
May	1538	0	0	0	1518	24	0	0	0	-4	2107	0	8	0	0	0	0	286	0	0	0	1214	615	188	0	0	0	0	0	0
June	1124	0	0	0	1125	0	0	0	0	-1	2048	0	0	0	0	0	0	277	0	0	0	900	870	213	0	0	0	0	0	0
July	913	0	0	0	913	0	0	0	0	0	1867	0	0	0	0	0	0	215	0	0	0	730	921	229	0	0	0	0	0	0
August	946	0	0	0	946	0	0	0	0	0	2149	0	0	0	0	0	0	234	0	0	0	757	1158	237	0	0	0	0	0	0
September	1333	0	0	0	1331	1	0	0	0	1	2204	0	0	0	0	0	0	255	0	0	0	1064	885	211	0	1	0	1	0	0
October	2072	0	0	0	2008	60	0	2	0	2	2287	0	20	0	0	0	0	234	0	0	0	1606	471	176	0	4	0	4	0	1
November	2923	0	0	0	2572	145	0	212	0	-5	2471	0	48	0	0	0	0	308	0	0	0	2057	228	161	0	75	0	75	0	11
December	3533	0	0	0	2826	183	0	524	0	0	2472	0	61	0	0	0	0	324	0	0	0	2261	127	170	0	179	0	179	0	25
Average	2277	0	0	0	1996	89	0	193	0	-1	2277	0	30	0	0	0	0	276	0	0	0	1597	493	188	0	58	0	58	0	58
Maximum	4049	0	0	0	3125	300	0	775	0	996	3512	0	100	0	0	0	0	1329	0	0	0	2500	2087	287	0	1561	0	1561	0	180
Minimum	820	0	0	0	538	0	0	0	0	-244	1141	0	0	0	0	0	0	0	0	0	431	0	100	0	0	0	0	0	0	281
TWh/year	20.00	0.00	0.00	0.00	17.53	0.78	0.00	1.69	0.00	-0.01	20.00	0.00	0.26	0.00	0.00	0.00	0.00	2.42	0.00	0.00	0.00	14.03	4.33	0.00	0.51	0.00	0.51	0	93	
FUEL BALANCE (TWh/year):		CAES										BioCon-Electro-										PV and Wind off		Industry		CO2 emission (Mt):				
DHP		CHP2	CHP3	Boiler2	Boiler3	PP	Geo/Nu.	Hydro	Waste	Elec.ly.	version	Fuel	Wind	CSP	Wave	Hydro	Solar.Th	Transp.	househ.	Various	Total	Imp/Exp	Corrected	Net	Total	Net				
Coal		-	4.15	4.61	0.47	-	2.40	-	-	-	-	-	-	-	-	-	-	-	-	-	-	11.64	0.00	11.64	3.98	3.98				
Oil		-	4.15	4.61	0.47	-	2.40	-	-	-	-	-	-	-	-	-	-	-	-	-	-	11.64	0.00	11.64	3.10	3.10				
N.Gas		-	4.15	4.61	0.47	-	2.40	-	-	-	-	-	-	-	-	-	-	-	-	-	-	11.64	0.00	11.64	2.38	2.38				
Biomass		-	4.15	4.61	0.47	-	2.40	-	-	-	-	-	-	-	-	-	-	-	-	-	-	11.64	0.00	11.64	0.00	0.00				
Renewable		-	-	-	-	-	-	-	-	-	-	-	2.07	0.35	-	-	-	-	-	-	-	2.42	0.00	2.42	0.00	0.00				
H2 etc.		-	-	-	0.00	-	0.00	-	-	-	-	-	-	-	-	-	-	-	-	-	-	0.00	0.00	0.00	0.00	0.00				
Biofuel		-	-	-	-	-	-	-	-	-	-	-	-	-	-	-	-	-	-	-	-	0.00	0.00	0.00	0.00	0.00				
Nuclear/CCS		-	-	-	-	-	-	-	-	-	-	-	-	-	-	-	-	-	-	-	-	0.00	0.00	0.00	0.00	0.00				
Total	-	16.61	18.45	1.88	-	9.61	-	-	-	-	-	-	2.07	0.35	-	-	-	-	-	-	-	48.98	-1.14	47.84	9.46	9.46				

28-September-2018 [15:27]

2.2.4. View

There are two ways to navigate through the tabsheets of EnergyPLAN:

- Treeview
- Tabs

Both can be turned on or off using the respective buttons in the View section of the Home ribbon. The Treeview is on the left and the tabs appear on the top of the window.

The Show Hints checkbox is available if you need some extra descriptions of explanation of the inputs. For example, in the image below, the white boxes appear to illustrate what the group 1, group 2, and group 3 district heating labels represent. Also, wherever there is a star (*) in the text of EnergyPLAN, then an explanation will appear beside that text when you hover over it, while the Show Hints box is checked. For example, below is a description that appears for the "CHP Back Pressure Mode Operation".

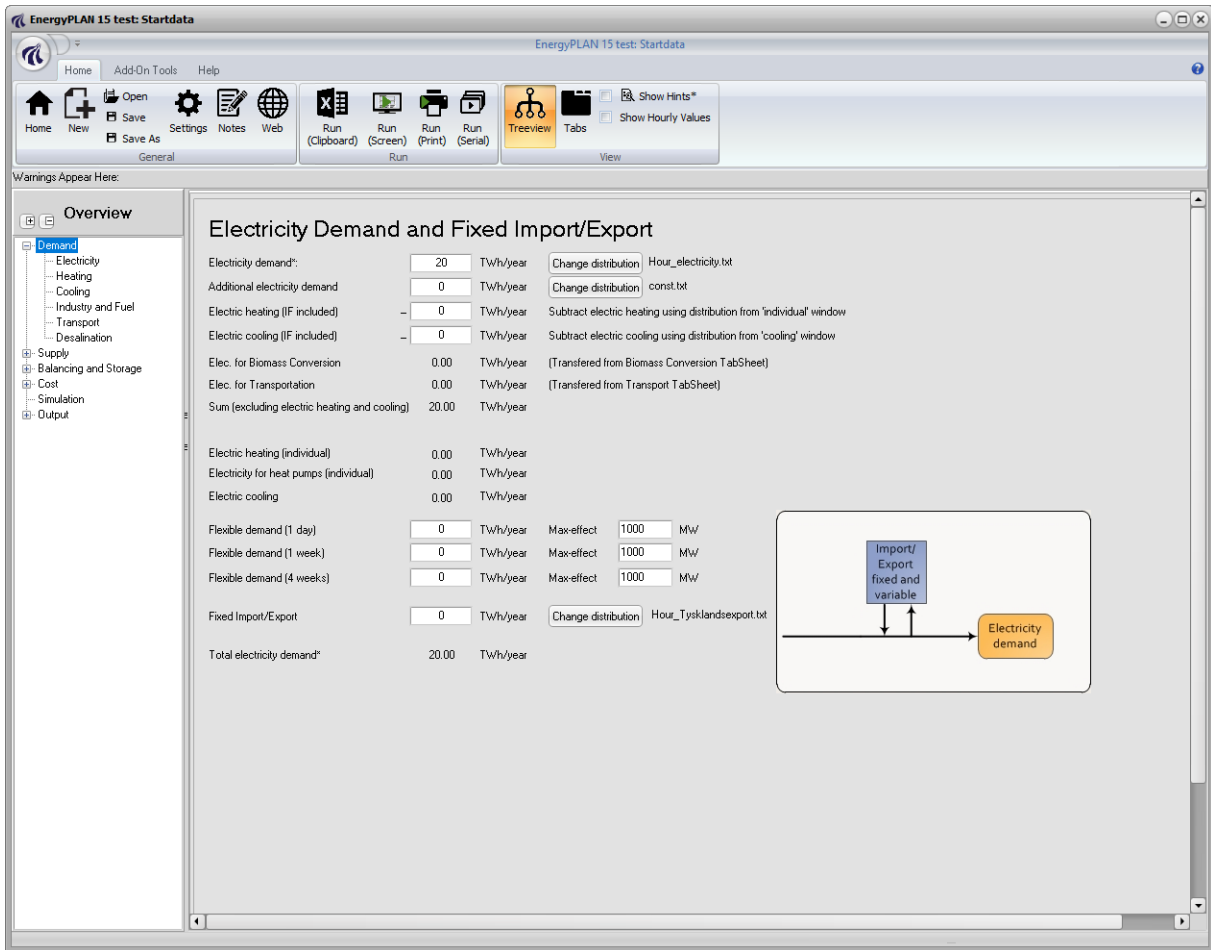

2.3. Add-On Tools

The EnergyPLAN model (version 10 and onwards) has been prepared for the inclusion of “Add-On Tools” to assist in the handling of data, distribution files, etc., as well as other sorts of assistance. Different help tools are in the process of being developed, but are not ready to be released yet. However, the following function can still be used to include any tools on request of the individual user.

One must define a directory called /energyPLAN Tools/ located next to the EnergyPLAN.exe file and the /energyPlan Data/ directory.

Any execute file which is put into the /energyPlan Tools/ directory will now be shown with an icon in the upper left corner of the EnergyPLAN model and can be activated from the ‘Add-On Tools’ ribbon (see below).

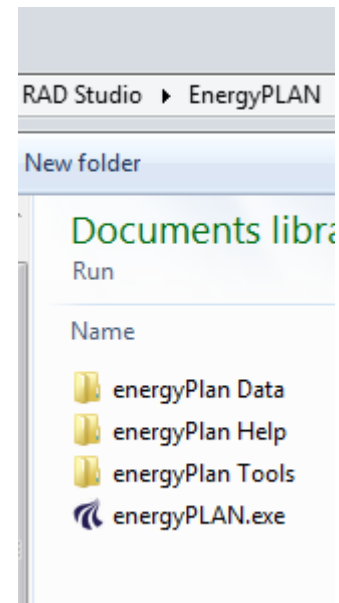

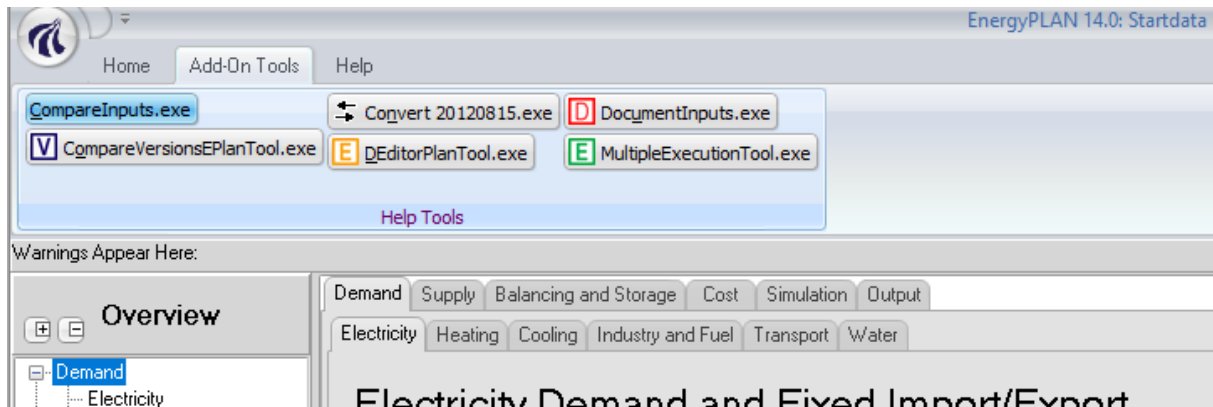

2.4. Help

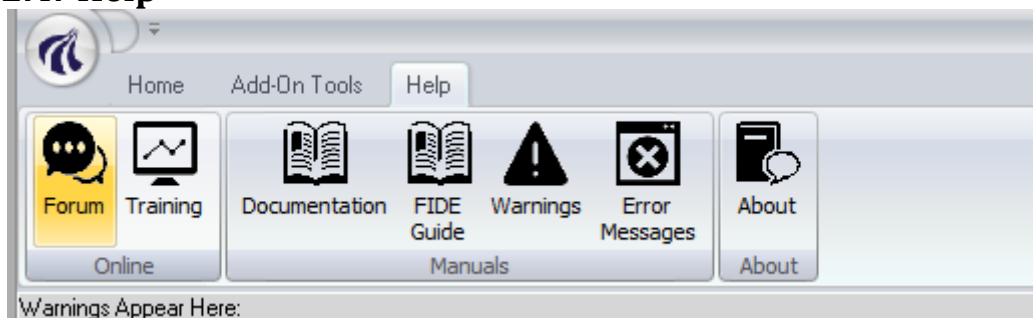

The Help window contains a variety of links to the EnergyPLAN website and to the documentation provided with EnergyPLAN. In the first group, there are links to the forum, training, and landing page of the EnergyPLAN website.

The Manuals group contains links to the:

- Documentation, which is this document)
- FIDE guide, which explains how to find and input data into EnergyPLAN
- Warnings documentation, which explains the warnings that highlight potential problems to the user
- Error Messages documentation, which describes common errors that can occur in EnergyPLAN, mostly relating to data that is inputted incorrectly

3. Libraries and settings

The model is organised as an executable file and a data directory including three libraries: Data, Distributions and Cost. The three data directories are sub-directories to “energyPlan Data”. Additional to the “energyPlan Data” folder, there is also an “energyPlan Help” and an “energyPlan Tools” directory as illustrated in section 2.3.

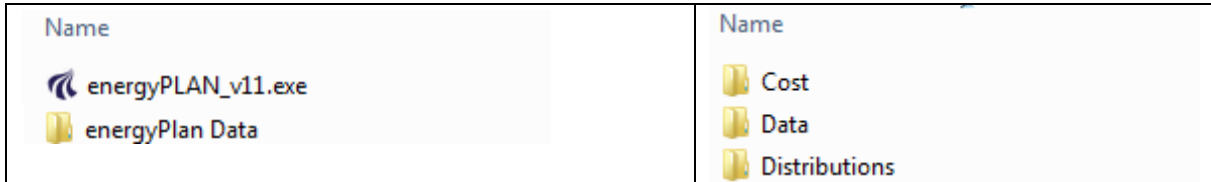

The Data Library holds input data set and the Distribution Library contains hourly distribution files. The Cost Library includes data sets of investment and fuel costs. The Cost data is part of the input data set. However, the Cost data allow a quick shift or replacement of investment and fuel cost data without changing the rest of the input. Whenever one chooses to save or load “input data”, all input data including costs data will be handled. However, when one chooses to save or load “cost data”, only investment and fuel cost data are included.

3.1. Input data set

The EnergyPLAN model always holds sufficient input data for doing a calculation. Moreover, the model controls if new input data meet the standards. If not they will be rejected.

When the programme is started, the model automatically defines a set of input data, called “Startdata”. The input data set can be saved and stored in the Data Library. Stored data sets can be read into the model. In the upper left corner, the model shows the name of the present data set (see below).

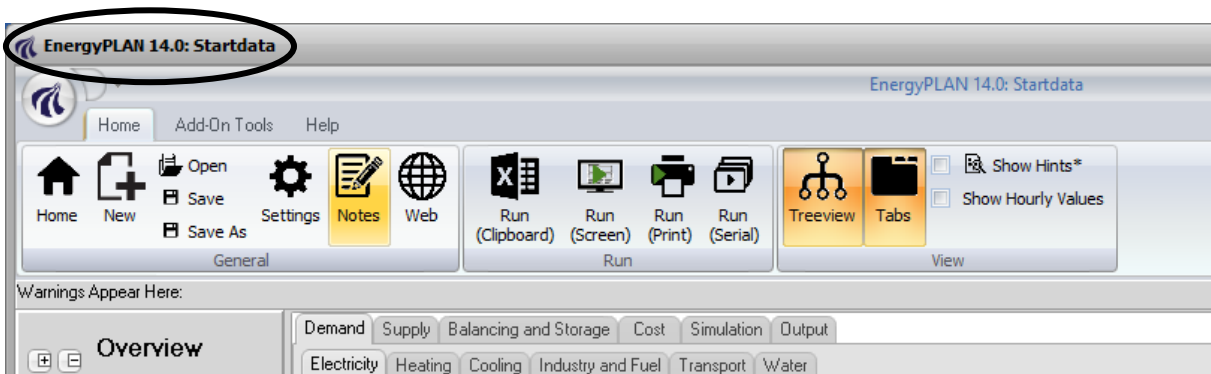

3.1.1. Open an input data set from the Library

To open an input data set from the Library, activate the open button  in the upper left corner.

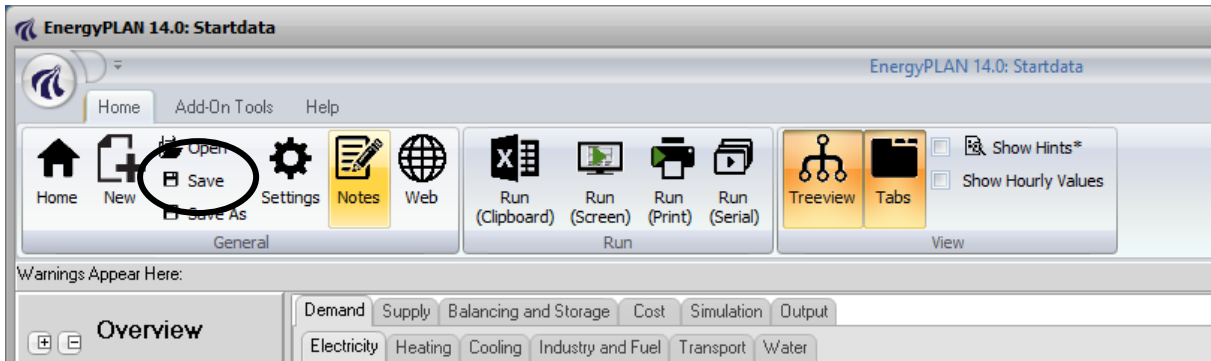

The following tab sheet will open, in which one can choose between stored input data sets:

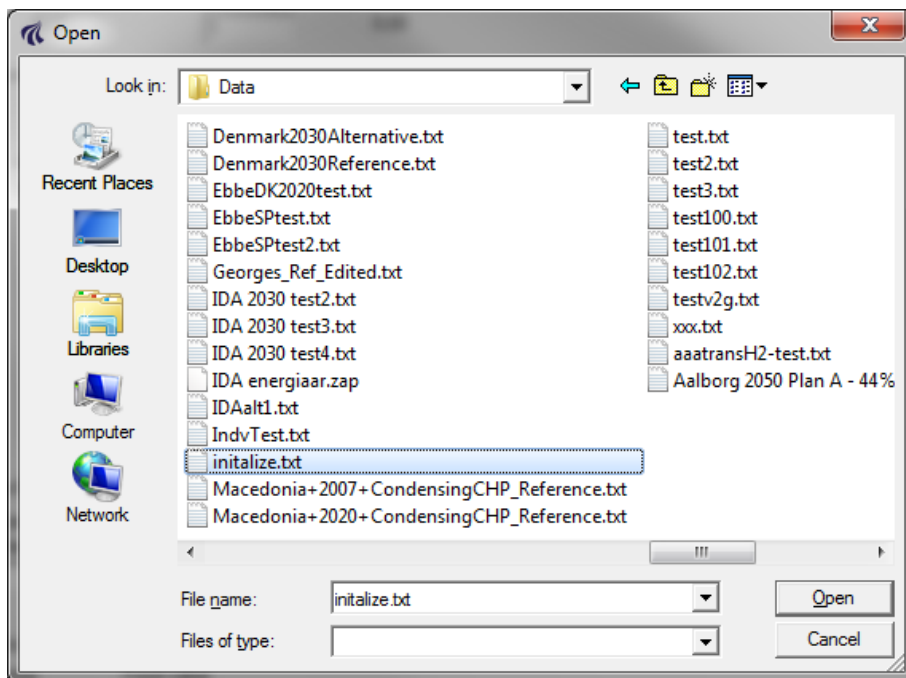

3.1.2. Defining a new input data set and storing it in the Library

To define a new input data name and save present input data in the Library, activate the open button  in the upper left corner.

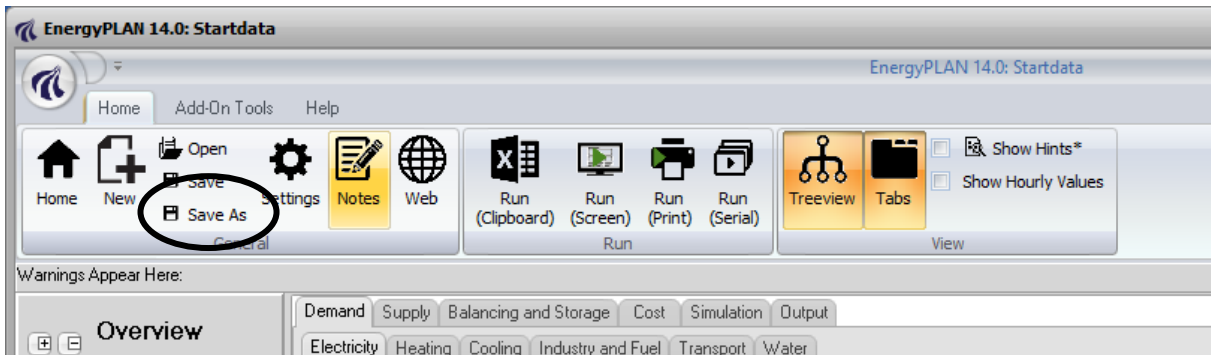

The following tab sheet will open, in which one can define the name of the data set, e.g., “Example”:

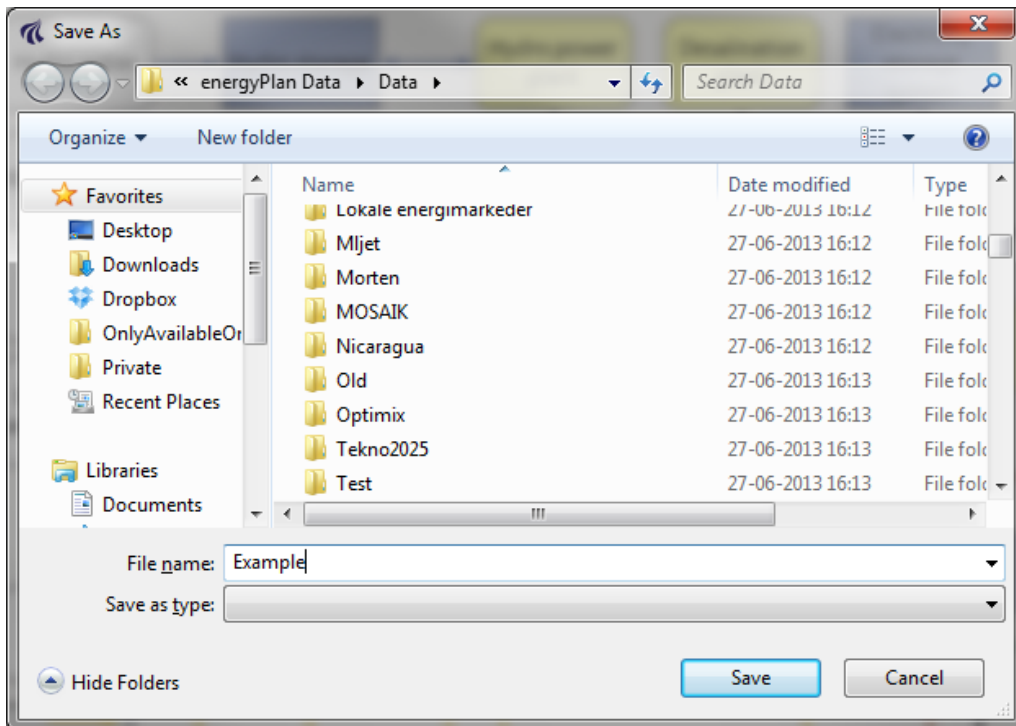

After storing the data set, the new name will appear in the upper left corner:

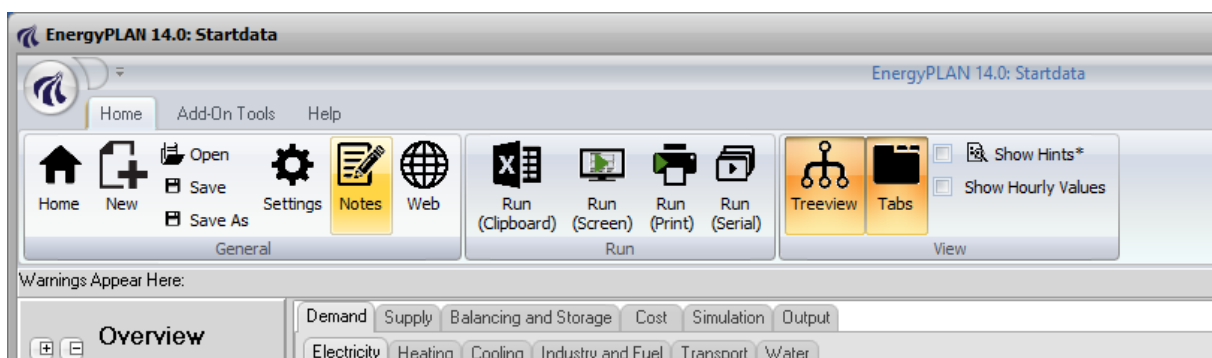
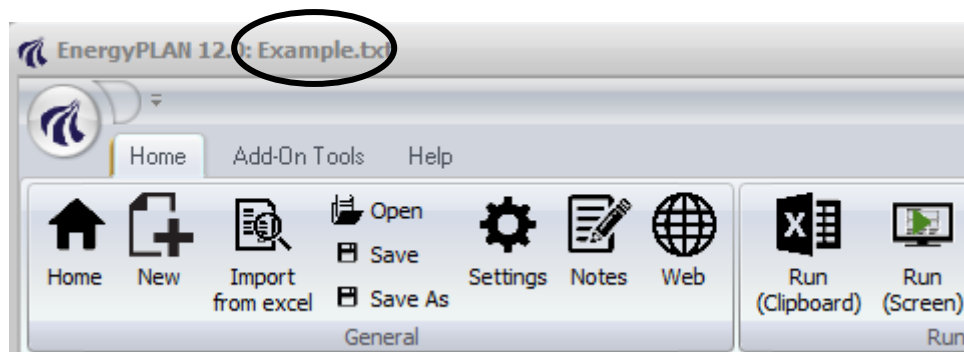

3.1.3. Saving the present input data set in the Library

To save the present input data set (replace present data under the same name), activate the  button in the upper left corner.

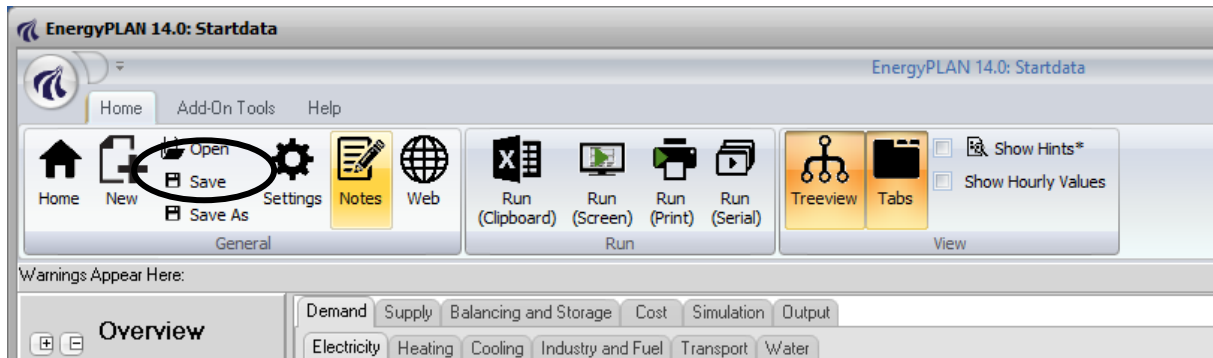

3.2. Distribution

Typically, energy demands and renewable resources, etc., are defined in the model by an annual value and a distribution name from the Distribution Library.

Distributions in the Library are stored as text files and consist of 8784 hour values presented on 8784 lines. New distributions have to meet this format.

For price distributions, the 8784 numbers are absolute. For demands, all values are relative and will relate to the specified annual value. For renewable energy sources, distribution is relative to the specified capacities.

Distributions are defined by their name, and such names are part of the input data set. When the model is started, names are defined for all distributions. However, one can easily change from one distribution to another in the Library.

3.2.1. Change distribution

The model shows the name of the present distribution; here illustrated by the electricity demand:

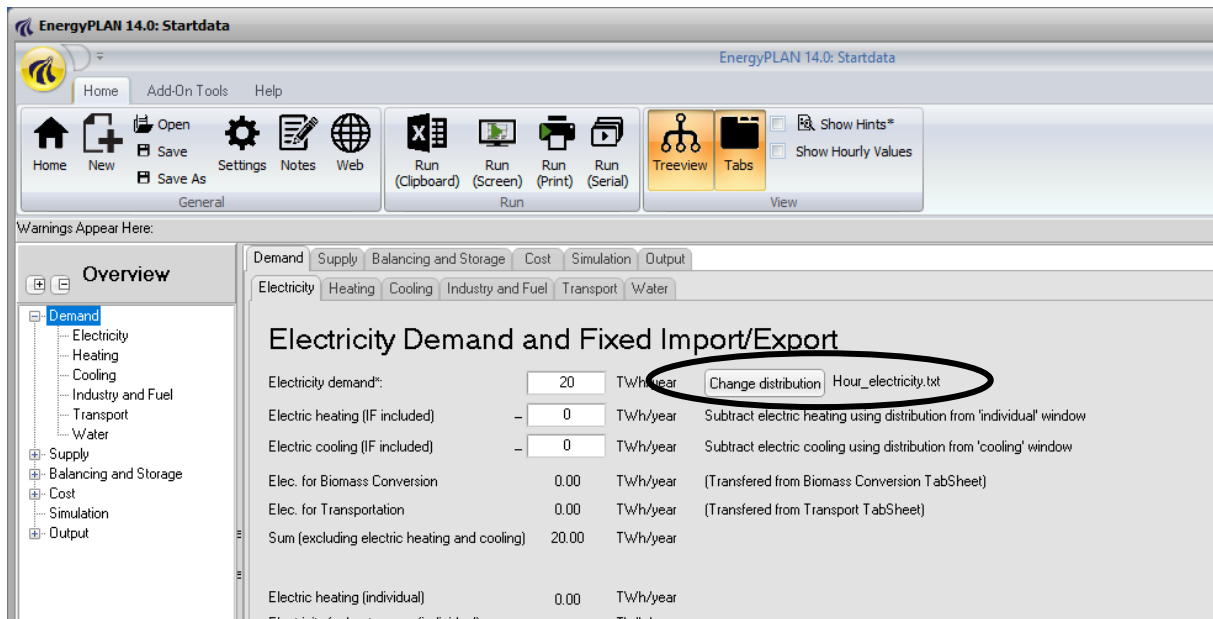

To change distribution, simply activate the **Change distribution** button and the following tab sheet will open:

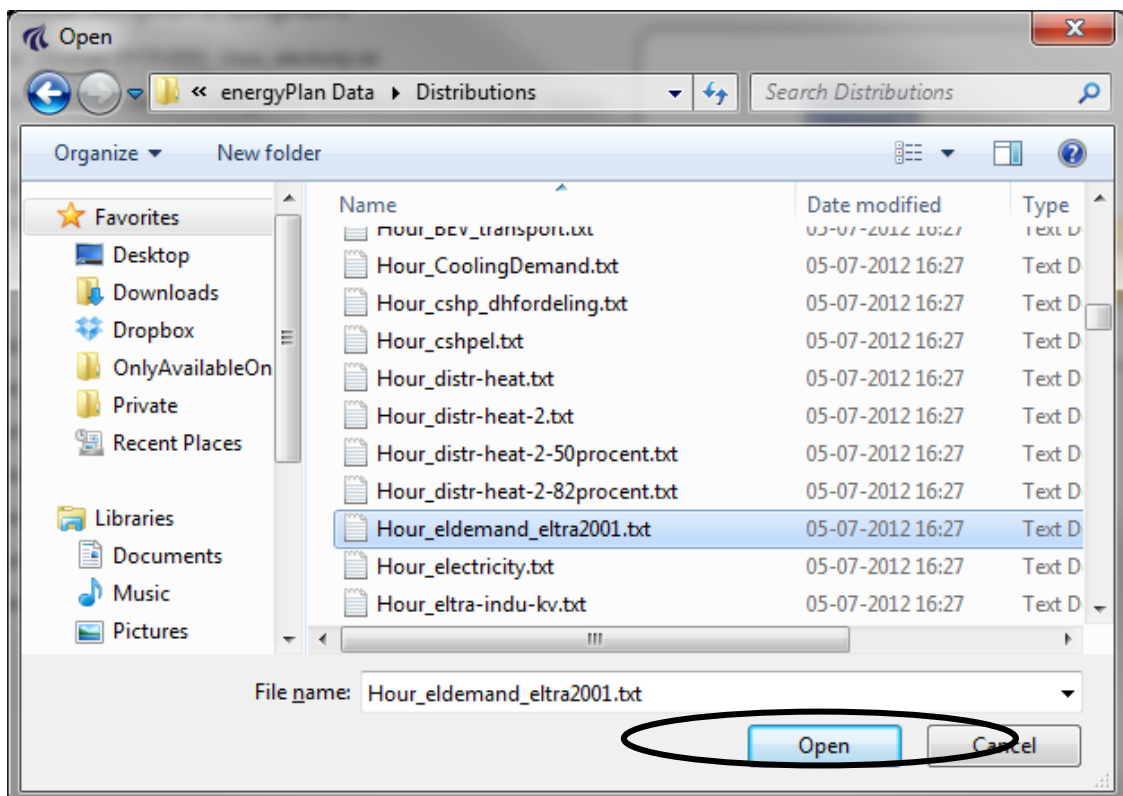

Here, one can choose a new distribution, which will then be shown in the input tab sheet.

3.2.2. Define new distributions

New distribution data can be added to the Library, simply by producing a text file with 8784 numbers. Distributions in the Library are stored as text files and consist of 8784 hourly values presented on 8784 lines. New distributions have to meet this format.

If the message shown below appears it is very often because one of the distribution files does not meet the required format, i.e., typically it does not contain 8784 values but only 8760. Or it has too many values.

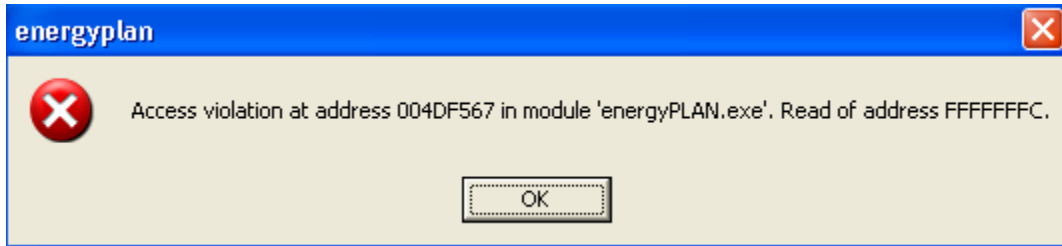

Or if one of the values contains letters instead of numbers, the following message will appear.

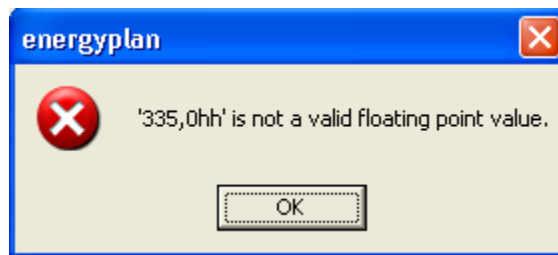

One fast way of making a new distribution is to open an existing file in the Distribution Library by using the pathfinder. Then, change the data and save under a new name. One can mark all data and load the data into, e.g., Excel and change them. Or one can simply replace them with a new set of data.

In the diagram below, the first part of a distribution file opened in Notesblok (notepad) is shown.

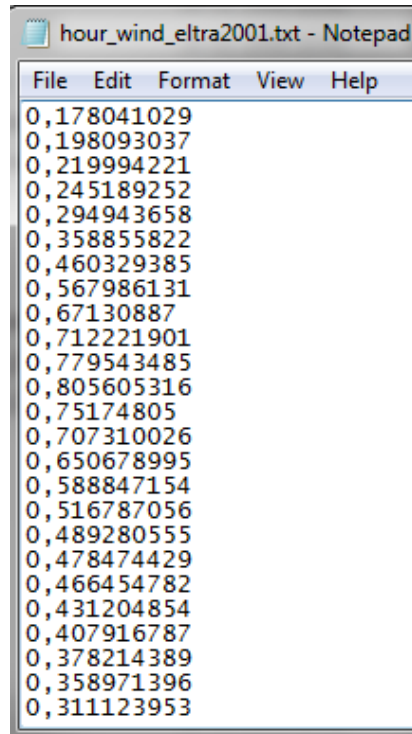

```
hour_wind_eltra2001.txt - Notepad
File Edit Format View Help
0,178041029
0,198093037
0,219994221
0,245189252
0,294943658
0,358855822
0,460329385
0,567986131
0,67130887
0,712221901
0,779543485
0,805605316
0,75174805
0,707310026
0,650678995
0,588847154
0,516787056
0,489280555
0,478474429
0,466454782
0,431204854
0,407916787
0,378214389
0,358971396
0,311123953
```

In order to provide information of the source of specific data, one may add some lines in the beginning of the distribution file. Such lines will have to start with the sign “/” as shown below. One may add as many lines as one wish.

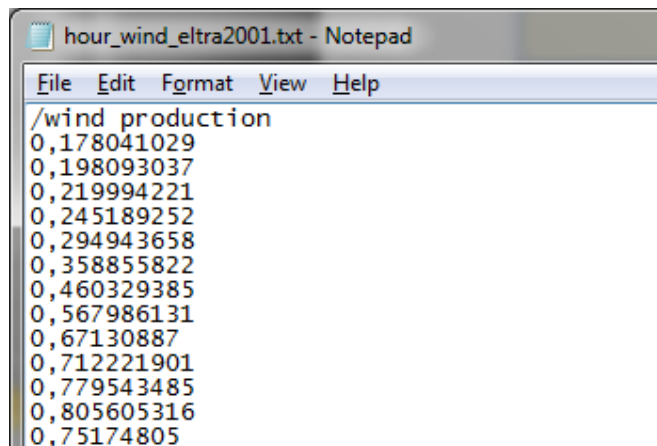

```
hour_wind_eltra2001.txt - Notepad
File Edit Format View Help
/wind production
0,178041029
0,198093037
0,219994221
0,245189252
0,294943658
0,358855822
0,460329385
0,567986131
0,67130887
0,712221901
0,779543485
0,805605316
0,75174805
```

3.2.3. Existing data in the Library

The model Library already includes a long list of distribution data, among others: Typical Danish electricity demand (year 2000), typical Danish district heating demand, distribution of photovoltaic and solar thermal power, distribution of industrial CHP, different wind years: 1996, 2000 and 2001, and distribution of Nord Pool prices between the different years from 2000 to 2006. Four of the hourly distribution data sets are illustrated in the diagram below.

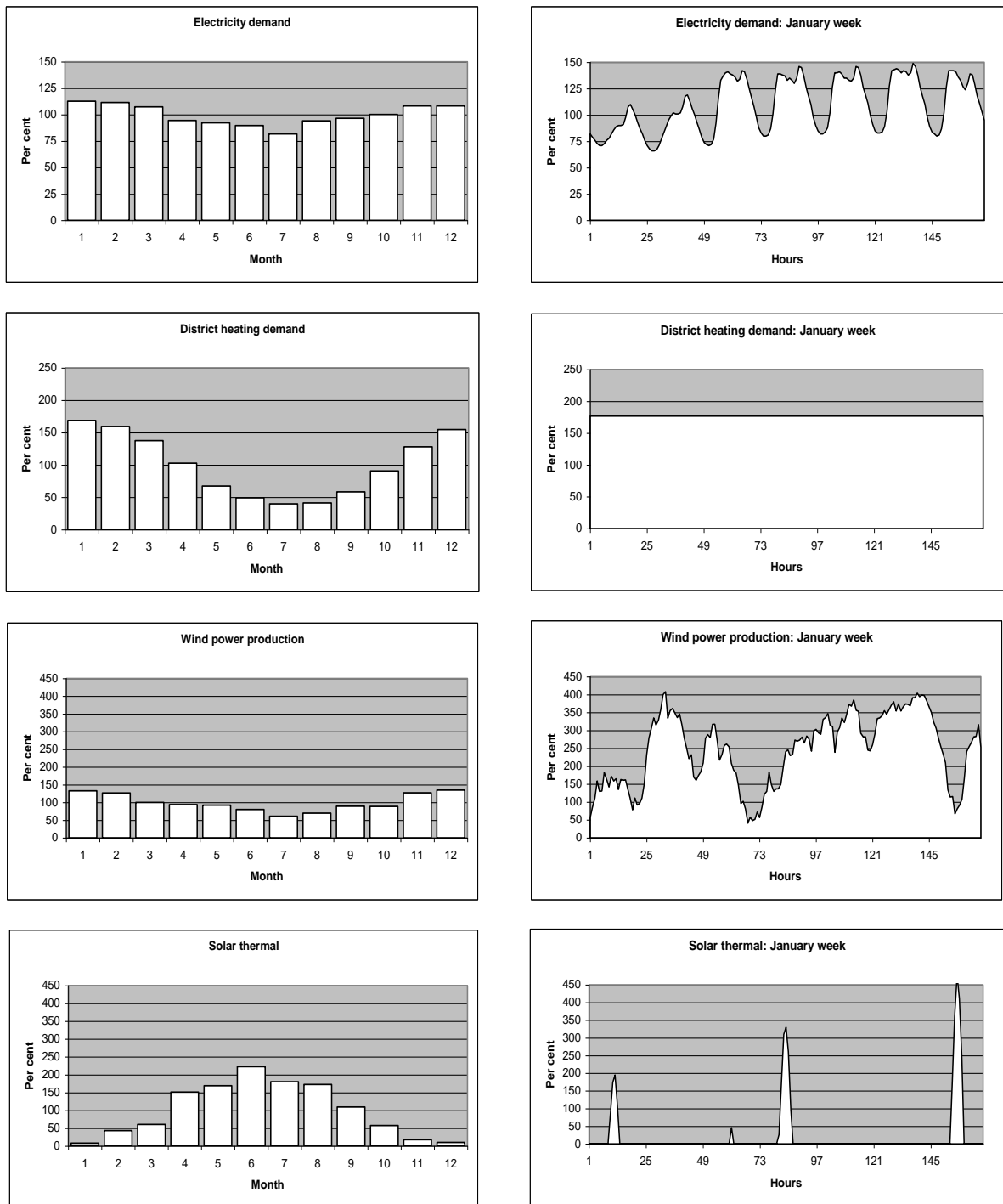
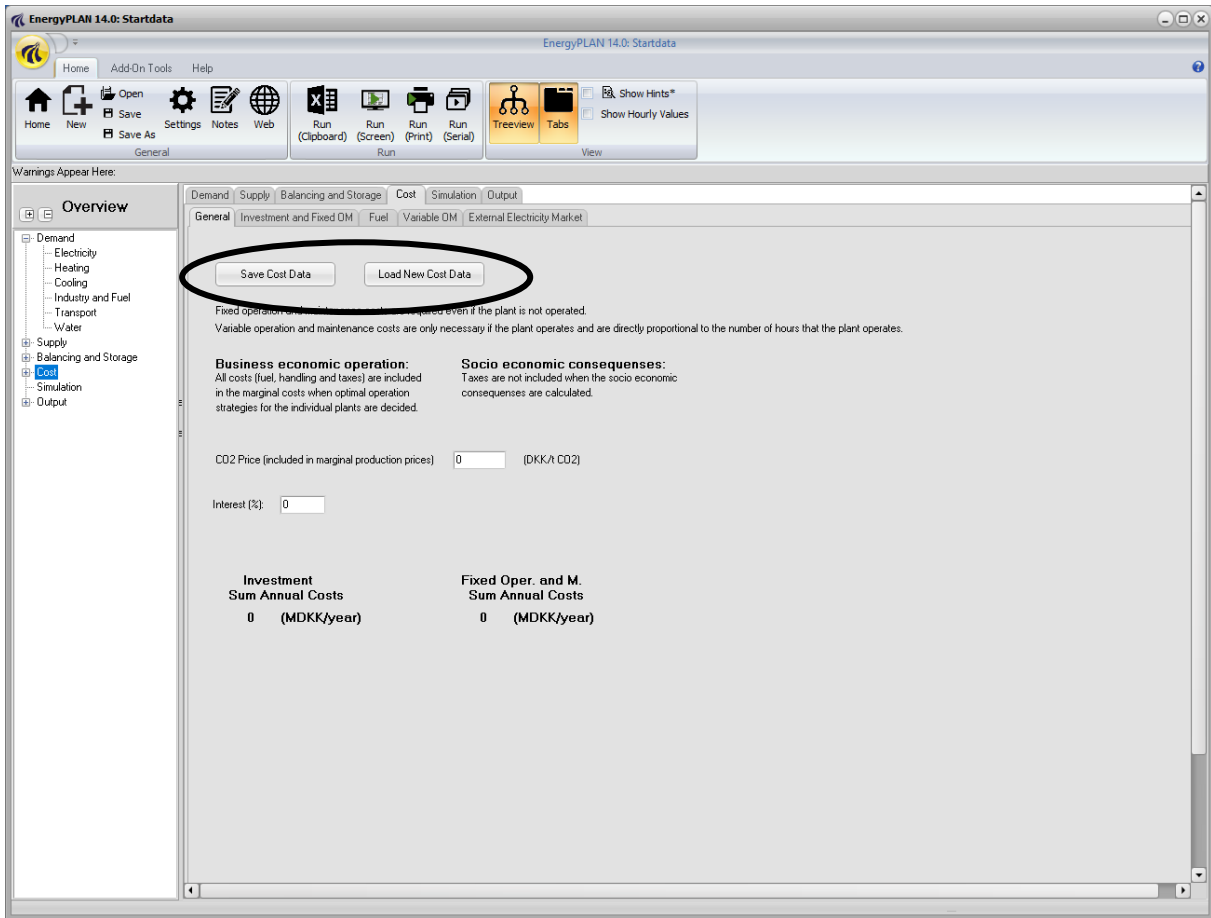

Diagram 3: Four examples of internal model data sets: Electricity demand, district heating demand, wind power production (one out of three possible), and solar heating thermal. To the left, the annual distribution on months is shown, and to the right, an example of one week of January is presented.

3.3. Cost database

To save or load Cost Data, one has to go to the Cost Additional tab sheet and activate one of the two buttons “Save Cost Data” or “Load New Cost Data”.



When activating one of these buttons, the following tab sheet will show and one can either read new data or load present data in the same way as for input data.

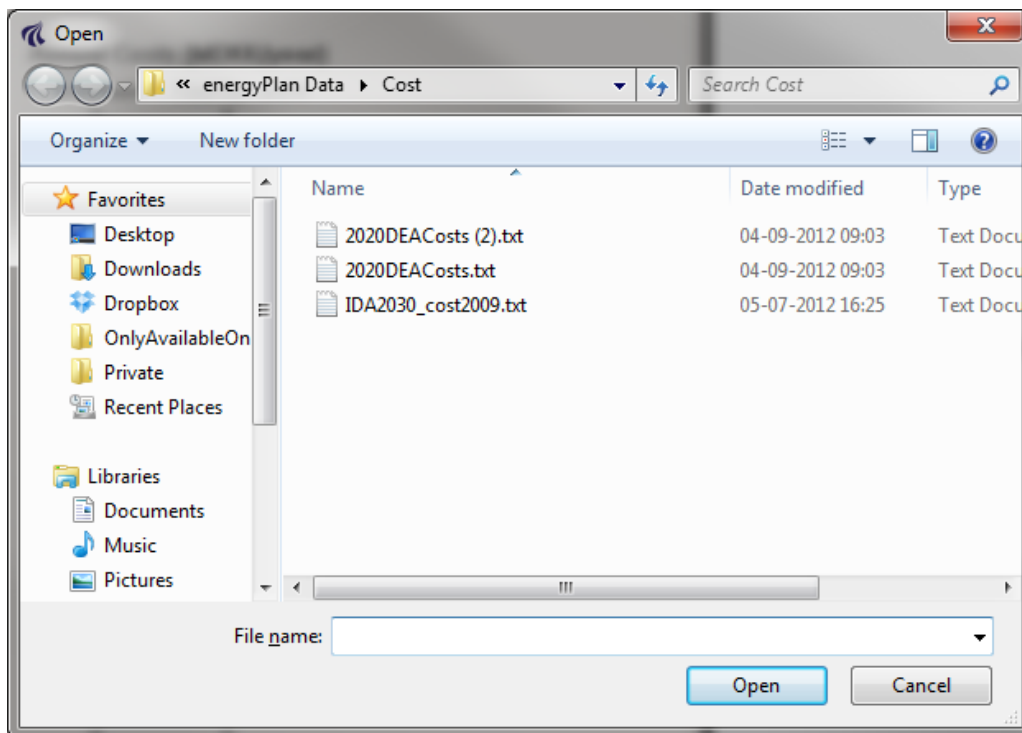

3.4. Settings

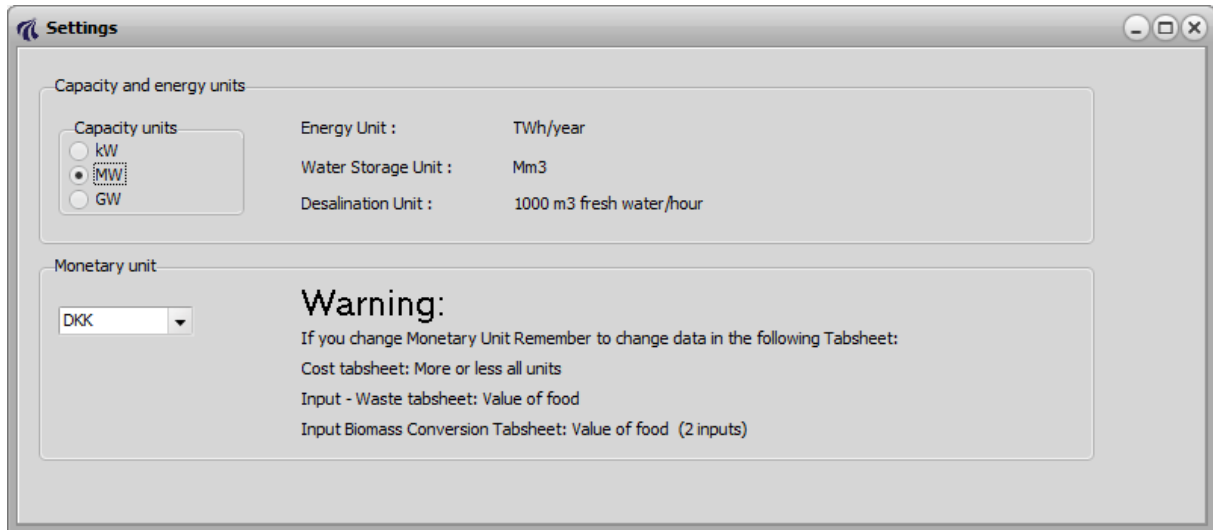

In the settings tab sheet, one can define the energy units and monetary units.

Note: No input or output numbers will be changed by activating the button. Only the writing of units in the tab sheets and on the printed pages is changed.

The energy/capacity units can be changed by selecting between the following combinations:

- kW and GWh/year
- MW and TWh/year
- GW and PWh/year

4. Energy System Definition (Inputs)

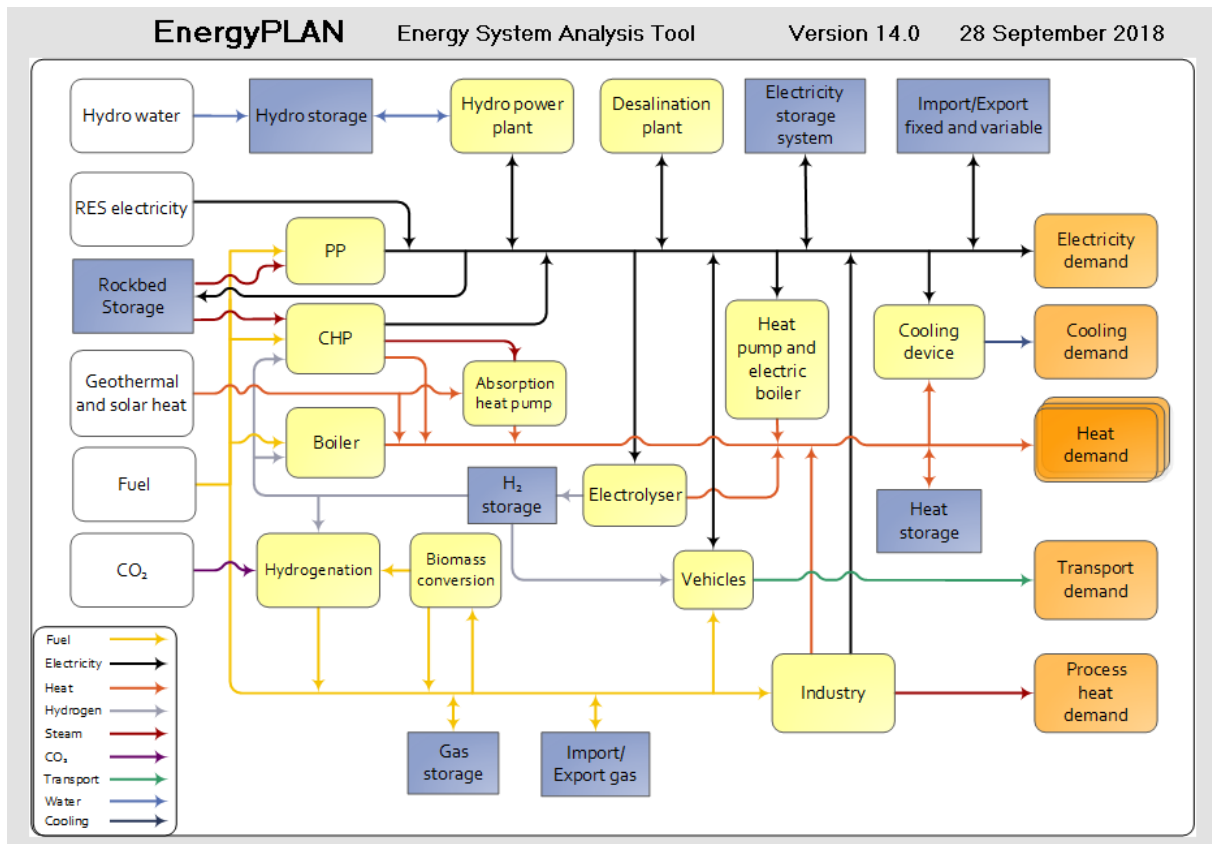

As shown in the diagram, the EnergyPLAN model consists of the following overall structure components: Demand, Supply, Balancing and Storage, Cost, Simulation and Output.

Inputs are defined by the user in the following: Demand, Supply, Balancing and Storage, and Cost. In the following, each of these sections is described, including a description of input definitions and initial calculations. Initial calculations are done simultaneously with the changing of inputs.

Any energy system analysis - technical as well as market-economic - requires data in the "Demand" and "Supply" sections. In a technical system analysis, the model does not require other inputs. But in the case of a market-economic simulation or if a feasibility study is conducted, further inputs are required in the "cost" section.

By doing exercises and following the guidelines to the EnergyPLAN model, one can learn step by step how to define relevant input data. Both exercises and guidelines can be found on www.EnergyPLAN.eu.

4.1. Demand

The demands in the energy system are defined under the various different tabsheets of the 'Demand' tabsheet. In some cases, where it is necessary from a pedagogical perspective, the supply is also included in some of the demand tabsheets. However, this is avoided as much as possible.

4.1.1. Electricity

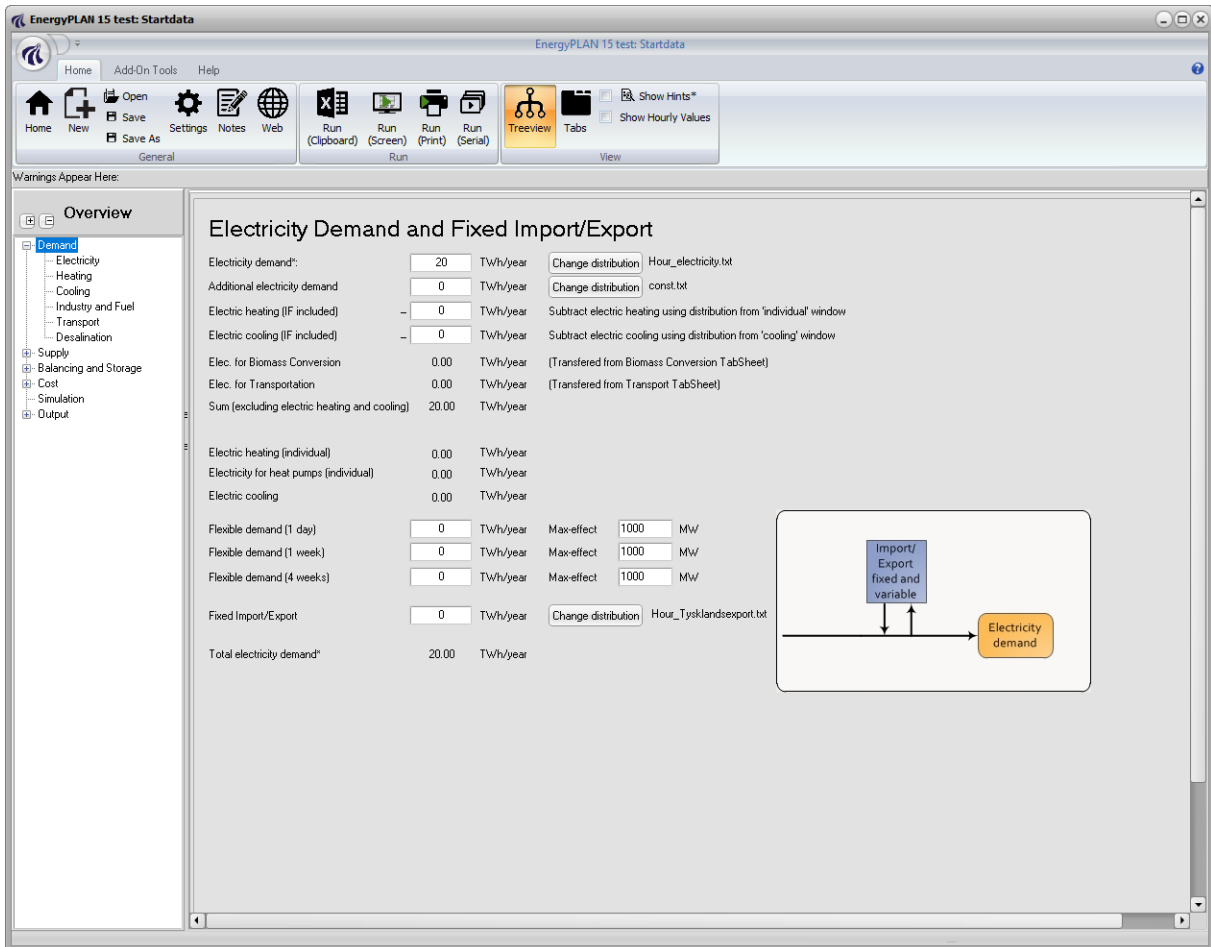

Inputs

- D_E = Annual electricity demand
- D_{EA} = Additional annual electricity demand
- D_{EH} = Annual electricity demand for cooling (defined in the input tab sheet "Cooling")
- D_{EC} = Annual electricity demand for heating (defined in the input tab sheet "Individual")
- D_{EX} = Annual electricity demand of fixed exchange (Fixed import/export)
- D_{FXDay} = Annual electricity demand flexible within 1 day
- D_{FXWeek} = Annual electricity demand flexible within 1 week
- $D_{FX4Week}$ = Annual electricity demand flexible within 4 weeks
- C_{FXDay} = Max capacity of 1-day flexible demand
- C_{FXWeek} = Max capacity of 1-week flexible demand
- $C_{FX4Week}$ = Max capacity of 4-week flexible demand

The electricity demand is defined by an annual value, D_E (TWh per year) and the name of an hourly distribution data set. This can be increased by adding an additional demand D_{EA} . And one can also specify a fixed import/export, D_{EX} . Furthermore, one can define various kinds of flexible electricity demands, D_{FXDay} , D_{FXWeek} and $D_{FX4Week}$ in combination with maximum capacity values. Electricity

demands for electric heating and cooling (specified in the “cooling” and the “individual” tab sheets) are shown, and help functions make is possible to subtract such demands from the electricity demand.

4.1.1.1. Input tab sheet calculation of electricity demand

If the electricity demand contains an electric heating or cooling demand, such demand (D_{EH} and D_{EC}) can be defined and will be subtracted from the electricity demand hour by hour:

$$d_E' = d_E - d_{EH} - d_{EC}$$

$$\text{if } d_E' < 0 \text{ then } d_E' = 0$$

$$D_E' = \sum d_E'$$

If such electric heating or cooling demands are specified, the new electricity demand, D_E' , will be used subsequently as input to the energy system analysis.

4.1.2. Heating

The screenshot displays the EnergyPLAN 14.0: Startdata software interface. The main window shows the 'Overview' tab with a summary of heating demands and a detailed table for individual heating systems. To the right, a flow diagram illustrates the energy conversion and distribution processes.

Summary Data:

- Total Heat Demand*: 17.50
- Demand Per Building*: 15000 kWh/year
- Indv. heated households: 0 1000 Units

Individual Heating Table:

Distribution:	Fuel Input	Efficiency Thermal	Heat Demand	Efficiency Electric	Capacity Limit	Estimated Electricity Production	Solar Thermal		Resulting Fuel Consumption*
							Heat Storage*	Share*	
Coal boiler:	0	0.7	0.00			0	1	0	0.00
Oil boiler:	0	0.8	0.00			0	1	0	0.00
Ngas boiler:	0	0.9	0.00			0	1	0	0.00
Biomass boiler:	0	0.7	0.00			0	1	0	0.00
H2 micro CHP:	0.5	0	0.3	1	0.00	0	1	0	0.00
Ngas micro CHP:	0.5	0	0.3	1	0.00	0	1	0	0.00
Biomass micro CHP:	0.5	0	0.3	1	0.00	0	1	0	0.00
Heat Pump:	0	3	1	0.00	0	0	1	0	0.00
Electric heating:	0			1	0.00	0	1	0	0.00
Total Individual:			0.00		0.00				0.00

District Heating Table:

	Group 1:	Group 2:	Group 3:	Total:	Distribution:
Production:	0	10	10	20.00	Change
Network Losses:	0.2	0.15	0.1		Hour_distr-heat.bt
Heat Demand:	0.00	8.50	9.00	17.50	

The flow diagram on the right shows various energy sources (Coal, Oil, Ngas, Biomass, H2, Electricity) feeding into different conversion technologies (Boiler, CHP, Electric boiler, Heat pump). These technologies then feed into heat storage units, which finally supply heat to meet the demand.

Input

Individual boilers, CHP, heat pumps and electric heating

F_{M-Coal} , F_{M-Oil} , F_{M-Ngas} , F_{M-bio} = Annual fuel demands for individual boilers

ρ_{M-coal} , ρ_{M-Oil} , ρ_{M-Ngas} , ρ_{M-bio} = Thermal efficiencies of individual boilers

$H_{M-H2CHP}$, $H_{M-NgasCHP}$, $H_{M-BioCHP}$ = Annual heat demands of micro CHP on H2, natural gas and biomass.

$\mu_{M-H2CHP}$, $\mu_{M-NgasCHP}$, $\mu_{M-BioCHP}$ = Efficiencies (electric) of micro CHP on H2, natural gas and biomass.

$\rho_{M-H2CHP}$, $\rho_{M-NgasCHP}$, $\rho_{M-BioCHP}$ = Efficiencies (thermal) of micro CHP on H2, natural gas and biomass.

H_{M-HP} , H_{M-EH} = Annual heat demand of heat pumps and electric heating in individual houses

ϕ_{I-HP} = COP of heat pumps in individual houses

$LIMIT_{M-H2CHP}$, $LIMIT_{M-NgasCHP}$, $LIMIT_{M-BioCHP}$, $LIMIT_{I-HP}$ = Capacity Limit of CHP and HP (between 0 and 1)

Solar thermal and heat storage

$Q_{Solar-M-coal}$, ..., $Q_{Solar-M-bio}$ = Annual heat production from solar thermal in individual boiler systems.

$Q_{Solar-M-H2CHP}$, ..., $Q_{Solar-M-bioCHP}$ = Annual heat production from solar thermal in individual CHP systems.

$Q_{Solar-M-HP}$, $Q_{Solar-M-EH}$ = Annual heat production from solar thermal in individual HP and EH systems.

$SHARE_{Solar-M-coal}$, ..., $SHARE_{Solar-M-EH}$ = Share of individual houses with solar thermal in various systems.

$SH_{Solar-M-coal}$, ..., $SH_{Solar-M-EH}$ = Capacity, Heat storage for solar thermal in various systems

District heating production and demands

Q_{DH1} , Q_{DH2} , Q_{DH3} = Heat production in district heating group 1, 2, and 3

ρ_{DH1} , ρ_{DH2} , ρ_{DH3} = District heating losses for district heating group 1, 2, and 3 (% of production)

H_{DH1} , H_{DH2} , H_{DH3} = Heat demand in district heating group 1, 2, and 3

Inputs to individual houses are basically defined as fuel inputs, since such figures are normally basic data in statistics. When defining the efficiencies of boilers, heat demands are calculated. Electric heating is defined as electricity consumption. The same hourly distributions are used for all heat demands.

To include CHP and heat pumps, one must define heat demands and efficiencies. Moreover, one may define capacity limits in the CHP and heat pump units in terms of shares of the maximum heat demand (figures between 0 and 1). If such limits are defined, the peak heat demands will be met by boilers using the same efficiencies as defined for the boiler-only systems. In the case of H2, the efficiency of the natural gas boiler is used; and in the case of heat pumps, electric heating is used.

Moreover, one can add solar thermal power to all the systems by defining the annual solar production and the share of heat demand based on solar thermal power. For all solar thermal productions, the same hourly distributions are used.

The district heating demands, H_{DH1} , H_{DH2} , H_{DH3} , are calculated by multiplying the district heating production by the annual losses in the district heating network, which are expressed as a percentage of total district heating production. For example,

$$H_{DH1} = Q_{DH1} * (1 - \rho_{DH1})$$

4.1.2.1. Input tab sheet calculation of heat demands in individual houses

The resulting heat demands in the individual houses serve as input to the micro CHP and heat pump systems. For the boiler-only systems, the heat demands are calculated simply as the fuel input multiplied by the boiler efficiencies:

$$H = F / \rho$$

4.1.2.2. Input tab sheet calculation of solar thermal production in individual houses

Solar production is, in principle, calculated in the same way as solar thermal production in district heating. If the solar production at one hour exceeds the demand, the excess production is stored if possible, and if not, the excess production is perceived as lost. When the solar production is lower than the demand the model seeks to empty the storage. The same calculation methodology is used as in section 4.2.4.1.

4.1.2.3. Input tab sheet calculation of boilers, CHP and heat pumps in individual houses

The **heat demand** for solar production is supplied by boilers, micro CHPs and heat pumps. The production in the boilers-only systems is simply calculated as the difference between the demand and the solar production (including the use of the heat storage):

$$q_{M-Oil} = h_{M-Oil} - q'_{Solar-M-Oil}$$

For the micro CHP and the heat pump, the production cannot exceed the limitations on capacity, if any.

$$q_{M-NgasCHP} = h_{M-NgasCHP} - q'_{Solar-M-NgasCHP}$$

$$\text{If } q_{M-NgasCHP} > \text{Max}(h_{M-NgasCHP}) * \text{LIMIT}_{M-NgasCHP} \text{ then } q_{M-NgasCHP} = \text{Max}(h_{M-NgasCHP}) * \text{LIMIT}_{M-NgasCHP}$$

The heat demand remaining after coverage by solar (including the use of storage), CHP and heat pumps is met by boilers and, in the case of heat pumps, by electric heating:

$$q_{M-H2CHP-Boiler} = h_{M-H2CHP} - q'_{Solar-M-H2CHP} - q_{M-H2CHP}$$

$$q_{M-NgasCHP-Boiler} = h_{M-NgasCHP} - q'_{Solar-M-NgasCHP} - q_{M-NgasCHP}$$

$$q_{M-BioCHP-Boiler} = h_{M-BioCHP} - q'_{Solar-M-BioCHP} - q_{M-BioCHP}$$

$$q_{M-HP-EH} = h_{M-HP} - q'_{Solar-M-HP} - q_{M-HP}$$

The **fuel demands** for all boiler systems are calculated and shown in the input tab sheet (Here shown for the oil boiler):

$$f_{M-Oil} = q_{M-Oil} / \rho_{M-Oil}$$

The fuel demands for the three CHP systems (here shown for the Ngas system) are calculated individually for the CHP unit and the peak load boiler, respectively.

$$f_{M-NgasCHP} = q_{M-NgasCHP} / \rho_{M-NgasCHP}$$

$$f_{M-NgasCHP-Boiler} = q_{M-NgasCHP-Boiler} / \rho_{M-Ngas}$$

The total fuel demand, $F_{M-NgasCHP-Total}$, is found by adding the two demands:

$$f_{M-NgasCHP-Total} = f_{M-NgasCHP-Boiler} + f_{M-NgasCHP}$$

The **electricity production** from CHP is calculated as follows:

$$e_{M-NgasCHP} = f_{M-NgasCHP} * \mu_{M-NgasCHP}$$

The total **electricity consumption** from heat pumps, $D_{I-HP-Total}$, is calculated as follows:

$$d_{M-HP-EH} = q_{M-HP-EH}$$

$$d_{M-HP} = q_{M-HP} / \phi_{M-HP}$$

$$d_{M-HP-total} = d_{M-HP-EH} + d_{M-HP}$$

The electricity demand for electric heating is calculated like this:

$$D_{M-EH} = q_{M-EH}$$

The resulting total fuel consumption and electricity production (and consumption) are shown in the input tab sheet for all systems. So is the resulting solar production.

4.1.2.4. Input tab sheet calculation of Electrolysers for micro H2 CHP systems

If a heat demand is specified for the micro H2 CHP system, then the minimum electrolyser capacity required to provide the necessary hydrogen is calculated. The electrolysers must be added to the system in the Input Hydrogen tab sheet. If hydrogen storage is specified in the Input Hydrogen tab sheet, then such storage capacity is taken into account. The minimum electrolyser capacity, $C_{ELC-MIN}$, is calculated in the following way:

First, the hydrogen production of the electrolyser, f_{ELcM} , is defined as the average hydrogen consumption of the micro CHP system, $f_{M-H2CHP-Average}$:

$$f_{ELcM} = f_{M-H2CHP-Average} = F_{M-H2CHP} / 8784$$

Then for each hour (x), the hydrogen storage content is calculated, $S_{ELcM}(x)$, as the content of the previous hour plus the average production minus the actual consumption of the hour.

$$S_{ELcM}(x) = S_{ELcM}(x-1) + f_{M-H2CHP-Average} - f_{M-H2CHP}(x)$$

If, at one hour, the storage content exceeds the capacity, the production is decreased:

$$\text{If } S_{ELcM} > S_{ELcM} \text{ then } f_{ELcM} = f_{ELcM} - (S_{ELcM} - S_{ELcM})$$

And if the storage content goes below zero, the production is increased:

$$\text{If } S_{ELcM} < 0 \text{ then } f_{ELcM} = f_{ELcM} - S_{ELcM}$$

Due to differences in the storage content at the beginning and at the end of the calculation period, errors may appear in the calculation. To correct these errors, the above calculation seeks to identify a

solution in which the storage content at the end is the same as at the beginning. Initially, the storage content is defined as 50% of the storage capacity. After the first calculation, a new initial content is defined as the resulting content at the end of this calculation.

Finally, the minimum electrolyser capacity, $C_{EIC-MIN}$, is identified as the maximum production needed divided by the fuel efficiency:

$$C_{EIC-MIN} = \text{Hourmax}(f_{EiCM}) / \alpha_{EiCM}$$

The corresponding electricity demand, d_{EiCM} , can also be calculated:

$$d_{EiCM} = f_{EiCM} / \alpha_{EiCM}$$

The electricity demand, d_{EiCM} , forms the basis for the further calculation in section 6.7.1, in which the electrolysers are used for decreasing excess and power-only production in the system.

4.1.2.5. District heating demands

The annual district heating consumption must be stated for each of the three DH groups. A common hourly distribution for all three groups is specified.

4.1.3. Cooling

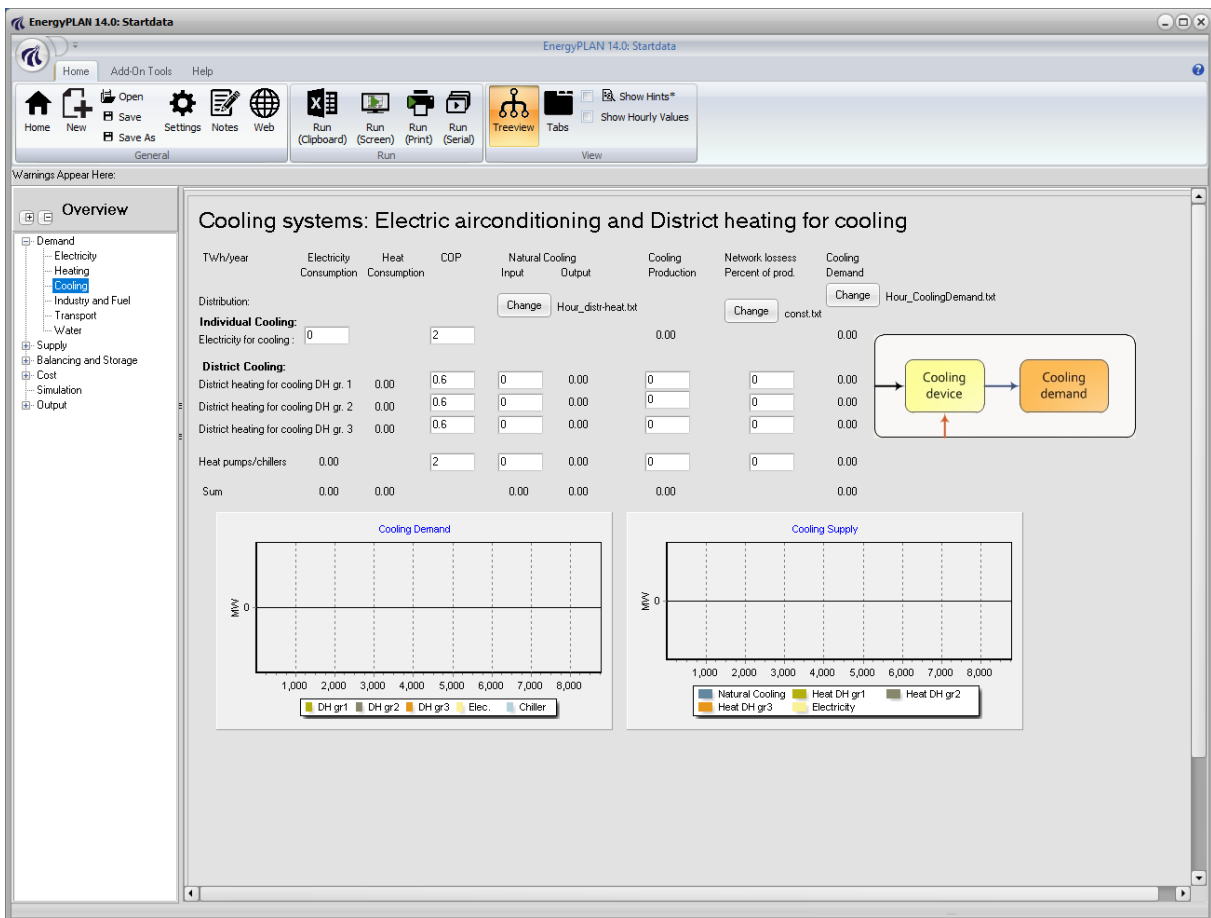

Input

D_{Cool} = Annual electricity demand for cooling

$\phi_{CoolElec}$ = COP of electric cooling.

$C_{Cool1}, \dots, C_{Cool3}$ = Annual demand for cooling in DH groups 1, 2 and 3.

$C_{Natural1}, \dots, C_{Natural3}$ = Annual contribution from natural cooling in DH groups 1, 2 and 3.

$\phi_{Cool1}, \dots, \phi_{Cool3}$ = COP of absorption units in DH groups 1, 2 and 3.

Cooling demands are defined by annual electricity consumption (air-conditioning etc.) and/or by annual cooling consumption (absorption technology). In the latter case, cooling consumption is divided into the 3 district heating groups and requires additional inputs in terms of a COP for the absorption units to be able to calculate the corresponding heat demands. One common hourly distribution is used for all cooling demands.

The electricity demand for cooling is added hour by hour to the other electricity demands. Please, note that a help function in the Input Electricity Demand tab sheet makes it possible to subtract electricity for cooling and heating from the fixed electricity demand.

The heat demands for cooling are added hour by hour to the district heating demands. In principle, this represents a scenario in which the heat can be supplied either by connecting the individual units to the existing district heating systems or by investing in a district cooling grid connected to the district heating production units. Input can also be defined in terms of a COP of the electricity cooling. Such a co-efficient is used in the input tab sheet only to calculate a "Cooling" demand. This function is meant to provide assistance in case one demand is replaced by another; e.g., an air-conditioning electricity demand with a COP of 3 is replaced by a district heating absorption cooling with a COP of 0.6.

The use of heat pumps/chillers in the district cooling grid is also possible to model. This enables the user to model a district cooling grid based on electric cooling and natural cooling in combination.

Further inputs are contributions from "natural cooling", i.e., cooling from rivers or sea waters. The input is given in an annual value for each of the three DH groups, and the heat pumps/chillers group, and a common hourly distribution. In such case, an initial calculation will identify and subtract the potential contribution from natural cooling and calculate the resulting heat demand (h_{Cool}) in the following way:

If $C_{Natural1} > C_{Cool1}$ then $C_{Natural1} := C_{Cool1}$ else $C_{Natural1} := C_{Natural1}$

$$h_{Cool1} = (C_{Cool1} - C_{Natural1}) / \phi_{Cool1}$$

4.1.4. Industry and Fuel

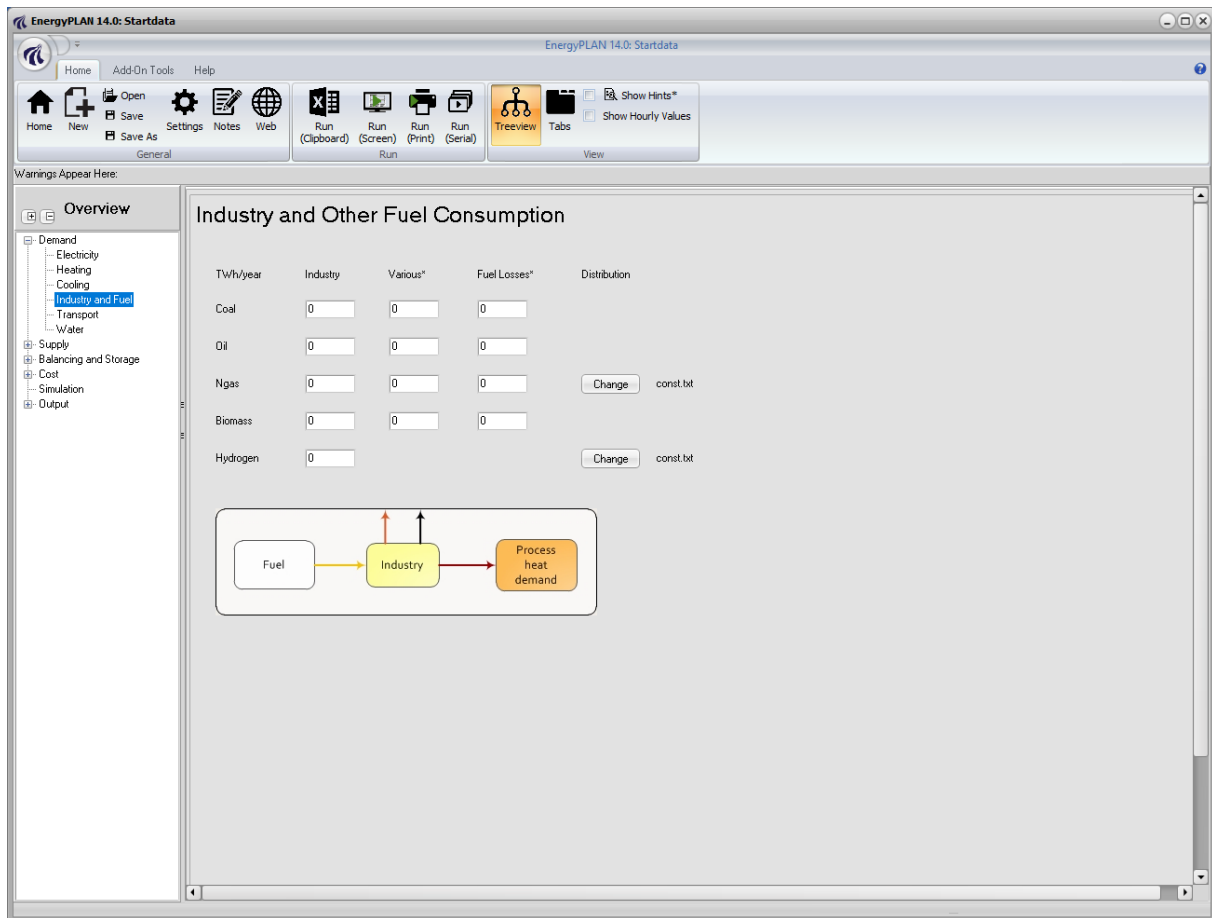

Input

F_{I-Coal} , F_{I-Oil} , F_{I-Ngas} , F_{I-bio} , F_{I-hyd} = Annual fuel demands for Industry
 F_{V-Coal} , F_{V-Oil} , F_{V-Ngas} , F_{V-bio} = Annual fuel demands for Various

Inputs to Industry are basically defined as fuel inputs, since such figures are normally basic data in statistics. Moreover, electricity and excess heat productions from industrial CHP or similar are defined and fed into one of the three district heating groups.

The distribution of natural gas is used only in the calculation of the gas grid hourly balance (See Chapter 8.7)

The amount and distribution of hydrogen is used to calculate the need and operation of electrolyzers as specified in section 4.2.7.3.

4.1.5. Transport

The screenshot displays the EnergyPLAN 15 test: Startdata software interface. The main workspace is divided into several sections:

- Overview:** A tree view on the left showing the project structure, with 'Transport' selected.
- Data Table:** A table showing TWh/year for various fuel sources. The columns are Fossil, Biofuel, Waste*, Electrofuel, Total, and Distribution. The rows include JP (Jet Fuel), Diesel / DME, Petrol / Methanol, Ngas* (Grid Gas), LPG, Ammonia (NH3), H2 (Produced by Electrolysers), Electricity (Dump Charge), and Electricity (Smart Charge).
- Warnings Appear Here:** A section for displaying warnings.
- Electric Vehicle Specifications:** A section for configuring vehicle parameters, including Smart Charge Vehicles (Max. share of cars during peak demand, Capacity of grid to battery connection, Share of parked cars grid connected, Efficiency (grid to battery), Battery storage capacity) and Additional Specifications for Vehicle-to-Grid (V2G) (Capacity of battery to grid connection, Efficiency (battery to grid)).
- Flow Diagram:** A diagram on the right showing the energy flow from sources (Oil, Ngas, Biomass, H2 storage, Electricity) through various vehicle types (Combustion cars, FC, Electric vehicle, Vehicle to grid) to Transport demand.

Input

Fuel demands

F_{T-JF} , $F_{T-Diesel}$, $F_{T-Petrol}$, F_{T-NGas} , F_{T-LPG} , F_{T-NH3} = Annual fuel demand for transport

$F_{Transport-H2}$ = Annual hydrogen fuel demand for transport

Electricity demands

D_{BEV} = Electricity demand of Battery Electric Vehicles in TWh/year

D_{V2G} = Electricity demand of "V2G cars" and or "BEV smart charge" in TWh/year

$V2G_{Max-Share}$ = The maximum share of cars which are driving during peak demand hour.

$C_{Charger}$ = The capacity of the grid to battery connection in MW

$V2G_{Connection-Share}$ = The share of parked V2G cars connected to the grid.

$\mu_{Charger}$ = The efficiency of the grid to battery connection (charger).

$S_{V2G-Battery}$ = The capacity of the battery storage in GWh

C_{Inv} = The capacity of the battery to grid connection in MW

μ_{Inv} = The efficiency of the battery to grid connection (inverter).

The transport input tab sheet is designed to describe potential changes in the transport sector.

The fuel inputs at the top comprise fuel for cars and other transport units divided into jet petrol, diesel, petrol, natural gas, and LPG. For all these types of fuels, biofuels and electrofuels (if any) will be transferred from the Waste, BiomassConversion and Electrofuel tab sheets and added to the sum. Vehicles on hydrogen require an additional input in terms of an hourly distribution which will be used to specify the demand for hydrogen administered in the Hydrogen tab sheet.

The distribution of natural gas is used only in the calculation of the gas grid hourly balance (See Chapter 8.7)

A series of inputs describes battery electric vehicles (BEV). Basically, they are divided into dump cars and smart cars. In the case of dump cars, the input defines an electricity demand for transport shown as an annual demand and a distribution curve. In the case of smart cars, the electricity demand forms part of the simulations and one has to specify a number of relevant input data. One can activate a help function by pressing the button in the upper right corner of the tab sheet, as illustrated below. By specifying the efficiency of the individual types of cars in terms of km/kWh, one can follow the total numbers of km per year during the process of changing the system, e.g., by reducing the number of traditional cars and adding new technologies on biofuels and/or electric vehicles.

TWh/year	Fossil	Biofuel	Waste*	Electrofuel	Total	Distribution	Help to design inputs	
							km/kWh	Billion km/year
JP (Jet Fuel)	<input type="text" value="0"/>	<input type="text" value="0"/>		<input type="text" value="0"/>	0.00			
Diesel / DME	<input type="text" value="0"/>	<input type="text" value="0"/>	0.00	<input type="text" value="0"/>	0.00		<input type="text" value="1.5"/>	<input type="text" value="0"/>
Petrol / Methanol	<input type="text" value="0"/>	<input type="text" value="0"/>		<input type="text" value="0"/>	0.00		<input type="text" value="1.5"/>	<input type="text" value="0"/>
Ngas* (Grid Gas)	<input type="text" value="0"/>				0.00	Gas const.txt	<input type="text" value="1.5"/>	<input type="text" value="0"/>
LPG	<input type="text" value="0"/>				0.00		<input type="text" value="1.5"/>	<input type="text" value="0"/>
Ammonia (NH3)				<input type="text" value="0"/>	0.00		<input type="text" value="1.5"/>	<input type="text" value="0"/>
H2 (Produced by Electrolysers)					<input type="text" value="0"/>	H2	Hour_US2001_transportation_BEV_	<input type="text" value="3"/>
Electricity (Dump Charge)					<input type="text" value="0"/>	Dump	Hour_US2001_transportation_BEV_	<input type="text" value="5"/>
Electricity (Smart Charge)					<input type="text" value="0"/>	Smart	Hour_US2001_transportation_SEV_	<input type="text" value="5"/>
								<input type="text" value="0"/>

4.1.5.1. Input tab sheet calculation of electrolysers for transport

If a fuel demand is specified for hydrogen transport, then the minimum electrolyser capacity required to provide the necessary hydrogen is calculated. The electrolysers must be added to the system in the Input Hydrogen tab sheet. The calculation is the same as for micro hydrogen systems, as shown in section 4.1.2.4.

4.1.6. Desalination

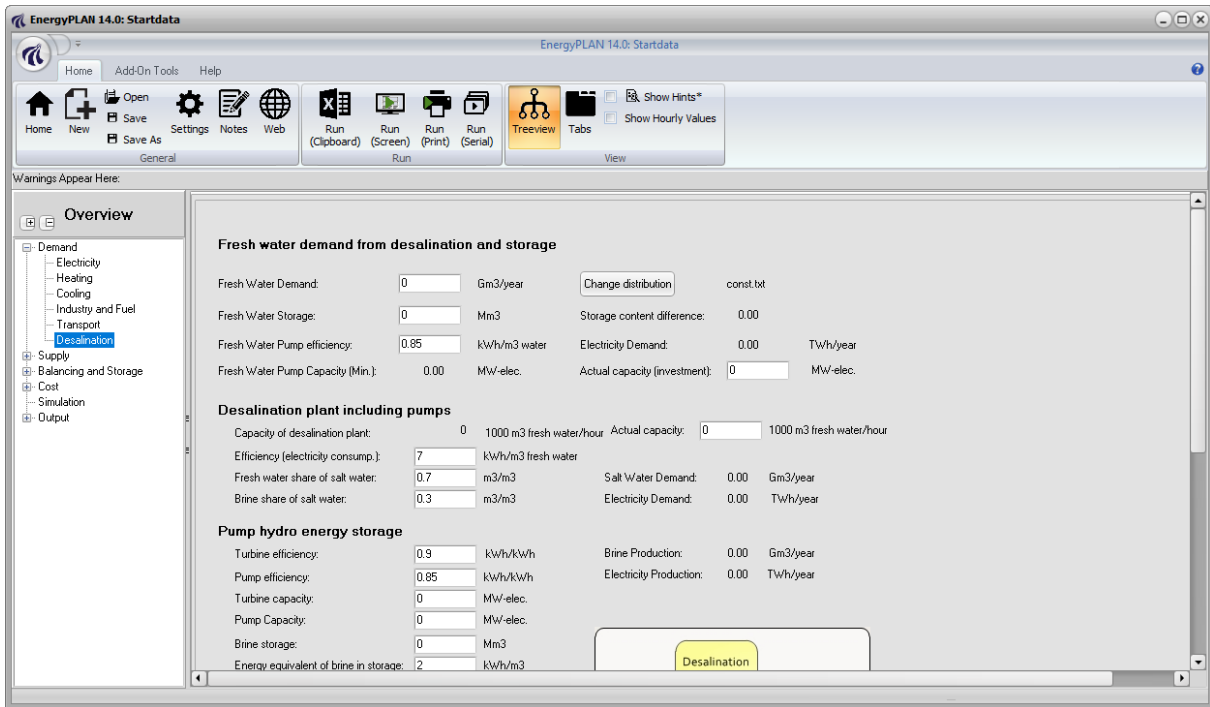

Input

Fresh Water demand from desalination and storage:

D_{FRESH} : Annual Demand for Fresh Water (Mm3/year)

Hourly distribution of Fresh Water demand

S_{FRESH} : Capacity of Fresh Water Storage (Mm3)

$\mu_{\text{FRESHWATERPUMP}}$: Electricity efficiency of the fresh water pump (kWh/m3 Fresh Water)

$C_{\text{PUMP-FRESHWATER}}$: Capacity of the fresh water supply pump (MW electric input)

Desalination Plant including Pumps:

$C_{\text{DESALINATION}}$: Capacity Desalination Plant (m3 Fresh Water/hour)

$\mu_{\text{DESALINATION}}$: Electricity efficiency (kWh/m3 Fresh Water)

$SHARE_{\text{FRESH}}$: Fresh Water Share of Salt Water input (m3/m3)

$SHARE_{\text{BRINE}}$: Brine Share of Salt Water input (m3/m3)

Pump Hydro Energy Storage

μ_{TURBINE} : Electric efficiency of turbine (kWh/kWh)

μ_{PUMP} : Electric efficiency of pump (kWh/kWh)

C_{TURBINE} : Capacity of the turbine (MW electric output)

C_{PUMP} : Capacity of the pump (MW electric input)

S_{BRINE} : Capacity of Brine Storage (1000 m3)

$\phi_{\text{BRINESTORAGE}}$: Energy equivalent of water in Brine Storage (kWh/m3)

The modelling of desalination is based on a potential solution for a plant in Jordan as illustrated in the diagram below:

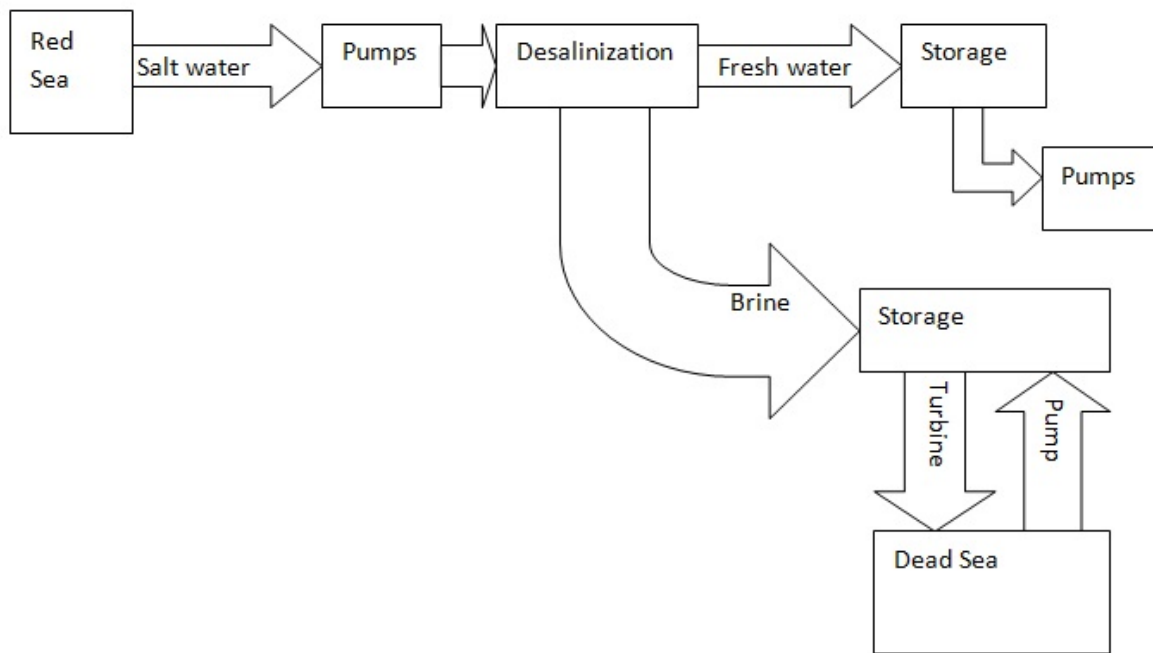

Based on the hourly fresh water demand and storage the model will calculate the minimum necessary capacity of the fresh water pump and the desalination unit to fulfill the demands as follows:

First the hourly demand for fresh water (d_{FRESH}) is calculated from the annual demand (D_{FRESH}) and the hourly distribution.

The hourly electricity demand (MW) and minimum necessary capacity (MW) of the fresh water pump is found as the hourly demand for water multiplied by the electricity efficiency of the fresh water pump (kWh/m³ Fresh Water) divided by 1000 to get the result in MW.

$$e_{\text{PUMP-FRESHWATER}} = d_{\text{FRESH}} * \mu_{\text{FRESHWATERPUMP}} / 1000$$

$$C_{\text{PUMP-FRESHWATER-MIN}} = \text{Max} (e_{\text{PUMP-FRESHWATER}})$$

The minimum capacity necessary will be shown in the input TabSheet of EnergyPLAN and the user will be allowed to input a higher value if desired. This value is only used in the cost calculation and if one inputs a smaller value the EnergyPLAN model will replace it with the necessary minimum value.

Next, the average fresh water production ($w_{\text{FRESH-AVERAGE}}$) is calculated:

$$w_{\text{FRESH-AVERAGE}} = D_{\text{FRESH}} / 8784$$

The hourly content of the fresh water storage (s_{FRESH}) is calculated by iterations and by setting the production of fresh water (w_{FRESH}) equal to the average value ($w_{\text{FRESH-AVERAGE}}$) in the first iteration:

$$s_{\text{FRESH}} := s_{\text{FRESH}} + (w_{\text{FRESH}} - d_{\text{FRESH}})$$

$$\text{If } s_{\text{FRESH}} > S_{\text{FRESH}} \text{ then } s_{\text{FRESH}} = S_{\text{FRESH}}$$

$$\text{If } s_{\text{FRESH}} < 0 \text{ then } s_{\text{FRESH}} = 0$$

To assure that the content of the fresh water storage is the same by the end of the year as at the beginning the calculation is repeated once.

If the storage is big enough there will be a balance between the annual production and demand for fresh water. However if the storage creates a limitation there will be a lack of production. In this case the capacity of the desalination unit is raised in small steps until repeating the calculation above provides a balance and the minimum capacity required for the desalination plant has been identified.

The minimum capacity necessary will be shown in the input TabSheet of EnergyPLAN and the user will be allowed to input a higher value to allow for better integration. However if one inputs a smaller value the EnergyPLAN model will replace it with the necessary minimum value.

The hourly demand for salt water (w_{SALT}) as well as the production of brine (w_{BRINE}) and the demand for electricity ($d_{DESALINATION}$) is then found as follows:

$$w_{SALT} = w_{FRESH} / SHARE_{FRESH}$$

$$w_{BRINE} = w_{SALT} * SHARE_{BRINE}$$

$$d_{DESALINATION} = w_{FRESH} * \mu_{DESALINATION}$$

Afterwards, based on the hourly production of brine (w_{BRINE}), the brine storage content (s_{BRINE}) and the maximum electricity production on the turbine ($e_{TURBINE}$) is found as follows:

$$e_{TURBINE} = \min [(\mu_{TURBINE} * s_{BRINE}) , C_{TURBINE}]$$

$$s_{BRINE} := s_{BRINE} + w_{BRINE} * \phi_{BRINESTORAGE} - e_{TURBINE}$$

$$\text{If } s_{BRINE} > S_{BRINE} \text{ then } s_{BRINE} := S_{BRINE}$$

4.2. Supply

Once the demands have been defined, the user must design the supply side of the energy system. Here the user constructs different types of electricity, heat, cooling, and fuel production plants. Technical characteristics such as the capacities and efficiencies are typically required for each plant, while in some cases, a predefined hourly distribution is also necessary.

4.2.1. Heat and Electricity

The screenshot shows the EnergyPLAN 14.0: Startdata software interface. The main workspace is divided into several sections:

- Overview:** A tree view on the left shows the project structure, with 'Heat and Electricity' selected.
- Electricity Production:** A table showing production for three groups and a total.

	Group 1:	Group 2:	Group 3:	Total:	Unit:
Electricity Production:					
District Heating Production:	0.00	10.00	10.00	20.00	TWh/year
- Boilers:** A table showing boiler parameters for three groups.

	Group 1:	Group 2:	Group 3:	Unit:
Thermal Capacity	5000	5000		MJ/s
Boiler Efficiency	0.9	0.9	0.9	Percent
Fixed Boiler share	0	0	0	
- Combined Heat and Power (CHP):** A table showing CHP parameters for three groups.

	Group 1:	Group 2:	Group 3:	Unit:
CHP Condensing Mode Operation*				
Electric Capacity (PP1)			4000	MW/e
Electric Efficiency (PP1)			0.45	
CHP Back Pressure Mode Operation*				
Electric Capacity	1000	1500		MW/e
Thermal Capacity	Auto	1250	1875	MJ/s
Electric Efficiency	0.4	0.4		
Thermal Efficiency	0.5	0.5		
- Industrial CHP:** A table showing industrial CHP parameters.

	Group 1:	Group 2:	Group 3:	Total:	Unit:
CHP Electricity	0	0	0	0.00	TWh/year
CHP Heat Produced	0	0	0	0.00	TWh/year
CHP Heat Demand	0	0	0	0.00	TWh/year
CHP Heat Delivered*	0.00	0.00	0.00	0.00	TWh/year
- Schematic Diagram:** A flow diagram showing the energy flow between various components: Fuel, CHP, Boiler, Heat pump/electric boiler, Heat demand, Solar thermal, Electrolyser, Industry, and Heat storage.

Input

Energy production units

C_{CHP2} = CHP capacity (MWe) in district heating group 2

T_{B2} = Boiler capacity (MJ/s) in district heating group 2

C_{CHP3} = CHP capacity (MWe) in district heating group 3

T_{B3} = Boiler capacity (MJ/s) in district heating group 3

C_{PP} = Power Plant capacity (MWe)

ρ_{B1} = Thermal efficiency, Boiler in district heating group 1

μ_{CHP2} = Electric efficiency, CHP in district heating group 2

ρ_{CHP2} = Thermal efficiency, CHP in district heating group 2

ρ_{B2} = Thermal efficiency, Boiler in district heating group 2

μ_{CHP3} = Electric efficiency, CHP in district heating group 3

ρ_{CHP3} = Thermal efficiency, CHP in district heating group 3

ρ_{B3} = Thermal efficiency, Boiler in district heating group 3

μ_{PP} = Electric efficiency, Power Plant

Q_{I1}, \dots, Q_{I3} = Annual excess heat production from industry to district heating groups 1, 2 and 3.

$E_{CSHP1}, \dots, E_{CSHP3}$ = Annual excess electricity production from industrial CHP (CSHP)

Heat storage

S_{DH2} = Capacity, Heat storage in district heating group 2 (GWh)

S_{DH3} = Capacity, Heat storage in district heating group 3 (GWh)

Capacities and operation efficiencies of CHP units, power stations, boilers and heat pumps are defined as part of the input data. The size of heat storage capacities is also given here.

C_{PP} is the total sum of power plant capacity and CHP capacity in group 3. In the absence of district heating demand in group 3, the CHP capacity can be turned into purely condensing power plant capacity. Often CHP plants in city areas form part of extraction plants.

4.2.1.1. Industrial CHP

Heat production for district heating groups is given priority along with solar thermal and heat production from waste as explained in section 5.5 (for group 1) and in sections 6.2.1 and 7.4 (for groups 2 and 3).

Electricity production can be specified for each of the three district heating groups. However, they are all fed into the grid and given priority along with renewable energy resources such as wind power. Other units such as CHP and power plants will adjust their production accordingly if possible (given the specified simulation strategy), and if this cannot be done, excess electricity production will be exported.

4.2.2. Central Power Production

The screenshot displays the EnergyPLAN 15.0: Startdata software interface. The main window is titled "EnergyPLAN 15.0: Startdata" and features a menu bar with "Home", "Add-On Tools", and "Help". Below the menu bar is a toolbar with icons for Home, New, Open, Save, Save As, Settings, Notes, Web, Run (Clipboard), Run (Screen), Run (Print), Run (Serial), Treeview, Tabs, Show Hints*, and Show Hourly Values.

The interface is divided into several sections:

- Overview:** A tree view on the left side showing a hierarchy of simulation components: Demand (Electricity, Heating, Cooling, Industry and Fuel, Transport, Desalination), Supply (Heat and Electricity, Central Power Production, Variable Renewable Electric, Heat Only, Fuel Distribution, Waste, Liquid and Gas Fuels, CO2), Balancing and Storage, Cost, Simulation, and Output.
- Central Power Plants:** A table with columns for Capacity (MW-e), Efficiency, Correction Factor (Percent), Annual production (TWh/year), and Distributions. The table lists:

Central Power Plants	Capacity (MW-e)	Efficiency	Correction Factor (Percent)	Annual production (TWh/year)	Distributions
PP1 (CHP3 Condensing Mode)*	4000.00			n/a*	
Condensing PP2	0	0.45		n/a*	
Nuclear	0	0.33	1	0.00	Change const.txt
Nuclear partload:	1	Share of capacity - has to be activated in Regulatin Strategy Tabsheet			
Geothermal	0	0	1	0.00	Change const.txt
Dammed Hydro Water supply*				0	Change Hour_wind_1.txt
Dammed Hydro Power	0	0.33		0.00 (Estimated)*	
- Transmission line capacity*:** Maximum imp./exp. cap: 1600 MW/
- External wish for import export defined by hourly distribution:** Change distribution zero.txt
- Advanced Hydro Power:** Off
- Storage for Dammed Hydro:** Storage 0 GWh, Storage difference: 0. Pump Back Capacity 0 MW-e, Pump Back Efficiency 0.9.
- Diagram:** A flow diagram showing the interaction between Hydro water, Hydro storage, Hydro PP, RES electricity, and Geothermal power.

Input

Condensing Power Plants

C_{PP2} = Power Plant capacity 2 (MWe)

μ_{PP2} = Electric efficiency, Power Plant 2

Nuclear

$C_{Nuclear}$ = Capacity of the Nuclear Power Electricity Generator in MW

$\mu_{Nuclear}$ = Efficiency of the Nuclear Power station.

$FAC_{Nuclear}$ = Correction factor between production and capacity

$PAR_{Nuclear}$ = Percent of the capacity that can be reduced. Works as a CEEP regulation.

Geothermal

$C_{Geothermal}$ = Capacity of the Geothermal Power Electricity Generator in MW

$\mu_{Geothermal}$ = Efficiency of the Geothermal Power station.

$FAC_{Geothermal}$ = Correction factor between production and capacity

Hydro power

C_{Hydro} = Capacity of Electricity Generator in MW

μ_{Hydro} = Efficiency defined as the conversion from energy in the storage into electricity production.

S_{Hydro} = Capacity of the storage in GWh

W_{Hydro} = Annual water supply to the storage in TWh/year

$C_{Hydro-Pump}$ = Capacity of the Hydro Power Pump in MW

$\alpha_{Hydro-Pump}$ = Efficiency of Pump defined as the conversion from electricity to energy in the storage

$S_{Hydro-Pump}$ = Capacity of the lower water storage in GWh

Transmission line capacity:

$C_{imp/exp}$ = Import/export transmission line capacity

In this input tab sheet, one can specify power-alone units additional to the CHP3 and PP unit already specified in the Heat and Electricity production input tab sheet. PP2 represents an option to have another power plant additional to PP in case the fuels and/or the operation costs are different.

Furthermore, one can specify nuclear, geothermal and hydro power input including reversal hydro power.

Transmission line capacity*	Maximum imp./exp. cap:	<input type="text" value="1600"/>	MW
External wish for import export defined by hourly distribution: <input type="button" value="Change distribution"/> zero.txt			
	Export	Import	
Annual External Wish	0,00	0,00	TWh/year
Potential given transmission line	0,00	0,00	TWh/year

As a new feature (implemented in version 15.1), one can specify a request for external import/export defined by an hourly distribution. In this way, the EnergyPLAN model can quantify the system's ability to provide balancing for an external system.

The purpose is to make it possible for one country/system to assist in the balancing of another country/system, e.g. to use the flexibility of Norwegian hydropower to balance a Swedish, Danish or European system.

Using the feature requires an hourly distribution file, which can have both negative and positive numbers:

- Positive numbers means a request for export out of the internal system (i.e. import into the external system)
- Negative numbers means a request for the opposite

The distribution is by default zero, using the distribution file zero.txt.

The external file expresses a request for import/export, which may or may not be possible depending on the internal system.

The import/export is limited to the capacities of the transmission line. As an initial calculation, the input tabsheet shows both the total request as well as the potential for meeting the request given the transmission line capacity.

EnergyPLAN includes the request for import/export simply by adding it to the demands when the electricity production and balancing is calculated. Thus, instead of striving for a net zero, it strives to meet the specified import/export.

The calculation is only included in the “technical simulation”. In the “market economic simulation”, such a request should be expressed in the hourly duration of the prices on the external market.

4.2.2.1. Nuclear

Nuclear power units are determined by the following inputs:

C_{Nuclear} = Capacity of the nuclear power electricity generator in MW

μ_{Nuclear} = Efficiency of the nuclear power station.

d_{Nuclear} = Distribution of the electricity production between 8784 hour values

FAC_{Nuclear} = Correction factor between production and capacity

PAR_{Nuclear} = Percent of the capacity that can be reduced. Works as a CEEP regulation.

The nuclear power station is subject to the condition that it will always be involved in the task of maintaining grid stability.

The nuclear unit is considered to be running as base load by default, and therefore, the power plant does not take part in the active regulation. The electricity production of the nuclear unit (e_{Nuclear}) is simply defined by the capacity, the hourly distribution and the correction factor:

$$e_{\text{Nuclear}} = FAC_{\text{Nuclear}} * C_{\text{Nuclear}} * d_{\text{Nuclear}} / \text{Max}(d_{\text{Nuclear}})$$

The correction factor is used to adjust differences between capacity and production. E.g. if the capacity factor is 0.8 then the maximum production will be 80% of the installed capacity

The efficiency is used only for the calculation of the annual amount of fuel (f_{NUCLEAR}), which is calculated by applying the following formula:

$$f_{\text{Nuclear}} = e_{\text{Nuclear}} / \mu_{\text{Nuclear}}$$

The fuel consumption is named “Uranium” and is measured in TWh/year in order to be able to compare it to the consumption of the rest of the units.

Nuclear can regulate a user defined share of its capacity. This is activated as CEEP regulation strategy resulting in the down regulation of Nuclear in hours with CEEP.

4.2.2.2. Input tab sheet calculation of geothermal power

The geothermal power plant is calculated in the following way:

Geothermal power units are determined by the following inputs:

$C_{\text{Geothermal}}$ = Capacity of the geothermal power electricity generator in MW

$\mu_{\text{Geothermal}}$ = Efficiency of the geothermal power station.

$d_{\text{Geothermal}}$ = Distribution of the electricity production between 8784 hour values

$FAC_{\text{Geothermal}}$ = Correction factor between production and capacity

The geothermal power station is subject to the condition that it will always be involved in the task of maintaining grid stability.

The geothermal unit is considered to be running as base load, and therefore, the power plant does not take part in the active regulation. The electricity production of the geothermal unit ($e_{\text{Geothermal}}$) is simply defined by the capacity, the hourly distribution and the correction factor:

$$e_{\text{Geothermal}} = FAC_{\text{Geothermal}} * C_{\text{Geothermal}} * d_{\text{Geothermal}} / \text{Max}(d_{\text{Geothermal}})$$

The correction factor is used to adjust differences between capacity and production. E.g. if the capacity factor is 0.8 then the maximum production will be 80% of the installed capacity

The efficiency is used only for the calculation of the annual amount of fuel ($f_{\text{Geothermal}}$), which is calculated by applying the following formula:

$$f_{\text{Geothermal}} = e_{\text{Geothermal}} / \mu_{\text{Geothermal}}$$

The fuel consumption is named “Geothermal” and is measured in TWh/year in order to be able to compare it to the consumption of the rest of the units.

4.2.2.3. Input tab sheet calculation of hydro power

The hydro power plant is identified by an hourly distribution of the annual water input (W_{Hydro}), a water storage capacity (S_{Hydro}) and the capacity (C_{Hydro}) and efficiency (μ_{Hydro}) of the generator.

Based on such input, the potential output is calculated simultaneously by the procedure described in the following.

First, the average hydro electricity production ($e_{\text{Hydro-ave}}$) is calculated as the output of the average water supply (Annual water supply divided by 8784 hours/year):

$$e_{\text{Hydro-ave}} = \mu_{\text{Hydro}} * W_{\text{Hydro}} / 8784$$

Then the program calculates the hourly modelling of the system, including the fluctuations in the storage content. Furthermore, the hydro power production (e_{Hydro}) is modified in accordance with the generator capacity, the distribution of the water supply, and the storage capacity in the following way:

$$\text{Hydro storage content} = \text{Hydro storage content} + w_{\text{Hydro}}$$

$$e_{\text{Hydro}} = \text{MAX} [e_{\text{Hydro-Ave}}, (\text{Hydro storage content} - S_{\text{Hydro}}) * \mu_{\text{Hydro}}]$$

$$e_{\text{Hydro}} \leq C_{\text{Hydro}}$$

Due to differences in the storage content at the beginning and at the end of the calculation period, errors may appear in the calculations. To correct these, the above calculation seeks to identify a solution in which the storage content at the end is the same as at the beginning. Initially, the storage content is defined as 50% of the storage capacity. After the first calculation, a new initial content is defined as the resulting content at the end of the former calculation.

The annual potential production of the hydro power plant is calculated and shown in the input tab sheet.

4.2.3. Variable renewable electricity

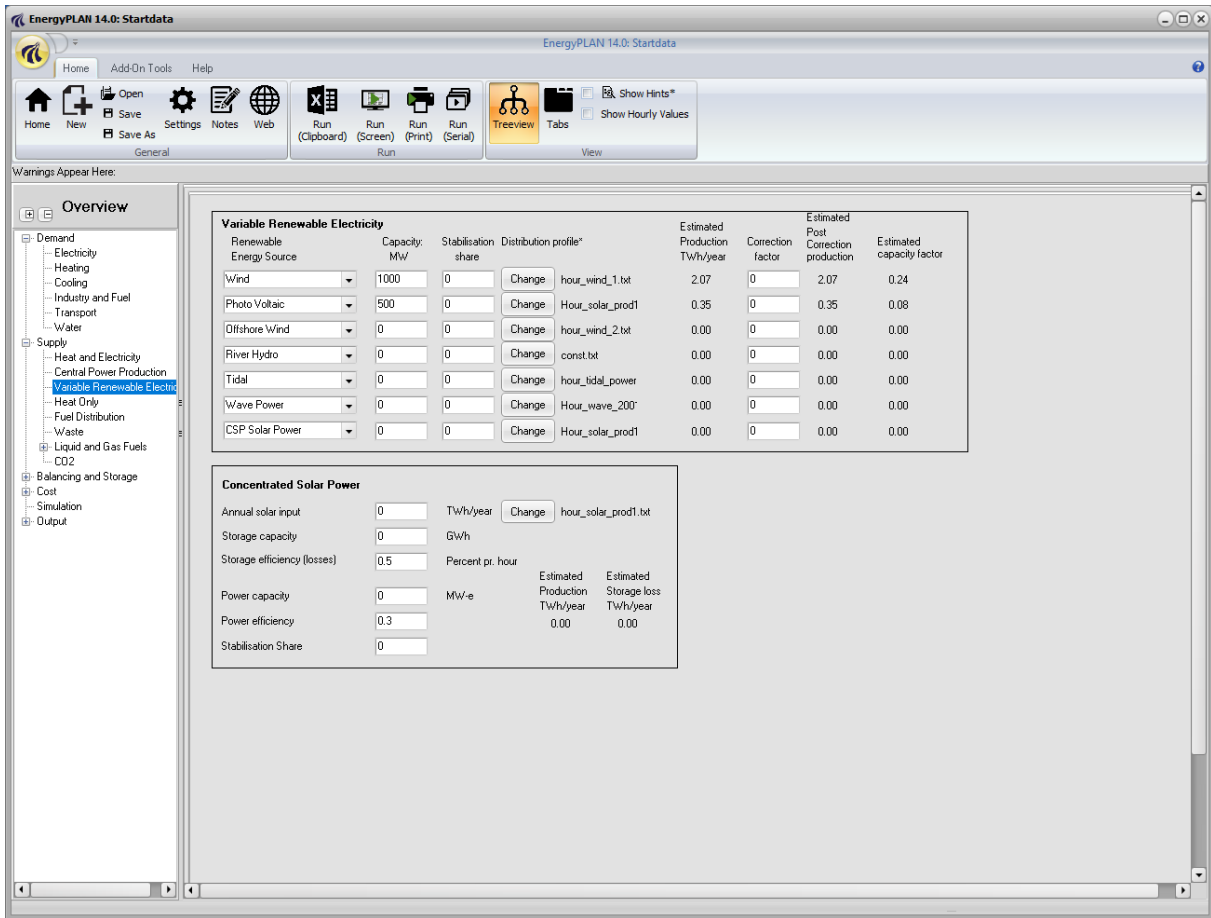

Input

Variable Renewable Electricity

$C_{Res1}, \dots, C_{Res7}$ = Electricity capacity from Renewable Energy Resources
 $Stab_{Res1}, \dots, Stab_{Res7}$ = Share of RES capacity with grid stabilisation capabilities
 $FAC_{Res1}, \dots, FAC_{Res7}$ = Correction factor of RES production"

Concentrated solar power

Q_{CSP} = Solar input
 S_{CSP} = Storage capacity for CSP unit
 $LOSS_{CSP}$ = Loss in solar storage

C_{CSP} = Capacity of CSP plant
 μ_{CSP} = Efficiency of CSP
 $Stab_{CSP}$ = Share of CSP capacity with grid stabilisation capabilities

The input data set defines input from RES and hydro power. One can choose inputs from up to seven different renewable energy sources. By pressing the button, the following specification can be attached to each RES:

- Wind
- Offshore Wind
- Photo Voltaic
- Wave Power

- River Hydro
- Tidal
- CSP Solar Power

Input to the electricity production is identified by the capacity of each RES and by the name of the distribution file. In the case that the RES contributes to grid stabilisation, a share between 0 and 1 can be given.

In the above option, CSP is without storage. However, one can also specify CSP with storage using the input fields below. In such case CSP becomes an active component in the simulation.

4.2.3.1. Variable Renewable Energy

The electricity production input from variable renewable energy sources such as, e.g., wind power is found by multiplying the capacity by the specified hourly distribution. The Data Library comprises different distributions typically found from historical data.

The resulting annual production based on the specified input capacity and distribution is shown on the input page. However, different future wind turbine configurations would lead to either lower or higher productions in the same wind years. Therefore, one can choose to specify a correction factor to change the distribution and increase the annual production. The factor changes the production in such a way that the productions remain the same at hours with either no production or full production, while the other values are moderated relatively:

$$e_{Res}' = e_{Res} * 1 / [1 - FAC_{Res} * (1 - e_{Res})]$$

The same procedure is used for the possible modification of any of the renewable sources.

In the following diagrams, it is illustrated how the factor modifies the input. The examples are based on wind power and photovoltaic distributions in the area of western Denmark year 2001. When defining a capacity of 1000 MW wind power, the annual production becomes 1,96 TWh/year, and when defining 500 MW photovoltaic power, the annual production becomes 0.50 TWh/year, as shown in rows 1 and 3 in the input tab sheet below.

Variable Renewable Electricity				Estimated Production TWh/year	Correction factor	Estimated Post Correction production	Estimated capacity factor
Renewable Energy Source	Capacity: MW	Stabilisation share	Distribution profile*				
Wind	1000	0	Change hour_wind_eltra2	1,96	0,8	4,10	0,47
Photo Voltaic	500	0	Change hour_PV_eltra200	0,50	0,8	1,01	0,23
Offshore Wind	0	0	Change hour_wind_2.txt	0,00	0	0,00	0,00
River Hydro	0	0	Change const.txt	0,00	0	0,00	0,00
Tidal	0	0	Change hour_tidal_power	0,00	0	0,00	0,00
Wave Power	0	0	Change Hour_wave_200	0,00	0	0,00	0,00
CSP Solar Power	0	0	Change Hour_solar_prod1	0,00	0	0,00	0,00

If adding a correction factor of, e.g., 0.8, the hourly production is modified as illustrated in the two following diagrams. The 0 values and the maximum values of 1000 MW are kept, while all values in between those are raised in accordance with the formula described above.

As a result, annual productions are raised to 4.10 TWh/year for wind power and 1.01 TWh/year for photovoltaic power. It should be mentioned that the factor 0.8 is very high especially for photovoltaic power. However, such a high factor is suitable for the illustration of the modification principle.

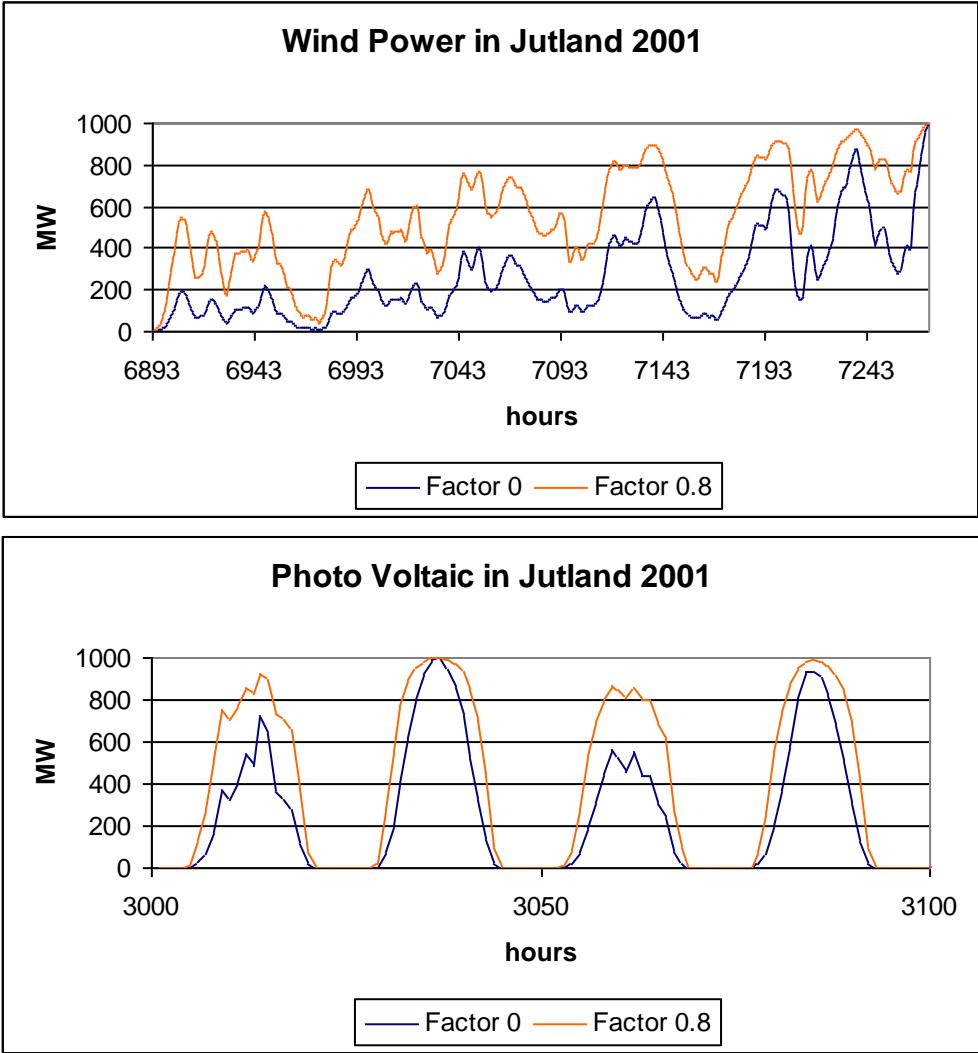

4.2.3.2. Concentrated Solar Power

The Concentrated Solar Power plant (CSP) is identified by an hourly distribution of the annual solar thermal input (Q_{CSP}), a thermal storage capacity (S_{CSP}) and the capacity (C_{CSP}) and efficiency (μ_{CSP}) of the power generator. Moreover, one can specify the losses of the storage ($LOSS_{CSP}$) in percent per hour of the content and the share of the installed CSP units, which can supply grid stability ($Stab_{CSP}$).

Based on such input, the potential output is calculated simultaneously by the procedure described in the following.

First, the demand for solar thermal from the storage ($S_{CSP-demand}$) is defined on the basis of the maximum production capacity: calculated as output of the average water supply (Annual water supply divided by 8784 hours/year):

$$S_{CSP-demand} = C_{CSP} / \mu_{Hydro}$$

Then the program calculates the maximum potential production from the CSP unit taking into consideration the storage losses in the following way:

$$\text{If } q_{\text{CSP}} > S_{\text{CSP-demand}} \text{ then } e_{\text{CSP}} = S_{\text{CSP-demand}} * \mu_{\text{Hydro}}$$

$$\text{If } q_{\text{CSP}} < S_{\text{CSP-demand}} \text{ then } e_{\text{CSP}} = (q_{\text{CSP}} + \text{storagecontent}) * \mu_{\text{Hydro}}$$

$$\text{If } e_{\text{CSP}} > C_{\text{CSP}} \text{ then } e_{\text{CSP}} = C_{\text{CSP}}$$

$$\text{Storagecontent}(x) = \text{storagecontent}(x-1) + q_{\text{CSP}} - C_{\text{CSP}} / \mu_{\text{Hydro}}$$

$$\text{Storage loss} = \text{Storagecontent}(x) * \text{LOSS}_{\text{CSP}}/100;$$

$$\text{Storagecontent}(x) = \text{storagecontent}(x) - \text{storage loss}$$

$$\text{If } \text{storagecontent} > S_{\text{CSP}} \text{ then } \text{Storage loss} = \text{Storage loss} + (\text{Storagecontent}(x) - S_{\text{CSP}})$$

Due to differences in the storage content at the beginning and at the end of the calculation period, errors may appear in the calculations. To correct these, the above calculation seeks to identify a solution in which the storage content at the end is the same as at the beginning. Initially, the storage content is defined as 50% of the storage capacity. After the first calculation, a new initial content is defined as the resulting content at the end of the former calculation.

The annual losses in the storage and the potential production of the CSP plant is calculated and shown in the input tab sheet.

4.2.4. Heat Only

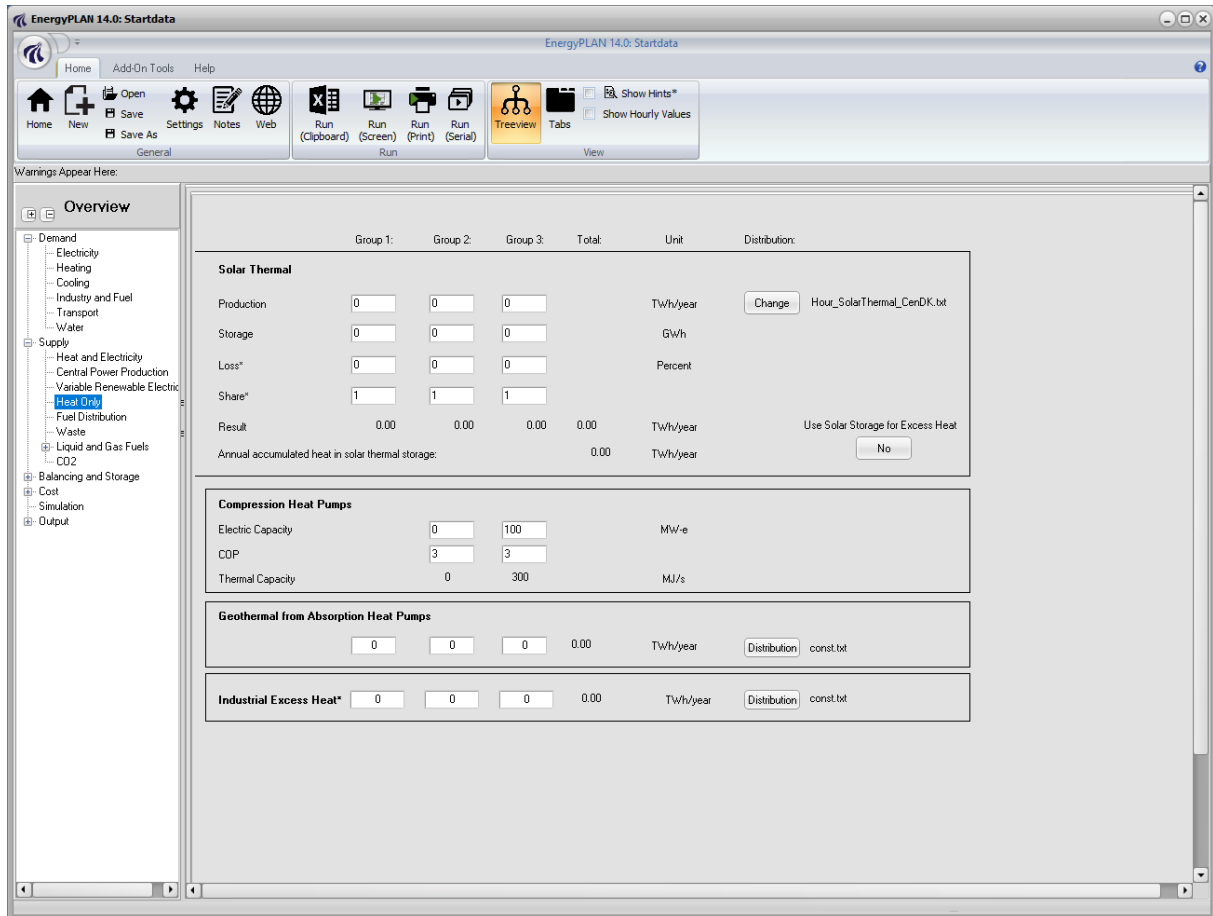

Input

Solar thermal

$Q_{\text{Solar}1}, \dots, Q_{\text{Solar}3}$ = Annual heat production from solar thermal in district heating groups 1, 2 and 3.
 $\text{SHARE}_{\text{Solar}1}, \dots, \text{SHARE}_{\text{Solar}3}$ = Share of district heating with solar thermal in groups 1, 2 and 3.

Heat storage

$S_{\text{HSolar}1}$ = Capacity, Heat storage for solar thermal in district heating group 1 (GWh)
 $S_{\text{HSolar}2}$ = Capacity, Heat storage for solar thermal in district heating group 2 (GWh)
 $S_{\text{HSolar}3}$ = Capacity, Heat storage for solar thermal in district heating group 3 (GWh)
 $\text{LOSS}_{\text{HSolar}1}, \dots, \text{LOSS}_{\text{HSolar}3}$ = Losses in Heat storage for solar thermal in district heating groups 1, 2 and 3.

Compression Heat Pumps

$\phi_{\text{HP}3}$ = COP, heat pump in district heating group 3
 $\phi_{\text{HP}2}$ = COP, heat pump in district heating group 2
 $C_{\text{HP}2}$ = Heat pump capacity (MWe) in district heating group 2
 $C_{\text{HP}3}$ = Heat pump capacity (MWe) in district heating group 3

Geothermal from Absorption Heat Pumps

$Q_{\text{AHP}1}, Q_{\text{AHP}2}, Q_{\text{AHP}3}$ = Annual heat production from geothermal absorption heat pumps in district heating groups 1, 2, and 3

Industrial Excess Heat

$Q_{EH1}, Q_{EH2}, Q_{EH3}$ = Annual heat production from industrial excess heat in district heating groups 1, 2, and 3

In the heat only tab sheet one can define solar thermal, compression heat pumps, excess heat from industry and geothermal heat only inputs. All of them are divided into the three district heating groups.

4.2.4.1. Input tab sheet calculation of solar thermal in district heating systems

The annual solar thermal production is defined for each group and includes heat storage capacity and losses. The share of solar is a figure between 0 and 1 defining the share of district heating demand with solar thermal production within each of the DH groups. A common hourly distribution for all three groups is specified.

The solar thermal input cannot always be utilised. It depends on the hourly distributions of the heat demand, the solar thermal production, the heat storage and the losses. The share of the solar thermal production, which can be utilised, Q'_{Solar} , is calculated simultaneously in the input tab sheet for each of the three district heating groups. If the solar production at one hour exceeds the demand, the excess production is stored (if possible). And when the solar production is lower than the demand, the model seeks to empty the storage. The sequence is repeated to identify a solution in which the content of the storage in the beginning of the year equals the content by the end of the year:

$$q'_{DH} = q_{DH} * SHARE_{Solar}$$

$$\text{If } q_{Solar} < q'_{DH} \text{ then } q'_{Solar} = q_{Solar} + \text{Min}[\text{StorageContent}, (q'_{DH} - q_{Solar})]$$

$$\text{If } q_{Solar} > q'_{DH} \text{ then } q'_{Solar} = q'_{DH} + (S_{HSolar} - \text{StorageContent})$$

$$\text{StorageContent} := \text{StorageContent} + q_{Solar} - q'_{DH}$$

$$\text{If } \text{StorageContent} > S_{HSolar} \text{ then } \text{StorageContent} = S_{HSolar}$$

$$\text{StorageContent} := \text{StorageContent} - \text{StorageContent} * \text{LOSS}_{HSolar1} / 100;$$

$$Q'_{Solar} = \sum q'_{solar}$$

Q'_{Solar} is shown in the input tab sheet for each of the three groups, and q'_{Solar} is applied subsequently to the energy system analysis.

4.2.5. Fuel Distribution

The fuel distribution for boilers, CHP and power plants is defined in the “Thermal Plant Fuel Distribution” window. Each plant is represented by a different row, while the type of fuel is represented by the column. There are two ways to define each fuel: Variable and Fixed.

If ‘Fixed’ is selected, then the exact value you enter is defined as the amount of fuel that plant consumes. For example, the inputs below define that CHP3 consumes exactly 2 TWh of coal. However, if variable is selected, then the fuel is proportioned evenly with other Variable fuels. For example, below, oil, gas and biomass are all defined as variable. Hence, the fuel distribution is proportioned

across these fuels according to their inputs. In this case it is 2, 2, and 4 for oil, gas, and biomass respectively. Hence when EnergyPLAN completes a simulation, then 25% of the CHP3 fuel will be oil, 25% gas, and 50% biomass (since that's how 2, 2, and 4 are proportioned). Remember, this proportion will be applied to the total fuel for CHP3 minus 2 TWh for coal, since this is a fixed value.

It is possible to use electrofuels directly in the thermal plants as a fixed amount. The amount will show up in the Electrofuel sheet.

Distribution of fuel (TWh/year)	Coal	Oil	Ngas	Biomass	Electrofuels(Oil) *)					
	<input type="text" value="Fixed"/>	<input type="text" value="Variable"/>	<input type="text" value="Variable"/>	<input type="text" value="Variable"/>	<input text"="" type="text" value="0"/>	<input type="text" value="0"/>	<input type="text" value="0"/>	<input type="text" value="0"/>	<input type="text" value="0"/>	DHP: Boilers in district heating group 1.
CHP2	<input type="text" value="0"/>	<input type="text" value="0"/>	<input type="text" value="0"/>	<input type="text" value="0"/>	<input type="text" value="0"/>	CHP2: Combined heat and power in district heating group 2.				
CHP3	<input type="text" value="2"/>	<input type="text" value="2"/>	<input type="text" value="2"/>	<input type="text" value="4"/>	<input type="text" value="0"/>	CHP3: Combined heat and power in district heating group 3.				
Boiler2	<input type="text" value="0"/>	<input type="text" value="0"/>	<input type="text" value="0"/>	<input type="text" value="0"/>	<input type="text" value="0"/>	Boiler2: Boilers in district heating group 2.				
Boiler3	<input type="text" value="0"/>	<input type="text" value="0"/>	<input type="text" value="0"/>	<input type="text" value="0"/>	<input type="text" value="0"/>	Boiler3: Boilers in district heating group 3.				
PP1	<input type="text" value="0"/>	<input type="text" value="0"/>	<input type="text" value="0"/>	<input type="text" value="0"/>	<input type="text" value="0"/>	PP1: Condensing mode operation of combined heat and power in district heating group 3.				
PP2	<input type="text" value="0"/>	<input type="text" value="0"/>	<input type="text" value="0"/>	<input type="text" value="0"/>	<input type="text" value="0"/>	PP2: Condensing power plant in 'Electricity only'.				

*) Replace only Oil - will be adjusted if the Oil demand is not big enough
 **) Specify a demand for the production of electrofuels which must be met in the "Liquid and Gas Fuels" Tabsheet

4.2.6. Waste

Waste Incineration

Waste is defined geographically on the three district heating groups. Only one hour distribution can be defined and storage of waste is not considered an option. Heat production is utilized and given priority in the respective district heating groups. Electricity production is fed into the grid. Biofuel production for transportation is transferred to the transportation window. And biofuels for CHP and boilers is subtracted from the fuels in the respective district heating group. "Various" represent non energy products such as food. The economic value is subtracted from the cost of the waste energy resource.

Distribution of Waste: Strategy CHP-Boiler:

Unit:	Waste input	DH production	Electricity production	Biofuel transportation	Biofuel CHP-Boiler	Various (Food etc.)	Income from Various*
	TWh/year	Efficiency	TWh/year	Efficiency	TWh/year	Efficiency	TWh/year
Group 1:	<input type="text" value="0"/>	<input type="text" value="0.8"/>	<input type="text" value="0.00"/>	<input type="text" value="0"/>	<input type="text" value="0.00"/>	<input type="text" value="0"/>	<input type="text" value="0.00"/>
Group 2:	<input type="text" value="0"/>	<input type="text" value="0.8"/>	<input type="text" value="0.00"/>	<input type="text" value="0"/>	<input type="text" value="0.00"/>	<input type="text" value="0"/>	<input type="text" value="0.00"/>
Group 3:	<input type="text" value="0"/>	<input type="text" value="0.8"/>	<input type="text" value="0.00"/>	<input type="text" value="0"/>	<input type="text" value="0.00"/>	<input type="text" value="0"/>	<input type="text" value="0.00"/>
Total:	0.00		0.00		0.00		0.00

Geothermal operated by absorption heat pump on steam from waste CHP plants

Unit:	DH production		Electricity production		Steam for Heat Pump		Heat Pump (CHP)	Steam storage		Heat Pump on steam from storage	
	Efficiency	TWh/year	Efficiency	TWh/year	Efficiency	TWh/year	COP	MJ/s	GWh	Loss (%)	COP
Group 2	<input type="text" value="0"/>	<input type="text" value="0.00"/>	<input type="text" value="0"/>	<input type="text" value="0.00"/>	<input type="text" value="0"/>	<input type="text" value="0.00"/>	<input type="text" value="0"/>	<input type="text" value="0"/>	<input type="text" value="0"/>	<input type="text" value="0"/>	<input type="text" value="0"/>
Group 3	<input type="text" value="0"/>	<input type="text" value="0.00"/>	<input type="text" value="0"/>	<input type="text" value="0.00"/>	<input type="text" value="0"/>	<input type="text" value="0.00"/>	<input type="text" value="0"/>	<input type="text" value="0"/>	<input type="text" value="0"/>	<input type="text" value="0"/>	<input type="text" value="0"/>

Input

F_{W1}, F_{W2}, F_{W3} = Annual input of waste fuels divided into the three district heating groups
 $\rho_{W1}, \rho_{W2}, \rho_{W3}$ = Efficiencies (thermal) of waste conversion
 $\mu_{W1}, \mu_{W2}, \mu_{W3}$ = Efficiencies (electric) of waste conversion
 $\psi_{W1}, \psi_{W2}, \psi_{W3}$ = Efficiencies (waste to biofuel for transport) of waste conversion
 $\eta_{W1}, \eta_{W2}, \eta_{W3}$ = Efficiencies (waste to biofuel for CHP and boilers) of waste conversion
 $\tau_{W1}, \tau_{W2}, \tau_{W3}$ = Efficiencies (waste to various non-energy products) of waste conversion
 P_{W1}, P_{W2}, P_{W3} = Prices of various non-energy products (MDKK/TWh)
 $\rho_{W2-GEO}, \rho_{W3-GEO}$ = Efficiencies (thermal) of waste conversion when also producing steam for geothermal HP
 $\mu_{W2-GEO}, \mu_{W3-GEO}$ = Efficiencies (electric) of waste conversion when also producing steam for geothermal HP
 $\sigma_{W2-GEO}, \sigma_{W3-GEO}$ = Efficiencies (steam) of waste conversion (Used geothermal HP)
 $\phi_{GEO-steam}, \phi_{GEO-steam}$ = COP of geothermal HPs when provided with steam directly from Waste CHP
 $\phi_{GEO-steamStorage}, \phi_{GEO-steamStorage}$ = COP of geothermal HPs when provided with steam from steam storage
 S_{GEO2}, S_{GEO3} = Steam Storage Capacities (GWh)
 $LOSS_{GEO2}, LOSS_{GEO3}$ = Energy Losses from Steam Storage in per cent/hour (GWh)

Waste is considered as biomass energy, which cannot be stored but has to be burned regularly. Waste is divided geographically into three district heating groups, and only one hourly distribution can be defined.

Waste can be converted into the following:

- heat production, which is given priority in the three district heating groups
- electricity production, which is being fed into the grid
- biofuels (fluid) for transport,, which are transferred to the Input Transport tab sheet
- biofuels (solid) for CHP and boilers, which are subtracted from the fuels in the respective DH groups
- Various (non-energy) products, which are given an economic value.

(In the case that one wants to include the conversion of waste to syngas, one can include the waste as biomass in the Biomass Conversion Tab Sheet).

The following input must be given to the model:

- The waste resources divided geographically between the three district heating systems mentioned above.
- Efficiencies specifying the quantity of the waste input resources converted into the following four energy forms: Heat for district heating, electricity, fuel for transport and fuel for CHP and boilers.
- An hourly distribution of the waste input (heat and electricity output)

Moreover, one can specify an additional non-energy output (such as animal food), which will then be given an economic value in the feasibility study.

Basically, the model assumes that waste cannot be stored and has to be converted in accordance with the specified hourly input. Consequently, the energy outputs are treated in the following way:

Heat production for district heating is given priority along with solar thermal and industrial waste heat production. If such input cannot be utilised because of limitations on demand and heat storage capacity, the heat is simply lost.

Electricity production is fed into the grid and given priority along with renewable energy resources such as wind power. Other units such as CHP and power plants will adjust their production accordingly, if possible (given the specified simulation strategy), and if not,, excess electricity production will be exported.

Fuel for transport is calculated and the used fuel will subtract the petrol accordingly and, at the same time, adjust to differences in car efficiencies, if any.

Fuel for CHP and boilers is automatically subtracted in the calculation of fuel in the relevant district heating groups.

Geothermal energy for District Heating in combination with Waste CHP

One can specify a geothermal heat production operated by the use of an absorption heat pump fuelled by steam from the waste CHP plants in District Heating groups 2 and 3. The option is defined by the following input data:

- alternative electric, thermal and steam efficiencies of the Waste CHP plant
- A COP of the absorption heat pump defined as the heat output divided by the steam input

The waste CHP plant will still burn all the waste input in accordance with the specified hourly input. However, the CHP plant can now be operated linearly between the two operation modes, with or without steam production and with high or low electricity and thermal outputs.

Moreover, one can specify the option of steam storage by defining a capacity and an energy loss if any.

In simulation strategies 1 and 4, the system is operated in the following way: If the thermal output from the Waste CHP exceeds the district heating demand and if it is possible to store steam, the CHP will decrease electricity and heat production and increase steam production accordingly, as the steam is stored. If the heat demand exceeds the thermal output from Waste CHP (and industrial waste heat and solar heating), the geothermal production will cover as much as possible only limited by the capacity of the absorption heat pump and the heat demand. First, the absorption heat pump will use steam from the storage and, subsequently, steam from the Waste CHP obtained by decreasing electricity and heat productions.

In simulation strategies 2 and 3, additionally to the above simulation, the Waste CHP will decrease electricity production in the case of excess electricity productions in the system, if the steam storage is available.

4.2.6.1. Calculation of waste fuel outputs

The biofuel outputs are calculated in the following way and the fuel for transport is transferred to the Transport tab sheet:

$$F_{T\text{-Waste}} = FW1 * \psi_{W1} + FW2 * \psi_{W2} + FW3 * \psi_{W3}$$

4.2.7. Liquid and Gas Fuels

4.2.7.1. Biofuels

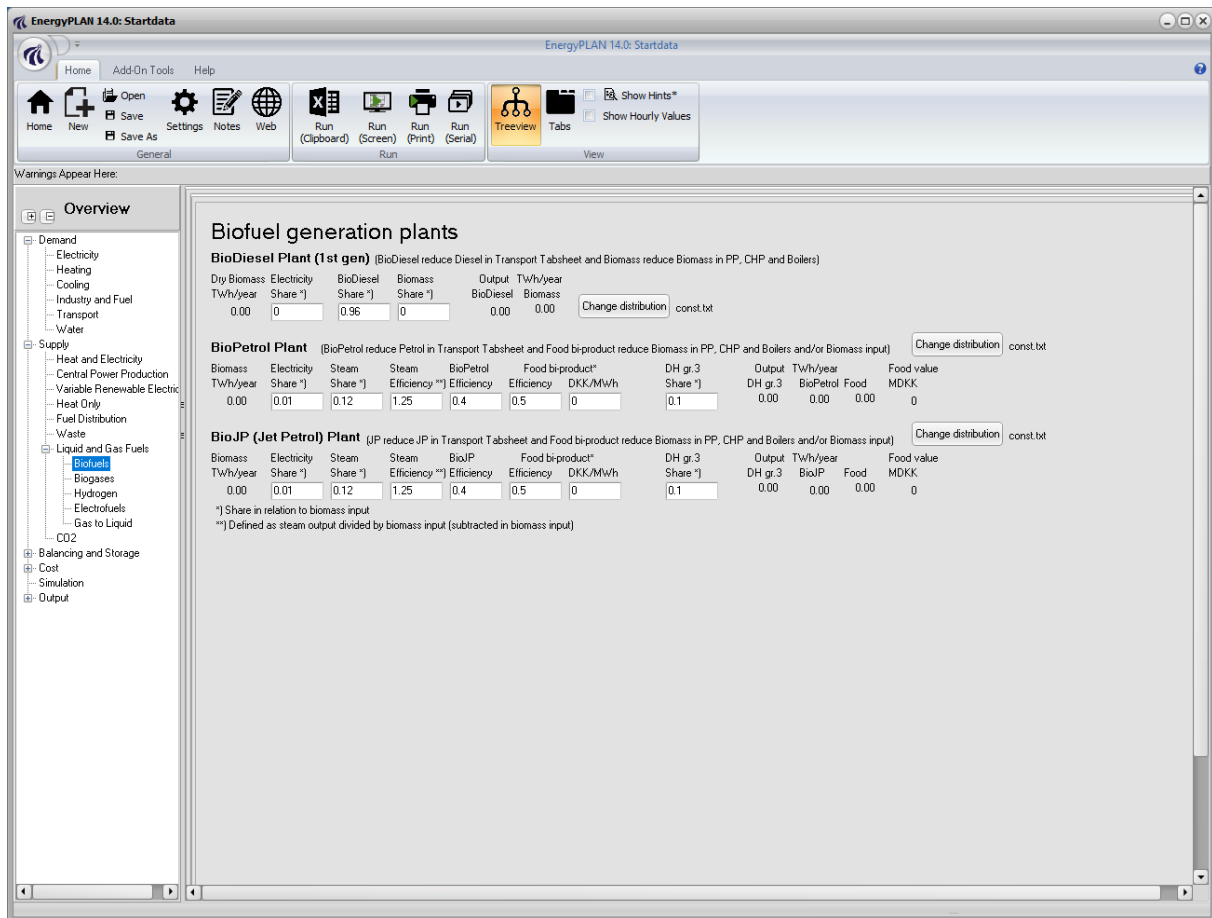

Input

$F_{\text{BioDiesel}}$ = Annual bio diesel production (TWh/year)

$\text{SHARE}_{\text{D-BioDiesel}}$ = Annual input of electricity to bio diesel plant in share of dry biomass input

$\psi_{\text{BioDiesel}}$ = Biomass-to-biodiesel efficiency (diesel output divided by biomass input)

$\eta_{\text{BioDiesel}}$ = Dry biomass-to-biomass efficiency (biomass output divided by dry biomass input)

$F_{\text{BioPetrol}}$ = Annual bio petrol production (TWh/year)

$\text{SHARE}_{\text{D-BioPetrol}}$ = Annual input of electricity to bio petrol plant in share of biomass input

$\text{SHARE}_{\text{STEAM-BioPetrol}}$ = Annual input of steam to bio petrol plant in share of biomass input

$\lambda_{\text{BioPetrol}}$ = Production of steam efficiency (steam output divided by biomass input)

$\Psi_{\text{BioPetrol}}$ = Biomass-to-bio petrol efficiency (petrol output divided by biomass input)

$\tau_{\text{BioPetrol}}$ = Biomass-to-food efficiency (petrol output divided by biomass input)

P_{Food} = Price of food (E.g. DKK/MWh)

$\text{SHARE}_{\text{DH3-BioPetrol}}$ = Annual output of heat to DH gr3 in share of biomass input

F_{BioJP} = Annual bio jet petrol production (TWh/year)

$\text{SHARE}_{\text{D-BioJP}}$ = Annual input of electricity to bio jet petrol plant in share of biomass input

$\text{SHARE}_{\text{STEAM-BioJP}}$ = Annual input of steam to bio jet petrol plant in share of biomass input

λ_{BioJP} = Production of steam efficiency (steam output divided by biomass input)

Ψ_{BioJP} = Biomass-to-bio jet petrol efficiency (petrol output divided by biomass input)

τ_{BioJP} = Biomass-to-food efficiency (jet petrol output divided by biomass input)
 P_{Food} = Price of food (E.g. DKK/MWh)
 $\text{SHARE}_{\text{DH3-BioJP}}$ = Annual output of heat to DH gr3 in share of biomass input

The biofuels input tab sheet is divided into Biodiesel, BioPetrol (i.e. bioethanol) and bio-jetfuel plants. For all plants, the annual electricity demand is either specified or given in terms of the share of the biomass input and is calculated as e.g.:

$$D_{\text{BioPetrol}} = F_{\text{BioPetrol-Biomass}} * \text{SHARE}_{\text{D-BioPetrol}}$$

The hourly electricity demand is calculated using the specified hourly distribution and is added hour by hour to the electricity demand specified in the Electricity Demand tab sheet.

$$d_{\text{BioPetrol}} = D_{\text{BioPetrol}} * \delta_{\text{BioPetrol}} / \sum \delta_{\text{BioPetrol}}$$

4.2.7.1.1. Biodiesel Plant

The biomass for biodiesel is simply calculated as follows

$$F_{\text{BioDiesel-DryBiomass}} = F_{\text{BioDiesel}} / \psi_{\text{BioDiesel}}$$

The model also includes a biomass fuel share resulting from the bio diesel production, which is calculated in a similar way to the bio diesel output:

$$F_{\text{BioDiesel-Biomass}} = F_{\text{BioPetrol-DryBiomass}} * \eta_{\text{BioDiesel}}$$

The biomass fuel output is subtracted from the biomass fuel used for power stations, etc., when calculating the resulting primary energy balance.

4.2.7.1.2. Bio Petrol Plant

The district heating production is calculated hour by hour and added to the CSHP and solar production. Bio petrol plants are assumed to be located only in connection to district heating group 3:

$$Q_{\text{BioPetrol-DH3}} = F_{\text{BioPetrol-Biomass}} * \text{SHARE}_{\text{DH3-BioPetrol}}$$

$$q_{\text{BioPetrol-DH3}} = Q_{\text{BioPetrol-DH3}} * \delta_{\text{BioPetrol-DH3}} / \sum \delta_{\text{BioPetrol-DH3}}$$

The district heating output is calculated as a share of the total biomass input and not the biomass input subtracted the biomass used for steam production, as in the case of the calculation of biopetrol and syngas.

With regard to electricity and steam and district heating output, the calculations are the same as described for the gasification plant above. In a similar way, the biomass fuel for steam production is added when calculating the consumption of biomass:

$$F_{\text{BioPetrol-Biomass}} = F_{\text{BioPetrol}} / \psi_{\text{BioPetrol}} + F_{\text{BioPetrol-steam}}$$

The model also includes a food bi-product of the bio petrol production, which is calculated in a similar way to the bio petrol output:

$$F_{\text{BioPetrol-Food}} = (F_{\text{BioPetrol-Biomass}} - F_{\text{BioPetrol-steam}}) * \tau_{\text{BioPetrol}}$$

The food bi-product is subtracted from the biomass fuel input in the calculation of the resulting primary energy balance. With regard to cost, the total biomass input to bio petrol production is included in the fuel cost, which is based on the price for biomass specified in the fuel cost tab sheet (see later). The model calculates the value of the food bi-product in the following way:

$$A_{\text{BioPetrol-Food}} = F_{\text{BioPetrol-Food}} * P_{\text{Food}}$$

The value of the food bi-product is subtracted from the fuel costs when calculating the total costs.

4.2.7.1.3. Bio JP (Jet Petrol) Plant

The Bio jet petrol plant is calculated in the same way as the BioPetrol Plant.

4.2.7.2. Biogases

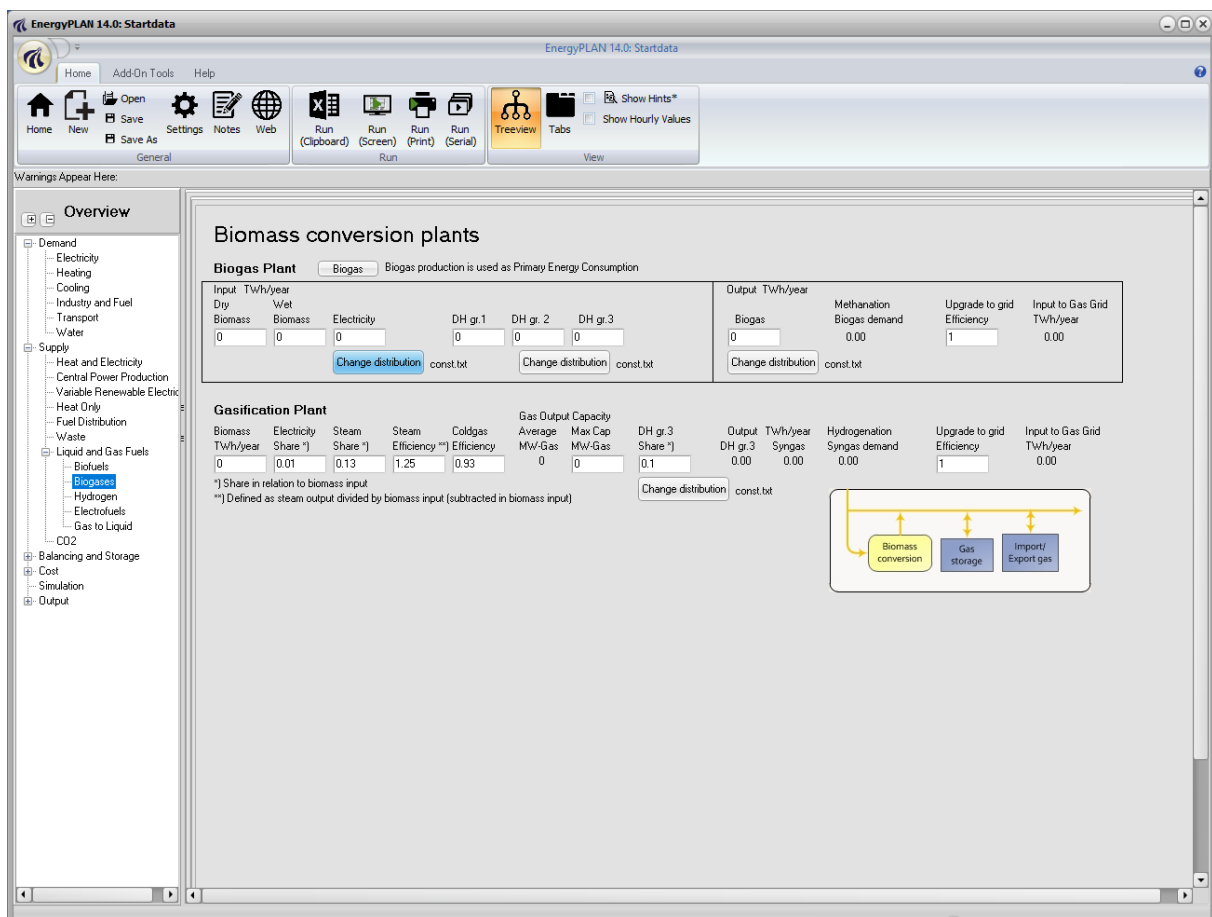

Input

D_{Biogas} = Annual electricity demand for biogas plant (TWh/year)

$H_{\text{BiogasDH1}}, \dots, H_{\text{BiogasDH3}}$ = Annual district heating demand for biogas in groups 1, 2 and 3 (TWh/year).

F_{Biogas} = Annual biogas production (TWh/year)
 $F_{\text{Biogas-WetBiomass}}$ = Annual input of wet biomass to biogas production (TWh/year)
 $F_{\text{Biogas-DryBiomass}}$ = Annual input of solid biomass to biogas production (TWh/year)
 κ_{Biogas} = Biogas to grid gas quality efficiency

 $F_{\text{Gasi-Biomass}}$ = Annual input of biomass to gasification production (TWh/year)
 $\text{SHARE}_{\text{D-Gasi}}$ = Annual input of electricity to gasification plant in share of biomass input
 $\text{SHARE}_{\text{STEAM-Gasi}}$ = Annual input of steam to gasification plant in share of biomass input
 λ_{GASI} = Production of steam efficiency (Steam output divided by biomass input)
 γ_{GASI} = Cold gas efficiency (Gas output divided by biomass input)
 $C_{\text{GASI-MAX}}$ = Capacity of the gasification plant (MW)
 $\text{SHARE}_{\text{DH3-Gasi}}$ = Annual output of heat to DH gr3 in share of biomass input
 κ_{Syngas} = Syngas to grid gas quality efficiency

 $C_{\text{Ngas-Storage}}$ = Capacity of gas storage connected to the gas grid (GWh)

The user can define the production of gas from bioenergy under the biogasses tabsheet. Two plants are currently considered: biogas plants and gasification plants.

For both plants, the annual electricity demand is added in the same way as for biofuel plants (see previous section). For the Biogas plant, the heat demand for each of the three district heating groups is calculated:

$$h_{\text{BiogasDH3}} = H_{\text{BiogasDH3}} * \delta_{\text{Biogas-DH3}} / \sum \delta_{\text{Biogas-DH3}}$$

4.2.7.2.1. Biogas

The biogas supplied to the grid is found through an upgrade to grid efficiency after the subtraction of biogas used for hydromethanation (See section 4.2.7.3):

$$F_{\text{Biogas-to-NgasGrid}} = (F_{\text{Biogas}} - F_{\text{Biogas-for-HydroMethanation}}) * \kappa_{\text{Biogas}}$$

If electricity and/or heat are needed in the upgrading process, such demands will have to be included in the specified electricity and heat demands.



The Wet and Solid biomass input represents, e.g., manure (Wet) and biofuel crops such as, e.g., grass or corn (Dry). In many biomass resource estimates, biogas is measured in the potential biogas production. However, it may also be relevant to distinguish between wet and solid biomass input. Consequently, one has the option to choose whether to include either the one or the other in the resulting primary energy balance. Such choice is made by activating the button at the top.

In the calculation, upgraded biogas is subtracted from the natural gas consumption. However, if one wants to use the biogas directly without upgrading it, one may simply set the biogas-to-Ngas efficiency to 1.

4.2.7.2.2. Gasification Plant

Similar to the biopetrol plants, the gasification district heating production is calculated hour by hour and added to the CSHP and solar production. Also, like biopetrol plants, the gasification plants are assumed to be located only in connection to district heating group 3. The district heating output is calculated as a share of the total biomass input and not the biomass input subtracted the biomass used for steam production, as in the case of the calculation of biopetrol and syngas.

The biomass input represents resources such as woodchips or straw and the price is defined in the fuel cost input tab sheet (see later). Gasification needs an input of steam in the production process. Such steam may be produced efficiently in combination with steam for CHP production at large power stations or it may be produced in separate boilers. Consequently, one can specify the steam efficiency. If one assumes that the production is integrated with large CHP plants, such efficiency may be set to, e.g., 1.25 representing the additional fuel input to the CHP plant. If one assumes that the production comes from separate boilers, the efficiency should be set to, e.g., 0.9 representing the boiler efficiency.

The fuel used for steam production is consequently calculated as follows:

$$F_{\text{Gasi-steam}} = (F_{\text{Gasi-Biomass}} * \text{SHARE}_{\text{STEAM-Gasi}}) / \lambda_{\text{GASI}}$$

When calculating the syngas output, the fuel used for steam production is subtracted from the biomass input:

$$F_{\text{Syngas}} = (F_{\text{Gasi-Biomass}} - F_{\text{Gasi-steam}}) * \gamma_{\text{GASI}}$$

The syngas supplied to the grid is found through an upgrade to grid efficiency after the subtraction of gasification gas used for electrofuels (See section 4.2.7.4):

$$F_{\text{Syngas-to-NgasGrid}} = (F_{\text{Syngas}} - F_{\text{gasigas-for-Hydrogenation}}) * \kappa_{\text{Syngas}}$$

Similar to the biogas plant, if electricity and/or heat are needed in the upgrading process, such demands will have to be included in the specified electricity and heat demands.

Based on the annual production of syngas, the average output is calculated representing the minimum capacity of the plant. However, one can specify a higher capacity input. If no capacity is specified or if the capacity is lower than the calculated minimum capacity, the model disregards the input and assumes investment in the minimum capacity. However, if a higher capacity is specified, the model uses such flexibility to minimise the import/export of gas upgraded to natural gas quality.

4.2.7.3. Hydrogen

The screenshot shows the EnergyPLAN 15 test: Startdata software interface. The main window is titled 'Electrolysers' and contains a table for configuring electrolysers. The table has columns for 'Electrolyser unit', 'Demand' (TWh/year), 'Capacities' (MW-e, MJ/s), 'Efficiencies' (fuel, DH gr2, DH gr3), and 'Hydrogen Storage' (GWh). The table lists various electrolysers units such as 'Transport and Electrofuel*', 'Transport (Hydrogen)', 'Industry (Hydrogen)', 'Electrofuel (Biomass)', 'Electrofuel (Biogas)', 'Electrofuel (CO2)', 'Ammonia (NH3)', 'Micro CHP', 'CHP and Boilers in Group 2', and 'CHP and Boilers in Group 3'. Each unit has input fields for its respective parameters. To the right of the table is a diagram showing a yellow box labeled 'Electro-lyser' with an arrow pointing to a blue box labeled 'H2 storage'.

Electrolyser unit	Demand TWh/year	Capacities		Efficiencies			Hydrogen Storage GWh
		MW-e	MJ/s	fuel	DH gr2	DH gr3	
Transport and Electrofuel*	0.00	0		0.73	0.00	0.05	0
Transport (Hydrogen)	0.00			0.73	0	0.05	
Industry (Hydrogen)	0.00			0.73	0	0.05	
Electrofuel (Biomass)	0.00			0.73	0	0.05	
Electrofuel (Biogas)	0.00			0.73	0	0.05	
Electrofuel (CO2)	0.00			0.73	0	0.05	
Ammonia (NH3)	0.00			0.73	0	0.05	
Micro CHP		0		0.73			0
CHP and Boilers in Group 2		0	0	0.73	0.05		0
CHP and Boilers in Group 3		0	0	0.73	0.05		0

Input

C_{Elc2} = Capacity of Electrolysers in district heating group 2
 C_{Elc3} = Capacity of Electrolysers in district heating group 3
 C_{ElcT} = Capacity of Electrolysers for Transport and electrofuels
 C_{ElcM} = Capacity of Electrolysers for Micro CHP
 α_{Elc2} = Fuel efficiency of Electrolysers in district heating group 2
 α_{Elc3} = Fuel efficiency of Electrolysers in district heating group 3
 α_{ElcTh} = Fuel efficiency of Electrolysers for Transport (Hydrogen)
 α_{Elcl} = Fuel efficiency of Electrolysers for Industry (Hydrogen)
 α_{ElcTc} = Fuel efficiency of Electrolysers for Transport (CO2)
 α_{ElcTbm} = Fuel efficiency of Electrolysers for Transport (Biomass)
 α_{ElcTbg} = Fuel efficiency of Electrolysers for Transport (Biogas)
 α_{ElcNH3} = Fuel efficiency of Electrolysers for Ammonia
 α_{ElcM} = Fuel efficiency of Electrolysers for Micro CHP
 ρ_{Elc2} = Thermal efficiency of Electrolysers in district heating group 2
 ρ_{Elc3} = Thermal efficiency of Electrolysers in district heating group 3
 S_{Elc2} = Capacity of Electrolysers Fuel Storage in district heating group 2
 S_{Elc3} = Capacity of Electrolysers Fuel Storage in district heating group 3
 S_{ElcT} = Capacity of Electrolysers Fuel Storage, Transport
 S_{ElcM} = Capacity of Electrolysers Fuel Storage, Micro CHP

In the Hydrogen input tab sheet one can specify the electrolyzers needed to produce the hydrogen input for transport and other purposes which have been specified in some of the other input tab sheets.

The model calculates the necessary capacities on the basis of similar calculations as shown for the micro H2 systems described in section 4.1.2.4. If the capacities are too small, the model writes out how much electrolyzers capacity is needed as a warning in the upper left corner. Note that if the capacity of the hydrogen storage is increased, the need for electrolyzers may decrease depending on the hourly profile of the demands.

In the model, the two last electrolyzers are located in either district heating group 2 or group 3 along with the CHP units, heat pumps and boilers. The other electrolyzers are used for hydrogen production for transport or electrofuels or micro CHP. The electrolyzers transform electricity into fuel and heat if located in connection to district heating. The electrolyzers are defined by capacity, fuel efficiency and thermal efficiency. Moreover, fuel storage is defined by capacity.

4.2.7.4. Electrofuels

Electrofuels production via electrolytic hydrogen and carbon sources

CO2 Hydrogenation (Producing electrofuels from CO2 and hydrogen)

CO2 (ton) and Hydrogen Input		Hydrogen		Output	Carbon Recycling		Flexibility				
CO2	Hydrogen	CO2/Syngas	(H2/SynGridGas)	TWh/year	Elec./CO2	Elec. demand	DH gr. 2	DH gr. 3	DH prod. (***)	Average	Max Cap
Mt	TWh/year	Mton/TWh	TWh/TWh	TWh/year	TWh/Mton	TWh/year	(Share of Elec. demand)	(Share of Elec. demand)	TWh/year	ton CO2/hour	ton CO2/hour
0.00	0.00	0.177	1.086	0	0.289	0.00	0	0.05	0.00	0	0
		0.252	1.153	0							

***) DH (District heating) is assumed a hourly constant output

N2 Hydrogenation (Producing ammonia (NH3) from N2 and H2)

N2 (ton) and Hydrogen Input		Hydrogen		Output	Nitrogen capture		Flexibility		
N2	Hydrogen	N2/NH3	(H2/NH3)	TWh/year	Elec./N2	Elec. demand	DH gr. 2	DH gr. 3	DH prod. (***)
Mt	TWh/year	Mton/TWh	TWh/TWh	TWh/year	TWh/Mton	TWh/year	(Share of Elec. demand)	(Share of Elec. demand)	TWh/year
0.00	0.00	0.146	0.948	0	0.107	0.00	0	0	0.00

Biomass Hydrogenation (Producing electrofuels from gasified biomass and hydrogen)

Gasification Gas and Hydrogen Input		Hydrogen		Output	Average	Flexibility		
Gasification	Hydrogen	Efficiency	Hydrogen	TWh/year	MW	DH gr. 2	DH gr. 3	DH prod. (***)
TWh/year	TWh/year	%	Share (**)	TWh/year		(Share of Gas+Hydrogen)	(Share of Gas+Hydrogen)	TWh/y
0.00	0.00	1.018	0.552	0	0	0	0.05	0.00
		0.992	0.38	0	0			

Biogas Hydrogenation (Producing electrofuels from biogas and hydrogen)

Biogas and Hydrogen Input		Hydrogen		Output	Average	Flexibility		
Biogas	Hydrogen	Efficiency	Hydrogen	TWh/year	MW	DH gr. 2	DH gr. 3	DH prod. (***)
TWh/year	TWh/year	%	Share (**)	TWh/year		(Share of Gas+Hydrogen)	(Share of Gas+Hydrogen)	TWh/y
0.00	0.00	0.82	0.37	0	0	0	0.05	0.00
				0	0			

Liquid electrofuel synthesis

Input		Output ElectroP		Output Methanol		Output DME	
Liquid fuel demand	Output ElectroP	Efficiency	Output Methanol	Efficiency	Output DME	Efficiency	
TWh/year	TWh/year		TWh/year	TWh/year	TWh/year	TWh/year	
0.00	0.00	0.8	0.00	1	0.00	1	

*) Efficiency = Gas or Liquid Fuel output per gas and hydrogen input
 **) Hydrogen share = Hydrogen share of hydrogen plus gas input

Liquid Fuel Balance

Demand	0.00
Production	0.00

Flow Diagram: A schematic diagram showing CO2 entering a Hydrogenation unit, which produces SynGridGas and LiqFuel. A Biogas conversion unit also feeds into the Hydrogenation unit.

Input

$F_{CO_2Hydro-GridGas}$ = Annual production of synthetic gas for the gas grid (TWh/year)
 $F_{CO_2Hydro-Liquid}$ = Annual production of liquid electrofuels (TWh/year)
 $C_{CO_2Hydro-MAX}$ = Capacity of the CO₂ Hydrogenation plant (MW)
 $\lambda_{CO_2Sequestration-Elec}$ = Electricity demand for CO₂ capture (TWh/Mton)
 $\gamma_{CO_2Sequestration-CO_2Demand}$ = Demand for CO₂ per synthetic gas production unit (Mton/TWh)
 $\mu_{CO_2Hydro-Hydrogendemand}$ = Demand for hydrogen per syntetic gas production unit ((TWh/TWh)
 $SHARE_{DH2-CO_2Hydro}, SHARE_{DH3-CO_2Hydro}$ = Annual heat to DH gr2 and 3 in share of total electricity demand

$F_{NH_3-Liquid}$ = Annual production of ammonia (TWh/year)
 $\lambda_{N_2Capture-Elec}$ = Electricity demand for N₂ capture (TWh/Mton)
 $\gamma_{N_2Capture-N_2Demand}$ = Demand for N₂ per NH₃ production unit (Mton/TWh)
 $\mu_{NH_3-Hydrogendemand}$ = Demand for hydrogen per NH₃ production unit ((TWh/TWh)
 $SHARE_{DH2-NH_3}, SHARE_{DH3-NH_3}$ = Annual heat to DH gr2 and 3 in share of total electricity demand

$F_{SynHydro-GridGas}$ = Annual production of synthetic gas for the gas grid (TWh/year)
 $F_{SynHydro-Liquid}$ = Annual production of liquid electrofuels (TWh/year)
 $C_{SynHydro-MAX}$ = Capacity of the Hydrogenation plant (MW)
 $K_{SynHydro}$ = (Hydrogen+GasificationGas)-to-SyntheticGridGas efficiency
 $\gamma_{SynHydro-HydrogenShare}$ = Hydrogen share of total input (Hydrogen plus Gasification gas)

$F_{SynMethane-GridGas}$ = Annual production of synthetic gas for the gas grid (TWh/year)
 $F_{SynMethane-Liquid}$ = Annual production of liquid electrofuels (TWh/year)
 $C_{SynMethane-MAX}$ = Capacity of the Hydrogenation plant (MW)
 $K_{SynMethane}$ = (Hydrogen+GasificationGas)-to-SyntheticGridGas efficiency
 $\gamma_{SynMethane-HydrogenShare}$ = Hydrogen share of total input (Hydrogen plus Gasification gas)

$F_{SynJP}, F_{SynPetrol}, F_{SynDiesel}$ = Annual production of electro Jet Petrol, Methanol and DME (TWh/year) $K_{SynJP}, K_{SynPetrol}, K_{SynDiesel}$ = Additional conversion losses

The Electrofuel tab sheet covers synthetic gas and liquid fuel production and includes plants and units which convert hydrogen and biomass, in terms of biogas and gasification gas, into synthetic grid gas and liquid electrofuel, such as methanol, DME and jet petrol.

Hydrogen, biogas and gasification gas are transferred from the Hydrogen and biogases tab sheets. Synthetic grid gas is produced for the gas grid and electrofuels are transferred to the transportation tab sheet.

For each of the units, the following initial calculations are made simultaneous with the entry of inputs into the tab sheet:

4.2.7.4.1. CO₂ Hydrogenation Plant

The CO₂ and the Hydrogen demands for CO₂ capturing is calculated from the specified efficiencies in terms of CO₂ demand per synthetic gas production or liquid fuel production (Mton/TWh) and Hydrogen demand (TWh/TWh):

$$CO_{2CO_2Hydro-demand} = F_{CO_2Hydro-GridGas} * \gamma_{CO_2Sequestration-CO_2Demand}$$

$$H_{2CO_2Hydro-demand} = F_{CO_2Hydro-GridGas} * \mu_{CO_2Hydro-Hydrogendemand}$$

The necessary minimum capacity of the CO₂ Hydrogenation plant is calculated as the average of the annual production:

$$C_{\text{CO}_2\text{Hydro-Average}} = \text{CO}_2\text{CO}_2\text{Hydro-demand} * 1000000 / 8784$$

One can add extra capacity and in such case the model will try to use such extra capacity in the simulations to assist in the balancing of electricity demand and supply.

The electricity consumption for CO₂ sequestration is calculated from the CO₂ demand:

$$D_{\text{CO}_2\text{Hydro-Sequestration}} = \text{CO}_2\text{CO}_2\text{Hydro-demand} * \lambda_{\text{CO}_2\text{Sequestration-Elec}}$$

The contribution to district heating in groups 2 and 3 is calculated hour by hour and added to the CSHP and solar production. When calculating the hourly distribution, a constant output is assumed.

$$Q_{\text{CO}_2\text{Hydro-DH3}} = D_{\text{CO}_2\text{Hydro-Sum}} * \text{SHARE}_{\text{DH3-CO}_2\text{Hydro}}$$

$$q_{\text{CO}_2\text{Hydro-DH3}} = Q_{\text{CO}_2\text{Hydro-DH3}} * 1000000 / 8784$$

4.2.7.4.2. Hydrogenation of Gasified Biomass and Biogas:

The initial calculations regarding hydrogenation of gasified biomass and biogas are similar and here illustrated for the hydrogenation of syngas from biomass gasification.

The total demand for both hydrogen and gasification gas is calculated:

$$F_{\text{SynHydro-TotalInput}} = F_{\text{SynHydro-GridGas}} / \kappa_{\text{SynHydro}}$$

The separate demands for hydrogen and gasification gas are then found:

$$F_{\text{SynHydro-HydrogenDemand}} = F_{\text{SynHydro-TotalInput}} * \gamma_{\text{SynHydro-HydrogenShare}}$$

$$F_{\text{gasigas-for-Hydrogenation}} = F_{\text{SynHydro-TotalInput}} - F_{\text{SynHydro-HydrogenDemand}}$$

The necessary minimum capacity of the Hydrogenation plant is calculated as the average of the annual production:

$$C_{\text{SynHydro-Average}} = F_{\text{SynHydro-GridGas}} * 1000000 / 8784$$

The resulting demands for biogas and gasification gas are transferred to the Biogases Conversion tab sheet and subtracted in the productions before being upgraded to grid gas quality, as described in section 4.2.7.1.

4.2.7.4.3. Liquid electrofuel synthesis

For all three types of liquid electrofuels (methanol, DME and electro JP), the output and potential extra losses are specified and the resulting demand for liquid fuel demand calculated as:

$$F_{\text{Liquid}} = F_{\text{SynJP}} / \kappa_{\text{SynJP}} + F_{\text{SynPetrol}} / \kappa_{\text{SynPetrol}} + F_{\text{SynDiesel}} / \kappa_{\text{SynDiesel}}$$

4.2.8. CO2

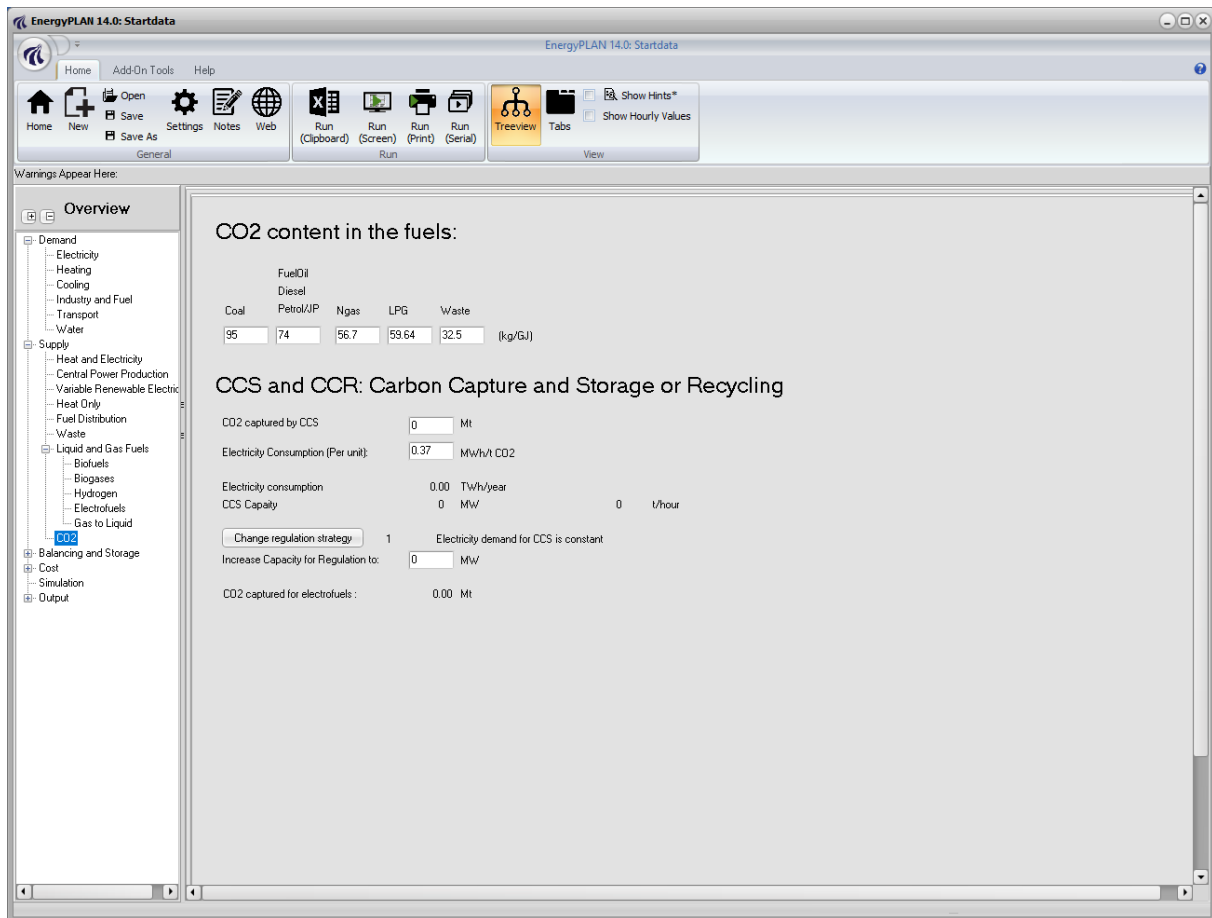

Input

CO₂ emission factors (kg/GJ)

CO_{2Coal} , CO_{2Oil} , CO_{2Ngas} , CO_{2Waste} = CO₂ emission factors

CCS captured:

D_{CCS} : Annual Demand for CO₂ captured by CCS (Mt)

$D_{CCS-Electro}$: Annual captured CO₂ for electrofuels (Mt).

CCS Plant:

C_{CCS} : Capacity CCS Plant (m³ Fresh Water/hour)

μ_{CCS} : Electricity efficiency (MWh/t CO₂)

The calculation of CCS is prepared for different regulation strategies in future versions of the EnergyPLAN tool. However in the current version 13.0 only the regulation strategy “Electricity demand for CCS is constant” has been implemented.

The calculation is very simple:

The input demand for CO2 capturing (D_{CCS}) is simply subtracted from the resulting CO2 emission. In the print output the subtraction can be found in the lower left corner of the first page.

The electricity demand (e_{CCS}) is added to the total electricity demand and found as follows:

$$e_{CCS} = \mu_{CCS} * D_{CCS} / 8784 \text{ hours}$$

4.3. Balancing and Storage

4.3.1. Electricity

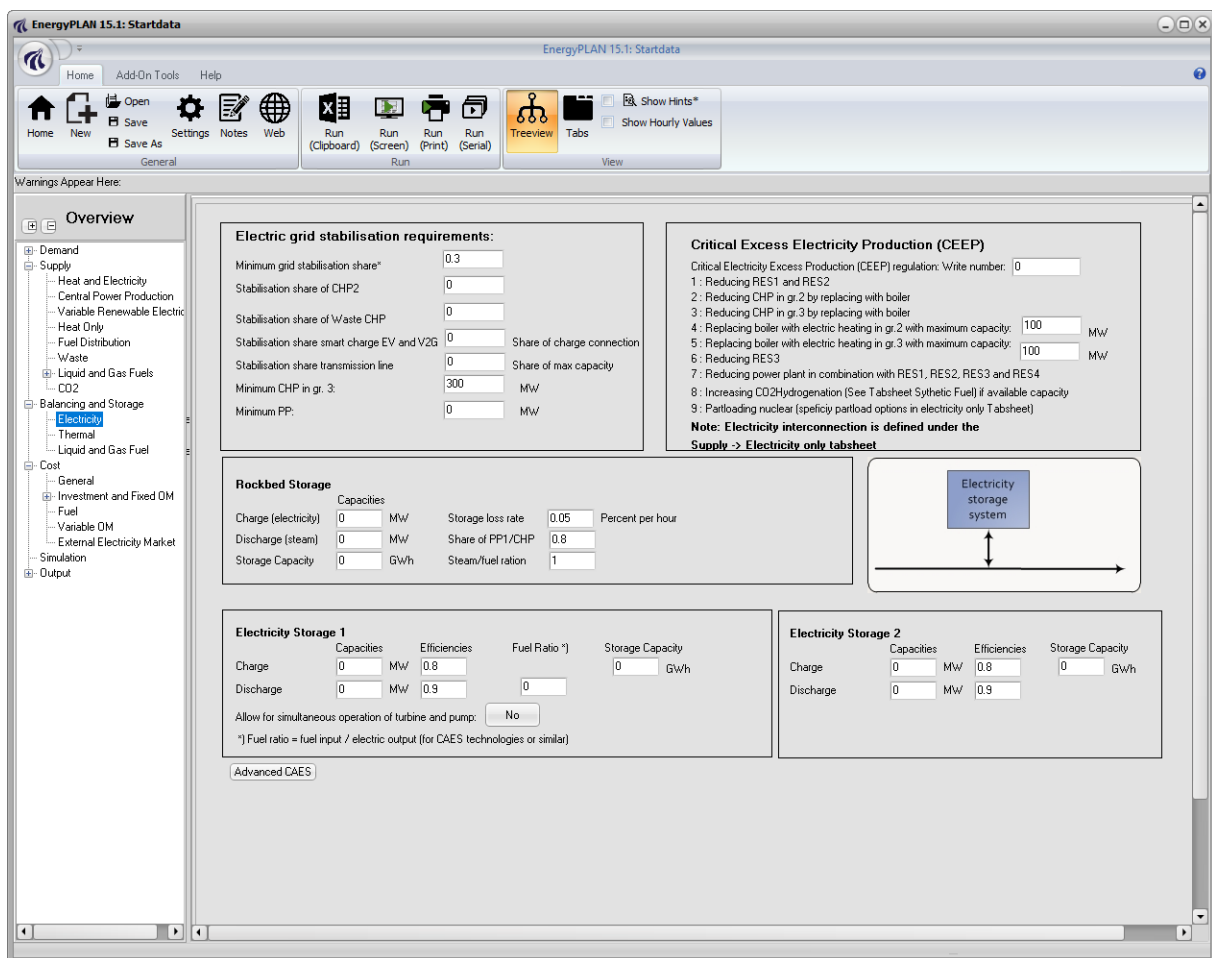

Input

Electric grid stabilisation requirements:

$Stab_{Total}$ = Demand for grid-stabilising units in percentage of total electricity production

$Stab_{CHP2}$ = Share of CHP2 units which can provide grid stabilisation

$LIMIT_{HP}$ = Maximum heat production form heat pumps

$Stab_{Waste}$ = Share of Waste CHP units which can provide grid stabilisation

$Stab_{V2G}$ = Share of V2G and EV (Electric Vehicle) units which can provide grid stabilisation

$Stab_{TRANS}$ = Share of transmission line capacity which can provide grid stabilisation

$C_{CHP3-Min}$ = Minimum production on CHP units in DH group 3
 C_{PP-Min} = Minimum production on PP units
 C_{EP2} = Capacity of Electric Boiler in DH group 2
 C_{EP3} = Capacity of Electric Boiler in DH group 3

4.3.1.1. Choice of Critical Excess Electricity Production (CEEP) Regulation Strategy

The electrical connection to external electricity markets is limited by the defined capacity of the transmission lines. Based on such limitation, the model identifies Critical Excess Electricity Production (CEEP) as the export which exceeds the transmission line capacity. Such production is not allowed in real life, since this will cause a breakdown in the electricity supply.

However, the model allows CEEP in order to be able to calculate the magnitude as a consequence of different regulation strategies, or one can ask the model to avoid CEEP.

Nine options to remove critical excess electricity production can be activated:

- 1: Reducing RES1 and RES2
- 2: Reducing CHP production in group 2 (Replacing with boiler)
- 3: Reducing CHP production in group 3 (Replacing with boiler)
- 4: Replacing boiler production with electric heating in group 2.
- 5: Replacing boiler production with electric heating in group 3.
- 6: Reducing RES4 and RES5
- 7: Reducing power plant production in combination with RES1, RES2, RES3 and RES4
- 8: Increasing CO₂Hydrogenation (See Tab sheet Sythetic Fuel) if available capacity
- 9: Partloading nuclear (specify partload option in Electricity Only tabsheet)

The nine possibilities are activated according to an order of priority. If, for instance, "CEEP regulation" is given as 23547 (referring to the numbers in the above list), critical excess production will be removed first by replacing CHP in groups 2 and 3, then by electric heating and, in the end, by decreasing electricity production from RES1-RES4 together with power plants. For "CEEP regulation" = 51 (referring to the list above), excess production is removed first by increasing electric heating only in group 3 and then by stopping RES1 and RES2. All nine options can be activated in all possible combinations.

Chapter 8 explains the calculation of CEEP reduction and the specific difference between the options.

4.3.1.2. Grid Stabilisation Restrictions

The model conducts an hourly calculation and basically assumes that all production units can change production from one hour to another. However, especially large steam turbine CHP or extraction plants have difficulties in going below a certain technical minimum, typically 20% of max capacity. Therefore, one can specify a minimum CHP3 production. Such minimum production serves as a minimum for extraction plants (constituted by the combination of CHP3 and PP). However, in the modelling of a system with no CHP and/or no extraction plants, one can choose to specify a minimum PP production instead.

Apart from such minimum production, one can specify limitations on the operation in order to assure grid stability. A certain percentage (30 per cent is recommended) of the total electricity production

must come from grid-stabilising units. CHP in group 3 and large power plants including hydro, geothermal and nuclear power are assumed to have such stabilising abilities. In addition, one can specify to which extent small CHPs in group 2 and RES units can provide grid stabilisation.

4.3.1.3. Electricity Storage

Rockbed Storage <table border="0"> <tr> <td colspan="2">Capacities</td> <td>Storage loss rate</td> <td>0.05</td> <td>Percent per hour</td> </tr> <tr> <td>Charge (electricity)</td> <td>0</td> <td>MW</td> <td>Share of PP1/CHP</td> <td>0.8</td> </tr> <tr> <td>Discharge (steam)</td> <td>0</td> <td>MW</td> <td>Steam/fuel ration</td> <td>1</td> </tr> <tr> <td>Storage Capacity</td> <td>0</td> <td>GWh</td> <td></td> <td></td> </tr> </table>				Capacities		Storage loss rate	0.05	Percent per hour	Charge (electricity)	0	MW	Share of PP1/CHP	0.8	Discharge (steam)	0	MW	Steam/fuel ration	1	Storage Capacity	0	GWh															
Capacities		Storage loss rate	0.05	Percent per hour																																
Charge (electricity)	0	MW	Share of PP1/CHP	0.8																																
Discharge (steam)	0	MW	Steam/fuel ration	1																																
Storage Capacity	0	GWh																																		
Electricity Storage 1 <table border="0"> <tr> <td>Capacities</td> <td>Efficiencies</td> <td>Fuel Ratio *)</td> <td>Storage Capacity</td> </tr> <tr> <td>Charge</td> <td>0</td> <td>MW</td> <td>0.8</td> <td>0</td> <td>GWh</td> </tr> <tr> <td>Discharge</td> <td>0</td> <td>MW</td> <td>0.9</td> <td>0</td> <td></td> </tr> </table> <p>Allow for simultaneous operation of turbine and pump: <input type="button" value="No"/></p> <p>*) Fuel ratio = fuel input / electric output (for CAES technologies or similar)</p>			Capacities	Efficiencies	Fuel Ratio *)	Storage Capacity	Charge	0	MW	0.8	0	GWh	Discharge	0	MW	0.9	0		Electricity Storage 2 <table border="0"> <tr> <td>Capacities</td> <td>Efficiencies</td> <td>Storage Capacity</td> </tr> <tr> <td>Charge</td> <td>0</td> <td>MW</td> <td>0.8</td> <td>0</td> <td>GWh</td> </tr> <tr> <td>Discharge</td> <td>0</td> <td>MW</td> <td>0.9</td> <td></td> <td></td> </tr> </table>			Capacities	Efficiencies	Storage Capacity	Charge	0	MW	0.8	0	GWh	Discharge	0	MW	0.9		
Capacities	Efficiencies	Fuel Ratio *)	Storage Capacity																																	
Charge	0	MW	0.8	0	GWh																															
Discharge	0	MW	0.9	0																																
Capacities	Efficiencies	Storage Capacity																																		
Charge	0	MW	0.8	0	GWh																															
Discharge	0	MW	0.9																																	
<input type="button" value="Advanced CAES"/>																																				

Input

Electricity Storage

C_{charge} = Capacity of Pump in electricity storage

$C_{\text{discharge}}$ = Capacity of Turbine in electricity storage

S_{CAES} = Capacity of Storage, electricity storage system

α_{Pump} = Efficiency of Pump in electricity storage (from electricity to storage input)

μ_{Turbine} = Efficiency of Turbine in electricity storage (from storage output to electricity)

ϕ_{CAES} = Fuel ratio for CAES systems (fuel input / electric output)

Electricity Storage2

C_{charge2} = Capacity of Pump in electricity storage

$C_{\text{discharge2}}$ = Capacity of Turbine in electricity storage

S_{CAES2} = Capacity of Storage, electricity storage system

α_{Pump2} = Efficiency of Pump in electricity storage (from electricity to storage input)

μ_{Turbine2} = Efficiency of Turbine in electricity storage (from storage output to electricity)

Rockbed storage (High temperature electricity storage)

$C_{\text{electricity}}$ = Charge capacity based on MW electricity

C_{steam} = Discharge capacity based on MW steam delivered to PP/CHP.

S_{Rockbed} = Steam storage capacity

$LOSS_{\text{Rockbed}}$ = Storage loss in energy content every hour

$SHARE_{\text{Rockbed}}$ = Share of PP/CHP plants with access to steam from storage

$RATIO_{\text{Fuel}}$ = Ratio for how much fuel 1 unit of steam can replace.

The electricity storage can represent, e.g., hydro pump storage, a battery or an FC/electrolyser hydrogen storage and is represented by the following inputs:

- Pump (converting electricity to potential energy) defined by capacity and efficiency
- Turbine (converting potential energy to electricity) defined by capacity and efficiency
- Storage (storing energy) defined by capacity.

The model can also add fuel when the turbine is activated, thereby facilitating the modelling of technologies such as CAES (Compressed Air Energy Storage). In such case, the following input has to be defined:

- CAES fuel ratio defined as CAES fuel consumption / electric output.

Advanced CAES

In the lower left corner, there is a button called “advanced CAES”. By activating this button, a number of business-economic optimisation strategies may be included which involve the operation of electricity storage technologies, such as, e.g., CAES on various markets. For further description please consult Chapter 10.

The screenshot shows a software interface for configuring electricity storage. It is divided into two main panels: 'Electricity Storage 1' and 'Electricity Storage 2'. Each panel has input fields for 'Charge' and 'Discharge' capacities (in MW), efficiencies (0.8 and 0.9 respectively), and 'Storage Capacity' (in GWh). Below these panels is an 'Advanced CAES' section with a 'Calculate' button and a dropdown menu set to 'Strategy 4 - Practical Prognostic Strategy'. This section contains various cost and price parameters: Compressor variable operation costs (0 DKK/MWh), Compressor taxes (0 DKK/MWh), Turbine variable operation cost (0 DKK/MWh), Natural Gas price (100 DKK/MWh), and Market average price (227 DKK/MWh). It also lists several 'price' parameters: Income electricity (MDKK), Cost electricity (MDKK), Cost compressor operation (MDKK), Cost compressor Taxes, Cost turbine operation (MDKK), Cost natural gas (MDKK), Value of storage dif (MDKK), Net income (MDKK), and Max storage (GWh). To the right, there is a section for 'Define profit margin increase of Electricity Storage 2 in percent of min profit margin:' with a 'NonActive' button and a '0' input field. Below this are 'Turbine Market volumen Limits' and 'Compressor Market volumen Limits', both with 'Change distribution' buttons and 'const.txt' labels. At the bottom right, there is a checkbox for 'Allow for simultaneous operation of turbine and pump:' set to 'Yes'.

As a new feature (implemented in version 15.1), one can define a profit margin increase of electricity storage 2. The input is a percentage of the minimum profit rate. If e.g. 20 is inserted, the minimum profit rate will be multiplied by a factor 1.2. The minimum profit rate is calculated as the minimum difference between electricity sales and buying prices that the storage will have to identify in order not to lose on a trade given the efficiencies and variable operation costs of the plant. Such a calculation is further detailed in section 7.9.

The use of Rockbed Storage (High temperature electricity storage) facilitates the storage of excess electricity as steam, enabling it to feed into the CHP3 / PP1 technology. Thus it can replace fuel consumption.

4.3.2. Thermal

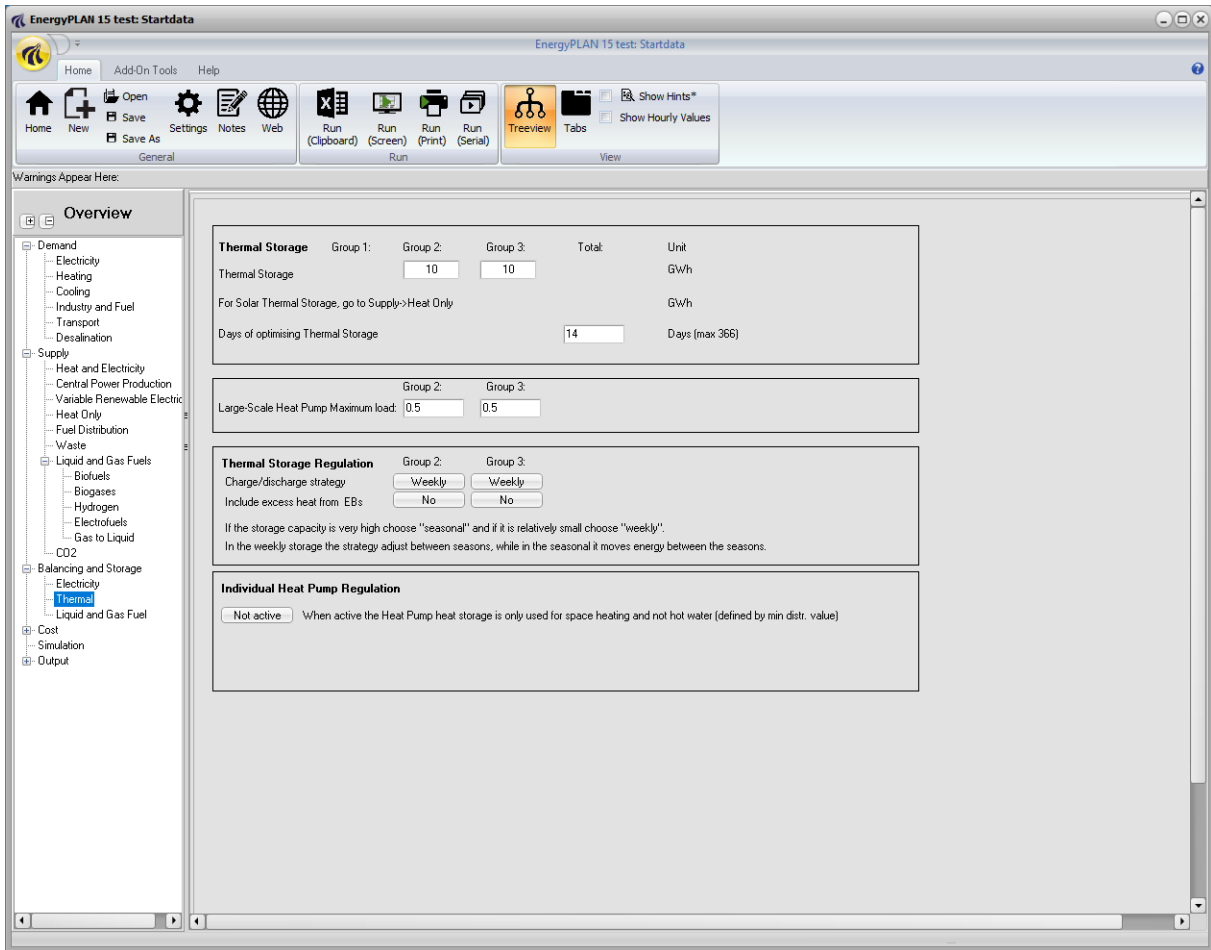

Input

Heat storage

S_{DH2} = Capacity, Heat storage in district heating group 2 (GWh)

S_{DH3} = Capacity, Heat storage in district heating group 3 (GWh)

4.3.2.1. Disclosing heat storage for hot water in micro heat pumps

In the lower left corner, there is a button to activate a special regulation strategy only for micro heat pumps. If the button is activated the model will not use the heat storage for hot water but only for space heating.

Individual Heat Pump Regulation

Active When active the Heat Pump heat storage is only used for space heating and not hot water (defined by min distr. value)

Max. loading when storage is empty corresponding to max. unloading when storage is full (given in share of max. heat demand)

Max. loading when storage is full corresponding to max. unloading when storage is empty (given in share of max. heat demand)

The idea is to be able to calculate heat storage options such as heat capacities built into the material of the buildings. If this button is activated the model will separate the heat demand for hot water from the heat demand for space heating. The heat demand for hot water is simply defined as the minimum value of the hourly distribution of the heat demand. Additionally, one can define limitations on the loading and un-loading of the storage as a function of the load of the storage.

4.3.3. Liquid and Gas Fuel

Input
$C_{\text{Ngas-Storage}}$ = Capacity of gas storage connected to the gas grid (GWh) $C_{\text{Oil-Storage}}$ = Capacity of oil storage (GWh) $C_{\text{Methanol-Storage}}$ = Capacity of methanol storage (GWh)

The model allows a specification of the capacity of the gas grid storage. The storage is used when calculating the resulting import/export of natural gas described in section 8.7.

It is also possible to specify an oil and methanol storage capacity. This are not connected to the balancing of the gas grid, but they are used for calculating the total costs of the energy system (see section 4.4.2).

4.4. Cost

4.4.1. General

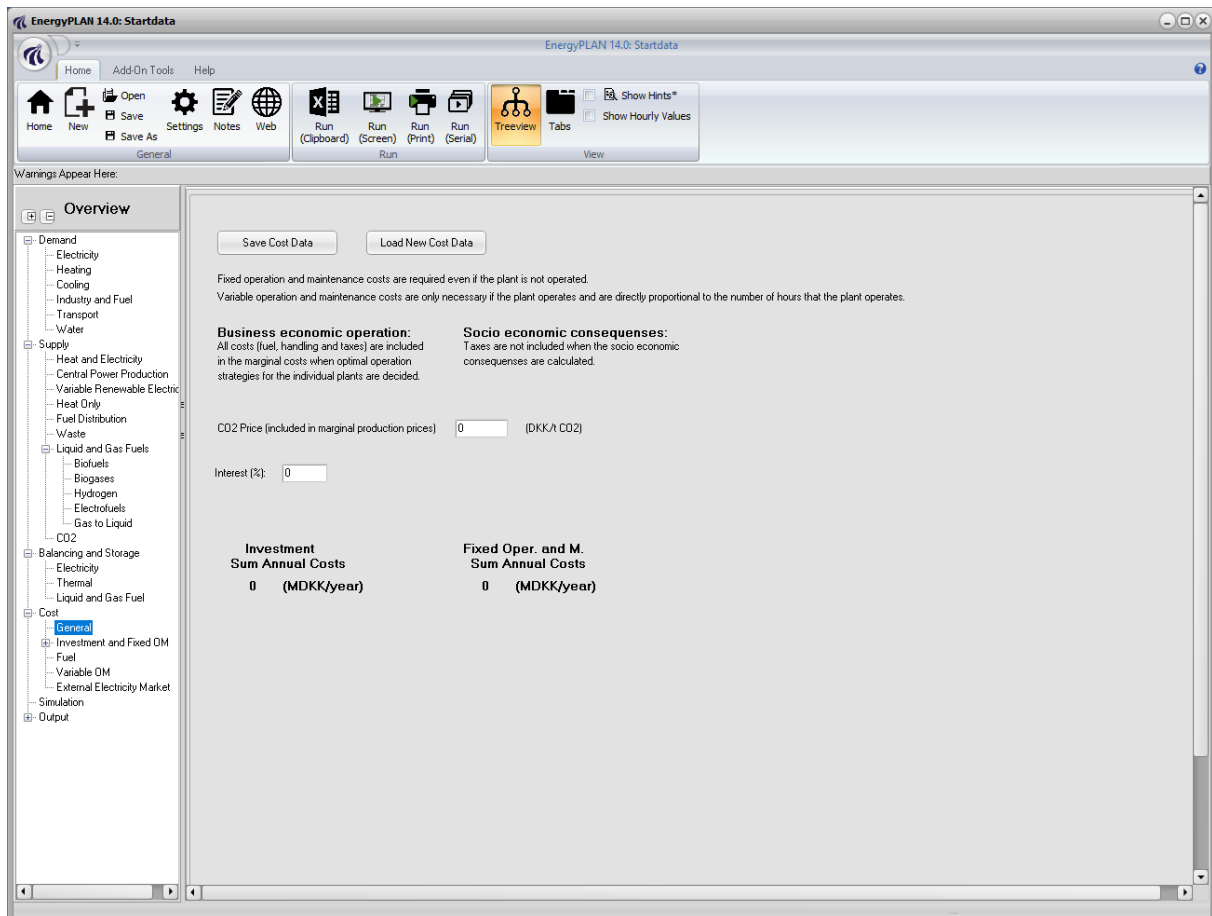

As shown in the diagram, the cost data of the model are divided into: Investment, Fuel, Operation & Maintenance, and External Electricity Market costs.

An analysis using technical simulation strategies can be done solely on technical data from the ten input tab sheets described in the previous section. However, if one wants to include either market-economic simulation or if a feasibility study is conducted; further inputs are required in the “cost” section.

In the guidelines on how to use the EnergyPLAN model, one can learn how to conduct feasibility studies and market exchange studies when cost data input are provided for the model. Such analyses are conducted in exercise 5 and guidelines. Both can be found at www.EnergyPLAN.eu.

The General cost tabsheet enables the user to Save and Load EnergyPLAN cost files. It also provides some brief descriptions about the type of costs considered in the model, along with a display for the total investment and fixed O&M costs. Finally, general cost assumptions like the interest rate and CO2 price can be defined in the general tabsheet.

4.4.2. Investment and Fixed Operation and Maintenance

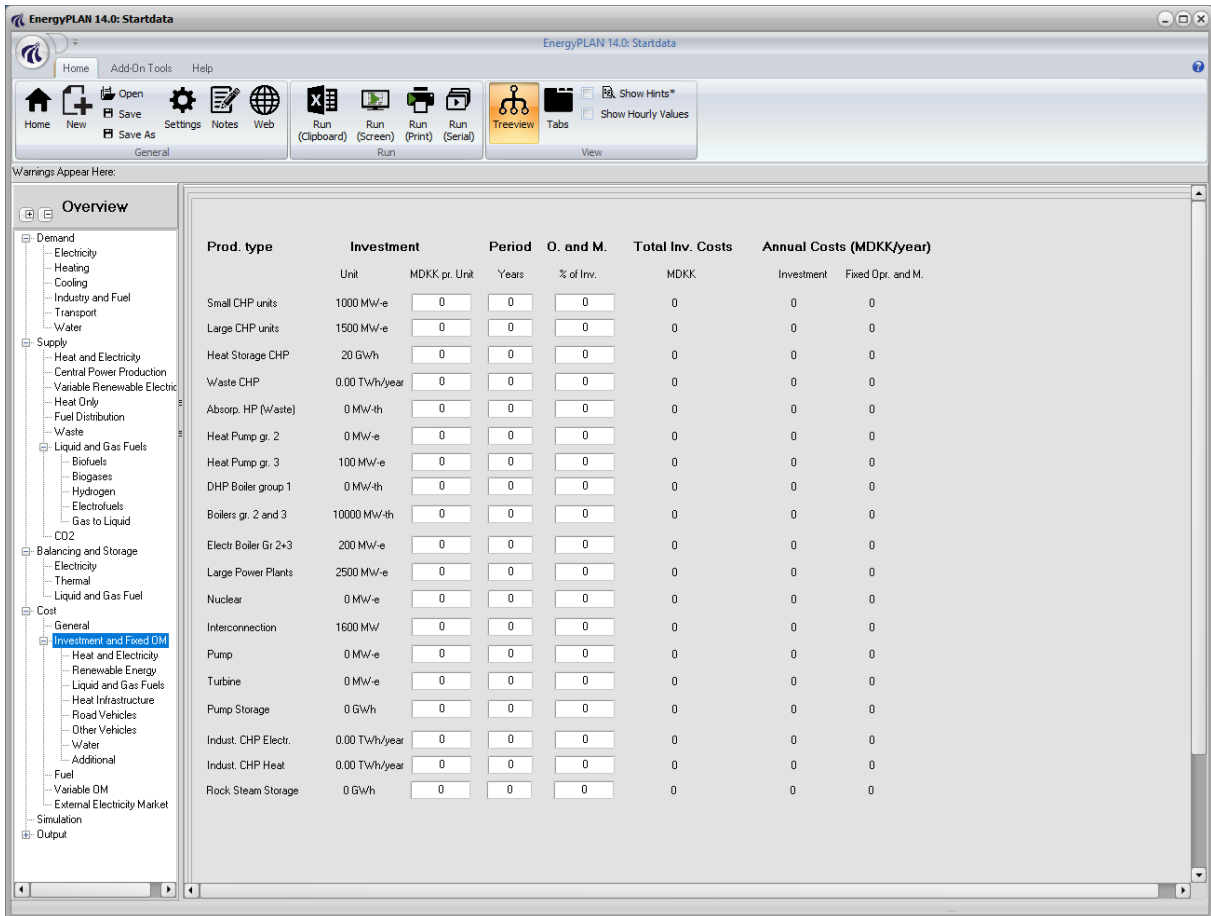

Input

For each component (here shown for wind):

$P_{\text{Unit-Wind}}$ = Per unit price

n_{Wind} = lifetime of investment

$P_{\text{FOC-Wind}}$ = Fixed annual operational costs in percentage of total investment

Common to all calculations:

i = calculation interest (real interest) used for socio-economic evaluation

In the Investment Cost tab sheet, the model summarises the input capacity specifications for the production units, and one can add unit prices, lifetimes and fixed operation and maintenance costs. Also, one must enter an interest rate for the whole calculation. The total investment (I) of each production unit is simply calculated as:

$$I_{\text{Wind}} = C_{\text{Wind}} * P_{\text{Unit-Wind}}$$

The model then calculates the annual costs of each component divided into investment costs and fixed operation and maintenance costs.

The annual costs, $A_{\text{Investment}}$, are calculated as follows:

$$A_{\text{Investment-Wind}} = I_{\text{Wind}} * i / [1 - (1+i)^{-n}]$$

In which

- I_{Wind} are the investment costs found by multiplying the number of units by the cost unit (MDKK per unit). The unit is shown for each component. E.g., the unit for large CHP is MW, and consequently, the cost is given in million DKK/MW.
- n is the lifetime given in years.
- i is the interest

The annual fixed operational costs, A_{FOC} , are calculated as follows:

$$A_{\text{FOC-Wind}} = P_{\text{FOC-Wind}} * I_{\text{Wind}}$$

In which

- P_{FOC} is the annual fixed operation and maintenance costs given in percentage of the investment cost.

4.4.2.1. Additional Cost

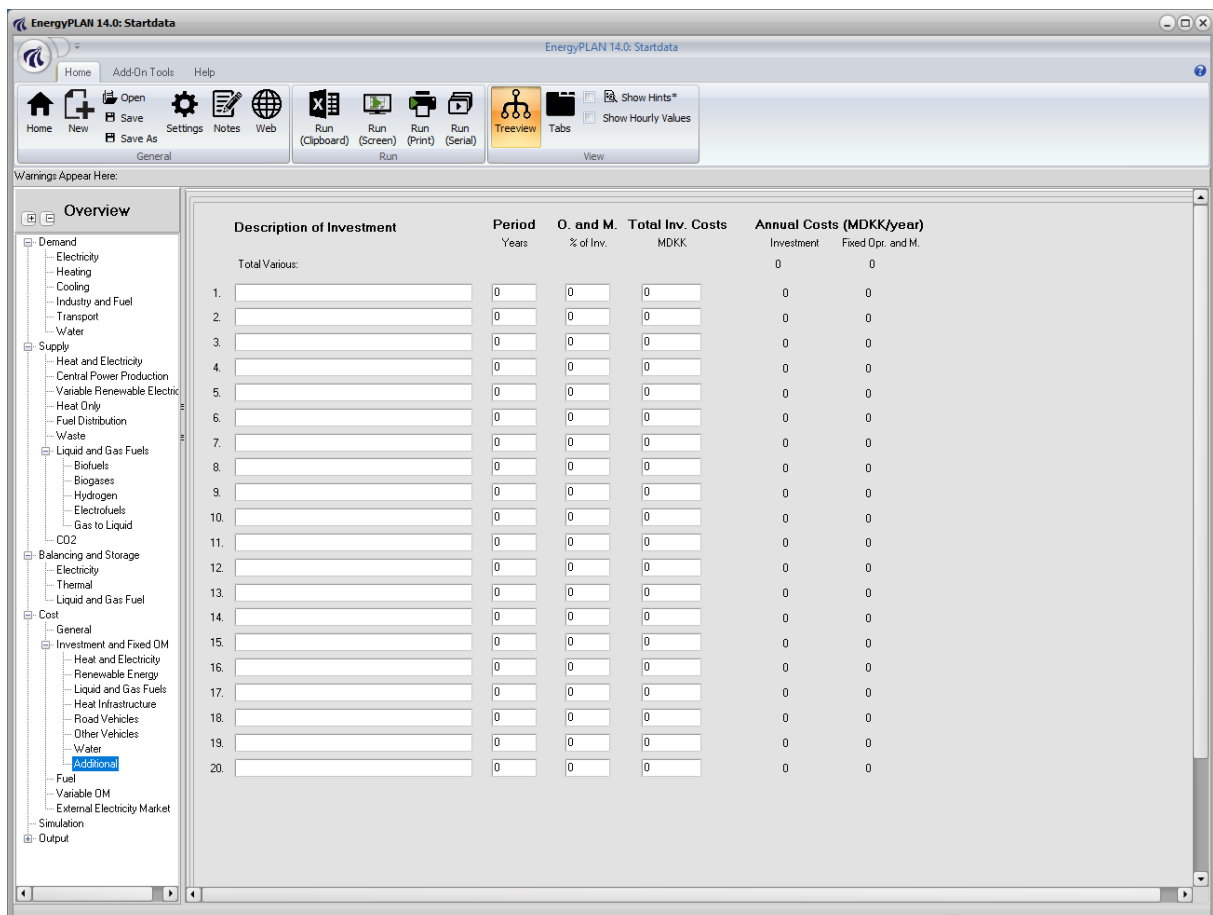

The screenshot shows the EnergyPLAN 14.0: Startdata software interface. The main window displays a table titled 'Description of Investment' with the following columns: 'Description of Investment', 'Period (Years)', 'O. and M. (% of Inv.)', 'Total Inv. Costs (MDKK)', and 'Annual Costs (MDKK/year)'. The 'Annual Costs' column is further divided into 'Investment' and 'Fixed Opr. and M.'. The table contains 20 rows, with the first row labeled 'Total Various' and the remaining rows numbered 1 through 20. All values in the table are currently set to 0. On the left side, there is a tree view under 'Overview' with categories like Demand, Supply, Balancing and Storage, Cost, and Simulation. The 'Additional' category is highlighted in blue.

Description of Investment	Period Years	O. and M. % of Inv.	Total Inv. Costs MDKK	Annual Costs (MDKK/year)	
				Investment	Fixed Opr. and M.
Total Various:				0	0
1.	0	0	0	0	0
2.	0	0	0	0	0
3.	0	0	0	0	0
4.	0	0	0	0	0
5.	0	0	0	0	0
6.	0	0	0	0	0
7.	0	0	0	0	0
8.	0	0	0	0	0
9.	0	0	0	0	0
10.	0	0	0	0	0
11.	0	0	0	0	0
12.	0	0	0	0	0
13.	0	0	0	0	0
14.	0	0	0	0	0
15.	0	0	0	0	0
16.	0	0	0	0	0
17.	0	0	0	0	0
18.	0	0	0	0	0
19.	0	0	0	0	0
20.	0	0	0	0	0

In the Additional Cost tab sheet, one can add and specify additional cost, i.e., investments that are not directly connected to the production units, such as the insulation of buildings, transport infrastructure, etc.

The additional costs are included in the calculation of total costs.

4.4.3. Fuel

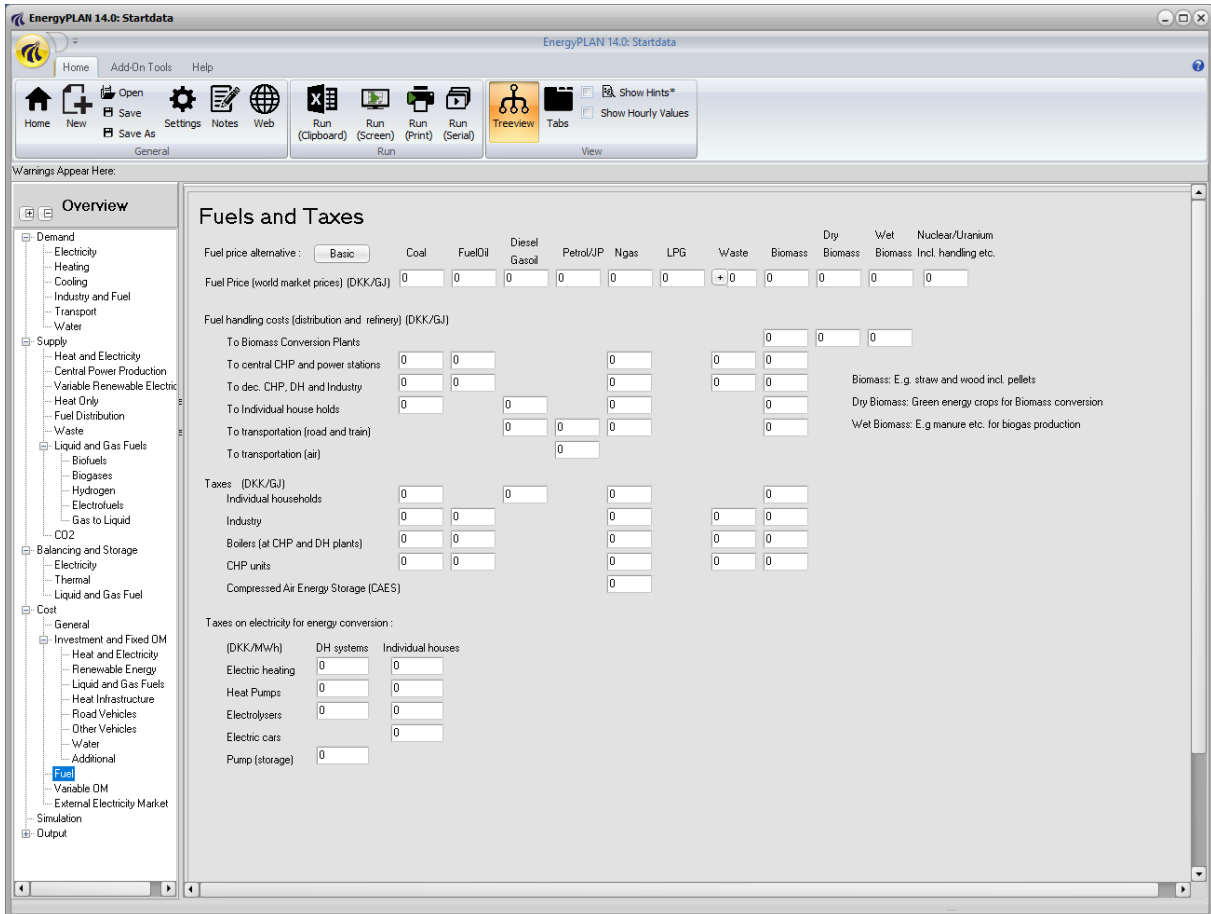

Input

Fuel world market prices, handling costs and taxes (DKK/GJ)

$P_{\text{Coal-WM}}, P_{\text{FuelOil-WM}}, P_{\text{Diesel-WM}}, P_{\text{Petrol-WM}},$

$P_{\text{Ngas-WM}}, P_{\text{Waste-WM}}, P_{\text{Biomass-WM}}, P_{\text{DryBiomass-WM}}, P_{\text{WetBiomass-WM}} =$ World Market Fuel Prices

$P_{\text{Biomass-Hbiocon}}, P_{\text{DryBiomass-Hbiocon}}, P_{\text{WetBiomass-Hbiocon}} =$ Fuel Handling costs for Biomass Conversion Plants

$P_{\text{Coal-Hcen}}, P_{\text{FuelOil-Hcen}}, P_{\text{Ngas-Hcen}}, P_{\text{Waste-Hcen}}, P_{\text{Biomass-Hcen}} =$ Fuel Handling costs for central power plants

$P_{\text{Coal-Hdec}}, P_{\text{FuelOil-Hdec}}, P_{\text{Ngas-Hdec}}, P_{\text{Waste-Hdec}}, P_{\text{Biomass-Hdec}} =$ Fuel Handling costs for decentralised CHP and industry

$P_{\text{Coal-Hindv}}, P_{\text{Diesel-Hindv}}, P_{\text{Ngas-Hindv}}, P_{\text{Biomass-Hindv}} =$ Fuel Handling costs for individual households

$P_{\text{Diesel-HRoad}}, P_{\text{Petrol-HRoad}}, P_{\text{JP-HAir}}, P_{\text{Ngas-HRoad}}, P_{\text{Biomass-HRoad}} =$ Fuel Handling costs for transport

$P_{\text{Coal-TaxIndv}}, P_{\text{Diesel-TaxIndv}}, P_{\text{Ngas-TaxIndv}}, P_{\text{Biomass-TaxIndv}} =$ Taxes on Fuels for individual households

$P_{\text{Coal-TaxI}}, P_{\text{FuelOil-TaxI}}, P_{\text{Ngas-TaxI}}, P_{\text{Waste-TaxI}}, P_{\text{Biomass-TaxI}} =$ Taxes on Fuels for waste incineration and industry

$P_{\text{Coal-TaxB}}, P_{\text{FuelOil-TaxB}}, P_{\text{Ngas-TaxB}}, P_{\text{Waste-TaxB}}, P_{\text{Biomass-TaxB}} =$ Taxes on Fuels for district heating boilers

$P_{\text{Coal-TaxCHP}}, P_{\text{FuelOil-TaxCHP}}, P_{\text{Ngas-TaxCHP}}, P_{\text{Waste-TaxCHP}}, P_{\text{Biomass-TaxCHP}} =$ Taxes on Fuels for CHP production

$P_{\text{Ngas-TaxCAES}} =$ Taxes on Fuels for CAES installations

CO₂ trade price and Electricity taxes on heat and hydro productions (DKK/MWh)

$P_{Elec-TaxEH-DH}$, $P_{Elec-TaxHP-DH}$, $P_{Elec-TaxElc-DH}$, $P_{Elec-TaxCAES-DH}$ = Taxes on electricity in district heating systems

$P_{Elec-TaxEH-Indv}$, $P_{Elec-TaxHP-Indv}$, $P_{Elec-TaxElc-Indv}$, $P_{Elec-TaxBEV-Indv}$ = Taxes on electricity in individual houses and cars

CO₂ trade price (DKK/t CO₂)

$P_{CO_2-trade}$: CO₂ emission quota price (included in marginal costs)

Fuel prices are specified as world market prices and domestic handling costs and taxes, if any. The input in the Fuel Cost tab sheet is used for two purposes. The one is a calculation of marginal productions costs, which is done in the Cost Operation tab sheet (see below in section 4.4). The other is a feasibility study including fuel costs, which is conducted at the end of the energy system analysis (see section 8.8).

4.4.4. Variable Operation and Maintenance

The screenshot shows the EnergyPLAN 14.0: Startdata software interface. The main window displays the 'Variable Operation and Maintenance Cost' tab. On the left, there is a navigation tree with categories like Demand, Supply, Balancing and Storage, and Cost. The main area is divided into several sections for cost input:

- District Heating and CHP systems:** Includes input fields for Boiler, CHP, Heat Pump, and Electric heating, each with a value of 0 and units of DKK/MWhr/h.
- Power Plants:** Includes input fields for Hydro Power, Condensing, Geothermal, GTL M1, and GTL M2, each with a value of 0 and units of DKK/MWhr/e.
- Storage:** Includes input fields for Electrolyzer, Pump, Turbine, V2G Discharge, Hydro Power Pump, and Steam Storage, each with a value of 0 and units of DKK/MWhr/e.
- Individual:** Includes input fields for Boiler, CHP, Heat Pump, and Electric heating, each with a value of 0 and units of DKK/MWhr/h.

On the right side, there are two summary tables:

Marginal Costs of producing 1 MWh electricity			
District Heating	Incr. CHP2 decr. HP2	0	DKK/MWh
	Incr. CHP3 decr. HP3	0	DKK/MWh
	Incr. CHP2 decr. B2	0	DKK/MWh
	Incr. CHP3 decr. B3	0	DKK/MWh
	Incr. B2 decr. HP2	0	DKK/MWh
	Incr. B3 decr. HP3	0	DKK/MWh
	Incr. B2 decr. EB2	0	DKK/MWh
	Incr. B3 decr. EB3	0	DKK/MWh
	incr. CHP2 decr. ELT2	0	DKK/MWh
	incr. CHP3 decr. ELT3	0	DKK/MWh
	incr. B2 decr. ELT2	0	DKK/MWh
	incr. B3 decr. ELT3	0	DKK/MWh
	incr. GTL decr. B3	0	DKK/MWh
	incr. GTL decr. CHP3	0	DKK/MWh
Power Plants	Condensing Power	0	DKK/MWh
	PP2	0	DKK/MWh
	Hydro Power	0	DKK/MWh
	Geothermal	0	DKK/MWh
Individual	Incr. Ngas CHP decr. B.	0	DKK/MWh
	Incr. Bio.CHP decr. B.	0	DKK/MWh
	Incr. HP decrease EH	0	DKK/MWh

Marginal Costs of storing 1 MWh electricity			
	DKK/MWh	Multiplication Factor (**)	
Individual	Incr. H2.CHP decr. Boiler	0	2.03
Storage	V2G (Electric Vehicle)	0	1.23
	Pump/Turbine (CAES)	0	1.39
	Hydro Pump Storage	0	3.37
	Steam Storage	0	0.00

Footnotes:
 *) Total cost of storing defined pr. MWh of electricity production
 **) Minimum selling price divided by maximum buying price

Input

Variable Operational Costs (DKK/MWh)

$P_{VOC-Boiler-DH}$, $P_{VOC-CHP-DH}$, $P_{VOC-HP-DH}$, $P_{VOC-EH-DH}$ = Variable operational costs in district heating plants

$P_{VOC-Hydro}$, P_{VOC-PP} , $P_{VOC-Nuclear}$, $P_{VOC-Geothermal}$ = Variable operational costs in power plants

$P_{VOC-Elc}$, $P_{VOC-Pump}$, $P_{VOC-Turbine}$, $P_{VOC-V2G}$, $P_{VOC-Hydro-Pump}$ = Variable operational costs in storage systems

$P_{VOC-Boiler-Indv}$, $P_{VOC-CHP-Indv}$, $P_{VOC-HP-Indv}$, $P_{VOC-EH-Indv}$ = Variable operational costs in individual households

In the Cost Operation tab sheet, variable operational and maintenance costs are specified for all units which are involved in the electricity balancing. Such costs are used for identifying all relevant marginal production costs, which are calculated on the basis of fuel costs, taxes, CO₂ costs (specified in the Fuel Cost tab sheet), and variable operational costs. Fuel costs consist of international market prices plus local handling costs, as shown in the input tab sheet below.

For units connected to district heating plants (such as CHP and heat pumps), power stations and individual micro CHP, marginal costs are given in DKK/MWh of electricity production/consumption.

For storage units such as hydrogen CHP and pump storage systems, marginal costs are given according to a multiplication factor and an addition factor. Basically, the simulation criterion is the following:

$$p_{\text{sell}} > p_{\text{buy}} * f_{\text{MUL}} + f_{\text{ADD}}$$

In which

- P_{sell} is the market electricity price when selling (DKK/MWh)
- P_{buy} is the market electricity price when buying (DKK/MWh)
- f_{MUL} is the multiplication factor (always bigger than 1), and
- f_{ADD} is the addition factor (DKK/MWh)

The calculation of marginal production prices is based on the fuel specifications in the various input tab sheets. Only fuels which are specified as variable are included in the calculation.

4.4.5. External electricity market

Input
<p>External Electricity Market Definition: $p_{\text{Market-input}}$ = Hourly input, external market electricity price FaC_{Mul} = Multiplication factor FaC_{Add} = Addition factor $\text{FaC}_{\text{Depend}}$ = Dependence factor (price elasticity) p_o = Basic price level for price elasticity</p>

The market price on the external electricity market is defined by the following input:

- An hourly distribution of prices (chosen from the Library)
- FaC_{Mul} = Multiplication factor
- FaC_{Add} = Addition factor
- $\text{FaC}_{\text{Depend}}$ = Dependence factor (price elasticity)
- p_o = Basic price level for price elasticity

For the economic simulation, the market prices, $p_{\text{Market},t}$, are found from the specified hourly price distribution ($p_{\text{Market-input},t}$), when modified in the following way:

$$p_{\text{Market}} = p_{\text{Market-input}} * \text{FaC}_{\text{Mul}} + \text{FaC}_{\text{Add}}$$

The resulting average market price after influence by the multiplication and addition factors is calculated simultaneously and shown in the tab sheet.

In the economic simulation strategy and in the calculation of income from exchange, the market price is further influenced by the price elasticity, as described in sections 7.1, 7.10 and 8.9.2.

4.5. Simulation

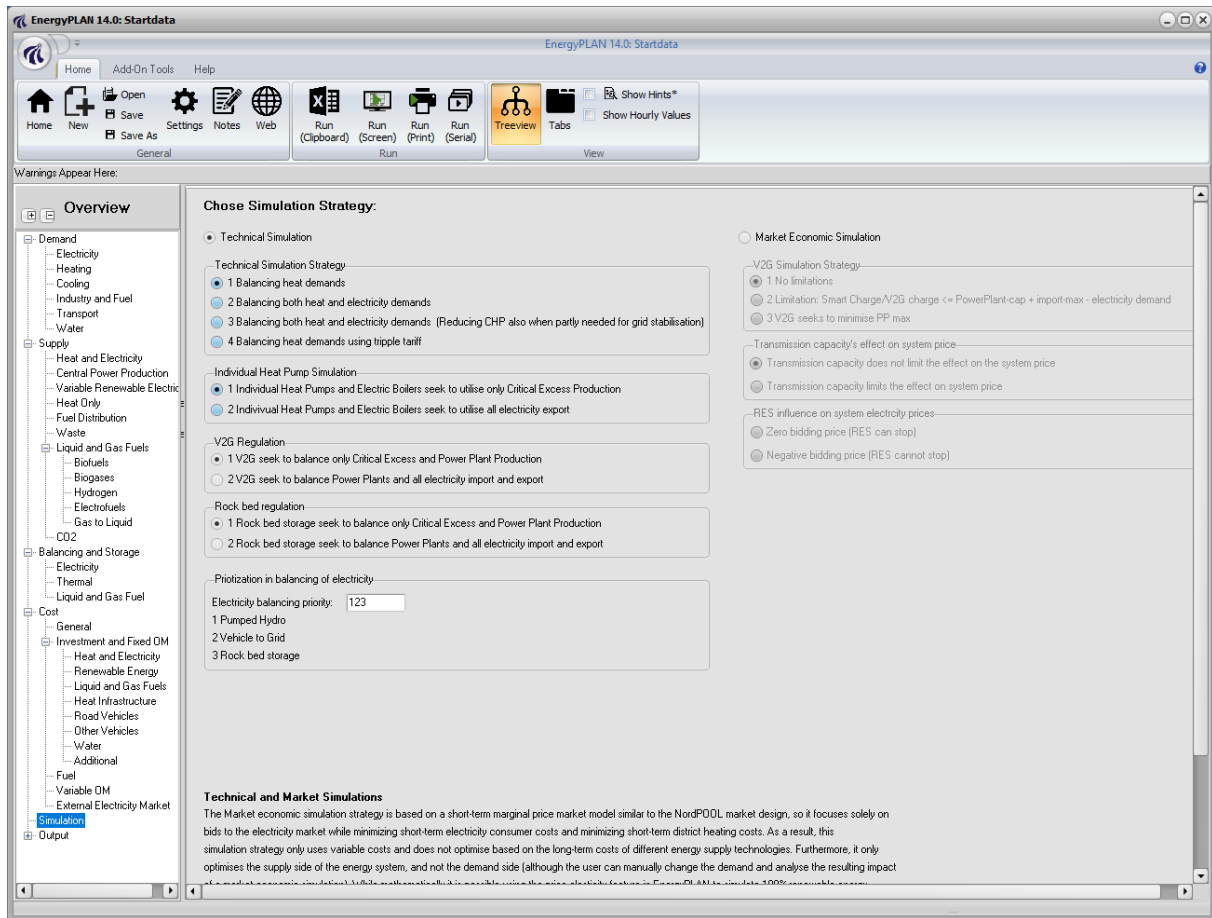

The choice of simulation strategy is made by activating the correct radio button. Here, one can choose between Technical Simulation, as described in chapter 6, or Market-Economic Simulation, as described in chapter 7.

If technical simulation is selected, one must choose between the following 4 technical simulation strategies, all explained in chapter 6:

1. Balancing heat demands
2. Balancing both heat and electricity demands
3. Balancing both heat and electricity demands (Reducing CHP also when needed partly for grid stabilisation)
4. Balancing heat demands using triple tariff

Furthermore, the individual heat pumps can operate based on two strategies, vehicle to grid can balance based on two strategies, and priority can be chosen between pumped hydro and vehicle to grid.

V2G and Rockbed storage can operate based on all excess electricity available, or only based on critical excess production and power plants.

The user can prioritize the different storage options by defining which to use first.

If market-economic simulation is selected, one must choose between the following 3 simulation strategies with regard to the operation of V2Gs, all explained in chapter 7.5:

1. No limitations
2. Limitation: Smart Charge/V2G charge \leq PowerPlant-cap + import-max - electricity demand
3. V2G seeks to minimise PP max

The user also has to choose whether the transmission line capacity limits the effect of the external market.

In the market simulation, the user also has to choose whether variable renewable electricity bids as zero price or as negative infinite price, basically determining if RES stops in negative price hours or not.

5. Initial analyses without electricity balancing

The model starts by making a number of initial calculations based on the input data. Various electricity and heat demands are found simply by distributing the annual demands according to the internal hourly distributions.

5.1. Fixed import/export of electricity

The fixed import/export demand is meant to describe exchanges with external electricity markets additional to the one which is active in the model. Input is annual electricity demand, D_{EX} , together with hourly distribution, δ_{EX} . The hourly values, d_{EX} , are calculated as follows:

$$d_{EX} = D_{EX} * \delta_{EX} / \sum \delta_{EX}$$

5.2. District heating demands incl. heat demands from absorption cooling

District heating demands in the three district heating groups, including the heat demand for biogas production and absorption cooling in the various groups, are calculated as described in the following.

For all three district heating groups, the demand is defined by an annual heat demand, H_{DH} , together with the hourly distribution, δ_{DH} . The same applies to heat demands for biogas production and absorption cooling in the various district heating groups: H_{Cool} and δ_{Cool} . The hourly values, h_{DH} , are calculated as follows:

$$h_{DH} = H_{DH} * \delta_{DH} / \sum \delta_{DH} + H_{Cool} * \delta_{Cool} / \sum \delta_{Cool} + H_{BiogasDH} * \delta_{BiogasDH} / \sum \delta_{BiogasDH}$$

5.3. District heating and electricity productions from Industry and Waste

District heating and electricity production from Industrial CHP are defined for each of the three district heating groups in terms of the annual heat and electricity productions, $Q_{Industry-DH}$ and $E_{Industry-DH}$, together with the hourly distribution, $\delta_{Industry-DH}$:

$$q_{Industry-DH} = Q_{Industry-DH} * \delta_{Industry-DH} / \sum \delta_{Industry-DH}$$

$$e_{Industry-DH} = E_{Industry-DH} * \delta_{Industry-DH} / \sum \delta_{Industry-DH}$$

District heating and electricity production from Waste are calculated in the same way:

$$q_w = Q_w * \delta_w / \sum \delta_w$$

$$e_w = E_w * \delta_w / \sum \delta_w$$

The same applies to district heating productions from biomass conversion plants:

$$q_{GASI} = Q_{GASI} * \delta_{GASI} / \sum \delta_{GASI}$$

$$q_{\text{BioPetrol}} = Q_{\text{BioPetrol}} * \delta_{\text{BioPetrol}} / \sum \delta_{\text{BioPetrol}}$$

Heat production from Industry and Waste are calculated separately for all three district heating groups, while heat production from gasification and bio petrol plants are assumed to be supplied to only district heating group 3.

5.4. Fixed Boiler production subtracted from the district heating demand

The CHP units of each district heating group are modelled by one average production unit with average efficiencies. Therefore, the model cannot include simulation of situations in which the units of one system are not operating because of maintenance or breakdowns. However, one can compensate for this problem by specifying a certain percentage of the district heating demand which has to be supplied from the boiler, the so-called “fixed boiler share”, FixedPercent_B . Studies indicate that approximately 2 per cent of fixed boiler share will represent an appropriate compensation. The compensation is calculated as a percentage of the annual district heating demand in groups 2 and 3 and afterwards subtracted from the demand. Here it is shown for district heating group 2:

$$q_{\text{FixedBoiler2}} = H_{\text{DH2}} * \text{FixedPercent}_{B2} / 8784$$

$$h_{\text{DH2}} = h_{\text{DH2}} - q_{\text{FixedBoiler2}}$$

Later (see section 8.1), the production is added to the boiler production:

$$q_{B2} = q_{B2} + q_{\text{FixedBoiler2}}$$

If there is available capacity on the heat pump it can replace the fixed boiler production, thus the fixed boiler share will be supplied by a heat pump and thus added to the heat pump production instead.

The same calculation is done for district heating group 3.

5.5. Boiler production in district heating group 1

In group I, heat for district heating is produced by:

1. Solar Thermal: q_{solar1}
2. Industrial CHP (CSHP): $q_{\text{Industry-DH1}}$
3. Heat production from waste fuel: q_{W1}
4. District heating plants with boilers: q_{B1}

The productions from solar thermal, CSHP and waste are calculated for each hour based on the input data and the respective distribution sets. The production from the boiler is identified as the difference between demands and solar/CSHP productions:

$$q_{B1} = h_{\text{DH1}} - q_{\text{solar}} - q_{\text{Industry-DH1}} - q_{W1}$$

$$\text{If } q_{B1} < 0 \text{ then } q_{B1} = 0$$

6. Technical Energy System Analysis

This chapter describes the technical energy systems analysis presented as step 3A in the overview.

6.1. Condensing power and import/export including CEEP and EEEP

The calculation of condensing power and import/export including CEEP and EEEP (Critical and Exportable Excess Electricity Production) is made more or less after each of the following sequences (sections 6.2 – 6.9) in the technical energy system analysis procedure.

The demand is calculated as the sum of the following demands:

$$d_{\text{Total}} = d_E + d_{\text{EX}} + d_{\text{FX}} + d_{\text{Cool}} + d_{\text{Biogas}} + d_{\text{GASl}} + d_{\text{BioPetrol}} + d_{\text{BioDiesel}} + d_{\text{Elic}} + d_{\text{BEV}} + d_{\text{V2G}} \\ + d_{\text{I-HP-total}} + d_{\text{I-EH}} + d_{\text{HP2}} + d_{\text{HP3}} + d_{\text{Pump}} + d_{\text{HydroPump}} + d_{\text{SteamStorage}}$$

$$\text{in which } d_{\text{FX}} = d_{\text{FXDay}} + d_{\text{FXWeek}} + d_{\text{FX4Week}}$$

$$\text{and } d_{\text{Elic}} = d_{\text{Elic2}} + d_{\text{Elic3}} + d_{\text{ElicT}} + d_{\text{ElicM}}$$

The production, excluding the condensing power plants, is calculated as the sum of the following:

$$e_{\text{Total}} = e_{\text{Res}} + e_{\text{M-CHP}} + e_{\text{Hydro}} + e_{\text{Nuclear}} + e_{\text{Geothermal}} + e_{\text{V2G}} + e_{\text{W}} + e_{\text{CSHP}} + e_{\text{CHP2}} + e_{\text{CHP3}} + e_{\text{Turbine}}$$

$$\text{in which } e_{\text{Res}} = e_{\text{Res1}} + e_{\text{Res2}} + e_{\text{Res3}} + \dots + e_{\text{Res7}}$$

$$\text{and } e_{\text{M-CHP}} = e_{\text{M-h2CHP}} + e_{\text{M-NgasCHP}} + e_{\text{M-BioCHP}}$$

The production of the condensation plants is determined as the larger of the following two values:

A. The difference between demand and production:

$$e_{\text{PP}} = d_{\text{Total}} - e_{\text{Total}}$$

B. The minimum production needed in order to fulfil the requirement of stabilising the grid: (I.e., the needed share of power plants with stabilising ability of the total production minus the share of the other units which are assumed to have stabilising ability)

$$e_{\text{PP}} = (e_{\text{Total}} * \text{Stab}_{\text{Total}} - e_{\text{CHP2}} * \text{Stab}_{\text{CHP2}} - (e_{\text{W1}} + e_{\text{W2}} + e_{\text{W3}}) * \text{Stab}_{\text{Waste}} - e_{\text{Res1}} * \text{Stab}_{\text{Res1}} - e_{\text{Res2}} * \text{Stab}_{\text{Res2}} - \\ e_{\text{Res3}} * \text{Stab}_{\text{Res3}} - \dots - e_{\text{Res7}} * \text{Stab}_{\text{Res7}} - e_{\text{CHP3}} - e_{\text{Nuclear}} - e_{\text{Geothermal}} - e_{\text{Hydro}} - e_{\text{Turbine}} - e_{\text{CSP}} * \text{Stab}_{\text{CSP}} - e_{\text{V2G}} * \text{Stab}_{\text{V2G}} - \\ C_{\text{Imp/exp}} * \text{Stab}_{\text{TRANS}}) / (1 - \text{Stab}_{\text{Total}})$$

In which C_{V2G} represents the power capacity of all V2G connected to the grid (see further details in chapter 6.9) and $C_{\text{Imp/exp}}$ is the capacity of the import/export transmission line.

In case e_{PP} exceeds the specified maximum value, C_p , the necessary electricity production is imported. The import and export of electricity can now be calculated as:

$$\text{If } (e_{\text{Total}} + e_{\text{PP}} - d_{\text{Total}} < 0) \text{ then } e_{\text{Import}} = e_{\text{Total}} + e_{\text{PP}} - d_{\text{Total}} \text{ or else } e_{\text{Import}} = 0 \\ \text{If } (e_{\text{Total}} + e_{\text{PP}} - d_{\text{Total}} > 0) \text{ then } e_{\text{Export}} = e_{\text{Total}} + e_{\text{PP}} - d_{\text{Total}} \text{ or else } e_{\text{Export}} = 0$$

The export is divided into two categories: 1) Critical Excess Electricity Production, e_{CEEP} , and 2) Exportable Excess Electricity Production, e_{EEEE} . Critical excess electricity production appears when the export exceeds the maximum capacities of the grid connections abroad:

$$\begin{aligned} & \text{If } e_{\text{Export}} > C_{\text{Transmission}} \\ & \text{then } e_{\text{CEEP}} = e_{\text{Export}} - C_{\text{Transmission}} \text{ and } e_{\text{EEEE}} = C_{\text{Transmission}} \\ & \text{or else } e_{\text{CEEP}} = 0 \text{ and } e_{\text{EEEE}} = e_{\text{Export}} \end{aligned}$$

6.2. CHP, heat pumps and boilers in groups 2 and 3 (simulation 1 or 4)

Based on the modified “hourly distributions” described above and the remaining input data, the model calculates electricity and heat productions depending on the simulation strategy chosen.

6.2.1. Simulation strategy 1: Meeting heat demand

In this strategy, all heat producing units are producing solely according to the heat demand. For district heating groups 2 and 3, the units are given priority on an hourly basis according to the following sequence:

- | | |
|-------------------------------------|---------------------------|
| 1. Solar Thermal: | q_{solar2} |
| 2. Industrial CHP (CSHP): | $q_{\text{Industry-DH2}}$ |
| 3. Heat production from waste fuel: | q_{W2} |
| 4. Heat plant CHP: | q_{CHP2} |
| 5. Heat pumps: | q_{HP2} |
| 6. Peak load boilers: | q_{B2} |

The productions from solar thermal, CSHP and waste are calculated for each hour based on the input data and the respective distribution sets. The heat productions from CHP and heat pumps are identified as the difference between demands and solar/CSHP productions:

$$q_{\text{CHP2}} = h_{\text{DH2}} - q_{\text{solar2}} - q_{\text{Industry-DH2}} - q_{\text{W2}}$$

$$\text{If } q_{\text{CHP2}} > T_{\text{CHP2}} \text{ then } q_{\text{CHP2}} = T_{\text{CHP2}}$$

$$q_{\text{HP2}} = h_{\text{DH2}} - q_{\text{solar2}} - q_{\text{Industry-DH2}} - q_{\text{W2}} - q_{\text{CHP2}}$$

$$\text{If } q_{\text{HP2}} > T_{\text{HP2}} \text{ then } q_{\text{HP2}} = T_{\text{HP2}}$$

$$\text{If } q_{\text{HP2}} > h_{\text{DH2}} * \text{SHARE}_{\text{HP2}} \text{ then } q_{\text{HP2}} = h_{\text{DH2}} * \text{SHARE}_{\text{HP2}}$$

For the heat plant CHPs and the heat pumps, the calculation respects the maximum capacity as well as the maximum share of heat pumps compared to the total heat demand, $\text{SHARE}_{\text{HP2}}$. This limitation reflects the fact that heat pumps should be used for the production of low temperature heat only. The peak load boiler supplies the remaining demand:

$$q_{\text{B2}} = h_{\text{DH2}} - q_{\text{solar2}} - q_{\text{Industry-DH2}} - q_{\text{W2}} - q_{\text{CHP2}} - q_{\text{HP2}}$$

If $q_{B2} > T_{B2}$ **then** $q_{B2} = T_{B2}$

The model also makes sure that no heat production becomes negative and the resulting heat balance is calculated and shown as a result. Due to limitations on capacities or excess productions from solar thermal or industry/waste, such result may show imbalances.

6.2.2. Simulation strategy 4: Meeting the triple tariff

Simulation strategy 4 is the same as strategy 1 apart from one factor.

In simulation strategy 4, the CHP units in group 2 meet the Danish triple tariff instead of meeting the heat demand.

The electricity production from CHP units in group 2 is located according to an order of priority, i.e., peak load, high load and low load. The periods of the triple tariff are simply defined as:

- Peak load during weekdays between 8.00 and 12.00 (plus 17.00-19.00 in the winter)
- High load during weekdays between 6.00 and 21.00, and
- Low load during the remaining time.

Simulation strategies 1 and 4 are the same in the sense that, in neither of the cases, the CHPs adjust their productions according to the fluctuations in wind power.

6.3. Flexible electricity demand (including dump charge BEV)

The model uses an hourly distribution of the electricity demand specified in the input as an external input file. A typical Danish distribution based on statistic information from year 2000 is provided as an option (shown in diagram 3). Or other external input files can be created. The electricity demand is distributed according to the specified distribution. Moreover, one can add a fixed import/export demand as described in relation to the Input Electricity Heating tab sheet in section 4.1.

Any new demands created by the use of electricity for transport (batteries and/or hydrogen) or by other purposes can be specified in the Input Transport tab sheet (described in section 4.1.5). Electricity for transport can be made flexible in two ways. One comprises the smart charge and V2G possibilities in the transport tab sheet (section 4.1.5) and the other involves the specification of a flexible demand. The same routines can be applied to the definition of a certain percentage of the demand as flexible. This involves an analysis of the consequences of introducing flexible demands for cooling etc. in industries and/or households.

Thus, an additional electricity demand can be made flexible within short periods according to the following four categories:

1. Demand following a specified distribution (typically battery cars being charged during the night). Section 4.1.5.
2. Demand freely distributed over a 24-hour period according to the actual electricity balance. (Similar to the above, but with the added possibility of concentrating the demand in the actual peak hours for, e.g., wind production, which requires a method of communicating this knowledge to the consumers). Section 4.1.
3. Demand which can be distributed freely over a week according to the actual electricity balance (Similar to the above - relevant to consumers with extra battery capacity and for hydrogen-operated vehicles). Section 4.1.

4. Demand which can be distributed freely over a four-week period (similar to the above - relevant to hydrogen-operated vehicles. The optimal distribution of demand for a period of this length requires a long-term prognosis for the electricity balance to be transmitted to the consumers. Since this prognosis is partly based on a weather prognosis, this is hardly possible today, as the prognosis for a four-week period at present is not sufficiently reliable). Section 4.1.

For the categories 2, 3 and 4, the demands are distributed within the given intervals one by one according to an evaluation of the balance between “fixed” electricity productions and demands. The calculation of productions and demands is done in accordance with the description in section 6.1. However, only productions and demands from units calculated up to now (steps 1 and 2 and section 6.2) are included; i.e. Nuclear and all RES, CHPs and heat pumps based on simulation 1 or 4 including individual units. Hydro power and micro CHP are based on the initial estimate not including the simulation described later in this chapter. Moreover, electricity productions for dump charge BEV are included. Productions and demands from more flexible units such as electricity storage systems and electrolyzers are not included.

The distribution of demands within the interval is made in order to provide the variation of this balance with two limitations:

- a. it must be positive at any time
- b. it should be below a given maximum, C_{fx} (defined in the input)

A normalisation of the variation ensures that the average demand for the period equals the yearly average.

Part of the existing demand can be specified as flexible in the same way as the transport demands of categories 2, 3, and 4. Typically, these flexible demands will be connected to either room heating or to cooling processes (air conditioning or cold stores). The flexible demands can be specified for the same three periods as the transport demands. For each period and for each type (cooling, heating), the maximum capacity must be stated. Please note that the fixed demand should be decreased in order not to increase the total demand. The effects on the hourly distribution of the total electricity demand are calculated in the same way as for the transport demands. In diagrams 6.1 and 6.2, an example is shown of how flexible demand reduces differences in the balance between the supply from CHP and renewable energy and the demand.

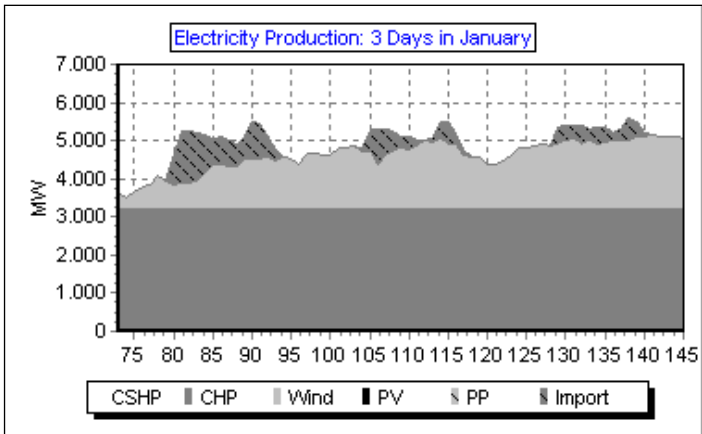

Diagram 6.1: Electricity Production from CHP, Wind and Import, 3 Days in January.

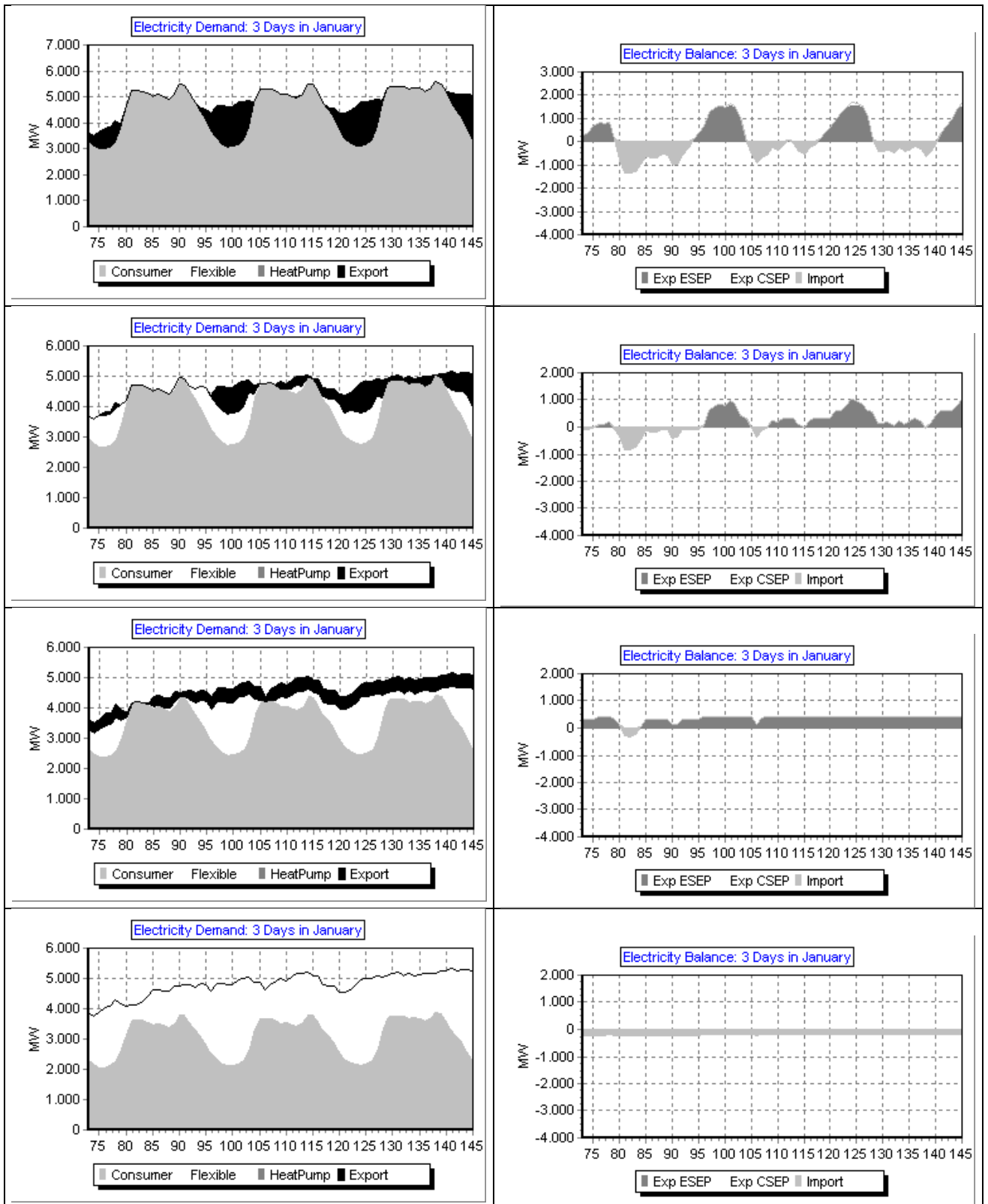

Diagram 6.2: Example of flexible demand

The example represents the following situation:

Electricity demand = 33 TWh
 District heating = 20 TWh
 Wind Power = 2000 MW
 CHP = 2000+3000 MW-el
 HP = 300 + 500 MW-el

Diagram 6.1 illustrates a three-day period in January with a continuous CHP production of approx. 3200 MW, and, on top of this, a wind production increasing the total production to between approx. 3500 and 5000 MW.

In the upper left corner of diagram 6.2, the demand is shown (in the case of no flexible demand); and to the right, the resulting difference in the balance between supply and demand is shown. The latter diagram is found simply by subtracting the demand and the supply from diagram 6.1. It can be seen how an excess production is generated during night hours and there is a lack of supply during day hours, fluctuating according to the variations in the wind production.

At the next three levels of diagram 6.2, an increasing share of the demand has been changed into flexible demand in the input. At the second level, 10 per cent is made flexible within a day. At the next level, an additional 10 per cent is made flexible within a week. And in the last picture, an additional 10 per cent is made flexible within a four-week period. It can be seen how such flexibility is able to continuously improve the balance between supply and demand.

6.4. CHP, heat pumps and boilers in groups 2 and 3 (simulation 2 or 3)

If technical simulation strategy 2 or 3 is chosen, the following calculations are done, which will then replace the calculations of section 6.2 (strategy 1 or 4).

6.4.1. Simulation strategy 2: Meeting both heat and electricity demands

In this section, the export of electricity is minimised mainly by the use of heat pumps at CHP plants. This will simultaneously increase electricity demand and decrease electricity production, as the CHP units must decrease their heat production. Note that if a request for external export/import has been defined as an input (see section 4.2.2), the model will try to meet such a request instead of minimizing the export of electricity.

By the use of extra capacity at the CHP plants combined with heat storages, the production at the condensation plants is minimised by replacing it with CHP production.

The **electricity production by CHP**, e_{CHP} , must at any time be lower or equal to the maximum capacity, C_{CHP} , and to the capacity corresponding to the heat demand which is not met by the industrial CHP (including waste and biomass conversion plants) and the solar thermal production. Within these limits, the electricity production by CHP is determined by one of the following conditions:

- A. The capacity which can ensure stability of the grid together with a possible stabilising effect of the RES units but without relying on any effect from condensation plants:

$$e_{CHP,II,A} = (e_{Total} * Stab_{total} - (e_{W1} + e_{W2} + e_{W3}) * Stab_{Waste} - e_{RES1} * Stab_{RES1} - e_{RES2} * Stab_{RES2} - e_{RES3} * Stab_{RES3})$$

$$- \dots - e_{RES7} * Stab_{RES7} - e_{CHP3} - e_{Nuclear} - e_{Geothermal} - e_{Turbine} - e_{Hydro} - e_{V2G} * Stab_{V2G} - e_{CSP} * Stab_{CSP} - C_{imp/exp} * Stab_{TRANS} / Stab_{CHP2}$$

B. The capacity which will be the result of reducing the CHP production found by strategy I, $e_{CHP,I}$, in order to minimise the electricity export found by strategy I, $e_{Export,I}$. The reduction needed will depend on whether the heat pumps at the CHP plants are already operating at maximum capacity (For all hours, this is determined as either the technical limit, C_{CHP} , or as the maximum share of the total heat demand, $Share_{HP}$). If this is not the case, the reduction in heat production caused by the reduction in electricity production can be balanced by an increase in the heat produced by the heat pumps. This will also reduce the electricity export. As a result, the necessary reduction is made by a factor

$$1 + T_{CHP}/C_{CHP} * C_{HP}/T_{HP}$$

If the heat pumps are already operating at maximum capacity, the CHP production will have to be reduced by the size of the electricity export, $e_{Export,I}$.

For these reasons, the reduction has to be calculated in two steps:

a. Reduction of CHP plus increase of heat pump production:

$$e_{HPmax} = \min(C_{CHP}; h_{DH} * Share_{HP})$$

$$e_{CHP,red,a} = \min(e_{Export,I} / (1 + T_{CHP}/C_{CHP} * C_{HP}/T_{HP}); (e_{HPmax} - e_{HP}) * T_{HP}/C_{CHP} * C_{CHP}/T_{CHP})$$

$$e_{HP,inc,a} = e_{CHP,red,a} * T_{CHP}/C_{CHP} * C_{HP}/T_{HP}$$

b. A possible further reduction of CHP only:

$$e_{CHP,red,b} = e_{Export,I} - e_{CHP,red,a} - e_{HP,inc,a}$$

$$e_{CHP,II,B} = e_{CHP,I} - e_{CHP,red,a} - e_{CHP,red,b}$$

These calculations are performed for groups 2 and 3 separately, but with due consideration of total stabilisation demands, etc.

After having determined the production at the CHP plants as maximum ($e_{CHP,II,A}$; $e_{CHP,II,B}$), the production of the heat pumps and the boilers are calculated in the same way as in strategy I.

6.4.2. Simulation strategy 3: Meeting both heat and electricity demands and reducing CHP also when it is partly needed for reasons of stabilisation (replacing by PP).

Simulation strategy 3 is the same as strategy 2 apart from one factor.

In strategy 2, CHP will not be reduced (and the heat production will be replaced by heat pumps), if CHP units are needed for reasons of stabilisation of the electricity grid.

Meanwhile, in some situations (when the CHP stabilisation factor is below 100 per cent), excess production can be minimised further by reducing CHP and replacing heat production by heat pumps and boilers and stabilisation demands by PP units.

Consequently, in strategy 3, CHP units are reduced even when stabilisation demands call for replacement with PP units.

The choice between strategy 2 and 3 is a choice between better efficiency in the system and less excess production.

6.5. Hydro power

Hydro Power Units are defined by the following inputs:

C_{Hydro} : The capacity of the Hydro Power Electricity Generator in MW

μ_{Hydro} : The efficiency of the Hydro Power station defined as the conversion factor from energy in the storage to electricity production from the generator.

S_{Hydro} : The capacity of the Hydro Power storage in GWh

W_{Hydro} : The amount of energy connected to the water supplied to the storage in TWh/year

δW_{Hydro} : The distribution of the energy/water supply in 8784 hourly values

Additional input options are:

$\mu_{\text{Hydro-PUMP}}$: The efficiency of running the generator reversibly as a pump, defined as the conversion factor from electricity consumption to energy in the storage

$C_{\text{Hydro-PUMP}}$: The capacity of the Hydro Power pump in MW

$S_{\text{Hydro-PUMP}}$: The capacity of the lower water storage in GWh

The Hydro Power station is subject to the condition that it will always be involved in the task of maintaining grid stability.

The unit is integrated in the simulation of the total system in the following way:

Initially (described in section 4.2.2.3), the average hourly production is calculated on the basis of the water supply to the water reservoirs. The average production is then modified in order to maximise the potential production when limitations on storage and generator capacities are taken into consideration.

To correct the calculation from errors due to differences in the storage content between the beginning and the end of the calculation period, the calculation seeks to identify a solution in which the storage content at the end is the same as at the beginning. Initially, the storage content is defined as 50% of the storage capacity. After the first calculation, a new initial content is defined as the resulting content at the end of the calculation.

However, one may as input specify a start and end value of the hydro storage. In such case these values will be used.

The calculation of input can be illustrated by an example characterised by the following:

C_{Hydro} : 400 MW
 μ_{Hydro} : 0.8.
 S_{Hydro} : 1000 GWh
 W_{Hydro} : 2.5 TWh/year
 δW_{Hydro} : Distribution as shown in diagram 6.3.

In such case, the storage and the generator capacity set no limits to the system and the resulting hydro power production is equal to the average production of 228 MW, as shown in diagrams 6.3 and 6.4, together with the storage content (in GWh). The annual production becomes 2.00 TWh/year (equal to $2.5 * 0.8$). The initial and the final storage contents are identified to be 598 GWh.

However, if one introduces a limitation on the storage capacity, so that the total water input cannot be utilised during a year (e.g., a storage capacity of 500 GWh), the solution shown in diagram 6.5 will be applied.

As one can see, the starting point is the average production of 228 MW. During summer and autumn, when the storage is filled and the water supply is higher than what is needed for average production, the production of the power plant is increased up to the capacity of the generator. Consequently, the storage is not filled when the water supply is low during spring and the production is decreased accordingly. However, in this case, losses in the storage cannot be avoided and the annual production is limited to 1.88 TWh/year and not the potential 2.00 TWh/year.

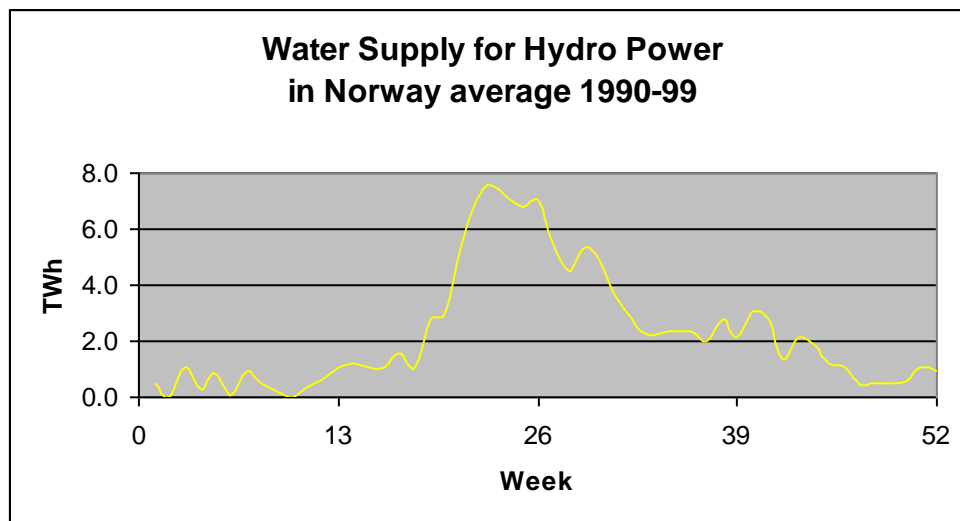

Diagram 6.3: Water supply to the Hydro Power System

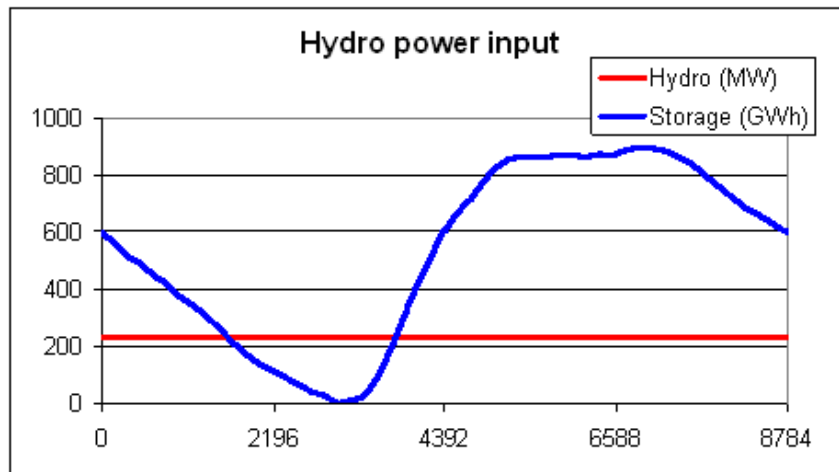

Diagram 6.4: Hydro power output with no limitations in water storage capacity

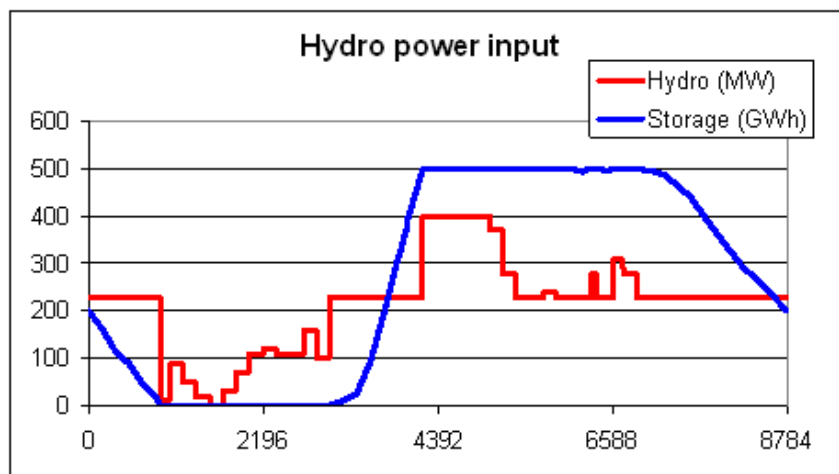

Diagram 6.5: Hydro power output with limitations on water storage capacity

If the capacity of the generator is increased to 700 MW, the solution shown in diagram 6.6 is found in which the system will produce the fully 2.00 TWh/year. If, on the other hand, the capacity is decreased to 300 MW, the annual production will be only 1.79 TWh/year.

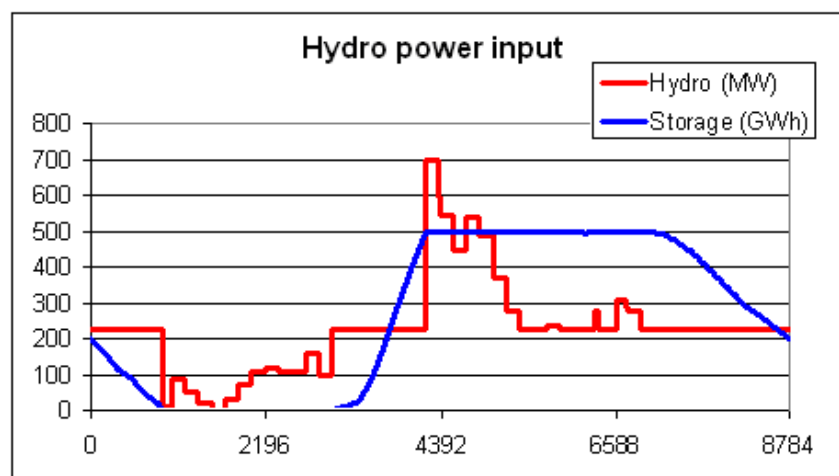

Diagram 6.6: Hydro power output with limitations on water storage and generator capacities

The resulting annual hydro input production is shown simultaneously in the input tab sheet in which the input data are specified.

In the potential calculation of flexible demand, the baseline hydro power production is subtracted from the various demands (consumers, fixed import/export, heat pumps and transport) before the distribution of the flexible demand is determined, as described in section 6.3. In all technical simulation strategies 1, 2, 3 and 4, the above baseline hydro power production is included when the power production from the remaining units is determined.

Subsequently, the condensing power and import/export are calculated again in accordance with section 6.1, and the hydro power is then used for replacing the condensing units and decreasing, first, CEEP and, secondly, EEEP in the following way:

First, the potential of replacing the condensing power plant ($e_{\text{Hydro-Inc}}$) is determined as the minimum value of either the production of the condensing unit or the difference between hydro power capacity and hydro power production.

$$e_{\text{Hydro-Inc}} = \text{MIN} (e_{\text{PP}} , (C_{\text{Hydro}} - e_{\text{Hydro}}))$$

The hydro production, e_{Hydro} , is defined as the production identified through the initial calculation of section 4.2.2.3, as illustrated above.

The potential of decreasing hydro power in the case of CEEP ($e_{\text{Hydro-Dec-CEEP}}$) is determined as the minimum value of either the CEEP or the hydro power production. At the same time, the potential is limited by the fact that the hydro power plant potentially forms part of grid stabilisation:

$$e_{\text{Hydro-Dec-CEEP}} = \text{MIN} (e_{\text{CEEP}} , e_{\text{Hydro}})$$

$$e_{\text{Hydro-Dec-CEEP}} \leq e_{\text{Hydro}} - e_{\text{Hydro-Min-Grid-Stab}}$$

In the case of reversal hydro power, i.e., a pump and lower water storage, the potential of decreasing CEEP further ($e_{\text{Hydro-Pump-Dec-CEEP}}$) is determined as the minimum value of the CEEP (minus the share that is already occupied), the pump capacity, or the content of the lower water storage, $S_{\text{Hydro-PUMP}}$:

$$e_{\text{Hydro-Pump-Dec-CEEP}} = \text{MIN} [(e_{\text{CEEP}} - e_{\text{Hydro-Dec-CEEP}}) , C_{\text{Hydro-PUMP}} , S_{\text{Hydro-PUMP}} / \mu_{\text{Hydro-PUMP}}]$$

In the same way, the potential of decreasing hydro power in the case of EEEP ($e_{\text{Hydro-DEC-EEEE}}$) is found.

Knowing the potentials of increasing and decreasing the hydro power production, a balance is found in which the annual hydro power production is maintained. The reduction of CEEP is given priority over the reduction of EEEP.

$$\sum e_{\text{Hydro-Inc}} = \sum e_{\text{Hydro-Dec-CEEP}} + \sum e_{\text{Hydro-Dec-EEEE}}$$

Similar to the previous modelling of the hydro power input, the programme again calculates the hourly modelling of the system including the fluctuations in the storage content. The hydro power production (e_{Hydro}) is modified in accordance with the generator capacity, the distribution of the water supply, and the storage capacity in the following way:

$$\text{Hydro storage content} = \text{Hydro storage content} + w_{\text{Hydro}}$$

$$e_{\text{Hydro}} = e_{\text{Hydro}} + e_{\text{Hydro-Inc}} - e_{\text{Hydro-Dec-CEEP}} - e_{\text{Hydro-Dec-EEEP}}$$

$$e_{\text{Hydro-Input}} \leq (\text{Hydro storage content} - S_{\text{Hydro}}) * \mu_{\text{Hydro}}$$

$$e_{\text{Hydro-Input}} \leq C_{\text{Hydro}}$$

Differences in the storage content at the beginning and at the end of the calculation period may cause errors in the calculations. To correct these errors, the above calculation seeks to identify a solution in which the storage content at the end is the same as at the beginning. Initially, the storage content is defined as 50% of the storage capacity. After the first calculation, a new initial content is defined as the resulting content at the end of the calculation. However, one may as input specify a start and end value of the hydro storage. In such case these values will be used.

The calculation of the input can be illustrated by the example in diagram 6.7. The upper diagram shows the electricity production for a week in a system with a high share of both CHP and wind power. The system has a high excess electricity production (CEEP).

The second diagram shows the influence of the hydro input (before the hydro simulation). It can be seen how the hydro power automatically replaces the power plant (PP) in the situations in which the PP produces in order to secure grid stability. However, in other situations, the hydro power also adds to the problem of excess production.

In the third diagram, the hydro power is part of the simulation and it can be seen how the hydro power plant replaces the condensing plant and reduces the excess production.

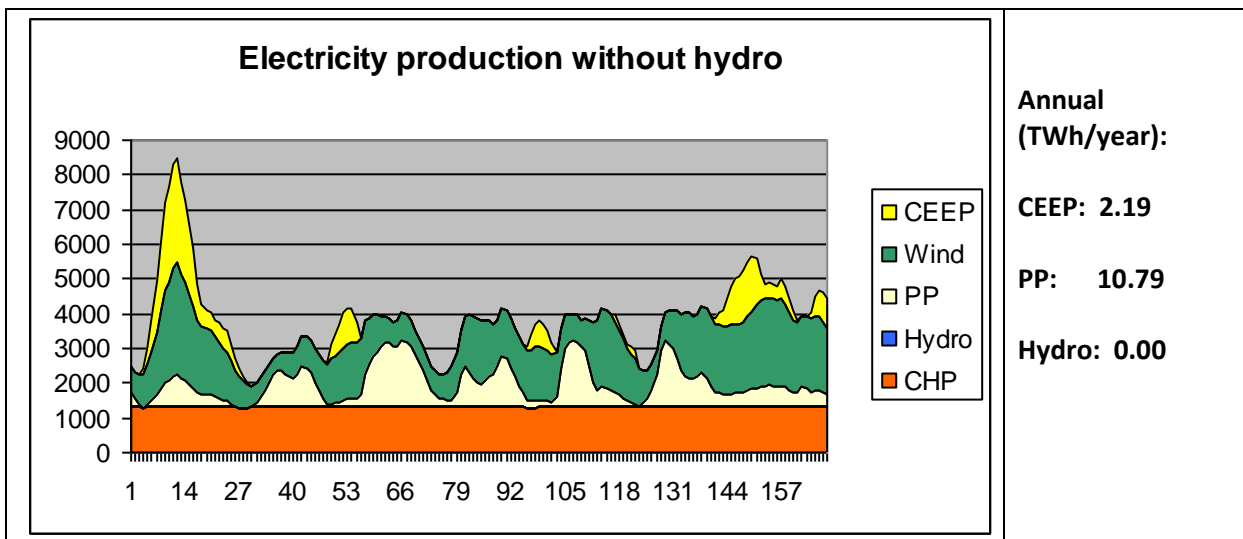

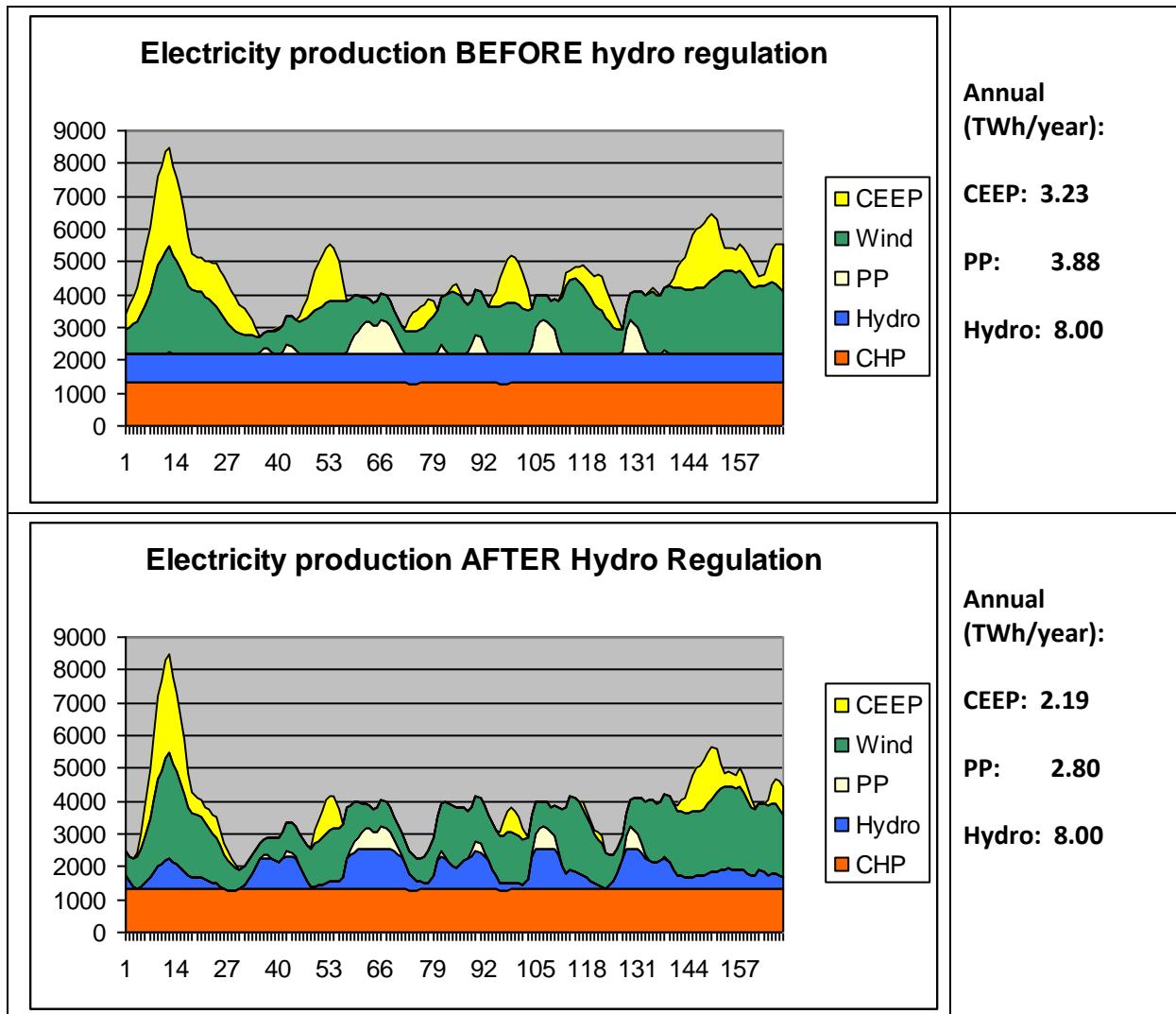

Diagram 6.7: Hydro power is regulated to decrease excess and condensing power productions.

6.6. Individual CHP and heat pump systems

The calculations of individual CHP and heat pump systems are based on the initial calculations of section 4.1.2.. If heat storage capacity is specified, the following moderation will be introduced and will replace the previous productions.

6.6.1. CHP systems

Heat production and the use of the heat storage give priority to solar thermal, which is calculated as the maximum value of either solar thermal production or heat demand plus available room in the heat storage:

$$q_{\text{Solar-M-H2CHP}} = \text{Max} [q_{\text{Solar-M-H2CHP}}, h_{\text{M-H2CHP}} + (S_{\text{Solar-M-H2CHP}} - S_{\text{Solar-M-H2CHP}})]$$

In case of CEEP

If the solar production is lower than the heat demand and CEEP is positive, the heat demand will be supplied by the heat storage, if possible. Only in the case that this can not be done, the CHP unit will be operated. Consequently, the CHP heat production is calculated as follows:

$$q_{M-H2CHP} = \text{Max} [0, (h_{M-H2CHP} - S_{\text{Solar-M-H2CHP}} - q_{\text{Solar-M-H2CHP}})]$$

If such CHP heat production exceeds the capacity, the boiler is operated and the CHP heat production is reduced to the capacity

$$q_{M-H2CHP-Boiler} = \text{Max} [0, (T_{M-H2CHP} - q_{M-H2CHP})]$$

$$q_{M-H2CHP} = \text{Min} [q_{M-H2CHP}, T_{M-H2CHP}]$$

In case of condensing power production

If the condensing power production is positive, the micro CHP unit will try to produce at maximum capacity. Only in the case that excess heat production cannot be stored, the CHP unit will be decreased accordingly. Consequently, the CHP heat production is calculated as follows:

$$q_{M-H2CHP} = \text{Min} [T_{M-H2CHP}, (h_{M-H2CHP} - q_{\text{Solar-M-H2CHP}} + (S_{\text{Solar-M-H2CHP}} - S_{\text{Solar-M-H2CHP}}))]$$

The calculations are done separately for each of the three micro CHP systems starting with the H2-CHP system, followed by the Ngas system and the biomass system. Between each calculation, the condensing power and excess productions are calculated.

6.6.2. Heat pump system

After calculating the CHP systems, the heat pump systems are calculated in the following way.

Like the CHP system, the heat production and the use of the heat storage give priority to solar thermal, which is calculated as the maximum value of either solar thermal or heat demand plus available room in the heat storage:

$$q_{\text{Solar-M-HP}} = \text{Max} [q_{\text{Solar-M-HP}}, h_{M-HP} + (S_{\text{Solar-M-HP}} - S_{\text{Solar-M-HP}})]$$

In case of condensing power production

If the solar production is lower than the heat demand and the production on the condensing power plant is positive, the heat demand will be supplied by the heat storage, if possible. Only in the case that this cannot be done, the heat pump units will be operated. Consequently, the heat pump production is calculated as follows:

$$q_{M-HP} = \text{Max} [0, (h_{M-HP} - S_{\text{Solar-M-HP}} - q_{\text{Solar-M-HP}})]$$

If the heat produced by the heat pump exceeds the capacity, the electric boiler is operated and the heat pump production is reduced to the level of the capacity

$$q_{M-HP-EH} = \text{Max} [0, (T_{M-HP} - q_{M-HP})]$$

$$q_{M-HP} = \text{Min} [q_{M-HP}, T_{M-HP}]$$

In case of CEEP

If CEEP is positive, the heat pump units will try to produce according to maximum capacity. Only in the case that excess heat production cannot be stored, the production of the heat pump units will decrease accordingly. Consequently, the heat production of the heat pump is calculated as follows:

$$q_{M-HP} = \text{Min} [T_{M-HP}, (h_{M-HP} - q_{\text{Solar-M-HP}} + (S_{\text{Solar-M-HP}} - S_{\text{Solar-M-HP}}))]$$

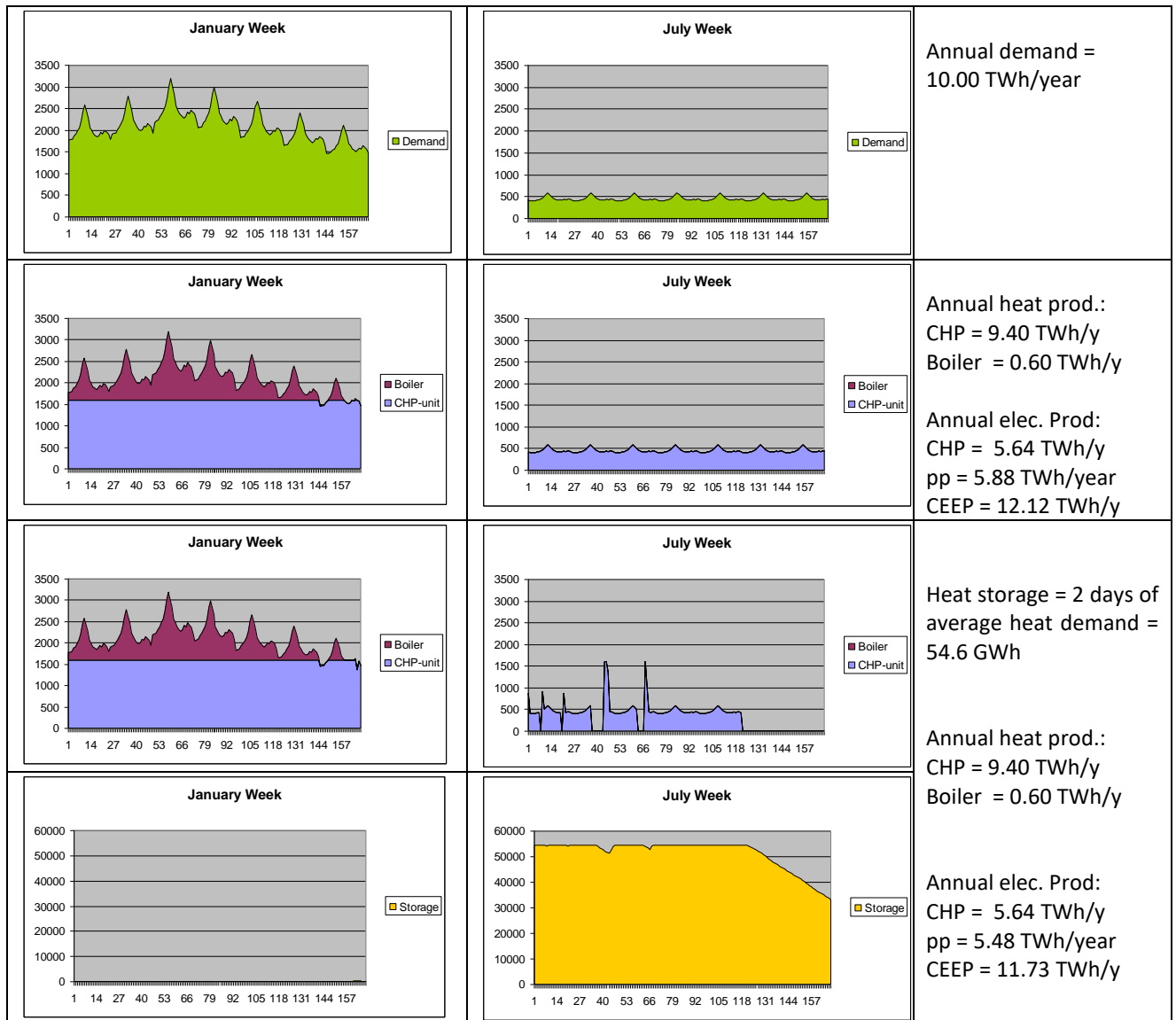

Diagram 6.8: When heat storage capacity is added to the individual micro CHP systems (the two lower diagrams), the excess production of the system and the power-only production are decreased compared to the reference without thermal storage (the two upper diagrams).

Diagram 6.8 illustrates how the model functions in the case of no solar thermal production. An annual heat demand of 10 TWh/year is specified and the resulting hourly distribution is shown in the upper

diagrams, for a week in January and a week in July, respectively. The next diagram shows the production in the same weeks divided between the CHP unit and the peak load boiler. On an annual basis, the CHP unit produces 9.40 TWh and the boiler produces 0.60 TWh of heat. The electricity production of the CHP units is 5.64 and, in the example, the power plant's production is 5.88 TWh/year and the excess production is 12.12 TWh/year. The two lower diagrams show how the model changes the productions IF heat storage capacity is added. The annual heat and electricity productions from the CHP unit are the same, but the heat storage allows a decrease in the power plant production and the excess production of the total system.

In diagram 6.9, the same calculations are shown in which solar thermal is added to the system. In such case, the model gives priority to the utilisation of the solar thermal input. In the two upper diagrams without heat storage capacity, the solar thermal input can not be fully utilised. When storage capacity is added, such capacity is first used in order to increase the utilisation of solar thermal from 1.25 to 1.49 TWh/year, and then to decrease the power-only production and the excess production of the system.

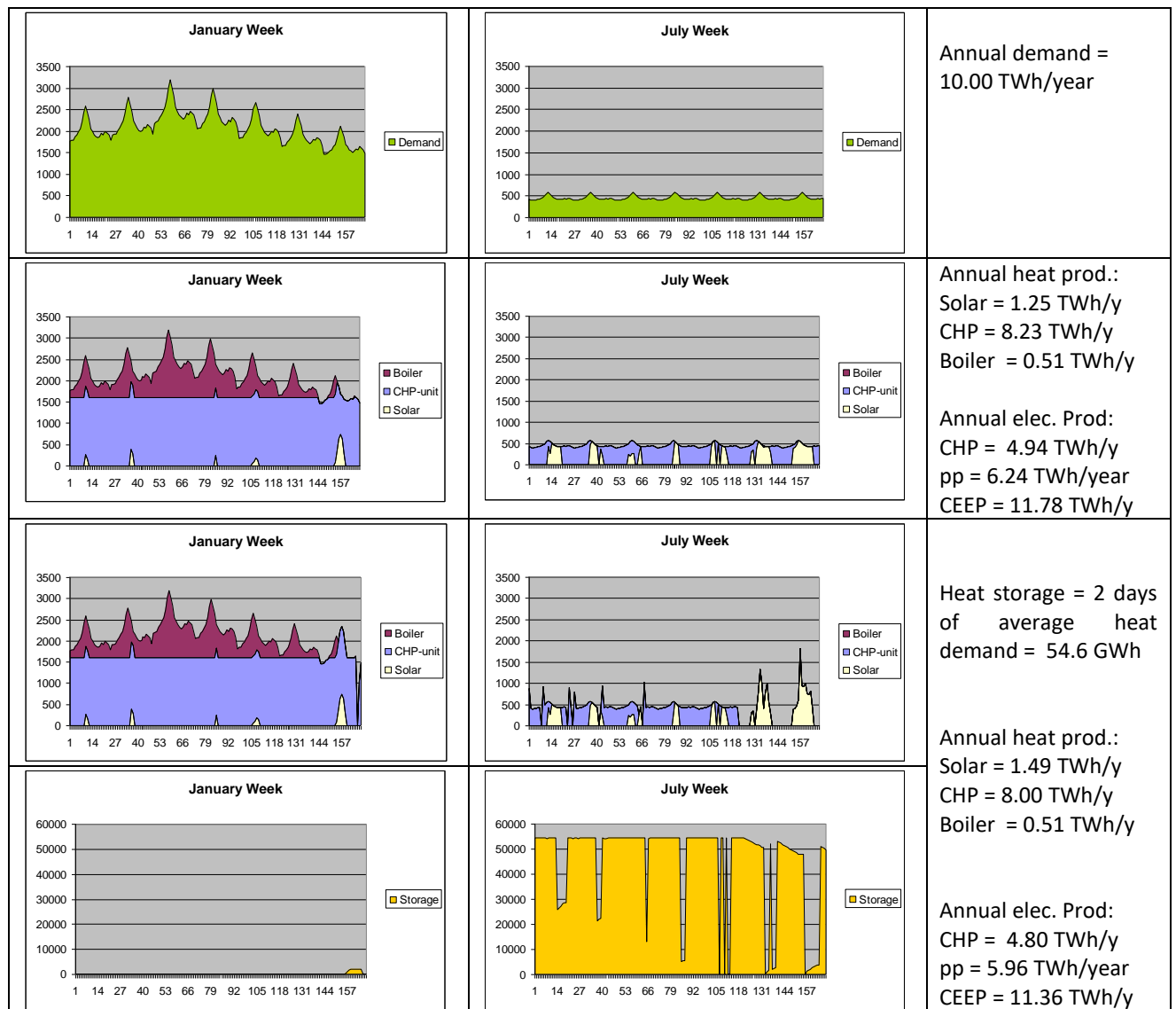

Diagram 6.9: Corresponds to diagram 6.8 plus solar thermal, which is then prioritised.

6.7. Electrolyser for micro CHP, Transport, Hydrogenation and DH groups

Four electrolyser systems are described in the model. Two of these are systems which are assumed to be located next to the district heating groups 2 and 3 along with the CHP units, heat pumps and boilers. Here, the heat production of the electrolysers can be utilised in the district heating supply. The two other systems produce hydrogen for micro CHP systems or for transport and hydrogenation. The electrolyser is assumed to be a hydrolyser (producing hydrogen), but can be used for modelling any kind of equipment converting electricity into fuel and heat.

6.7.1. Electrolysers for hydrogen production to individual micro CHP systems

The calculation is based on the result of the input calculation described in section 4.1.2.4., in which the minimum capacity of the electrolyser is identified together with the electricity demand, d_{ElcM} . The model seeks to reorganise such production in order to avoid excess and power-only productions.

First, the potential for increasing the production at hours of excess production is identified as the lower value of either CEEP or the difference between the capacity and the production of the electrolyser:

$$d_{ElcM-inc-pot} = \text{Min} [e_{CEEP}, (C_{ElcM} - d_{ElcM})]$$

Secondly, the potential for decreasing production at hours of power-only production is identified as the lower value of either the power production or the electrolyser demand:

$$d_{ElcM-dec-pot} = \text{Min} [e_{PP}, d_{ElcM}]$$

Then a balance is created in which either the potential of increasing or the potential of decreasing is lowered to achieve the same level as that of the annual potentials:

$$\text{If } D_{ElcM-dec-pot} > D_{ElcM-inc-pot} \text{ then } d_{ElcM-dec-pot} = d_{ElcM-dec-pot} * D_{ElcM-inc-pot} / D_{ElcM-dec-pot}$$

$$\text{If } D_{ElcM-inc-pot} > D_{ElcM-dec-pot} \text{ then } d_{ElcM-inc-pot} = d_{ElcM-inc-pot} * D_{ElcM-dec-pot} / D_{ElcM-inc-pot}$$

A new optimal distribution of the electrolyser electricity demand (producing exactly the same annual fuel as before) is calculated as:

$$d_{ElcM} = d_{ElcM} - d_{ElcM-dec-pot} + d_{ElcM-inc-pot}$$

Finally, such distribution is evaluated against the hydrogen storage capacity. First, the changes in storage content, S_{ElcM} , are calculated

$$S_{ElcM}(x) = S_{ElcM}(x-1) + d_{ElcM}(x) * \alpha_{ElcM} - f_{M-NgasCHP-Total}(x)$$

If the storage content based on such calculation is below zero, the production of the electrolyser is raised:

$$\text{If } S_{ElcM} < 0 \text{ then } d_{ElcM} = d_{ElcM} + (-S_{ElcM} / \alpha_{ElcM})$$

If the storage content exceeds the storage capacity, the production of the electrolyser is decreased:

$$\text{If } S_{ElcM} > S_{ElcM} \text{ then } d_{ElcM} = d_{ElcM} + (S_{ElcM} - S_{ElcM})$$

6.7.2. Electrolysers producing hydrogen for transport and hydrogenation

After simulating the electrolyser for individual micro hydrogen CHP systems, the calculation of excess and power-only production (section 6.1) is repeated, and then the calculation of the hydrogen production for transport and hydrogenation is done exactly the same way as for the micro CHP, as described in section 6.7.1 above.

The hourly supply of hydrogen for hydrogenation is (in the present version 12) assumed to be constant and therefore calculated as follows:

$$f_{\text{SynHydro-HydrogenDemand}} = F_{\text{SynHydro-HydrogenDemand}} * 1,000,000 / 8784$$

$$f_{\text{SynMethan-HydrogenDemand}} = F_{\text{SynMethan-HydrogenDemand}} * 1,000,000 / 8784$$

The hourly demand for transportation is found by the use of the hourly distribution file specified in the transportation tab sheet:

$$f_{\text{Transport-H2}} = F_{\text{Transport-H2}} * \delta_{\text{Transport-H2}} / \sum \delta_{\text{Transport-H2}}$$

The production of hydrogen is identified for all three hydrogen consumptions as a whole:

$$f_{\text{Total-HydrogenDemand}} = f_{\text{SynHydro-HydrogenDemand}} + f_{\text{SynMethan-HydrogenDemand}} + f_{\text{Transport-H2}}$$

6.7.3. Electrolyser for CO₂ Hydrogenation

The simulation of the CO₂ Hydrogenation is used to raise the efficiency of the whole system by seeking to consume electricity during hours of excess electricity production and minimise the use during hours of production on the power-alone plants. At the same time, the production of synthetic gas for the grid is specified in the input tab sheet.

First, the necessary minimum capacity of the CO₂ Hydrogenation plant is calculated as the average of the annual :

$$C_{\text{CO2Hydro-Average}} = F_{\text{CO2Hydro-GridGas}} * 1000000 / 8784$$

If the specified input required for the maximum capacity of the plant is equal to or lower than the necessary minimum, then the hourly production of synthetic grid gas and the demand for electricity are set as constant over the year. However, if the maximum capacity is higher, such flexibility is used to minimise the excess electricity production of the whole system in the same way as for micro CHP and transportation. The capacity on the electrolysers needed is defined as part of the transport electrolysers in the hydrogen tabsheet.

Additional to the above use of the CO₂ Hydrogenation plant, one may use the plant for producing additional synthetic gas to the grid during hours of excess electricity production and available capacity on the plant. Such use is activated by choosing CEEP regulation strategy 8 in the 'Balancing & Storage->Electricity' tab sheet, as further described in section 8.2.8.

6.7.4. Electrolyser for Ammonia Production

The simulation of the ammonia production is used to raise the efficiency of the whole system by seeking to consume electricity during hours of excess electricity production and minimise the use during hours of production on the power-alone plants. At the same time, the production of ammonia is specified in the input tab sheet.

First, the necessary minimum capacity of the ammonia plant is calculated as the average of the annual:

$$C_{\text{Ammonia-Average}} = F_{\text{Ammonia}} * 1000000 / 8784$$

There is no option of increasing the capacity of the ammonia plant. All flexibility is located in the electrolysers to produce the hydrogen.

6.7.5. Electrolysers in district heating systems

The simulation of the electrolysers in the district heating system is used solely to avoid critical excess electricity production, exactly as the two other electrolysers. However, the electrolysers in the district heating system do not have to produce a certain amount of hydrogen (as the two other electrolysers, which must meet the demands of the hydrogen CHP and transport systems).

The sequence of the calculations is as follows. First, the electrolysers of district heating groups 3 and 2 are calculated. After each calculation, the calculation of excess production (section 6.1) is repeated.

The electrolysers in each of the district heating systems are regulated in the following way:

The electrolyser is used for producing fuel in the case of critical excess production, $e_{\text{CEEP}} > 0$.

The fuel is used for reducing the fuel consumption of the CHP unit and the boiler of the particular group.

If the thermal efficiency is equal to 0, the use of electrolysers is simply calculated as the minimum value of either the CEEP value or the capacity of the electrolysers.

$$\text{If } \rho_{\text{Elc}} = 0 \text{ Then } e_{\text{Elc}} = \min(e_{\text{CEEP}}, C_{\text{Elc}})$$

If the thermal efficiency is positive, the heat of the electrolyser is used for reducing heat production of other units according to the following order of priority:

- reduce boiler production
- reduce CHP production
- reduce heat pump production
- wasted

Step1: Replace boiler heat production

First, the potential replacement of the boiler is calculated as the minimum value of either (1) the critical excess production, (2) the capacity of the electrolyser, or (3) the electricity consumption responding to the heat production of the boiler. The latter is found by dividing the heat production of the boiler by the thermal efficiency of the electrolyser. The excess production and the productions of the boiler and the electrolyser are then adjusted accordingly.

$$\text{Potential} = \min (e_{\text{CEEP}}, C_{\text{Elc}}, q_{\text{B}} / \rho_{\text{Elc}})$$

$$e_{\text{CEEP}} = e_{\text{CEEP}} - \text{Potential}$$

$$e_{\text{Elc}} = \text{Potential}$$

$$q_{\text{Elc}} = \text{Potential} * \rho_{\text{Elc}}$$

$$q_{\text{B}} = q_{\text{B}} - \text{Potential} * \rho_{\text{Elc}}$$

Step 2: Replace CHP heat production

If the excess production is still positive, then the potential decrease in the CHP unit is found; first by calculating the factor which will make it possible to remove critical excess production without creating import. This factor takes into account the fact that the replacement of the CHP by the electrolyser influences the excess production, as the CHP production is decreased and the electrolyser consumption is increased. The factor is determined by the following equations:

$$\delta e_{\text{CEEP}} = \delta e_{\text{CHP}} + \delta e_{\text{Elc}}$$

$$\delta q_{\text{CHP}} = \delta q_{\text{Elc}}$$

$$\delta q_{\text{Elc}} = \delta e_{\text{Elc}} * \rho_{\text{Elc}}$$

$$\delta q_{\text{CHP}} = \delta e_{\text{CHP}} * \rho_{\text{CHP}} / \mu_{\text{CHP}}$$

The factor then becomes:

$$\text{Factor} = 1 + \rho_{\text{CHP}} / (\mu_{\text{CHP}} * \rho_{\text{Elc}})$$

The factor is used for identifying the potential replacement of the CHP in which the combination of the CHP decrease and the electrolyser increase outbalances the excess production. Consequently, the potential CHP reduction is identified as the critical excess production divided by the factor. Again, the potential replacement of the CHP unit is identified as the minimum value of either such reduction or the capacity of the electrolyser or the electricity consumption responding to the heat production of the CHP unit.

$$\text{Potential} = \min [e_{\text{CEEP}} / \text{Faktor}, (C_{\text{Elc}} - e_{\text{Elc}}), q_{\text{CHP}} / \rho_{\text{Elc}}]$$

In the case of group 3, the potential reduction in the heat production of the CHP unit is identified as the difference between the actual production and the minimum production according to the simulation.

$$\text{In group 3: Potential} = \min [e_{\text{CEEP}} / \text{Faktor}, (C_{\text{Elc}3} - e_{\text{Elc}3}), (q_{\text{CHP}3} - q_{\text{CHP}3\text{-minimum}}) / \rho_{\text{Elc}}]$$

Again, the excess production and the production of the CHP and the electrolyser are then adjusted accordingly, as in the previous case of the boiler.

Step 3: Replace the heat production of the heat pump

If the excess production is still positive, the potential decrease in the heat pump (HP) unit is found; first by calculating the factor which will make it possible to remove critical excess production without creating import. This factor takes into account the fact that the replacement of the HP by the electrolyser influences the excess production, as HP production decreases and electrolyser consumption increases. The factor is determined by the following equations:

$$\delta e_{\text{CEEP}} = \delta e_{\text{HP}} + \delta e_{\text{Eic}}$$

$$\delta q_{\text{HP}} = \delta q_{\text{Eic}}$$

$$\delta q_{\text{Eic}} = \delta e_{\text{Eic}} * \rho_{\text{Eic}}$$

$$\delta q_{\text{HP}} = \delta e_{\text{HP}} * \phi_{\text{HP}}$$

And the factor then becomes:

$$\text{Factor} = \phi_{\text{HP}} / \rho_{\text{Eic}} - 1$$

The factor is used for identifying the potential replacement of the HP by which the combination of the HP decrease and the electrolyser increase outbalances the excess production. Consequently, the potential HP reduction is identified as the critical excess production divided by the factor. Again, the potential replacement of the HP unit is identified as the minimum value of either such reduction or the capacity of the electrolyser or the electricity consumption responding to the heat production of the HP unit.

$$\text{Potential} = \min (e_{\text{CEEP}} / \text{Faktor} , (C_{\text{Eic}} - e_{\text{Eic}}), q_{\text{HP}} / \rho_{\text{Eic}})$$

The excess production and the production of the HP and the electrolyser are then adjusted accordingly, as in the previous case of the boiler and the CHP.

Step 4: Electrolyser heat production is wasted

If the excess production is still positive, the potential increase in the electrolyser is simply identified as the minimum value of either the excess production or the remaining increase up to the capacity of the electrolyser.

$$\text{Potential} = \min [e_{\text{CEEP}} , (C_{\text{Eic}} - e_{\text{Eic}})]$$

The excess production and the production of the electrolyser are then adjusted accordingly.

6.8. Heat storage in groups 3 and 2

To improve the possibilities of minimising the electricity export, the heat storage capacity is included in the model for each of the district heating groups 2 and 3. Again, such storage capacities are used for minimising the excess and power-only productions in the system.

One can choose between a weekly and a seasonal regulation strategy. In the weekly, one can specify a desired time period if not a week exactly. The difference is that in the weekly strategy the model will seek to balance input/output of the storage within the time period specified, while in the seasonal strategy the model will run for the whole year. If the storage is very large, the seasonal strategy will

likely find the best solution, while the weekly strategy will be able to make best use of the storage if it is small.

In three situations, the storage can be loaded:

- A: when solar and/or industrial excess heat exceeds the heat demand
- B: By increasing the use of HP in situations with electricity export.
- C: By moving the electricity production from condensing plants, e_{pp} , to CHP plants.

In three situations, the storage can be unloaded:

- D: By reducing the CHP production in situations with electricity export.
- E: By reducing the boiler production.
- F: By reducing the use of HP in situations of PP or import.

B and C are secondary to A, and E and F are secondary to D.

These series are then used in the following order:

- 1: Critical excess electricity production, e_{CCEEP} , and CHP in group 3
- 2: Critical excess electricity production, e_{CCEEP} , and CHP in group 2
- 3: Exportable excess electricity export, e_{EEEP} , and CHP in group 3
- 4: Exportable excess electricity export, e_{EEEP} , and CHP in group 2

In order to achieve balance, the calculations are performed in series of two-week periods in which the storage content at the end of the year is equal to the storage content at the beginning of the year. These 14 days period can be changed by the user in the simulation input tabsheet "Days of optimizing Thermal Storage". Which length to use depends on the size of the thermal storage in comparison to the heat demand. If the storage is in the size of days the length should be relatively short (like weeks). However if the storage is in the size so that it can balance seasonal differences the length should be long (like months).

The five loading and unloading situations are calculated as follows:

A: loading by increasing the use of HP in situations with electricity export

First, the minor of the potential increase in district heating production from HP, q_{HP-inc} , and the potential increase in storage content, S_{inc} , is determined:

$$q_{HP-inc} = \min(e_{EEP}, C_{HP} - e_{HP}) * (T_{HP}/C_{HP})$$

$$S_{inc} = S_{DH} - S_{DH}$$

New values can now be calculated:

$$e_{HP} = e_{HP} + \min(q_{HP-inc}, S_{inc}) * (C_{HP}/T_{HP})$$

$$e_{EEP} = e_{EEP} - \min(q_{HP-inc}, S_{inc}) * (C_{HP}/T_{HP})$$

$$q_{HP} = q_{HP} + \min(q_{HP-inc}, S_{inc})$$

$$S_{DH} = S_{DH} + \min(q_{HP-inc}, S_{inc})$$

B: Moving the electricity production from condensing plants, e_{pp} , to CHP plants

First, the minimum condensing power plant production needed in order to stabilise the grid is found (see section 6.1 for more details):

$$e_{PP-min} = (e_{Total} * Stab_{total} - e_{CHP2} * Stab_{CHP2} - (e_{W1} + e_{W2} + e_{W3}) * Stab_{Waste} - e_{RES1} * Stab_{RES1} - e_{RES2} * Stab_{RES2} - e_{RES3} * Stab_{RES3} - \dots - e_{RES7} * Stab_{RES7} - e_{CHP3} - e_{Nuclear} - e_{Geothermal} - e_{Hydro} - e_{Turbine} - e_{V2G} - e_{CSP} * Stab_{CSP} - e_{V2G} * Stab_{V2G} - C_{imp/exp} * Stab_{TRANS}) / (1 - Stab_{total})$$

Then, the potential increase in district heating production from CHP, $q_{CHP-inc}$, and the potential increase in storage content, s_{inc} , are determined:

$$q_{CHP-inc} = \min [(C_{CHP} - e_{CHP}) ; (e_{PP} - e_{PP-min})]$$

$$s_{inc} = S_{DH} - s_{DH}$$

New values can now be calculated:

$$e_{CHP} = e_{CHP} + \min(q_{CHP-inc}, s_{inc}) * (C_{CHP}/T_{CHP})$$

$$e_{PP} = e_{PP} - \min(q_{CHP-inc}, s_{inc}) * (C_{CHP}/T_{CHP})$$

$$q_{CHP} = C_{CHP} + \min(q_{CHP-inc}, s_{inc})$$

$$s_{DH} = s_{DH} + \min(q_{CHP-inc}, s_{inc})$$

C: Reducing the CHP production in situations with electricity export

First, the minimum CHP production needed in order to stabilise the grid is found. In the case of district heating (DH) group 2:

$$e_{CHP2-min} = (e_{Total} * Stab_{total} - (e_{W1} + e_{W2} + e_{W3}) * Stab_{Waste} - e_{RES1} * Stab_{RES1} - e_{RES2} * Stab_{RES2} - e_{RES3} * Stab_{RES3} - \dots - e_{RES7} * Stab_{RES7} - (e_{PP} / Stab_{Total}) - e_{CHP3} - e_{Nuclear} - e_{Geothermal} - e_{Turbine} - e_{Hydro} - e_{CSP} * Stab_{CSP} - e_{V2G} * Stab_{V2G} - C_{imp/exp} * Stab_{TRANS}) / Stab_{CHP2}$$

And in the case of DH group 3:

$$e_{CHP3-min} = e_{Total} * Stab_{total} - (e_{W1} + e_{W2} + e_{W3}) * Stab_{Waste} - e_{RES1} * Stab_{RES1} - e_{RES2} * Stab_{RES2} - e_{RES3} * Stab_{RES3} - e_{RES4} * Stab_{RES4} - (e_{PP} / Stab_{Total}) - e_{Nuclear} - e_{Geothermal} - e_{Hydro} - e_{Turbine} - (e_{CHP2} / Stab_{CHP2})$$

$$\text{If } e_{CHP3-min} < C_{CHP3-min} \text{ then } e_{CHP3-min} < C_{CHP3-min}$$

Secondly, the potential for decreasing the CHP heat production, $q_{CHP-red}$, is identified as the lower value of either the excess production or the difference between the actual production and the minimum production required for grid stabilisation:

$$q_{CHP-red} = \min(e_{EEP}; e_{CHP} - e_{CHP-min}) * (T_{CHP}/C_{CHP})$$

New values can now be calculated:

$$e_{CHP} = e_{CHP} - \min(q_{CHP-red}, s_{DH}) * (C_{CHP}/T_{CHP})$$

$$e_{EEP} = e_{EEP} - \min(q_{CHP-red}, S_{DH}) * (C_{CHP}/T_{CHP})$$

$$q_{CHP} = q_{CHP} - \min(q_{CHP-red}, S_{DH})$$

$$S_{DH} = S_{DH} - \min(q_{CHP-red}, S_{DH})$$

D: Reducing boiler production.

First, the smallest potential reduction in boiler production, q_{B-red} , and the potential reduction in storage content, S_{red} , are determined:

$$q_{B-red} = q_B$$

New values can now be calculated:

$$q_B = q_B - \min(q_{B-red}; S_{DH})$$

$$S_{DH} = S_{DH} - \min(q_{B-red}; S_{DH})$$

E: Reducing the use of HP in situations of production on condensing plants, e_{PP} .

First, the minimum condensing power plant production needed in order to stabilise the grid is found (see section 6.1 for more details):

$$e_{PP-min} = (e_{Total} * Stab_{total} - e_{CHP2} * Stab_{CHP2} - (e_{W1} + e_{W2} + e_{W3}) * Stab_{Waste} - e_{RES1} * Stab_{RES1} - e_{RES2} * Stab_{RES2} - e_{RES3} * Stab_{RES3} - \dots - e_{RES7} * Stab_{RES7} - e_{CHP3} - e_{Nuclear} - e_{Geothermal} - e_{Hydro} - e_{Turbine} - e_{CSP} * Stab_{CSP} - e_{V2G} - e_{V2G} * Stab_{V2G} - C_{Imp/exp} * Stab_{TRANS}) / (1 - Stab_{total})$$

Then, the potential decrease in electricity consumption from the heat pump is identified as the minimum of either the heat pump consumption or the potential decrease in the power plant:

$$e_{HP-dec} = \min [e_{HP}; (e_{PP} - e_{PP-min})]$$

New values can now be calculated:

$$e_{HP} = e_{HP} - e_{HP-dec}$$

$$e_{PP} = e_{PP} - e_{HP-dec}$$

6.9. Transport (Smart charge and V2G)

Definition of inputs:

- D_{V2G} : Transport demand of V2G cars in TWh/year (defined as demand from the grid)
- δ_{V2G} : The distribution of the transport demand in 8784 hourly values. (The numbers are relative, e.g., each ranging from 0 to 1).
- $C_{Charger}$: The capacity of the grid connection in MW
- $V2G_{MaxShare}$: The maximum share of V2G cars which are driving during peak demand hour.

μ_{Charger} : The efficiency of the grid to battery connection (charger).
 μ_{Inverter} : The efficiency of the battery to grid connection (inverter).
 $S_{\text{V2G-Battery}}$: The capacity of the battery storage in GWh
 $V2G_{\text{Connection-Share}}$: The share of parked V2G cars connected to the grid.

All inputs are expressed for the entire utility system analysed and for the entire vehicle fleet within the service territory of that utility system. Thus, for example, the maximum system capacity, C_{Charger} , is calculated on the basis of the maximum power of a single car multiplied by the maximum number of vehicles plugged in at any given time.

One important input is the distribution of the transport demand (δ_{V2G}), which is used for two purposes. One is to determine how many V2G cars are driving and consequently not connected to the grid at the hour in question. This, together with the $V2G_{\text{Max-Share}}$ (the maximum share of V2G cars which are driving during peak demand hour) and the $V2G_{\text{Connection-Share}}$, determines the fraction of the V2G fleet that is available to the electrical system at any given hour. The other purpose of defining δ_{V2G} is to determine the discharging of the battery storage caused by driving.

Initial input calculations

The hourly transport demand, and thereby the discharging of the battery (t_{V2G}), is calculated as follows:

$$t_{\text{V2G}} = [D_{\text{V2G}} * \delta_{\text{V2G}} / \sum \delta_{\text{V2G}}] * \eta_{\text{CHARGE}}$$

The grid connection capacity of the total V2G fleet on an hourly basis (c_{V2G}) is calculated as follows:

$$c_{\text{V2G}} = C_{\text{Charger}} * V2G_{\text{Connection-Share}} * ((1 - V2G_{\text{Max-Share}}) + V2G_{\text{Max-Share}} * (1 - \delta_{\text{V2G}} / \text{Max}(\delta_{\text{V2G}}))$$

This formula is constituted by three factors. The first factor is C_{Charger} , the power capacity of the entire V2G fleet. This is multiplied by $V2G_{\text{Connection-Share}}$, the fraction of the parked vehicles which is assumed to be plugged. The third factor, in parentheses, calculates the fraction of vehicles on the road at each hour. The third parenthesised factor is based on the sum of two terms. The first term, $(1 - V2G_{\text{Max-Share}})$, represents the minimum fraction of vehicles parked. The second term is the additional fraction of vehicles parked during non-rush hours. The hourly fraction of vehicles parked is derived from the known input of hourly energy demand for the fleet. This formula yields c_{V2G} , the power capacity of all connected V2G vehicles, at any given hour. This is a calculation of capacity, not considering whether sufficient battery power is available. This will be treated in the next section.

The calculation works as described in the following example of 1.9 million cars, each with a grid connection of 10 kW and each with a demand of 2 MWh/year, equal to 20,000 km/year. The charger and inverter efficiencies are each defined as 0.9. In total, the demand for transport becomes $D_{\text{V2G}}=3.8$ TWh/year and a maximum capacity of 19,000 MW. The power used is distributed between a peak demand during rush hours between 7:00 and 9:00 a.m. and again between 16:00 and 18:00 p.m., as shown in the diagram for one week (Please, recall that this is battery demand, not electric system demand, as the vehicles are necessarily disconnected from the grid while driving).

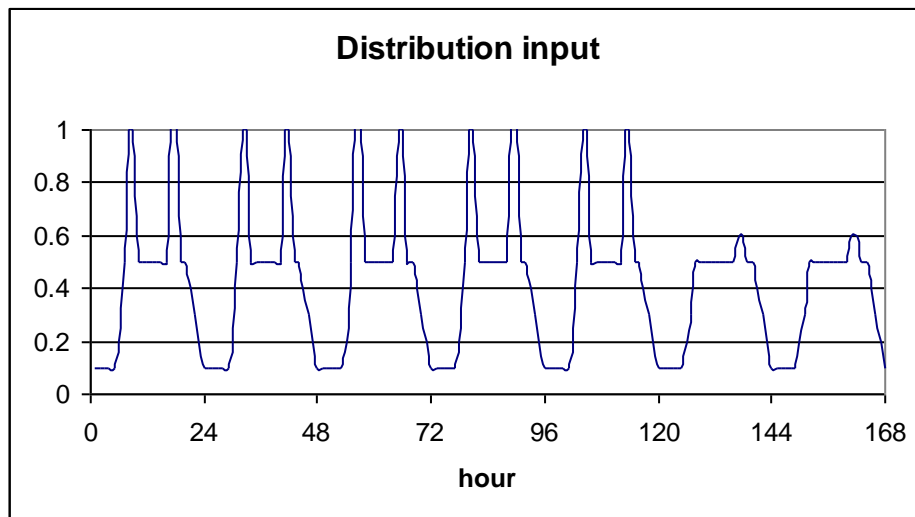

Diagram 6.10: Input distribution of transport demand

Based on such information, the model will calculate the distribution of the demand and thereby also the discharging of the battery, as shown in the next diagram. The sum of the diagram within a year becomes 3.42 TWh/year equal to $0.9 \cdot 3.8$ TWh/year.

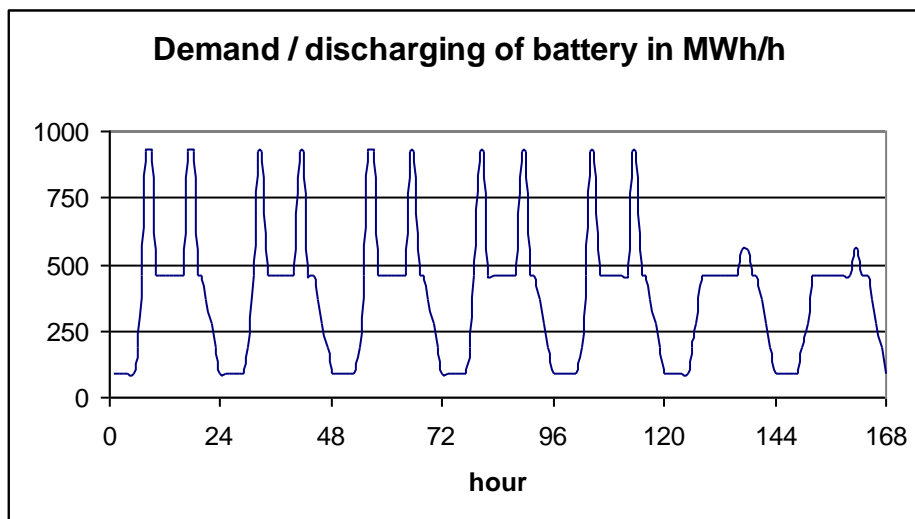

Diagram 6.11: Transport demand and discharging of battery.

The calculation of the available grid connection depends on the definition of both the maximum share of V2G cars, $V2G_{MaxShare}$, and the share of parked vehicles which are connected, $V2G_{ConnectionShare}$. If both are 100 per cent, the result is as shown in the upper figure of diagram 6.12. In such case, the model assumes that all vehicles are driving during peak demand and, consequently, the grid connection becomes zero. During low demand, the grid connection becomes equal to the maximum grid connection, $C_{Charger}$, subtracting the few vehicles that are driving.

Even during peak demand (rush hour), the model does not assume that all vehicles are driving. By setting the $V2G_{MaxShare}$ value, one can define how many cars are parked and potentially connected to the grid during peak demand. In diagram 6.12 (the figure in the middle), the $V2G_{MaxShare}$ has been defined as 20 per cent, representing a typical situation in which a minimum of 80 per cent of all cars are parked during rush hours (Kempton et al 2001).

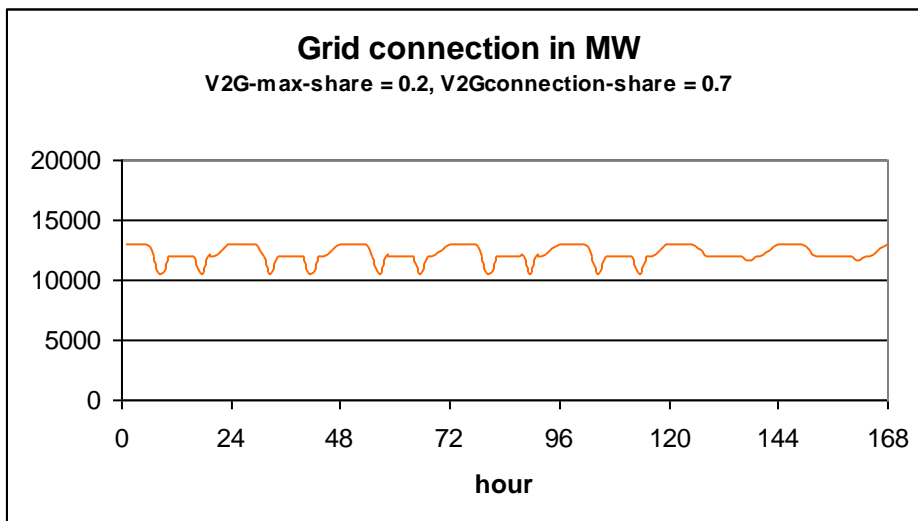
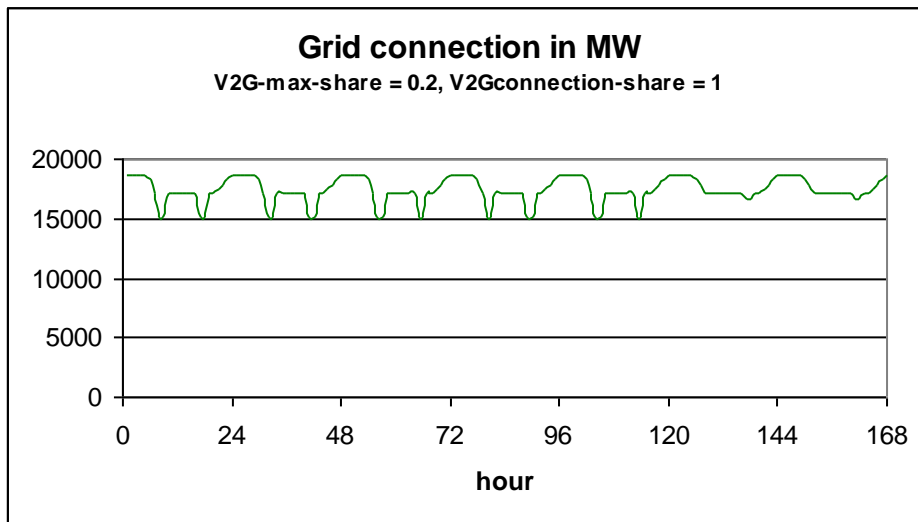
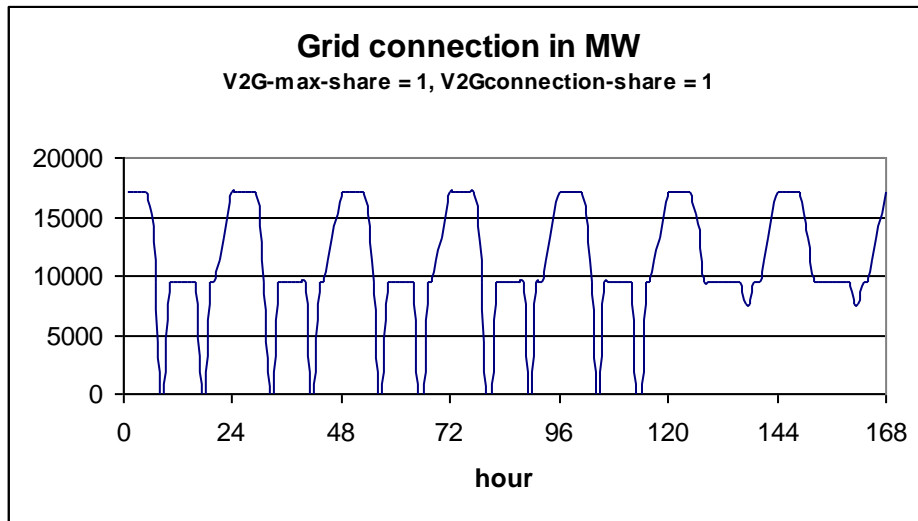

Diagram 6.12: The model calculation of the available grid connection for three different combinations of input definitions.

In the lower figure of diagram 6.12, the input of the share of parked vehicles which are connected, $V2G_{\text{ConnectionShare}}$, has been changed from 100 to 70 per cent and, consequently, the grid connection is decreased in general by 30 per cent compared to fig 2.

Considerations of the modelling of the battery and loading before disconnecting

The batteries of the V2G fleet are modelled as if one “big battery” existed for the entire vehicle fleet. The available battery capacity is equal to the maximum capacity. In reality, the total capacity of the battery is not available all the time, since some of the cars will be driving and can neither discharge to nor charge from the grid; others will need to drive during the next few hours and thus cannot be discharged. However, for reasons of simplicity, the model assumes that the batteries for the cars are fully loaded when the cars disconnect and start driving. Consequently, the model does not gain much from keeping separate accounts of the share of the battery which is not connected, since this part would typically be fully loaded within the hour anyway. However, the share representing the cars driving will change a bit from one hour to another in the case of cars driving for more than one hour. If one wants to take such issues into consideration, one could simply make a small reduction in the input value for the capacity of the battery, $S_{V2G\text{-Battery}}$.

The model is required to make sure that the individual car is fully loaded before it disconnects. In general, the batteries are loaded in the case of excess electric power production. However, when there is not excess power production, the model has to make sure that the batteries are loaded prior to driving periods. (In a future refinement of the model, we may assume that the vehicle controller is able to infer how much charge is needed and would not need to always fully charge if there is no excess production and vehicle use is highly regular; e.g., if intercity trips are only made on Saturdays, the battery may not need to be fully charged at early mornings during weekdays.)

The model assumes that the scheduler of each car is 100% accurate in terms of determining when the driver will need to drive again. Therefore, the scheduler is assumed to prioritise charging of the cars that will drive again within the next few hours, so if there is only a small amount of excess wind, it is directed to the cars that will be in use next time. That is, during each hour, the model inspects the next, e.g., two hours of driving needs, and if the big battery is not sufficiently loaded for this, the charging is forced even in the case of lack of excess production. In this case, if needed, fossil fuel power plants will be switched on if there is not enough excess wind production.

Such procedure simulates a situation in which the individual car owner will make priorities in terms of how to optimise between low charging costs and the security of fully loaded batteries when starting to drive. The car owner does this by setting prices and limitations on the computer control of the car. However, the car owner will learn from experience and will soon know how to optimise. He will also know how many hours in advance he must start the charging of the battery even in the case of no low prices.

Here, the model on its own identifies the number of hours needed to secure driving and thereby the minimum battery loading. The necessary number of hours will depend on both the shape and pattern of the distribution of the transport demand as well as on the definition of the rest of the energy system. For example, a system in which the excess production is severe will call for less “pre-loading” than a system in which the excess production is small.

The necessary hours of “pre-loading” are found by use of try-and-error. The model starts by assuring that the battery always has the minimum load required in order to supply the next hour and if this

results in lack of battery content, the number is raised to two, etc. The number of hours becomes a result of the calculation. In an optimised electric control system, the number of hours prior to driving might also be determined by weather forecasts regarding anticipated wind for the next few hours, but we do not consider such refinements here.

Modelling of the V2G cars

For each hour, the model calculates as follows. The V2G cars are told to charge in the case of available excess electricity production (e_{CEEP}) and available battery energy capacity ($S_{V2G-Battery} - S_{V2G-Battery}$) within the limitations of the power capacity of the grid connection (c_{V2G}) for that particular hour. Thus, the formula utilises the minimum of these three values:

$$e_{Charge} = \min [e_{CEEP}, (S_{V2G-Battery} - S_{V2G-Battery}) / \mu_{Charge}, c_{V2G}]$$

Moreover, as mentioned above, the charging is forced in the case in which the transport demands of the present and the next “y” hours cannot be supplied by the battery content. Initially, the “y” value is set to one hour. If this leads to lack of battery content, the value is raised in steps of one hour.

The minimum battery content needed is calculated:

$$S_{V2G-Battery-min} = \sum_{a+y}^{x=a} t_{V2G}$$

Then, the charging of the battery is adjusted accordingly, by requiring that:

$$e_{Charge} \geq [S_{V2G-battery} - S_{V2G-Battery-min}] / \mu_{Charge}$$

If e_{Charge} becomes higher than the capacity of the grid connection, c_{V2G} , the number of hours, y, is raised by one, and the calculations start again.

The new battery content is then calculated by adding the above charging and subtracting the discharging caused by driving (t_{V2G}):

$$S_{V2G-Battery} := S_{V2G-Battery} - t_{V2G} + (e_{Charge} * \mu_{Charge})$$

The V2G cars are told to supply to the grid in the case of a potential replacement of production from power plants (e_{PP}) and available stored electricity in the battery after the supply of the transport demand:

$$e_{Inv} = \min [e_{PP}, ((S_{V2G-Battery} - S_{V2G-Battery-min}) * \mu_{Inv}), c_{V2G}]$$

The resulting new battery content is then calculated as follows

$$S_{V2G-Battery} := S_{V2G-Battery} - (e_{Inv} / \mu_{Inv})$$

Due to differences in the battery storage content at the beginning and the end of the calculation period (one year), errors may appear in the calculations. To correct these errors, the above calculation is repeated until the storage content at the end is the same as at the beginning. Initially, the storage content is defined as 50% of the battery storage capacity. After the first calculation, a new initial

content is defined as the resulting content at the end of the calculation. Such procedure is repeated until the difference is insignificant.

REFERENCES CITED:

Kempton, W., J. Tomic, S. Letendre, A. Brooks & T. Lipman. 2001. Vehicle-to-Grid Power: Battery, Hybrid, and Fuel Cell Vehicles as Resources for Distributed Electric Power in California. UCD-ITS-RR-01-03.

Kempton, Willett and Jasna Tomic, 2005a. Vehicle to Grid Fundamentals: Calculating Capacity and Net Revenue. *J. Power Sources* Volume 144, Issue 1, 1 June 2005, Pages 268-279. doi:10.1016/j.jpowsour.2004.12.025.

6.10. Electricity storage

The electricity storage is described in the model as a hydro storage consisting of the following components:

- Pump (converting electricity to potential energy) defined by a capacity and an efficiency
- Turbine (converting potential energy to electricity) defined by a capacity and an efficiency
- Storage (storing energy) defined by a capacity.

On the other hand, the hydro storage can be used for modelling any kind of electricity storage, for example batteries.

The simulation of the storage is used solely to avoid critical excess electricity production. The storage facility is regulated in the following way:

The pump is used for filling the storage in the case of critical excess production, $e_{CEEP} > 0$. In such case, the available space in the storage ($S_{CAES} - S_{CAES}$) is calculated and the electricity demand of the pump (e_{Pump}) is identified as the minimum value of the following three figures:

- e_{CEEP} , the critical excess production
- $(S_{CAES} - S_{CAES}) / \alpha_{Pump}$ available storage capacity divided by the pump efficiency
- C_{Pump} , the maximum capacity of the pump.

$$\text{If } e_{CEEP} > 0 \text{ then } e_{Pump} := \min [e_{CEEP}, (S_{CAES} - S_{CAES}) / \alpha_{Pump}, C_{Pump}]$$

$$S_{CAES} = S_{CAES} + e_{Pump} / \alpha_{Pump}$$

The turbine is used for emptying the storage, first by replacing import and then power plant production if $e_{pp} > 0$. In such case, the content of the storage (S_{CAES}) is identified and the electricity production of the turbine ($e_{Turbine}$) is identified as the minimum value of the following three figures:

- e_{import}, e_{pp} , electricity import or electricity production of the power plant, respectively
- $S_{CAES} * \mu_{Turbine}$, storage content multiplied by turbine efficiency
- $C_{Turbine}$, the maximum capacity of the turbine.

$$\text{If } e_{import} > 0 \text{ then } e_{Turbine1} := \min [e_{import}, S_{CAES} * \mu_{Turbine}, C_{Turbine}]$$

$$\text{If } e_{pp} > 0 \text{ then } e_{Turbine2} := \min [e_{pp}, S_{CAES} * \mu_{Turbine}, (C_{Turbine} - e_{Turbine1})]$$

$$e_{Turbine} = e_{Turbine1} + e_{Turbine2}$$

$$S_{CAES} = S_{CAES} - e_{Turbine} / \mu_{Turbine}$$

Due to differences in the storage content between the beginning and the end of the calculation period, errors may appear in the calculations. In order to correct these errors, the above calculation is repeated until the storage content at the end is the same as at the beginning. Initially, the storage content is defined as 50% of the storage capacity. After the first calculation, a new initial content is defined as the resulting content at the end of the calculation. Such procedure is repeated until the difference is insignificant.

CAES (Compressed Air Energy Storage)

The electricity storage facility can also be used to model a Compressed Air Energy Storage component. The CAES component is modelled in a similar way to the pumped hydro storage; the main difference is the fuel consumption at the electricity production stage. Consequently, one has to specify a CAES fuel ratio, ϕ_{CAES} , which is defined as the fuel input divided by the electricity production of the turbine, $e_{Turbine}$.

Please, note that in CAES, the main loss in the storage is heat loss, which occurs only during the initial hours after compression. As a certain time usually elapses before the expansion phase begins, the heat loss in the storage is included in the compressor efficiency definition.

The compressor is utilised in the model after calculating the heat and electricity production of the CHP and power plants, but before reducing excess electricity by use of other means. When hydro storage is pumped into the system, this is prioritised over the CAES plant operation.

The turbine is utilised with the objective of replacing power plant production.

6.11. Desalination

The desalination unit is described in the model (see the input section) as consisting of the following components:

- Fresh Water demand and storage:
- Desalination Plant including Pumps:
- Pump Hydro Energy Storage

In principle (if the fresh water demand varies) one may end up in a situation where the maximum contribution of fresh water from desalination in combination with the fresh water storage content will not be able to cover the demand in a given hour. Therefore to prevent this from happening, the first calculation is the fresh water storage capacity required to ensure that the fresh water demand is always met, which is carried out as follows:

$$S_{FRESH-MIN(hour\ 8784)} = \text{Max} [(d_{FRESH} - C_{DESALINATION}) , 0]$$

$$S_{FRESH-MIN(hour\ x)} = \text{Max} [(S_{FRESH-MIN(hour\ x+1)} + d_{FRESH} - C_{DESALINATION}) , 0]$$

When operating the plant to minimize electricity excess and power alone production, one may end up in a situation where an increase in the desalination may decrease excess electricity and there is available capacity in the fresh water storage, but not in the brine storage. In this situation one has to choose between one of the following two options: 1) accept excess production or 2) waste brine. Consequently the user is asked in the input TabSheet if it is ok to lose brine. If the user will not brine

to be lost, then EnergyPLAN will calculate the minimum available content in the brine storage for each hour in the following way.

First the minimum production of fresh water is identified for hour x ($w_{\text{FRESH-MIN}(\text{hour } x)}$) if the above minimum content of the fresh water storage can be fulfilled. The value is equal to the demand plus the difference in the minimum storage content in the given hour and the next:

$$w_{\text{FRESH-MIN}(\text{hour } x)} = d_{\text{FRESH}} + (S_{\text{FRESH-MIN}(\text{hour } x+1)} - S_{\text{FRESH-MIN}(\text{hour } x)})$$

The equivalent minimum brine production is then given as:

$$w_{\text{BRINE-MIN}(\text{hour } x)} = w_{\text{FRESH-MIN}(\text{hour } x)} / \text{SHARE}_{\text{FRESH}} * \text{SHARE}_{\text{BRINE}}$$

In order not to waste brine the available capacity in the storage in the beginning of hour x ($S_{\text{BRINE}} - S_{\text{BRINE}(\text{hour } x)}$) has to be bigger than the difference between the minimum input of brine and the maximum capacity of the turbine:

$$S_{\text{BRINE}} - S_{\text{BRINE}(\text{hour } x)} > w_{\text{BRINE-MIN}(\text{hour } x)} * \phi_{\text{BRINESTORAGE}} - C_{\text{TURBINE}}$$

And therefore the maximum content in the brine storage can be found as:

$$S_{\text{BRINE-MAX}(\text{hour } x)} = S_{\text{BRINE}} - w_{\text{BRINE-MIN}(\text{hour } x)} * \phi_{\text{BRINESTORAGE}} + C_{\text{TURBINE}}$$

This maximum content represents a situation in which the desalination unit is operated accurately to assure the necessary content in the fresh water storage at any hour. However if the desalination plant has been used to fill the fresh water storage above, the minimum content necessary. this represent a situation in which the demand for minimum fresh water production is decreased. This decrease influences the brine production and subsequently also the demand for minimum available space in the brine storage to avoid waste of brine.

The possible reduction in input to the brine storage (ΔS_{BRINE}) can be found as a function of the content in the fresh water additional to the necessary minimum content ($S_{\text{FRESH}} - S_{\text{FRESH-MIN}}$):

$$(\Delta S_{\text{BRINE}}) = (S_{\text{FRESH}} - S_{\text{FRESH-MIN}}) / \text{SHARE}_{\text{FRESH}} * \text{SHARE}_{\text{BRINE}} * \phi_{\text{BRINESTORAGE}}$$

As can be seen the reduction in the demand for available content in the brine storage depends on the actual content in the fresh water storage. Consequently the requirements for the brine storage cannot be defined on beforehand as for the fresh water storage. However the following equation can be defined and used in the calculations below:

$$S_{\text{BRINE-MAX}} = S_{\text{BRINE}} - w_{\text{BRINE-MIN}} * \phi_{\text{BRINESTORAGE}} + C_{\text{TURBINE}} - (S_{\text{FRESH}} - S_{\text{FRESH-MIN}}) / \text{SHARE}_{\text{FRESH}} * \text{SHARE}_{\text{BRINE}} * \phi_{\text{BRINESTORAGE}}$$

All values except the actual content in the fresh water storage (S_{FRESH}) are known beforehand.

In the energy systems analysis on the complete energy system the desalination plant is included in the following steps:

A.

First the hourly electricity demand of the fresh water pump, the desalination plant and the electricity production of the turbine (as calculated above) is included as input to the general energy system analysis of rest of the energy system. Based on this, the resulting hourly excess electricity production (e_{EXCESS}) is calculated as well as an hourly production on power alone condensing units in the system (e_{PP}).

B.

If there is excess production in a given hour ($e_{\text{EXCESS}} > 0$) then the system will try to eliminate the excess production in the following sequence:

1. Reduction of turbine production due to available capacity in the brine storage. (If the user has chosen that no brine should be wasted, then the production from the turbine cannot be below the level in which the content in the brine storage comes above the maximum value as calculated by the formula mentioned above under initial calculations) NOT implemented YET
2. Increase production on the desalination unit due to available capacity of the desalination plant as well as available capacity in both the fresh water storage and the brine storage.
3. Start the pump due to available capacity in the brine storage.

C.

If there is production on the power alone units in a given hour ($e_{\text{PP}} > 0$) then the system will try to eliminate some production in the following sequence:

1. Increase the turbine production due to available capacity of the turbine as well as brine.
2. Decrease production on the desalination plant, however not below the production which will secure the necessary content in the fresh water storage for the next hour.

Sequence B and C will be repeated once to secure the same content in the storages at the beginning of the year as by the end of the year.

On the results printout, the values are incorporated as follows:

- The electricity demand of the desalination plant is added to "Flex & Transp."
- The electricity demand for the fresh water pump and the hydro power pump is added to "Hydro Pump".
- The electricity production from the turbine is added to "Turbine".

7. Market-Economic Simulation

If market-economic simulation is chosen, the following simulation procedure is used. The model distinguishes between business economy (including taxes) and socio-economy (NOT including taxes). Basically, the model identifies the least-cost solution of the system, assuming an electricity market on which all plant operators seek to optimise their business-economic profit.

7.1. Net import and resulting external market price

The market-economic modelling is based on the identification of the market price at each hour resulting from the demand and supply of electricity. Moreover, the exact production of the various units in which the resulting market price becomes equal to the marginal production price is identified. Similar balance prices are found for electricity-consuming units such as heat pumps and electrolyzers.

Consequently, the following types of calculations are done continuously as an integrated part of each of the following sequences (sections 7.2-7.9) in the market-economic simulation procedure.

7.1.1. Calculating the resulting market price

First, the net import is identified as the difference between the electricity demand, d_{Total} , and the supply, e_{Total} :

$$d_{Net-Import} = d_{Total} - e_{Total}$$

$$d_{Total} = d_E + d_{EX} + d_{FX} + d_{Cool} + d_{Biogas} + d_{GASl} + d_{BioPetrol} + d_{BioDiesel} + d_{Elc} + d_{BEV} + d_{V2G} \\ + d_{I-HP-total} + d_{I-EH} + d_{HP2} + d_{HP3} + d_{Pump} + d_{HydroPump} + d_{SteamStorage}$$

$$\text{in which } d_{FX} = d_{FXDay} + d_{FXWeek} + d_{FX4Week}$$

$$\text{and } d_{Elc} = d_{Elc2} + d_{Elc3} + d_{ElcT} + d_{ElcM}$$

$$e_{Total} = e_{PP} + e_{RES} + e_{M-CHP} + e_{Hydro} + e_{Nuclear} + e_{Geothermal} + e_{V2G} + e_W + e_{CSHP} + e_{CHP2} + e_{CHP3} + e_{CHP3-MIN} + e_{Turbine} \\ + e_{CSP}$$

$$\text{in which } e_{RES} = e_{RES1} + e_{RES2} + e_{RES3} + \dots + e_{RES7}$$

$$\text{and } e_{M-CHP} = e_{M-h2CHP} + e_{M-NgasCHP} + e_{M-BioCHP}$$

In the calculation of the net import, the production from CHP3 is divided into e_{CHP3} and $e_{CHP3-Min}$ as explained in section 7.3 below.

The market price on the external market, p_x , is now found as follows:

$$p_x = p_i + (p_i / p_o) * \text{Fac}_{depend} * d_{Net-Import}$$

where p_i is the system market price (se e_{pend} is the price elasticity (DKK/MWh/MW)
 p_o is the basic price level for price elasticity (input),
 $d_{Net-Import}$ is the trade on the market.

Import is calculated as positive and export is negative, resulting in an increase in the market price in the case of import and a decrease in the case of export.

7.1.2. Calculating the balance production

The balance production from a certain unit in which the resulting market price becomes equal to the marginal production price is identified as an integrated part of the procedure. Here, such calculation is illustrated by the example of the geothermal power plant.

First, the net-import, $d_{\text{Net-Import}}$, is calculated as well as the market price, p_x , as described above in section 7.1.1, when the electricity production of the geothermal power plant is zero.

Then, the balance production is calculated as follows:

$$\text{BalanceProduction}_{\text{Geothermal}} = - [(\text{VEEP}_{\text{Geothermal}} - p_x) / (\text{Fac}_{\text{depend}} * p_x / p_o) - d_{\text{Net-Import}}]$$

where $\text{VEEP}_{\text{Geothermal}}$ is the marginal production cost of geothermal power production
 p_x is the market price before geothermal production (see section 7.1.1),
 $\text{Fac}_{\text{depend}}$ is the price elasticity (DKK/MWh/MW)
 p_o is the basic price level for price elasticity (input),
 $d_{\text{Net-Import}}$ is the trade on the market before geothermal production

The formula is typically subject to the limitations on power plant capacity.

Using the ‘Transmission capacity’s effect on system price’ in ‘Simulation’ it is possible to choose whether the transmission line capacity should limit $d_{\text{Net-Import}}$ or not. If EnergyPLAN is set to ‘Transmission capacity limits the effect on the system price’, then $d_{\text{Net-Import}}$ will be limited to the transmission line capacity of the system, in absolute values. If EnergyPLAN is set to “Transmission capacity does not limit the effect on the system price”, then the transmission line capacity does not limit $d_{\text{Net-Import}}$.

7.2. The overall procedure

The simulation is done in the following steps:

Step 1: Electricity Market Definition

The electricity market is defined by the inputs in the ‘Cost->External Electricity Market’ tab sheet, as described in section 4.4.2. The fluctuations of the market prices are presented as an hourly distribution file. One can change such prices by adding or multiplying figures, as described in section 4.4.2. The influence of import/export on the external market prices is given in terms of a dependence factor (price elasticity and a basic price level for the price elasticity).

When the business-economic best operation strategy is identified for each plant in the following, the influence on the market price is taken into consideration.

Step 2: Identifying marginal production (and consumption) costs

All marginal production costs are calculated on the basis of fuel costs, taxes, CO₂ costs and variable operational costs, as described in section 4.4. For units connected to district heating plants (such as CHP and heat pumps), power stations and individual micro CHP, marginal costs are given in DKK/MWh of electricity production/consumption. For storage units such as hydrogen CHP and pump storage systems, marginal costs are given according to a multiplication factor together with an addition factor. Basically, the simulation criterion is the following:

$$p_{\text{sell}} > p_{\text{buy}} * f_{\text{MUL}} + f_{\text{ADD}}$$

In which

- p_{sell} is the market electricity price when selling (DKK/MWh)
- p_{buy} is the market electricity price when buying (DKK/MWh)
- f_{MUL} is the multiplication factor (always higher than 1), and
- f_{ADD} is the addition factor (DKK/MWh)

Step 3: Starting point electricity market prices

As a starting point for the simulation, the electricity system prices are calculated on the basis of:

- the electricity demand including flexible demand (calculated as described in section 6.3)
- the production from RES (Wind power, PV etc.)

The production from RES is potentially affected by the “RES influence on system electricity price” setting, which has two options:

- “Zero bidding price (RES can stop)”: When using this option, the Variable Renewable Electricity sources’ production will be curtailed at negative system electricity market prices. The Variable Renewable Electricity sources are curtailed starting with the top listed.
- “Negative bidding prices (RES cannot stop)”: When using this option, the Variable Renewable Electricity sources’ production will not be curtailed due to negative electricity market prices.

As a starting point, all district heating is defined as supplied by boilers.

The sequence of optimising the individual plants is then identified by the subsequent procedure.

Step 4: Optimising the buying of given hydrogen and electricity demands

The least-costs solutions of buying the minimum amount of electricity needed to meet the following demands are identified, given the market price fluctuations and limitations on storage capacities, etc.:

- for producing hydrogen for transport
- for charging electric vehicles
- for producing hydrogen for micro CHP systems

When identifying the least-cost solution for the hydrogen micro CHP systems, the option of producing heat on a boiler using less hydrogen than the CHP unit is considered in situations of high electricity prices.

In the case of smart charge EV and V2G (Vehicle to Grid) possibilities, the optimal business-economic solutions of buying and selling are found on the basis of the multiplication and addition factors identified in the Cost Operation tab sheet (see section 4.4).

Step 5: Optimising electricity consumption options

The following electricity-consuming options are sorted according to marginal consumption costs:

- replacing boiler with heat pumps in district heating group 2
- replacing boiler with heat pumps in district heating group 3
- replacing boiler with electrolysers in district heating group 2
- replacing boiler with electrolysers in district heating group 3
- replacing electric heating with heat pumps in individual houses
- replacing boiler with electric boiler in district heating group 2
- replacing boiler with electric boiler in district heating group 3
- producing steam for high temperature thermal storage if the electricity price is lower than the cost of fuel for PP and CHP3 taking efficiencies into account.

Each option is then optimised according to market electricity prices, starting with the option with the highest marginal costs and taking into consideration the fact that each change in consumption influences the market price (increases the price).

Step 6: Optimising hydro power and CSP (Concentrated Solar Power)

Then, the best business-economic production from CSP is identified taking into consideration limitations on storage and generator capacities. And a similar calculation is done for hydro power.

In the case of pump possibilities, the optimal business-economic solution of buying and selling is identified on the basis of the multiplication and addition factors identified in the Cost Operation tab sheet (see section 4.4).

Step 7: Optimising electricity production options

The following electricity production options are then sorted according to the lowest marginal costs of production:

- Nuclear
- Geothermal
- Condensing Power plants
- Individual Ngas CHP
- Individual biomass CHP
- CHP replacing boilers in gr.2
- CHP replacing boilers in gr.3
- CHP replacing heat pumps in gr. 2
- CHP replacing heat pumps in gr. 3
- CHP replacing electrolysers in gr. 2
- CHP replacing electrolysers in gr. 3

Each option is then optimised according to market electricity prices, starting with the option with the lowest marginal costs and taking into consideration the fact that each change in consumption influences the market price (decreases the market price).

Limitations on transmission lines are taken into consideration by setting a limit on the production of each unit so that the total export will not exceed the transmission capacity (if possible).

Limitations on import are calculated with regard to the condensing power plants, which will simply be activated in the case that the import transmission capacity is exceeded.

Step 8: Optimising electricity storage (Hydro or battery or CAES storage)

The optimal business-economic solution of buying and selling is identified on the basis of the above-mentioned multiplication and addition factors.

Step 9: Steps 3 to 8 are repeated

In order to calculate the impact on the simulation of the consumption units after the market price is influenced by the production options, the procedure from steps 3 to 8 is repeated.

Step 10: Critical Excess Production

Any critical excess production is removed following the usual technical simulation procedure of EnergyPLAN (see chapter 8).

7.3. CHP3 minimum production

If a minimum CHP production in district heating group 3 is specified as input in the 'Balancing & Storage -> Electricity' tab sheet (see section 4.4.2), then such minimum capacity is treated separately from the rest of the CHP production.

In the beginning of the simulation procedure, the electricity production, $e_{\text{CHP3-MIN}}$, is set as equal to the CHP3 minimum capacity, $C_{\text{CHP3-MIN}}$, and the heat production is calculated accordingly. However, if the heat production at one hour exceeds the difference between the district heating demand and the solar thermal and industrial and waste heat productions, then the heat production is reduced accordingly.

$$e_{\text{CHP3-Min}} = C_{\text{CHP3-Min}}$$

$$q_{\text{CHP3-Min}} = e_{\text{CHP3-Min}} * \rho_{\text{CHP3}} / \mu_{\text{CHP3}}$$

$$\text{If } q_{\text{CHP3-Min}} > d_{\text{DH3}} - q_{\text{Solar3}} - q_{\text{W3}} - q_{\text{Industry-DH3}} \text{ then } q_{\text{CHP3-Min}} = d_{\text{DH3}} - q_{\text{Solar3}} - q_{\text{W3}} - q_{\text{Industry-DH3}}$$

The CHP3 capacity is then decreased by the minimum capacity when the simulation procedure of section 7.8 is completed. In the end (after sections 7.4 to 7.9), the two sets of productions are combined in one resulting CHP3 electricity and heat production.

7.4. District heating supplied by solar thermal and boilers

As a starting point in each of the district heating groups 2 and 3, the boilers are defined to supply all heating after solar thermal production and industrial and waste heat:

$$q_B = h_{DH} - q_{Solar} - q_W - q_{CSHP}$$

7.5. Hydrogen and electricity demands for transport and micro CHP

Least-cost solutions of buying the minimum amount of electricity required to meet the following demands are identified given the market price fluctuations and limitations on storage capacities, etc.

- for producing hydrogen for transport
- for charging electric vehicles
- for producing hydrogen for micro CHP systems

7.5.1. Hydrogen for transport

The model seeks to minimise the business-economic costs of buying electricity to meet the specified hydrogen demand for transport.

First, the annual electricity demand, $D_{Transport-H2}$, is calculated on the basis of the annual hydrogen demand, $F_{Transport-H2}$, (specified in the Input Transport tab sheet, section 4.1.5) and the electrolyser efficiency, α_{EICT} , (specified in the Input Storage tab sheet, section 4.3):

$$D_{Transport-H2} = F_{Transport-H2} / \alpha_{EICT}$$

The minimum number of electrolyser production hours, $h-MIN_{EICT}$, is calculated as the demand divided by the capacity of the electrolyser:

$$h-MIN_{EICT} = \text{round} (D_{Transport-H2} / C_{EICT})$$

Then, the market price (at the present stage of the procedure, i.e., in the beginning with no productions) is identified, as described in section 7.1. Based on these prices, the model identifies the hours of least-cost production, i.e., the hours up to $h-MIN_{EICT}$ with the lowest market prices. The model identifies the maximum buying price, $p_{EICT-MAX}$, if all production hours are placed at times with the lowest possible market prices.

The model now includes the limitations on the hydrogen storage. Basically the electrolysers produce whenever the market price, p_x , is below $p_{EICT-MAX}$:

$$\text{If } p_x < p_{EICT-MAX} \text{ then } e_{EICT} = C_{EICT} \text{ else } e_{EICT} = 0$$

Then, the hydrogen storage content of hour x , $S_{EICT}(x)$, is calculated:

$$S_{EICT}(x) = S_{EICT}(x-1) + e_{EICT} * \alpha_{EICT} - f_{Transport-H2}$$

If the storage content at hour x becomes negative, the model looks back from hour x to the latest hour at which the storage was full, and identifies and activates the available hour of production with the

lowest market price. Such procedure is repeated until the storage content at hour x is no longer negative.

On the other hand, if the storage content at hour x exceeds the capacity of the storage, the model looks back from hour x to the latest hour at which the storage was empty, and identifies and deletes the hour of production with the highest market price. Again, such procedure is repeated until the storage content at hour x no longer exceeds the capacity.

Due to differences in the storage content between the beginning and the end of the calculation period, errors may appear in the calculations. In order to correct these errors, the above calculation is repeated until the storage content at the end is the same as at the beginning.

7.5.2. Electricity demand for transport (BEV and V2G)

In the input, electricity for transport is divided into three options. The one is specifying a fixed electricity demand. Such demand is included in the demand, as shown in section 7.1.1. The two other options are smart charge BEV and V2G. In both cases, the model seeks to minimise the business-economic costs of buying electricity in order to meet the annual demands. Moreover, in the V2G case, the model seeks to optimise the business-economic profit from buying and selling electricity to the grid.

When optimising smart charge or V2G, one can (in the simulation tab sheet) choose between 3 options:

- V2G simulation 1 (No limitations). In this situation, the V2G will try to optimise profits given the external market prices (including the influence from buying and selling from the V2G itself) without any limits with regard to grid or transmission capacities, as described in the following. Such optimisation of profits may, however, lead to severe power plant and grid capacity problems and bottlenecks and may cause problems to the system. Therefore, one has the option of setting a limit on the charging of smart charge and V2Gs.
- V2G simulation 2 (Limitation: Smart Charge/V2G charge \leq PowerPlant-cap + import-max - electricity demand). In this case, charging is limited to the sum of power plant (PP) and transmission line capacities minus electricity demands.
- V2G simulation 3 (Seeks to minimise PP max). In this case, the smart charge or V2G will try to charge and discharge in order to minimise the use of power plants.

The starting point for the simulation is the hourly calculation of the electricity demand (from the grid), d_{V2G} ; the transport demand (from the battery), t_{V2G} , and the charging and discharging capacity, c_{V2G} , calculated as described in section 6.9. Please, note that, due to the fact that not all vehicles are connected at the same time, the charging capacity changes from one hour to another.

Minimising cost

For the two first simulation strategies, the modelling starts by assuming infinite battery storage capacity and identify by iteration the maximum price of buying, $P_{\max\text{-buy}}$, when the difference between charging and discharging fulfils the electricity demand for transport.

The iteration is done as follows:

First, a $P_{\max\text{-buy}}$ value is assumed.

If the system price is below $P_{\max\text{-buy}}$, the maximum charging, which will still leave the system price below $P_{\max\text{-buy}}$, is identified, as described in section 7.1.2. Such charging is then activated taking into account limitations on charging capacity and, in the case of V2G simulations strategy 2, also the limitations on power plant and transmission line capacities.

Then, the minimum selling price which will provide a profit is identified as:

$$P_{\text{Min-sell}} > P_{\text{Max-Buy}} * f_{\text{MUL-V2G}} + f_{\text{ADD-V2G}}$$

If the system price is above $P_{\text{Min-sell}}$, the maximum discharging, which will still leave the system price above $P_{\text{min-sell}}$, is identified, as described in section 7.1.2. Such charging is then activated taking into account limitations on discharging capacity.

After completing the calculation of the whole year, the annual charging and discharging values are compared to the electricity transport demand. The $P_{\max\text{-buy}}$ value is then changed gradually until a balance is found which constitutes the best business-economic profit, provided that the storage capacity is infinite.

Based on this $P_{\max\text{-buy}}$ value, the model takes into consideration the storage limitations in the following way:

The battery storage content of hour x , $s_{V2G}(x)$, is calculated:

$$s_{V2G}(x) = s_{V2G}(x-1) + d_{V2G} * \mu_{\text{Charger}} - t_{V2G} - e_{V2G} / \mu_{\text{Inv}}$$

If the battery storage content at hour x becomes negative, the model first decreases the discharging and then increases the charging until a balance is found.

On the other hand, if the storage content at hour x exceeds the capacity of the storage, the model simply decreases the charging until a balance is found.

Due to differences in the storage content between the beginning and the end of the calculation period, errors may appear in the calculations. In order to correct these errors, the above calculation is repeated until the storage content at the end is the same as at the beginning.

Minimising PP max

For the V2G simulation strategy 3, the modelling also starts by assuming infinite battery storage capacity. However, in this case, the model seeks to identify by iteration the PP production, PP_{\max} , by which the difference between charging (when PP is below PP_{\max}) and discharging (when PP is above PP_{\max}) fulfils the electricity demand for transport.

The iteration is done as follows:

First, a PP_{\max} value is assumed.

If PP is below PP_{\max} , the charging is set to the difference between PP and PP_{\max} plus critical excess production.

If PP is below PP_{max} , the discharging is set to the difference between PP and PP_{max} .

After completing the calculation of the whole year, the annual charging and discharging values are compared to the electricity transport demand. The PP_{max} value is then changed gradually until a balance is found which constitutes the best level of PP peak productions given an infinite battery.

Based on this PP_{max} value, the model takes into consideration the storage limitations in the same way as described above for the cost simulation.

Please, note that both of the strategies (minimising cost or PP max) assume that the users of V2G by learning experience are able to identify at which price level (of PP max) they should buy. However, they are not assumed to be able to look into the future with regard to variations in prices nor power plant productions.

7.5.3. Hydrogen for micro CHP

The model seeks to optimise the business-economic profit of buying electricity in order to meet the specified hydrogen demand for micro CHP and sell electricity from the CHP unit. In the model, the micro CHP system consists of a CHP unit and a boiler supplied only by hydrogen, and consequently, the annual hydrogen demand can vary by shifting from the CHP unit to the boiler and back again. Moreover, both hydrogen and heat storage can be specified, which provides for flexibility both regarding when to buy and when to sell electricity on the market.

Then, the model identifies hour by hour the least-cost operation of the CHP unit and the boiler, taking into account solar thermal and heat storage as well as hydrogen storage capacities, in the following way:

Priority is given to solar thermal production

Priority is given to solar thermal production. First, the model identifies the maximum solar thermal output given the heat demand and the heat storage capacity. As part of the calculation, the model identifies the share of the heat storage which is occupied by solar thermal as a result of such operation.

Boiler production is the starting point

Then, the minimum hydrogen demand, $f_{M-H2CHP-Total}$, and corresponding electrolyser electricity demand, e_{ElcM} , are found in the case when the heat demand is supplied by the boiler only after solar thermal production.

$$q_{M-H2CHP-Boiler} = h_{M-H2CHP} - q_{Solar-M-H2CHP}$$

$$f_{M-H2CHP-Total} = q_{M-H2CHP-Boiler} / \rho_{M-NgasCHP-Boiler}$$

$$e_{ElcM} = f_{M-H2CHP-Total} / \alpha_{ElcM}$$

The marginal price of producing additional hydrogen for the CHP unit is identified

For each hour x, the model looks back and forth and identifies a period starting with full hydrogen storage and ending with empty hydrogen storage. For such period, the model identifies the marginal least-cost hour of hydrogen production. Based on the market price at such hour y, p_{buy} , the minimum

selling price of the CHP unit which will provide a profit in hour x , p_{sell} , is calculated as the market price at hour y adjusted according to the multiplication and addition price factors defined in section 4.4, in terms of efficiencies and variable operational costs.

$$p_{sell} > p_{buy} * f_{MUL-M-H2CHP} + f_{ADD-M-H2CHP}$$

The CHP unit is activated if profitable and if allowed by the heat storage

The boiler production is set to zero and the minimum selling price of hour x determines whether the CHP unit should operate. The production is identified as the minimum value of either the CHP capacity or the production which will influence the market price to such extent that it will become equal to the minimum selling price.

$$\text{If } p_{sell} < p_x(x) \text{ then } e_{M-H2CHP} = C_{M-H2CHP} \text{ else } e_{M-H2CHP} = 0$$

If it is decided to operate the CHP unit, the heat storage content is identified:

$$S_{M-H2CHP}(x) = S_{M-H2CHP}(x-1) - h_{M-H2CHP} - q_{Solar-M-H2CHP} - q_{M-H2CHP}$$

If at hour x , the heat storage content exceeds the capacity, the model looks back from hour x to the latest hour at which the storage content (minus the share of the storage which is occupied by solar thermal) becomes lower than the CHP heat production, and identifies the hour y , which has the lowest market price. The production at hour y is decreased until the heat storage content at hour x does not exceed the capacity.

If, on the other hand, the heat storage at hour x becomes below zero, the boiler is activated.

Identifying minimum production costs of the electrolyser

Based on the optimal hydrogen demand, $F_{M-H2CHP-Total}$, identified above, the electrolysers are now optimised in the same way as the electrolysers for hydrogen production for transport. The annual electricity demand, D_{EicM} , is calculated on the basis of the annual hydrogen demand, $F_{M-H2CHP-Total}$, and the electrolysers' efficiency, α_{EicM} (specified in the Input Storage tab sheet, section 4.3):

$$D_{EicM} = F_{M-H2CHP-Total} / \alpha_{EicM}$$

The minimum number of electrolyser production hours, $h-MIN_{EicM}$, is calculated as the demand divided by the capacity of the electrolyser:

$$h-MIN_{EicM} = \text{round} (D_{EicM} / C_{EicM})$$

Then, the market price (at the present stage of the procedure, i.e., in the beginning with no productions) is identified, as described in section 7.1. On the basis of these prices, the model identifies the hours of least-cost production, i.e., the hours up to $h-MIN_{EicM}$ with the lowest market prices. The model also identifies the maximum price, $p_{EicT-MAX}$, of buying if all production takes place at the lowest possible market price.

Including hydrogen storage capacity limitations

The model now includes the limitations on the hydrogen storage in the same way as for the transport hydrogen production described in section 7.5.1.

7.6. Electricity consumption of heat pumps and DH electrolyzers

The following electricity-consuming options are sorted according to marginal costs:

- replacing boiler with heat pumps in district heating group 2
- replacing boiler with heat pumps in district heating group 3
- replacing boiler with electrolyzers in district heating group 2
- replacing boiler with electrolyzers in district heating group 3
- replacing electric heating with heat pumps in individual houses
- replacing boiler with electric boiler in district heating group 2
- replacing boiler with electric boiler in district heating group 3
- producing steam for high temperature thermal storage if the electricity price is lower than the cost of fuel for PP and CHP3 taking efficiencies into account.

Each option is then optimised according to market electricity prices, starting with the option with the highest marginal costs and taking into consideration the fact that each change in consumption influences the market price (increases the price).

7.6.1. Heat pumps in district heating groups 2 and 3

If the option of replacing boilers by heat pumps in district heating group 2 has the highest marginal cost, it is optimised according to market electricity prices in the following way:

First, the system price, p_x , is calculated and the balance production of the heat pump, $\text{BalanceProduction}_{\text{HP2}}$, is found as described in section 7.1.

Then, the balance production is limited by the capacity of the heat pump:

$$\text{If } \text{BalanceProduction}_{\text{HP2}} < 0 \text{ then } \text{BalanceProduction}_{\text{HP2}} = 0$$

$$\text{If } \text{BalanceProduction}_{\text{HP2}} > C_{\text{HP}} \text{ then } \text{BalanceProduction}_{\text{HP2}} = C_{\text{HP}}$$

And the corresponding thermal output is calculated:

$$q_{\text{HP2}} = \text{BalanceProduction}_{\text{HP2}} * \phi_{\text{HP2}}$$

If the corresponding heat production is lower than the boiler production, the boiler production is simply reduced accordingly:

$$\text{If } q_{\text{HP2}} < q_{\text{B2}} \text{ then } q_{\text{B2}} = q_{\text{B2}} - q_{\text{HP2}}$$

However, if the corresponding heat production is higher than the boiler heat production, the boiler production is set to zero and the heat storage is included in the calculation in the following way:

$$\text{If } q_{\text{HP2}} > q_{\text{B2}} \text{ then } S_{\text{DH2}} = S_{\text{DH2}} + (q_{\text{HP2}} - q_{\text{B2}}) \text{ and } q_{\text{B2}} = 0$$

If such increase in the storage content at hour x has the consequence that the content exceeds the storage capacity ($S_{DH} > S_{DH}$), the model looks back from hour x to the latest hour at which the storage was empty (lower than the heat production of the heat pump at hour x) and identifies the hour (y) at which the heat pump was producing at the highest market price. Such production at hour y represents the best alternative to decreasing productions in order to avoid overload at hour x .

The procedure is done in the same way for the heat pumps in district heating group 3.

7.6.2. Electrolysers replacing boilers in district heating groups 2 and 3

If the option of replacing boilers by electrolysers in district heating group 2 has the highest marginal cost, it is optimised according to market electricity prices in the following way:

First, the system price, p_x , is calculated and the balance production of the electrolyser, $\text{BalanceProduction}_{\text{Eic2}}$, is found as described in section 7.1.

Then, the balance production is limited by the capacity of the heat pump:

If $\text{BalanceProduction}_{\text{Eic2}} < 0$ **then** $\text{BalanceProduction}_{\text{Eic2}} = 0$

If $\text{BalanceProduction}_{\text{Eic2}} > C_{\text{Eic2}}$ **then** $\text{BalanceProduction}_{\text{Eic2}} = C_{\text{Eic2}}$

And the corresponding thermal output is calculated:

$$q_{\text{Eic2}} = \text{BalanceProduction}_{\text{Eic2}} * \rho_{\text{Eic}}$$

If the corresponding heat production is lower than the boiler production, the boiler production is simply reduced accordingly; and if it is higher, the electrolyser production is reduced:

If $q_{\text{Eic2}} < q_{\text{B2}}$ **then** $q_{\text{B2}} = q_{\text{B2}} - q_{\text{Eic2}}$

If $q_{\text{Eic2}} > q_{\text{B2}}$ **then** $q_{\text{Eic2}} = q_{\text{B2}}$ **and** $q_{\text{B2}} = 0$

Finally, the electricity consumption of the electrolyser is found as:

$$d_{\text{Eic2}} = q_{\text{Eic2}} / \rho_{\text{Eic2}}$$

The same procedure is followed in the case of the electrolysers in district heating group 3.

7.6.3. Heat pumps in individual households

If the option of heat pumps in individual households has the highest marginal cost, it is optimised according to market electricity prices in the following way:

Priority is given to solar thermal production. If solar thermal production exceeds the heat demand, priority is given to the excess production in the heat storage. Consequently, the model first calculates the maximum share of the solar thermal production which can be utilised, given the distributions of heat demand and solar thermal production and given the capacity of the heat storage.

Then, the system price, p_x , is calculated and the balance production of the heat pump, $\text{BalanceProduction}_{M-HP}$, is found, as described in section 7.1.

The balance production is limited by the capacity of the heat pump:

If $\text{BalanceProduction}_{I-HP} < 0$ **then** $\text{BalanceProduction}_{I-HP} = 0$

If $\text{BalanceProduction}_{I-HP} > C_{I-HP}$ **then** $\text{BalanceProduction}_{I-HP} = C_{I-HP}$

The corresponding thermal output is calculated:

$$q_{I-HP} = \text{BalanceProduction}_{I-HP} * \phi_{I-HP}$$

Now the heat storage content at hour x is calculated as

$$S_{I-HP}(x) = S_{I-HP}(x-1) + q_{I-HP} + q_{I-HP-Solar} - h_{I-HP}$$

If the storage content goes below zero, the electric heating boiler is started:

If $S_{I-HP} < 0$ **then** $q_{I-HP-Boiler} = -S_{I-HP}$

If the storage content at hour x exceeds the storage capacity ($S_{DH} > S_{DH}$), the model looks back from hour x to the latest hour at which the storage was empty (lower than the heat production of the heat pump at hour x) and identifies the hour (y) at which the heat pump was producing at the highest market price. Such production at hour y represents the best alternative to decreasing productions in order to avoid overload at hour x.

7.6.4. Electric Boilers in district heating groups 2 and 3

If the option of replacing boilers by electric boilers in district heating group 2 has the highest marginal cost, it is optimised according to market electricity prices in the following way:

First, the system price, p_x , is calculated and the balance production of the electric boiler, $\text{BalanceProduction}_{EP2}$, is found as described in section 7.1.

Then, the balance production is limited by the capacity of the electric boiler:

If $\text{BalanceProduction}_{EP2} < 0$ **then** $\text{BalanceProduction}_{EP2} = 0$

If $\text{BalanceProduction}_{EP2} > C_{EP2}$ **then** $\text{BalanceProduction}_{EP2} = C_{EP2}$

And the corresponding thermal output is calculated:

$$Q_{EP2} = \text{BalanceProduction}_{EP2}$$

If the corresponding heat production is lower than the boiler production, the boiler production is simply reduced accordingly:

If $q_{EP2} < q_{B2}$ **then** $q_{B2} = q_{B2} - q_{EP2}$

However, if the corresponding heat production is higher than the boiler heat production, the electric boiler heat production is reduced accordingly:

$$\text{If } q_{EP2} > q_{B2} \text{ then } q_{EP2} = q_{B2} \text{ and } q_{B2} = 0$$

The procedure is done in the same way for the electric boilers in district heating group 3.

7.6.5. Electricity consumption for steam to High Temperature Thermal storage.

If the option of producing steam has the highest marginal cost, it is optimised according to market electricity prices in the following steps:

Step 1: An initial storage content is defined as 50% of the capacity.

Step 2: The potential of using steam to replace fuel in PP is calculated as:

$$PP_{\text{Steam}} = ((e_{PP} / \mu_{pp}) / \mu_{\text{SteamStorage}}) * \text{SteamStorage}_{\text{share}}$$

- In which $\text{SteamStorage}_{\text{share}}$ represents the share of PP/CHP3 in the system, which has access to steam storage, and $\mu_{\text{SteamStorage}}$ is the steam/fuel ration, i.e. how much fuel the steam replaces.

The PP_{Steam} value is then adjusted with regard to the limits of the storage content and the discharging capacity of the steam storage.

Step 3: Same procedure is calculated for the CHP3 units.

Step 4: The system price, p_x , is calculated and the balance production of the electricity for steam input is found similarly to the previous calculations in section 7.6.

Then, the balance production is limited by the capacity of the steam charging and the available CEEP.

Step 5: The storage content after the hour is calculated as the content in the beginning of the hour plus the charging from CEEP minus the discharging for PP and CHP3.

Step 6: The losses are calculated as the storage content multiplied by the loss (in share per hour).

Step 7: The content of the storage by the end of the year is identified, and used as new initial storage content before steps 2-6 are repeated. In this way the net-input from the storage becomes zero on an annual basis.

7.7. Hydro Power

7.7.1. Hydro Power

The best business-economic production from hydro power is identified taking into consideration limitations on storage and generator capacities. In the case of pump capacities, the optimal business-

economic solution of buying and selling is found on the basis of the multiplication and addition factors identified in the Cost Operation tab sheet (see section 4.4). The simulation is done in the following way:

First, the maximum potential hydro power production, E_{Hydro} , is calculated, as described in section 4.2.2.3, taking into account the distribution of the water supply, the limitations on the water storage and the capacity of the hydro power generator.

Based on this maximum hydro power production, the model identifies a suitable content of the water storage to have in the start of the year, i.e. a storage content which makes it technically possible to utilize all the potential hydro power.

Next, the model identifies the electricity market prices without any hydropower production including the maximum price of the year. And on the basis of the difference between the maximum and the minimum price of the year is calculated a suitable delta-price for the following iteration.

Now the model sets a target price and calculate the following three steps. In the beginning the target price is set high, i.e. the maximum price minus the delta price.

Step 1: The Hydro power plant will produce and sell electricity as long as the resulting selling price on the market is higher than or equal to the target price.

Step 2: The Pump is active if the market price is so low that it will make a profit assuming that the electricity can afterwards be sold to the target price.

The maximum pumping/buying price, p_{Buy} , which will provide a profit, is calculated as the market price at the given hour adjusted for the multiplication and addition price factors found in section 4.4, which adjust for efficiencies and variable pump and turbine costs.

$$P_{Sell} > p_{Buy} * f_{MUL-HydroPump} + f_{ADD-HydroPump}$$

The minimum selling price is then compared to the target price, and if the market price is higher, then the hydro power pump, $d_{Hydro-Pump}$, is activated:

$$\text{If } p_{Sell} < p_x(x) \text{ then } d_{HydroPump} = C_{HydroPump} \text{ else } d_{HydroPump} = 0$$

Step 3: Now the hydrogen storage content of hour x , $S_{Hydro}(x)$, is calculated:

$$S_{Hydro}(x) = S_{Hydro}(x-1) + W_{Hydro} - e_{Hydro} / \mu_{Hydro} + d_{HydroPump} * \alpha_{HydroPump}$$

If the storage content at hour x becomes negative, the hydro power production is reduced accordingly. If the storage content exceed the capacity the pump is reduced if any or the exceeding water is lost.

After running through these three steps of the whole year the resulting content of the storage is compared to the content defined in the beginning. If the storage content is higher the target price will be reduced and the steps are repeated until a balance is achieved.

7.7.2. Concentrated Solar Power (CSP)

The best business-economic production from CSP is identified taking into consideration limitations on storage and generator capacities. The simulation is done in the following way:

First, the initial storage content is defined as zero.

Next, the model identifies the electricity market prices without any CSP production including the maximum price of the year. On the basis of the difference between the maximum and the minimum price of the year, a suitable delta price for the following iteration is calculated.

Now the model sets a target price and calculates the following three steps. In the beginning, the target price is set high, i.e. the maximum price minus the delta price.

Step 1: The CSP plant will produce and sell electricity as long as the resulting selling price on the market is higher than or equal to the target price.

Step 2: The storage content of hour x , $S_{\text{Hydro}}(x)$, is calculated:

$$S_{\text{CSP}}(x) = S_{\text{CSP}}(x-1) + \text{Solar}_{\text{CSP}} - e_{\text{CSP}} / \mu_{\text{CSP}}$$

If the storage content at hour x becomes negative, the CSP production is reduced accordingly.

If the storage content at one hour x exceeds the storage capacity, the model will go back to the previous hour of full storage capacity and lower the target price and proceed from this hour. This procedure will be repeated until all CSP is sold on the market and there is no excess storage content.

Following this procedure assures that the CSP plant optimises the income on the electricity market.

7.8. Electricity production from CHP and power plants

The following electricity production options are sorted according to marginal production costs:

- Nuclear
- Geothermal
- Condensing Power plants
- Individual Ngas CHP
- Individual biomass CHP
- CHP replacing boilers in gr.2
- CHP replacing boilers in gr.3
- CHP replacing heat pumps in gr. 2
- CHP replacing heat pumps in gr. 3
- CHP replacing electrolysers in gr. 2
- CHP replacing electrolysers in gr. 3

Each option is then optimised according to market electricity prices, starting with the option with the lowest marginal costs and taking into consideration the fact that each change in consumption influences the market price (decreases the market price).

Limitations on transmission lines are taken into consideration by setting a limit on the production of each unit so that the total export does not exceed the transmission capacity (if possible).

Limitations on import are calculated with regard to the condensing power plants, which will simply be activated in the case that the import transmission capacity is exceeded.

7.8.1. Nuclear

Nuclear power is optimised in the following way: If the market price goes below the marginal production costs, the production is reduced.

The simulation takes its starting point in the simple calculations described in section 4.2.2.2 in which the production is simply determined by the capacity and the hourly distribution.

Then, the system price, p_x , is calculated and the balance production of the nuclear power plant, $\text{BalanceProduction}_{\text{Nuclear}}$, is found as described in section 7.1.

If the balance production price is lower than the production found in section 4.2.2.2, the production is reduced accordingly.

7.8.2. Geothermal

Geothermal power is calculated in the same way as nuclear power.

7.8.3. Condensing power plants

Condensing power production is optimised simply by identifying the system price, p_x , and the balance production of the condensing power plant, $\text{BalanceProduction}_{\text{pp}}$, as described in section 7.1.

$$e_{\text{pp}} = \text{BalanceProduction}_{\text{pp}}$$

The production is adjusted to the limit of zero and the power plant capacity, C_{pp} . If the net import or export exceeds the transmission line capacity, the condensing power production is adjusted accordingly. In such case, the domestic and the external markets are separated and the marginal production cost on the condensing power plant determines the market price on the domestic electricity market.

7.8.4. Individual natural gas and biomass CHP

The individual natural gas and biomass CHP systems each consist of heat storage and three production units: Solar thermal, CHP and a peak load boiler. The peak load boiler is assumed to have the same thermal efficiency as the natural gas or the biomass boiler of the individual boiler systems.

First priority is given to solar thermal, and the model first identifies the maximum solar thermal output given the heat demand and the heat storage capacity. As part of the calculation, the model identifies the share of the heat storage which is occupied by solar thermal as a result of such operation.

The model now identifies the system price, p_x , and the balance production of the CHP system, $\text{BalanceProduction}_{\text{M-NgasCHP}}$, as described in section 7.1. The electricity production of the CHP unit is

identified as the minimum of either the CHP capacity or the balance production which will influence the market price to such extent that it becomes equal to the minimum selling price.

$$e_{M-NgasCHP} = \text{Min} (C_{M-NgasCHP}, \text{BalanceProduction}_{M-NgasCHP})$$

The heat storage content at hour x is calculated:

$$S_{M-NgasCHP}(x) = S_{M-NgasCHP}(x-1) - h_{M-NgasCHP} - q_{Solar-M-NgasCHP} - Q_{M-NgasCHP}$$

If the heat storage content exceeds the capacity at hour x , the model looks back from hour x to the latest hour at which the storage content (minus the share of the storage, which is occupied by solar thermal) becomes lower than the CHP heat production, and identifies the hour (y) which has the lowest market price. The production at hour y is then decreased until the heat storage content at hour x does not exceed the capacity.

If, on the other hand, the heat storage at hour x goes below zero, the boiler is activated.

Here, the simulation procedure is shown for the natural gas CHP system. The same procedure is applied to the biomass CHP system.

7.8.5. CHP replacing boilers in gr. 2 and 3

CHP replacing boilers in district heating groups 2 and 3 is optimised by identifying the system price, p_x , and the balance production of the CHP plant, $\text{BalanceProduction}_{CHP-B}$, as described in section 7.1. The balance production is added to the former production (if any) arising from CHP replacing either heat pumps or electrolysers, as described in sections 7.8.6 and 7.8.7 below.

$$e_{CHP} = e_{CHP} + \text{BalanceProduction}_{CHP-B}$$

The production is adjusted to the limit of zero and the capacity, C_{CHP} . If the net import or export exceeds the transmission line capacity, the electricity production is adjusted accordingly in the same way as for the condensing power plant.

Then, the heat storage is included in the calculation in the following way:

First, the corresponding heat production is found and the boiler production is defined as zero:

$$q_{CHP} = e_{CHP} * \rho_{CHP} / \mu_{CHP}$$

$$q_B = 0$$

Then, the heat storage content, s_{DH} , at hour x is calculated:

$$S_{DH}(x) = S_{DH}(x-1) - h_{DH} + q_{Solar} + q_{Industry-DH} + q_W + q_{HP} + q_{Elc} + q_{CHP} + q_B$$

Please, note that the solar thermal production is stored in its own low-temperature heat storage. The solar thermal production included above is the resulting output from the solar thermal and the low-temperature heat storage, which is included in the calculations together with the district heating demand in order to determine the net input/output to the high-temperature storage.

If the content of the heat storage at hour x becomes negative, the boiler is activated:

$$\text{If } S_{DH} < 0 \text{ then } q_B = -S_{DH}$$

If the content of the heat storage at hour x exceeds the heat storage capacity, S_{DH} , the model looks back from hour x to the latest hour at which the storage content is lower than the CHP heat production and identifies the hour (y) which has the lowest market price. The production at hour y is then decreased until the heat storage content at hour x does not exceed the capacity.

The same procedure is used for each of the CHP units in district heating groups 2 and 3.

7.8.6. CHP replacing heat pumps in gr. 2 and 3

CHP replacing heat pumps in district heating groups 2 and 3 is optimised by identifying the system price, p_x , and the balance production of the CHP plant, $\text{BalanceProduction}_{\text{CHP-HP}}$, as described in section 7.1. The balance production is added to the former production (if any) arising from CHP replacing either boilers or electrolysers, as described in sections 7.8.5 and 7.8.7.

$$e_{\text{CHP}} = e_{\text{CHP}} + \text{BalanceProduction}_{\text{CHP-HP}}$$

The production is adjusted to the limit of zero and the capacity, C_{CHP} . If the net import or export exceeds the transmission line capacity, the electricity production is adjusted accordingly in the same way as for the condensing power plant.

Then, the corresponding heat production, q_{DIFF} , which will replace the heat pump, is found:

$$q_{\text{DIFF}} = \text{BalanceProduction}_{\text{CHP-HP}} * \rho_{\text{CHP}} / \mu_{\text{CHP}}$$

If such production exceeds the heat pump heat production, it is adjusted accordingly:

$$\text{If } q_{\text{DIFF}} > q_{\text{HP}} \text{ then } q_{\text{DIFF}} = q_{\text{HP}}$$

Thereafter, the productions of the heat pump and the CHP unit are adjusted accordingly:

$$q_{\text{CHP}} = q_{\text{CHP}} + q_{\text{DIFF}}$$

$$q_{\text{HP}} = q_{\text{HP}} - q_{\text{DIFF}}$$

The heat storage is not included in the calculation since the heat production is the same. Heat pump production is just replaced by CHP.

The same procedure is used for each of the CHP units in district heating groups 2 and 3.

7.8.7. CHP replacing electrolysers in gr. 2 and 3

CHP replacing electrolysers in district heating groups 2 and 3 is optimised by identifying the system price, p_x , and the balance production of the CHP plant, $\text{BalanceProduction}_{\text{CHP-EL}}$, as described in section

7.1. The balance production is added to the former production (if any) arising from CHP replacing either boilers or heat pumps, as described in sections 7.8.5 and 7.8.6.

$$e_{\text{CHP}} = e_{\text{CHP}} + \text{BalanceProduction}_{\text{CHP-Elc}}$$

The production is adjusted to the limit of zero and the capacity, C_{CHP} . If the net import or export exceeds the transmission line capacity, the electricity production is adjusted accordingly in the same way as for the condensing power plant.

Then, the corresponding heat production, q_{DIFF} , which will replace the electrolyser is found:

$$q_{\text{DIFF}} = \text{BalanceProduction}_{\text{CHP-Elc}} * \rho_{\text{CHP}} / \mu_{\text{CHP}}$$

If such production exceeds the electrolyser heat production, it is adjusted accordingly:

$$\text{If } q_{\text{DIFF}} > q_{\text{Elc}} \text{ then } q_{\text{DIFF}} = q_{\text{Elc}}$$

Thereafter, the productions of the electrolyser and the CHP unit are adjusted accordingly:

$$q_{\text{CHP}} = q_{\text{CHP}} + q_{\text{DIFF}}$$

$$q_{\text{Elc}} = q_{\text{Elc}} - q_{\text{DIFF}}$$

The heat storage is not included in the calculation, since the heat production is the same. Electrolyser production is just replaced by CHP.

The same procedure is used for each of the CHP units in district heating groups 2 and 3.

7.9. Electricity storage (hydro or battery or CAES storage)

The model seeks to identify a realistic business-economic strategy for optimising the net profit of buying and selling electricity on the basis of fluctuations in the market price and the variable operation including fuel costs in the case of CAES. The strategy is described in section 10 as simulation strategy no. 4.

The strategy is based on a concept which bids on the market according to the average price, p_{Average} , of an upcoming user-specified period (of y hours). The average price is found as:

$$p_{\text{Average}}(x) = \frac{\sum_{i=x}^{i=x+y} p(i)}{y}$$

The bid on the market occurs in such way that the price difference between the buying and bidding prices is equally distributed around the average price. Figure 7.1 demonstrates this concept for a 24-hour period. The centre line represents the price average, p_{Average} , for the shown 24-hour period.

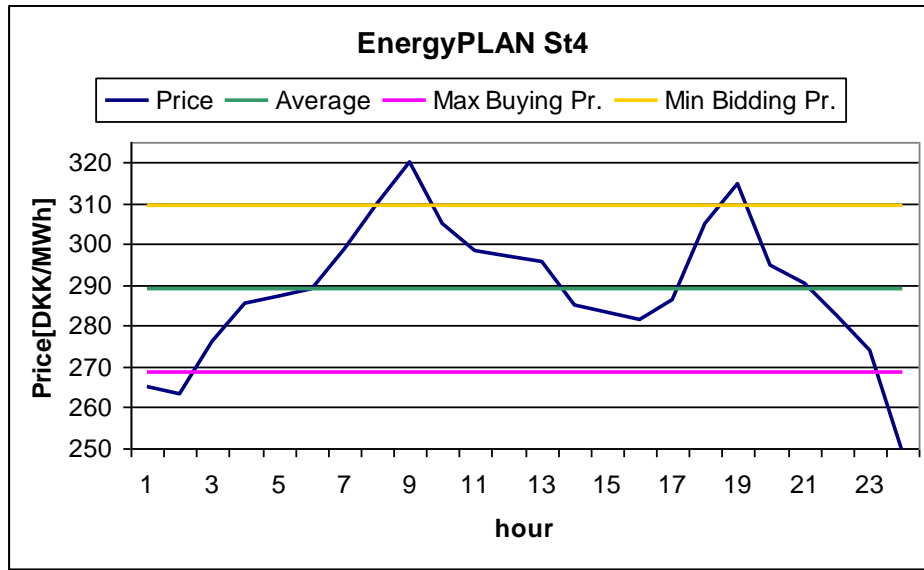

Figure 7.1: EnergyPLAN St4 concept, where the average of an upcoming period, 24 hours in this figure, is used for calculating market bidding prices.

The distance between the minimum and maximum lines represents the minimum difference between the selling and the buying price if a profit is to be made. Such price difference is identified on the basis of the multiplication and addition factors of CAES, as described in section 4.4.

$$F_{\text{Multiplication-CAES}} = 1 / (\alpha_{\text{Pump}} * \mu_{\text{Turbine}})$$

$$F_{\text{Addition-CAES}} = (VOC_{\text{Pump}} + TAX_{\text{Pump}}) / (\alpha_{\text{Pump}} * \mu_{\text{Turbine}}) + VOC_{\text{Turbine}} + \phi_{\text{CAES}} * (P_{\text{Ngas}} + P_{\text{Handling-Ngas}} + Tax_{\text{Ngas-CAES}}) * 3.6$$

As a basic assumption, the market price when selling must exceed the market price when buying in order to generate a profit, in accordance with the following formula of section 4.4:

$$p_{\text{sell}} > p_{\text{buy}} * F_{\text{Multiplication}} + F_{\text{Addition}}$$

In which p_{sell} is the market electricity price when selling (DKK/MWh)
 p_{buy} is the market electricity price when buying (DKK/MWh)
 $F_{\text{Multiplication}}$ is the multiplication factor (always bigger than 1), and
 F_{Addition} is the addition factor (DKK/MWh)

The price difference is defined as:

$$p_{\text{sell}} = p_{\text{Average}} + p_{\text{Diff}} \quad \text{and} \quad p_{\text{Buy}} = p_{\text{Average}} - p_{\text{Diff}}$$

Consequently, the price difference can be identified as:

$$p_{\text{diff}} = [p_{\text{Average}} * (1 - \alpha_{\text{Pump}} * \mu_{\text{Turbine}}) + \text{constant}] / (\alpha_{\text{Pump}} * \mu_{\text{Turbine}} + 1)$$

In which the constant represents the variable operational costs (VOC) of consuming one unit of electricity in the pump (or compressor), found as 1) the VOC of the pump, 2) the VOC of the turbine corrected for losses in the process, and 3) the VOC of the additional fuel in the turbine also corrected for the losses in the process:

$$\text{constant} = (\text{VOC}_{\text{Pump}} + \text{TAX}_{\text{Pump}}) + \text{VOC}_{\text{Turbine}} * (\alpha_{\text{Pump}} * \mu_{\text{Turbine}}) \\ + \phi_{\text{CAES}} * (P_{\text{Ngas}} + P_{\text{Handling-Ngas}} + \text{Tax}_{\text{Ngas-CAES}}) * 3.6 * (\alpha_{\text{Pump}} * \mu_{\text{Turbine}})$$

As specified in section 4.3.1.3, one can add an increase to the minimum profit rate in percent. If one e.g. inserts 20%, p_{diff} will be multiplied by a factor 1.2. This option is especially relevant if the storage is so large that it will have a substantial influence on the market price. In such situations the storage plant might benefit from raising the profit rate.

Based on the above price difference, p_{diff} , the operation of the electricity storage or CAES system is defined in the following way:

The average price of the upcoming period is found as described and illustrated above and the minimum selling price and the maximum buying price are determined:

$$p_{\text{sell-Min}} = p_{\text{Average}} + p_{\text{Diff}}$$

$$p_{\text{Buy-Max}} = p_{\text{Average}} - p_{\text{Diff}}$$

The market system price, p_x , and the balance production of the turbine, $\text{BalanceProduction}_{\text{Turbine}}$, are found as described in section 7.1. If the market system price is higher than the minimum selling price, the turbine is activated:

$$\text{If } p_x > p_{\text{sell-Min}} \text{ then } e_{\text{Turbine}} = \text{Min} (C_{\text{Turbine}}, \text{BalanceProduction}_{\text{Turbine}})$$

Similarly, the market system price is found for the pump, p_x , and the balance consumption of the pump, $\text{BalanceConsumption}_{\text{Pump}}$, as described in section 7.1. If the market system price is lower than the maximum buying price, the pump is activated:

$$\text{If } p_x < p_{\text{Buy-Max}} \text{ then } d_{\text{Pump}} = \text{Min} (C_{\text{Pump}}, \text{BalanceConsumption}_{\text{Pump}})$$

The storage content, S_{CAES} , is calculated:

$$S_{\text{CAES}} (x) = S_{\text{CAES}}(x-1) + d_{\text{Pump}} * \alpha_{\text{Pump}} - e_{\text{Turbine}} * \mu_{\text{Turbine}}$$

If the storage content exceeds the capacity, the pump is reduced accordingly, and if the storage content goes below zero, the turbine production is reduced.

The above modelling makes it possible to bypass the storage while operating the pump and turbine at the same time, if feasible. Such situation occurs when operating a CAES plant as a gas turbine under conditions of high electricity prices and low natural gas prices.

Due to differences in the storage content between the beginning and the end of the calculation period, errors may appear in the calculations. In order to correct these errors, the above calculation is repeated until the storage content at the end is the same as at the beginning.

7.10. Resulting electricity market prices (External, Domestic and bottlenecks)

In the above-mentioned procedure, it is checked if the balance production of each unit results in a total electricity production in the system. This will have the consequence that the export exceeds the transmission line capacity. If such a bottleneck occurs, the production of the relevant unit is reduced accordingly, as described in section 7.8. Moreover, it is checked if the import exceeds the transmission line capacity, and in such case, the production of the condensing power plant is increased.

In the case of a bottleneck, the price areas of the external and the domestic markets are separated, and the domestic market price is calculated as the highest bidding price of the active production units, i.e., the marginal operational costs of the unit which created the bottleneck. In the case of critical excess production, the domestic market price becomes zero. The external market prices are calculated as shown in section 7.1, when applying an export equal to the capacity of the transmission lines.

If there is no bottleneck, the domestic and the external market prices are the same.

If bottlenecks occur, a profit is made since electricity is bought on one side of the bottleneck at a lower price than the price at which it is sold on the other side. Such profit is normally shared on an equal basis between the TSOs on each side of the bottleneck. Consequently, half of such profit is here included as an income in the socio-economic feasibility calculation. Such income is simply identified as 50% of the difference between the market prices on the domestic and the external markets.

7.11. Grid stability

In the end, the model makes sure that the grid stability requirements are fulfilled. First, the grid stabilisation is calculated as described in section 8.3 (below). If the requirement is not fulfilled, the production of the power plant is increased accordingly.

8. Fuel, CO₂ emissions and Feasibility Study (calculations)

After having optimised the operation of the various production units in accordance with either the technical or the market-economic simulation strategy, the model makes a number of calculations of final fuel consumptions, CO₂ emissions and costs. The model also removes critical excess electricity production in accordance with the specified strategy.

8.1. Fixed boiler production is added to the boilers in groups 2 and 3

The fixed boilers percentage of the district heating in groups 2 and 3, subtracted in section 5.4, is now added to the boiler production. The fixed boilers percentage represents the hours at which the CHP units of one system are not operating because of maintenance or breakdowns:

$$Q_{B2} = Q_{B2} + Q_{\text{FixedBoiler2}}$$

The same calculation is done for district heating group 3.

8.2. Reducing Critical Excess Electricity Production

A number of measures to reduce Critical Excess Electricity Production, e_{CEEP} , can be activated, as shown in section 4.3.1.1:

- 1: Reducing RES1 and RES2
- 2: Reducing CHP production in group 2 (Replacing with boiler)
- 3: Reducing CHP production in group 3 (Replacing with boiler)
- 4: Replacing boiler production with electric heating in group 2.
- 5: Replacing boiler production with electric heating in group 3.
- 6: Reducing RES4 and RES5
- 7: Reducing power plant production in combination with RES1, RES2, RES3 and RES4
- 8: Increasing CO₂ Hydrogenation during hours of CEEP
- 9: Partloading nuclear (specify partload options in Electricity only tabsheet)

It is possible to specify one or more numbers which will be treated in the specified order. For example, the combination 315 activates three CEEP reductions. First, CEEP is reduced as much as possible by option 3, then by option 1, and finally, by option 5. All 7 options can be activated in all possible combinations.

8.2.1. Reducing RES1 and RES2

First, RES1 is reduced. The reduction potential, Red_{pont} , is found as follows:

$$\text{Red}_{\text{pont}} = \text{Min}(e_{\text{RES1}} ; e_{\text{CEEP}})$$

And new values are calculated:

$$e_{\text{RES1}} = e_{\text{RES1}} - \text{Red}_{\text{pont}}$$

$$e_{\text{CEEP}} = e_{\text{CEEP}} - \text{Red}_{\text{pont}}$$

Thereafter, RES 2 production is calculated in the same manner.

8.2.2. Reducing CHP production in group 2

First, the minimum CHP production needed in order to fulfil the requirement of stabilising the grid is found:

$$e_{\text{CHP2-Min}} = [e_{\text{Total}} * \text{Stab}_{\text{total}} - (e_{\text{W1}} + e_{\text{W2}} + e_{\text{W3}}) * \text{Stab}_{\text{Waste}} - e_{\text{RES1}} * \text{Stab}_{\text{RES1}} - e_{\text{RES2}} * \text{Stab}_{\text{RES2}} - e_{\text{RES3}} * \text{Stab}_{\text{RES3}} - \dots - e_{\text{RES7}} * \text{Stab}_{\text{RES7}} - e_{\text{CHP3}} - e_{\text{Nuclear}} - e_{\text{Geothermal}} - e_{\text{Hydro}} - e_{\text{Turbine}} - e_{\text{V2G}} * \text{Stab}_{\text{V2G}} - C_{\text{imp/exp}} * \text{Stab}_{\text{TRANS}} - e_{\text{PP}} * (1 - \text{Stab}_{\text{Total}})] / \text{Stab}_{\text{CHP2}}$$

Then, the reduction potential, Red_{pont} , is found:

$$\text{Red}_{\text{pont}} = \min(e_{\text{CHP2}} - e_{\text{CHP2-Min}} ; e_{\text{CEEP}})$$

And new values are calculated:

$$e_{\text{CHP2}} = e_{\text{CHP2}} - \text{Red}_{\text{pont}}$$

$$e_{\text{CEEP}} = e_{\text{CEEP}} - \text{Red}_{\text{pont}}$$

$$q_{\text{CHP2}} = e_{\text{CHP2}} * \rho_{\text{CHP2}} / \mu_{\text{CHP2}}$$

$$q_{\text{B2}} = q_{\text{B2}} - \text{Red}_{\text{pont2}} * \rho_{\text{CHP2}} / \mu_{\text{CHP2}}$$

8.2.3. Reducing CHP production in group 3

First, the minimum CHP production needed in order to fulfil the requirement of stabilising the grid is found:

$$e_{\text{CHP3-Min}} = [e_{\text{Total}} * \text{Stab}_{\text{total}} - (e_{\text{W1}} + e_{\text{W2}} + e_{\text{W3}}) * \text{Stab}_{\text{Waste}} - e_{\text{RES1}} * \text{Stab}_{\text{RES1}} - e_{\text{RES2}} * \text{Stab}_{\text{RES2}} - e_{\text{RES3}} * \text{Stab}_{\text{RES3}} - e_{\text{RES4}} * \text{Stab}_{\text{RES4}} - e_{\text{CHP2}} * \text{Stab}_{\text{CHP2}} - e_{\text{Nuclear}} - e_{\text{Geothermal}} - e_{\text{Hydro}} - e_{\text{Turbine}} - e_{\text{PP}} * (1 - \text{Stab}_{\text{Total}})] / \text{Stab}_{\text{CHP2}}$$

If such minimum is below the input-specified CHP3 minimum production, $C_{\text{CHP3-Min}}$ (see section 4.4.2), the value is increased accordingly:

$$\text{If } e_{\text{CHP3-Min}} < C_{\text{CHP3-Min}} \text{ then } e_{\text{CHP3-Min}} = C_{\text{CHP3-Min}}$$

Then, the reduction potential, Red_{pont} , is found:

$$\text{Red}_{\text{pont}} = \min(e_{\text{CHP3}} - e_{\text{CHP3-Min}} ; e_{\text{CEEP}})$$

And new values of CHP and boiler heat production are calculated, as in section 8.2.2 above.

8.2.4. Replacing boiler production with electric heating in group 2

The reduction potential, Red_{pont} , is calculated as follows:

$$\text{Red}_{\text{pont}} = \min(q_{\text{B2}} ; e_{\text{CEEP}})$$

Then, the value for electric heating is calculated:

$$e_{\text{EH}} = \text{Red}_{\text{pont}}$$

Subsequently, new values for e_{CEEP} and q_{B2} are calculated.

8.2.5. Replacing boiler production with electric heating in group 3

The same calculations are made as described in section 8.2.4 above, just replacing group 2 with group 3.

8.2.6. Reducing RES3

The potential for reducing RES3 is found in the same way as for RES1 in section 8.2.1 above.

8.2.7. Reducing power plant production in combination with RES1, 2, 3 and RES4

This option has been added because in options 1 and 6 (reduction of RES1, RES2 and RES3), the sequence of first increasing the power plant for stability reasons and then decreasing renewable sources in cases of very high RES shares led to CEEP from the power station. In such cases, one can increase the share of RES and still maintain minimum stabilisation demands by decreasing the power plant and the RES productions simultaneously.

First, the minimum load of the power plant is calculated in the case of no RES1 at all:

$$e_{PP-No-RES1} = [e_{Total} * Stab_{total} - (e_{W1} + e_{W2} + e_{W3}) * Stab_{Waste} - e_{Res2} * Stab_{Res2} - e_{Res3} * Stab_{Res3} - \dots - e_{Res7} * Stab_{Res7} - e_{CHP2} * Stab_{CHP2} - e_{CHP3} - e_{Hydro} - e_{Turbine} - e_{V2G} * Stab_{V2G} - C_{imp/exp} * Stab_{TRANS}] / (1 - Stab_{total})$$

Then, the reduction potential of the power plant is identified as the difference between this number and the previously defined electricity production of the power plant:

$$e_{PP-pontial} = e_{PP} - e_{PP-No-Res1}$$

The potential reduction of CEEP achieved through this reduction of the power plant production is identified by the following factor:

$$factor = e_{CEEP} * (Stab_{Total} - Stab_{Res1}) / (1 - Stab_{Res1})$$

If such factor is lower than the reduction potential, $e_{PP-pontial}$, the reduction potential is reduced accordingly:

$$\text{If } e_{PP-pontial} > factor \text{ then } e_{PP-pontial} = factor$$

First, the CEEP is reduced by the power plant contribution:

$$e_{PP} = e_{PP} - Red_{pont}$$

$$e_{CEEP} = e_{CEEP} - Red_{pont}$$

Then, a new reduction potential achieved by reducing RES1 is found and CEEP and RES1 are reduced accordingly:

$$Red_{pont-next} = \text{Min}(e_{RES1} ; e_{CEEP})$$

$$e_{RES1} = e_{RES1} - Red_{pont-next}$$

$$e_{CEEP} = e_{CEEP} - Red_{pont-next}$$

The same procedure is repeated for RES2, RES3 and RES4.

8.2.8. Increasing CO₂ Hydrogenation during hours of CEEP

Additional to the use of the CO₂ Hydrogenation plant for the production of the specified amount of synthetic gas needed, the plant is here used for producing additional synthetic gas to the grid during hours of excess electricity production and available capacity on the plant.

First, the relationship ($FACTOR_{CO_2Hydro-GridGas}$) between the total electricity demand ($D_{CO_2Hydro-Sum}$) and the corresponding grid gas production ($F_{CO_2Hydro-GridGas}$) is calculated:

$$FACTOR_{CO_2Hydro-GridGas} = D_{CO_2Hydro-Sum} / F_{CO_2Hydro-GridGas}$$

The maximum demand for increasing the electricity production is found as the hourly value of the critical electricity production, e_{CEEP} . The maximum potential of fulfilling the demand is found as the difference between the maximum capacity and the actual production of the CO₂ hydrogenation plant:

$$Max_{pont} = (C_{CO_2Hydro-MAX} * FACTOR_{CO_2Hydro-GridGas}) - d_{CO_2Hydro-Sum}$$

The change is then identified as the minimum value of the maximum demand and the maximum potential

$$change = \text{Min}(Max_{pont} ; e_{CEEP})$$

And new values are calculated:

$$d_{CO_2Hydro-Sum} = d_{CO_2Hydro-Sum} + change$$

$$e_{CEEP} = e_{CEEP} - change$$

8.2.9. Partloading nuclear

This function enables nuclear to run in partload operation. That means in hours with critical excess electricity, by enabling the partload of nuclear it will reduce the operation of the nuclear power plants. The user can define how big of a share of the max capacity that can be reduced.

The function identifies if

$$d_{Nuclear} > C_{Nuclear} * PAR_{Nuclea}$$

This identifies if there is potential for down regulating.

With a potential for down regulating, EnergyPLAN will calculate the change and the new nuclear production

$$change = d_{Nuclear} - C_{Nuclear} * PAR_{Nuclea}$$

$$e_{Nuclear} = d_{Nuclear} - change$$

This results in a new CEEP amount:

$$e_{CEEP} = e_{CEEP} - change$$

8.3. Grid stabilisation

The degree to which the grid stabilisation requirements have been fulfilled is calculated in the following way:

First, the grid stabilisation demand, d_{Stab} , is calculated on the basis of e_{Total} , which represents all electricity productions, as described in section 6.1:

$$d_{Stab} = e_{Total} * Stab_{total}$$

Then, the grid stabilisation supply, e_{Stab} , is calculated:

$$e_{Stab} = e_{PP} + e_{CHP2} * Stab_{CHP2} - (e_{W1} + e_{W2} + e_{W3}) * Stab_{Waste} - e_{RES1} * Stab_{RES1} - e_{RES2} * Stab_{RES2} - e_{RES3} * Stab_{RES3} \\ - \dots - e_{RES7} * Stab_{RES7} - e_{CHP3} - e_{Nuclear} - e_{Geothermal} - e_{Hydro} - e_{Turbine} - e_{V2G} - e_{V2G} * Stab_{V2G} - C_{Imp/exp} * Stab_{TRANS}$$

Then, the fulfilment of the grid stabilisation, GridStab, is calculated in percentage terms:

$$GridStab = e_{Stab} / d_{Stab} * 100$$

8.4. Heat balances in district heating systems

Subsequently, the heat balances, $h_{Balance}$, in the district heating groups are calculated:

$$h_{Balance} = h_{DH} - h_{Solar} - h_{CSHP} - h_{CHP} - h_{HP} - h_B - h_{EH} - h_{Eic}$$

The heat balance is calculated separately for each district heating group.

8.5. Fuel consumptions

For various production units in the model (DHP, CHP2, CHP3, Boiler2, Boiler3 and PP), the distribution across fuel types is stated as input (See section 4.2.5.) divided into the following types of fuels:

- Coal
- Oil
- Natural Gas, and
- Biomass

For transport, oil is divided into fuel oil, diesel/gas oil and petrol/JP. Moreover, fuels such as hydrogen (or similar fuels from internal energy conversion in the system) are calculated.

For the production units mentioned above, the distribution is calculated relatively. The total fuel consumption of each energy unit is the result of the system analyses described in chapters 6 and 7. Given the total fuel consumption, the distribution across the four fuel types is calculated relatively according to the input values.

If, for instance,

- the total energy consumption of the DHP unit is identified as 10 TWh, and
 - the input fuel distribution is stated as follows: Coal=1, Oil=1, Ngas=2, Biomass=1
- the result will be: Coal=2, Oil=2, Ngas=4, Biomass=2, Total=10.

The model can be told not to consider limitations on some of the fuel types by activating the "Variable / Fixed" button in the input.

If, for instance,

- the total energy consumption of the DHP unit is found to be 10 TWh, and
- the input fuel distribution is stated as follows: Coal=1, Oil=1, Ngas=2, Biomass=1
- **and the button for biomass is activated as "Fixed"**

the result will be: Coal=2.25, Oil=2.25, Ngas=4.5, Biomass=1, Total=10.

If **all** buttons are activated as "fixed", the model is told to consider all types as "variable". The model also makes an import/export-corrected fuel account. This is done simply by using the input data for the PP unit to adjust the import/export. In the final account, wind, photo voltaic and solar thermal power are added to the account as a new type of fuel named "Renewable".

8.6. CO₂ emissions

When applying the CO₂ emission (kg/GJ) of each of the four fuel types as an input, the model calculates the CO₂ emission simply by multiplying the fuel consumption by the emission data.

The model also calculates an import/export-corrected CO₂ emission by using the import/export-corrected fuel account.

8.7. Balancing of Gas Grid

Based on the resulting productions of all units fuelled by natural gas together with biogas and syngas productions based on the inputs in the Biomass Conversion tab sheet, the model calculates the hourly consumption and production of gas to and from the gas grid, including the utilisation of the grid storage (if specified in the input) to balance the import/export of gas.

8.7.1. (Natural) gas consumption

First, the model identifies the natural gas consumptions. Natural gas consumption of boilers in group DH1, 2 and 3 is calculated as follows:

$$f_{B1} = q_{B1} / \rho_{B1} * SHARE_{Ngas}$$

SHARE_{Ngas} is the share of total fuel coming from natural gas as specified in the input.

Natural gas consumption in CHP2 and CHP3:

$$f_{CHP2} = q_{CHP2} / \rho_{CHP2} * SHARE_{Ngas}$$

Natural gas consumption in power plants (PP and PP2):

$$f_{PP} = e_{PP} / \mu_{PP} * SHARE_{Ngas}$$

Natural gas consumption in CAES:

$$f_{CAES} = e_{Turbine} / \phi_{CAES}$$

Natural gas consumption in individual natural gas boilers and micro CHPs:

$$f_{M\text{-Ngas}} = q_{M\text{-Ngas}} / \rho_{M\text{-Ngas}}$$

$$f_{M\text{-NgasCHP}} = q_{M\text{-NgasCHP}} / \rho_{M\text{-NgasCHP}}$$

$$f_{M\text{-NgasCHP-Boiler}} = q_{M\text{-NgasCHP-Boiler}} / \rho_{M\text{-NgasCHP-Boiler}}$$

Natural gas consumption in natural gas vehicles (transport):

$$f_{T\text{-Ngas}} = F_{T\text{-Ngas}} * d_{T\text{-Ngas}}$$

in which $d_{T\text{-Ngas}}$ is the hourly distribution specified in the Transport input tab sheet.

Natural gas consumption in Industry:

$$f_{I\text{-Ngas}} = F_{I\text{-Ngas}} * d_{I\text{-Ngas}}$$

in which $d_{I\text{-Ngas}}$ is the hourly distribution specified in the Industry input tab sheet.

The resulting total natural gas consumption, $f_{\text{Total-Demand}}$, is calculated as the sum of all the above-mentioned fuel consumptions.

8.7.2. Biogas and Syngas production

Thereafter, the model identifies the biogas and syngas productions upgraded and supplied to the gas grid. The hourly supply of biogas and syngas to hydrogenation is (in the present version 12) assumed to be constant and therefore calculated as follows:

$$f_{\text{Biogas-for-HydroMethanation}} = F_{\text{Biogas-for-HydroMethanation}} * 1,000,000 / 8784$$

$$f_{\text{Gasigas-for-Hydrogenation}} = F_{\text{Gasigas-for-Hydrogenation}} * 1,000,000 / 8784$$

The factor 1,000,000 compensates for the fact that f is measured in MW and F is measured in TWh/year.

Biogas production in biogas plants:

$$f_{\text{Biogas}} = F_{\text{Biogas}} * d_{\text{Biogas}}$$

in which d_{Biogas} is the hourly distribution specified in the Biomass Conversion input tab sheet.

The biogas supplied to the grid is found through an upgrade to grid efficiency after the subtraction of biogas used for electrofuels (See section 4.2.7.4.):

$$f_{\text{Biogas-to-NgasGrid}} = (f_{\text{Biogas}} - f_{\text{Biogas-for-HydroMethanation}}) * \kappa_{\text{Biogas}}$$

The annual production of syngas, F_{Syngas} , is calculated on the basis of the annual biomass input, $F_{\text{Gasi-Biomass}}$, subtracted the share of biomass used for steam production:

$$F_{\text{Syngas}} = \gamma_{\text{GASI}} * \kappa_{\text{Syngas}} * [F_{\text{Gasi-SolidBiomass}} - (F_{\text{Gasi-SolidBiomass}} * \text{SHARE}_{\text{STEAM-Gasi}}) / \lambda_{\text{GASI}}]$$

In which

$SHARE_{STEAM-Gasi}$ = Annual input of steam to gasification plant in share of biomass input

λ_{GASI} = Production of steam efficiency (steam output divided by biomass input)

γ_{GASI} = Cold gas efficiency (gas output divided by biomass input)

κ_{Syngas} = Syngas to grid gas quality efficiency

The calculation of syngas productions from gasification plants depends on the specification of a maximum capacity. If a maximum capacity, $C_{GASI-MAX}$, higher than the average production has been specified in the Biomass Conversion input tab sheet, the exact syngas production can be calculated. If not, the syngas production is simply calculated as the average production:

$$f_{Syngas} = F_{Syngas} / 8784 \text{ hours} * 1,000,000$$

The factor 1,000,000 compensates for the fact that f is measured in MW and F is measured in TWh/year.

IF a maximum capacity, $C_{GASI-MAX}$, higher than the average value has been specified, the model will seek to use such flexibility to minimise the maximum import as much as possible in the following way:

First, hourly imports of gas are calculated as the difference between total natural gas demands and biogas productions:

$$f_{Ngas-Import} = f_{Total-Demand} - f_{Biogas-to-NgasGrid} - f_{Gasigas-for-Hydrogenation}$$

Secondly, a maximum value of consumption, MAX is defined. In the beginning, such value is initialised as the maximum value of $f_{Ngas-Import}$. The MAX value is used to run the following sequence for all hours of the year:

$$\text{IF } MAX < f_{Ngas-Import} \text{ THEN } f_{Syngas} = \text{MIN} [(f_{Ngas-Import} - MAX), C_{GASI-MAX}]$$

If the resulting syngas production is below the annual production calculated in accordance with the input specifications in the Biomass Conversion input tab sheet, the MAX is raised gradually and the above sequence is repeated until the output matches the annual syngas production.

The gasification syngas supplied to the grid is found through an upgrade to grid efficiency after the subtraction of gasification gas used for Electrofuels (See section 4.2.7.4.):

$$f_{Gasigas-to-NgasGrid} = (f_{Syngas} - f_{Gasigas-for-Hydrogenation}) * \kappa_{Syngas}$$

8.7.3. Gas storage

If a gas storage capacity, $C_{Ngas-Storage}$, is specified in the Biomass Conversion input tab sheet, the model will utilise the gas storage to balance the export and import of gas to and from the system. Please, note that this means that the gas storage is only used if both export and import are positive as a consequence of the above calculations of gas consumption and biogas and syngas productions.

First, hourly imports of gas are calculated as the difference between total natural gas demands and biogas and syngas productions:

$$f_{Ngas-Import} = f_{Total-Demand} - f_{Biogas-to-NgasGrid} - f_{Gasigas-to-NgasGrid}$$

Next, the input and output of the storage, $f_{Ngas-Storage}$, is calculated using the following sequence:

$$\text{IF } f_{\text{Ngas-Import}} > 0 \text{ THEN } f_{\text{Ngas-Storage}} = \text{MIN}(f_{\text{Ngas-Import}}, f_{\text{Ngas-Storage-Content}})$$

$$\text{IF } f_{\text{Ngas-Import}} < 0 \text{ THEN } f_{\text{Ngas-Storage}} = \text{MIN}(-f_{\text{Ngas-Import}}, (C_{\text{Ngas-Storage}} - f_{\text{Ngas-Storage-Content}}))$$

After each hour, the storage content is updated:

$$f_{\text{Ngas-Storage-Content}} = f_{\text{Ngas-Storage-Content}} - f_{\text{Ngas-Storage}}$$

To compensate for any difference in the storage content between the beginning and the end of the year, the above sequence is repeated until the content is the same at the beginning as at the end. After one sequence, a new initial content is defined as the resulting content at the end of the calculation.

8.7.4. Calculation of balance, import and export

To complete the analysis of the balancing of the gas grid, a balance is calculated together with the import and export:

$$f_{\text{Ngas-Balance}} = f_{\text{Total-Demand}} - f_{\text{Biogas-to-NgasGrid}} - f_{\text{Gasigas-to-NgasGrid}} - f_{\text{Ngas-Storage}}$$

$$\text{IF } f_{\text{Ngas-Balance}} > 0 \text{ THEN } f_{\text{Nnggs-Import}} = f_{\text{Ngas-Balance}} \text{ ELSE } f_{\text{Nnggs-Import}} = 0$$

$$\text{IF } f_{\text{Ngas-Balance}} < 0 \text{ THEN } f_{\text{Nnggs-Export}} = -f_{\text{Ngas-Balance}} \text{ ELSE } f_{\text{Nnggs-Export}} = 0$$

8.8. Share of Renewable Energy

The model calculates the share of renewable energy in the system. The share is calculated as a percentage of the primary energy supply. The renewable resource is identified as RES, hydro power, geothermal power and solar thermal productions plus biomass and waste fuels. The total primary energy supply is identified as the same figure added all fossil fuels. Fuels such as hydrogen or biofuel for transport produced on waste are not included in the primary energy supply, since they are produced from other energy resources which have already been included in the supply.

The model also calculates the share of electricity produced from renewable energy. In such calculation, the share of biomass compared to the total fuel consumption determines the share of CHP and power plants.

8.9. Cost

Annual socio-economic costs are divided into fuel costs, variable and fixed operation and maintenance costs, investments costs, CO₂ emission costs, and electricity exchange costs.

8.9.1. Fuel costs

Fuel costs are defined as input unit prices, including handling costs multiplied by the annual total fuel consumption. The socio-economic costs do not include taxes.

The total annual coal costs, A_{Coal} , are found as follows:

$$A_{\text{Coal}} = 3.6 * [F_{\text{Coal-Total}} * P_{\text{Coal-WM}} + F_{\text{Coal-PP}} * P_{\text{Coal-HCen}} + (F_{\text{Coal-B1}} + F_{\text{Coal-CHP2}} + F_{\text{Coal-CHP3}} + F_{\text{Coal-B2}} + F_{\text{Coal-B3}} + F_{\text{Coal-CSHP}}) * P_{\text{Coal-HDec}} + F_{\text{Coal-Indv}} * P_{\text{Coal-HIndv}}]$$

The costs of the remaining fuels are found in the same way.

8.9.2. Electricity exchange costs

Electricity exchange costs are found on the basis of resulting external market prices, see, e.g., section 7.10. Import costs are identified as the hourly import multiplied by the resulting external market price at the relevant hour. The income from export is found in the same way.

The exchange cost of fixed import/export is found in the same way as the import/export costs multiplied by external market prices.

Bottleneck income is found as described in section 7.10 as half of the difference between external and domestic market prices multiplied by the transmission capacity, since bottlenecks only appear when the transmission capacity is fully exploited.

8.9.3. Variable operational costs

Annual variable operational costs are identified as the cost per unit (of section 4.4.4) multiplied by the relevant production. E.g., the operational costs of boilers are found in the following way:

$$A_{\text{VOC-Boiler-DH}} = (e_{B1} + e_{B2} + e_{B3}) * P_{\text{VOC-Boiler-DH}}$$

8.9.4. Fixed operation and maintenance and investment costs

The fixed operation and maintenance costs as well as the annual investment costs are found already in the investment/cost tab sheet (see section 4.4.2).

9. Output

The output can be shown and/or exported from the model in the following ways: View on the screen, Print or see in Graphics.

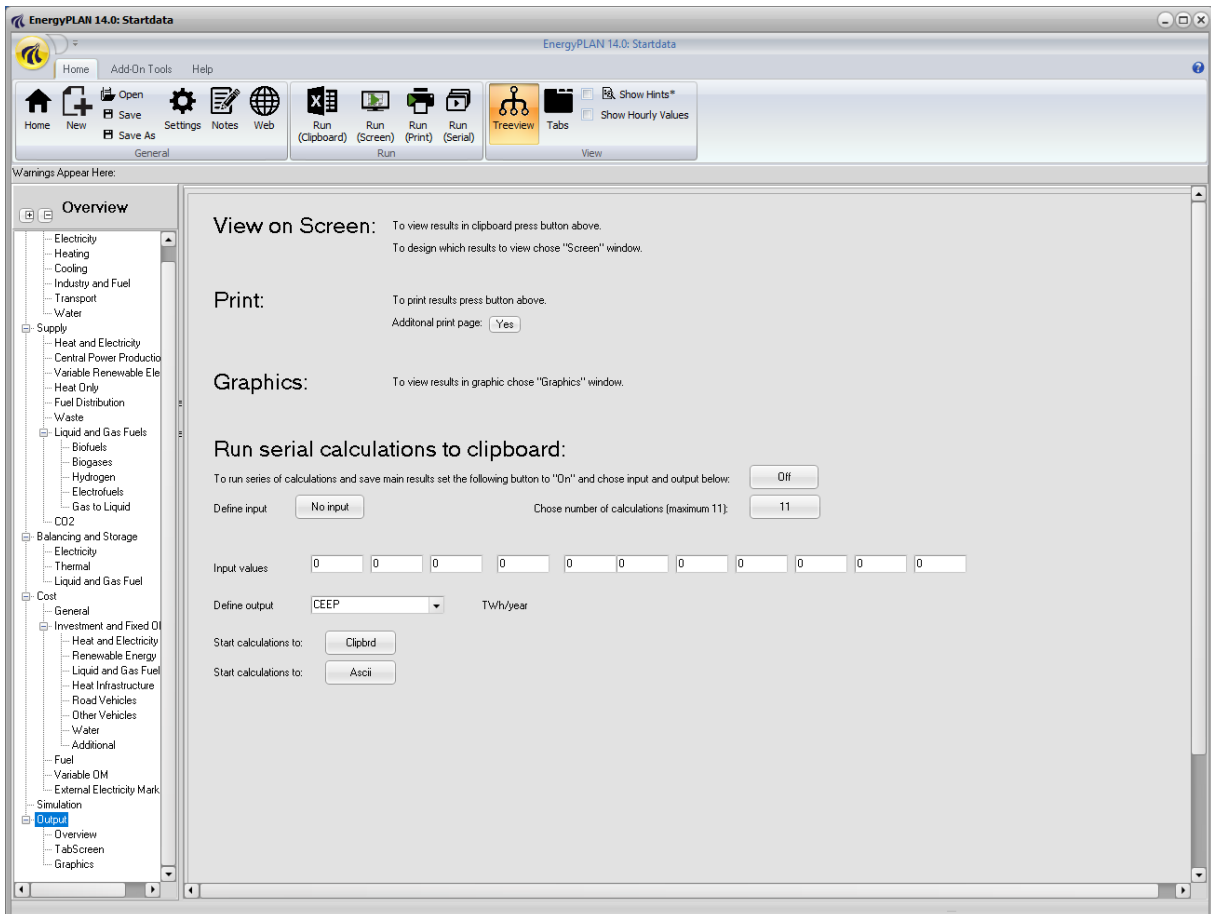

9.1. The screen function

Results can be viewed on the screen.

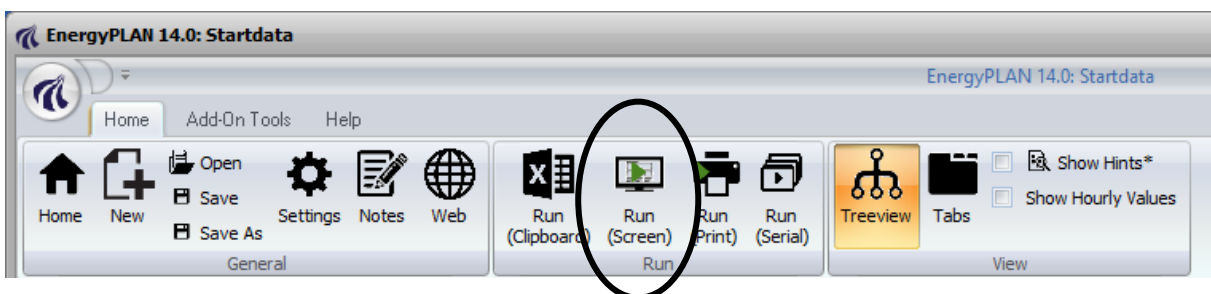

The function can be activated by clicking on the icon called "view clipboard" in the upper line of the main display of the programme. When activating this facility, the programme will start calculating and then open a text file in which the results are shown.

Results

V2G Pre Load Hours = U

ANNUAL COSTS

Total Fuel = 0 Million SEK

Coal = 0 Million SEK

FuelOil = 0 Million SEK

Gasoil/Diesel = 0 Million SEK

Petrol/JP = 0 Million SEK

Ngas = 0 Million SEK

Biomass = 0 Million SEK

Food income = 0 Million SEK

Waste = 0 Million SEK

Marginal operation costs = 0 Million SEK

Total Electricity exchange = -1594 Million SEK

Import = 0 Million SEK

Export = 0 Million SEK

Bottleneck = -1594 Million SEK

Fixed imp/ex = 0 Million SEK

Total CO2 emission costs = 0 Million SEK

Total Ngas Exchange costs = 0 Million SEK

Total variable costs = -1594 Million SEK

Fixed operation costs = 0 Million SEK

Annual Investment costs = 0 Million SEK

TOTAL ANNUAL COSTS = -1594 Million SEK

	elec. demand	elec. cooling	Fixed Exp/Imp	district heating	wind power	PV	Wave power	River hydro	Hydro power	Hydro pump	Hydro storage	Hy Wa
TOTAL FOR ONE YEAR (TWh/year):												
Annual:	20.00	0.00	0.00	20.00	2.07	1.04	0.00	0.00	0.00	0.00	0.00	
MONTHLY AVERAGE VALUES (MW):												
January	2573	0	0	3856	315	157	0	0	0	0	0	
February	2546	0	0	3644	300	150	0	0	0	0	0	
March	2450	0	0	3140	237	119	0	0	0	0	0	
April	2159	0	0	2346	222	111	0	0	0	0	0	
May	2107	0	0	1538	219	110	0	0	0	0	0	
June	2048	0	0	1124	189	95	0	0	0	0	0	
July	1867	0	0	913	144	72	0	0	0	0	0	
August	2148	0	0	946	166	83	0	0	0	0	0	
September	2204	0	0	1333	212	106	0	0	0	0	0	
October	2287	0	0	2072	211	105	0	0	0	0	0	
November	2471	0	0	2923	301	151	0	0	0	0	0	
December	2472	0	0	3533	320	160	0	0	0	0	0	
Average	2277	0	0	2277	236	118	0	0	0	0	0	
Maximum	3512	0	0	4049	990	495	0	0	0	0	0	
Minimum	1141	0	0	820	0	0	0	0	0	0	0	

All calculated results of each unit in the system can be shown both on an annual and a monthly basis. Moreover, one can see each hourly value. The user can define the results to be shown in the "Screen" window in the EnergyPLAN model. All hourly data for all calculations are available.

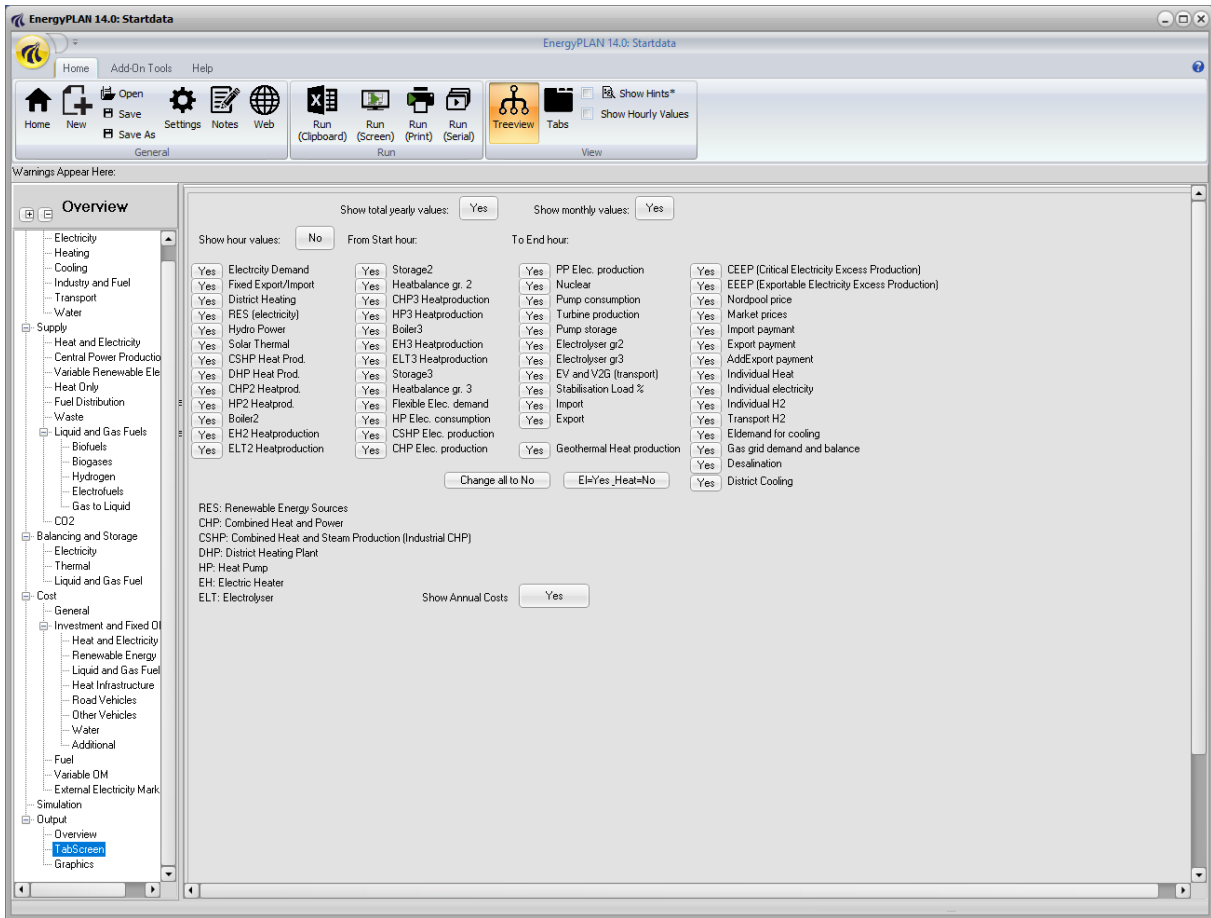

9.2. The print

Results can be printed in an A4 version defined by the model.

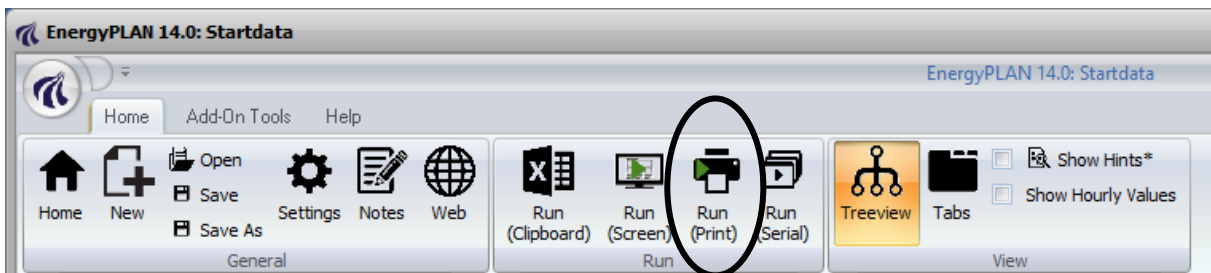

The function can be activated by clicking on the printer icon in the upper line of the main display of the programme. When activating this facility, the programme will start calculating and then send a print to the printer.

One can choose to add an additional page of specifications by clicking on “Yes” in the output overview tab sheet, as shown below. In such case, two pages will be printed instead of one. The default is set to “Yes”.

Examples of prints are shown on the next page.

Input		Denmark2030Reference.txt	The EnergyPLAN model 12.0
Electricity demand (TWh/year):	Flexible demand	0,00	
Fixed demand	Fixed impexp.	0,00	
Electric heating + HP	Transportation	0,00	
Electric cooling	Total	49,00	
District heating (TWh/year)	Gr.1	Gr.2	Gr.3
District heating demand	2,26	14,29	22,63
Solar Thermal	0,02	0,00	0,00
Industrial CHP (CSHP)	0,00	0,00	1,73
Demand after solar and CSHP	2,24	14,29	20,90
Wind	3100 MW	7,26 TWh/year	0,00 Grid
Offshore Wind	1952 MW	7,61 TWh/year	0,00 stabili-
Photo Voltaic	0 MW	0 TWh/year	0,00 sation
Wave Power	0 MW	0 TWh/year	0,00 share
Hydro Power	0 MW	0 TWh/year	
Geothermal/Nuclear	0 MW	0 TWh/year	
Capacities	Group 2:	Efficiencies	Regulation Strategy:
MW-e	MW-e	MJ/s	KEOL regulation
MU/s	MU/s	elec.	23457000
elec.	elec.	Ther	Minimum Stablisation share
Ther	Ther	COP	0,00
COP	COP		Stablisation share of CHP
			0,00
Group 3:	Group 3:		Minimum CHP gr 3 load
CHP	CHP		450 MW
Heat Pump	Heat Pump		Minimum PP
			0 MW
			Heat Pump maximum share
			0,50
			Maximum import/export
			2500 MW
			Distr. Name :
			Price_DKV_2005.txt
			Addition factor
			60,00 DKK/MWh
			Multiplication factor
			1,04
			Dependency factor
			0,02 DKK/MWh pr. MW
			Average Market Price
			349 DKK/MWh
			Gas Storage
			0 GWh
			Syngas capacity
			0 MW
			Biogas max to grid
			0 MW
			Fuel Price level:
			Capacities Storage Efficiencies
			MW-e GWh elec. Ther.
			Hydro Pump:
			0 0 0,40
			Hydro Turbine:
			0 0 0,40
			Electrol. Gr.2:
			0 0 0,40 0,50
			Electrol. Gr.3:
			0 0 0,40 0,50
			Electrol. trans.:
			0 0 0,80
			Ely. MicroCHP:
			0 0 0,80
			CAES fuel ratio:
			0,000
			(TWh/year) Coal Oil Ngas Biomass
			Transport 0,00 69,20 0,00 0,00
			Household 0,01 6,72 9,05 7,29
			Industry 3,37 26,92 18,19 5,18
			Various 0,00 3,01 19,73 0,00

Output		Denmark2030Reference.txt	The EnergyPLAN model 12.0
District Heating		Consumption	
Demand	Production	Electricity	
Distr. heating MW	Solar MW	Waste+ CSHP MW	DHP MW
		CHP MW	HP MW
		ELT MW	Boiler MW
		EH MW	Bal. MW
		Elec. demand MW	Flex. MW
		Trans. MW	HP MW
		Elect. MW	EH MW
		Hydro Pump MW	Tur- MW
		RES MW	Hy- MW
		Geo- MW	Waste+ MW
		CSHP MW	CHP MW
		PP MW	Stab- MW
		Exp MW	Imp MW
		CEEP MW	EEP MW
January 7177	1 197 413 3973	40 0 2553	0 0 6305
February 7343	2 197 422 4031	40 0 2652	0 0 6237
March 6256	2 197 359 4063	40 0 1595	0 0 6004
April 5013	3 197 286 3984	40 0 556	0 -53 5129
May 3933	3 197 223 3346	40 0 90	0 34 5162
June 1782	3 197 100 1404	40 0 66	0 -28 5017
July 1782	4 197 99 1385	40 0 66	0 -9 4574
August 1782	3 197 100 1383	40 0 66	0 -7 5263
September 2736	3 197 155 2275	40 0 66	0 0 5401
October 4076	2 197 234 3433	40 0 142	0 28 5602
November 5347	1 197 307 4012	40 0 757	0 33 6054
December 6385	1 197 368 4028	40 0 1751	0 0 6056
Average 4460	2 197 255 3107	40 0 859	0 0 5578
Maximum 12535	28 197 723 4088	40 0 7487	0 4486 8603
Minimum 1561	0 197 76 549	40 0 66	0 -1491 2795
TWh/year 39,18	0,02 1,73 2,24 27,29	0,35 0,00 7,55 0,00	0,00 0,00 14,87 0,00
FUEL BALANCE (TWh/year):	DHP	CHP2	Boiler2
Coal	0,04	2,54	3,58
Oil	0,83	0,57	0,80
N.Gas	0,67	11,79	16,59
Biomass	1,06	7,35	11,37
Renewable	-	-	-
H2 etc.	0,00	0,00	0,00
Biofuel	-	0,00	-
Nuclear/CCS	-	-	-
Total	2,60	22,25	32,35

Output specifications		Denmark2030Reference.txt	The EnergyPLAN model 12.0
District Heating Production		RES specification	
Gr.1	Gr.2	Gr.3	RES1 RES2 RES3
District heating MW	Solar MW	CSHP MW	CHP MW
		HP MW	ELT MW
		Boiler MW	EH MW
		Bal. MW	Stor- MW
		age MW	Bal- MW
		age MW	ance MW
January 414	1 0 413	2618	0 0 1630
February 424	2 0 422	2578	0 0 1647
March 361	2 0 359	2282	0 0 1647
April 289	3 0 286	1829	0 0 1618
May 227	3 0 223	1435	0 0 1319
June 103	3 0 100	650	0 0 595
July 103	4 0 99	650	0 0 578
August 103	3 0 100	650	0 0 576
September 158	3 0 155	998	0 0 917
October 235	2 0 234	1486	0 0 1391
November 308	1 0 307	1950	0 0 1646
December 368	1 0 368	2329	0 0 1645
Average 257	2 0 255	1627	0 0 1266
Maximum 723	28 0 723	4572	0 0 1647
Minimum 90	0 0 76	569	0 0 40
Total for the whole year	2,26 0,02 0,00 2,24	14,29 0,00 0,00 11,12	0,35 0,00 2,81 0,00
TWh/year			
Own use of heat from industrial CHP:	0,00 TWh/year		
NATURAL GAS EXCHANGE			
ANNUAL COSTS (Million DKK)			
Total Fuel ex Ngas exchange	47040		
Uranium	0		
Coal	1059		
FuelOil	7741		
Gasoil/Diesel	13572		
Petrol/UP	17399		
Gas handling	1611		
Biomass	5659		
Food income	0		
Waste	0		
Total Ngas Exchange costs	15911		
Marginal operation costs	850		
Total Electricity exchange	-1093		
Import	1174		
Export	-2176		
Bottleneck	-91		
Fixed impexp	0		
Total CO2 emission costs	8271		
Total variable costs	70979		
Fixed operation costs	4947		
Annual Investment costs	11363		
TOTAL ANNUAL COSTS	87289		
RES Share:	18,7 Percent of Primary Energy 46,1 Percent of Electricity 22,6 TWh electricity from RES		

9.3. Graphics

Results can be shown graphically and exported by the clipboard function.

By activating the Graphics tab sheet, the results are illustrated graphically on the basis of the hourly values.

Three choices are offered by activating the buttons in the upper left corner of the button section: the electricity balance, the district heating balance, and the grid gas electricity demand. For district heating, one can choose to see either one of the three groups or a sum of all of them. Three diagrams are shown for each of the items.

The diagrams can be shown either for one day, three days, one week, one month or the whole year.

The diagrams can be shown either in colour or as monochrome (black and white).

The results can be shown for all periods of the year by activating the two buttons "Forward" and "Back".

Also, the diagrams can be exported by clicking on the "clipboard" button located in the upper right corner of each diagram.

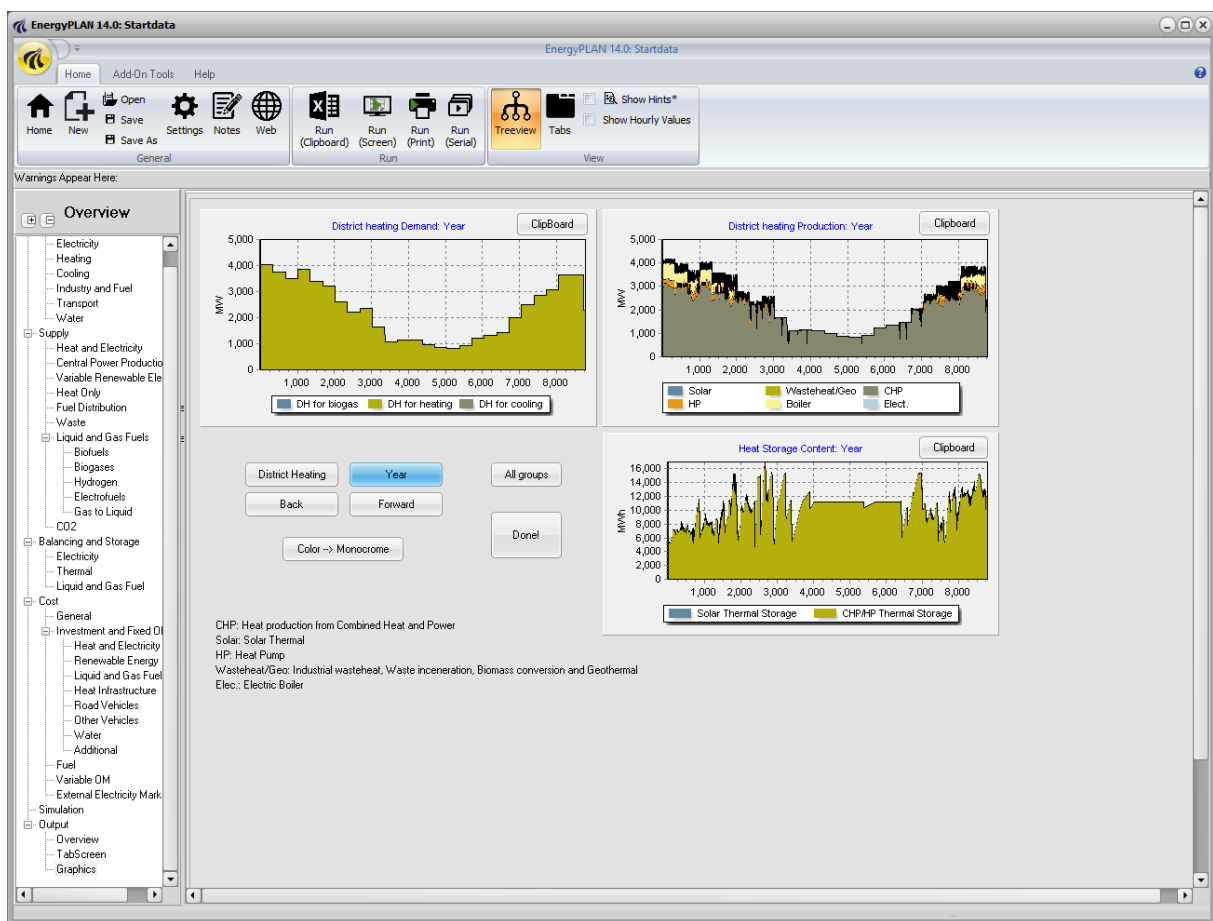

Diagram 6: Example of graphical presentations of results

9.4. Run serial calculations function

Run serial calculations to clipboard:

To run series of calculations and save main results set the following button to "On" and chose input and output below:

Define input Chose number of calculations (maximum 11):

Input values

Define output TWh/year

Start calculations to:

Start calculations to:

Moreover, the output tab sheet makes it possible to run series of up to nine or eleven calculations by activating the "Run series calculations". The calculations are started by activating either the "Clipbrd" or the "Ascii" buttons. In the first case, the results are put into the clipboard and can be exported to any Windows programme such as Word or Excel by the Ctrl+V function.

Before starting the series calculations, one must

- define which input parameters are to be changed by activating the "Define input" button
- define how many calculations are to be carried out by activating the button "Choose number of calculations"
- define a value of each input by stating inputs in the "input values" column, and
- define which output parameter one wants to save in the Clipbrd/Ascii function by activating the "define output" button.

9.5. Export Screen Data to Clipboard and e.g. Excel

The same results which are shown in the screen function (defined by the user as described in section 9.1) can also be exported to the clipboard and thereby to, e.g., Excel.

This is simply done by setting the run serial button at "Off" and activating the clipboard function in the Output overview tab sheet:

Run serial calculations to clipboard:

To run series of calculations and save main results set the following button to "On" and chose input and output below:

Define input Chose number of calculations (maximum 11):

Input values

Define output TWh/year

Start calculations to:

Start calculations to:

10. Business-economic optimisation of CAES plants

In general, the EnergyPLAN model has a focus on system analysis, i.e., the analysis of national or regional energy systems. However, the model also enables a business-economic analysis of individual plants in the case of electricity storage systems with a special focus on CAES (Compressed Air Energy Storage) plants.

The business-economic analysis can be done by activating the button “Advanced CAES” in the Input Storage tab sheet. The tab sheet will look like shown here:

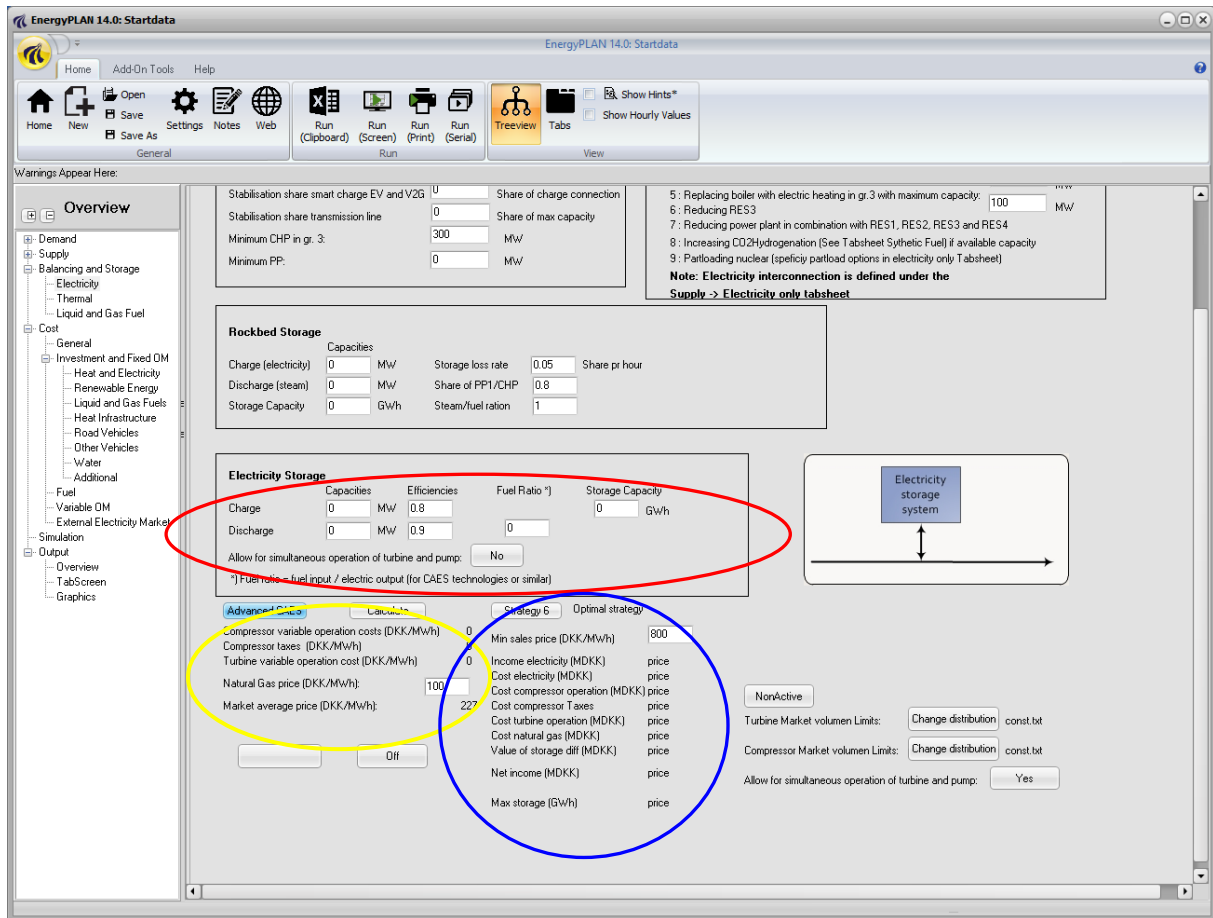

The main technical input variables can be defined in the area marked in red. Such input variables are already described in chapter 4.4.

The main financial inputs are shown in the lower left area marked in yellow. Except from the fuel costs, the inputs are imported from other tab sheets. The pump and turbine operational costs reflect the variable entered in the Cost Operation tab sheet, whereas the average electricity price reflects the average of the price time series entered in the ‘Balancing & Storage->Electricity’ tab sheet.

The main operational results are shown as output in the lower middle part marked in blue. These results include electricity consumption and production costs, operational costs, fuel costs, the net income, and the maximum utilised storage capacity. Besides, certain strategy-specific variables are

entered in the box above this area. For example, the maximum number of iterations in strategy 6 and the projected period in strategy 4 are entered in this area.

In the upper part of the area marked in blue, one can choose between the following three operation strategies:

- Strategy 4: Practical prognosis strategy
- Strategy 5: Practical historical strategy
- Strategy 6: Optimal Strategy (Theoretically optimal solution)

Strategy 6 identifies the theoretically optimal strategy, i.e., the strategy which will identify the highest possible net operational income of a year given the specified input. The two other strategies represent practicable solutions.

10.1. Theoretically optimal strategy

The method used for identifying the optimal operation strategy is the following:

The key principle is based on the fact that in order to make a profit, the market price of selling, P_{sell} , must be higher than the marginal cost of producing one unit of electricity, MC_{prod} :

$$MC_{\text{prod}} < P_{\text{sell}}$$

The marginal production cost is defined by the marginal operational cost, the natural gas price, and the price of buying electricity for the compressor. MC_{prod} , is found by applying the following formula:

$$MC_{\text{prod}} = P_{\text{Ngas}} * \eta_{\text{ratio}} + MC_{\text{t}} + [(P_{\text{buy}} + MC_{\text{c}}) / (\eta_{\text{c}} * \eta_{\text{t}})]$$

In which

- η_{c} is the compressor efficiency
- η_{t} is the turbine storage efficiency defined as the power output per unit of energy storage input.
- η_{ratio} is the fuel ratio defined as the fuel input to the turbine per electricity output
- MC_{c} is the variable operational cost of the compressor
- MC_{t} is the variable operational cost of the turbine
- P_{Ngas} is the natural gas price
- P_{buy} is the price of electricity for the compressor.

At some hours with very high electricity prices, it may pay to bypass the storage while operating the compressor and the turbine at the same time. Such operation is included in the strategy and allows the compressor and turbine to operate simultaneously during the same hour, in case the storage reservoir is empty.

The optimal operation strategy aims at finding the maximum theoretical operational income given a deterministic annual electricity price time series. The algorithm can be summarised by repeating the following 7 steps:

- 1) Identify the hour with the **maximum electricity price** (MAXhour) in the spot market price series. Such hour is given priority when operating the turbine. (In the following iterations, hours already identified are disregarded and the hour of the remaining maximum price is used).

- 2) Identify the **storage boundaries** around MAXhour. Running the turbine at MAXhour will have to be compensated for by running the compressor in such a way that the storage boundaries are not compromised. In this step, the hours before and after MAXhour are examined. In the time period after MAXhour, the storage must be charged before the storage reservoir is empty. Similarly, in the time period before MAXhour, the storage reservoir must be charged when it is full. Consequently, the period between the last hour of full storage before MAXhour and the first hour of empty storage after MAXhour is identified. This range constitutes the time space in which recharging/discharging is possible. The range can very well constitute only the MAXhour itself, in which case the plant may operate in the bypass mode.
- 3) Identify the **minimum electricity price** within the range defined in step 2. Such hour is given priority when operating the compressor. (In the following iterations, hours already identified are disregarded and the hour of the remaining minimum price is used).
- 4) Calculate the **marginal operational cost** (MC_{prod}) based on the minimum price (P_{buy}) found in step 3. The marginal production cost (MC_{prod}) is calculated according to the equation described above. If the maximum electricity price (P_{sell}) found in step 1 is higher than the marginal production cost (MC_{prod}), the calculation proceeds to step 5.
- 5) Determine the “**operation bottlenecks**” in the range between the maximum and minimum prices. In the case that one hour of compressor operation is compensated for by exactly one hour of turbine operation, there is no bottleneck. Otherwise, the turbine and/or the compressor may have to partly load and the bottleneck is identified as the minimum of the following 4 considerations:
 - a. Available turbine capacity at the maximum price hour.
 - b. Available compressor capacity at the minimum price hour.
 - c. The minimum free storage space if the compressor operation takes place before the turbine operation.
 - d. The minimum storage content in case the compressor operation succeeds the turbine operation.
- 6) **Operate the turbine** at the hour of maximum price **and the compressor** at the hour of minimum price by the capacity determined in step 5 **and update the storage content**. In the case that the turbine has reached its full capacity, the hour is disregarded in the subsequent iterations. The same is the case if the compressor has reached its full capacity.
- 7) Iterate back to step 1 until the period of one year is completed.

To illustrate the algorithm of the strategy, an example is shown in diagram 10.1 for a CAES plant comprised by a 216 MW compressor, a 360 MW turbine, and a 1478 GWh storage. In such system, the rates of air compression and expansion are equal. This permits an equal number of compression and expansion hours, and such case is presented here for illustration purposes. The algorithm is, however, capable of dealing with unequal compression and expansion rates.

Diagram 10.1 shows the Nord Pool 2005 electricity prices (upper diagram) used in the simulation of the CAES plant operation during various iterations (the next three diagrams). After the first iteration, it is seen that the maximum price is reached around hour 4000, and the turbine is operated during that hour. The compressor is operated during the minimum price hour (in this case hour 32) within the time range that does not violate the storage constraint (in this case all hours before hour 4000).

After 18 iterations (next diagram), the turbine is operated at the 18 hours with the highest prices, while the compressor operates at the 18 hours with the lowest prices. In year 2005, the lowest price hours were concentrated at the beginning of the year.

After 100 iterations (last diagram), the CAES plant operation is distributed throughout the year, as the price maximums and minimums are utilised. Please, note the correlation between the operation hours and the electricity prices at the top of the figure. The simulation continues until all hours with feasible operation prices are utilised.

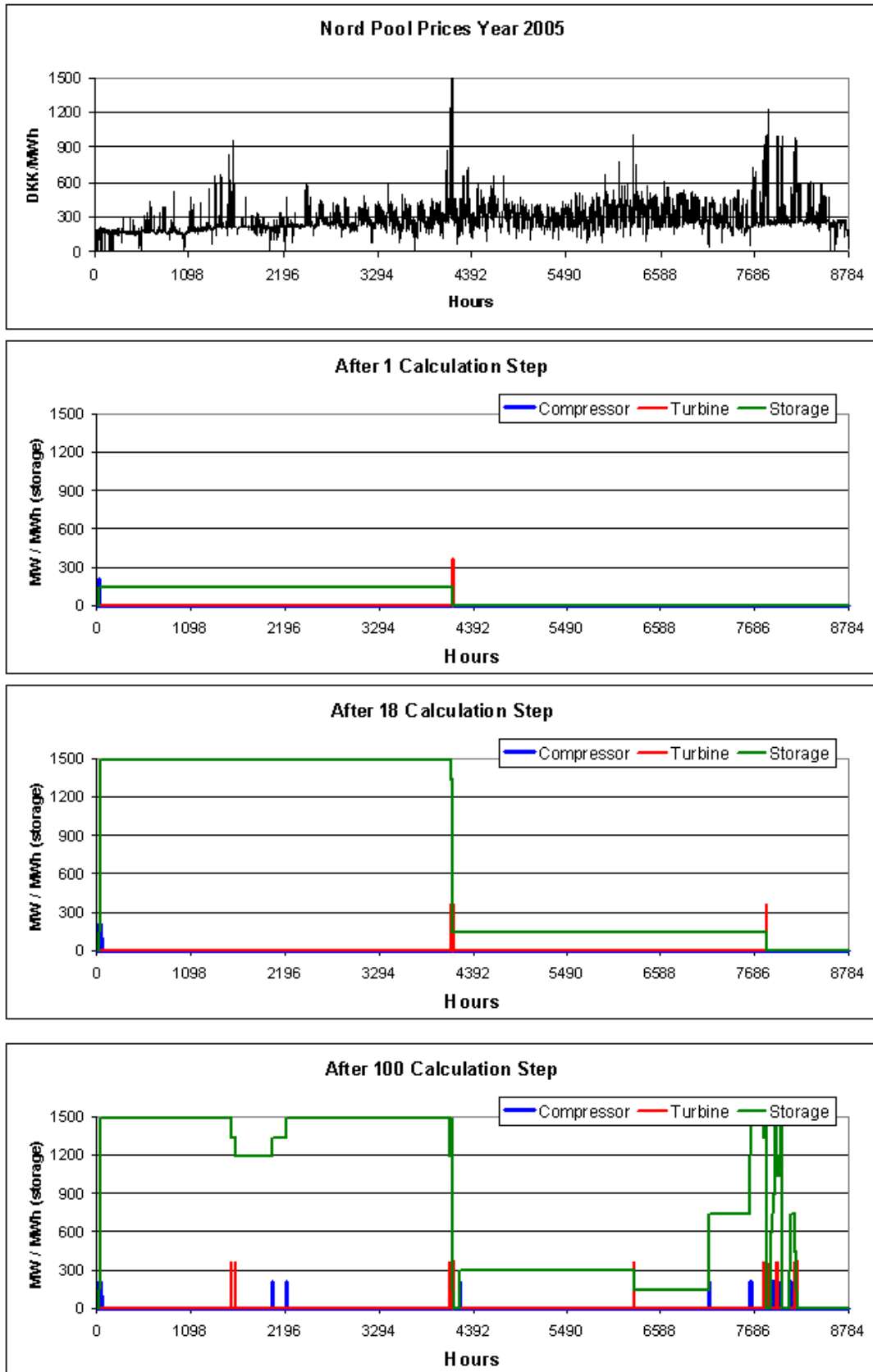

Diagram 10.1: NordPool electricity prices for 2005 and CAES plant operation after various iterations in the EnergyPLAN strategy algorithm.

10.2. Practical operation strategies

In practice, CAES plants will not be able to implement the above-mentioned optimal operation strategies, since the fluctuations of spot market prices in future hours and days are not known for a whole year. However, the EnergyPLAN model includes two additional strategies, which can be implemented:

- **Practical historical strategy**, in which decisions on buying and selling electricity are based on the knowledge of the average price over some historical and future period. For example, for strategy 5, if 24 hours is the “Average Period”, then the simulation uses 11 historical hours, the present hour, and 12 future hours.
- **Practical prognostic strategy**, in which buying and selling electricity are based on the average price of the coming hours, e.g., 24 hours. Such a strategy requires the presence of good price prognoses.

The prognostic strategy is based on the concept of bidding on the market according to the average price of an upcoming user-specified period. The bid on the market occurs in such way that the price difference between the buying and bidding prices is equally distributed around the average price. Figure 4 demonstrates this concept for a 24-hour period. The centre line represents the price average for the shown 24-hour period. Based on that, the distances to the two other lines are calculated.

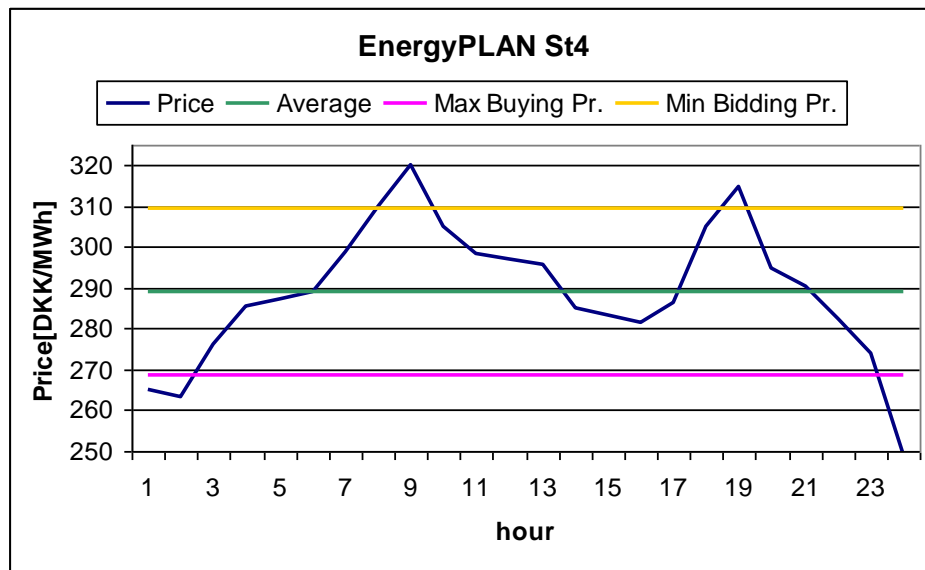

Diagram 10.2: EnergyPLAN practical prognostic concept, where the average of an upcoming period, 24 hours in this figure, is used to calculate the market bidding prices.

The distance between the minimum/maximum lines and the average price, ΔP , can be calculated analytically using the following equation:

$$\Delta P = \frac{\bar{P}(1 - \eta_c \eta_T) + K}{1 + \eta_c \eta_T}$$

Where \bar{P} is the average price over the given period and K is a constant that includes the variable operational costs and fuel costs:

$$K = MC_c + \eta_c \eta_t (\eta_{ratio} * P_{Ngas} + MC_t)$$

It is noted here that the price average, \bar{P} , is a flexible average and is updated on an hourly basis, as opposed to a fixed average over the specified period. This implicitly assumes the ability of the system operator to update market bids on an hourly basis. Again, the bypass of the storage at hours with very high electricity prices is included in the strategy and allows the compressor and turbine to operate simultaneously during the same hour, in case the storage reservoir is empty.

The practical historical strategy is similar to the prognostic strategy with the only difference that the average price is based on the previous 12 hours and future 12 hours instead of a price prognosis for the upcoming 24 hours. Also, the define your own strategy operates in the same way except decisions on buying and selling electricity are solely based on the knowledge of a user defined number of historical and future hours. Firstly, the number of historical hours to use is specified and secondly, the total range of hours to use is defined. For example, in the figure below, the simulation uses the 10 hours before the present hour and considers a 24 hour range. Hence, decisions are based on 10 historical prices and 13 future prices (including the present hour, that sums to 10 historical + Present Hour + 13 Future Hours = 24 hours).

Strategy 8		Define your own hours	
Starthour(prior to x) no. of hours	<input type="text" value="10"/>	<input type="text" value="24"/>	
Income electricity (MDKK)		price	
Cost electricity (MDKK)		price	
Cost compressor operation (MDKK)		price	
Cost compressor Taxes		price	
Cost turbine operation (MDKK)		price	
Cost natural gas (MDKK)		price	
Value of storage diff (MDKK)		price	
Net income (MDKK)		price	

Finally, it is planned to include an option in which the “*Optimal Strategy 24 Hours*” operates in the same way as the Optimal strategy described in section 10.1. However, instead of optimising the energy storage facility over the whole year, it only optimises the energy storage over 1 day. After a day has been completed, the optimisation moves to the next day until eventually the entire year is complete. To use this strategy, good price prognosis is required. Compared to the *24 Prognostic Strategy*, which updates itself every hour by assuming an intra-day market, this strategy optimises itself over 1 full day at a time, which requires good price prognosis. However, this strategy has not been implemented yet.

11. List of Error Messages

1.

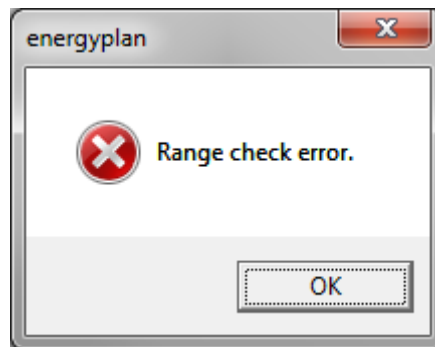
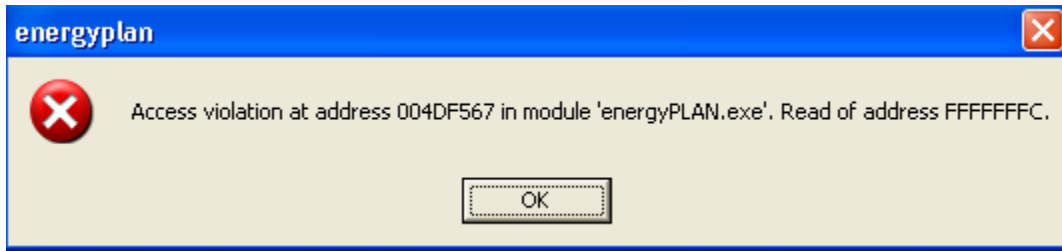

One of the distribution files has too many or too few lines.
It must have exactly 8784 lines with exactly one value in each (see section 3.2.2).

2.

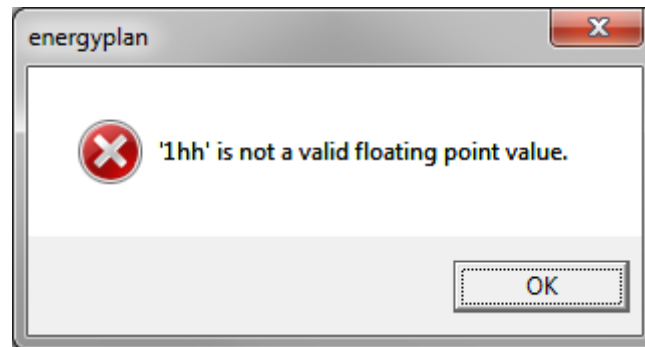

One of the values in one of the distribution files contains letters instead of numbers. In this case, "335,0hh" should be replaced by "335,0" or "335.0".

3.

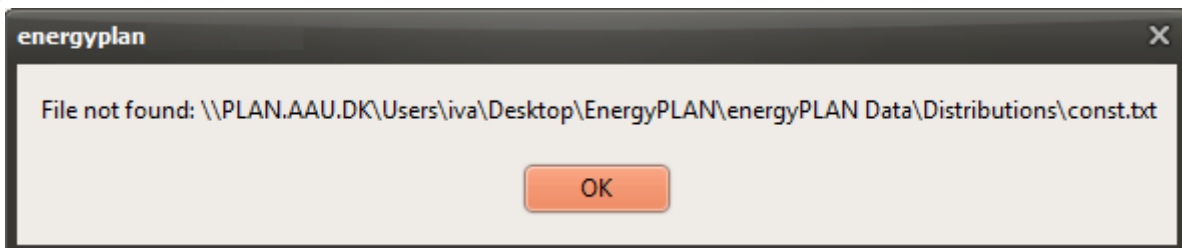

The stated distribution file (in this case “Wind_WestDK2009”) cannot be found in the distribution library. Such error typically appears if one receives a data file from another person who has designed new distribution files. You can either change the files to existing files or get the missing files and place them in the distribution library.

This error may also appear if you have replaced a version 9 (or lower) with a version 10 (or higher) of the EnergyPLAN model without making an “EnergyPlan Data” directory to host the three data directories as subdirectories (See item 5 next page).

4.

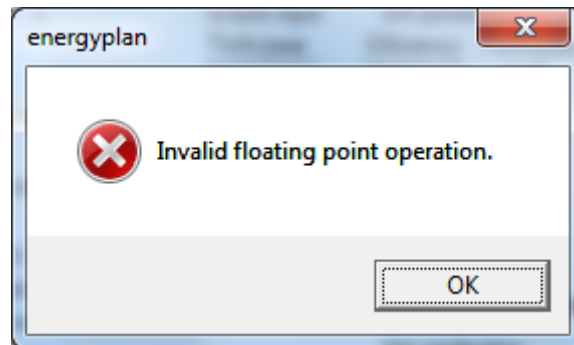

The calculation has been interrupted because of division by zero. Please, check if you have recently changed an input (e.g., to zero) and replace with a small number like 0.0001 instead and see if this helps. Moreover, please send a note to the following email: lund@plan.aau.dk, giving as much information as possible about the error and the cause. We try to avoid such failure from happening by making the necessary change in the tool.

5. The name of the input data file is not showing in the upper left corner of programme and the print.

Input		PLAN				
Electricity demand (TWh/year):	Flexible demand	2,70				Group 2:
Fixed demand	31,74	Fixed Implexp.	0,00			CHP
Electric heating	0,00	Transportation	0,00			Heat Pump
Electric cooling	0,00	Total	34,44			Boiler
District heating (TWh/year)	Gr.1	Gr.2	Gr.3	Sum		Group 3:
District heating demand	2,96	11,09	24,34	38,39		CHP
Solar Thermal	1,25	1,39	0,61	3,24		Heat Pump
Industrial CHP (CGHP)	0,00	0,00	2,65	2,65		Boiler
Demand after solar and CGHP	1,71	9,70	21,08	32,50		Condensing

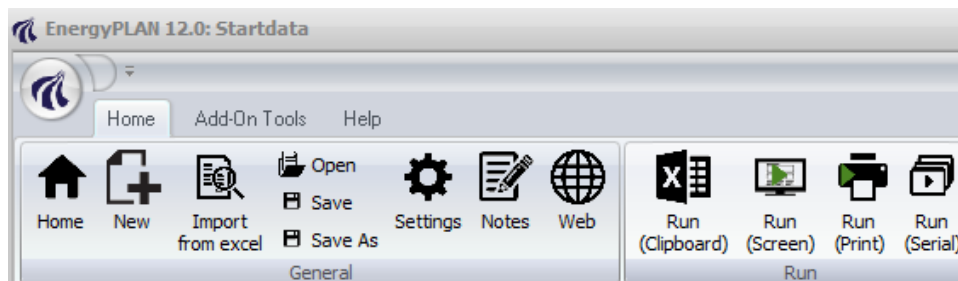

This may be because you make use of the Windows Offline Files feature on your computer (see <http://www.windows7update.com/Windows7-Offline-Files.html>). You will then have to make sure that all units (as unpacked from the original Zip file) are located and being operated from the same hard desk.

As described in chapter 3, the model is organised as an executable file and three libraries: Data, Distributions and Cost, which have to be organised in the following way. To avoid this failure make sure everything is operated from the same hard desk.

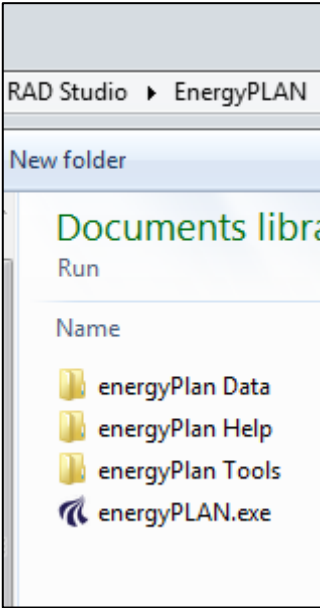

12. List of Warning Messages

A number of different input combinations will create an error in the EnergyPLAN tool. If this occurs, a warning is created by EnergyPLAN outlining the type of error. The warnings are shown in three different places:

First, they are shown in the lower left corner of the input Tab sheets. In many cases, this enables the user to consider the error before the calculation is done:

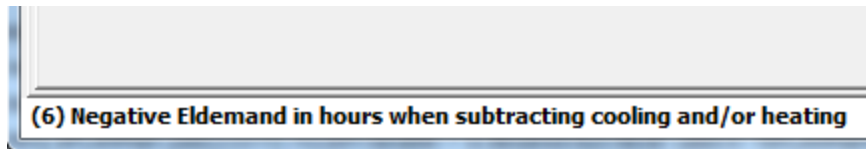

Additionally, the warnings will appear on the output print, as shown below, as well as at the top of the output screen (if one has chosen to see the output on the screen).

Hydrogen		0 MW	0 TWh/year	0.00	0.00	Gr.1:	0.00	0.00	Gas Storage	0 MW	Indu														
Hydro Power	0 MW	0 TWh/year		Gr.2:	0.00	0.00		Syngas capacity	0 MW	Vari															
Geothermal/Nuclear	0 MW	0 TWh/year		Gr.3:	0.00	0.00		Biogas max to grid	0 MW																
Output WARNING!!: (1) Critical Excess; (4) Syn/biogas shortage (6) Negative Eldemand																									
District Heating										Electricity															
Demand	Production									Consumption			Production				Stab-	Imp							
Distr. heating MW	Solar MW	Waste+ CSHP MW	DHP MW	CHP MW	HP MW	ELT MW	Boiler MW	EH MW	Ba-lance MW	Elec. demand MW	Flex.& Transp. MW	HP MW	Elec-trolyser MW	EH MW	Hydro Pump MW	Tur-bine MW	RES MW	Hy-dro thermal MW	Geo-thermal MW	Waste+ CSHP MW	CHP MW	PP MW	Stab-Load %	Imp MA	
January	3856	0	0	0	2978	203	0	678	0	-3	1635	0	68	1087	0	0	0	472	0	0	0	2382	173	172	
February	3644	0	0	0	2866	207	0	572	0	-1	1517	0	69	1087	0	0	0	450	0	0	0	2293	114	164	
March	3140	0	0	0	2606	223	0	320	0	-9	1147	0	74	1087	0	0	0	356	0	0	0	2085	38	151	

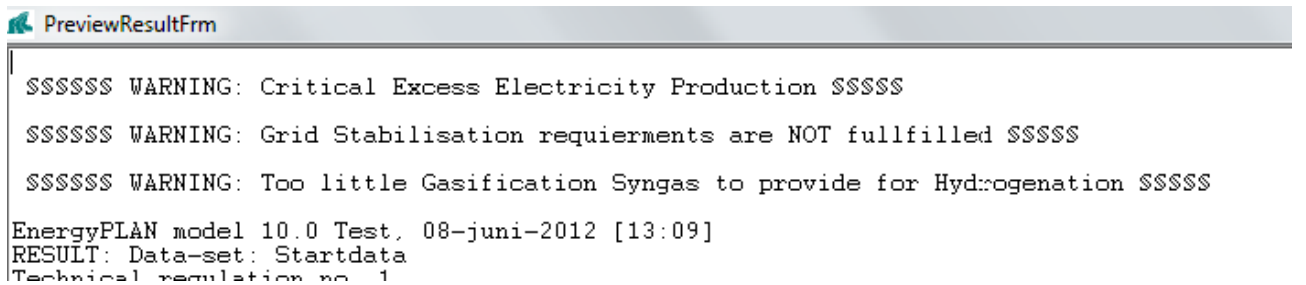

The following warnings are included:

(1) Critical Excess:

This warning appears if the excess production of electricity during one hour or more exceeds the capacity of the transmission line out of the system; this is known as critical excess electricity production (CEEP). If such critical excess production appears, the electricity supply system will not be able to operate. To avoid this, one may want to activate one or more of the CEEP strategies available in the “Balancing & Storage->Electricity” tab sheet. Conversely, one may not want to avoid it in the analysis so it is possible to calculate the size of it.

(2) Grid Stab. Problem:

This warning appears if the electricity production during one hour or more does not meet the input requirements specified in the 'Balancing & Storage->Electricity' tab Sheet. EnergyPLAN divides the electricity producing units into two types: those that play and those that do not play an active role in the task of grid stabilization. For example, they may be part of supplying regulating power and primary automatic reserve. EnergyPLAN assumes by default that large CHP and Power Plants in group 3 have such abilities. In the 'Balancing & Storage->Electricity' Tab Sheet and the Renewables Tab sheet, one can specify to which extent this is also the case of small CHP plants in group 2, V2G, and Wind Power. Moreover, it is possible to specify the minimum share of the total electricity production that should come from the active units (in the 'Balancing & Storage->Electricity' tab sheet). If this minimum share is not met during one or more hours, the model will give this warning.

(3) PP/Import problem:

If there is not enough capacity to meet the electricity demand, EnergyPLAN will import the electricity. However, if the import during one or more hours exceeds the capacity of the transmission line, this warning will appear. To avoid this, one must either add more electricity production capacity (by increasing PP for example) or increase the capacity of the transmission line.

(4) Syn/biogas shortage:

This warning appears if one (in the SyntheticFuel Tab Sheet) has specified a demand for either Biogas or Syngas from Gasification which exceeds the supply on an annual basis. To avoid this situation, one must either lower the demand and/or increase the production in the BiomassConversion Tab sheet.

(5) V2G connection too small

This warning is displayed if one has specified an electricity demand for electric vehicles such as EV or V2G in the Transportation Tab sheet which cannot be supplied with the specified charging connection. To avoid this situation, one must either lower the electricity demand or increase the charging capacity.

(6) Negative Eldemand:

In the ElecDemand Tab Sheet, the electricity demand for heating/cooling is subtracted from the total 'Electricity demand' using the distributions provided. Depending on the distributions used and the annual totals, this subtraction may cause negative hourly values during one or more hours: During such hours, EnergyPLAN will adjust the demand to zero and, consequently, the subtraction of electricity will not match on an annual basis. When this occurs, this warning will appear, and to avoid this, one must make sure that the annual demands and the distribution files specified are designed in such a way that this problem is not generated.

Transport Electrolyser is too small. Must be xx MW

This warning appears if one has specified a demand for hydrogen without specifying a sufficient capacity (and storage) for hydrogen production. The demand for hydrogen can be specified either for

transportation in the Transportation Tab Sheet and/or for Hydrogenation in the SyntheticFuel Tab Sheet. To avoid this problem, one must do one of the following: lower the demand for hydrogen and/or increase the capacity of the electrolyzers and/or increase the hydrogen storage in the ElecStorage Tab Sheet. Please, note that EnergyPLAN calculates the hourly hydrogen demands using the specified distribution for transportation. As a consequence, one may be able to lower the electrolyser capacity required by adding or increasing the capacity of the hydrogen storage.

Indv. CHP Electrolyser is too small. Must be xx MW

This warning appears if one (in the Individual Tab Sheet) has specified a demand for hydrogen for micro CHP without specifying a sufficient capacity (and storage) for hydrogen production. To avoid this problem, one must either lower the demand for hydrogen and/or increase the capacity of the electrolyser and/or the hydrogen storage in the ElecStorage Tab Sheet. Please, note that EnergyPLAN calculates the hourly demands for hydrogen using the individual heat demand distribution for micro CHPs. As a consequence, one may be able to lower the electrolyser capacity required by adding or increasing the capacity of the hydrogen storage.