

# Intelligent Environments 2020

*Workshop Proceedings of the 16th International  
Conference on Intelligent Environments*

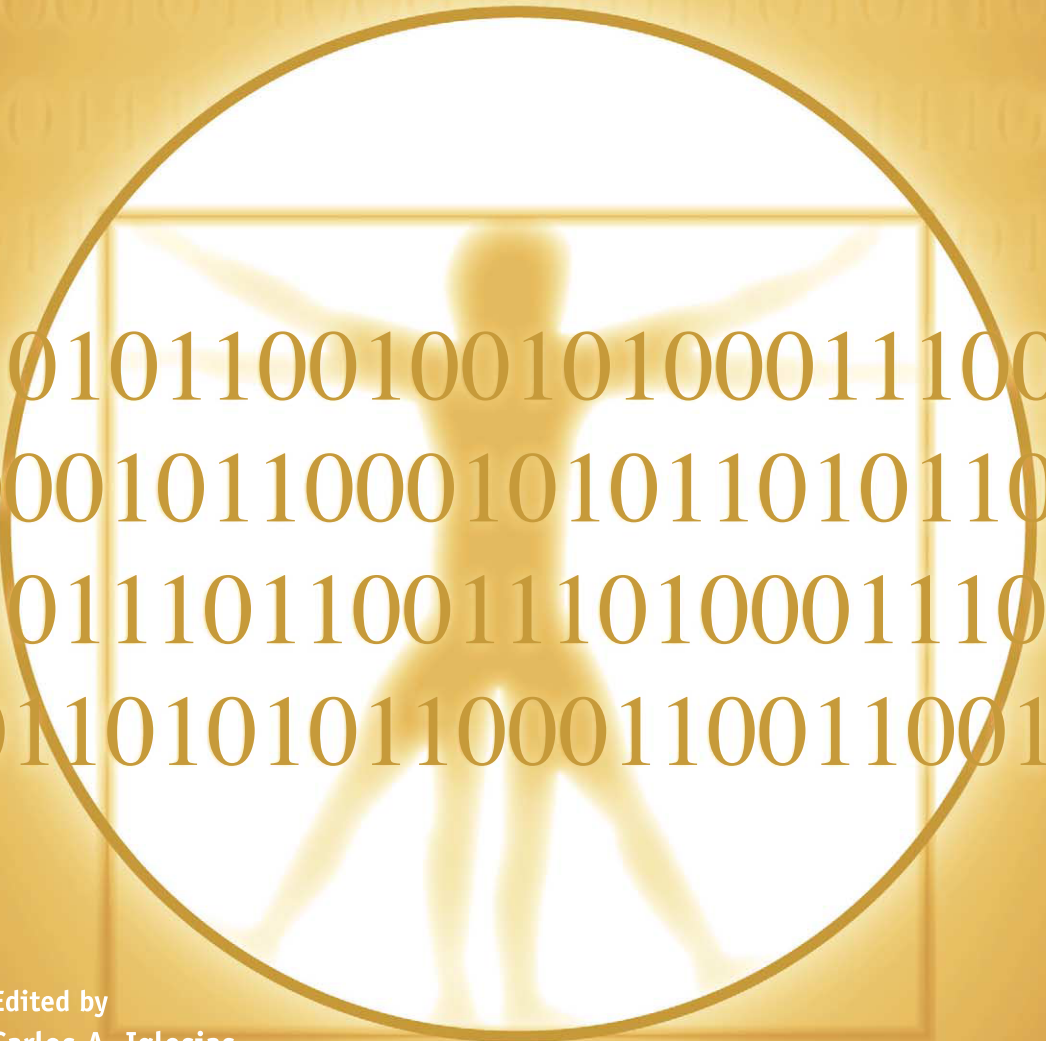

Edited by  
Carlos A. Iglesias  
Jose Ignacio Moreno Novella  
Alessandro Ricci  
Diego Rivera Pinto  
Dumitru Roman

**IOS**  
Press

# Intelligent Environments 2020

Intelligent Environments (IEs) aims to empower users by enriching their experience, raising their awareness and enhancing their management of their surroundings. The term IE is used to describe the physical spaces where ICT and pervasive technologies are used to achieve specific objectives for the user and/or the environment. The growing IE community, from academia and practitioners, is working on the materialization of IEs driven by the latest technological developments and innovative ideas.

This book presents the proceedings of the workshops held in conjunction with the 16th International Conference on Intelligent Environments (IE2020), Madrid, Spain, 20-23 July 2020. The conference focused on the development of advance intelligent environments, as well as newly emerging and rapidly evolving topics. The workshops included here emphasize multi-disciplinary and transverse aspects of IE, as well as cutting-edge topics: 10th International Workshop on Intelligent Environments Supporting Healthcare and Well-being (WISHWell'20); 9th International Workshop on the Reliability of Intelligent Environments (WoRIE2020); 4th International Workshop on Legal Issues in Intelligent Environments (LIIE'20); 4th International Workshop on Intelligent Systems for Agriculture Production and Environment Protection (ISAPEP'20); 4th International Workshop on Citizen-Centric Smart Cities Services (CCSCS'20); 2nd International Workshop on Intelligent Environments and Buildings (IEB'20); 1st International Workshop on Research on Smart Grids and Related Applications (SGRA'20); 1st International Workshop on Open and Crowdsourced Location Data (ISOCLoD'20); 1st International Workshop on Social Media Analysis for Intelligent Environment (SMAIE'20).

The proceedings contain contributions reflecting the latest research developments in IEs and related areas, focusing on stretching the borders of the current state of the art and contributing to an ever-increasing establishment of IEs in the real world. It will be of interest to all those whose work involves the design or application of Intelligent Environments.

ISSN 1875-4163 (print)

ISSN 1875-4171 (online)

ISBN 978-1-64368-090-3 (print)

ISBN 978-1-64368-091-0 (online)

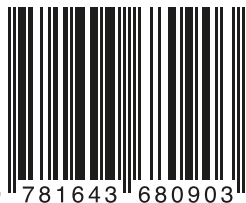

# INTELLIGENT ENVIRONMENTS 2020

# Ambient Intelligence and Smart Environments

The Ambient Intelligence and Smart Environments (AISE) book series presents the latest research results in the theory and practice, analysis and design, implementation, application and experience of *Ambient Intelligence* (AmI) and *Smart Environments* (SmE).

Coordinating Series Editor:  
Juan Carlos Augusto

Series Editors:  
Emile Aarts, Hamid Aghajan, Michael Berger, Marc Bohlen, Vic Callaghan, Diane Cook, Sajal Das, Anind Dey, Sylvain Giroux, Pertti Huuskonen, Jadwiga Indulska, Achilles Kameas, Peter Mikulecký, Andrés Muñoz Ortega, Albert Ali Salah, Daniel Shapiro, Vincent Tam, Toshiyo Tamura, Michael Weber

## Volume 28

*Recently published in this series*

- Vol. 27. J.L. Hernández Ramos and A. Skarmeta (Eds.), Security and Privacy in the Internet of Things: Challenges and Solutions
- Vol. 26. A. Muñoz, S. Ouhbi, W. Minker, L. Echabbi and M. Navarro-Cía (Eds.), Intelligent Environments 2019 – Workshop Proceedings of the 15th International Conference on Intelligent Environments
- Vol. 25. M. Vega-Barbas and F. Seoane (Eds.), Transforming Ergonomics with Personalized Health and Intelligent Workplaces
- Vol. 24. A. Muñoz and J. Park (Eds.), Agriculture and Environment Perspectives in Intelligent Systems
- Vol. 23. I. Chatzigiannakis, Y. Tobe, P. Novais and O. Amft (Eds.), Intelligent Environments 2018 – Workshop Proceedings of the 14th International Conference on Intelligent Environments
- Vol. 22. C. Analide and P. Kim (Eds.), Intelligent Environments 2017 – Workshop Proceedings of the 13th International Conference on Intelligent Environments
- Vol. 21. P. Novais and S. Konomi (Eds.), Intelligent Environments 2016 – Workshop Proceedings of the 12th International Conference on Intelligent Environments
- Vol. 20. W. Chen et al. (Eds.), Recent Advances in Ambient Assisted Living – Bridging Assistive Technologies, e-Health and Personalized Health Care
- Vol. 19. D. Preuveneers (Ed.), Workshop Proceedings of the 11th International Conference on Intelligent Environments
- Vol. 18. J.C. Augusto and T. Zhang (Eds.), Workshop Proceedings of the 10th International Conference on Intelligent Environments

ISSN 1875-4163 (print)  
ISSN 1875-4171 (online)

# Intelligent Environments 2020

Workshop Proceedings of the 16th International Conference on  
Intelligent Environments

Edited by

**Carlos A. Iglesias**

*Universidad Politécnica de Madrid, Spain*

**Jose Ignacio Moreno Novella**

*Universidad Politécnica de Madrid, Spain*

**Alessandro Ricci**

*Universita di Bologna, Italy*

**Diego Rivera Pinto**

*Universidad Politécnica de Madrid, Spain*

and

**Dumitru Roman**

*SINTEF AS and University of Oslo, Norway*

**IOS**  
Press

Amsterdam • Berlin • Washington, DC

© 2020 The authors and IOS Press.

This book is published online with Open Access and distributed under the terms of the Creative Commons Attribution Non-Commercial License 4.0 (CC BY-NC 4.0).

ISBN 978-1-64368-090-3 (print)  
ISBN 978-1-64368-091-0 (online)  
doi: 10.3233/AISE28

*Publisher*

IOS Press BV  
Nieuwe Hemweg 6B  
1013 BG Amsterdam  
Netherlands  
fax: +31 20 687 0019  
e-mail: [order@iospress.nl](mailto:order@iospress.nl)

*For book sales in the USA and Canada:*

IOS Press, Inc.  
6751 Tepper Drive  
Clifton, VA 20124  
USA  
Tel.: +1 703 830 6300  
Fax: +1 703 830 2300  
[sales@iospress.com](mailto:sales@iospress.com)

LEGAL NOTICE

The publisher is not responsible for the use which might be made of the following information.

PRINTED IN THE NETHERLANDS

# Preface

Intelligent Environments (IEs) aim at empowering users by enriching their experience, raising their awareness, and enhancing their management of such environments. IEs refer to the physical spaces where ICT and pervasive technologies are used to achieve specific objectives for the user and/or the environment. IEs' growing community, from academia to practitioners, is working on the materialization of IEs driven by the latest technological developments and innovative ideas.

The 16th International Conference on Intelligent Environments focuses on the development of advanced intelligent environments, as well as newly emerging and rapidly evolving topics. The present edition has been impacted by the COVID-19 pandemic, and has forced us all to celebrate it virtually. We are pleased to include the proceedings of the following workshops, which emphasize multi-disciplinary and transversal aspects of IEs, as well as cutting-edge topics:

- 10th International Workshop on Intelligent Environments Supporting Healthcare and Well-being (WISHWell'20)
- 9th International Workshop on the Reliability of Intelligent Environments (WoRIE 2020)
- 4th International Workshop on Legal Issues in Intelligent Environments (LIIE'20)
- 4th International Workshop on Intelligent Systems for Agriculture Production and Environment Protection (ISAPEP'20)
- 4th International Workshop on Citizen-Centric Smart Cities Services (CCSCS'20)
- 2nd International Workshop on Intelligent Environments and Buildings (IEB'20)
- 1st International Workshop on Research on Smart Grids and Related Applications (SGRA'20)
- 1st International Workshop on Open and Crowdsourced Location Data (ISOCLoD'20)
- 1st International Workshop on Social Media Analysis for Intelligent Environment (SMAIE'20)

The proceedings contain a series of contributions reflecting the latest research developments in IEs and related areas, focusing on stretching the borders of the current state of the art and contributing to an ever-increasing establishment of IEs in the real world. We would like to thank all the contributing authors, as well as the members of the Organizing Committees and Program Committees of the workshops for their highly valuable work, which contributed to the success of the Intelligent Environments 2020 Event.

We are grateful to our technical sponsors, the IEEE Systems Man & Cybernetics Society, IOS Press and the MDPI journals: Sensors, Electronics and Applied Sciences.

July 2020  
The Editors

This page intentionally left blank



# Committees

## Workshop Chairs

Vincent Tam, University of Hong Kong, Hong Kong  
Iván Pau, Universidad Politécnica de Madrid, Spain  
Vicente Traver, Universidad Politécnica de Valencia, Spain  
Fernando Seoane, Karolinska Institutet, Sweden

## 10th International Workshop on Intelligent Environments Supporting Healthcare and Well-being (WISHWell'20)

### Organizing Committee

Mario J. Quinde Li Say Tan, Departamento de Ingeniería Industrial y de Sistemas,  
Universidad de Piura, Perú  
Juan Carlos Augusto, Department of Computer Science, Middlesex University, UK  
Sofia Ouhbi, Computer Science and Software Engineering, UAE University, UAE

### Programme Committee

Camille Alexis-Garsee, Middlesex University London, UK  
Nebil Achour, Anglia Ruskin University, UK  
Hamid Bouchachia, Bournemouth University, UK  
Andreas Braun, PwC Luxembourg, UK  
Jeannette Chin, University of East Anglia, UK  
Mowafa Househ, Hamad Bin Khalifa University, Qatar Foundation, UK  
Nawaz Khan, Middlesex University London, UK  
Mario Kolberg, University of Stirling, UK  
German Montoro, Universidad Autónoma de Madrid, Spain  
Paul Panek, Vienna University of Technology, Austria  
Nicola Payne, Middlesex University London, UK  
Andreas Stainer-Hochgatterer, Austrian Institute of Technology, Austria  
Shabbir Syed-Abdul, Taipei Medical University, Taiwan  
Nazar Zaki, United Arab Emirates University, UAE

## 9th International Workshop on the Reliability of Intelligent Environments (WoRIE 2020)

### Organizing Committee

Miguel J. Hornos, University of Granada, Spain  
Juan Carlos Augusto, Middlesex University, United Kingdom

### **Programme Committee**

Oana Andrei, University of Glasgow, United Kingdom  
Serge Autexier, DFKI Bremen, Germany  
Saddek Bensalem, Université Grenoble Alpes, France  
Stefano Chessa, Università di Pisa, Italy  
Eun-Sun Cho, Chungnam National University, Korea  
Antonio Coronato, Institute for High Performance Computing and Networking, Italy  
Domenico Cotroneo, Università “Federico II” di Napoli, Italy  
Vincenzo De Florio, University of Antwerpen, Belgium  
Okba Kazar, University of Biskra, Algeria  
Thibaut Le Guilly, Cryptogarage Inc., Japan  
Pedro Merino, University of Málaga, Spain  
Daniela Micucci, Università degli Studi di Milano-Bicocca, Italy  
Alice Miller, University of Glasgow, United Kingdom  
Mehdi Najib, International University of Rabat, Morocco  
Mustapha Oudani, International University of Rabat, Morocco  
George C. Polyzos, AUEB, Greece  
Davy Preuveneers, KU Leuven, Belgium  
Carlos Rodríguez-Domínguez, University of Granada, Spain  
Stefano Schivo, Open University, The Netherlands  
Alexei Sharpanskykh, Vrije Universiteit Amsterdam, The Netherlands  
Sotirios Terzis, University of Strathclyde, United Kingdom  
Yoshito Tobe, Aoyama Gakuin University, Japan

### **4th International Workshop on Legal Issues in Intelligent Environments (LIIE'20)**

#### **Organizing Committee**

Pedro Miguel Freitas, Católica Porto Law School. Universidade Católica Portuguesa,  
Portugal  
Ugo Pagallo, University of Torino, Italy  
Massimo Durante, University of Torino, Italy

#### **Programme Committee**

Carlisle E. George, Middlesex University, UK  
Giovanni Sartor, European University Institute, Italy  
Manuel David Masseno, Instituto Politécnico de Beja, Portugal  
Paulo Novais, University of Minho, Portugal  
Peggy Valcke, KU Leuven, Belgium  
Pompeu Casanovas, Universitat Autònoma de Barcelona, Spain, and Royal Melbourne  
Institute of Technology, Australia  
Radboud Winkels, University of Amsterdam, Netherlands  
Thomas Burri, University of St. Gallen, Switzerland

## **4th International Workshop on Intelligent Systems for Agriculture Production and Environment Protection (ISAPEP'20)**

### **Organizing Committee**

Andrés Muñoz, Universidad Católica de Murcia, Spain  
 José Martín Soriano-Disla, Centro Tecnológico de la Energía y el Medio Ambiente, Spain

### **Programme Committee**

Honorary Chair: Michael J. McLaughlin, University of Adelaide, Australia  
 In Seop Na, Chosun University, Korea  
 Saeid Nahavandi, Institute for Intelligent Systems Research and Innovation, Australia  
 Abdul M Mouazen, Ghent University, Belgium  
 Paulo Moura Oliveira, UTAD University Vila-Real, Portugal  
 José Boaventura Cunha, UTAD University Vila-Real, Portugal  
 Josenalde Oliveira, Federal University of Rio Grande do Norte, Brazil  
 Raúl Parada, Universitat Oberta de Catalunya, Spain  
 Raquel Martínez, Universidad Católica de Murcia, Spain  
 Nuria Vela, Universidad Católica de Murcia, Spain  
 José Manuel Cadenas Figueredo, University of Murcia, Spain  
 M<sup>a</sup> del Carmen Garrido Carrera, University of Murcia, Spain  
 Gabriel Pérez Lucas, University of Murcia, Spain  
 José Fenoll Serrano, Instituto Murciano de Investigación y Desarrollo Agrario y Alimentario, Spain  
 Isabel Garrido Martín (Instituto Murciano de Investigación y Desarrollo Agrario y Alimentario, Spain  
 Jaehwa Park Chung-Ang University, Rep. of Korea  
 Joan Melià Seguí, Universitat Oberta de Catalunya, Spain  
 Carlos Monzo Sánchez, Universitat Oberta de Catalunya, Spain  
 Ioannis Chatzigiannakis, Sapienza University of Rome, Italy  
 Andrea Vitaletti, Sapienza University of Rome, Italy  
 Antonio Stasi, Università di Foggia, Italy  
 Fernando Terroso, Universidad Católica de Murcia, Spain  
 Otman Aghzout, ENSA-Tetouan, Morocco)  
 Lakshmi G. Cochin University of Science and Technology Kerala, India  
 R. S. Ajin, Idukki District Disaster Management Authority (DDMA), India  
 José-Fernán Martínez-Ortega, Universidad Politécnica de Madrid, Spain

## **4th International Workshop on Citizen-Centric Smart Cities Services (CCSCS'20)**

### **Organizing Committee**

Fábio Silva, Polytechnic Institute of Porto, Portugal  
 Héctor Alaiz Moretón, University of Leon, Spain  
 Cesar Analide, University of Minho, Portugal  
 Paulo Novais, University of Minho, Portugal

**Programme Committee**

Ângelo Costa, University of Minho, Portugal  
 Antonio Fernández-Caballero, Universidad de Castilla-La Mancha, Spain  
 Bruno Fernandes, University of Minho, Portugal  
 Cesar Analide, University of Minho, Portugal  
 Davide Carneiro, ESTG, Politécnico do Porto, Portugal  
 Fábio Silva, ESTG, Politécnico do Porto, Portugal  
 Gianni Vercelli, DIBRIS - University of Genoa, Italy  
 Hector Alaiz Moreton, Universidad de León, Spain  
 Ichiro Satoh, National Institute of Informatics, Japan  
 Jason Jung, Chung-Ang University, Republic of Korea  
 José Alberto Benítez-Andrades, University of León, Spain  
 José Carlos Castillo Montoya, Universidad Carlos III de Madrid, Spain  
 Khac-Hoai Nam Bui, Korea Institute of Science and Technology Information, Republic  
 of Korea  
 Leonardo Nogueira Matos, Federal University of Sergipe, Brazil  
 Maria Teresa García, Universidad de Leon, Spain  
 Minsung Hong, Chung-Ang University, Republic of Korea  
 Paulo Novais, University of Minho, Portugal  
 Ricardo Santos, ESTG, Politécnico do Porto, Portugal

**2nd International Workshop on Intelligent Environments and Buildings (IEB'20)****Organizing Committee**

Mohammed Bakkali, University College London, UK

**Programme Committee**

Kaveh Dianati, University College London, UK  
 Mohcine Bakhat, University of Vigo, Spain  
 Asmaa Zaz, International University of Rabat, Morocco  
 Daniel Bonilla Licea, University of Leeds, UK  
 Walter Gaj Tripiano, International University of Rabat, Morocco  
 Nadia Khaled Zurba, Federal Univesity of Ceara, Brazil  
 Vittorio Ghia, Polo Multimodal Pecém Investimentos SA., Brazil  
 Winter Rainer Tochikazum, ECOFORM Lab., Italy  
 Walter Baricchi, National Council of Italian Architects, Italy  
 P. Gallo, University of Florence, Italy  
 A. Mordini, University of Florence, Italy  
 Andrea Zamboni, Domus Magazine, Italy  
 Michele Zazzi, University of Parma, Italy  
 Youssef El Ganadi, University of Parma, Italy

## **1st International Workshop on Research on Smart Grids and Related Applications (SGRA'20)**

### **Organizing Committee**

Daniel Diaz Sánchez, Universidad Carlos III de Madrid, Spain  
 Ana Fernández Vilas, Universidad de Vigo, Spain  
 Luis Javier de la Cruz Llopis, Universidad Politécnica de Cataluña, Spain

### **Programme Committee**

Ahmad Mohamad Mezher, University of New Brunswick, Canada  
 Elena Yndurain, IBM  
 Andrés Marín Lopez, Universidad Carlos III de Madrid, Spain  
 Jordi Forné, Universidad Politécnica de Cataluña, Spain  
 Rebeca Díaz Redondo, Universidad de Vigo, Spain  
 Carlos García Rubio, Universidad Carlos III de Madrid, Spain  
 Florina Almenara, Universidad Carlos III de Madrid, Spain  
 María Celeste Campo Vázquez, Universidad Carlos III de Madrid, Spain

## **1st International Workshop on Open and Crowdsourced Location Data (ISOCLoD'20)**

### **Organizing Committee**

Fernando Terroso Sáenz, Universidad Católica de Murcia, Spain  
 Andrés Muñoz Ortega, Universidad Católica de Murcia, Spain

### **Programme Committee**

Antonio Skarmeta, University of Murcia, Spain  
 Carlos Tavares-Calafate, Technical University of Valencia, Spain  
 Jason J. Jung, Chung-Ang University, Republic of Korea  
 Juan Antonio Alvarez, University of Seville, Spain  
 Enrique Frias-Martinez, Telefonica Research, Spain  
 Vanessa Frias-Martinez, University of Maryland, United States  
 Javier Prieto, University of Salamanca, Spain  
 Lorena Gonzalez-Manzano, University Carlos III, Spain  
 Jesús Soto, Catholic University of Murcia, Spain  
 Mercedes Valdes-Vela, University of Murcia, Spain  
 Francisco Arcas, Catholic University of Murcia, Spain

## **1st International Workshop on Social Media Analysis for Intelligent Environment (SMAIE'20)**

### **Organizing Committee**

Andrés Bueno-Crespo, Universidad Católica de Murcia, Spain  
 Raquel Martínez-España, Universidad Católica de Murcia, Spain

**Programme Committee**

José Manuel Cadenas Figueredo, University of Murcia, Spain  
María del Carmen Garrido Carrera, University of Murcia, Spain  
Germán Rodríguez Bermúdez, University Centre of Defence at the Spanish Air Force Academy, Spain  
Carlos Períñan Pascual, Polytechnic University of Valencia  
Sofía Ouhbi, United Arab Emirates University, UAE  
José María Cecilia Canales, Polytechnic University of Valencia  
José García Rodríguez, University of Alicante, Spain  
Albert García García, University of Alicante, Spain  
Andrés Muñoz Ortega, Catholic University of Murcia, Spain  
Francesco Leotta, Sapienza University of Roma, Italy  
Magdalena Cantabella Sabater, Catholic University of Murcia, Spain  
Ramón Andrés Díaz Valladares, University of University of Montemorelos, Mexico  
Antonio Llanes Castro, Catholic University of Murcia, Spain  
Ginés David Guerrero, National Laboratory for High Performance Computing, Chile  
Jesús Antonio Soto Espinosa, Catholic University of Murcia, Spain  
Baldomero Imbernón Tudela, Catholic University of Murcia, Spain  
Mario Hernandez Hernandez, Autonomous University of Guerrero, Mexico

# Contents

Preface	v
<i>Carlos A. Iglesias, Jose Ignacio Moreno Novella, Alessandro Ricci, Diego Rivera Pinto and Dumitru Roman</i>	
Committees	vii
<b>10th International Workshop on Intelligent Environments Supporting Healthcare and Well-Being (WISHWell'20)</b>	
10th International Workshop on Intelligent Environments Supporting Healthcare and Well-Being (WISHWell'20)	3
<i>Mario Quinde, Juan C. Augusto and Sofia Ouhbi</i>	
Innovation in a Time of Crisis – COVID-19 and Rapid Developments in Intelligent Environment Technologies	5
<i>Andreas Braun</i>	
Designing a Multiagent System for Elderly Care	9
<i>M. Ramírez, C. Lino, V. Zamudio, D. Gutiérrez and H. Puga</i>	
On Digital Multimedia and Human Emotions Using EEG-Based Brain Computer Interface	19
<i>Nuraini Jamil, Abderahmane Lakas, Sofia Ouhbi and Abdelkader Nasreddine Belkacem</i>	
Automatic Generation of Customised Exergames for Home Rehabilitation Based on Physical Mobility Constraints and Key Performance Indicators	29
<i>Cristian Gómez-Portes, David Vallejo, Ana I. Molina and Carmen Lacave</i>	
IoT-Based Smart Medicine Dispenser to Control and Supervise Medication Intake	39
<i>Gleiston Guerrero-Ulloa, Miguel J. Hornos, Carlos Rodríguez-Domínguez and Ma. Mercedes Fernández-Coello</i>	
<b>9th International Workshop on the Reliability of Intelligent Environments (WoRIE 2020)</b>	
9th International Workshop on the Reliability of Intelligent Environments (WoRIE 2020) – Introduction	51
<i>Miguel J. Hornos and Juan C. Augusto</i>	
Practical Issues in Aggregation and Distribution of Electrical Power Among USB-PD-Connected Devices	54
<i>Kota Tamura, Yuusuke Kawakita, Yoshito Tobe, Shinji Yokogawa and Haruhisa Ichikawa</i>	
HarSaRK-RS: Hard Safe Real-Time Kernel in Rust	62
<i>Kanishkar Jothibasur and Gourinath Banda</i>	

Automated Drone-Based Aircraft Inspection 72  
*Soufiane Bouarfa and Joselito Serafico*

A Gateway for Enabling Uniform Communication Among Inter-Platform JADE Agents 82  
*Juan A. Holgado-Terriza, Pablo Pico-Valencia and Alvaro Garach-Hinojosa*

#### **4th International Workshop on Legal Issues in Intelligent Environments (LIIE'20)**

Internet Protocol Standards for IoT Interoperability in the House. Open Issues in EU Competition Law 95  
*Francesca Gemari*

The Unsecure Side of (Meta)Data in IoT Systems 105  
*Pier Giorgio Chiara*

Big Data and Pandemics: How to Strike Balance with Data Protection in the Age of GDPR 115  
*Aiste Gerybaite and Paola Aurucci*

#### **4th International Workshop on Intelligent Systems for Agriculture Production and Environment Protection (ISAPEP'20)**

Application of Ensemble Learning to Detect *Alternaria Solani* Infection on Tomatoes Cultivated Under Foil Tunnels 127  
*Krzysztof Smykala, Bogdan Ruszczak and Karol Dziubański*

Geospatial Technologies in Precision Farming: A Case Study 133  
*Md. Jashim Uddin, Peter S. Hooda, Abdus Salam Mohammad Mohiuddin and Mike Smith*

Towards the Characterization of Agricultural Regions Based on Weather Conditions – Sustainable Agriculture 143  
*Jose M. Cadenas, M. Carmen Garrido and Raquel Martínez*

A Computer Vision Approach to Monitoring the Activity and Well-Being of Honeybees 152  
*Sanket Kachole, Gordon Hunter and Olga Duran*

#### **4th International Workshop on Citizen-Centric Smart Cities Services (CCSCS'20)**

Introduction to CCSCS'20 165  
*Fábio Silva, Héctor Moretón, Cesar Analide and Paulo Novais*

Context-Aware Approach for Cardiac Rehabilitation Monitoring 167  
*Godwin Okechukwu Ogbuabor, Juan Carlos Augusto, Ralph Moseley and Alechia van Wyk*

IoT Architecture Proposal from a Survey of Pedestrian-Oriented Applications 177  
*Luís Rosa, Fábio Silva and Cesar Analide*



A Soft Context-Aware Traffic Management System for Smart Cities <i>Davide Carneiro, António Amaral and Mariana Carvalho</i>	187
Optimising User Experience with Conversational Interface <i>Marco Gomes, António Miguel Costa, Cesar Analide, Paulo Novais and Fábio Silva</i>	197
Review and Replication of CoAP and MQTT Attacks for Dataset Generation <i>Jose Aveleira-Mata, Armando Ibán-Sánchez, María Teresa García-Ordás, Isaiás García-Rodríguez and Héctor Alaiz-Moreton</i>	207
Managing Preference Profiles in Multi-User Intelligent Environments <i>Juan Carlos Augusto and Andrés Muñoz</i>	217

## **2nd International Workshop on Intelligent Environments and Buildings (IEB'20)**

Multi-Scaled Outdoor Temperature Models Within the London Building Domestic Stock of Westminster <i>Mohammed Bakkali</i>	229
Modelling Effects of Rooftop PVs on Outdoor Temperatures: The Case of Low Latitude Neighbourhoods <i>Asmaa Zaz, Mohammed Bakkali, Mohammed Ouassaid, Yasunobu Ashie and Mounir Ghogho</i>	242
Intelligent Thermal Storage in the Balearic Islands Hotels with Solar Energy <i>Andreu Moià-Pol, Pere Rullan and Bartomeu Alorda</i>	252
New Approach to Indoor Thermal Climate Control Using Natural Building Envelope and Cross Ventilation Techniques <i>C. Carmona, J. Muñoz and B. Alorda</i>	259
Price Relationships of Crude Oil, Biofuels and Food Commodities <i>Mohcine Bakhat and Klaas Würzburg</i>	268
Parametric Building Design Options Within Voronoï Diagram Based Urban Fabric <i>Fatima-Ezzahra Laaroussi, Bahia Nouh and Mohammed Bakkali</i>	278

## **1st International Workshop on Research on Smart Grids and Related Applications (SGRA'20)**

A Framework for Microservice Migration and Performance Assesment <i>Eugenio Rubio-Drosdov, Daniel Díaz-Sánchez, Andrés Marín-López and Florina Almenares</i>	291
A Testbed Based Performance Evaluation of Smart Grid Wireless Neighborhood Area Networks Routing Protocols <i>Juan Pablo Astudillo León and Luis J. de la Cruz Llopis</i>	301
Anomalies Detection Using Entropy in Household Energy Consumption Data <i>Marta Moure-Garrido, Celeste Campo and Carlos García-Rubio</i>	311

Monitoring Electricity Consumption Based on Time Series Analysis <i>Rebeca P. Díaz Redondo, Ana Fernández Vilas and Alberto Estévez Caldas</i>	321
On the Automation of Auditing in Power Grid Companies <i>Sergio Chica-Manjarrez, Andrés Marín-López, Daniel Díaz-Sánchez and Florina Almenares-Mendoza</i>	331
<b>1st International Workshop on Open and Crowdsourced Location Data (ISOCLoD'20)</b>	
Domain Agnostic Quality of Information Metrics in IoT-Based Smart Environments <i>Aurora González-Vidal, Tomás Alcañiz, Thorben Iggena, Eushay Bin Ilyas and Antonio F. Skarmeta</i>	343
Efficient Collaborative Strategy for Last Mile Package Delivery Optimization: Salamanca Case Study <i>Roberto Casado-Vara, Ricardo S. Alonso, Jose A. García-Coria, Sara Rodríguez and Javier Prieto</i>	353
Enhancing the spaCy Named Entity Recognizer for Crowdsensing <i>Julio Fernández-Pedauye, Carlos Periñán-Pascual, Francisco Arcas-Túnez and José M. Cecilia</i>	361
<b>1st International Workshop on Social Media Analysis for Intelligent Environment (SMAIE'20)</b>	
Assessing the Impact of Tweets in Flood Events <i>Carlos Periñán-Pascual, José M. Cecilia, Alicia Sepúlveda-Muñoz, Francisco Arcas-Túnez and Nicolás José Fernández-Martínez</i>	371
Realisation of Usability Tests: A Social Media Marketing Software Development Case <i>Christina Eberharter and Anna Fensel</i>	381
Towards a Web Tool for the Analysis of Twitter Profiling Information <i>Feliciano J. Gómez-Fernandez and Fernando Terroso-Sáenz</i>	391
Performance Evaluation of Clustering Algorithms on GPUs <i>Juan Morales-García, Antonio Llanes, Baldomero Imbernón and José M. Cecilia</i>	400
Representing Human Mobility Patterns in Urban Spaces <i>Luís Rosa, Fábio Silva and Cesar Analide</i>	410
Subject Index	421
Author Index	423

10th International Workshop on Intelligent  
Environments Supporting Healthcare and  
Well-Being (WISHWell'20)

This page intentionally left blank

# 10th International Workshop on Intelligent Environments Supporting Healthcare and Well-Being (WISHWell'20)

July 20-21, 2020, Madrid, Spain

Chairs: Mario QUINDE<sup>a</sup>, Juan C. AUGUSTO<sup>b</sup> and Sofia OUHBI<sup>c</sup>

<sup>a</sup>*Departamento de Ingeniería Industrial y de Sistemas, Universidad de Piura, Peru*

<sup>b</sup>*Department of Computer Science, Middlesex University, London*

<sup>c</sup>*Department of Computer Science and Software Engineering, UAE University*

## 1. Introduction

The workshop will bring together researchers from both industry and academia from the various disciplines to contribute to this new edition of the International Workshop on Intelligent Environments Supporting Healthcare and Well-Being. This event previously joined forces with the International Workshop “PervaSense – Situation recognition and medical data analysis in Pervasive Health environments” and the workshop on “Smart Healthcare and Healing Environments”. Healthcare environments (within the hospital and the home) are extremely complex and challenging to manage from an IT and IS perspective, as they are required to cope with an assortment of patient conditions under various circumstances with a number of resource constraints. Pervasive healthcare technologies seek to respond to a variety of these pressures by integrating them within existing healthcare services. It is essential that intelligent pervasive healthcare solutions are developed and correctly integrated to assist health care professionals in delivering high levels of patient care. It is equally important that these pervasive solutions are used to empower patients and relatives for self-care and management of their health to provide seamless access for health care services.

The technical program will feature an invited Keynote: *Innovation in a time of crisis - COVID-19 and rapid developments in intelligent environment technologies* by Dr Andreas Braun.

This will be supplemented with discussions and panel-type activities and the presentation of the following selected papers:

*Designing a Multiagent System for Elderly Care* by Maria Ramírez, Carlos Lino, Victor Zamudio, David Gutiérrez and Héctor Puga.

*On Digital Multimedia and Human Emotions using EEG-based Brain Computer Interface* by Nuraini Jamil, Abderahmane Lakas, Sofia Ouhbi and Abdelkader Nasreddine Belkacem.

*Automatic Generation of Customised Exergames for Home Rehabilitation based on Physical Mobility Constraints and Key Performance Indicators* by Cristian Gómez-Portes, David Vallejo, Ana I. Molina, Carmen Lacave.

*IoT-Based Smart Medicine Dispenser to Control and Supervise Medication Intake* by Gleiston Guerrero-Ulloa, Miguel J. Hornos, Carlos Rodríguez-Domínguez and Ma. Mercedes Fernández-Coello.

We deeply appreciate the Intelligent Environments 2020 conference organizers for their help on hosting this event. As a final note, we wish to express our sincere thanks to the Program Committee for their thorough reviews and support along this year and the previous editions.

# Innovation in a Time of Crisis - COVID-19 and Rapid Developments in Intelligent Environment Technologies

Andreas BRAUN<sup>a,1</sup>

<sup>a</sup>*PricewaterhouseCoopers Société coopérative, Luxembourg*

**Abstract.** “In the midst of every crisis, lies great opportunity”, this unverified quote, often attributed to Albert Einstein, is a hopeful statement in those early months of 2020. While, the dramatic human and economic costs of the COVID-19 crisis are still unraveling, there is at the same time the immense human push to create the path out of this crisis, to challenge our habitual patterns, and to envision solutions for the future. This drive towards innovation is very apparent in the area of intelligent environments, where we see an increased movement towards solution that support the monitoring of individual and public health, that massively expand the scope of data collection for societal benefits, ultimately trying to rebuild trust between people and nations, as well as accelerating the way to a new normal. In this work I will provide an overview of the most recent developments of innovative solutions in intelligent environment technologies and how those support the current efforts to overcome the global COVID-19 health crisis.

**Keywords.** Intelligent environments, COVID-19, biometrics, sensors, telehealth, mobile health

## 1. A world in crisis

The world has been undergoing a rapid change during those early months of 2020. With economic effects in the trillions, millions of people being infected, and thousands of fatalities each day, the consequences of COVID-19 have been nothing short of dramatic. Models predict a significant loss of employment and economic impacts that could last for many years [1]. Thanks to coordinated mitigation measures and the resilience of billions of individuals that adhered to imposed lockdowns and quarantines, the human cost, while serious, is not following the worst predictions [2].

There is the oft-cited quote that “*in the midst of every crisis, lies great opportunity*”. While this is something that Albert Einstein could have said, there is no evidence that this originated from his great mind. Nonetheless, the words remain true to this day. Throughout human history, great struggles have also led to great innovation. The current crisis is still in its early stages, so speculating on potential outcomes is premature. However, there are early signals of innovation in technology around the world that may allow us to investigate some scenarios and developments.

---

<sup>1</sup> Andreas Braun, PwC Société coopérative, 2 rue Gerhard Mercator, B.P. 1443, L-1014 Luxembourg, Luxembourg; E-mail: andreas.braun@pwc.com.

The area of intelligent environments has frequently anticipated innovation that has reached the lives of millions of people, years later. From widespread use of wearable devices [3], to large groups of people communicating and interacting via video [4]. Innovation in the intelligent environments space may just as well give us a glimpse of what emerging technologies we might see in the recovery of the crisis.

A particularly interesting case are large linked intelligent environments, composed of a massive scale of devices and people participating and that leverage advanced sensor technologies. I will provide a quick overview of some of those technologies, as well as outline some key differences on how they have been applied globally.

## 2. Innovation in public health monitoring

The speed of how this crisis and the response to it has developed is extraordinary. There are already more than 180,000 scientific works registered in Google Scholar<sup>2</sup>. The number of news articles, blog posts, social media greatly surpasses this. Therefore, it is only possible to capture a small range of technologies that have been tested, proposed, and implemented in the last months.

I want to focus on three specific areas that are closely interconnected with the domain of intelligent environments, namely advanced sensor systems, mobile and mHealth solutions, as well as large-scale teleconferencing systems that all have seen a significant momentum in the past months and may become crucial instruments in overcoming the crisis.

Advanced sensor systems are a vast area of research that must be further refined. I want to focus on the area of biometric sensors and how they are in active use in areas hit by COVID-19. Large-scale facial recognition systems have been quickly updated with algorithms that enable applications in this domain. The city of Moscow has linked more than 100,000 cameras to a system that claims to analyze social interactions, silhouette tracking to detect violations in quarantine zones, identification of home quarantined persons in public spaces, or violation of age restrictions in certain areas [5]. Remote body temperature measurement systems aim at detecting persons with a fever as a common symptom of COVID-19 are used by various international airports. There is already significant experience, as many of the systems have been tested after the SARS epidemic of 2003 [6]. However, there are considerable ethical concerns about those technologies. Systems installed for the purpose of tracking COVID-19 can easily be abused for malicious purposes, e.g. camera surveillance systems that track minorities, or political opponents.

A second group of technologies is mobile systems that integrate with intelligent environments. A common talking point are at this point contact tracing systems. The method is a common strategy during pandemics, yet traditionally performed manually. Mobile tracing apps use location services, based on Global Navigation Systems, radio triangulation and device-to-device communication (e.g. Bluetooth LE) to identify when a positively tested person may have interacted with other persons. The same apps can notify potentially infected persons [7]. Countries that are actively using this technology include Singapore, South Korea, Israel and Norway, with many more to follow during the second quarter of 2020. These apps essentially create a large-scale intelligent environment, that requires interconnected sensors, high-bandwidth communication facilities, and smart analytics systems to enable this on a country level. There are again

---

<sup>2</sup> Search term “COVID-19” as per May 8<sup>th</sup> 2020



significant ethical concerns. The systems generate a high number of movement profiles that could be misused by malicious actors. There is ongoing discussion to create decentralized systems that would alleviate some of those concerns and keeping the data of each participant in their own control. Mobile apps have also been used broadly to provide quick access to health resources, to inform the public about the current status in the country, or to carry information about the current COVID-19 health status of users [8]. Notably there is a risk of social condemnation of persons carrying their health status and such systems must be used responsibly.

A third innovation with strong links to intelligent environments are the rapid adoption of teleconferencing services in the health domain. While teleconsultation with medical professionals is almost considered a traditional application of intelligent environment, there has been a change of pace. The increased risk for health workers becoming infected, has caused many countries to remove administrative hurdles and engage in a massive expansion of telemedicine services [9]. There are concerns regarding the digital gap, i.e. the lower adoption rate of senior citizens or certain groups of persons with disabilities that may prevent them from fully benefiting from those services. Again, a responsible use is key. In any cases the anticipated higher availability of resources in the health sector thanks to the ongoing digital transformation can be used to support those persons.

### 3. Global perspective and a look into the future

There are differences on how these technologies are applied, when comparing global regions. Technology-driven Asian countries, including Taiwan, South Korea and China, have had success leveraging those technologies in the early stages of the pandemic. Taiwan has e.g. made available the travel history of patients available to doctors and pharmacies within a 72-hour period to specifically support at-risk persons [10]. Europe or North America on the other hand, have been slower to adapt new technologies and the severity of the outbreaks have been significantly worse [11]. It is impossible to tell at this point, to what extent this was driven by the aforementioned technologies. It was suggested that cultural factors, as well as experience from the 2003 SARS epidemic have played a role in the improved preparedness of many Asian countries [12].

However, it should lead the developed economies in the Western world to reflect on their approach towards innovation & technology, as an overly cautious approach may lead to adverse results. There are optimistic signs in this regard, as governments and international organizations were quick to seek innovative companies and individuals to contribute to the challenges, with numerous Hackathon's and innovation competitions being started in a very short amount of time [13]. The same mindset should enable us to bring these innovations to the people, in a responsible and effective manner that leverages the benefits and capabilities of intelligent environments, while considering and mitigating the potential risks. This would be a clear step towards capturing the *"opportunity of this crisis"*.

### References

- [1] McKibbin, W. J., & Fernando, R. (2020). The global macroeconomic impacts of COVID-19: Seven scenarios.

- [2] Anderson RM, Heesterbeek H, Klinkenberg D, Hollingsworth TD. How will country-based mitigation measures influence the course of the COVID-19 epidemic?. *The Lancet*. 2020 Mar 21;395(10228):931-4.
- [3] Weiser M. The Computer for the 21 st Century. *Scientific american*. 1991 Sep 1;265(3):94-105.
- [4] Bly SA, Harrison SR, Irwin S. Media spaces: bringing people together in a video, audio, and computing environment. *Communications of the ACM*. 1993 Jan 1;36(1):28-46.
- [5] <https://www.bbc.com/news/av/world-europe-52157131/coronavirus-russia-uses-facial-recognition-to-tackle-covid-19> (Accessed: May 8th, 2020)
- [6] <https://www.airport-technology.com/features/coronavirus-screening-at-airports/> (Accessed: May 8th, 2020)
- [7] Cho H, Ippolito D, Yu YW. Contact tracing mobile apps for COVID-19: Privacy considerations and related trade-offs. arXiv preprint arXiv:2003.11511. 2020 Mar 25.
- [8] Ienca M, Vayena E. On the responsible use of digital data to tackle the COVID-19 pandemic. *Nature medicine*. 2020 Apr;26(4):463-4.
- [9] Smith AC, Thomas E, Snoswell CL, Haydon H, Mehrotra A, Clemensen J, Caffery LJ. Telehealth for global emergencies: Implications for coronavirus disease 2019 (COVID-19). *Journal of telemedicine and telecare*. 2020 Mar 20:1357633X20916567.
- [10] Wang CJ, Ng CY, Brook RH. Response to COVID-19 in Taiwan: big data analytics, new technology, and proactive testing. *Jama*. 2020 Apr 14;323(14):1341-2.
- [11] World Health Organization. Coronavirus disease 2019 (COVID-19): situation report, 72.
- [12] Bedford J, Enria D, Giesecke J, Heymann DL, Ihekweazu C, Kobinger G, Lane HC, Memish Z, Oh MD, Schuchat A, Ungchusak K. COVID-19: towards controlling of a pandemic. *The Lancet*. 2020 Mar 28;395(10229):1015-8.
- [13] <https://www.forbes.com/sites/tomokoyokoi/2020/04/16/the-hackathon-approach-to-covid-19-showcases-agile-innovation-at-its-best/> (Accessed: May 8th, 2020)

# Designing a Multiagent System for Elderly Care

M. Ramírez<sup>a,1</sup>, C. Lino<sup>a</sup>, V. Zamudio<sup>a</sup>, D. Gutiérrez<sup>a</sup> and H. Puga<sup>a</sup>

<sup>a</sup>*Division of Graduate Studies and Research, Tecnológico Nacional de México/Instituto Tecnológico de León*

**Abstract.** Currently, society has more aging filters and this is done because: each year the amount of adults who exceed 60 years of age increases, each year more men and women participate in activities outside their homes and thanks to this, new solutions are required to help take care of older people (the elderly). Systems that support us with the care of the elderly at home already exist and some are economic, allowing healthcare centers to obtain them and help them remotely take care of our loved ones. As the years go by, technology has made the comfort of our loved ones at home possible. In this research, a novel architecture and initial prototype is presented focused on comfort and it exploits the multi-agent systems paradigm that includes both stationary and mobile agents. In addition, an adaptative mechanism is presented that allows mobile agents to adapt to diversified local environments.

**Keywords.** Smart Home, Ambient Intelligence, Multi-agent System, Artificial Intelligence, Fuzzy Logic, Elderly Care.

## 1. Introduction

Currently in first world countries, there exists a program where projects are launched "Active Assisted Living Program Ageing Well in the Digital World", ranging from monitoring physical activity to "happy aging" through home automation systems.

There is another program called MIT AgeLab, which was created to invent new ideas and creatively translate technologies into practical solutions that improve people's health and allow them to "do things" throughout life. MIT AgeLab is a multidisciplinary research program that works with companies, governments and NGOs to improve the quality of the elderly life and those who care for them.

Technology inside homes is one of the advantages of the 21st century. It has created technology and intelligent agents such as: Alexa (Smart device capable of interacting with its buyer and obeying their orders), Google Home (Smart device similar to Alexa), home automation or subdivisions, hospital rooms, etc. Each of these devices or multi-agent systems has its elaboration form and its development plan. This document will develop a strategy to implement multi-agent system which will be able to help vulnerable people or people with different abilities, using a Raspberry Pi.

On the other hand, the project is designed for automation within a house in order to achieve improvements in the quality of people's lives, who will reside in these houses. These improvements are made by adding multi-agent services to the house, in order to

---

<sup>1</sup> M. Ramírez, C. Lino, V. Zamudio, D. Gutiérrez and H. Puga, Division of Graduate Studies and Research, Tecnológico Nacional de México/Instituto Tecnológico de León; E-mail: M19241058@gmail.com.

fulfil this, we studied the 4 large groups in which the domotic services are grouped and these are: energy saving, comfort, security and communications.

## **2. Related Work**

Currently, life expectancy has increased, with the consequent aging of the population. On the other hand, family structures are changing, children's work and education require more time and if we add a family member with no mobility at home, the difficulty of attending a house has increased. Home automation allows responding to the requirements possible by these social changes and new trends in our ways of life, facilitating the home designs, multifunctional and flexible houses and homes. The home automation sector has evolved considerably in early years and currently offers a more consolidated offer [1-4]. Not only the mechanical part, comfort, patient care, but also energy savings at home [5, 6] are taken into account. The home automation sector is also beginning to implement security within smart rooms, such as fingerprint identifiers [7]. Currently there is a demand for home automation, however, the competition is not as developed as: Alexa, Google Home, independent systems, etc. [8-11].

Today, Smart Home technology aims to provide a home environment, comfortable and energy efficient to improve the quality of the resident's lives through the use of networks designed to work with sensors, actuators and information processing techniques. Most smart homes and their designs emphasize the use of artificial intelligence algorithms [12-17]. Networks that work with sensors [18-20] and multiple information acquisition techniques [21] these systems have also been used to perceive dangerous situations and achieve automatic control of certain household appliances. However, these systems generally involve large amounts of information processing and centralized implementation schemes. Its mechanisms are not optimal to achieve a smart home automation distributed, scalable and robust.

On the other hand, processing mechanisms for the acquisition of distributed and in-network data have been proposed to improve the efficiency and speed of sensor and actuator networks in the acquisition of information and the perception of the situation [22, 23]. Techniques such as adaptive sampling, aggregations within the network, reconfiguration of runtime and multitasking are used to improve query performance with reduced data throughput and energy consumption. In addition, [24] it provides a building management framework for multi-node platforms, which can dynamically capture the morphology of the building and manage groups of multiple nodes with different functionalities. These technologies assume that: (1) only simple operations are involved for the acquisition and performance of data; (2) only basic computer algorithms are used for in-network processing; and (3) the entire system can be developed in a homogeneous manner, except the base station. However, many sensors / actuators for home automation require complicated calibration, configuration and cooperation procedures. In addition, sensors and actuators impose different requirements on hardware and computing capabilities. Machine learning techniques are required for in-network processing to achieve perceptions of context and situation. The learned context and knowledge models should be stored in databases to facilitate access. Therefore, these distributed units must be improved with different computing, communication, configuration and storage capabilities, without losing system scalability and robustness against local failures.

### 3. System configuration and problem statement

#### 3.1. Smart agents

A unit that manages to work with hardware and software independently is considered an agent, intelligent agents have some characteristics that distinguish them as:

Agents are developed to target them, they are adaptive and self-reconfigurable. Each agent is able to understand their situation and adapts to changing environments through self-configuration. The perception of the situation is achieved through learning and contextual modeling of event data. After a set of contextual bases is learned from high-dimensional event data, the grouped contextual coefficients can represent different scenarios. Agents can then perceive the situation and locate regions of interest (RoIs) through identified scenarios. Each agent has a behavior state machine and a behavior library; choose a certain behavior according to the individual objectives and the behavior of other agents.

#### 3.2. User interface and event submission

The user interface has two functions: (1) convert the user's goal and environment and the human context into a set of beliefs, desires and intentions for each agent; and (2) select a communication protocol, a collaboration mechanism and a resource management scheme based on the regulatory policy provided by the user. These inputs will become selections of sensor modalities, algorithms / protocols, context / behavior templates and a resource management policy. There are two types of events: (1) external and (2) internal. External events represent different states of the environment and the behavior of human subjects. Internal events represent different states of agent behavior. These events will be sent to the operating agents and, in each agent, the events will trigger behaviors in certain situations.

#### 3.3. Problem Statement

If we count the elderly in Mexico, children under 10, people with disabilities or physical and mental disabilities, we would obtain a percentage of 39.7% of vulnerable people registered by the INEGI in Mexico. It is clear that, within these calculations we do not count lesions of lower degrees or temporary illnesses, which are not guaranteed to become well or fixed, but still, they have a probability of occurring.

Within the calculations mentioned, no reference is made to land accidents or daily accidents. In 2018, they registered 365,167 land accidents and more than 12 thousand daily accidents that were recorded in Mexico (INEGI, 2015), can you imagine the probability that in each of those accidents any person could end up injured or disabled?

After speaking to a few people in an elderly care center (this includes the elderly care staff and the clients) we decided to focus our attention on the elder and not on all the vulnerable people themselves. So we asked ourselves the real question and problem we want to focus on: Is it possible to design and build a multi-agent system capable of serving the elderly?

## 4. Agent evaluation and benefits

### 4.1. Agent Evaluation

This project plans to design a table that can be located in the center of the living room in any home, thinking about the comfort, safety and care of an individual. A table inside the home is categorized as a decorative and reliable piece of furniture, which is why he chose it as our costumed multi-agent. To be able to take care of our loved ones and rely on technology and its safety, an investigation will be carried out to determine which materials will be used in the manufacture of the table and what will be the ideal way for our patient to run the least possible risk. In case of an accident.

The comfort is another important point within the design of the multi-agent, a table that has the appropriate height, prudent dimensions and neutral colors should be built so that the “table” fits the house in the least remarkable way. Most vulnerable people consume medications and the table will have the task of recording the medications consumed, the consumption hours and notifying the patient the time in which they should consume their medications in order for them to maintain a healthy patient.

In order to carry out the design of the multi-agent, a Raspberry Pi will be used. This board was chosen so we could be able to design a practical application of a fuzzy controller, developed by the Raspberry Pi 3 embedded system and to be able to make use of the Python programming language, as well as for the control of the GPIO's (General-Purpose Input / Output) of the Raspberry.

The objective of the controller is to keep the multi-agent in a proposed interval which will allow different devices to be activated by means of a control signal, manipulating the signal in the form of diffuse quantities, thus carrying out the defusification process to obtain the control signal, which will interact with the final actuators.

### 4.2. Project requirements

The devices that will be use are: A Raspberry Pi 3 as the brain of the intelligent agent that will register all the data and two ESP32 that will work as monitors, they will monitor the house to be sure of the security (no gas leaks and temperature control). This is done because the elder doesn't always stays in the living room and we want to know if his/her temperature levels are appropriate, also, the elder frequently forgets to turn off the stove or has gas leaks and doesn't know it.

The Raspberry Pi will have a few sensors and some actuators which are: A DHT sensor (temperature sensor) which will read the temperature of the elder in the living room, a touch sensor that will control the light that will be attached underneath the table so he can see the floor and prevent any accidents. Several motor and endless screws to provide him or her with the pills the required (they will activate when the schedule programmed reads that it's time to take their medicines) and a buzzer that will be activated when it's time to take the pills and it will not shut down until the elder presses the button that indicates that he toke the pills and when he does the program will automatically register the date and hour he toke the pill.

In one of the ESP32 it will have a temperature sensor (DHT) and a fan. This device will be located in the middle of the house (if it's a small house) or in a place where the elder can locate his or her fan and it would get to them, the device will be wireless.

The second ESP32 will have a gas sensor to read gas leaks and a fire and a temperature sensor to prevent fire accidents, this sensor will also be wireless and it will be located at the kitchen of the elder's house.

#### *4.3. Scope and limitations*

Communication within the room will be limited, while the system is within a moderate range, the communication signal should have no problem with its reception. The automatic part has a limit of I / O ports, which one is used for one of the available inputs or outputs (digital signals), if it exceeds the number of inputs and outputs an external expansion will be necessary. The disabled or in need person, owner of the device will have to have a data acquisition system and must have the basic knowledge of "how to turn on a device". People who wish to purchase this system should not necessarily have any physical limitations, anyone who can reason could use the device or system for pleasure or convenience.

In order to collect information, a data analysis will be performed to find regularities or abnormalities in the information. This will be carried out in order to take preventive or corrective actions within the implementation of the project through diffuse logic.

#### *4.4. Practical implication*

A number of practical implications are associated to this research, including:

- The intelligent agent would decrease the need for mobility
- It will help with medication registration
- The system will remember the consumption hour of medications and their schedules
- The table will provide accessible and easy-to-use electrical contacts
- and accessible lights
- Sliding tray, carrier for glasses or cups.

#### *4.5. Social relevance*

- It helps society to realize that our loved ones depend on special care and if we cannot give it to them, we have the obligation to look for the way in which they can be treated as they deserve.
- It gives people the opportunity to look out for themselves in the future and it gives them the option to avoid having to be dependent on their elderly years.
- It creates a social impact, so that people begin to care socially and our society generates engineers who look out for vulnerable people.

#### *4.6. Methodological utility*

Collection of medical data, compile the schedules in which patients take their medications and help their memory.

## 5. Methodology

### 5.1. Electronic Process

Achieving this project will take a lot of electrical work, we have to start programming the gas and temperature sensors in python which will be programmed as analog inputs, next we program the fan and power test it with the Raspberry Pi. After designing the basic Python program with input and outputs we communicate the ESP32 and Raspberry Pi and perform Wifi tests, we switch the programs to the ESP32s and add the buzzer notifications.

Once we finish the Wifi communication between the raspberry pi and the ESP32 we start programming the touch sensor so we can start designing the circuit plate and providing the cables and devices for the second stage of the project, building the structure.

We will create the table design in SolidWorks, add mechanisms to the table, decorate the table, add the motors and endless screws to the pillbox and design the final circuit plate. After we finish, we will provide material for corrections, in case of any error or technical difficulty and we will make any corrections in mechanisms or programs.

We would like to clarify that only the first stage of the electronic work has been finished, as will be explained in the following section.

### 5.2. Electronic design

As it is shown in figure 1, an electronic device will be used to perform sensor reading, a program will command the actuators actions and analyze the program to apply fuzzy logic.

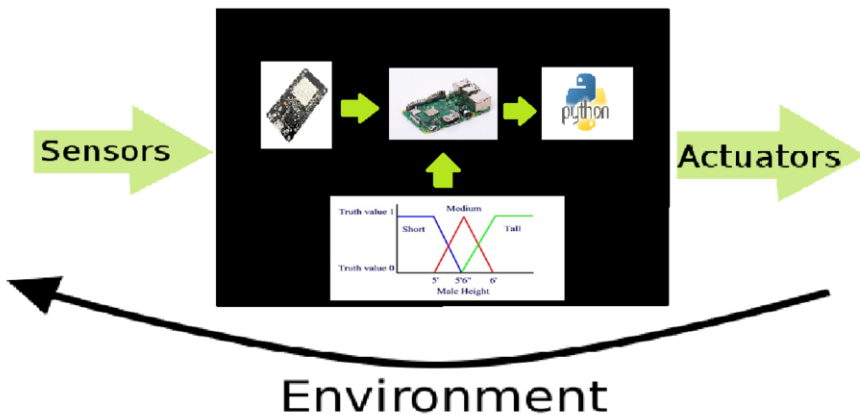
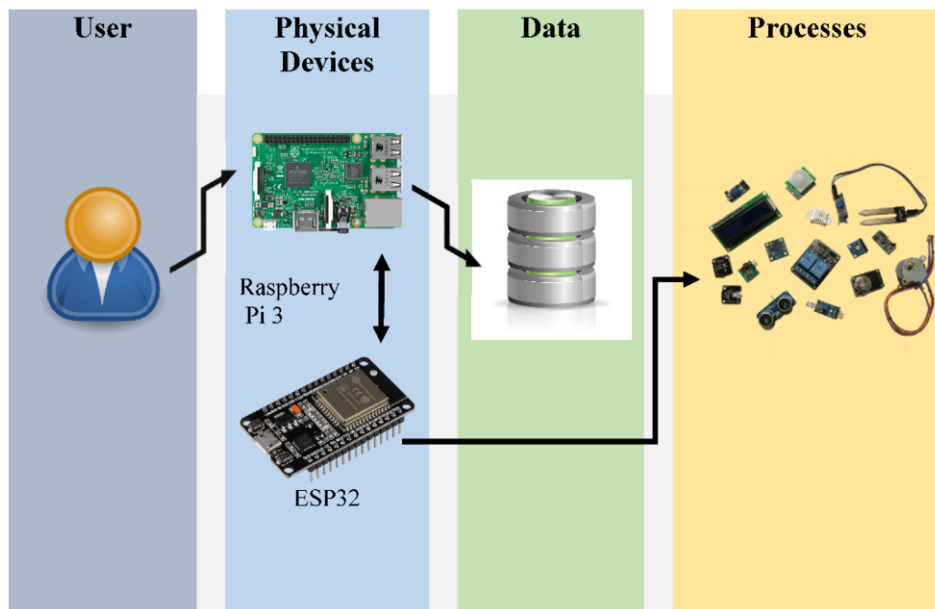

Figure 1. Electronic System.

In this case, the Raspberry Pi 3 will be used in communication with the ESP32 so it can be able to communicate wirelessly via Wi-Fi, the sensors that will write the data will be: a gas sensor, a flame sensor, 3 DHT22, and some touch buttons, the actuators that



will react to data writing and programming will be: motors with endless screws, a buzzer and a registration system within a Raspberry Pi document.



**Figure 2.** Multiagent Electronic Design.

As it is shown in Figure 2, the Raspberry pi will act as a CPU and the communication center between the two ESP32 connected via Wi-Fi. The ESP32s will be connected to the flame, gas, temperature, touch sensor, motor, buzzer and fan sensors via a relay actuator. When the reading is done, these readings will be recorded within a .txt in the PCU.

### 5.3. Physical design

The intelligent agent will be disguised as a table, which will have a section for the pillbox that will include the motors and the endless screws for its movement. The table will also have a buzzer for notifications and an ESP32 that controls the pillbox and buzzer and a touch sensor with the DHT that measures the ambient temperature.

Figure 3 shows that the intelligent agent will communicate via a Wi-Fi connection with a fan that will be connected to an ESP32 so that it can react automatically with the ambient temperature. An ESP32 will be installed at the kitchen so that through a gas and flame sensor it can provide security. The agent's brain, which will record the data obtained will be wireless and mobile through a Raspberry Pi.

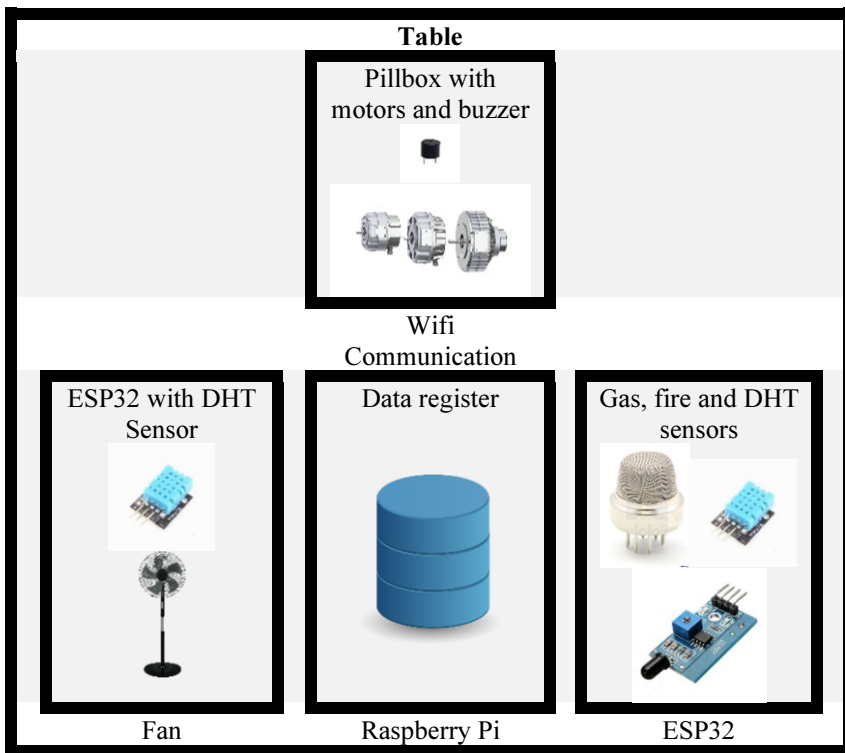

Figure 3. Physical Design and Structure.

## 6. Preliminary results

Currently, as the first step to complete the prototype, a Python program was designed using the Raspberry Pi 3; which already makes use of a Buzzer that notifies the moment (date and time) in which the patient must take their medications (turns on a led) and ends this notification with the recording of data by pressing a button that indicates that the patient took your medication, the record includes the date and time the button was pressed (Buzzer's stop). As a next step, the flame sensor and the gas sensor were programmed in Python through the Raspberry Pi 3 to send a notification through the Buzzer, if any of these sensors detects a gas or fire leak inside the house, it will activate the Buzzer. It is worth mentioning that for each one of the notifications (led lighting, medication intake and detection by means of the sensors) a different output (noise or sound) was programmed to show the difference.

Another very important step that was carried out was the wireless programming of the ESP32, currently we already have wireless communication through MQTT (mosquitto). As previously mentioned, it is important to have a Wi-Fi communication between each of the devices so that the patient is secure while these devices do their work in the place they are required. Communication was an essential step and now the first program is begin reorganized. Thanks to wireless communication, you can now divide the program that was made on the Raspberry Pi and program each of the ESP32 with

their respective sensors (this part is the one that is currently being worked on in order to end the wireless communication).

Once the wireless part is finished, we will begin to design the physical structure of the intelligent agent and the mechanisms it will use. Great goals have been achieved in the project from this point and it will soon reach its final result in order to fill the needs of vulnerable people.

## 7. Conclusions and future works

A novel architecture for assistance for elderly people has been presented. We expect the system will be able to impact positively, and that it will help people realize that our loved ones depend on special care and if we cannot give it to them, we have an obligation to look for the way to do it, so they can be taken care the way they deserve. The main focus of the project is to provide assistance for the elderly, encouraging the possibility to live an independent life as much as possible according to individual needs. Technology must help people, and engineers should design smart devices according to the needs of vulnerable people.

As we mentioned before, this project is in an early stage. We hope to present our results in future conferences..

## References

- [1] Casas, R. (2008). User Modelling in Ambient Intelligence for Elderly and Disabled People. In: Miesenberger K., Klaus J., Zagler W., Karshmer A. (eds) Computers Helping People with Special Needs. ICCHP 2008. Lecture Notes in Computer Science, vol. 5105. Springer, Berlin, Heidelberg
- [2] González, E. (2014). Ambient intelligence based multi-agent system for attend elderly people. 2014 9th Computing Colombian Conference, 9CCC 2014, pages 115–120.
- [3] Casaccia, S., Pietroni, F., Scalise, L., Revel, G. M., Monteriu, A., Prist, M. R., Frontoni, E., and Longhi, S. (2018). Health@Home: Pilot cases and preliminary results: Residential sensor network to promote the active aging of real users. 2018 IEEE International Symposium on Medical Measurements and Applications, Proceedings.
- [4] Gu, H., Diao, Y., Liu, W., and Zhang, X. (2011). The design of smart home platform based on Cloud Computing. Proceedings of 2011 Inter-national Conference on Electronic and Mechanical Engineering and Information Technology, EMEIT 2011, 8:3919–3922.
- [5] Cabrera, J., Mena, M., Parra, A., and Pinos, E. (2017). Intelligent assistant to control home power network. 2016 IEEE International Autumn Meeting on Power, Electronics and Computing, ROPEC 2016, (Ropez).
- [6] Longo, M., Roscia, M. C., and Zaninelli, D. (2015). Net zeroenergy of smart house design. 5th International Conference on Clean Electrical Power: Renewable Energy Resources Impact, ICCEP 2015, pages 548–553.
- [7] Verifikasi, D. A. N., Jari, C. A. P., and Sulong, G. B. I. N. (2005). Design and Development of an Automatic Fingerprint Verification System. Pages 1–5.
- [8] Cu PHAM, Y. L. and TAN, Y. (2018). A Platform for Integrating Alexa Voice Service Into. 2018 IEEE International Conference on Consumer Electronics-Taiwan (ICCE-TW) A.
- [9] Panwar, A., Singh, A., Kumawat, R., Jaidka, S., and Garg, K. (2018). Eyrie smart home automation using Internet of Things. Proceedings of Computing Conference 2017, 2018-January (July):1368–1370.
- [10] Rajalakshmi, A. and Shahnasser, H. (2018). Internet of things using nodered and alexa. 2017 17th International Symposium on Communications and Information Technologies, ISCIT 2017, 2018-January: 1–4.
- [11] Kepuska, V. and Bohouta, G. (2018). Next generation of virtual personal assistants (Microsoft Cortana, Apple Siri, Amazon Alexa and Google Home). 2018 IEEE 8th Annual Computing and Communication Workshop and Conference, CCWC 2018, 2018-January(c):99–103.

- [12] Qela, B.; Mouftah, H.T. (2012). Observe, Learn, and Adapt (OLA)—An Algorithm for Energy Management in Smart Homes Using Wireless Sensors and Artificial Intelligence. *IEEE Trans. Smart Grid* 2012, 3, 2262–2272.
- [13] Duong, T.V.; Phung, D.Q.; Bui, H.H.; Venkatesh, S. (2005). Efficient Coxian Duration Modelling for Activity Recognition in Smart Environments with the Hidden Semi-Markov Model. In *Proceedings of 2005 Intelligent Sensors, Sensor Networks and Information Processing Conference*, Melbourne, Australia, 5–8 December 2005; pp. 2262–2272.
- [14] Gaddam, A.; Mukhopadhyay, S.C.; Gupta, G.S. (2011). Trial & Experimentation of a Smart Home Monitoring System for Elderly. In *Proceedings of IEEE Instrumentation and Measurement Technology Conference (I2MTC)*, Hangzhou, China, 10–12 May 2011; pp. 1–6.
- [15] Sun, Q.; Wu P.; Wu Y. (2012). Unsupervised Multi-Level Non-Negative Matrix Factorization Model: Binary Data Case. *J. Information Security* 2012, 3, 245–250.
- [16] Gaddam, A.; Mukhopadhyay, S.C.; Gupta, G.S. (2011). Elder care based on cognitive sensor network. *IEEE Sens. J.* 2011, 11, 574–581.
- [17] Stefanov, D.H; Bien, Z.; Bang, W.-C. (2004). The smart house for older persons and persons with physical disabilities: Structure, technology arrangements, and perspectives. *IEEE Trans. Neural Syst. Rehabil. Eng.* 2004, 12, 228–250.
- [18] Sun, Q.; Hu F.; Hao Q. (2013). Human Activity Modelling and Situation Perception Based on Fiber-optic Sensing System. *IEEE Trans. Human Mach. Syst.* 2013, in press.
- [19] Zhong, D.; Ji, W.; Liu, Y.; Han, J.; Li, S. (2011). An improved routing algorithm of Zigbee Wireless sensor network for smart home system. In *Proceedings of 2011 5th International Conference on Automation, Robotics and Applications (ICARA)*, Wellington, New Zealand, 6–8 December 2011; pp. 346–350.
- [20] Tsou, Y.-P.; Hsieh, J.-W.; Lin, C.-T.; Chen, C.-Y. (2006). Building a remote supervisory control network system for smart home applications. In *Proceedings of 2006 IEEE International Conference on Systems, Man and Cybernetics, SMC'06*, Taipei, Taiwan, 8–11 October 2006; Volume 3, pp. 1826–1830.
- [21] Zhang, L.; Leung, H.; Chan, K. (2008). Information fusion based smart home control system and its application. *IEEE Trans. Consum. Electron.* 2008, 54, 1157–1165.
- [22] Madden, S.R.; Franklin, M.J.; Hellerstein, J.M.; Hong, W. (2005). TinyDB: An acquisitional query processing system for sensor networks, *ACM Trans. Database Syst.* 2005, 30, 122–173.
- [23] Mueller, R.; Alonso, G.; Kossmann, D. (2007). SwissQM: Next generation data processing in sensor networks. *CIDR* 2007, 7, 1–9.
- [24] Fortino, G.; Guerrieri, A.; O'Hare, G.; Ruzzelli, A. (2012). A flexible building management framework based on wireless sensor and actuator networks. *J. Netw. Comput. Appl.* 2012, 35, 1934–1952.

# On Digital Multimedia and Human Emotions Using EEG-Based Brain Computer Interface

Nuraini Jamil<sup>1</sup>, Abderahmane Lakas<sup>2</sup>, Sofia Ouhbi<sup>1</sup>, Abdelkader Nasreddine Belkacem<sup>2</sup>

<sup>1</sup>Department of Computer Science and Software Engineering  
{201990167, sofia.ouhbi}@uaeu.ac.ae

<sup>2</sup>Department of Computer and Network Engineering  
{alakas, belkacem}@uaeu.ac.ae

CIT, UAE University, Al Ain, P.O. Box 15551, UAE

**Abstract.** An expanding attention regarding human emotion is a pressing motive towards the current research in neuroscience and artificial intelligent. People need to communicate by exchanging information through verbal or nonverbal communication via sound, visual gestures (facial expression or hand/body gestures). In today's society, digital multimedia is one of the essential elements in daily life activities that can emphasize communication and emotions adequately. People with severe motor disabilities have difficulties in communicating and showing their emotions directly. Therefore, brain computer interface (BCI) can be a helpful tool as an alternative and assistive communication tools for sharing emotional information. This paper has conducted a review analysis to present the current trend in using digital multimedia to express the human feelings for the latest five years. Twenty-nine studies were selected from IEEEEXplore, PubMed and ScienceDirect, and classified into three major categories: methodology, multimedia type and number of emotion classes. The results show the need for more case studies and games in this area. There is also a need to increase the quality and quantity of research in emotion using the electroencephalography (EEG).

**Keywords.** Brain computer interface, BCI, Human emotion, Digital multimedia, Electroencephalography, EEG, Review.

## 1. Introduction

Communication is one of the essential tools to deliver messages and exchange information. It can be either human to human communication or human to machines/devices interaction. Some people might not have full abilities or capabilities to communicate directly because they lost control of their voluntary muscles, such as people with severe motor injuries. Technologies have dependably been helpful instruments for this matter for collecting the information to communicate based on noninvasive brain waves using biosignals measurements such as *electroencephalogram* (EEG) [1] or *magnetoencephalogram* (MEG) [2]. Recently, brain computer interface (BCI) had risen as a popular field cross the multidisciplinary work. BCI system is moreover characteristically connected with the human brain because the brain is the primary and critical part that makes human

system functioning [3]. Today's technologies even promise a variety of tools to help people with information. Progressively the video, audio, and text are widely used as tools for communication using BCI [4]. Other than that, the BCI can also be implemented in the real time environment and applications [5,6,7,8].

BCI is being mostly used in the rehabilitation process especially for people who had severe motor injuries. Previous research [9] showed that BCI can help people perform hand movements to communicate, and can restore the motor and sensory function for finger movement [10]. BCI can also be used in games for health-related project and communication. For instance, Brainio Bros 300 is a game that allow two players to communicate using BCI [11]. By playing this games, someone's intention, impression and action can be predicted. Emotions play an important contribution in communication. Emotions can imitate the human intention [12] to inform others about their feelings. The amygdala part in the brain is associated with emotion centrality, so emotion and brain have a connection to react to some of the events [13]. This happens especially when retrieving emotional events, whether they are pleasant or unpleasant ones [14]. Emotions play also essential parts in interaction, impression and decision-making. People tend to show their passion based on an emotional event. For example, people will be sad if someone is passed away. They can also be sad if they see a picture or image of people that already passed away. Digital multimedia can help to increase the way of human emotion [15] especially for the impaired people. Brainwave can be one of the tools that can be showing and detecting their emotion-based on digital multimedia, e.g. pictures, audio or text.

This paper aims to review the adaptation of digital multimedia with emotion based on BCI using only the EEG method. Based on the previous research by using EEG method is helpful, safe, and modest. The most significant EEG does not hurt the subject. It involves recording and analyzing the artifact of the brainwave. This survey of literature presents the fundamental foundation of emotion using the common digital multimedia in BCI such as pictures and videos. This paper aims also to investigate the current patterns of using digital multimedia for retrieving the emotion to propose further direction. The rest of the paper is organized as follows. EEG and emotion are explained in Section 2. While Section 3 describes the method used. Section 4 summarizes the results and discussion and conclusion are presented in Section 5 and 6, respectively

## 2. Emotion

Research on emotion recognition is rapidly increasing due to the era of artificial intelligent [16]. Many numbers of experiments have been done, and system have been designed for various application specifically for human to interact with computer or devices on an emotional level. The essential target of emotion recognition is to transform the signals and interpret the information and feelings. Emotion itself can be clustered into three categories which are: (i) arousal and valence; (ii) primary emotion; and (iii) secondary emotion. Arousal and valence for two-dimension to measure effective experiences. While the six primary emotions, the feelings that prompt in response to an event are happiness, sadness, disgust, fear, surprise and anger [17]. The secondary emotion is the reaction based on the primary emotion such as optimism, irritation or nervousness. For instance, if a student gets good marks in examination, s/he feels happy and because of this, s/he is more

motivated to do well next time. Here, happiness is the primary emotion and motivation becomes the secondary emotion. Plutchik et al. [18] proposed the three-dimensional emotion that arranges the emotion in the circle where the inner circle is primary emotion while the outer circle, which is more complex, represents the level of intensity for each of the emotions. Example: the inner circle is grief and the outer circle is pensiveness.

EEG signals can relate to emotional changes and identify the current state of human emotion especially for the impaired people who cannot express their feelings. EEG is considered one of the crucial tools to detect emotion directly from the human brain [19]. From a psychological perspective, especially for autism patients, it is difficult to communicate and transfer the information to them. Hence, their emotion plays a significant contribution during transferrable knowledge and therapy. Additionally, observing their feelings can help people around them understand and fathom their behavior. Overwhelmingly, many researchers focusing on emotion recognition have applied the EEG for reading the stimulus [20,21]. Some of them used several machine-learning algorithms to classify the emotion based on EEG [22,23,24,25]. However, they used a survey to study the impact of multimedia EEG-based tools on recognizing emotions [26] but they did not provide further direction on multimedia contents.

Nowadays, multimedia plays a vital role in society, especially in communication, learning, entertainment or professional work. Barletta et al. [27] showed the invention to control the emotion while presenting the multimedia content. Byun et al. [28] using music to investigate the characteristic for the EEG pattern to analyze emotion and Tseng et al. [29] proposed the multimedia controller to choose music based on the prevailing emotion. Likewise, a video clip is used to interpret emotions while watching the video [30,31].

### 3. Method

This paper followed the guidelines by Preferred Reporting Items for Systematic Reviews and Meta-Analysis (PRISMA) specification [32]. The electronic search online database was performed to find candidate papers from the following database: PubMed, Science Direct and IEEE Xplore to locate publication dealing with emotion and multimedia in the BCI area using the EEG signal. The reason for searching papers from 2015 to 2019 is because we want to analyze the current trend in terms of digital multimedia. The primary keywords used were: “emotions” AND “EEG” AND “multimedia”. Only full text with the English language were selected. The search was limited to the title, abstract and keywords.

The main inclusion criteria were: (1) The healthy participants can be volunteers or a patient, (2) The tools to recognize the emotion must use the digital multimedia elements, (3) Using only the EEG method. The articles of the following exclusion criteria (EC) were not included in this paper: (1) expert opinion and book chapter; (2) physiological signal or biosignal as a task, such as focus on doing the exercise and physical movement to detect the emotion; and (3) not focusing on emotion as the final outcomes. A descriptive analysis table was built to extract significant information including the classes of emotions, methodology and multimedia types. The categories of emotion did not focus on primary emotion but secondary emotion as well as the dimensional models of emotion. While the methodology was

concerned about the type of research such as experiments, case study or questionnaire, other elements being considered in this paper were tools of digital multimedia.

#### 4. Results

After retrieving all the articles from three digital databases, 218 articles were identified that included the searching keywords. Only 29 articles satisfied the inclusion criteria and were selected for review. The remaining articles were discarded because they fulfilled the exclusion criteria. The overall result of this paper is presented in Table I.

Figure 1 shows the diagram of selected studies. Uzun et al. [33] classified the emotion using multimedia but not with EEG as a conventional method, while [34] applied the EEG but focused on classifying the ethnic-based on music. Tech et al. [35] and Mothes et al. [36] experimented with the multimedia and EEG for depression for mental illness and healthy exercises, respectively.

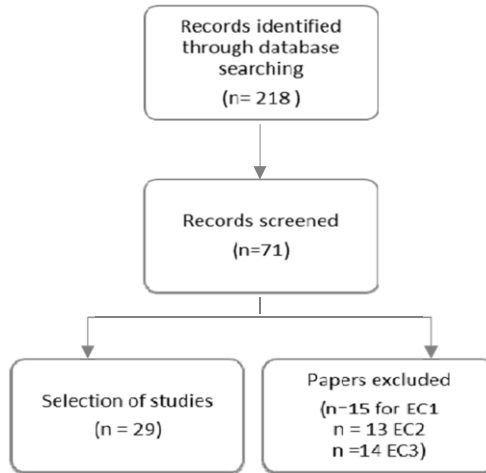

**Figure 1.** Flow diagram of study selection

Figure 2 shows the proportion of methodology being used in the selected articles. The majority of the selected articles (82%) used experiments to classify or recognize human emotion. Five articles combined both questionnaire with experiment. Only one paper used a case study in which the participant is a game player whose emotion is examined after the game and after killing enemies. The reason because to match the evaluation with the result using EEG since emotion can be very subjective and hard to identify.



**Table 1.** Characteristic and result of Included Articles.

Author	Methodology	Multimedia Type	Emotion class
Mohammadpour et al. [37]	Experiment	Pictures	fear, sad, frustrated, happy, pleasant and satisfied
Pan et al. [38]	Experiment	Pictures	happy and sad
Shahnaz et al. [39]	Experiment & Questionnaire	Music Video	valence, arousal, dominance and liking
Mehmood and Lee [40,41]	Experiment	Pictures	happy, calm, sad and scared
Raheel et al. [42]	Experiment	Multimedia	happy, relaxed, sad, and angry
Xing et al. [43]	Experiment	Video Clip	arousal and valence
Syahril [44]	Experiment	Video Clip	sad, fear, happiness and disgust.
Katsigiannis and Ramzan [45]	Experiment	Video Clip	valence, arousal, and dominance
Soleymani et al. [46]	Experiment	Video Clip	arousal and valence
Yoo and Hong [47]	Experiment	Pictures	arousal and valence
Ntalampiras et al [48]	Experiment	Music	arousal and valence
Abadi et al. [49]	Experiment	Music Video	valence, arousal, and dominance
Al Madi and Khan [50]	Experiment & Questionnaire	Video Clip Text	arousal and valence
Ding et al. [51]	Experiment	Video Clip	arousal and valence
Miranda-Correa and Patras [52]	Experiment & Questionnaire	Video Clip	arousal and valence
Antons et al. [53]	Experiment	Video Clip	valence, arousal, dominance, liking, quality
Raheel et al. [54]	Experiment	Video Clip	arousal and valence
Clerico et al. [55]	Experiment	Music Video	arousal, valence, dominance and liking
Han et al. [56]	Experiment & Questionnaire	Video Clip	arousal
Liang et al. [57]	Experiment	Video Clip	arousal, valence, dominance and liking
Kaur et al. [58]	Experiment	Video Clip	calm, anger and happiness
Qayyum et al. [59]	Experiment	Video Clip	happy sad, neutral, love, angry, surprise
Gaubal et al. [60]	Experiment	Video Clip	valence
Riaz et al. [61]	Experiment	Pictures	arousal and valence
Kurbalija et al. [62]	Experiment	Speech Music	angry, fear, happy, neutral, sad, and surprise
Singhal et al. [63]	Experiment & Questionnaire	Video	happy, sad and neutral
Stein et al. [64]	Case study	Game	arousal and valence
Gupta and Falk [65]	Experiment	Music Video	arousal, valence, dominance and liking

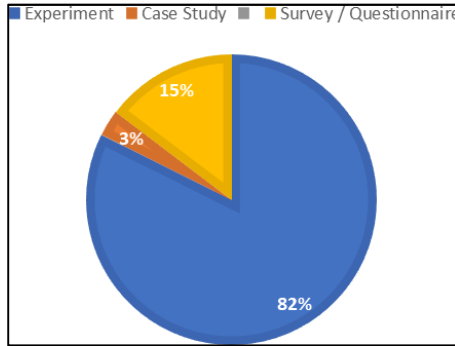

Figure 2. Methodology

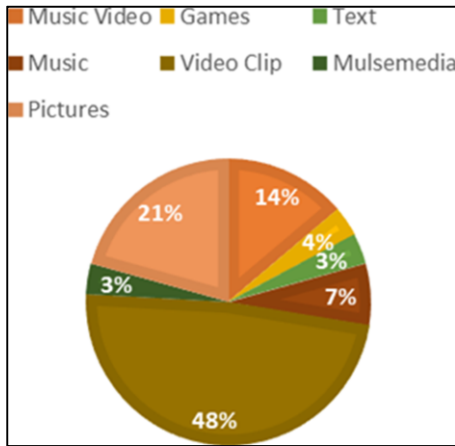

Figure 3. Multimedia Type

Figure 3 presents the multimedia types identified in all the selected studies. The majority of the human emotion based on digital multimedia are empirically evaluated using the video clips. Music videos and pictures were mainly conducted during the experiments. Text, games and mulsemedia were used in a few papers. Figure 4 illustrates the categories of emotion identified in the selected papers. The emotion was classified and recognized based on two class of model dimensional (arousal or valence), 4 class of model dimensional (arousal, valence, liking and dominance), primary emotion and combination within primary and secondary emotion. Many kinds of research focus on classifying the emotion within two classes that belong to arousal and valence. Additionally, other class such as only valence or only arousal also become the major contribution for human motion with 13% equally with two models dimensional. This class belongs to emotion that being classified or recognized using one emotion, which can be either valence or arousal, or classified the emotion into three categories: arousal, valence and dominance. The combination between primary and secondary emotion was identified only in 3% of the selected papers.

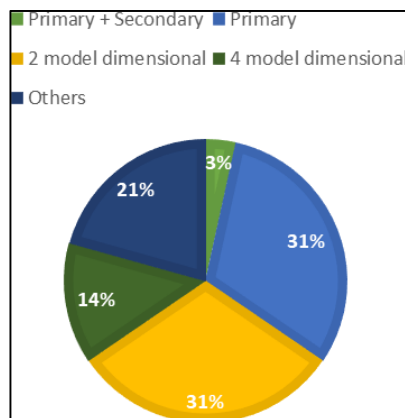

Figure 4. Emotion classification / recognition

## 5. Discussion

The study of emotions crosses disciplinary boundaries with the contribution and collaboration between medical, psychology, education, and entertainment. Human emotion is a research topic that has implications to be extended to future technologies with artificial intelligence [66]. Digital multimedia is now progressively used in every single aspect of human life. However, individual affection for multimedia elements can affect emotions and daily life performance. This paper investigated the current trend of different multimedia elements for the future direction to identify human emotion. Despite the fact that multimedia and emotion are becoming increasingly important, only 29 selected studies discussed the usage of digital multimedia that can erupt emotions. This might be due to the search keyword used since we used the general terms of “multimedia” rather than using the specific multimedia keyword such as “Games”, “Music” or “Video”. The majority of the selected studies used experiments to handle EEG and classify feelings.

The results showed also that video clips consisted of the majority of tools to perform emotion recognition [43,44,45,46,51,52,54]. This can be because video is the most popular digital multimedia, which includes audio and continuous images. In this case the emotion is triggered based on two media at the same time. Only [42] used mulsemmedia combined with the action of smelling while watching the video during an experiment. Text [50] and games [64] are less favorable to be tested for human emotion. The reason might be because nowadays more people communicate with emoji or .gif rather than direct text. The quantity of the games as multimedia elements can be increased to identify the human emotions due to the demand. Most of people spend their free time playing video-games. Future games can be developed to control human emotion. In line with this paper, the emotion can be classified into few categories which can be extended to include more complex human emotions. More research is needed to study human emotion that relates to digital multimedia. In future work, we intend to conduct an EEG experiment in this topic.

## Acknowledgment

This paper is part of the Startup project (31T130) funded by UAEU.

## References

- [1] Wolpaw, J.R., Birbaumer, N., McFarland, D.J., Pfurtscheller, G. and Vaughan, T.M., 2002. Brain-computer interfaces for communication and control. *Clinical neurophysiology*, 113(6), pp.767-791.
- [2] Baillet, S., Garnero, L., Marin, G. and Hugonin, J.P., 1999. Combined MEG and EEG source imaging by minimization of mutual information. *IEEE transactions on biomedical engineering*, 46(5), pp.522-534.
- [3] Gordon, E.M., Laumann, T.O., Adeyemo, B. and Petersen, S.E., 2017. Individual variability of the system-level organization of the human brain. *Cerebral Cortex*, 27(1), pp.386-399.
- [4] Ebrahimi, T., Vesin, J.M. and Garcia, G., 2003. Brain-computer interface in multimedia communication. *IEEE signal processing magazine*, 20(1), pp.14-24
- [5] Belkacem, A.N., Ishiguro, H., Nishio, S., Hirata, M. and Suzuki, T., 2018, July. Real-time MEG-based brain-geminoïd control using single-trial SVM classification. In 2018 3rd International Conference on Advanced Robotics and Mechatronics (ICARM) (pp. 679-684). IEEE.
- [6] Belkacem, A.N., Saetia, S., Zintus-art, K., Shin, D., Kambara, H., Yoshimura, N., Berrached, N. and Koike, Y., 2015. Real-time control of a video game using eye movements and two temporal EEG sensors. *Computational intelligence and neuroscience*, 2015.
- [7] Belkacem, A.N., Shin, D., Kambara, H., Yoshimura, N. and Koike, Y., 2015. Online classification algorithm for eye-movement-based communication systems using two temporal EEG sensors. *Biomedical Signal Processing and Control*, 16, pp.40-47.
- [8] Shao, L., Zhang, L., Belkacem, A.N., Zhang, Y., Chen, X., Li, J. and Liu, H., 2020. EEG-Controlled Wall-Crawling Cleaning Robot Using SSVEP-Based Brain-Computer Interface. *Journal of Healthcare Engineering*, 2020.
- [9] Belkacem, A.N., Nishio, S., Suzuki, T., Ishiguro, H. and Hirata, M., 2018. Neuromagnetic decoding of simultaneous bilateral hand movements for multidimensional brain-machine interfaces. *IEEE Transactions on Neural Systems and Rehabilitation Engineering*, 26(6), pp.1301-1310.
- [10] Chen, C., Zhang, J., Belkacem, A.N., Zhang, S., Xu, R., Hao, B., Gao, Q., Shin, D., Wang, C. and Ming, D., 2019. G-causality brain connectivity differences of finger movements between motor execution and motor imagery. *Journal of healthcare engineering*, 2019
- [11] Sumi, K., Yabuki, K., Tiam-Lee, T.J., Belkacem, A.N., Ferre, Q., Hirai, S. and Endo, T., 2019. A cooperative game using the P300 EEG-based brain-computer interface. In *Assistive and Rehabilitation Engineering*. IntechOpen.
- [12] Lee, H., Choi, Y.S., Lee, S. and Park, I.P., 2012, January. Towards unobtrusive emotion recognition for affective social communication. In 2012 IEEE Consumer Communications and Networking Conference (CCNC) (pp. 260-264). IEEE.
- [13] Mackay, D.G., Shafto, M., Taylor, J.K., Marian, D.E., Abrams, L. and Dyer, J.R., 2004. Relations between emotion, memory, and attention: Evidence from taboo Stroop, lexical decision, and immediate memory tasks. *Memory & Cognition*, 32(3), pp.474-488.
- [14] Garfinkel, S.N. and Critchley, H.D., 2013. Interoception, emotion and brain: new insights link internal physiology to social behaviour. Commentary on: "Anterior insular cortex mediates bodily sensibility and social anxiety" by Terasawa et al.(2012). *Social cognitive and affective neuroscience*, 8(3), pp.231-234.
- [15] Heidig, S., Müller, J. and Reichelt, M., 2015. Emotional design in multimedia learning: Differentiation on relevant design features and their effects on emotions and learning. *Computers in Human Behavior*, 44, pp.81-95
- [16] Martinez-Miranda, J. and Aldea, A., 2005. Emotions in human and artificial intelligence. *Computers in Human Behavior*, 21(2), pp.323-341.
- [17] Ekman, P., 1999. Basic emotions. *Handbook of cognition and emotion*, 98(45-60), p.16.
- [18] Plutchik, Robert, and Henry Kellerman, eds. *Theories of emotion*. Vol. 1. Academic Press, 2013.
- [19] Liu, Y., Sourina, O. and Nguyen, M.K., 2010, October. Real-time EEG-based human emotion recognition and visualization. In 2010 international conference on cyberworlds (pp. 262-269). IEEE.
- [20] Correa, J.A.M., Abadi, M.K., Sebe, N. and Patras, I., 2018. Amigos: a dataset for affect, personality and mood research on individuals and groups. *IEEE Transactions on Affective Computing*.
- [21] Thammasan, N., Fukui, K.I. and Numao, M., 2016. Fusion of EEG and Musical Features in Continuous Music-emotion Recognition. *arXiv preprint arXiv:1611.10120*.

- [22] Taran, S. and Bajaj, V., 2019. Emotion recognition from single-channel EEG signals using a two-stage correlation and instantaneous frequency-based filtering method. *Computer methods and programs in biomedicine*, 173, pp.157-165.
- [23] Zubair, M. and Yoon, C., 2018. EEG Based Classification of Human Emotions Using Discrete Wavelet Transform. In *IT Convergence and Security 2017* (pp. 21- 28). Springer, Singapore.
- [24] Bhatti, A.M., Majid, M., Anwar, S.M. and Khan, B., 2016. Human emotion recognition and analysis in response to audio music using brain signals. *Computers in Human Behavior*, 65, pp.267-275.
- [25] Lin, Y.P., Wang, C.H., Jung, T.P., Wu, T.L., Jeng, S.K., Duann, J.R. and Chen, J.H., 2010. EEG-based emotion recognition in music listening. *IEEE Transactions on Biomedical Engineering*, 57(7), pp.1798-1806.
- [26] Alarcao, S.M. and Fonseca, M.J., 2017. Emotions recognition using EEG signals: A survey. *IEEE Transactions on Affective Computing*.
- [27] Barletta, A., Moser, B. and Mayer, M., Sony Deutschland GmbH, 2010. Emotion controlled system for processing multimedia data. U.S. Patent 7,698,238.
- [28] Byun, S.W.; Lee, S.P.; Han, H.S. Feature selection and comparison for the emotion recognition according to music listening. In *Proceedings of the 2017 International Conference on Robotics and Automation Sciences (ICRAS)*, Hong Kong, China, 26–29 August 2017
- [29] Tseng, K.C.; Lin, B.S.; Wong, A.M.K.; Lin, B.S. Design of a mobile brain computer interface-based smart multimedia controller. *Sensors* 2015, 15, 5518–5530
- [30] Murugappan, M.; Nagarajan, R.; Yaacob, S. Combining spatial filtering and wavelet transform for classifying human emotions using EEG Signals. *J. Med. Biol. Eng.* 2011, 31, 45–51
- [31] Khosrowabadi, R.; Quek, H.C.; Wahab, A.; Ang, K.K. EEG-based emotion recognition using self-organizing map for boundary detection. In *Proceedings of the 2010 20th International Conference on Pattern Recognition*, Istanbul, Turkey, 23–26 August 2010.
- [32] Moher, D., Liberati, A., Tetzlaff, J. and Altman, D.G., 2009. Preferred reporting items for systematic reviews and meta-analyses: the PRISMA statement. *Annals of internal medicine*, 151(4), pp.264-269.
- [33] Uzun, A.M. and Yildirim, Z., 2018. Exploring the effect of using different levels of emotional design features in multimedia science learning. *Computers & Education*, 119, pp.112-128.
- [34] Bajoulvand, A., Marandi, R.Z., Daliri, M.R. and Sabzpooshan, S.H., 2017. Analysis of folk music preference of people from different ethnic groups using kernel-based methods on EEG signals. *Applied Mathematics and Computation*, 307, pp.62-70.
- [35] Tech, C.K.M. and Sahni, S., 2019. Advanced Spatially Specific Neurofeedback for Symptoms of Depression and Its Electroencephalographic Correlates. *Alternative therapies in health and medicine*, 25(3), pp.54-63.
- [36] Mothes, H., Leukel, C., Jo, H.G., Seelig, H., Schmidt, S. and Fuchs, R., 2017. Expectations affect psychological and neurophysiological benefits even after a single bout of exercise. *Journal of behavioral medicine*, 40(2), pp.293- 306.
- [37] Mohammadpour, M., Hashemi, S.M.R. and Houshmand, N., 2017, April. Classification of EEG-based emotion for BCI applications. In *2017 Artificial Intelligence and Robotics (IRANOPEN)* (pp. 127-131). IEEE.
- [38] Pan, J., Li, Y. and Wang, J., 2016, July. An EEG-based brain-computer interface for emotion recognition. In *2016 international joint conference on neural networks (IJCNN)* (pp. 2063-2067). IEEE.
- [39] Shahnaz, C. and Hasan, S.S., 2016, November. Emotion recognition based on wavelet analysis of Empirical Mode Decomposed EEG signals responsive to music videos. In *2016 IEEE Region 10 Conference (TENCON)* (pp. 424- 427). IEEE.
- [40] Mehmood, R.M. and Lee, H.J., 2016, July. Emotion recognition from EEG brain signals based on particle swarm optimization and genetic search. In *2016 IEEE International Conference on Multimedia & Expo Workshops (ICMEW)* (pp. 1-5). IEEE.
- [41] Mehmood, R.M. and Lee, H.J., 2015, June. Emotion classification of EEG brain signal using SVM and KNN. In *2015 IEEE International Conference on Multimedia & Expo Workshops (ICMEW)* (pp. 1-5). IEEE.
- [42] Raheel, A., Majid, M., Anwar, S.M. and Bagci, U., 2019. Emotion Classification in Response to Tactile Enhanced Multimedia using Frequency Domain Features of Brain Signals. *arXiv preprint arXiv:1905.10423*.
- [43] Xing, B., Zhang, H., Zhang, K., Zhang, L., Wu, X., Shi, X., Yu, S. and Zhang, S., 2019. Exploiting EEG Signals and Audiovisual Feature Fusion for Video Emotion Recognition. *IEEE Access*, 7, pp.59844-59861.
- [44] Syahril, S., Subari, K.S. and Ahmad, N.N., 2016, November. EEG and emotions:  $\alpha$ -peak frequency as a quantifier for happiness. In *2016 6th IEEE International Conference on Control System, Computing and Engineering (ICCSCE)* (pp. 217-222). IEEE.

- [45] Katsigiannis, S. and Ramzan, N., 2017. DREAMER: A database for emotion recognition through EEG and ECG signals from wireless low-cost off-the-shelf devices. *IEEE journal of biomedical and health informatics*, 22(1), pp.98- 107
- [46] Soleymani, M., Pantic, M. and Pun, T., 2011. Multimodal emotion recognition in response to videos. *IEEE transactions on affective computing*, 3(2), pp.211-223.
- [47] Yoo, G. and Hong, S., 2016, February. Emotion evaluation analysis and system design of biosignal. In 2016 International Conference on Platform Technology and Service (PlatCon) (pp. 1-4). IEEE.
- [48] Ntalampiras, S., Avanzini, F. and Ludovico, L.A., 2019, July. Fusing Acoustic and Electroencephalographic Modalities for User-Independent Emotion Prediction. In 2019 IEEE International Conference on Cognitive Computing (ICCC) (pp. 36-41). IEEE.
- [49] Abadi, M.K., Subramanian, R., Kia, S.M., Avesani, P., Patras, I. and Sebe, N., 2015. DECAF: MEG-based multimodal database for decoding affective physiological responses. *IEEE Transactions on Affective Computing*, 6(3), pp.209-222.
- [50] Al Madi, N.S. and Khan, J.I., 2016, April. Measuring learning performance and cognitive activity during multimodal comprehension. In 2016 7th International Conference on Information and Communication Systems (ICICS) (pp. 50-55). IEEE.
- [51] Ding, Y., Hu, X., Xia, Z., Liu, Y.J. and Zhang, D., 2018. Inter-brain EEG Feature Extraction and Analysis for Continuous Implicit Emotion Tagging during Video Watching. *IEEE Transactions on Affective Computing*.
- [52] Miranda-Correa, J.A. and Patras, I., 2018, May. A Multi-Task Cascaded Network for Prediction of Affect, Personality, Mood, and Social Context Using EEG Signals. In 2018 13th IEEE International Conference on Automatic Face & Gesture Recognition (FG 2018) (pp. 373-380). IEEE.
- [53] Antons, J.N., Arndt, S., De Moor, K. and Zander, S., 2015, May. Impact of perceived quality and other influencing factors on emotional video experience. In 2015 Seventh International Workshop on Quality of Multimedia Experience (QoMEX) (pp. 1-6). IEEE.
- [54] Raheel, A., Majid, M. and Anwar, S.M., 2019. A study on the effects of traditional and olfaction enhanced multimedia on pleasantness classification based on brain activity analysis. *Computers in Biology and Medicine*, 114, p.103469.
- [55] Clerico, A., Tiwari, A., Gupta, R., Jayaraman, S. and Falk, T.H., 2018. Electroencephalography amplitude modulation analysis for automated affective tagging of music video clips. *Frontiers in Computational Neuroscience*, 11, p.115.
- [56] Han, C.H., Lee, J.H., Lim, J.H., Kim, Y.W. and Im, C.H., 2017. Global electroencephalography synchronization as a new indicator for tracking emotional changes of a group of individuals during video watching. *Frontiers in human neuroscience*, 11, p.577.
- [57] Liang, Z., Oba, S. and Ishii, S., 2019. An unsupervised EEG decoding system for human emotion recognition. *Neural Networks*, 116, pp.257-268.
- [58] Kaur, B., Singh, D. and Roy, P.P., 2018. EEG based emotion classification mechanism in BCI. *Procedia computer science*, 132, pp.752-758.
- [59] Qayyum, H., Majid, M., ul Haq, E. and Anwar, S.M., 2019. Generation of personalized video summaries by detecting viewer's emotion using electroencephalography. *Journal of Visual Communication and Image Representation*, 65, p.102672.
- [60] Gauba, H., Kumar, P., Roy, P.P., Singh, P., Dogra, D.P. and Raman, B., 2017. Prediction of advertisement preference by fusing EEG response and sentiment analysis. *Neural Networks*, 92, pp.77-88.
- [61] Riaz, A., Gregor, S., Dewan, S. and Xu, Q., 2018. The interplay between emotion, cognition and information recall from websites with relevant and irrelevant images: A Neuro- IS study. *Decision Support Systems*, 111, pp.113-123.
- [62] Kurbalija, V., Ivanović, M., Radovanović, M., Geler, Z., Dai, W. and Zhao, W., 2018. Emotion perception and recognition: an exploration of cultural differences and similarities. *Cognitive Systems Research*, 52, pp.103-116.
- [63] Singhal, A., Kumar, P., Saini, R., Roy, P.P., Dogra, D.P. and Kim, B.G., 2018. Summarization of videos by analyzing affective state of the user through crowdsourcing. *Cognitive Systems Research*, 52, pp.917-930.
- [64] Stein, A., Yotam, Y., Puzis, R., Shani, G. and Taieb- Maimon, M., 2018. EEG-triggered dynamic difficulty adjustment for multiplayer games. *Entertainment computing*, 25, pp.14-25.
- [65] Gupta, R. and Falk, T.H., 2016. Relevance vector classifier decision fusion and EEG graph-theoretic features for automatic affective state characterization. *Neurocomputing*, 174, pp.875-884.
- [66] Shank, D.B., Graves, C., Gott, A., Gamez, P. and Rodriguez, S., 2019. Feeling our way to machine minds: People's emotions when perceiving mind in artificial intelligence. *Computers in Human Behavior*, 98, pp.256- 266.

# Automatic Generation of Customised Exergames for Home Rehabilitation Based on Physical Mobility Constraints and Key Performance Indicators

Cristian GÓMEZ-PORTES <sup>a</sup>, David VALLEJO <sup>a 1</sup>, Ana I. MOLINA <sup>a</sup>,  
Carmen LACAVE <sup>a</sup>

<sup>a</sup> *Faculty of Computer Science (University of Castilla-La Mancha),  
Paseo de la Universidad 4, 13071 Ciudad Real, Spain*

**Abstract.** Remote rehabilitation systems allow the supervision and monitoring of physical exercises by therapists without the need to move, temporally and spatially, the patients who perform them. The main advantage of this approach is the patient's increased autonomy and flexibility to carry out rehabilitation from home, especially in situations of lock-down and movement restrictions. In order to make the execution of repetitive exercises more dynamic and to motivate patients to perform them from home, in recent years gamification techniques, exergames, and serious games have been extensively used. In this context, and to increase the remote monitoring capabilities of therapists, this paper proposes the use of a language for the specification of exergames oriented to the definition, by therapists, of key performance indicators and mobility constraints adapted to the rehabilitation process of each patient. The sentences of this language can be processed by software, allowing the automatic generation of personalised games for rehabilitation. A case study describing an exergame for the upper limb rehabilitation of stroke patients is also presented.

**Keywords.** home rehabilitation, customised exergames, automatic code generation, key performance indicators

## 1. Introduction

The technological tools that support rehabilitation at home aims at increasing the autonomy of patients when performing physical rehabilitation exercises [19]. This increase in autonomy is a direct consequence of the elimination of temporal and spatial barriers, traditionally linked to the face-to-face and synchronous supervision of a therapist with respect to his/her patients [16]. This advantage is more than evident in situations such as that which, unfortunately, occurs in the current sanitary context, where there is physical confinement in a large part of the world. Even in countries with low-and middle-income [24], where access to clinicians capable of guiding the rehabilitation process is, more often than not, non-existent.

Home rehabilitation tools face the dual challenge of motivating patients to perform inherently repetitive exercises and to ensure an adequate synchronous remote supervision by therapists. [3].

The first challenge is not an easy one, since without the right motivation, a patient who does not feel obliged to have a therapist by his/her side could abandon the exercise routines if the artificial system is not capable of providing an adequate, real-time *feedback*. In this sense, in recent years a whole range of gamification techniques and serious games have been used, mainly aimed at turning an extremely repetitive task, such as physical rehabilitation, into a playful activity [15]. In essence, the patient is being rehabilitated while playing or feeling immersed in a virtual world in which he or she recreates real-world activities [11].

The second challenge brings up the need for home rehabilitation to be done in a safe environment and, at the same time, to ensure that the patient is properly monitored by the therapist. This supervision does not have to be synchronous. In fact, it is usually of an asynchronous nature which maintains a one-to-many relationship between therapist and patients. In this context, the use of metrics and indicators that the therapist can access at all times to know the level of progression of their patients and adapt the therapy to their dynamic and changing situation is especially relevant.

Ideally, the design and development of rehabilitation support tools should be carried out through a co-creative approach between clinicians, patients, and developers. In this way, in addition to involving all the agents in the rehabilitation process from its genesis, the chances of success of the use of technology in the medical field increase considerably. One of the dimensions to consider in this approach is the potential capacity of the therapists themselves to become content generators. This capacity refers to the use of technological tools by therapists, which are intuitive and easy to use. Also, it allows them to design their own rehabilitation exercises in a playful context and with the possibility of defining the metrics they will use to monitor their patients.

In this particular context, the present work proposes the use of a system capable of automatically generating personalised therapeutic exergames for home rehabilitation based on the design specified by the therapists themselves. A therapeutic exergame can be understood as a game that tries to recreate, through a virtual or augmented world, a physical exercise linked to a therapeutic treatment. Typically, some kind of device will be needed to recognise the patient's movements or to track his/her body parts. In our work, we make use of Azure Kinect DK<sup>2</sup>.

The design of exergames by therapists, currently represented in a formal way by a language devised by the authors, makes possible both the inclusion of game mechanics, which the therapist can associate with physical rehabilitation exercises, and the definition of performance indicators, aimed at measuring the progress of each patient. The sentences of this language are interpreted by a processing module capable of generating exergames or therapeutic games. This proposal is framed within the concept of personalised rehabilitation, that is, it adopts a philosophy in which the therapist is provided with technological tools to treat each patient individually.

The rest of the work is structured as follows. Section 2 provides a description of related work within the scope of the proposal. Then, section 3 outlines the main sentences of the language that can be used to define exergames, discussing the most relevant char-

---

<sup>2</sup><https://azure.microsoft.com/en-us/services/kinect-dk/>



acteristics of the language and with a special emphasis on the specification of mobility constraints and the use of performance indicators. Section 4 introduces a case study in which an exergame has been generated for home rehabilitation of stroke patients. Finally, section 5 presents the conclusions obtained and outlines a series of future lines of research.

## **2. Related work**

In the last decade, technological advances have been incorporated into physical rehabilitation treatments with the aim of improving the quality of life of patients [19]. Among the most outstanding are solutions based on motion capture devices, such as Microsoft Kinect, whose use has led to a large number of systems employed as a complementary tool in rehabilitation therapies [28]. In fact, their effectiveness has been clearly demonstrated [17,6], which has meant the development of systems that provide rehabilitation from home [26,27,9].

However, the fact that technology enables remote rehabilitation does not mean that it is entirely effective. Taking this into account, there are several works in the literature that choose to apply gamification techniques and serious games to the rehabilitation process [22]. Indeed, this approach has been successfully studied in young people, adults, and elderly, providing clear evidence of its effectiveness [2,13,10,14].

Nevertheless, in the vast majority of cases, these games are usually aimed at patients with a specific pathology [1,4]. Consequently, their application in other contexts is limited, given that they have not been created considering patients with multiple limitations [18]. In addition, misuse or poor design of these games can aggravate existing patient injuries or even cause new ones [25]. In view of this situation, there are several proposals that try to solve this issue from two main points: the efficient and effective design of exergames, and the customisation and automatic generation of them.

The design of games for people with needs requires the consideration of obstacles or barriers that prevent their development effectively, safely, and adequately. For example, [15] proposes to design games considering the user's profile, as well as taking care of the quality of the game or its experience.

Similarly, [29] provides recommendations for an optimal exergame design, including user-centred design. On the other hand, [21] presents a methodology based on four phases focused on the creation of effective and safe exergames. Along these lines, [20] presents a set of guidelines and best practices for the design of exergames, among which highlight the use of daily activities such as rehabilitation exercises, games that provide fun experiences, or even those that promote competitiveness.

On the other hand, the second research line consists in providing tools to clinicians so that they can configure game parameters and thus reducing the cost and time involved in their production. Taking this into account, the literature covers general purpose solutions to facilitate the automatic generation of custom exergames. For example, [8] presents a system that integrates the concept of narrative story, where experts, without knowledge in information and communication technologies, adapt and customise training games for elderly and disabled people. In this line, [7] establishes a platform that offers a graphic tool for professionals to create games adapted to the needs of patients.

Finally, in [12], the authors describe a cooperative environment, in which clinical professionals record postures that are later reproduced by a 3D avatar to facilitate the

patient the execution of rehabilitation exercises. Similarly, [5] presents an system which analyses a video of a rehabilitation exercise, generating a grammar used to produce animations applied to a 3D avatar for guiding patients to perform rehabilitation.

### 2.1. Our proposal

The study of previous works has served as a basis for defining the requirements of a home-based rehabilitation system based on exergames.

At the hardware support level, the use of a more up-to-date compact and low-cost device is proposed (Azure Kinect DK), which facilitates the installation of the system at home. This device allows to capture accurately patient movements, as well as saving the information generated during a therapy thanks to a cloud storage support.

Regarding the feedback received by the patient, it is considered appropriate that this can be immediate, by the application itself, or deferred, by the therapist. In addition to the indicators used by most systems of this type (based on the game score or the evaluation of the specialist), it is considered useful to include a more complete set of indicators, based on the time of completion of the exercise, as well as on the precision and range of movements performed.

A noteworthy and differentiating aspect of the proposal is the support to the specification and personalisation of the exercise routines, as well as the automatic generation of the exergames, which allows the system to adapt them considering the patient needs. This design and generation process can be carried out in the context of a co-creative methodological proposal between the different stakeholders involved in rehabilitation therapy.

## 3. Definition of personalised mobility constraints and key performance indicators

The created language for defining exergames is supported by the GL Transmission Format (glTF) specification [23], which represents an open standard devised for the efficient transmission and loading of 3D models and scenes into applications. glTF was the adopted standard because it involves an extensible format regarding the management and integration of 3D contents. With glTF, it is possible to describe scenes by means of JSON files, which can be extended as needed. Particularly, glTF extensions provide properties, semantics and formats to be included.

From a high-level point of view, exergames defined with this language are composed of 3 major components: *scene*, *actors*, and *gameplay*.

- *Scene*. This component represents the different exergame views, which can be understood as the different parts of a video game. 3 basic views are proposed for every exergame: i) *tutorial view*, which aims at playing an animation of the virtual avatar that shows how the exergame must be executed by the patient, ii) *participation view*, related to the situation where the patient actually plays and needs to reach a specific goal, and iii) *results view*, which provides real-time, visual feedback to the patient.
- *Actors*. This element is composed of exergame items that recreate some type of behaviour, such as those associated to 3D animations or transforms in the 3D space to translate/rotate objects. Every exergame contains, at least, one actor: the virtual avatar that replicates the patient's movements.

- *Gameplay*. This component refers to the actions that the patient must do to make a repetition of the exergame. The correct execution of the game dynamics will trigger, consequently, a sequence of actions, such as increasing the number of performed repetitions.

In this general context, this work focuses on the definition of mobility constraints by the therapist when performing exergames. It is quite common that, when a patient performs rehabilitation exercises, he/she tries to compensate the lack of mobility (or strength) in a joint with the use of other parts of his/her body. A specific example might be using the hip to compensate for the lack of mobility when performing a shoulder mobility exercise.

In this sense, listing 1 shows an example that contains three constraints associated with an exergame. Thus, the component *constraints* is a list of elements (actually dictionaries) that comprises the individual definition of each constraint. This definition is simple, since it is only necessary to specify the joint that the patient should not move when performing the exergame that is being defined (the component *joint*), along with the level of flexibility of compliance with the constraint (the component *flexibility*). The latter component contemplates the use of fuzzy logic to easily represent text labels associated with various degrees of constraint compliance: *low*, *medium*, and *high*, depending on the level of flexibility that the therapist desires to associate to each patient.

Listing 1: Example of definition that involves 3 constraints (component *constraints*) related to an exergame that recreates the movement *shoulder abduction*.

```
"constraints": [
  {
    "joint_name": "hip-centre",
    "flexibility": "middle"
  },
  {
    "joint_name": "spine",
    "flexibility": "low"
  },
  {
    "joint_name": "shoulder-centre",
    "flexibility": "low"
  }
]
```

On the other hand, another of the aspects that we mainly deal with in this article is the definition of metrics or performance indicators, associated with the monitoring of patients and their level of improvement as rehabilitation progresses. Listing 2 shows the different types of indicators contemplated in the current definition of the language.

The first of these is called *performance*, and aims to measure how well the patient has performed the exergame. To do this, a *fuzzyfication* of the discrete score obtained by the patient is used. For example, if the obtained score is *low*, then the feedback visually given to the patient in the exergame will be that of the label *not bad*.

The second indicator, *rehabilitation\_time*, serves to explicitly activate the measurement of the time the patient has needed to perform the exergame. Typically, the execution of an exergame will involve a certain number of repetitions associated with the ex-

ercise being modelled. In addition, this indicator allows the therapist to activate another internal metric associated with the time spent between consecutive repetitions (element *time\_between\_repetitions*). When the exergame code is automatically generated, it will be able to perform this measurement.

Listing 2: Example of definition that involves key performance indicators.

```
"metrics" : [
  {
    "kpi"      : "performance",
    "score"    : ["low", "average", "high"],
    "labels"   : ["not bad", "good", "perfect"]
  },
  {
    "kpi"      : "rehabilitation_time",
    "time_between_repetitions": true
  },
  {
    "kpi"      : "mobility",
    "joints"   : ["shoulder-right"]
  }
]
```

Finally, the indicator *mobility* is designed so that the software that runs the exergame is able to monitor the level of mobility of a given set of joints. This set is specified by the component *joints*. From an internal point of view, the maximum level of amplitude recorded when performing an exergame (in degrees), considering one or several joints, will be stored.

#### 4. Case study: exergame for the upper limb rehabilitation of stroke patients

This section offers a description of an exergame generated for the physical rehabilitation, from home, of patients affected by stroke.

##### 4.1. Overview of the exergame definition language

The current version of the exergame definition language, previously introduced, allows the automatic generation of the game mechanics and the associated metrics, as an example, with respect to the exergame shown in Figure 1. This exercise is done in a virtual gym, with the aim of making the patient feel immersed in a sporty scenario and thus allowing him/her to abstract from the fact that he/she is actually doing the exercise in his/her own living room. The physical exercise itself consists of the execution of a lateral movement with the right arm, which is part of those routines aimed at improving the quality of life of patients affected by hemiparesis (loss of strength and dexterity) or hemiplegia (paralysis).

Before going deeper into the definition of mobility constraints and performance indicators, the main visual characteristics of the exergame are summarised next:

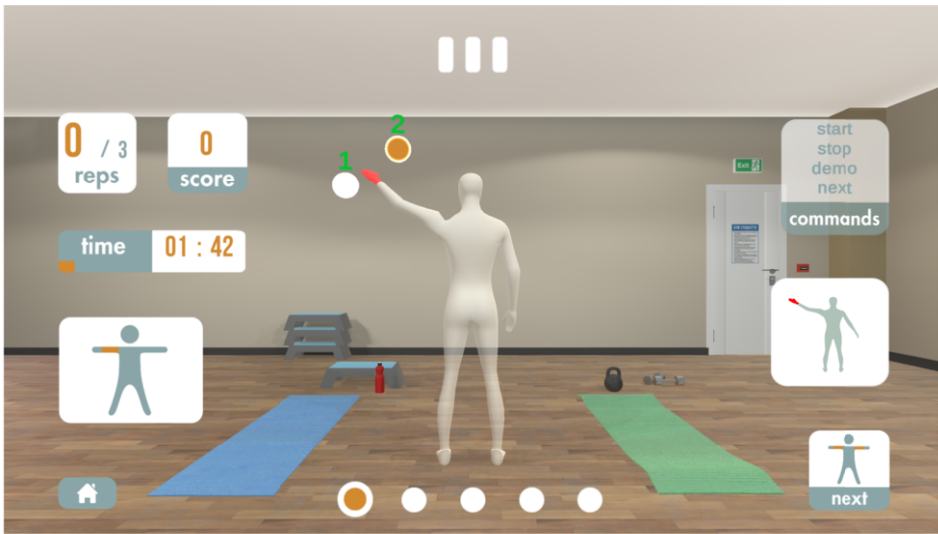

**Figure 1.** Visual aspect of the generated exergame. The visual feedback provided to the patient offers information about the current exercise, i.e., how it must be performed, the number of remaining repetitions, or the obtained scored. The interaction is carried out through voice commands.

1. The dominant interaction mechanism is voice-based in order for the patient to issue voice commands. This applies in the context of the entire system, including, for example, the exergame selection menu. At the top of the interface, a *boometer* is displayed, which serves to provide visual feedback to the patient when he/she speaks. Occasionally, stroke patients cannot use traditional interaction mechanisms, such as mouse and keyboard.
2. The components on the left contain information about the execution of the exergame, including the score as a basic gamification technique.
3. On the right side, a context component is shown that contains a textual description of the voice commands the patient can issue. One of them is the command *demo*. This command is used to play a visual animation for demonstrating the movement a patient must perform.
4. In the central part, the virtual avatar appears, which will recreate the patient's movements. Currently, the Azure Kinect DK device is used to obtain the tracking information of the patient's joints, which includes the rotations and positions in 3D space of those directly involved in the execution of the exergame.

With respect to the constraints defined for this exergame, those specified in listing 1, previously discussed in section 3, in relation to the exercise of *shoulder abduction*, apply. Thus, it is intended that the patient exercises the recovery of mobility in the right lateral part of his/her upper trunk, but avoiding compensation with the hip or upper trunk. Similarly, the performance indicators defined in listing 2 are activated for the exergame that makes up this case study.

#### 4.2. Preliminary clinical evaluation

This exergame was presented to a group of 12 therapists of the General University Hospital of Ciudad Real (Spain), with the aim of knowing its applicability in a home rehabil-

itation context. The presentation consisted of a detailed description of the system, along with the exergame demonstration. The experts could also ask some doubt they had. The meeting lasted about 45 minutes. One week later, all therapists were invited to fill out a survey, 4 of whom responded offering very valuable information in order to continue with the project development regarding mobility constraints and performance indicators. The content of the questionnaire can be accessed online<sup>3</sup>.

Among the results obtained from the experts' answers we highlight the most outstanding ones. Three of the four therapists agreed that the system would be very useful for i) adults affected by stroke, ii) adults who require another physical rehabilitation process, and iii) adolescents (Question 3). Interestingly, all therapists also pointed to children as potential users, due to the playful immersion offered by the gamification elements (Question 4). Furthermore, they indicated that the system may encourage patient autonomy and treatment adherence (Question 4).

All therapists agreed on obtaining i) the frequency with which patients perform exercises, ii) a video of the patient performing the exergame, and iii) the data generated during the rehabilitation process (Question 6). 3 out of 4 therapists were interested in monitoring the precision with which the exergames are performed (Question 6). The predominant response about the frequency for obtaining the patient information was *weekly*, which was answered by three of the four therapists (Question 7). Generally, specialists rated each item very positively, providing values 4 and 5 (Question 8). It is noteworthy that three of the four therapists would use the system and recommend it to other colleagues (Question 8). Regarding the representation of the scene, they also valued it positively, highlighting the decorative elements (Question 9). The therapists noted that the system i) is easy to use and understand; ii) it is designed like a video game; iii) it provides reinforcement and motivation; and iv) the motion capture device is small (Question 10). The weaknesses identified include those related to the appearance of the avatar and the cost of the device (Question 11). All four specialists have indicated that they wish to be informed of future enhancements of the system (Question 13).

Overall, the system was highly appreciated by the therapists and they showed interest in its use.

## 5. Conclusions and future work

The work presented in this article is framed within the context of physical rehabilitation at home, supported by a system capable of running exergames that are automatically generated from a set of sentences specified in an exergame definition language. This language, built on the gITF standard and supported by JSON, allows therapists (currently with the help of developers) to define the essential aspects of a therapeutic exergame, from the game mechanics, such as the interaction of the virtual avatar in the 3D world, to basic aspects of gamification, such as the score or the use of virtual messages that motivate the patient.

In this context, the particular contribution discussed in this article is the possibility of defining mobility constraints and performance indicators, both associated with the execution of an exergame by a patient. On the one hand, constraints make it possible to

<sup>3</sup><https://www.esi.uclm.es/www/dvallejo/WISHWell2020/Questionnaire.pdf>

explicitly establish which parts of the body a patient should not move when carrying out rehabilitation. On the other hand, the performance indicators are aimed at monitoring the patient's skill in an exergame and his/her level of improvement as the rehabilitation process progresses. The integrated language statements to model these aspects with gITF enable automatic code generation and integration into the final executable file.

The carried out experiments are related to a case study of exergame for the rehabilitation of patients affected by stroke. The associated software prototype makes use of the Azure Kinect DK device to track the patient's skeleton, so it is not necessary to use wearable devices. This decision was made to promote rehabilitation at home and to increase flexibility when a patient performs exergames. This software prototype was presented to a group of 12 therapists from the General University Hospital of Ciudad Real (Spain), 4 of whom responded to an online survey about the proposed system. This preliminary evaluation by clinical professionals allows us to reach positive conclusions in terms of met clinical needs and functional capacity offered by the proposed system.

Although the results are satisfactory and promising, their validity is limited by two factors: the very small number of specialists who have participated in the evaluation, and the lack of participation of real patients. This is why we are in touch with the Association of Cerebral Palsy patients of Ciudad Real (Spain), in order to perform a more complete evaluation of the system in the near future.

Other future work is oriented towards the automatic generation of exergames that are more related to real-world actions, particularly in people affected by a stroke, such as the simple act of putting a cup in the mouth and leaving it on the table, placing virtual utensils in a virtual kitchen, or simulating food shopping in a supermarket.

## References

- [1] Bonnechère, B., Jansen, B., Haack, I., Omelina, L., Feipel, V., Jan, S. V. S., & Pandolfo, M. (2018), "Automated functional upper limb evaluation of patients with Friedreich ataxia using serious games rehabilitation exercises", *Journal of neuroengineering and rehabilitation*, 15(1), 87.
- [2] Corona, F., Chiuri, R. M., Filocamo, G., Foa, M., Lanzi, P. L., Lopopolo, A., & Petaccia, A. (2018), "Serious games for wrist rehabilitation in juvenile idiopathic arthritis", In *2018 IEEE Games, Entertainment, Media Conference (GEM)* (pp. 35-42), IEEE.
- [3] Chua, K.S.G., Kuah, C., and Wee K. (2017), "Innovating With Rehabilitation Technology in the Real World: Promises, Potentials, and Perspectives", *American journal of physical medicine & rehabilitation*, 96(10):150-156.
- [4] Eichinger, F. L. F., Soares, A. V., Noveletto, F., Sagawa Júnior, Y., Bertemes Filho, P., & Domenech, S. C. (2020), "Serious game for locomotor rehabilitation of hemiparetic stroke patients", *Fisioterapia em Movimento*, 33.
- [5] Fernandez-Cervantes, V., Neubauer, N., Hunter, B., Stroulia, E., & Liu, L. (2018), "VirtualGym: A kinect-based system for seniors exercising at home", *Entertainment Computing*, 27, 60-72.
- [6] Da Gama, A., Fallavollita, P., Teichrieb, V., & Navab, N. (2015), "Motor rehabilitation using Kinect: a systematic review", *Games for health journal*, 4(2), 123-135.
- [7] González, C. S., Toledo, P., Padrón, M., Santos, E., & Cairos, M. (2013), "TANGO: H: creating active educational games for hospitalized children", In *Management Intelligent Systems* (pp. 135-142), Springer, Heidelberg.
- [8] Hardy, S., Dutz, T., Wiemeyer, J., Göbel, S., & Steinmetz, R. (2015), "Framework for personalized and adaptive game-based training programs in health sport", *Multimedia Tools and Applications*, 74(14), 5289-5311.
- [9] Haas, D., Phommahavong, S., Yu, J., Krüger-Ziolek, S., Möller, K., & Kretschmer, J. (2015) "Kinect based physiotherapy system for home use", *Current Directions in Biomedical Engineering*, 1(1), 180-183.

- [10] Katajapuu, N., Luimula, M., Theng, Y. L., Pham, T. P., Li, J., Pyae, A., & Sato, K. (2017), "Benefits of exergame exercise on physical functioning of elderly people", In 2017 8th IEEE International Conference on Cognitive Infocommunications (CogInfoCom) (pp. 000085-000090), IEEE.
- [11] Lee, S., Kim, W., Park, T., and Peng, W. (2017), "The psychological effects of playing exergames: A systematic review", *Cyberpsychology, Behavior, and Social Networking*, 20(9):513-532.
- [12] Li, B., Maxwell, M., Leightley, D., Lindsay, A., Johnson, W., & Ruck, A. (2014), "Development of exergame-based virtual trainer for physical therapy using kinect", In *Games for Health 2014* (pp. 79-88), Springer Vieweg, Wiesbaden.
- [13] Madeira, R. N., Antunes, A., Postolache, O., & Correia, N. (2017), "Serious... ly! Just Kidding in Personalised Therapy Through Natural Interactions with Games", In *International Conference on Advances in Computer Entertainment* (pp. 726-745), Springer, Cham.
- [14] Matallaoui, A., Koivisto, J., Hamari, J., & Zarnekow, R. (2017), "How effective is "exergamification"? A systematic review on the effectiveness of gamification features in exergames", In *Proceedings of the 50th Hawaii International Conference on System Sciences* (pp. 3316-3325).
- [15] S. McCallum (2012), "Gamification and serious games for personalized health", *Stud Health Technol Inform*, 177(2012):85-96.
- [16] Morales-Vidal, S. and Ruland, S. (2013), "Telemedicine in stroke care and rehabilitation," *Topics in stroke rehabilitation*, 20(2):101-107.
- [17] Mousavi Hondori, H., & Khademi, M. (2014), "A review on technical and clinical impact of microsoft kinect on physical therapy and rehabilitation", *Journal of medical engineering* (pp. 1-16).
- [18] Omelina, L., Jansen, B., Bonnechère, B., Van Sint Jan, S., & Cornelis, J. (2012), "Serious games for physical rehabilitation: designing highly configurable and adaptable games", In *Proceedings of the 9th International Conference on Disability, Virtual Reality & Associated Technologies* (pp. 195-201).
- [19] O'Sullivan, S.B., Schmitz, T.J., and Fulk, G. (2019), "Physical rehabilitation", *F.A. Davis Company*.
- [20] Paraskevopoulos, I. T., Tseklevs, E., Craig, C., Whyatt, C., & Cosmas, J. (2014), "Design guidelines for developing customised serious games for Parkinson's Disease rehabilitation using bespoke game sensors", *Entertainment Computing*, 5(4), 413-424.
- [21] Pirovano, M., Surer, E., Mainetti, R., Lanzi, P. L., & Borghese, N. A. (2016), "Exergaming and rehabilitation: A methodology for the design of effective and safe therapeutic exergames", *Entertainment Computing*, 14, 55-65.
- [22] Proença, J. P., Quaresma, C., & Vieira, P. (2018), "Serious games for upper limb rehabilitation: a systematic review", *Disability and Rehabilitation: Assistive Technology*, 13(1), 95-100.
- [23] Robinet, F., Arnaud, R., Parisi, T., and Cozzi, P. (2014), "gltf: Designing an open-standard runtime asset format", *GPU Pro*, vol. 5, pp. 375-392.
- [24] Semrau, M., Evans-Lacko, S., Alem, A., et al. (2015), "Strengthening mental health systems in low-and middle-income countries: the Emerald programme", *BMC Medicine*, 13(1):79-85.
- [25] Sparks, D. A., Coughlin, L. M., & Chase, D. M. (2011), "Did too much Wii cause your patient's injury? Motion-controlled game consoles like Wii may be used to play virtual sports, but the injuries associated with them are real. Here's what to watch for—and a handy table linking specific games to particular injuries", *Journal of family practice*, 60(7), 404-410.
- [26] Su, C. J., Chiang, C. Y., & Huang, J. Y. (2014), "Kinect-enabled home-based rehabilitation system using Dynamic Time Warping and fuzzy logic", *Applied Soft Computing*, 22, 652-666.
- [27] Venugopalan, J., Cheng, C., Stokes, T. H., & Wang, M. D. (2013), "Kinect-based rehabilitation system for patients with traumatic brain injury", In *2013 35th annual international conference of the IEEE engineering in medicine and biology society (EMBC)* (pp. 4625-4628), IEEE.
- [28] Webster, D., & Celik, O. (2014), "Systematic review of Kinect applications in elderly care and stroke rehabilitation", *Journal of neuroengineering and rehabilitation*, 11(1), 108.
- [29] Wiemeyer, J., Deutsch, J., Malone, L. A., Rowland, J. L., Swartz, M. C., Xiong, J., & Zhang, F. F. (2015), "Recommendations for the optimal design of exergame interventions for persons with disabilities: Challenges, best practices, and future research", *Games for health journal*, 4(1), 58-62.
- [30] Zadeh, L.A. (1999), "Fuzzy logic= computing with words", *Computing with Words in Information/Intelligent Systems 1*, pp. 3-23.



# IoT-Based Smart Medicine Dispenser to Control and Supervise Medication Intake

Gleiston GUERRERO-ULLOA <sup>a,1</sup>, Miguel J. HORNOS <sup>b</sup>,  
Carlos RODRÍGUEZ-DOMÍNGUEZ <sup>b</sup> and Ma. Mercedes FERNÁNDEZ-COELLO <sup>a</sup>

<sup>a</sup>Faculty of Engineering Sciences, Quevedo State Technical University, Ecuador

<sup>b</sup>Software Engineering Department, University of Granada, Spain

**Abstract.** This paper presents a system consisting of a smart medicine dispenser of solid medications (pills, capsules,...) and a mobile application for its configuration and management. The main idea is to offer a solution to help people (especially vulnerable ones) to avoid incorrect medication intakes. In this regard, the smart dispenser delivers the required medication if two conditions are met: (1) it is the scheduled time for a medication intake, and (2) the person who removes the medication from the dispenser (patient or caregiver) can be identified and is authorized to do so. Person identification and authorization is performed through facial recognition by the dispenser and through a username and a password by the mobile application. Moreover, the system reminds the users whenever a medication intake should take place through mobile notifications and lights and sounds emitted by the dispenser. The system development has been guided by a Test-Driven Development Methodology for Internet of Things (IoT)-based Systems to promote its quality and reliability.

**Keywords.** Smart system, medicine dispenser, facial recognition, mobile application, Internet of Things (IoT), elderly

## 1. Introduction

Population ageing is a worldwide concern, due to the system-changing effects that it implies: well-being and social policies, economical sustainability, availability of public services, etc. For example, according to the United Nations [1], 36.81% of the forecasted population (16,062,075 people) will be elderly (over 65 years old) in Spain by 2050. Likewise, 22.35% of the United States of America population (84,813,265 people) will also be elderly by that year.

Nonetheless, life expectancy is steadily growing every year. According to the data published by the European Commission, life expectancy in Europe in 2018 was between 70.1 (Latvia) and 81.9 years old (Switzerland), and has an average growth of 0.3 years per year [2]. That is, it could be roughly in the range between 80 and 92 years old by 2050.

---

<sup>1</sup>Corresponding Author: Gleiston Guerrero-Ulloa, Faculty of Engineering Sciences, Quevedo State Technical University, 120501 Quevedo, Ecuador. E-mail: gguerrero@uteq.edu.ec

One of the side effects of the population ageing is the widespread impact of many chronic diseases and conditions: diabetes, high blood pressure, heart conditions, cognitive impairment, etc. In that sense, researchers are proposing Internet of Things (IoT)-based systems and smart environments to help elderly people to deal with their consequences [3,4]. One of the aids that these systems can offer is to remind and ease medication intakes.

Chronic diseases usually require people to intake many different medications at a very steady schedule. However, due to cognitive decline, elderly people are more prone to intake medications in a wrong way (e.g., more or less intakes than expected, at a different schedule, mix-up medications, etc.) [5]. In fact, according to Singh et al. [6], an estimated 25% of the elderly population does not intake their medication according to the professional prescription. A wrong medication intake can lead to many negative situations, such as health worsening, increased amount of hospitalizations, or even a premature death [7,8,9].

In this paper, we present a system consisting of a smart medicine dispenser and a mobile application for its configuration and management. The dispenser emits a sound and lights up an LED to alert the patient that it is time to take his/her medication. When he/she is close to the smart medicine dispenser, it will identify him/her through facial recognition and deliver the prescribed medication. If the medication is not removed during the expected timings, a notification is sent to the caregiver through the mobile application so that she/he can act consequently. The mobile application can also deliver reminders to those patients able to use a smartphone. This is useful when they are not close to the dispenser at the schedule time for a medication intake. Moreover, it allows registering several patients, as well as managing the medication schedule and even multiple smart dispensers.

The remainder of this paper is structured as follows. Section 2 presents some previous works related to smart medicine dispensers. Section 3 describes the proposed system. Finally, Section 4 outlines our conclusions and future work.

## 2. Related Works

IoT is a lifestyle transforming computing paradigm [10] that can even lead to the fourth industrial revolution [11,12]. Furthermore, IoT is an opportunity for many researchers to propose smart systems to help people in many domains, among them those that emit reminders to people to assist them during their daily life at home. For instance, an IoT-based system prototype to offer light, sound and voice reminders to elderly people through a chair is proposed in [5]. Another work with the same goal is presented in [13], but using a photo frame to emit a set of reminders that are previously configured through a mobile application. In both cases, reminders are generic, that is, they do not have a specific goal.

Many other systems are specifically designed to deliver medication-related reminders. However, in a comparison of some existing medicine dispensers [7], the conclusion was that most of the existing proposals do not rely on an Internet connection (i.e., they do not allow remote operation) and do not have any user interaction.

Nonetheless, more recent related works do use Internet. For example, a smart medicine flask that delivers reminders according a pre-established schedule is presented

in [14], while a medicine dispenser that delivers medication intake reminders to smart-phones is proposed in [15]. Other proposals remind medical intakes through the dispenser using sounds [15,16,17], lights [18,19], or both [20,14]. The smart dispensers proposed in [6,8,14,15,19,20] do not implement person detection to know if the patient is physically close to the dispenser. In [16], patient presence is detected using infrared, and in [21] and [18], using ultrasounds. In [6,8], the vital signs of the patient are detected to deliver the medication only when is necessary, although these systems do not emit reminders to users.

The dispenser proposed in [21] is oriented towards autonomous people, since the patient itself must specify the medication and intake schedule, and the patient is responsible of being close to the dispenser at the right timing.

Other works do not guarantee if it is the correct patient who really removes the medication from the dispenser. In [16,18], the medication can be removed by any person who is close to the dispenser at the right time. Other works [6,20,21] try to identify the user, but the proposed mechanisms are easy to overcome. In [8], fingerprint detection is used to identify the patient, but it requires that the person has enough skills and abilities to interact with the system.

Table 1 shows a comparison of the medicine dispensers analysed in the literature review that we have carried out. The *Dispensation* column refers to how the user obtains the medication from the dispenser, whether automatically (A) or manually (M). The *Programming* column indicates whether the system delivers the medication based on previously established (scheduled) times. The *Detection* column informs on whether or not the system detects the person approaching, indicating in parentheses which detection technology is used in each case, while the *Identification* column reveals whether or not the patient is identified and how it is done. The following three columns are related to notices issued or sent to the users concerned: More specifically, the *Reminders* column specifies what type(s) of reminders each dispenser uses to indicate to the patients that it is time to take their medication; the *Alerts* column indicates whether notifications are sent to alert the caregiver when a user has not taken any medication and what means is used to do so; and the *Notifications* column shows if notifications are sent when medications are running low and need to be refilled. Finally, the *Multiple Patients* column indicates whether or not a dispenser can serve more than one patient at a time.

As can be seen in Table 1, none of the systems analysed meet all the aspects that have been considered. For example, all systems are intended for a single patient (per dispenser), except one [17], where it is not clearly specified for how many patients it is designed. Moreover, most of the dispensers analysed (all except those corresponding to [6] and [17]) do not identify the patient; in addition, none does it by means of facial recognition.

Consequently, the analysis of the previous works has motivated us to propose a new smart medicine dispenser that is able to deliver notifications to both dependents (mainly elderly people) and caregivers, automatically provides the prescribed medication on schedule, ensures user authentication and offers an easy interaction with it. A mobile application will complement the dispenser operation by allowing remote notifications and its configuration and management. Furthermore, as we will see in the next section, our proposal consists of a smart medicine dispenser that can be shared by four patients simultaneously.

**Table 1.** Comparison of existing dispensers

Reference	Dispensation	Programming	Detection	Identification	Reminders	Alerts	Notifications	Multiple Patients
[6]	A	✗	✗	☰	–	☐	✗	✗
[8]	A	✗	✗	–	✗	✗	✗	✗
[14]	A	✓	✗	–	☐, 🎵, ✨	☐	✓	✗
[15]	–	✓	✗	–	☒, 🎵	☒	✓	✗
[16]	M	✓	✓(IR)	✗	☒, 🎵	☒	✗	✗
[17]	A	✓	✓(FP)	✓	🎵	–	✓	–
[18]	A	✓	✓(US)	✗	🎵, ☒, @	✗	✗	✗
[19]	M	✓	✗	–	✨	☒	✗	✗
[20]	A	✓	✗	–	✨, 🎵	✗	✓	✗
[21]	–	✗	✓(US)	✗	☐	☐	✓	✗

✓: Yes; ✗: No; –: No clearly specified; ☰: Login data; US: Ultrasound; FP: Fingerprint; IR: Infrared;  
☐: Mobile app; ✨: Light; 🎵: Sound; ☒: SMS (Short Message Service); @: Email

### 3. Features of the Proposed System

The system we propose is made up of a network of sensors and actuators with a gateway implemented in a Raspberry Pi B single-board computer. These hardware components are integrated with a mobile application that allows the system data management and that provides an intuitive interface to be used by the end users, i.e. the patients and/or their caregivers.

To develop this system, we have followed the Test-Driven Development Methodology for IoT-based Systems (TDDM4IoTS) [22], which is an appropriate agile methodology for the development of IoT-based systems. TDDM4IoTS considers the inherent aspects of this type of systems, such as its characteristic hardware (sensors, actuators,...) and its configuration, as well as the eventual (semi)automatic generation of part of the software code used for data processing and interaction with the user. TDDM4IoTS covers all phases or stages of the life cycle of an IoT-based system, from analysis to maintenance, through the design and the generation of both models, tests and even snippets of software code, as well as their refinements. We sincerely think that Software Engineering techniques must be applied at all stages of the development of these systems to improve their reliability [23] and increase user confidence in them [24].

As a proof of concept, we have developed a first prototype of the system, which we are currently evaluating with a real patient who is undergoing medical treatment for diabetes. This person must take the medications shown in Table 2, which also details the doses and timetable in which she has to take them. Given that it would be necessary for more patients and their caregivers to evaluate the developed prototype, it is still too early to guarantee the success of our proposal. Nonetheless, we are optimistic about it, due to the favourable expressions emitted by both the patient and the caregiver who are assessing it.

**Table 2.** Patient treatment medications.

Active principle	Doses (mg/day)	Timetable
Nateglinide	60	10:00am, 09:00pm
Miglitol	50	5:30 pm
Acabosa	50	10:30 am, 6:30 pm
Repaglinide	1	9:30 am, 2:30 pm

### 3.1. System Architecture

The system architecture, which is shown in Figure 1, is similar to the one presented in [4]. This architecture enables to interconnect sensors and actuators, and also to emit remote notifications from Cloud computing servers. Furthermore, it will allow a future interaction with other IoT devices. Each of its layers are described below.

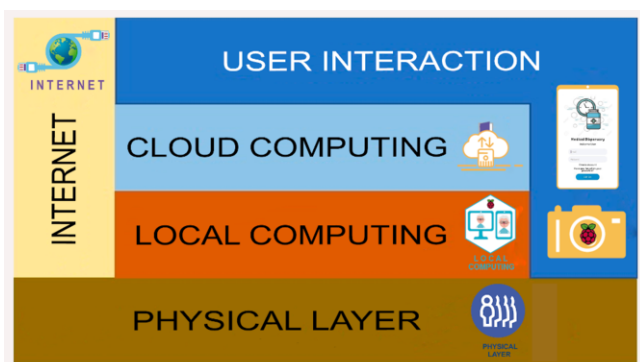
**Figure 1.** Proposed system architecture.

*Physical Layer.* It is made up of the sensors and actuators that are embedded into the dispenser (more details and photos about it will be provided in the following subsection). As for sensors, it includes an HC-SR501 passive infrared (PIR) sensor and a Raspberry Pi Camera Board v1.3. The former detects close movements and activates the camera used for facial identification, which is located inside a small slot in the central-front-top part of the dispenser. In addition, it integrates four (Tower Pro Micro Servo 9g SG90) servomotors, which are the actuators that push the corresponding medicine box through one of the four compartments that the dispenser has. These servomotors are controlled by an Arduino Uno R3 microcontroller board. Moreover, the dispenser has an LCD screen, a buzzer and 4 LED lights (one for each of its compartments). Every time a medicine box is dispensed, the LED in that compartment lights up and the buzzer emits a sound to alert the user, while the time and the name of the medicines dispensed are displayed in the LCD screen.

*Local Computing.* This layer registers patients by detecting their faces and taking the necessary photographs to automatically identify them later on. To do so, a mobile app detects people's faces using the Vision library in AndroidStudio and sends them to a Raspberry Pi 3 model B+. This computing board performs the patient identification through a Python (version 2.7) application running the OpenCV library (version 2.7). To ensure

the privacy of the patient, all his/her personal data that is required by this layer needs either an explicit approval from the own patient or being input under the responsibility of his/her caregiver. Moreover, after the dispenser finalizes a face recognition, it removes all live captured photographs to further avoid any privacy issues.

**Cloud Computing.** We use RESTful cloud services for processing, storage and database management (specifically in PostgreSQL, version 10.8). In addition to storing information in the PostgreSQL database, a folder is created for each patient in which we store the photographs that are used for his/her later identification.

**User Interaction.** The dispenser works non-intrusively. Thus, when the PIR sensor detects any movement near the dispenser, the camera is activated to try to identify if the approaching person is a registered patient. In that case, after identifying him/her, if it is time to take some of his/her medicines, they will be dispensed; otherwise, the time of his/her next dose will be shown on the LCD screen. Another way of interacting with the system would be through the mobile app, which will be used mainly by caregivers. Thus, they will be the ones who will enter the system configuration data, as well as their own data and those of the patients in their care, in addition to their doses of medications and the hours in which they must be taken. The mobile app also serves for the caregiver to receive notifications about whether or not the patient has obtained the medications from the dispenser. If the patient is able to use a smartphone, then he/she could also receive reminders about his/her medicine intakes through the mobile app [6,18]. Figure 2 shows some screenshots of the mobile app. The one on the left (A) shows the menu for the caregiver profile. In it, the *Patients* option gives access to the list of patients who are in charge of the caregiver, as shown in the central capture (B), which also allows adding more patients; the *Dispensers* option would show the list of nearby dispensers, being necessary to have the Bluetooth of the smartphone activated so that it can recognize them; and the *Medicine Boxes* option displays the screenshot (C), which shows bottom-lined buttons to manually dispense the medicine boxes from any of the (four) compartments. This option can be used whenever the patient has not approached the dispenser when he/she should.

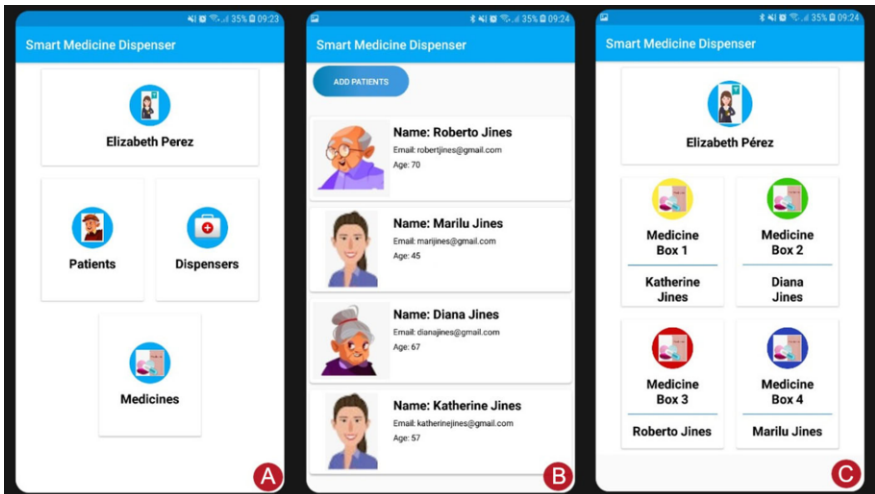
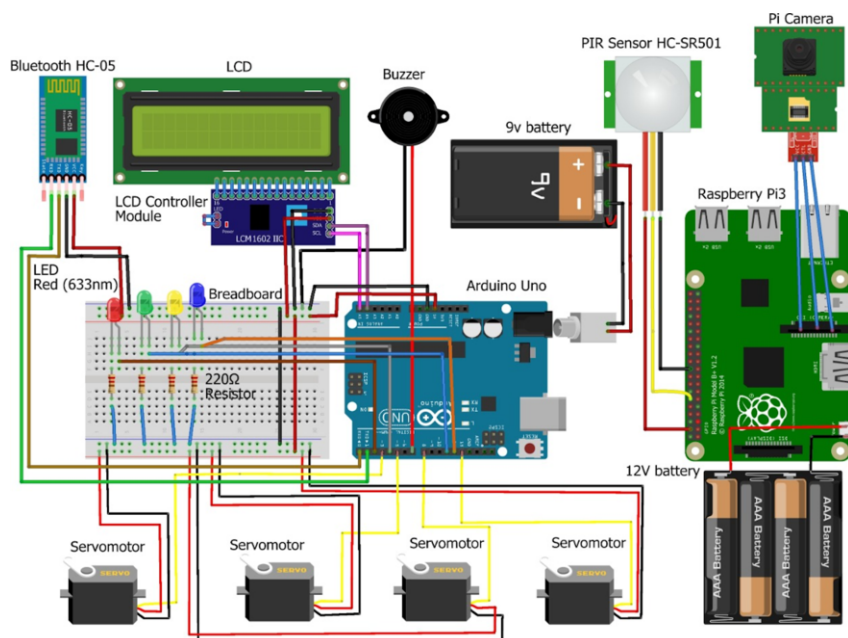

**Figure 2.** Some screenshots of the mobile application.

*Internet.* This layer is essential for IoT-based systems. In our case, the Internet is used for cloud storage of all information and for remote processing when local devices do not have enough resources. All notifications intended for users are issued from a remote system, being also essential to use the Internet for this.

### 3.2. Design and Implementation Details

The design of our smart medicine dispenser is shown in Figure 3. In it, we can see the different hardware components that make up of the dispenser. It can be powered either by batteries or connected directly to an electrical supply socket.



**Figure 3.** Design of the smart medicine dispenser showing its hardware components and connections.

The dispenser is developed to supply the solid medications (pills, capsules,...) that each patient needs to take on schedule. The physical model implemented for the dispenser is shown through several photos in Figure 4. The first one (A) shows the internals of the dispenser (with the back cover removed), where we can see two shelves. At the bottom one, there are four servomotors, which are in charge of activating a mechanism with a small rectangular piece that will push the medicine box at the bottom of the corresponding compartment towards the dispenser tray. At the top shelf, we can see the processing components, i.e., an Arduino Uno R3 and a Raspberry Pi 3 model B+, as well as their wiring. The Arduino board controls the servomotors, the Bluetooth module and the LCD screen so that each of these elements fulfils their function, while the Raspberry one manages the facial identification using the camera, as well as the notifications through the LED lights and the sounds emitted by the buzzer. As shown in the top view (B) and in the front view (C) of the dispenser, it has four vertical compartments. In each of them, we can place up to 12 small boxes (48 in total) like the one shown in the fourth photo

(D). All the medicines that a patient must take at a certain time should be introduced in one of these boxes. Each box (whose dimensions are  $2.5\text{ cm} \times 2\text{ cm} \times 1\text{ cm}$ ) may have a different colour. Normally, the caregiver will fill each box with the corresponding medicines, and will put the boxes inside the dispenser compartments. Note that the dispenser could potentially be shared by 4 patients by assigning a different compartment to each patient.

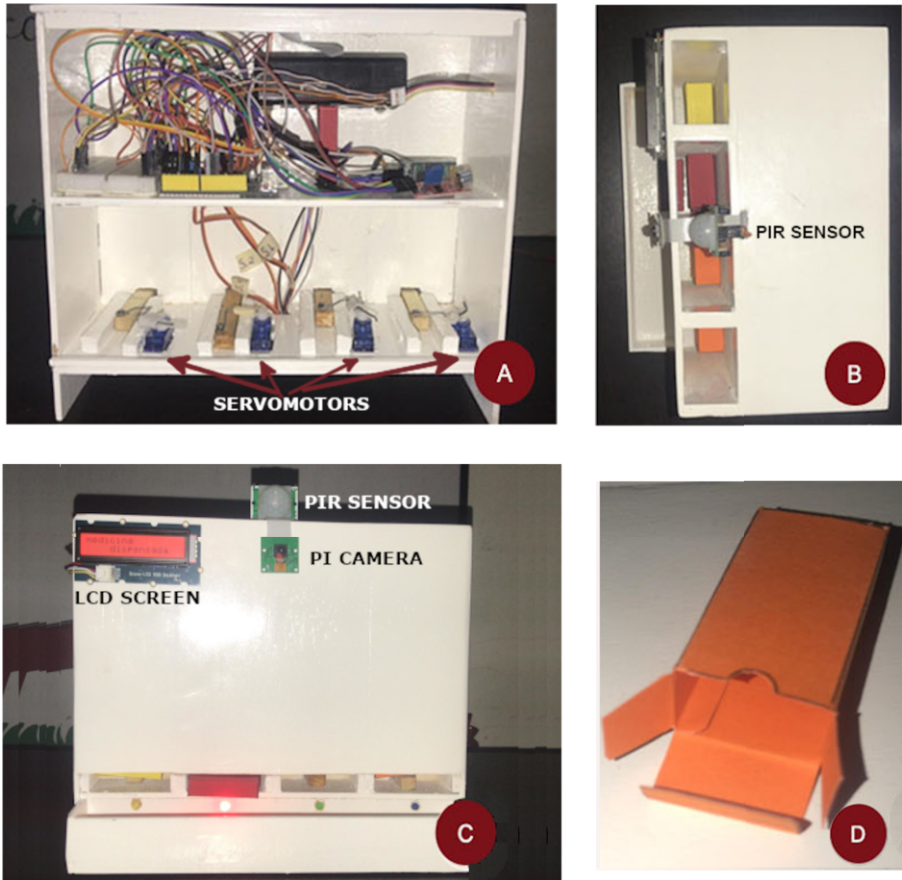

**Figure 4.** Photos of both the smart medicine dispenser from different perspectives and one of its medicine boxes.

#### 4. Conclusions and Future Work

We have presented a smart medicine dispenser that helps older people or people with a cognitive problem to take their medicine doses on schedule. In addition, it allows caregivers to supervise that their dependents take their medications on time. Using a facial identification mechanism, it recognizes the patients registered in the system and supplies



them with the medicines they should take just when needed. Every time the dispenser provides a medicine box, it generates a sound and illuminates the corresponding compartment. The system also sends remote notifications to caregivers, informing them of the medicines dispensed to their dependents directly on their smartphone. Thus, they can supervise the correct administration of medications and act when necessary (e.g., when somebody forgets to take a dose). In addition, those patients who can use the mobile app may be notified each time they have to take a dose, so that they approach the dispenser to withdraw it.

As for future work, we want to improve the proposed system, closing the dispenser compartments so that they only open when the camera detects the face of the caregiver who must place the medicine boxes in them. This would make it safer. It would also be good for the system to automatically detect which medicines and how many of them the caregiver has put in the different compartments; currently, he/she is who must provide these data through the mobile app. Moreover, an interesting extension would be the automatic request of the necessary medicines to a pharmacy by the system before the patient runs out his/her stock, since this will prevent him/her from losing any intake due to not having a certain medicine. Furthermore, the dispenser could also be integrated into a more general IoT-based system to help elderly people or people with cognitive problems in their daily life.

Besides, the overall system performance will be evaluated after encrypting the whole patient database and face detection images inside the Raspberry Pi, so as to improve patient privacy. Finally, it is important to highlight that our system is currently in use by one real patient, whose feedback will be valuable to develop a refined prototype. That improved prototype will be replicated and delivered to several patients, with different profiles, so as to adequately evaluate the system.

## References

- [1] UN Department of Economics and Social Affairs. World Population Prospects - Population Division - United Nations. The International Journal of Logistics Management. Available from: <https://population.un.org/wpp/Download/Standard/CSV/>.
- [2] Eurostat. Statistics — Eurostat. Life expectancy at birth by sex. 2020. Available from: <https://ec.europa.eu/eurostat/databrowser/view/tps00208/default/table?lang=en>.
- [3] Baranidharan B. Internet of Things (IoT) Technologies, Architecture, Protocols, Security, and Applications: A Survey. In: Raj P, Raman A, editors. Handbook of Research on Cloud and Fog Computing Infrastructures for Data Science. IGI Global; 2018. India: IGI Global. p. 149–74.
- [4] Guerrero-Ulloa G, Rodríguez-Domínguez C, Hornos MJ. IoT-Based System to Help Care for Dependent Elderly. In: Botto-Tobar M, Pizarro G, Zúñiga-Prieto M, D'Armas M, Zúñiga Sánchez M., editors. Communications in Computer and Information Science. Springer, Cham; 2019. p. 41–55.
- [5] Erazo O, Guerrero-Ulloa G, Guzmán D, Cáceres C. From a Common Chair to a Device that Issues Reminders to Seniors. In: Botto-Tobar M, Zambrano Vizuete M, Torres-Carrión P, Montes León S, Pizarro Vásquez G, Durakovic B, editors. Communications in Computer and Information Science. Quito: Springer; 2020. p. 439–48.
- [6] Singh U, Sharad A, Kumar P. IoMT Based Pill Dispensing System. In: 2019 10th International Conference on Computing, Communication and Networking Technologies, ICCCNT 2019; 2019 jul 6-8; Kampur, India, India. IEEE. p. 1–5.
- [7] Huang R, Zhao X, Ma J. The Contours of a Human Individual Model Based Empathetic U-Pillbox System for Humanistic Geriatric Healthcare. Future Generation Computer Systems. 2014; 37(July):404–16.
- [8] Jaipriya S, Aishwarya R, Akash NB, Jeyadevi AP. An intelligent medical box remotely controlled by doctor. In: Proceedings of the International Conference on Intelligent Sustainable Systems, ICISS 2019. 2019 Feb 21-22; Palladam, Tamilnadu, India, India. IEEE. p. 565–9.

- [9] Schreier G, Schwarz M, Modre-Osprian R, Kastner P, Scherr D, Fruhwald F. Design and Evaluation of a Multimodal mHealth Based Medication Management System for Patient Self Administration. In: Proceedings of the Annual International Conference of the IEEE Engineering in Medicine and Biology Society, EMBS. 2013 Jul 3-7; Osaka, Japan. IEEE. p. 7270–3.
- [10] Atzori L, Iera A, Morabito G. The Internet Of Things: A Survey. *Computer Networks*. 2010 Oct 28; 54(15):2787–805.
- [11] Salkin C, Oner M, Ustundag A, Cevikcan E. A Conceptual Framework for Industry 4.0. In: Ustundag A, Cevikcan E, editors. *Industry 4.0: Managing The Digital Transformation*. Springer, Cham; 2018. p. 3–23.
- [12] Xu H, Yu W, Griffith D, Golmie N. A Survey On Industrial Internet Of Things: A Cyber-Physical Systems Perspective. *IEEE Access*. 2018 Dec 4; 6: 78238–59.
- [13] Erazo, O, Guerrero Ulloa, G, Santana Sornoza, R, Chávez Boza, B. A Ubiquitous Photo Frame to Provide Reminders to Older Adults. *Revista Conrado*. 16(72): 34-8.
- [14] Nijjiya Jabin Najeeb PK, Rimna A, Safa KP, Silvana M, Adarsh TK. Pill Care-the Smart Pill Box with Remind, Authenticate and Confirmation Function. In: 2018 International Conference on Emerging Trends and Innovations In Engineering And Technological Research, ICETIETR 2018. 2018 Jul 11-13; Ernakulam, India. p. 1–5.
- [15] Kumar SB, Goh WW, Balakrishnan S. Smart Medicine Reminder Device For The Elderly. In: Proceedings - 2018 4th International Conference on Advances in Computing, Communication and Automation, ICACCA 2018. 2018 Oct 26-28; Subang Jaya, Malaysia, Malaysia. IEEE. p. 1–6.
- [16] Jabeena A, Kumar S. Smart medicine dispenser. In: Proceedings of the International Conference on Smart Systems and Inventive Technology, ICSSIT 2018. 2018 Dec 13-14; Tirunelveli, India, India. IEEE. p. 410–4.
- [17] Rumi RI, Pavel MI, Islam E, Shakir MB, Hossain MA. IoT Enabled Prescription Reading Smart Medicine Dispenser Implementing Maximally Stable Extremal Regions and OCR. In: 2019 Third International conference on I-SMAC (IoT in Social, Mobile, Analytics and Cloud) (I-SMAC). 2019 Dec 12-14; Palladam, India, India. IEEE. p. 134–8.
- [18] Kartheek K, Saddam Hussain SK. Medical Dispense System Using IoT. In: Proceedings - International Conference on Vision Towards Emerging Trends in Communication and Networking, ViTECoN 2019. 2019 Mar 30-31; Vellore, India, India. IEEE. p. 1–3.
- [19] Aneke J, Ardito C, Caivano D, Colizzi L, Costabile MF, Verardi L. A Low-cost Flexible IoT System Supporting Elderly's Healthcare in Rural Villages. In: ACM International Conference Proceeding Series, AfriCHI '18: 2nd African Conference for Human Computer Interaction. 2018 Dec; Windhoek Namibia. Association for Computing Machinery; p. 184–7.
- [20] Pandey PS, Raghuvanshi SK, Tomar GS. The Real Time Hardware of Smart Medicine Dispenser to Reduce the Adverse Drugs Reactions. In: Proceedings on 2018 International Conference on Advances in Computing and Communication Engineering, ICACCE 2018. 2018 Jun 22-23; Paris, France. IEEE. p. 413–8.
- [21] Arora K, Singh SK. IoT Based Portable Medical Kit. *International Journal of Engineering and Advanced Technology*. 2019; 8(5 Special Issue 3):42–6.
- [22] Guerrero-Ulloa G, Hornos MJ, Rodríguez-Domínguez C. TDDM4IoTS: A Test-Driven Development Methodology for Internet of Things (IoT)-Based Systems. In: Botto-Tobar M, Zambrano Vizuete M, Torres-Carrión P, Montes León S, Pizarro Vásquez G, Durakovic B, editors. *Communications in Computer and Information Science*. Quito: Springer; 2020. p. 41–55.
- [23] Hornos MJ. Application of Software Engineering Techniques to Improve the Reliability of Intelligent Environments. *Journal of Reliable Intelligent Environments*. 2017; 3(1):1-3.
- [24] Hornos MJ, Rodríguez-Domínguez C. Increasing User Confidence in Intelligent Environments. *Journal of Reliable Intelligent Environments*. 2018; 4(2): 71-3.

9th International Workshop on the Reliability  
of Intelligent Environments (WoRIE 2020)

This page intentionally left blank

# 9th International Workshop on the Reliability of Intelligent Environments (WoRIE 2020) - Introduction

Miguel J. HORNOS <sup>a,1</sup> and Juan C. AUGUSTO <sup>b</sup>

<sup>a</sup> *Software Engineering Department, University of Granada, Granada, Spain*

<sup>b</sup> *Department of Computer Science, Middlesex University, London, United Kingdom*

In this part of these Proceedings, we gather the accepted contributions to be presented at the *9th International Workshop on the Reliability of Intelligent Environments (WoRIE 2020)*, which should have been initially held within the *16th International Conference on Intelligent Environments (IE 2020)* in Madrid, Spain, on June 22-25, 2020. However, due to the pandemic caused by the COVID-19 outbreak, the whole conference has had to move to be held completely online on July 20-23, 2020. The seven previous editions of this workshop were also held within the IE corresponding edition in marvellous venues: Rabat, Morocco (2019), Rome, Italy (2018), Seoul, Korea (2017), London, United Kingdom (2016), Prague, Czech Republic (2015), Shanghai, China (2014) and Guanajuato, Mexico (2012), whereas the first one was held within the *2nd International Symposium on Ambient Intelligence (ISAmI 2011)* in Salamanca, Spain. Therefore, we can say that this event is gradually consolidating as a meeting point for researchers, academics and professionals interested in presenting and sharing their ideas, developments and results of their latest works related to the application of techniques, methods, procedures, etc. that lead to the development of more reliable, securer and/or safer intelligent environments (IEs).

IEs [1] are those in which a certain environment or physical space (e.g., building, home, vehicle, shopping mall, tourist spot, workplace, etc.) is enriched with numerous networked components, such as sensors, actuators, processors and other technological devices. The coordinated actions of all these components distributed in that environment makes the resultant system, based on the analysis of both information collected in real time and historical data, is able to make decisions that benefit users who carry out a certain activity (live, work, have fun, etc.) in that environment. Among the benefits that these systems can offer users would be to improve their safety, comfort, independence, transport, medical care, social inclusion, lifelong learning, etc., i.e. their quality of life, in general. Each of these areas or facets of life represents an important challenge that developed societies are currently facing. In addition, we must bear in mind that almost all of them become more important as their population ages.

Although we will refer to these systems as IEs, other researchers and practitioners use other related terms, such as Ambient Intelligence systems, Smart Environments, Cyber-Physical Systems, Pervasive/Ubiquitous Computing systems and Internet of Things (IoT) systems, to name a few of them. Regardless of the name used to refer to

---

<sup>1</sup> Corresponding author, Software Engineering Department, University of Granada, E.T.S. de Ingenierías Informática y de Telecomunicación, 18071 Granada, Spain; E-mail: [mhornos@ugr.es](mailto:mhornos@ugr.es).

these systems, the important thing is that IEs must automatically adapt to the users they have to serve, even anticipating their needs. To do so, they have to be context-aware systems [2]–[4], in order to sense the significant events that happen in the environment, and even recognize the people and the activities performed by them in it. Furthermore, these systems should learn from the frequent behaviour patterns of their users [5] in a discreet and transparent way, as well as know the user preferences [6]. All these aspects are essential for the IEs to react appropriately to the actions of their users, as well as to serve them smartly, according to their needs.

Therefore, a user-centred development process is convenient and even necessary, especially if the target users are people with special needs [7]. However, a study on user expectations regarding IEs [8], which has analysed the existing literature on this topic, concludes that, though most articles on IEs make reference to users, only a small part of them involve users in the development phases of the corresponding project. Undoubtedly, a greater degree of user integration is needed in this type of projects to bridge the gap between technology and users, especially if they are older adults [9]. In this way, we will be able to produce systems more accepted by users and closer to their real needs.

With all this in mind, it is easy to conclude that IEs are complex systems which deploy a multitude of hardware devices in the environment that must be controlled and coordinated by concurrently executed software modules, so special attention must be paid to the architecture of these systems [10]. In addition, users could interact in unexpected ways with them. All this makes the development of IEs an extremely difficult task and a considerable challenge, being countless the issues that developers must take into account. Therefore, it is crucial to have adequate methodologies and to apply the best practices of Software Engineering in their development [11].

Despite the fact that a series of methodologies [12]–[20] have been proposed in the last decade, whose purpose is to improve different quality aspects of these systems, and especially their reliability, each proposal is used only by its authors, so none of them has become a *de facto* standard in our community. Consequently, it is necessary to invest new efforts and a greater degree of collaboration among the researchers and professionals working in this field to advance in this regard and strengthen the methodologies for the development of IEs.

We think that the reliability, safety and security in this type of systems is achieved as a result of the application of approaches combining various methods and techniques coming from both Software Engineering [21] and other fields of Computer Science, such as Artificial Intelligence, Human-Computer Interaction, Robotics, etc. In fact, remember that the area of IEs has interaction with many other disciplines [1] and that our ultimate goal should be to increase user confidence in the resulting systems [22].

In this workshop, we are interested in both theoretical advances and lessons learned from the application of existing methodologies and techniques to the domain of IEs. Thus, the accepted papers represent a well-balanced distribution of theoretical and practical contents. In fact, they address the following topics: the aggregation and distribution of electrical power among both mobile and IoT devices using the specification USB-PD (Universal Serial Bus – Power Delivery); a priority-based preemptive hard real-time kernel that is power efficient and ideal for battery-operated environments; the automated drone-based aircraft inspection; and a gateway to enable communication among inter-platform agents.

We hope to have a successful and fruitful workshop, with an active participation and an interesting discussion on the topics addressed. We also expect that readers enjoy

the selected contributions included in these proceedings. Finally, we wish to express our sincere thanks to: the authors, for their very interesting and high quality contributions; WoRIE'20 Program Committee members, for their effort and invaluable suggestions made during the review process; and IE'20 General Chairs, for their help and support. All of them have made possible to successfully organize the present edition of this workshop, which is the first one to be held completely online.

## References

- [1] Augusto JC, Callaghan V, Cook D, Kameas A, Satoh I. “Intelligent Environments: a manifesto.” *Human-centric Comput Inf Sci*. 2013;3(1):12.
- [2] Bauer C, Dey AK. Considering context in the design of intelligent systems: Current practices and suggestions for improvement. *J Syst Softw*. 2016;112:26–47.
- [3] Alegre U, Augusto JC, Clark T. Engineering context-aware systems and applications: A survey. *J Syst Softw*. 2016;117:55–83.
- [4] Alegre-Ibarra U, Augusto JC, Evans C. Perspectives on engineering more usable context-aware systems. *J Ambient Intell Humaniz Comput*. 2018;9(5):1593–609.
- [5] Aztiria A, Augusto JC, Basagoiti R, Izaguirre A, Cook DJ. Learning frequent behaviors of the users in intelligent environments. *IEEE Trans Syst Man, Cybern Syst*. 2013;43(6):1265–78.
- [6] Augusto JC, Muñoz A. User Preferences in Intelligent Environments. *Appl Artif Intell*. 2019;33(12):1069–91.
- [7] Augusto J, Kramer D, Alegre-Ibarra U, Covaci A, Santokhee A. The user-centred intelligent environments development process as a guide to co-create smart technology for people with special needs. *Univ Access Inf Soc*. 2018;17:115–30.
- [8] Corno F. User expectations in intelligent environments: Issues and opportunities in the interaction of intelligent users and intelligent environments. *J Reliab Intell Environ*. 2018;4(4):189–98.
- [9] Teles S, de Sousa RT, Abrantes D, Bertel D, Ferreira A, Paúl C. Bridging the gap between technology and older adults: insights from a collaborative workshop on R&D methodologies for ambient assisted living solutions. *J Reliab Intell Environ*. 2019; 5(4):195–207.
- [10] Augusto J, Giménez-Manuel J, Quinde M, Oguego C, Ali M, James-Reynolds C. A Smart Environments Architecture (SEArch). *Appl Artif Intell*. 2020;34(2):155–86.
- [11] Preuveneers D, Novais P. A survey of software engineering best practices for the development of smart applications in Ambient Intelligence. *J Ambient Intell Smart Environ*. 2012;4(3):149–62.
- [12] Coronato A, De Pietro G. Formal specification and verification of ubiquitous and pervasive systems. *ACM Trans Auton Adapt Syst*. 2011;6(1):Article No. 9:1–6.
- [13] BENGHAZI K, HURTADO M V, HORNOS MJ, RODRIGUEZ ML, RODRIGUEZ-DOMINGUEZ C, PELEGRINA AB, et al. Enabling correct design and formal analysis of Ambient Assisted Living systems. *J Syst Softw*. 2012;85(3):498–510.
- [14] Augusto JC, Hornos MJ. Software simulation and verification to increase the reliability of Intelligent Environments. *Adv Eng Softw*. 2013;58: 18–34.
- [15] Tang L, Yu Z, Wang H, Zhou X, Duan Z. Methodology and tools for pervasive application development. *Int J Distrib Sens Networks*. 2014;10(4): Article ID 516432.
- [16] Corno F, Guercio E, De Russis L, Gargiulo E. Designing for user confidence in intelligent environments. *J Reliab Intell Environ*. 2015;1(1):11–21.
- [17] Le Guilly T, Nielsen MK, Pedersen T, Skou A, Kjeldskov J, Skov M. User constraints for reliable user-defined smart home scenarios. *J Reliab Intell Environ*. 2016;2(2):75–91.
- [18] Coronato A, Paragliola G. A structured approach for the designing of safe AAL applications. *Expert Syst Appl*. 2017;85:1–13.
- [19] Sosa-Reyna CM, Tello-Leal E, Lara-Alabazares D. Methodology for the model-driven development of service oriented IoT applications. *J Syst Archit*. 2018;90:15–22.
- [20] Guerrero-Ulloa G, Hornos MJ, Rodríguez-Domínguez C. TDDM4IoT: A Test-Driven Development Methodology for Internet of Things (IoT)-Based Systems. *Commun Comput Inf Sci*. 2020;1193:41–55.
- [21] Hornos MJ. Application of Software Engineering techniques to improve the reliability of Intelligent Environments. *J Reliab Intell Environ*. 2017;3(1):1–3.
- [22] Hornos MJ, Rodríguez-Domínguez C. Increasing user confidence in intelligent environments. *J Reliab Intell Environ*. 2018;4(2):71–3.

# Practical Issues in Aggregation and Distribution of Electrical Power Among USB-PD-Connected Devices

Kota TAMURA<sup>a,1</sup>, Yuusuke KAWAKITA<sup>b</sup>, Yoshito TOBE<sup>a</sup>, Shinji YOKOGAWA<sup>c</sup> and Haruhisa ICHIKAWA<sup>c</sup>

<sup>a</sup>*Department of Integrated Information Technology Aoyama Gakuin University Sagamihara, Japan*

<sup>b</sup>*Faculty of Information Technology Kanagawa Institute of Technology Atsugi, Japan*

<sup>c</sup>*Info-Powered Energy System Research Center The Univ. of Electro-Communications Tokyo, Japan*

**Abstract.** Nowadays we can witness many mobile and IoT devices constituting intelligent environments. The physical status of the real world is obtained with many wirelessly-connected devices and it seems that we can create any arbitrary intelligent environments. However, these devices still have a problem of inflexibility of supplied power; wireless IoT devices tend to necessitate the batteries solely dedicated to them. Therefore, as the number of IoT devices increases, the cost of managing these batteries also increases. To cope with the problem, Ichikawa et al. has developed Virtual Grid Hub (VGHub), where USB-PD-connected devices can alternatively provide and receive electrical power. In this study, we show how to control VGHub connecting personal computers, mobile phones, and portable batteries to maximize the utilization of electrical power taking practical issues into consideration.

**Keywords.** USB, power supply, smart grid

## 1. Introduction

Since Mark Weiser's vision [1], many ubiquitous devices have been developed and intelligent environments are becoming common. Computers are not only machines in remote computer rooms anymore, but they are devices for personal assistants and even embedded into many daily-life objects. Although we have no significant difficulty in creating intelligent environments with wirelessly connected devices and computers, there is still a problem of providing electrical power to the devices. Another remarkable trend in computers is a unified interface for I/O interface. Universal Serial Bus (USB) was first proposed as a commonly-used serial bus protocol as its name suggests and it can integrate the I/O cables with peripheral devices such as keyboards, mice, and hard discs. However, it is currently more universal to connect many kinds of devices. Notably, it can be often used only for providing electrical power to electric devices.

---

<sup>1</sup> Corresponding Author: kota@rcl-aoyama.jp



The power transmission and distribution system is shifting towards the smart grid [2]. In the smart grid, Information Technology (IT) enables real-time understanding of electricity demand, thereby improving transmission and distribution efficiency. With the spread of power generation facilities that utilize natural energy sources such as solar and wind power from the viewpoints of environmental protection, reduction of CO<sub>2</sub>, and securing power in emergencies, stabilization of power has become a new issue again. Power generation from solar and wind energy sources is extremely unstable because it depends on the weather. Therefore, in order to provide stable power supply in a situation where unstable power is mixed, it is necessary to constantly monitor and control the power demand and supply situation using IT technology and match the power demand and supply.

Based on the above background, Ichikawa et al. proposed Virtual Grid Hub (VGHub) for office and residential use [3]. The specification of USB Power Delivery (USB-PD) [5] accommodates the both direction of electrical power flow and the VGHub. The basic concept of VG-Hub is realizing indoor "smart grid" with Direct Current (DC) power. As mentioned above, the USB is becoming a standard interface for electrical power at the computer-device level and the advent of its advanced and additional function, Power Delivery specification, facilitates the realization of the concept of VG-Hub. One may think that using a mobile battery for each electronic device is sufficient. VGHub eliminates having multiple batteries and speculating where each device should be connected. If devices are connected to VGHub, the flow of power is controlled by software to maximize the total performance.

A practical problem in controlling the recently-created prototype of VGHub is the difficulty of identifying the actual consumed power at the devices; in many cases there is a little difference between the actual and nominal values. In this paper, we present a method of balancing demand and supply based on the actual consumed power.

The rest of the paper is organized as follows. Section 2 explains technologies and previous researches related to this study. Sections 3 and 4 describe the system of VGHub and its basic properties with experiments, respectively. Section 5 concludes this study.

## 2. Related Work

The most relevant work to our study is the smart grid [2]. Initially, the notion of smart grid itself was intended to be used for restructuring old facilities of the power transmission and distribution network. However, the spread of regenerative power production urges the construction of smart grid and many smart meters are being installed in the world wide scale. Smart grids are designed in various scales. Microgrids [7] combine distributed mincro-generators, energy storage systems (ESSs), and loads. Nanogrids [8] are similar to microgrids in a smaller size within a single building. Although our VGHub is considered to be only a particularly small nanogrid, we tackle a problem where power demand and supply are almost equivalent.

Another new trend in the power transmission and distribution network is the utilization of DC. One of the major factors that are attracting attention to DC power supply is that DC power supply can be a very effective means for reducing CO<sub>2</sub> emissions. Many electronic devices operate on electronic circuits that are supplied with DC power. At present, AC power delivered from the power network is converted to DC inside the electronic device or at AC adapters. On the other hand, if the signal is

transmitted directly with DC, the overhead of AC-DC conversion can be eliminated. The use of DC is raising another problem of DC circuit breakers [4], overall, DC power supply is considered to increase. However, the majority of the power transmission and distribution network is expected to use AC and the network of the smart grid is considered in the AC power flow.

The challenges in the smart grid are (1) the integration of distributed power generators and (2) the balancing of the demand and supply. More specifically, (1) includes the control of phase in AC voltage and current and the avoidance of instable states in the conventional power network with the regulation of incoming power flow and the utilization of power storage.

In contrast, the indoor DC power distribution has similar but slightly different challenges. The balancing of the demand and supply is common with the smart grid, but (3) the aggregation and distribution of DC power and (4) DC power transmission are DC-specific problems. Our Virtual Grid focuses on (2) and (3), that is, the aggregation and distribution of DC power based on the demand and supply.

The most advanced technology with respect to indoor power distribution is wireless power transfer. Using the principle of resonant coupling, the electrical power is transfer in the mid-range distance [6]. Although there are already practical applications using wireless power transfer, they are only limited to the short-range distance and still far from deployment in the actual intelligent environments.

### 3. VGHub

In this section, we describe the basic architecture of Virtual Grid and prototype of VGHub and explain the practical issues to control the VGHub.

#### 3.1. Basic Architecture of Virtual Grid

Ichikawa et al. proposed a virtual grid system as shown in Figure 1 as an approach to utilize the dual role function of the USB PD and perform flexible power flow control. The virtual grid system is a network-type system built around a device such as a distributed hub that can set the role of each port and the amount of power arbitrarily based on the USB PD standard described above. Each hub has multiple USB Type-C ports that support USB PD, and the goal is to connect loads, power generators, batteries, etc. to the ports and to perform optimal power flow control within the connected devices. This will enable users to overcome the limitations of battery capacity and output, and reduce storage costs by using a virtual grid system.

The virtual grid assumes the connection of various compatible devices such as power supply and load to multiple USB PD-compatible USB Type-C ports as shown in Figure 2. The VGHub collects information on the status of connected devices and information related to power input / output, cooperates with the cloud, determines the role and power value of each port according to a predetermined policy, which enables optimal control of the hub.

In Figure 2, the power supplied from the outside is distributed to the mobile PC and smartphone, but the power supply to the mobile battery starts when the battery capacity of the PC satisfies a certain condition or when the external power supply has been removed.

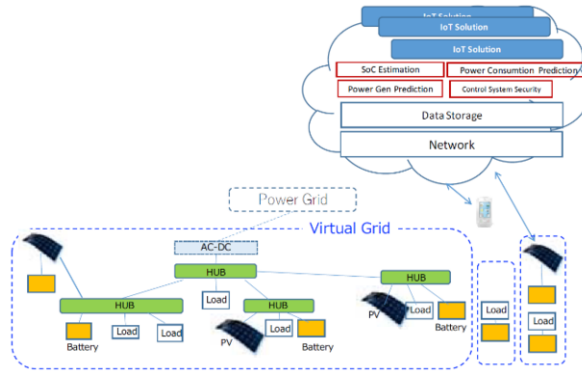

Figure 1. Basic architecture of Virtual Grid [3].

VGHub accommodates the control of switching the role of the portable battery from providing electrical power to the other devices to receiving electrical power from them.

Another feature of VGHub is that the power input and input by the DC-DC converter inside VGHub can be freely combined and distributed. Figure 3 shows an example of using VGHub with the composition / distribution function. In Figure 3, power input from two external power supplies is internally combined and distributed to supply a total of four loads. Similarly, it is possible to supply power to three loads from one external power supply, or to supply power to one load with a large power requirement by combining three small batteries with small output.

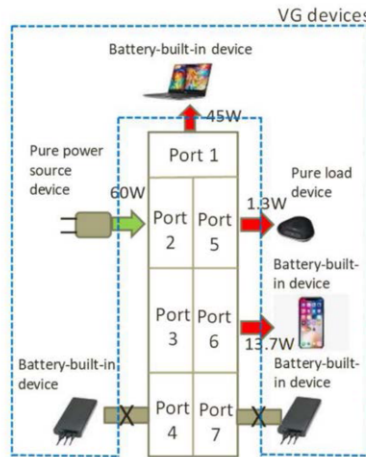

Figure 2. Input and output devices at VGHub.

### 3.2. Prototype System of VGHub

The prototype of VGHub is a box-type device equipped with seven USB Type-C ports, and all ports are compatible with the USB PD standard. All ports support up to 60-W

(20V3A) power input and output, and can supply power to devices equipped with USB PD ports.

The prototype uses a Raspberry Pi as the control CPU, and it is possible to control the power with a software program running on the Raspberry Pi. This program uses USB PD control library to control USB PD for each port. The USB PD control library sends control commands to the USB PD controller mounted on each port. In addition, the library also provides a function of acquiring the status of "voltage / current measurement IC" mounted on each port.

The port can function either as a source or a sink as follows:

- source: port providing electrical power to the connected device
- sink: port receiving electrical power from the connected device

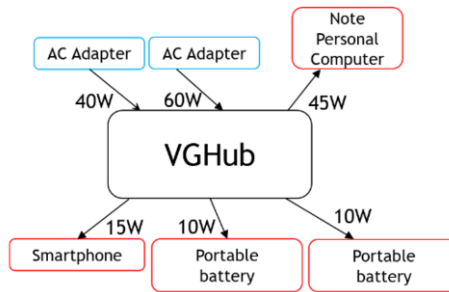

**Figure 3.** Example of electrical power distribution using VGHub.



**Figure 4.** Physical appearance of the VGHub prototype.

### 3.3. Practical Issues for Control

The main functions of the USB PD control library used for the operation of the VGHub prototype include the following functions.

- Acquisition of various status of each port: Current and voltage status flowing through VBUS
- Changing the USB PD setting of each port: Sink / Source switching, maximum power value change, etc.
- Sending control instruction to each port: Role change message, etc.

Let us define the following notations:

- $P_L$ : the minimum power at the source port
- $P_S$ : the maximum suppliable power to be set at the port using an instruction
- $P_X$ : the power the device manifests to use
- $P_T$ : the total power that can be provided to all the source ports

Here, in order to stably operate the prototype of VGHub for which the operating conditions were not established, we implemented a software program using the USB PD control library running on the control CPU for a stable operation based on the synthesis distribution control. We also investigated the conditions necessary for improving the power supply capacity utilization rate

$P_L$  is a value specific to each device, and it is necessary to set a power value  $P_S$  for all VGHub source ports that exceeds  $P_L$ . Since  $P_L$  is a value that is not specified in the specifications, it is necessary to estimate its value for each device. To control all the ports, we also need to identify  $P_X$  of each port and  $P_T$ . They dynamically change depending on the states of the load and the power sources, and thus real-time estimation of these values is required.

The following two conditions Eqs. (1) and (2) are required for each source port as conditions for maximizing the power capacity utilization rate and maximizing the load utility.

$$\text{minimize } |P_S - P_X| \quad (1)$$

$$\text{minimize } |P_T - \sum P_S| \quad (2)$$

( $\sum P_S$  represents the summation of  $P_S$  at all ports.)

#### 4. Basic Properties with Experiments

As mentioned above, the two conditions need to be quantified in the VGHub. In this section, we describe the measured results of  $|P_S - P_X|$  and  $|P_T - \sum P_S|$ .

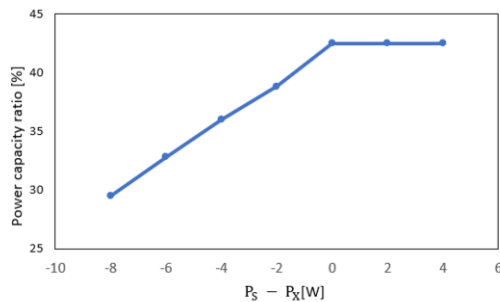
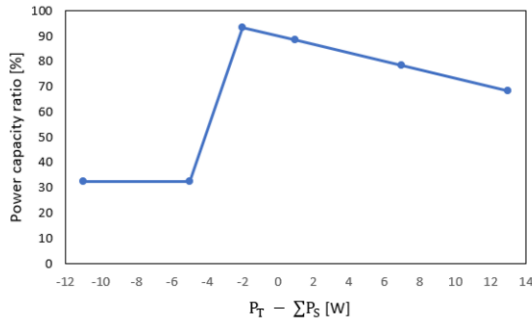

Figure 5. Power capacity ratio vs.  $P_S - P_X$ .

In Figures 5 and 6, the power capacity ratio is defined as the measured total outputting power from VGHub to the loads divided by  $P_T$ .



**Figure 6.** Power capacity ratio vs.  $P_T - \sum P_S$ .

Figure 5 shows the measured relationship between the value of (1) and the power capacity utilization rate when AC adapter with a maximum of 60-W output supplies power to a portable battery with the maximum  $P_X$  at 18 W and  $P_L$  at 8 W. We can confirm that the power capacity utilization rate is maximized at the point where the value of (1) is close to 0. As seen in the graph, there is no change even if the value of (1) increases in the positive direction. If the value of (1) is positive,  $P_S > P_X$  is satisfied. In such a state, there is a loss in the power distribution because  $P_S$  determines the power distribution when there are multiple source ports. Therefore, the value of (1) is preferable to be small when it is positive.

Figure 6 shows the measured relationship between the power supply capacity and the value of (2) when three portable batteries are charged using the same power supply used in Figure 5. As seen in the graph, we can confirm that the power capacity utilization rate is maximized when the value of (2) is close to 0. When the value of (2) is large in the negative direction, that is when  $\sum P_S$  is large, the power capacity utilization rate is significantly low. This is because the power supply to some ports was stopped because the total set value exceeded the power supply capability of the power supply.

Based on the above, it is considered that the setting of the power value in consideration of the values of these two formulas will lead to the power capacity utilization rate when combining and distributing power using USB PD.

## 5. Conclusion

In this paper, we have described the prototype of VGHub and the practical problem for its control. We need to satisfy two conditions with respect to the power at each port to optimize the flow of electrical power using VGHub. In this short paper, we have shown the results of experiments related to the two conditions. Our future work includes the developing the control algorithm for the optimization.

## **Acknowledgment**

This study was supported by JSPS KAKENHI Grant Number JP17H06293.

## **References**

- [1] Weiser M. The computer for the 21st century. *Scientific American*. 1991.
- [2] Dileep G. A survey on smart grid technologies and applications. In: *Renewable Energy*. 2020 Feb; 146:Vol. 146. p. 2589-2625.
- [3] Ichikawa H, Yokogawa S, Kawakita Y, Sawada K, Sogabe T, Minegishi A, and Uehara H. An approach to renewable-energy dominant grids via distributed electrical energy platform for IoT systems. In: *Proceedings of IEEE Int. Conf. on Communications, Control, and Computing Technologies for Smart Grids*. 2019.
- [4] Qi L, Pan J, Liljestrand L, Backman M, Antoniazzi A, Raciti L, and Riva M. DC power distribution: new opportunities and challenges. In: *Proceedings of IEEE Second Int. Conf. on DC Microgrids*. 2017 August: p. 27-29.
- [5] USB Power Delivery. <https://www.usb.org/document-library/usb-power-delivery>
- [6] Karalis A, Joannopoulos JD, and Soljacic M. Efficient wireless non-radiative mid-range energy transfer. *Annals of Physics*. 2008; 323. p. 34-48.
- [7] Justo JJ, Mwasilu F, Lee J, and Jung JW: AC-microgrids versus DC-microgrids with distributed energy resources: A review. *Renew. Sustain. Energy Review*. 2013 Aug; Vol. 24. p. 387-405.
- [8] Werth A, Kitamura N, and Tanaka K: Conceptual study for open energy systems : distributed energy network using interconnected DC nanogrids. *IEEE Trans. on Smart Grid*, 2015 July; Vol. 6. p. 1621-1630.

# HarSaRK-RS: Hard Safe Real-Time Kernel in Rust

Kanishkar JOTHIBASU<sup>a</sup>, Gourinath BANDA<sup>a,1</sup>

<sup>a</sup>*Discipline of Computer Science and Engineering, Indian Institute of Technology Indore, India*

**Abstract.** With the growth of the use of embedded systems in safety-critical applications, the demand for predictable and reliable real-time systems has increased drastically. A large percentage of real-time systems developed today are still built using C due to the performance requirements, and hence inherently unsafe. The advent of Rust has made it possible to achieve safety and reliability without any compromise on performance. This paper presents HarSaRK-RS, a priority-based preemptive hard real-time kernel implemented in Rust. The proposed kernel design and architecture ensure safety at compile time keeping the data-structure and runtime overhead of the kernel minimal, thus enhancing the real-time guarantees of the system. It guarantees freedom from data races, deadlocks, and priority inversion at compile-time. The Kernel core is independent of any clock for its operation, making it power efficient and ideal for battery-operated environments.

**Keywords.** Real-time systems, real-time kernels, hard real-time systems, Rust, safety critical systems

## 1. Introduction

Embedded systems are being deployed in a variety of safety-critical applications. Failure in such systems can have serious consequences, e.g., aerospace industry, automobiles, power plants, etc. [1]. Thus, the safety requirements and reliability expectations from real-time systems have increased drastically over time. Due to the complications in writing applications directly over embedded platforms, researchers have developed Real-time Kernels which are middlewares that operate between the application and the hardware. It provides the application developers abstractions over the hardware that takes care of various intricacies and provide friendly APIs so that application developer can focus on building the application rather than handling the complexity of dealing with the hardware.

There are two aspects to the real-time guarantees made by kernels. One of them is the adherence to completion before a deadline, and the other one being the safety and reliability of the system and its comprising tasks. This includes guarantees against invalid memory accesses, invalid type casts, memory leaks, data races, deadlocks, etc. The presence of such bugs in the real-time systems' implementations directly questions

---

<sup>1</sup>Corresponding Author: Gourinath Banda; E-mail: gourinath@iiti.ac.in



the reliability of the system itself. Thus, it is of utmost importance that the software written for real-time systems is guaranteed to be safe and reliable.

The price of running unsafe code is high. For example, in 2017, the Common Vulnerabilities and Exposures database lists 217 vulnerabilities that enable privilege escalation, denial-of-service, and other exploits in the Linux kernel [2], two-thirds of which are a consequence of the usage of unsafe programming languages. These errors can be attributed to ignoring the intricate details of object lifetimes, synchronization, bounds checking, etc., in a complex, concurrent environment. Even worse, the pervasive use of pointer aliasing, pointer arithmetic, and unsafe typecasts which keeps modern systems beyond the reach of software verification tools [3]. This emphasizes the need for usage of safe programming languages in the development of safety-critical systems.

Rust is a modern multi-paradigm system programming language focused on safety and performance [4]. It uses strong types and static analysis of source code to guarantee various aspects of software safety at compile-time [5]. By safety, we mean type and memory safety, type safety, and freedom from data-races. This makes Rust an Ideal candidate for building real-time systems. This paper proposes a Real-Time Kernel developed in Rust, HarSaRK-RS. The major goals of the kernel are:

- Minimal memory footprint.
- Low runtime overhead (Kernel Data-Structures).
- Freedom from Data races, Priority Inversion, and Deadlocks.
- Safe and reliable memory management.
- Hard real-time guarantees.

The bold safety guarantees made by Rust has attracted various developers into developing operating systems and kernels in Rust. Redox OS is a UNIX-like operating system written in Rust. The motivation behind the development of Redox OS is the fact that operating systems are an integrated part of computing, and thus a very security-critical component [6]. There is an increasing interest in implementing an OS in Rust [7]. Levy et al. (2017) provide a detailed case study of writing a kernel in Rust and argue that Rust will enable the next generation of safe operating systems [8]. These efforts motivated us to explore Rust in the realm of real-time systems and develop HarSaRK-RS, a hard safe real-time kernel in Rust.

The paper is organized into six major sections. A brief discussion on Rust programming language and its features that make it safe is presented in Section 2. Section 3 explains the Kernel architecture and details regarding sub-systems. It also explores how Rust has been leveraged to make kernel and application-level safety guarantees. Section 4 discusses the development process, experimentation details, and comparison with existing real-time kernels. It also explores the accompanying results. Section 5 concludes giving the summary of contributions of this work.

## 2. Significance of Rust in Embedded Systems Programming

The Rust programming language exists at the intersection of low-level systems programming and high-level application programming. It aims to empower the programmer with both fine-grained control over memory and performance and high-level abstractions that make the software more reliable and quicker to produce [5]. The design of Rust ex-

exploits the state of the art research in linear types, affine types, alias types, and region-based memory management [9]. The ownership-based type system has been formulated into formal statements and proven for the safety guarantees they make [10]. These features allow Rust to guarantee memory, type, and concurrency safety at compile-time. Ownership[10] and Borrowing[5] form the crux of the safety mechanisms of Rust. These mechanisms allow Rust to guarantee compile-time memory safety and freedom from data races boldly.

Generics[11] and traits[12] are the primary mechanism to achieve polymorphism and code-reuse in Rust. The ownership type system of Rust allows expressing and enforcing typestates at compile-time, which is useful in safety-critical applications.[13]. Because C does not support generics, kernels written in C tend to use pointers and unsafe typecasts to emulate type polymorphism. But this is a highly unsafe approach and opens doors to severe vulnerabilities [3]. HarSaRK leverages Rust generics to provide a type-safe Inter-process messaging and resource management primitives.

Null pointer de-referencing and flawed exception handling have been the cause for various notorious bugs in the history of software development. Rust replaces these with strong types defined using generics and enums, which makes compile-time error handling and other static checks in Rust very robust. The Rust library defines two Enums: `Option<T>` and `Result<T,E>`. The `Option` type encodes the very common scenario in which a value could be something or nothing. The `Result` enum helps represent cases where a function might not succeed, so the return value will either contain the value or the error [11].

Though the kernel does not use dynamic memory, the application tasks might need support for it, and thus HarSaRK supports it. This is where Rust shines ahead of most other compiled languages. The ownership and borrowing mechanism statically manage memory, thus wiping away a large group of bugs like memory leaks, double free, use after free, etc [14].

The resource primitive provided by HarSaRK encapsulates the actual resource and ensures that the only way tasks can access the resource is via the methods provided by the primitive, which are safe by design. The static checks are done by Rust to ensure that only concurrency safe variables are shared across tasks [15]. In this way, HarSaRK is able to guarantee concurrency safety at compile time.

### 2.1. Unsafe Rust

In low-level programming, there are various scenarios, for which full control over the function stack layout is necessary. A typical example is the implementation of a context switch. Typically, this is addressed by building the required code with an assembler and linking it to the rest of the Kernel code. However, this breaks the development workflow, and the Rust compiler cannot check these parts [16]. Thus, these code regions have to be explicitly marked unsafe.

It is the responsibility of the developer to ensure well-defined behavior inside the unsafe blocks. If the developer can guarantee that code inside the unsafe blocks does not lead to undefined behavior, then the compiler can proceed to verify the rest of the codebase, assuming that this unsafe block works fine [17].

In the Kernel implemented, the only routine that uses unsafe blocks is the context switch routine, as it requires access to CPU registers and modification of process stacks.

### 3. Kernel Architecture

The proposed Kernel is organized into various sub-systems based on their functionalities. Each module encloses the associated data-structures and routines in it. The sub-systems interact with each other via appropriate interfaces. They also provide certain public calls that can be invoked by the end-application.

The Kernel Architecture has been inspired by the Hartex Micro-kernel design [18]. Boolean Vectors have been used internally in the sub-systems instead of other complex data structures which reduces the kernel overhead considerably. Optional modules can be chosen not to be included in the compiled binary. A Boolean Vector internally translates to a 32-bit integer. Each bit represents the state of the task with TaskID as the position of the bit. This implies that the kernel supports a maximum of 32 tasks. In the current work, we have restricted ourselves to primary level scheduling. However, if the need for more tasks arises, then one of the tasks in the tasks can itself act as a scheduler and perform secondary level scheduling of additional tasks. Figure 1 depicts the block diagram of HarSaRK-RS.

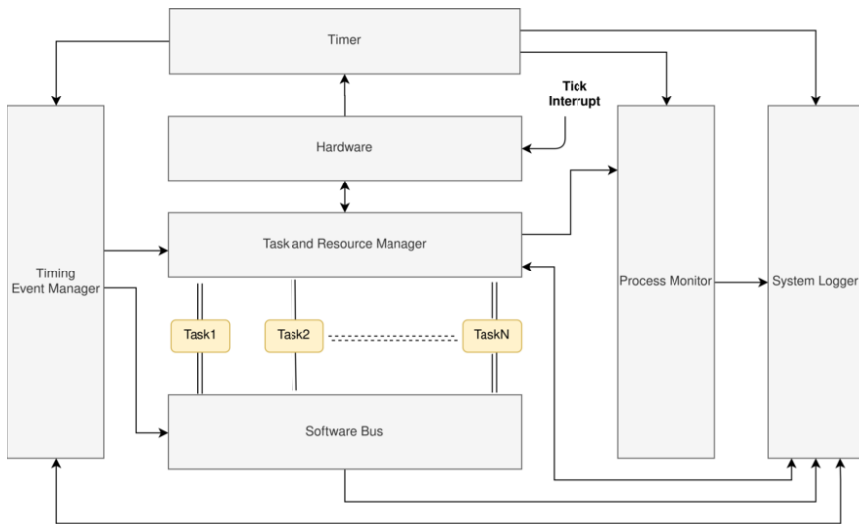

Figure 1. HarSaRK-RS block diagram

#### 3.1. Hardware Adaptation Layer (HAL)

This is the closest layer to the hardware. It provides safe abstractions to the other Kernel modules to access and modify the hardware peripherals. Due to the modular approach of HarSaRK-RS, all hardware-dependent routines in the Kernel comprise the HAL. Thus, the porting of Kernel onto other machine architectures would only require the rewriting of this module.

### 3.2. Task Management

The task-management module schedules tasks preemptively on the CPU based on priority. On activation of a higher priority task, this module handles storing the context of the current task and loads the context of the highest priority task. Multi-tasking in single-core processors is done by scheduling multiple tasks one-by-one on the CPU. In case the Scheduler does not have any tasks to schedule on the CPU, then it puts the CPU to sleep. The CPU is woken up again on the occurrence of an interrupt. In this manner, the Kernel optimizes the power consumption of the system as a whole.

After the creation of all tasks, all operations on it are on two Boolean vectors `active_tasks` and `blocked_tasks`. Each task has its own separate task stack. A few examples of how the use of Boolean Vectors reduces the kernel overhead drastically are:

- Releasing tasks is as simple as enabling the bits in `active_tasks`. Let's say multiple tasks have to be released, which are encoded into a boolean vector `task_mask`. Now all that's needed to be done is `active_tasks = active_tasks | task_mask`, which is a  $O(1)$  operation. Hence improves the execution time of the whole system drastically. The same follows for blocking and unblocking tasks.
- Improvements in the release, block, and unblock of tasks directly influence the performance of the other kernel primitives like Semaphore, Message, and Resource, as they also internally use Boolean Vectors and are highly dependent on these routines.
- The Scheduler can compute the new highest priority task to be scheduled by just finding the Most significant bit (MSB) of `active_tasks & !blocked_tasks`. In HarSaRK-RS, MSB is calculated using a CPU instruction CLZ(Count leading Zeroes)[19], which is a constant time operation. As this is an integral part of a context switch, improvements enhance the responsiveness and hence real-time guarantees of the system.

The tasks in HarSaRK-rs are user (application) tasks, which could be composed to realize an end control system. These tasks are basic tasks meaning they are of non-blocking style. HarSaRK is a library kernel, thus tasks are defined as functions and the kernel allocates the stack space for it and takes care of scheduling it. However, if the deployment demands additional hardware support (e.g. device drivers), such support could be implemented as a task with certain higher priority. The task priorities are static and fixed, such a scheme prevents deadlocks by design. The tasks are not infinitely looping, rather they are released by events, and once they finish execution they yields. As of our current implementation, it is based on stack-based priority ceiling protocol that overcomes deadlock and bounded priority inversion. But in extreme cases where a high priority task is being released, again and again, there are chances of task starvation. This can be addressed in application design by assigning frequently released tasks a lower priority.

### 3.3. Resource primitive

In multitasking systems, the shared resources are to be used in an atomic fashion, which can be easily achieved by the use of Mutex. But Atomic allocation of resources intro-

duces Deadlocks. Deadlocks cannot be accepted in real-time systems as they put the whole system on a halt. HarSaRK-RS employs the Stack-based priority ceiling protocol (SBPC)[20], which ensures the atomic use of resources without running into deadlocks and priority inversion. The Resource manager ensures atomicity by execution locking, i.e., when a resource is being locked, all competing tasks are blocked right away. These tasks are unblocked when the resource is unlocked.

The concept of ownership allows the resource primitive to take ownership of the actual resource i.e., after a resource primitive is initialized with a variable, the variable becomes invalid. The only way to access the variable is to call lock on the resource primitive. This ensures at compile time that all accesses to resources go via the primitive. The Resource primitive supports safe polymorphism via Traits and Generics.

### 3.4. Synchronization primitive

Some tasks execute certain set of instructions only if another task has completed execution till a certain point (called a synchronization point). This is known as task synchronization. It is achieved by notifying the receiver tasks on reaching the synchronization point, from where it resumes execution. Note that the Synchronization primitive provided by HarSaRK-RS is asynchronous, i.e., it just checks if the notification was received and if yes, it executes those instructions; if not, it skips those set of instructions and proceeds with the rest of the instructions.

### 3.5. Communication primitive

At the core, communication is just synchronization, but in addition to notification at synchronization points, messages can be passed to the tasks. The message primitive ensures that the details of the sender, receivers, and message buffer need not be specified every time to send a message; instead, only the name of the message is required. These details are provided while initializing the message primitive. The Communication primitive also supports safe polymorphism via Traits and Generics.

### 3.6. System Timer (Optional)

For the operation of a few sub-systems, system time is necessary. The system timer module uses the timer interrupt to update its time. The developer can choose the interruption frequency by choosing an appropriate `timer_interval`. This `timer_interval` defines the granularity and precision of time and event management in the system.

### 3.7. Timing event manager (Optional)

The timing event manager uses the System timer to detect timing events. Every event created has an event descriptor that holds a threshold. This defines the time period of the event as a multiple of the `timer_interval` of the system timer. It also holds a function pointer, which will be executed when its threshold expires. Once the threshold of an event expires, then the threshold is reset.

### 3.8. System Event Logger (Optional)

For monitoring and debugging purposes, some systems would like to keep track of all the internal kernel events that are occurring in the system with the timestamp. This log data can be used to modify the tasks. Alternatively, they can be sent to an operator station via ports like UART/Serial. Some microcontrollers support external storage, which can be used to store these logs. System Event Logger collects events like the release of tasks, tasks exiting, locking of resources, etc. Consequently, this data can be collected and processed by the developers. The logs collected during runtime can prove to be extremely useful in debugging, analyzing, and performance tuning of the system.

### 3.9. Process Monitor (Optional)

Some hard real-time systems would want to monitor the tasks and keep track of the tasks and their deadlines. This module allows the developer to specify the relative deadline by which a task should have finished once the task has been released. It must be noted that the deadline is specified as a multiple of `timer_interval`. This module stores the deadline and checks with the system time to see if any task has expired. Whenever a task exceeds its deadline, it creates a log entry in the System event logger.

### 3.10. Privileges and Memory Protection

The Kernel operates at two operation modes and two privilege levels, which are discussed in this section [19].

- The operation modes:
  - \* Thread mode: The processor is running a normal program.
  - \* Handler mode: The processor is running an exception handler like an interrupt handler or system exception handler.
- Kernel level and User level: It provides a mechanism for safeguarding memory accesses to important memory regions while providing a basic security model.

In thread mode, the CPU can either be in a Kernel state or in the User state. But while handling exceptions/interrupts, the processor switches to the Kernel state [19]. Tasks in User state are restricted from executing some operations.

The Kernel uses two stack pointers: a Main Stack Pointer (MSP) and a Process Stack Pointer (PSP). By default, all Kernel state (Kernel code and interrupt handlers) code runs on the MSP while the User state code (threads/tasks) runs on PSP [19]. The fact that the operating system and exception handlers use a different stack from the application means that the OS can protect its stack and prevent applications from accessing or corrupting it [19]. Also, it ensures that the OS does not run out of stack if the application consumes all the available stack space.

## 4. Experimentation

This section discusses the details of kernel implementation and testing.

**Table 1.** The execution time of various Kernel routines.

Description	Clock Cycles	Execution Time ( $10^{-6}$ Sec)
Load PendSV Interrupt Handler	20	0.120
Return from PendSV Interrupt Handler	23	0.137
Task Restore	20	0.120
Task Save	23	0.137
Context Switch	129	0.768
Effective Context Switch	43	0.256
Resource Lock	120	0.714
Resource Lock	84	0.500
Semaphore Signal	64	0.381
Semaphore Test and Reset	31	0.185
Message Broadcast	64	0.381
Message Receive	47	0.280

- Development machine: Linux
- Target platform: STM32F407 Microcontroller (Cortex M4 - ARM based) [21].
- Compiler toolchain: Standard Rust compiler, with cargo for package management.
- Debugger: arm-none-eabi-gdb for debugging.

The overhead of a real-time kernel can be measured by parameters: the binary size, the kernel data structure size, and the task switch time. The size of kernel after compilation is 3.8 Kb, which will fit into most microcontrollers without an issue. For measuring the execution time of different routines, we used the Data Watchpoint and Trace (DWT) peripheral [19] which allows us to measure the clock cycles elapsed between two points in the code [22].

Two very popular industrial real-time kernels Freescale MQX[23] and Quadros RTXC[24] have been compared with HarSaRK-RS for their task switch times. Both of these kernels are coded in C. The performance benchmarks of these kernels on Cortex M4 based microcontroller clocked at 96Mhz state the following about their task switch time [25]:

- Quadros RTXC takes  $5.2\mu s$ , which translates to roughly 500 clock cycles and
- Freescale MQX takes  $12.8\mu s$ , which translates to roughly 1171 clock cycles.

Task switch in HarSaRK-RS takes about 129 clock cycles, which is much smaller than the task switch time of Freescale MQX and Quadros RTXC. Though the microcontroller used for the benchmarks is different, comparisons of clock cycles is very much valid as they are using the same CPU. This is despite the safety guarantees made by HarSaRK.

## 5. Conclusion

The Kernel has been developed in a modular fashion, and with the help of cargo feature flags, it supports the optional compilation of Kernel modules. We have done an overhead analysis of the Kernel to get an idea of the execution times of vari-

ous kernel routines and the final binary size. All the modules of the Kernel have been developed as per specification and tested manually on ST32F407 microcontroller. The Kernel has been published as a Rust library on the cargo package directory. The source code has been open-sourced under MIT license accessible via <https://github.com/Autonomous-Cyber-Physical-Systems/harsark.rs>.

In summary, HarSaRK-RS brings novelty in design and implementation as listed below:

- The use of Boolean Vectors reduces the overhead of all kernel sub modules. All core kernel routines are  $O(1)$  operations, thus minimizing jitter across the system.
- The Kernel is built over strong types and robust error handling, thus reducing chances of erroneous behavior. The use of Rust has helped guarantee compile-time concurrency safety and much better memory safety.
- The modular approach of the Kernel allows extensibility to various platforms and supports even support smaller microcontrollers.
- Separation of stack for kernel and user tasks and different privileges guarantees the safer operation of the system on the whole.
- Use of SBPC(subsection 3.3) protects the system against Data Races, Deadlocks, and Priority Inversion.
- Process monitor(subsection 3.9) and System logger (subsection 3.8) can prove to be extremely useful in debugging, analysis and performance tuning of the system.
- The Kernel core itself is independent of any clock; thus the timing module can be disabled to achieve better performance and lower power consumption without loss of any real-time guarantees. This makes HarSaRK-RS ideal for battery operated environments like IoT.

## References

- [1] Armoush A. Design patterns for safety-critical embedded systems; 2010. .
- [2] Linux Linux Kernel : CVE security vulnerabilities, versions and detailed reports;. Available from: [https://www.cvedetails.com/product/47/Linux-Linux-Kernel.html?vendor\\_id=33](https://www.cvedetails.com/product/47/Linux-Linux-Kernel.html?vendor_id=33).
- [3] Chen H, Mao Y, Wang X, Zhou D, Zeldovich N, Kaashoek MF. Linux Kernel Vulnerabilities: State-of-the-Art Defenses and Open Problems. New York, NY, USA: Association for Computing Machinery; 2011. Available from: <https://doi.org/10.1145/2103799.2103805>.
- [4] Steve Klabnik CN. The Rust Programming Language - The Rust Programming Language;. Available from: <https://doc.rust-lang.org/stable/book/>.
- [5] Weiss A, Patterson D, Matsakis ND, Ahmed A. Oxide: The Essence of Rust. arXiv:190300982 [cs]. 2019 Mar;ArXiv: 1903.00982. Available from: <http://arxiv.org/abs/1903.00982>.
- [6] Why Rust? - The Redox Operating System; 2020. Available from: <https://web.archive.org/web/20200510173103/https://doc.redox-os.org/book/ch01-07-why-rust.html>.
- [7] Oppermann P. phil-opp/blog\_os; 2020. Available from: [https://github.com/phil-opp/blog\\_os](https://github.com/phil-opp/blog_os).
- [8] Levy A, Campbell B, Ghena B, Pannuto P, Dutta P, Levis P. The Case for Writing a Kernel in Rust. In: Proceedings of the 8th Asia-Pacific Workshop on Systems. APSys '17. Mumbai, India: Association for Computing Machinery; 2017. p. 1–7. Available from: <https://doi.org/10.1145/3124680.3124717>.
- [9] Balasubramanian A, Baranowski MS, Burtsev A, Panda A, Rakamarić Z, Ryzhyk L. System Programming in Rust: Beyond Safety. In: Proceedings of the 16th Workshop on Hot Topics in Operating Systems. HotOS '17. New York, NY, USA: Association for Computing Machinery; 2017. p. 156–161. Available from: <https://doi.org/10.1145/3102980.3103006>.
- [10] Jung R, Jourdan JH, Krebbers R, Dreyer D. RustBelt: Securing the Foundations of the Rust Programming Language. In: 45th ACM SIGPLAN Symposium on Principles of Programming Languages



- (POPL 2018). vol. 2 of POPL. Los Angeles, CA, United States: ACM; 2018. p. 66. Available from: <https://hal.archives-ouvertes.fr/hal-01633165>.
- [11] Steve Klabnik CN. Generic Data Types - The Rust Programming Language;. Available from: <https://doc.rust-lang.org/book/ch10-01-syntax.html>.
- [12] Steve Klabnik CN. Traits: Defining Shared Behavior - The Rust Programming Language;. Available from: <https://doc.rust-lang.org/book/ch10-02-traits.html>.
- [13] Erdin M, Astrauskas V, Poli F. Verification of Rust Generics, Typestates, and Traits. 2018;.
- [14] Steve Klabnik CN. References and Borrowing - The Rust Programming Language;. Available from: <https://doc.rust-lang.org/book/ch04-02-references-and-borrowing.html>.
- [15] Steve Klabnik CN. Send and Sync -;. Available from: <https://doc.rust-lang.org/nomicon/send-and-sync.html>.
- [16] Lankes S, Breitbart J, Pickartz S. Exploring Rust for Unikernel Development. In: Proceedings of the 10th Workshop on Programming Languages and Operating Systems. PLOS'19. New York, NY, USA: Association for Computing Machinery; 2019. p. 8–15. Available from: <https://doi.org/10.1145/3365137.3365395>.
- [17] Heldring W. An RTOS for embedded systems in Rust. University of Amsterdam; 2018. Available from: <https://esc.fnwi.uva.nl/thesis/centraal/files/f155044980.pdf>.
- [18] Banda G. HARTEX - Scalable Real-Time Kernel for Small Embedded Systems; 2003. Available from: <http://citeseerx.ist.psu.edu/viewdoc/download;jsessionid=84D11348847CDC13691DFAED09883FCB?doi=10.1.1.118.1909&rep=rep1&type=pdf>.
- [19] Yiu J. Definitive guide to the ARM Cortex-M3. Embedded technology series. Amsterdam ; Boston: Newnes; 2007. OCLC: ocn170955405.
- [20] Liu JWS. Real-time systems. Prentice Hall; 2000.
- [21] STM32F4 Series;. Available from: <https://www.st.com/en/microcontrollers-microprocessors/stm32f4-series.html>.
- [22] Aparicio J. Overhead analysis of the RTFM framework - Embedded in Rust;. Available from: <https://blog.japarcio.io/rtfm-overhead/>.
- [23] RTXQ Quadros Real Time Operating System;. Available from: <https://quadros.com/products/operating-systems/rtxc-quadros-rtos-advanced/>.
- [24] RTXQ 3.2 RTOS;. Available from: <https://quadros.com/products/operating-systems/rtxc-3-2-rtos/>.
- [25] Örnvall O. Benchmarking Real-time Operating Systems for use in Radio Base Station applications; 2012.

# Automated Drone-Based Aircraft Inspection

Soufiane BOUARFA<sup>a,1</sup> Joselito SERAFICO<sup>a</sup>

<sup>a</sup>Abu Dhabi Polytechnic, Al Ain, United Arab Emirates

**Abstract.** Deep learning combined with autonomous drones is increasingly seen as an enabler of automated aircraft inspection which can support engineers detect and classify a wide range of defects. This can help increase the accuracy of damage detection, reduce aircraft downtime, and help prevent inspection accidents. However, a key challenge in neural networks is that their stability is not yet well understood mainly due to the large number of dimensions and the complexity of their shapes. This paper illustrates this challenge through a use case that applies MASK R-CNN to detect aircraft dents. The results show that environmental factors such as raindrops can lead to false positives. The paper also proposes various test scenarios that need to be considered by the developers of the drone-based inspection concept to increase its reliability.

**Keywords.** Reliability, aircraft inspection, drones, convolutional neural network

## 1. Introduction

The current aircraft maintenance inspection process has not evolved during the last 40 years despite the rapid advances in technology. It is not only time consuming as it requires a long time to prepare work platforms, ground support, and anti-fall straps to conduct inspection; but also dangerous as reports of injuries during inspection are not uncommon. Automating the inspection process can therefore increase workplace safety by reducing incidents, and reduce costs related to maintenance which remains the second largest cost for airlines after fuel (e.g. manhours, equipment, training, PPE costs, etc.). In addition, automation will enable a more objective assessment of damage as different inspectors can have different assessments. This would prevent from the failure to detect critical damage as it was the case for the Aloha Airlines Flight 243 [1] and recently the Virgin Australia Regional Airlines ATR72 [2].

There is no doubt that computer vision will soon revolutionize aircraft inspection as it's already the case other domains that require visual assessment. This is not surprising given that object detection errors by a machine decreased from 26% in 2011 to only 3% in 2016 which is less than the human error of 5% [3]. The main driver behind these improvements is deep learning which had a significant impact on robotic perception following the design of AlexNet in 2012. In medical imaging diagnosis for instance, technology has become so good that the FDA has recently approved many use cases [4]. In the automotive industry, companies such as Tesla and Waymo are working towards fully driverless cars enabled by computer vision technology that can detect

---

<sup>1</sup> Corresponding Author, Abu Dhabi Polytechnic, P.O.Box: 66844, Al Ain, UAE; E-mail: soufiane.bouarfa@outlook.com.

various objects around the car. In production and manufacturing environments, computer vision is used for the external assessment of product quality and equipment such as tanks, pressure vessels, and pipes. In agriculture, computer vision algorithms are integrated with drones that can scan large fields in a matter of minutes. Images are collected and processed to help farmers make informed decisions about their crops. The captured images include soil and crop conditions to monitor for any stress or disease [5].

Recently the aviation community started to develop the drone-based aircraft inspection concept. For instance, Ubisense and Mrodrone [6,7] have developed an inspection system that has been tested by Easyjet and is planned to be rolled out across Easyjet's European bases. KLM Engineering & Maintenance is also experimenting with drones to inspect their aircraft and the research program is currently in its second trial phase. Another initiative is the Air-Cobot project [8] which aims at automating aircraft visual inspection and involves various academic and industrial partners including Airbus. In the same vein, the authors have also recently developed a Convolutional Neural Network to detect aircraft dents [9]. All these efforts aim at obtaining a good accuracy in defect detection and classification. However, as sensors can sometimes be unreliable, the question remains how well the system would perform in real-life outside the hangar? How to further improve it knowing that the slightest error in object detection can potentially lead to an aircraft accident if defects went unnoticed? And how to increase the confidence of aircraft engineers [10,11] in the drone-based aircraft inspection?

These are all challenging questions as most of the research efforts in deep learning focus on improving the detection accuracy, but lag when it comes to neural network safety/stability and dealing with various types of uncertainties. This is mainly due to the lack of understanding of deep learning technologies even by AI experts. This can be explained by the large number of dimensions and complexity of the shape of neural networks. In addition, there has been little emphasis on standards and methodologies which can lead to a stable and reliable intelligent environment [12]. To tackle this problem, this paper proposes different test scenarios that need to be considered by the aviation community in order to make drone-based inspection more reliable. The scenarios can be used to further improve the stability of neural networks and robustness of the decision-support system and validate the concept.

This paper is organized as follows. Section 1 provides the introduction. Section 2 presents the motivation behind automating aircraft inspection. Section 3 presents the use case of using MASK R-CNN to detect dents and illustrates some of the challenges. Section 4 proposes test scenarios that need to be considered by the developers of the automated drone-based inspection concept to increase its reliability. The conclusion is provided in section 5.

## **2. Why Automate Aircraft Inspection?**

The aircraft inspection process is a recurrent process that needs to be conducted at every flight cycle. The level of inspection depends on different factors. For instance, if the aircraft was subject to abnormal events, a thorough inspection for potential damage is required. Examples of abnormal events include bird strike, lightning strike, hard landings, and encountering turbulent air. Table 1 shows examples of the inspections required for the King Air following abnormal events.

**Table 1.** Areas to be inspected after abnormal conditions [13].

Inspection Areas	Flight through turbulent air	Hard landings	Lightning strike	Inspections Required:
Nacelles	a	a		<b>a</b> - Cracks, wrinkles and loose or missing rivets
Wing Panels	a	a		<b>b</b> - Skin wrinkles at the juncture of the fuselage and empennage.
Fuselage Nose Section	a, c, d	a, d		<b>c</b> - Windshield for evidence of structural deformation or failure.
Fuselage Centre Section	a	a		<b>d</b> - Avionics, antenna and components for security and attachment.
Fuselage Aft Section	b	b		<b>e</b> - Burned hole/s in metallic surfaces.
Fuselage			e, f, g, h	<b>f</b> - Plastic parts – delaminated and/or deformed.
Empennage			e, f, g, h	<b>g</b> - Antennas – for evidence of arcing, sooting, or pitting.
Wing Surfaces			e, f, g, h, i	<b>h</b> - Structure between entry and exit points.
				<b>i</b> - If near fuel vent, inspect all plumbing for damage.

Automated aircraft inspection basically aims at automating the visual inspection process normally carried out by aircraft engineers. i.e. It aims at detecting defects that are visible on the aircraft skin which are usually structural defects. These can include dents, lightning strike damage, surface finish defects, fasteners defects, corrosion, cracks, just to name a few. Automatic defect detection can be enabled by using a drone-based system that can scan the aircraft and detect/ classify a wide range of defects all in a very shorty time. Eliminating the manual process can lead to a significant impact on aircraft operators with numerous benefits including but not limited to:

- Reduction of time spent on maintenance: The drone can quickly reach difficult places such as the flight control surfaces in both wings and empennage. This in turn will reduce man hours and preparation time as engineers would need heavy equipment such as cherry pickers to have more scrutiny. The inspection time can be even further reduced if the drone-based system is able to assess the severity of the damage and the affected aircraft structure with reference to aircraft manuals.
- Reduction in safety incidents and PPE related costs: Engineers no longer need to work at heights or expose themselves to hazardous areas e.g. in case of dangerous aircraft conditions or the presence of toxic chemicals. This also reduces costs on Personal Protective Equipment.
- Reduction in Aircraft-On-Ground (AOG) time: Time savings on inspection time can lead to reductions of up to 70% in turnaround times.
- Reduction in decision time: Defect detection will be much more accurate and faster compared to the current visual inspection process. E.g. it takes operators between 6 to 8 hours to find lightning strike damage. This can be reduced up to one hour with an automated drone-based system. Such time savings can free up aircraft engineers from dull tasks and making them focus on more important tasks. This is especially desired given the projected need of aircraft engineers in various regions of the world according to a recent Boeing study.
- Objective damage assessment and reduction of human error: If the dataset used by the neural network is annotated by a team of experts who had to reach consensus on what is a damage and what not, then detection of defects will be

more objective. Consequently, human errors such as failing to detect critical damage (e.g. due to fatigue or time pressure) will be prevented.

- **Augmentation of Novices Skills:** It takes a novice 10000 hrs. to become an experienced inspector. Using a decision-support system can significantly augment the skills of novices.

### 3. Automated Defect Detection Using MASK R-CNN

To demonstrate the concept of automated drone-based inspection, the authors have applied MASK R-CNN to automatically detect aircraft dents [9]. Mask R-CNN is an instance segmentation model which enables the identification of pixel-wise delineation of the object class of interest. In order to get instance segmentation for a particular image, two main tasks are required: First, the bounding box-based object detection (Localization task) which uses similar architecture as faster R-CNN [14]. The only difference in Mask R-CNN is the Regions of Interest (ROI) step. Instead of using ROI pooling, it uses ROI align to allow the pixel to pixel preserve of ROIs and prevent information loss. Second, the semantic segmentation which allows segmenting individual objects at pixel within a scene, irrespective of the shapes. Semantic segmentation uses a Fully Convolutional Network which creates binary masks around the bounding box objects through creating pixel-wise classification of each region. Hence, Mask R-CNN minimizes the total loss.

The neural network was trained with 55 photos containing aircraft dents. Because the dataset was small, it was decided to use a 10-fold cross validation approach [15]. So, the dataset was split into 10 equally sized parts 9 of which were used for training and 1 one for testing. The experiment included 10 different combinations of training and test pairs. The performance of each fold was evaluated using precision and recall (see Table 2). During the initial 15 epochs of training, the RESNET weights were kept constants, while the layers of the head of MASK-RCNN were trained and finetuned. The head includes the Region Proposal Network, Masking, and Bounding Boxes, among others. Then another 5 epochs were used to continue training the head of the Mask R-CNN structure including the RESNET layer. An important improvement in both precision and recall was noticed. This could be explained by the fact that the RESNET layer functions as a feature extractor and therefore training it leads to more true positives.

**Table 2.** Average results corresponding to 10 folds. Precision =  $TP / (TP + FP)$ , Recall =  $TP / (TP + FN)$ , TP: True Positives, FP: False Positives, FN: False Negatives. Confidence Threshold = 73%.

Performance	Training head only (15 epochs)	Training head (15 epochs) + RESNET (5 epochs)
Train Size	49.5	49.5
Test Size	5.5	5.5
TP	5.7	6.9
FP	3.8	3.0
FN	6.1	5.4
Precision	53.6%	69.13%
Recall	46.2%	57.32%

Analyzing the results show that factors such as lighting and environmental conditions can mislead the model. For instance, raindrops and rivets can be confused with dents (Figure 1). Therefore, additional training with data containing these anomalies is required, and more experiments need to include these types of scenarios during the physical testing of the drone.

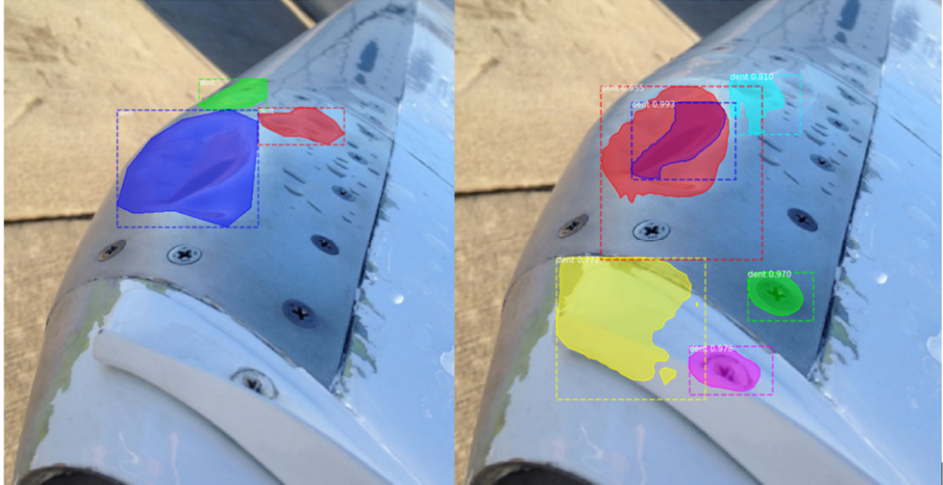

**Figure 1.** False Positive examples from Fold 10 test set where raindrops and rivets are confused with dents. The manually labeled photo is on the left while the prediction is shown on the right.

#### 4. Test Scenarios

This section presents different scenarios which can be used to improve the reliability of automated drone-based aircraft inspection. These scenarios can also be used to design neural networks architectures specifically tailored to the aircraft inspection problem.

##### 4.1. Environmental & Diurnal Effects

Environmental effects such as rain, sand, and salt can drastically affect object detection performance. As shown in [9], It might be a challenging task for the drone to detect defects under this type of scenarios because it remains a challenging task even for humans. However, equipping the drone with advanced scanning hardware might resolve this problem. In addition, Diurnal effects such as changes in light and temperature can also affect detect detection [9] (Figures 2-3). This could be an issue if the drone scans the aircraft from a fixed angle, as aircraft engineers usually inspect aircraft parts from different angles in order not to miss critical damage. A potential solution is to use multi-drone teaming and swarming with the help of light beams.



**Figure 2.** The gaps could be due to lose fasteners in edge of skin lap. Defect can easily be missed if not inspected standing on a work stand. The light plays an important role in damage detection. Photo taken at Abu Dhabi Polytechnic Hangar.

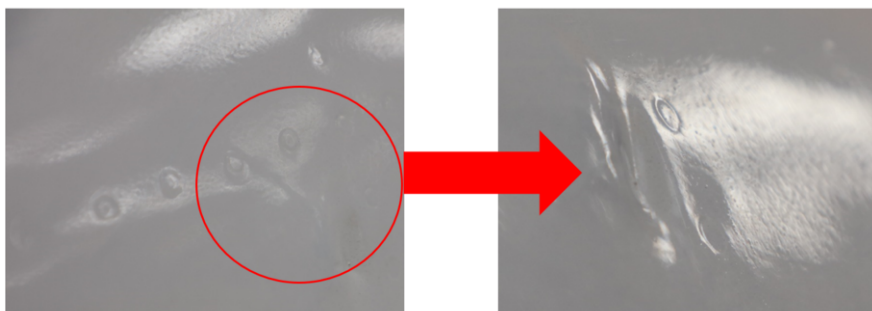

Uneven surface image is a suspect defect area.

The same spot viewed from different angle confirmed presence of dents.

**Figure 3.** Dents on an engine cowling of Falcon 20 at Abu Dhabi Polytechnic Hangar.

#### 4.2. Allowable Damage

Not all defects detected by human operators must be repaired. When an aircraft engineer detects a dent in the rear fairing skin for instance, he performs various reasoning processes (Figure 4). E.g. looking whether the structure is primary or secondary, consulting aircraft documentation to check if the defect is allowable or must be repaired. Engineers also look at the type of material affected (e.g. chemically milled section, composite structure, and laminated honeycomb) as different materials have different properties. Therefore, to reduce false positives, the drone should be able to distinguish between allowable and non-allowable damage.

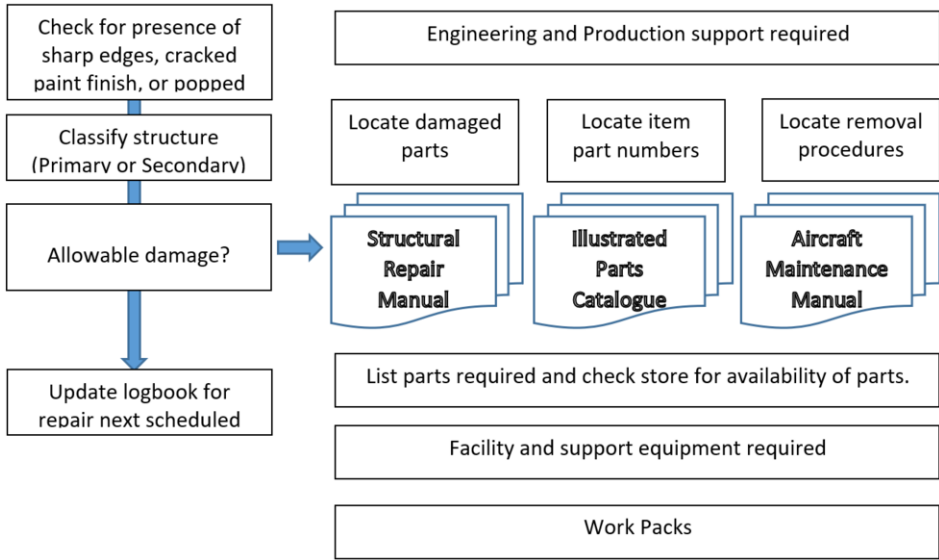

Figure 4. Damage examination and evaluation by a human inspector.

For instance, taking a scratch on the Falcon 20 as an example damage. Its importance depends on the nature of the scratched material, the shape of the scratch, and the depth of the scratch [16]. Scratches with sharp edges, triangular or trapezoidal bottom are the worst. Deep scratches usually eliminate the protective coating and reduce the cross section of the stressed material. The drone should be able to precisely measure the depth of the scratch using advanced scanning hardware and compare it to the thickness of the protective coating shown in table 3. A scratch with a depth less than the coating thickness will be considered negligible (less than 0,04 mm). It is prohibited to smooth out such scratches as it could lead to the reduction of thickness of the protective coating and corrosion. If the scratch is deeper than 0,04 repair actions are needed. These include eliminating the ‘notching effect’, protecting against corrosion, and patching the scratched area. Another example damage includes dents. An allowable dent must not exceed a specific length (Figure 5) and must be free from sharp creases, gouges, or cracks. Similar requirements exist for other types of damage e.g. cracks, localized impact, corrosion, wear, etc.

Table 3. Coating thicknesses on the Falcon 20.

Material nominal thickness [mm]	Thickness of Aluminum Coating each Face [1/100 mm]
0.3 to 0.6	4 to 6
0.8 to 1.6	4 to 6
2 to 3.5	4 to 8
4 to 6	4 to 10

The above requirements show that the drone algorithm should include relevant data from the aircraft Structure Repair Manual, Integrated Parts Catalogue, and Aircraft Maintenance Manual. The challenge would be the ability to assess and evaluate the damage similar to what an expert does. Therefore, experiments with the drone-based



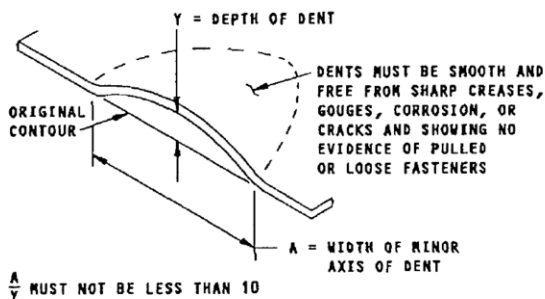

Figure 5. Allowable Dent [17].

inspection system should include various scenarios of both allowable and non-allowable damage.

#### 4.3. Rare/Unknown damage

Not all defects on aircraft have been encountered before (e.g. Figure 6). Therefore, the drone should be able to also detect unknown defects or very rare defects. This can be achieved by using unsupervised anomaly detection with Generative Adversarial Networks (GANs). With this method, it becomes possible to address the challenging task of detecting defects that were never seen before or are very rare. This is important when it is unclear what an anomaly is going to look like, or when there is no labeled data to train an image classifier with. Through training a GAN only with normal aircraft pictures that do not contain defects, it learns what healthy aircraft look like and would flag anything unusual. This can be double checked by operators to take actions if necessary.

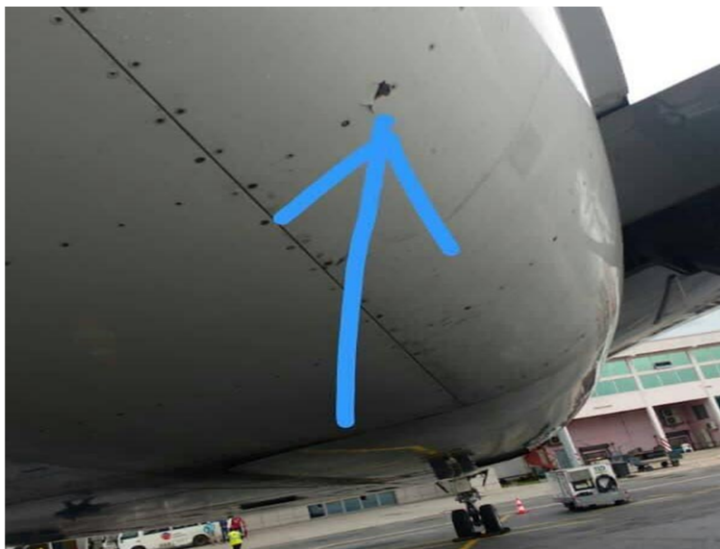

Figure 6. Example of a rare defect: Gunshot Damage of an A330-300 hit by a bullet in Congo on April 11<sup>th</sup>, 2020.

## 5. Conclusion

Automated drone-based aircraft inspection is a promising approach to further optimize aircraft maintenance operations. The concept could lead to important cost savings for aircraft operators as less time is spent on maintenance. Furthermore, inspection risk can also be reduced as engineers would no longer need to work at heights. However, significant research efforts are still needed to test the concept under various conditions and make it more reliable. This paper has proposed test scenarios to be considered by the system designers to further develop the concept and connected them with requirements that the automated drone-based system should satisfy. The requirements include 1) the ability to detect and classify defects under different environmental and diurnal conditions; 2) the ability to distinguish between an allowable damage and non-allowable damage thereby reducing false positives; and 3) the ability to detect rare or unknown damage that was never encountered before.

## References

- [1] Wikipedia. Aloha Airlines Flight 243. 2020 May 14. Available from: [https://en.wikipedia.org/wiki/Aloha\\_Airlines\\_Flight\\_243](https://en.wikipedia.org/wiki/Aloha_Airlines_Flight_243)
- [2] Aeroassurance. ATR72 Missed Damage: Maintenance Lessons. 2009 Oct 12. Available from: <http://aeroassurance.com/safety-management/atr72-missed-damage/>
- [3] Gina S. Google Brain chief: AI tops humans in computer vision, and healthcare will never be the same. 2017 Sep 27. Available from: <https://siliconangle.com/2017/09/27/google-brain-chief-jeff-dean-ai-beats-humans-computer-vision-healthcare-will-never/>
- [4] Carfagno, J. 5 FDA Approved Uses of AI in Healthcare. 2019 Jul 18. Available from: <https://www.docwirenews.com/docwire-pick/future-of-medicine-picks/fda-approved-uses-of-ai-in-healthcare/>
- [5] Precisionhawk. Drone-based Aerial Intelligence in Precision Agriculture. 2019 Jul 5. Available from: <https://www.precisionhawk.com/hubfs/PrecisionHawk%20PrecisionAnalytics%20Agriculture%20Solution%20Brief%202019.pdf>
- [6] MRODrone. Drone-based aircraft damage inspection system. 2020 May 13. Available from: <https://www.mrodrone.net/>
- [7] Ubisense. Ubisense and MRO drone launch world's first smart hangar solution. 2018 Apr 11. Available from: <https://ubisense.com/ubisense-and-mro-drone-launch-worlds-first-smart-hangar-solution/>
- [8] Jovancevic I, Larnier S, Orteu JJ, Sentenac T. Automated exterior inspection of an aircraft with a pan-tilt-zoom camera mounted on a mobile robot. *Journal of Electronic Imaging, Society of Photo-optical Instrumentation Engineers*. 2015 Nov 30; 24 (6), pp.061110. Available from: <https://www.spiedigitallibrary.org/journals/Journal-of-Electronic-Imaging/volume-24/issue-6/061110/Automated-exterior-inspection-of-an-aircraft-with-a-pan-tilt/10.1117/1.JEI.24.6.061110.short?SSO=1>
- [9] Bouarfa S, Dogru A, Arizar R, Aydogan R, Serafico J. Towards Automated Aircraft Maintenance Inspection. A use Case of Detecting Aircraft Dents Using Mask R-CNN. 2020 Jan 5. AIAA scientific forum, 0389. Available from: <https://doi.org/10.2514/6.2020-0389>
- [10] Hornos MJ, Rodriguez-Dominguez C. Increasing user confidence in intelligence environments. *Journal of Reliable Intelligent Environments*. 2018 May 25. 4: 71-73. Available from: <https://link.springer.com/article/10.1007/s40860-018-0063-4>
- [11] Corno, F. User expectations in intelligent environments. *Journal of Reliable Intelligent Environments*. 2018 Jul 26. 4: 189-198. Available from: <https://link.springer.com/article/10.1007/s40860-018-0068-z>
- [12] Augusto JC, Coronato A. Introduction to the Inaugural Issue of the *Journal of Reliable Intelligent Environments*. *Journal of Reliable Intelligent Environments*. 2015 May 1. 1:1-10. Available from: <https://link.springer.com/article/10.1007/s40860-015-0005-3>
- [13] Textron Aviaion Inc. Beechcraft King Air 90 Series. Structural Inspection and Repair Manual. Chapter 51. 2020 Jan 1, Revision D2. Available from: <https://ww2.txtav.com>

- [14] Ren S, He K, Girshick R, Sun J. Faster R-CNN: Towards Real-Time Object Detection with Region Proposal Networks. *Computer Vision and Pattern Recognition*. 2016 Jan 6. Available from: [arXiv:1506.01497](https://arxiv.org/abs/1506.01497)
- [15] Alpaydin E. *Introduction to Machine Learning*. The MIT Press. 2010. Available from: <https://dl.acm.org/citation.cfm?id=1734076>
- [16] Avions Marcel Dassault. *Fan Jet Falcon Structural Repair Manual*. 1974 Jun. Chapter 51-10-11.
- [17] Boeing. *Structural Repair Manual 727*. 2000 Nov 25. Chapter 51-40-6. P9.

# A Gateway for Enabling Uniform Communication Among Inter-Platform JADE Agents

Juan A. Holgado-Terriza <sup>a,1</sup>, Pablo Pico-Valencia <sup>b</sup> Alvaro Garach-Hinojosa <sup>a</sup>

<sup>a</sup> *University of Granada, Granada, Spain*

<sup>b</sup> *Pontifical Catholic University of Ecuador, Esmeraldas, Ecuador*

**Abstract.** In general, software agents deployed in a multi-agent systems (MASs) collaborate and share data with each other by means of Foundation for Intelligent Physical Agents (FIPA) communications into the same agent platform (intra-). Java Agent Development framework (JADE) provides a facility software framework to build software agents executing in a specific agent platform. This paper presents a novel agent communication gateway aimed at abstracting FIPA communication between software agents on external (inter-) platforms. The novel agent communication gateway is based on the Agent-as-a-Service model (AaaS) implemented using REST technologies. The use of this gateway can favor and enable the interoperability among agents belonging to different MASs, opening collaborations and interactions among heterogeneous agents everywhere in Internet, whenever FIPA message exchanges are used as standard. In this paper some communication paradigms are presented based on the proposed gateway. Some implementation issues show that the programming complexity of communication blocks of agents can be decreased at both Java applications and Java web systems.

**Keywords.** Multiagent system, agent, JADE, FIPA, communication patterns.

## 1. Introduction

Multi-agent systems (MASs) integrate a set of software agents that communicate and collaborate with each other in order to achieve specific goals [1]. Software agents are entities that support properties such as proactivity, intelligence, autonomy, collaboration, mobility, adaptability and social ability in the environment where they operate [2].

According to the architecture and elements that integrate the software agents, these entities can be reactive, deliberative or hybrids [3]. Reactive agents constitute entities that integrate a mechanism to intercept events occurred in their environment and trigger actions to establish control operations that change such environment. On the other hand, deliberative agents, also known as BDI (belief, desire, intention) agents [4], are positioned as a complementary agent model to reactive one. BDI agents model their behavior using a mental state that allows them to make decisions in the environment in which they

---

<sup>1</sup>Corresponding Author: Juan A. Holgado-Terriza. University of Granada, Daniel Saucedo Aranda Street 18014 Granada, Spain; E-mail:jholgado@ugr.es

operate similarly to a human being. BDI artifacts turn deliberative agents into more intelligent entities than reactive agents. Finally, hybrid agents arise as an artifact that merges the best capabilities of reactive and deliberative agents.

Regardless of the architecture that agents adopt, software agents have inherent communication skills that allow them sharing data and messages. Consequently, modeling collaborative processes to meet their goals is enabled in distributed systems. Nevertheless, the agent communication between MASs is still a limitation in terms of complexity and interoperability [5]. These limitations have arisen due to the proliferation of agent tools that have not been regulated from the beginning of agent oriented technologies [6]. To solve this concern the Foundation for Intelligent Physical Agents (FIPA) [5] has emerged in order to establish standards in the development of software agents. Thus, one of the most significant contributions done by FIPA have been the development of the agent communication language (ACL) [7]. This language is currently a standard that agents tools must comply with in order to provide interoperable MASs.

Many of the tools that implement ACL as the standard for agent communication are currently used for the agent development. This language does not only ensure interoperability between distributed MASs developed in the same tool, but also enables them to communicate with heterogeneous MASs developed with any tool that comply with the FIPA standard. These advances rank the agents as very useful entities for the development of intelligent and collaborative distributed systems in environments such as desktop applications, web sites [8], mobile apps [9] and Internet of Things (IoT) systems [10].

Web and IoT systems have already begun their transition towards the use of services and/or resources [11]. This implies that processes are modeled from the orchestration of services and resources available on the Internet or intranets. In both cases the communications are done using uniform resource identifiers (URIs), providing a common way to access everywhere.

The integration of agents with service technologies can provide a paradigm to control automatically, autonomously and smartly the real world through dynamic network of heterogeneous devices interconnected via Internet [12]. The interplay of web-services and agents are usually managed based on two approaches [13,14]. On one hand, web-services can be integrated into agent platform in order to make accessible resources available in Internet to agents. In this case, the agents can request data or functionality on web-services addressed by a service architecture. Then, no additional mechanism is needed to add web services into the agent framework.

On the other hand, web-services can be used to hide the functionality of agents or a MAS behind the services. From external point of view the web-service is behaved exposing the agent functionality using an URI. An example is the Web Service Dynamic Client (WSDC), an add-on of JADE that provide web-service facilities to JADE agent. In this case, the web-service employs also an Agent-as-a-Service model based on a service oriented architecture (SOA). Then, a consumer service can invoke web-service by message exchanges using Simple Object Access Protocol (SOAP).

In this paper, the proposed gateway provides a novel JADE mechanism to interconnect heterogeneous agents living in different platforms located anywhere. On one hand, the gateway exposes an receiver agent of a specific platform as a web-service based on the second approach and, on the other hand, this web-service is provided as facility to a sender agent that wants accessing to receiver agent based on the first approach. The involved communications paradigms are presented in this work.

This paper is structured in five sections. Section 2 presents the review of the main agent platforms and their capability to support FIPA communication as well as the main patterns of communication implemented in JADE. Section 3 describes a gateway oriented to create blocks for establishing agent communication at both intra- and inter-communication agent platforms. In Section 4 some examples of the communication paradigm is detailed. Finally, Section 5 summarizes the conclusions.

## 2. Software Agents and Communication Patterns

Some of the most relevant studies aimed at comparing agent tools have been surveyed. These studies have compared and evaluated the most important agent tools categorizing them as programming languages [15,16,17] and agent platforms [18,19,20,21,6]. However, we have only considered agent platforms to be analyzed in this paper.

### 2.1. Agent Platforms

The comparison of the existing agent tools considers the following aspects: (i) type of tool such as toolkits, programming languages [17]; (ii) supported agent model such as reactive, deliberative and hybrid [3]; (iii) communication standard compliance such as FIPA [22,23]; and (iv) additional supported mechanisms such as mobility and security.

It is remarkable that some of the existing agent tools have not become popular among developers because they are not compatible with FIPA standards. However, tools that support this standard such as JADE has become widely used to create intelligent agent-based systems useful in ambient intelligence, healthcare, smart cities and industry [24].

Positive features of JADE framework such as its popularity, full documentation and its distribution as open source have motivated developers to use this tool as the baseline to create MASs. Nonetheless, a strong criterion for selecting JADE as a platform for creating agent-based systems is its usability and supporting of FIPA standards [19]. In addition to JADE, others consolidated FIPA-compatible tools have been developed, some based on Java such as Jadex or JACK and others based on Python such as Python Agent DEvelopment Framework (PADE) and Smart Python multi-Agent Development Environment (SPADE). Independently of the used technology, achieving interoperability between these platforms is technically feasible when FIPA is supported [25]. Only few tools do not support FIPA standards such as MADKIT.

### 2.2. Communications in JADE

JADE is a software framework for the development of agent applications in compliance with FIPA specifications for inter-operable intelligent MASs [7]. In terms of communication, JADE supports the following features: (i) a Java API to send/receive ACL messages to/from other agents, (ii) a library of FIPA interaction protocols ready to model complex interactions, (iii) compliance with the Internet InterORB Protocol (IIOP) to connect different agent platforms, and (iv) an usable GUI to manage agents and their interactions.

Agents developed in JADE use FIPA-ACL to share messages. An ACL message is a set of encoding elements that allows to transmit a series of knowledge expressed in a content language. The terms used correspond to a common vocabulary in order that any agent that supports this language understands each received message. Main elements that

make up an ACL message are the following: (i) a sender, (ii) a receiver, (iii) a content, (iv) a language, and (v) an ontology that describes the semantics of the message. In addition, it is also needed to define the message type to be composed, that is, INFORM, QUERY, REQUEST or PROPOSE.

The ACL language allows any agent developed in any programming language to use the same message format to interact with each other. So, agents can have the ability to share messages and data with agents running on heterogeneous agent platforms from different MASs, regardless of the programming language used.

### 2.3. JADE Communication Pattern

JADE uses the concept of platform to distribute agents in different hosts. Figure 1 illustrates the main communication patterns implemented by this tool. These patterns include two-level communication processes, that is, intra-platform (Figure 1a) and inter-platform (Figure 1b). In both cases, the communication patterns are request/inform processes in a similar way as the request/response paradigm in resource-oriented architecture (ROA) [26].

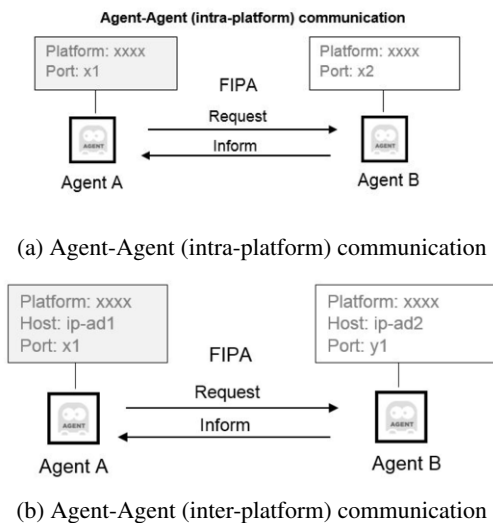

**Figure 1.** Basic patterns of communication supported by JADE.

Each request/inform communication process involves two entities, a sender and a receiver. Generally, in the basic communication patterns illustrated in Figure 1, both sender and receiver are agent entities that share an ACL message.

#### 2.3.1. Communication at Intra-Platform Level

The agent-agent communication pattern illustrated in Figure 1a constitutes the basic communication processes that JADE provides to MAS developers to share messages between agents running on the same platform. These patterns are used to implement the FIPA communication protocols such as: FIPA-Request, FIPA-Query, FIPA-Contract-Net, FIPA-Subscribe, FIPA-Propose [27].

In the pattern shown in Figure 1a both sender and receiver run on the same MAS. It is the typical communication at intra-platform level. To carry out this request/response process it is needed to define two arguments. The first one is the name of the platform in which the agent is running and the second aspect is the port from which the platform makes the connection. Both are mandatory for sender and receiver to establish a message exchange.

This pattern is elemental because it includes a single sender and a single receiver. However, it is possible to model more complex communication patterns with more than two receivers [28]. In this paper, we focus on one sender and only one receiver because our objective is to create a gateway to communicate with single agents that can be compatible with more complex communication patterns.

### 2.3.2. Communication at Inter-Platform Level

The communication patterns between agents at the inter-platform level follow the same structure at the intra-platform level. However, as illustrated in Figure 1b, in this pattern, both sender and receiver agents reside on different platforms that run on the same/different hosts in same/different networks. In this case, a communication can be set when agents know the platform name of the corresponding counterpart agent, their IP addresses and specific ports of the hosts where agent platforms of the counterpart agents are running.

Although the communication pattern at inter-platform level is rather general, some differences can be set depending where the platform is placed. Some differences and restrictions can be found in the execution of the communication pattern depending where the agent platforms are running. When the sender and receiver agents are running on platforms operating on the same host, they should have defined different ports. This case corresponds to agents of two MASs running on the same machine but sharing certain goals. On the other hand, when sender and receiver agents run on different hosts that connect to the same network, agent platforms that integrate the both agents involved in the communication can run on the same port without conflict as in the previous case. This pattern is recommended when it is necessary to have two MASs that run with their own computational resources.

Finally, when sender and the receiver agents are located on hosts in different networks, additional permissions are required to establish communication between two hosts. This pattern has similarities with the previous one but in this case, hosts where the agent platforms run are connected to different networks. Therefore, port conflicts, the use of the same platform names and difficulties to establish the link between different networks caused by firewalls may occur. However, it is feasible and advisable to give different names to avoid confusion when sending a message to a distributed agent.

## 3. Agent Communication Gateway

The agent communication gateway proposed in this paper was designed especially to assist the agent-agent communication at inter-platform level, since in general it is more difficult to establish and maintain the communication link between both parties. This opens up the possibility to make collaborations between agents from different MASs in a simple way, whenever FIPA-ACL is used in the message exchange.



This agent communication gateway was developed based on the JADE framework. The popularity of JADE among the community of agent developers as well as its wide use in the development of MASs for the intelligent control of scenarios have been some of the motivations that have led us to use JADE as a baseline for the development of our proposal. In order to abstract the programming complexity of blocks concerning the JADE communication patterns a specialized API for Java has been developed. This API implements a gateway based on RESTful services. RESTful web services provide autonomous, lightweight, and scalable software entities to manage contents (functionalities and data) in terms of resources. These resources enclosed in a web server can be exposed by web services through a standard common interface, the Uniform Resource Identifiers (URIs) supported by four web methods such as POST, GET, PUT and DELETE. From these methods it is possible to create, retrieve, update and delete resources, respectively [29].

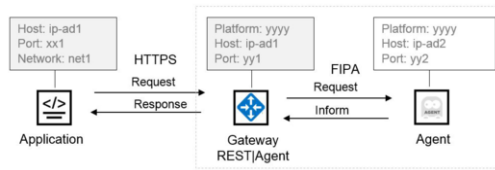

(a) Application-Agent communication

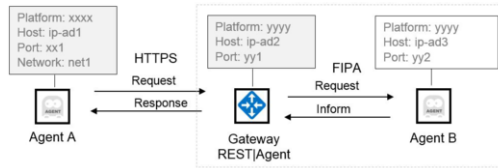

(b) Agent-Agent (inter-platform) communication (vers. 1)

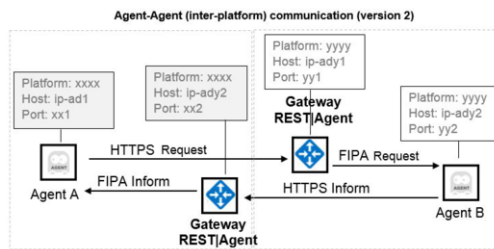

(c) Agent-Agent (inter-platform) communication (vers. 2)

**Figure 2.** Basic communication patterns of the proposed gateway.

Three different usages of the gateway can be shown schematically in Figure 2. The three communication patterns are: (i) application-agent communication in Figure 2a, (ii) agent-agent (inter-platform) communication (version 1) in Figure 2b and (iii) agent-agent (inter-platform) communication (version 2) in Figure 2c.

### 3.1. Application-Agent Communication

In this case, the agent communication gateway is managed by an external application such as a web service, a web component or an executable program, as shown in Figure 2a. This pattern is usually common when an external application requires the execution of specialized actions of intelligent agents who autonomously search for the resources to execute the desired action (e.g., a travel agency website that searches for the most appropriate means of transport to the client's request).

In a general view, the communication gateway acts by separating the FIPA communications that are established between the gateway and the agent to be accessed, with respect to the external communications that are carried out through the gateway.

### 3.2. Agent-Agent (Inter-Platform) Communication

Two versions of the agent-agent communication paradigm at inter-platform level were identified. The lighter version of the agent-agent communication paradigm shown in Figure 2b establishes a communication link between the sender agent and the receiver agent behind the gateway. Since the gateway and the receiver agent are operating on the same platform in the same network domain, the FIPA message exchange between the gateway and receiver agent is simplified; only the agent name is needed.

On the other hand, the sender agent, probably running on a host in a different network domain, is forced to use an HTTP request-response protocol in order to have access to the REST interface of the RESTful service implemented in the gateway. This web service has defined a specific resource associated to the invocation of the FIPA message interchange to the receiver agent. When the resource of the service in the gateway is consumed by a HTTP request, the FIPA message interchange is started.

This communication paradigm is especially interesting when the sender agent is an autonomous, distributed and isolated agent or an agent that belongs to a MAS. In both cases the agent requires to have access to the services offered by one or several agents that form part of a MAS. In this way it is possible to interoperate between different agent platforms as long as FIPA-ACL is maintained in the message exchange between agents.

In contrast, the heavier version of the agent-agent communication paradigm shown in Figure 2c provides a more elaborate communication among inter-platform agents. The HTTP request-response message on the RESTful service of the gateway is decoupled into two POST requests, each one to the RESTful service of the counterpart gateway. Each HTTP request to counterpart gateway encloses the ACL message only in one-way direction as occurs in general in FIPA messages. This allows a set of benefits to agent-agent communications: (i) the FIPA message exchanges can be asynchronous; (ii) more complex FIPA messages can be exchanged among JADE agents using different performatives, not only REQUEST and INFORM; (iii) FIPA messages can be shared among more parties, not only between two ones. This can be especially interesting in order to make many-to-many collaborations among agents at both domains as if they were living in a single MAS.

### 3.3. Implementation of the Agent Communication Gateway

The agent communication gateway has been defined under the Agent-as-a-Service model. Therefore the gateway from an external point of view can be seen as a RESTful

service with a REST API containing a resource or several ones with an URI that corresponds to the agent or agents accessible by the gateway. When a resource is consumed through a POST request that encloses the FIPA message as a JSON object in the body of this HTTP request, the RESTful service will start the agent management component implicit in the gateway and send a FIPA REQUEST to the agent specified in that agent platform.

The architecture of the agent communication gateway is composed of two parts: i) RESTful service management components and ii) agent management components that will exchange the message with the receiving agent, as shown in Figure 3. The design of the gateway allows decoupling both sides. The representation of the agents shared with the proposed gateway based on resources with an URI simplifies its implementation and handling.

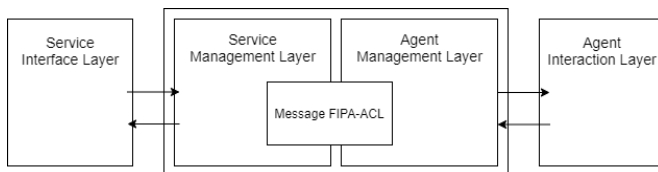

Figure 3. Architecture of the agent communication gateway.

In the implementation of the agent-agent communication paradigm of Figure 2b the agent management component must obtain the response through a FIPA INFORM request from the receiving agent, and this is encapsulated in the body of the HTTP response. On the other hand, in the implementation of agent-agent communication paradigm of Figure 2c, the requests only occur in one direction, without a response. Then, the implementation of the gateway is slightly different from the above case.

#### 4. Results

In order to demonstrate the operation of the communication patterns proposed in this study, two of these patterns, the Application-Agent (Figure 2a) and the Agent-Agent pattern (Figure 2b), are detailed.

The Application-Agent communication pattern was applied to communicate a web application developed with Java Server Pages (JSP) into an agent developed in JADE. In order to reproduce the communication pattern a web-server was installed into a PC where JSP pages were hosted and the gateway was implemented in JAVA as a RESTfull web-service with JAX-RS 2.0 as is shown in 4. Inside the logic of the web-service a gateway agent is built to send a FIPA message to the agent that is running into a Raspberry Pi embedded device.

On the other hand, the Agent-Agent pattern (Figure 2b) was developed and tested with a specific example. In this case, three entities were implemented. A receiver JADE agent with a cyclic behavior that is waiting to read a FIPA message received from gateway. Next, the gateway is implemented as a RESTful web-service using JAX-RS 2.0 library using Java programming language. Inside the logic of RESTful web-service a gateway agent is built which includes the conversion of the ACL message from JSON to an ACL object in JADE. Finally, a sender agent is developed in JADE that has associ-

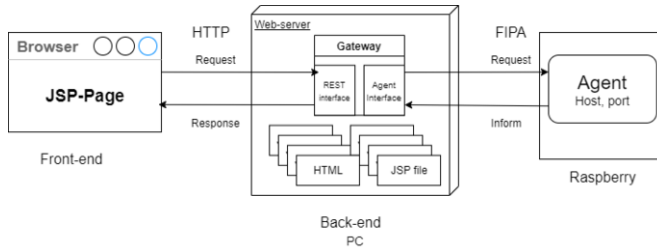

**Figure 4.** Deployment of the Application-Agent communication paradigm.

ated a simple behavior which contains the invocation of HTTP request in order to get a response from the receiver agent.

## 5. Conclusions

Resource Oriented Architecture (ROA) technologies have now reached a maturity level to develop distributed systems compatible with desktop, web, mobile, and pervasive computing scenarios such as IoT. However, services are passive entities and are not able to search for the suitable resources to achieve their goals as a software agent would. Developing a communication interface such as the one proposed in this paper not only facilitates communication with agents distributed in MASs but also enables other entities to communicate with them. Web applications and users are some of the entities that can communicate with agents only by composing a URI that incorporates simple arguments to remember.

The communication with JADE agents using URIs abstracted the complexity of agent communications and facilitated the modeling of heterogeneous processes based on the composition of services and agents. This makes it possible to take advantage of intelligence distributed through agents from emerging applications such as: web and IoT. Therefore, the gateway contributes a tool to work with smart agents interactions from heterogeneous MASs as if they were living in a single MAS.

## References

- [1] Stone P, Veloso M. Multiagent systems: A survey from a machine learning perspective. *Autonomous Robots*. 2000;8(3):345–383.
- [2] Russell S, Norvig P. *Artificial intelligence: A modern approach*. Prentice Hall Series in Artificial Intelligence. 2003;1.
- [3] Balke T, Gilbert N. How do agents make decisions? A survey. *Journal of Artificial Societies and Social Simulation*. 2014;17(4):13.
- [4] Thangarajah J, Padgham L, Harland J. Representation and reasoning for goals in BDI agents. *Australian Computer Science Communications*. 2002;24(1):259–265.
- [5] Poslad S, Charlton P. Standardizing agent interoperability: The FIPA approach. In: *ECCAI Advanced Course on Artificial Intelligence*. Springer; 2001. p. 98–117.
- [6] Kravari K, Bassiliades N. A survey of agent platforms. *Journal of Artificial Societies and Social Simulation*. 2015;18(1):11.
- [7] Bellifemine F, Poggi A, Rimassa G. Developing multi-agent systems with a FIPA-compliant agent framework. *Software: Practice and Experience*. 2001;31(2):103–128.

- [8] Bădică C, Bassiliades N, Ilie S, Kravari K. Agent reasoning on the web using web services. *Computer Science and Information Systems*. 2014;11(2):697–721.
- [9] Corchado JM, Corchado ES, Pellicer MA. Design of cooperative agents for mobile devices. In: *International Conference on Cooperative Design, Visualization and Engineering*. Springer; 2004. p. 205–212.
- [10] Singh D, Tripathi G, Jara AJ. A survey of Internet-of-Things: Future vision, architecture, challenges and services. In: *2014 IEEE world forum on Internet of Things (WF-IoT)*. Seoul, South Korea: IEEE; 2014. p. 287–292.
- [11] Pico-Valencia P, Requejo-Micolta B, Holgado-Terriza JA. *Multiagent System for Controlling a Digital Home Connected Based on Internet of Things*; 2020.
- [12] Li S, Da Xu L, Zhao S. The internet of things: a survey. *Information Systems Frontiers*. 2015;17(2):243–259.
- [13] Braubach L, Alexander P. Conceptual Integration of Agents with WSDL and RESTful Web Services. In: Dastani M, LBe Hübner J F, editor. *Programming Multi-Agent Systems. ProMAS 2012*. vol. 7837 of *Lecture Notes in Computer Science*. Springer; 2013. p. 17–34.
- [14] Pico-Valencia P, Holgado-Terriza JA. Integration of MultiAgent Systems with Resource-Oriented Architecture for Management of IoT-Objects. In: *Intelligent Environments 2018*. vol. 5 of *Ambient Intelligence and Smart Environments*. IOS Press; 2018. p. 567–576.
- [15] Bordini RH, Braubach L, Dastani M, El Fallah Seghrouchni A, Gomez-Sanz JJ, Leite J, et al. A Survey of Programming Languages and Platforms for Multi-Agent Systems. *Informatica*. 2015;30(10):33–44.
- [16] Bădică C, Budimac Z, Burkhard HD, Ivanović M. Software agents: Languages, tools, platforms. *Computer Science and Information Systems*. 2011;8(2):255–298.
- [17] Dastani M. In: Shehory O, Sturm A, editors. *A Survey of Multi-agent Programming Languages and Frameworks*. Springer Berlin Heidelberg; 2014. p. 213–233.
- [18] Vrba P. JAVA-Based Agent Platform Evaluation. In: Mařík V, McFarlane D, Valckenaers P, editors. *Holonic and Multi-Agent Systems for Manufacturing*. Springer Berlin Heidelberg; 2003. p. 47–58.
- [19] Leszczyna R. *Evaluation of agent platforms*. European Commission, Joint Research Centre, Institute for the Protection and Security of the Citizen; 2004.
- [20] Trillo R, Ilarri S, Mena E. Comparison and Performance Evaluation of Mobile Agent Platforms. In: *Third International Conference on Autonomic and Autonomous Systems (ICAS'07)*; 2007. p. 41–41.
- [21] Shakshuki E, Jun Y. Multi-agent Development Toolkits: An Evaluation. In: Orchard B, Yang C, Ali M, editors. *Innovations in Applied Artificial Intelligence*. Berlin, Heidelberg: Springer Berlin Heidelberg; 2004. p. 209–218.
- [22] Soon GK, On CK, Anthony P, Hamdan AR. A review on agent communication language. In: *Computational Science and Technology*. Springer; 2019. p. 481–491.
- [23] Chaib-draa B, Dignum F. Trends in agent communication language. *Computational Intelligence*. 2002;18(2):89–101.
- [24] Pico-Valencia P, Holgado-Terriza JA, Herrera D, José S. Towards the internet of agents: an analysis of the internet of things from the intelligence and autonomy perspective. *Ingeniería e Investigación*. 2018;38:121–129.
- [25] Bellifemine F, Caire G, Poggi A, Rimassa G. JADE: A software framework for developing multi-agent applications. *Lessons learned*. *Information and Software Technology*. 2008;50(1):10–21.
- [26] Lucchi R, Millot M, Elfers C. Resource oriented architecture and REST. *Assessment of impact and advantages on INSPIRE*, Ispra: European Communities. 2008;.
- [27] Juneja D, Jagga A, Singh A. A review of FIPA standardized agent communication language and interaction protocols. *Journal of Network Communications and Emerging Technologies*. 2015;5(2):179–191.
- [28] Moran S, Luger E, Rodden T. Exploring patterns as a framework for embedding consent mechanisms in human-agent collectives. In: *International Conference on Active Media Technology*. Springer; 2014. p. 475–486.
- [29] Saad MK, Abed R, Hamad HM. Performance evaluation of restful web services for mobile devices. *International Arab Journal of e-Technology*. 2010;1(3):72–78.

This page intentionally left blank

4th International Workshop on Legal Issues  
in Intelligent Environments (LIIE'20)

This page intentionally left blank



# Internet Protocol Standards for IoT Interoperability in the House. Open Issues in EU Competition Law

Francesca Gennari, PhD Candidate<sup>a,1</sup>

<sup>a</sup> *Mykolas Romeris University • University of Turin • University of Bologna*

**Abstract.** IoT for the house raises several concerns under the EU Competition and IP law. In order to create a better level of interoperability between the different smart home IoT objects, undertakings are willing to create new standards, in particular concerning the Internet Protocol. However, this problem seems to be over. In December 2019, Google, Amazon, Apple, Ikea, the ZigBee alliance and many other undertakings belonging to the electronics and innovation world joined together to form the project “connected home over IP” whose main goal is to create “...a new, royalty free, connectivity standard”. This paper aims at giving a first analysis of this project under a competition law and IP law perspective. The main focus will be both on the interplay between Art.101(1),(3) TFEU and on Standard Essential Patents (SEPS) applied to this project. It will be argued that if this project is considered a collusive agreement, it could become a new case in the SEP litigation framework.

**Keywords.** IoT, interoperability, competition, IP

## 1. Introduction

The origin of the Internet of Things (IoT) and of some of its most lucrative applications [1] are connected to the house environment. The purpose of this paper is to outline the importance and main characteristics home IoT objects have, with a special focus on recent policies of the European Union (EU) designed to create a legal environment in which this technology can thrive (§1.1). Apart from the advantages, it is also important to know the main challenges that home IoT objects present not only from a technical but also from a legal point of view. The main challenge to optimize the capacity of the IoT is to allow the different smart appliances of the house to “communicate” not just with the inhabitant of the house but also with other appliances and smart objects. As a consequence, data-portability is a transversal EU IT law principle, established by Art. 20 of the General Data Protection Regulation [2]. Its technical equivalent, interoperability [3], is a target that IoT producers try to achieve as well. To draft a new standard for an internet protocol (IP) for the house is the core of the “*Connected over IP project*” (hereinafter Project IP) (§1.2) [4]. In the second section there will be a first analysis of this project in terms of the EU Competition and IP law on the basis of the information that has been made public so far by the undertakings of this project. This is a first

---

<sup>1</sup> Francesca Gennari, PhD candidate, LAST-JD-RIoE, <https://last-jd-rioe.eu/francesca-gennari.html>; E-mail: francesca.gennari8@unibo.it.

assessment and does not claim that Project IP is collusive, as there is not enough data available to, for instance, calculate the influence on the market of some of its partners. However, there are some doubts that arise, especially as far as the correlation between costs to sustain this project and the gratuity of this Project IP fee. The analysis of Competition and IP aspects, though deeply intertwined, will be developed into two separate parts (§2.1, §2.2). It will be argued that, if hypothetically judged anticompetitive by the European Commission, Project IP will set a new scenario not only in competition law, but also in the debate on Standard Essential Patents (SEPs). Its novelty will consist in the influence exercised by a plurality of undertakings in the home IoT connectivity standard market and in the home IoT production one.

### *1.1. IoT for the house: what it is and why it is important*

There is not a unanimous consensus in defining the Internet of Things (IoT) despite this term being twenty-one years old [1]. In any case, there are some elements on which the academic community agrees on and these are the presence of “[...]material hardware, electronic signals, and electromagnetic emissions that generates, stores, transmits and analyses data” [5] and where “ambient sensing occurs by remotely controllable and constantly connected physical objects” [6].

As far as methodology, the legal analysis of this contribution will focus on the IoT devices that people buy and use in their homes, for the following reasons.

Firstly, because of the relevance of IoT objects in terms of EU policy. IoT is part of the new EU Commission's plan for the next five years in different documents. At the end of 2019, the European Green Deal set the framework in which environmental sustainability has to be considered the long-term objective even for the development of new technologies [7]. The importance of IoT technology and the infrastructure that is required to be competitive was stressed through the release of the 5g Toolkit [8] and the first report of the NIS group of EU Member States [9]. To have a sustainable and secure infrastructure for IoT is also part of the long-term objectives of the New Industrial Strategy for Europe [10]. Besides, the enactment of the Electronic Communications Code [11] together with the Cyber Security Act [12] and the upcoming Data Act [10] will lay out the core infrastructure rules for IoT in the EU.

Secondly, because the first IoT objects were indeed conceived for the house [1]. As a matter of fact, IoT objects for the house are becoming increasingly accessible for the average consumer and will probably play an important role in influencing consumers' habits [13] as they interact with the consumer/data subject by collecting, analysing and producing data [14] [15]. Compared with traditional home objects, IoT home objects have one characteristic that makes them truly special: they all contain embedded electronic material and software, some in a very rudimental form, others in a more advanced one.

### *1.2. Inter-operability: an underpinning principle in the home IoT and the new Connected home over IP project*

In the next few years, the house will be increasingly more connected. IoT objects will not just be more performant and energy efficient on their own [16], but they will become also more connected between themselves, thus enabling the inhabitant to transform each smart object to a node in a network that can be easily controlled by the inhabitant [16]. However, in order to do this, it is indispensable that the different smart appliances can

communicate with each other. This dependence of the components of a future connected house on each other will be a main feature of the future smart house.

As a consequence, interoperability comes into play. Interoperability can be considered an overarching principle of EU IT law and the equivalent of the principle of data portability in the of EU Data Protection law [3]. Interoperability is functional also to the realisation of new technology and, in this specific case, to the construction of IoT objects that can be compliant with the principles of privacy by default and by design as requested by Art.25 GDPR [2] [17].

Nevertheless, interoperability is not just an abstract legal principle. Interoperability is also the technical capacity of different kinds of technologies to “speak” a common language, to execute tasks and to perform functions.

As far as the home IoT are concerned, one of the features that makes home interoperability possible lies in the Internet Protocol used by the different IoT objects in the house. The Internet Protocol is “*the principal set or (communications protocol) of digital message formats and rules for exchanging messages between computers across a single network or a series of interconnected networks... Messages are exchanged as datagrams, also known as data packets or just packets.*” [18]. Its function is “*to deliver datagrams from the source computer to the destination host (receiving computer based on their addresses. To achieve this, IP includes methods and structures for putting tags (address information which is part of metadata) within datagrams.*” [18].

Therefore, it is interesting to analyse the so-called, “*project connected home over IP*” [4]. In December 2019, Google, Amazon, Apple, Ikea, the ZigBee alliance, and many other subjects (belonging to electronics and innovation world) joined together to create “[...]a new, royalty free, connectivity standard” [4]. If the project must be translated in legal terms, it will be clear that some undertakings decided to agree on creating an essential interoperable connectivity standard to make home IoT better. This standard is going to be royalty free and the code will be open source [4]. How can this new project affect the market of home IoT in terms of competition and IP law? On the basis of the information publicly available we will draw a first analysis concerning these two fields of law.

## **2. Project IP over connected home. The entanglement of EU Competition and IP law**

### *2.1. The possible interplay between Art. 101 (1) and (3) TFEU*

This first attempt at giving a competitive assessment of the IP project will start from the basis of EU competition law Art.101 TFEU. Then it will follow a systematic interpretation involving other documents issued by the European Commission following the principle *lex specialis derogat generali*. The objective is to forecast, with the few data available, which kind of reasoning the Commission might follow to evaluate the competitiveness of Project IP.

One preliminary remark is that EU competition law adopts a pragmatic approach which is effects-based. In an analogue way to the American rule of reason, European antitrust uses the principle of proportionality [19] even in competition law to assess the anti-competitiveness of a behavior. In practice, this is done through the interplay of the first and third paragraphs of Art.101 TFEU if more than one undertaking is involved. Firstly, the behavior must be judged anticompetitive and, secondly, there is the

evaluation of reasons that might balance out the anti-competitive character of the behavior. This is called the two steps test [20]. To consider a behavior anticompetitive for two or more undertakings, the Court of Justice of the European Union (CJEU) has held that it is not even necessary to have a formal agreement between undertakings [20] [21]. Sometimes, just the exchange of information within the same network [21], or even the implicit coordinated behavior of two or more undertakings [20] can lead to collusion.

If we read the text of Art. 101 TFEU [22], the first paragraph describes the restrictions per object that are considered unlawful and hardcore competition restrictions in EU law [20][23]. These are not the only restrictions possible. Art 101(1) TFEU also establishes that restrictions can also be considered as such by their effects, making the previous list, *de facto*, an open list. The second paragraph establishes the consequence of nullity for these agreements. Finally, the third paragraph sets out four conditions according to which anticompetitive agreements can be considered compatible with the rules of the Single Market. The conditions are the following: the improvement of the production of a certain good or of technological development; the distribution of the results in a fair share to consumers; the indispensability of the restriction and the non-elimination of competition [22]. In conclusion, even anti-competitive agreements can be lawful if, though distorting competition, either they do that not in a significant way or they promote other interests that are considered beneficial to the market [20]. Other documents to consider are, (in chronological order): the guidelines on the application of (former) Art.81(3) (now Art. 101(3)) TFEU [24], the R&D agreements block exemption regulation [25]. Some might argue that the Regulation of the Commission on vertical restraints and the application of Art.101(3) TFEU to vertical restraints [26] is the relevant set of rules to apply given the diversity of the subjects that can join this project on the supply chain. As a matter of fact, in the 2010 Commission Regulation on vertical restraints (the so called Block Exemption Regulation), the definition of vertical restraint itself encompasses just “[...]an agreement or concerted practice entered into between two or more undertakings each of which operates, for the purposes of the agreement or the concerted practice, at a different level of the production or distribution chain, **and relating to the conditions under which the parties may purchase, sell or resell certain goods or services.**”<sup>2</sup> This cannot be the case here. In fact, only a few things are clear from the description of Project IP but one is certain: the objective is the creation of a standard that is royalty free and it is not even specified if that applies only to the members of the agreement or also to third parties [4]. This makes inapplicable the guidelines on knowledge transfer agreements as they also involve the grant of a license against the payment of a price<sup>3</sup>. Moreover, in the corresponding Regulation, the only definition for transfer of technology agreement applicable to the IP project would be just the one concerning a *reciprocal agreement*, but it involves just two undertakings whereas here several are involved<sup>4</sup>.

It is not claimed that Project IP is *prima facie* anti-competitive. On the contrary, many positive effects might be caused by that, for instance the passage from the Internet of Silos phase [29] to the Internet of Everything. However, the market influence and pervasiveness that Google, Amazon and Apple (which are part of the project) have in the relevant market of IoT for the home, makes it possible to think whether it is really pro-competitive that the three most important players work together. If we agree with

---

<sup>2</sup> Art. 1.1.a), emphasis added [26].

<sup>3</sup> Para 51 [27].

<sup>4</sup> Art. 1(d)[28].

Professor Petit's theory of Mologopolies<sup>5</sup>, we might see that in the near future this market could be influenced thoroughly by a group of enterprises that are part of this project. Even if the IoT connectivity market is judged still very competitive and dynamic [31], the IP project has the objective to create an interoperable connectivity protocol. This is in substance a connectivity standard and it might be worthwhile to consider the smaller market of the IoT connectivity standards for the house, as it is the core of the mission of the IP project (e.g. connected home). There are few doubts that this standard will play a decisive role in the future in this market and exercise a decisive influence on the home IoT market.

Analyzing this project, which is an agreement in EU competition terms, it is evident that creating a standard for an interconnectivity protocol involves the research and development resources of most if not all the undertakings involved. The R&D Block Exemption Regulation<sup>6</sup> could be easily used by the undertakings involved to benefit from an exemption from the application of Art.101(1)[25]. The Project IP agreement seems to fill the condition set out in the Art. 1(1)(a)(i) which is the "*i joint research and development of contract products or contract technologies and joint exploitation of the results of that research and development*" [25]. It seems an educated guess that, in order for the exemption to apply (Art.2), also the condition of the agreement between the party will have to follow the rules of Art.3 which are "*full access to final result (2), pre-existing know-how (3), joint exploitation connected to IP rights that constitute know-how and are indispensable for the production of the product or the contract technology (4) and the obligation for parties in charge of the manufacture process to fill order for supplies except a joint distribution agreement is in place*" [25]. However, the undertakings involved compete against each other normally on different and on the same markets and it seems that Art.4(2)(i) will be applicable. According to this article, the application of the exemption applies only if "*[...] the case of research and development agreements referred to in point (a)(i), (ii) or (iii) of Article 1(1), the combined market share of the parties to a research and development agreement does not exceed 25 % on the relevant product and technology markets*" [25]. It seems likely that the combined share of all the parties could be higher than 25%. Therefore, it is probable that the R&D block exemption will not apply. However, given the lack of details, for now it is necessary to go back to the general rule, Art.101 TFEU, and check whether the justifications of its third paragraph could be applicable in the case this project is assessed as collusive. In the light of the interpretation offered by European Commission Guidelines on the application of former Art.81(3) TFEU [24] and by the CJEU, all the justifications set out by Art.101(3) are important and therefore cumulative (para 42.)[24]. In practice, the Commission also uses the idea of *workable competition*, indicated by the CJEU [32] as the *criterion* as whether to apply or not Art.101(3) TFEU. There have been a few exceptions to this trend so far<sup>7</sup>, but there is still no case-law on the application of

---

<sup>5</sup> Mologopoly means that a corporation that is dominant on one digital market tries to expand and collaborate with dominant or influent firms from other markets to guarantee the pervasiveness of its action [30].

<sup>6</sup> It must be remembered however that the R&D exemption from the application of Art.101 TFEU is not granted for an unlimited amount of time. It is either seven years or for the duration of the agreement following the conditions detailed at Art. 7(1)(2)[25].

<sup>7</sup> Some of these exceptions concerned selected distribution of luxury goods or professional orders fixing prices for compensation (which are object restrictions), were considered as justified by the CJEU. Among these cases, important are *Remia*, *Pronuptia*

Art.101(3) TFEU for the house IoT. It is still abstract to assess whether the efficiency gain concerning the technological development [22] can outweigh the other three causes of justification. Certainly, this agreement promotes technological development and the “fame” of the participants to this agreement might have a pass on effect on consumers (fair share), but how to calculate the inevitability of this agreement as a possible cause of distortion of competition in the home IoT connectivity market and in the home IoT products in the long run? It is likely that the standard created by Project IP will be the most widely-used one. Even if *prima facie* the positive effects of this project as presented by its promoters outweigh the negative ones, it must be kept in mind that the IoT connectivity market, despite being very competitive at the moment, might change swiftly and become very concentrated as far as IoT connectivity for the house is concerned. The network effects are one of the characteristics of digital markets that can have repercussions on connected markets as well [34]. In order to substantiate better these concerns, it is necessary to explain how IP rights are involved in this competitive assessment.

## 2.2. SEPs and collusive agreements. Is this the new phase in the SEPs saga?

The competition assessment of this project for interoperability standards is entwined with the analysis of IP rights. After a short explanation of what SEPs are, there will be a comparison of Project IP with the case-law of the CJEU and it will be argued that, if the agreement is ultimately found anticompetitive, Project IP could be the next step in the finding of a new part of the SEPs and FRAND litigation issues. It will not be as expanded as the part on competition as even less information is publicly available.

Building an IoT home object is not simple. Both its simpler material parts and the electronic material might need the application and use of standards possibly involving patents [35]. For instance, an innovator might need one of these patents as they are essential to the functioning of a new home IoT object. This allows an innovator to save the costs of R&D and of a patent procedure. For this reason, they are called standard essential patents (SEPs) [35]. A standard is created either through a process involving the patentee and a Standard Setting Organisation (SSO or Standard Developing Organisation, SDO) or it could be a *de facto* standard [35]. Even if not expressly mentioned, at least part of the protocol standard of Project IP, as in general all connectivity standards, might be subject to a process of patentability, most probably as a Computer Implementing Invention (CII) [29] or involving other intellectual property rights such as designs, know-how and software. Let us go back to the previous example of an innovator who wants to build a new IoT object and needs to use a standard, which is comprehensive of a patent which belongs to another patentee. To avoid infringing someone else’s patent, the innovator has to ask the patentee permission to use the standard and is generally subject to the payment of a fee [36] whose value is quite complex to calculate in advance, before the patent is effective [37] [38]. International stakeholders and international organisations (included the OECD and the EU) promoted FRAND conditions on which a fair fee/royalty must be paid<sup>8</sup>. It follows that only

---

and *Wouters* [20]. More recently, agreements that were *prima facie* collusive have been justified by the Commission because of an effective demonstration of the out of market efficiencies, such as in the airlines market [33].

<sup>8</sup> FRAND is an acronym for Fair, Reasonable, And Non-Discriminatory.

undertakings with *a*) a series of useful patents and *b*) consistent economic resources can actively play a role in the IoT market, included the home one.

It is clear that SEPs on the one hand boost innovation, but, on the other hand, they often put the patentee in a position of power on the market, as his/her patent is indispensable to the creation of derived products [3][31]. That can be the origin of an abuse of dominance behaviour under Art.102 TFEU[22]. After a few EU and national cases dealing with patents and SEPs (such as *Volvo, Orange-Book-Standard* [39]) the CJEU gave important directives on how to assess the patentee and implementer's behaviour when SEPs and FRAND conditions are involved in the *Huawei* case [40]. This last case deals directly on how to demonstrate a connection between a SEP and the abuse of dominance of Art.102 TFEU[3][31]. In the *Huawei* case, the Court followed the opinion of Advocate General (AG) Wathelet. The AG suggested that there is not a direct correlation between owning a SEP and being dominant on a market<sup>9</sup>. At the same time, it gave some procedural rules on how the patentee and the implementer should behave in case the patentee had previously agreed to license its product according to FRAND terms<sup>10</sup>. As far as the meaning on FRAND, national courts, especially in Germany and in the UK, have been going further in determining substantially what a FRAND fee must contain [35].

As far as it can be understood from the site of the project, it seems that the standard would be a *de facto* one as no mention about any SSOs is done. This would mean saving time and resources from a long process in which a third institution is involved. However, this might contrast with the content of guidelines on how to proceed in dealing with SEPs published by the European Commission [3][41]. In this document we can find some recommendations to follow including transparency (which might not always be a good thing in Antitrust terms, especially in concentrated-oligopolist markets [3]). To achieve this goal, the Commission advised to preferably use FRAND terms for licensing and to guarantee an open source code. One of the actions that the Commission wanted to take is to use existing certifying bodies (maybe national patent offices?[3][41]) to assist the patentee and the SSO in the procedure of standardisation and the drafting of FRAND terms. This is a good idea as the SSOs generally have a private character. Nevertheless, nothing has been done yet in this field. If we try to compare these requirements with what we know of the connected over IP project it must be noted that the Project IP announced that it will use Github to leave the code open source and that must be acknowledged. As far as the FRAND terms, logically there is nothing more Fair, Reasonable and Non Discriminatory than leaving a potentially very useful protocol royalty free for everyone. What is not clear from the project page is whether this gratuity is limited to the parties of the agreement or whether it extends to other undertakings that might ask to use this protocol. In the first case, there would be no collusion and no infringement issues, and this project could really qualify as a charity project. If that is not the case and the royalty free clause concerns just the participants, it ought to be specified which kind of conditions for licensing would apply. In any case, it would be much more comforting to have the involvement of at least one SSO and possibly the opinion of specialised bodies such as national patent offices. In any case, having the involvement of a third party such as a SSO would already be a reassuring sign that the elaboration of the Internet Protocol is supervised by a third party and would appear more pro-competitive to competition enforcement authorities such as the European Commission.

---

<sup>9</sup> See para. 57 of the Opinion [39].

<sup>10</sup> See para. 103 n.1-2-3-4-5-6-7 of the Opinion [39].

If this last requirement is not followed there could be grounds to start considering the agreement anticompetitive in its effects, following the reasoning scheme exposed in §2.1). Moreover, if that were the case, Project IP would definitely become a new paradigm in the SEP saga. It would be much simpler under the FRAND paradigm as the royalty would be 0 and, in this case, a series of businesses would exercise a collective form of pervasive influence if not dominance on *a)* the access to the market of home IoT connectivity standards and home IoT production; *b)* the choice of Internet Protocols for implementers; *c)* the consumers who would be drawn to the already most known brands.

## Conclusions

In conclusion, there are important questions that are not answered by what is made public about the IP project. It is not clear which kind of EU competition legislation to apply as the call is still open and other actors on the supply chain might adhere to different conditions. Either the Block Exemption Regulation on the transfer of knowledge or the R&D block exemption Regulation could be applicable. However, because of precise elements of their wording, it is safer to draft the analysis following the interplay between the first and third paragraph of Art.101 TFEU. A first assessment revealed *prima facie* a non-collusive agreement as a new interoperability protocol would play a major role in paving the way to the Internet of Everything. Furthermore, the market of connectivity standards for IoT is still considered dynamic and competitive. Nevertheless, perhaps it is useful not to consider the IoT connectivity standard market at large but to restrict the analysis to the smart home IoT connectivity market. The popularity of some of the participants of the project might be a cause of problems in terms of access to this market of competitors and it is not sure that the efficiency gains, consumer share and the necessity exceptions can outbalance the impossibility to have access to competition on this market. To make a complete and thorough analysis at this moment seems difficult, as the CJEU has no case-law on connectivity standards concerning IoT and the application of Art.101(3) TFEU. Furthermore, doubts arise from the absence of any mention about how the free royalty fee would be possible if not on planning to share an indirect collective influential position on the home IoT products market, given the essentiality of this standard (probably involving SEP) for the production of home IoT objects. Despite the open source code, the absence of an SSO from the process makes it quite clear that this would become a *de facto* standard that has a chance to become the most used and it might give more substance to the competition concerns expressed before. Moreover, if declared anticompetitive, this project could be a new episode in the SEP saga, where the SEP patentee is not just one but a series of subjects that exercise a collective form of influence originated by a collusive agreement as far as its effects in the long run.

## Acknowledgement

This project has received funding from the European Union's Horizon 2020 research and innovation programme under the Marie Skłodowska-Curie ITN EJD grant agreement No 814177.



## References

- [1] Lexinnova. Internet of Things: patent landscape analysis. Geneva: WIPO; 2014. P.1- 21
- [2] Regulation (EU) 2016/679 of the European Parliament and of the Council of 27 April 2016, on the protection of natural persons with regard to the processing of personal data and on the free movement of such data, and repealing Directive 95/46/EC (General Data Protection Regulation). OJ L 119, 4.5.2016, p. 1-88.
- [3] Podszun R. Standard Essential Patents and Antitrust Law in the Age of Standardisation and the Internet of Things: Shifting Paradigms. IIC International Review of Intellectual Property and Competition Law. 2019; 50(6):720-45.
- [4] Project Connected Home over IP, <https://www.connectedhomeip.com/> [25/03/2020]
- [5] Perry S, Roda C. Chapter 5: The Internet of things. In: Perry S, Roda C, 1<sup>st</sup>, editors. Human rights and digital technology: digital tightrope. London: Palgrave MacMillan; 2016. p.131-62.
- [6] Urquhart L, McAuley D, Avoiding the internet of insecure industrial things. Computer Law and Security Review. 2018; 34(3):450-66.
- [7] Communication from the Commission to the European Parliament, the European Council, the Council, the European Economic and Social Committee and the Committee of the Regions, The European Green Deal. COM/2019/640 final, p.1-24.
- [8] Communication from the Commission to the European Parliament, the Council, the European Economic and social Committee and the Committee of the Regions, Secure 5G deployment in the EU, Implementing the EU toolbox. COM/2020/50 final, p. 1-14.
- [9] NIS Cooperation Group. Cybersecurity of 5G networks and EU toolbox of risk mitigating measures. <https://ec.europa.eu/digital-single-market/en/news/cybersecurity-5g-networks-eu-toolbox-risk-mitigating-measures> [25/03/2020].
- [10] Communication from the Commission to the European Parliament, the Council, the European Economic and social Committee and the Committee of the Regions, A new Industrial Strategy for Europe. COM/2020/102 final, p.1-13.
- [11] Directive (EU) 2018/1972 of the European Parliament and the Council of 11 December 2018 establishing the European Electronic Communications Code (Recast). OJ L 321/36, p.36- 214.
- [12] Regulation (EU) 2019/881 of the European Parliament and of the Council of 17 April 2019 on ENISA (the European Union Agency for Cybersecurity) and on information and communications technology cybersecurity certification and repealing Regulation (EU) No 526/2013 (Cybersecurity Act), PE/86/2018/REV/1. OJ L 151, 7.6.2019, p. 15-69.
- [13] Gal M, Elikin-Koren N. Algorithmic Consumers. Harvard Journal of Law and Technology. 2017; 30(2): 309-52.
- [14] De Conca S. From the glass house to the hive: the private sphere in the era of intelligent home assistant robots. IFIP. 2018;126: 282-98.
- [15] Ali A, Awad A. Cyber and physical security vulnerability assessment for IoT based smart homes. Sensors, 2018; 18(3): 1-18.
- [16] Serrenho T, Bertoldi P. Smart home appliances: state of the art. Energy, communications, protocols, standards. Brussels: JRC technical reports. 2019. p. 2-36.
- [17] Chaudhuri A, Cavoukian A. The proactive and preventive privacy (3P) framework for IoT privacy by design. Edpacs. 2018; 57(1):1-16.
- [18] Technopedia. What does Internet Protocol (IP) mean? <https://www.techopedia.com/definition/5366/internet-protocol-ip> [25/03/2020].
- [19] Tridimas T. Fundamental rights, general principles of EU law and the Charter. In: Cambridge: Cambridge Yearbook of European Legal Studies. 2014; 16. p. 361-92.
- [20] Jones A, Sufirin B, EU competition law. Texts, cases and materials. Oxford: Oxford University Press; 2016(3).p.114-256.
- [21] Estevan de Quesada C. Collusive practices inside a business network: the case of information exchange. European Business Law Review, 2013; 24(6): 829-47.
- [22] Consolidated version of the Treaty on the Functioning of the European Union. OJ C 326, 26.10.2012, p. 47-390.
- [23] Toffoletto A, Stabilini A, De Giorgi et al. Part II. The application of the prohibitions-Italy. IEL Competition Law. 2019. p.123-234.
- [24] Communication from the Commission - Notice - Guidelines on the application of Article 81(3) of the Treaty, OJ C 101, 27.4.2004, p. 97-118.
- [25] Commission Regulation (EU) No 1217/2010 of 14 December 2010 on the application of Article 101(3) of the Treaty on the Functioning of the European Union to certain categories of research and development agreements. OJ L 335, 18.12.2010, p. 36-42.

- [26] Commission Regulation (EU) No 330/2010 on the application of Article 101(3) of the Treaty on the Functioning of the European Union to categories of vertical agreements and concerted practices. OJ 23.4.2010, p.1-7.
- [27] Communication from the Commission - Guidelines on the Application of Article 101 of the Treaty on the Functioning of the European Union to technology transfer agreements, OJ C 89,28.3.2015, p.3-50.
- [28] Commission Regulation (EU) No 316/2014 of 21 March 2014 on the application of the Treaty on the Functioning of the European Union to categories of technology transfer agreements. OJ L 93,28.3.2014, p.17-23.
- [29] Noto La Diega G. Internet of Things and Patents Towards the IoT Patent Wars? *Journal of Commercial and Intellectual Property Law*. 2017; 3(2):47-66.
- [30] Petit N. Technology Giants, the Moligopoly Hypothesis and Holistic Competition: A Primer (October 20, 2016). SSRN: <https://ssrn.com/abstract=2856502> or <http://dx.doi.org/10.2139/ssrn.2856502> [25/03/2020].
- [31] Conde Gallego B, Drexl J. IoT Connectivity Standards: How Adaptive is the Current SEP Regulatory Framework? *IIC International Review of Intellectual Property and Competition Law*. 2019; 50(1):135-56.
- [32] Brook O. Struggling with Article 101(3) TFEU: Diverging approaches of the Commission, EU Courts, and five competition authorities. *CMLR*. 2019; 59(1):121-56.
- [33] Mohan M. Ray of Hope for Airline Alliances: Consideration of Out of Market Efficiencies by the European Commission. *Air and Space Law*. 2014; 39(2):155-62.
- [34] Crémer J, De Montjoye Y-A, Schweitzer H. Competition policy for the digital era, Brussels: European Commission; 2019. 2p.
- [35] Kurgonaitė E, Treacy P, Bond E. Looking Back to the Future- Selective SEP Licensing Through a Competition Law Lens? *Journal of European Competition Law and Practice*. 2020; DOI: 10.1093/jeclap/lpaa003,1-14.
- [36] Kasdan M. Chapter: Intellectual Property Licensing. In: Dreyfuss R, Pila J 1 editors. *The Oxford Handbook of Intellectual Property Law*. Oxford: Oxford University Press. 2018. p.653-63. DOI: 10.1093/oxfordhb/9780198758457.013.41
- [37] Neurhor B. Dynamically Efficient Royalties for Standard Essential Patents. *Journal of Competition Law & Economics*. 2020;0(0):1-17, DOI: 10.1093/joclec/nhaa010.
- [38] Pentheroudakis C, Baron J. Licensing Terms of Standard Essential Patents. A Comprehensive Analysis of Cases. Brussels: JRC. 2018. p. 84-110.
- [39] Opinion of Advocate General Wathelet, *Huawei Technologies Co. Ltd v ZTE Corp. and ZTE Deutschland GmbH*, C-170/13, ECLI:EU:C:2014:2391.
- [40] Judgment of the Court (Fifth Chamber) of 16 July 2015 *Huawei Technologies Co. Ltd v ZTE Corp. and ZTE Deutschland GmbH*, C-170/13, ECLI:EU:C:2015:477.
- [41] Communication from the Commission to the European Parliament, the Council and the European Social and Economic Committee, Setting out the EU approach to Standard Essential Patents. COM/2017/712 final, p. 1-14.

# The Unsecure Side of (Meta)Data in IoT Systems

Pier Giorgio CHIARA [0000-0002-9444-3480]<sup>a,1</sup>

<sup>a</sup>University of Luxembourg, University of Bologna, University of Turin

**Abstract:** The exponential spreading and deployment of emerging digital technologies such as the Internet of Things (IoT) has been remarkable: the IoT market is expected to triple, at least, from USD 170.57 billion in 2017 to USD 561.04 billion by 2022. IoT technologies collect, generate and communicate a huge amount of different data and metadata, through an increasing number of interconnected devices and sensors. Current EU legislation on data protection classifies data into personal and non-personal. The paper aims at charting the resulting entanglements from an interdisciplinary perspective. The legal analysis, integrated with a technical perspective, will address firstly the content of IoT communications, i.e. “data”, and the underlying distinction between personal and non-personal. Secondly, the focus will shift on the metadata related to communications. Through a technical analysis of the highly sensitive nature of metadata, even when the content is encrypted, I will argue that metadata are likely to undermine even more the ontological and sharp division between personal and non-personal data upon which the European legal frameworks for privacy and data protection have been built. The incoming ePrivacy Regulation shall provide metadata, which should be considered always personal data, the same level of protection of “content” data. This interpretation might broaden the scope of application of GDPR and the connected obligations and responsibilities of data controllers and data processors too much.

**KEYWORDS:** Data Protection, Privacy, Security, IoT, Non-Personal Data, Metadata

## I. Introduction: The Internet of things as a major source of threat for security, privacy and data protection.

The need of a theoretical premise is justified by the complex interrelationship between the concepts of privacy and data protection. Albeit they may often overlap, privacy and data protection are rights with different rationales [1–3], as outlined by the jurisprudence of the European Court of Justice (ECJ) and the European Court of Human Rights (ECHR). The classic formulation of the right to privacy follows a general principle of non-interference in one’s private sphere. Pagallo, recalling Hanna Arendt, conceives privacy, in the digital era, as a movable degree of “opaqueness” [4]. The level of opacity that an individual may expect to attain is defined by the rules of the legal system<sup>2</sup>: public

---

<sup>1</sup> Corresponding Author, Law, Science and Technology, Rights of Internet of Everything – Horizon 2020 Marie Skłodowska-Curie ITN EJD; E-mail: piergiorgio.chiara@uni.lu.

<sup>2</sup> Cfr. *ex multis* with Floridi [44]: “the “ontological friction” consists in the amount of work and efforts required for a certain kind of agent to obtain, filter and/or block information (also, but not only) about other agents in a given environment”.

interest criteria, defined by law, may ultimately interfere with the right to privacy. Data protection, on the other side, has been conceived as a more proactive right<sup>3</sup>, underpinned by the principles of transparency, lawfulness and fairness, according to which personal data are collected, processed and therefore used<sup>4</sup>.

For the purpose of this paper, it will be assumed that, in order to address privacy and data protection concerns raised by the IoT, privacy enablers embedded from the design stage of these devices are necessary in order to make these devices trustworthy, safe and reliable [5,6]. The need is thus to promote better privacy engineering practices. There is a large consensus in considering security<sup>5</sup> and data protection by design closely interlinked. Data protection norms seek to address the requirements regarding the protection of personal data, which are not only security-related; conversely, security settings refer to all types of products, systems and services [7]<sup>6</sup>.

IoT ecosystem is peculiarly designed and constrained when it comes to map cyber-security vulnerabilities and privacy and data protection threats. Firstly, the problem can be framed through an interconnected vertical and horizontal model: IoT has many possible applications (also called verticals) that range within a wide spectrum from eHealth and smart home scenarios to industrial and smart cities ecosystems. Horizontally, one can imagine the combinations of multiple technologies that enable IoT functionalities: radio-frequency identification (RFID), wireless sensor networks, cloud computing, etc.

Accordingly, security risks arise: each vertical has specific requirements, often different from the others and every part of the chain of all of those technologies needs to be secured, which is not a trivial task [8]. There is an urgent necessity of scalable decentralized defensive frameworks.

From a data protection standpoint, another crucial layer of complexity is represented by the huge amount of data generated or collected by the numerous sensors equipped on smart objects [9]. The scale of Big Data processing takes to a level where risks are unforeseen: “the scale is in terms of volume, variety, velocity and veracity, all the V’s of the big data definition, and their combination in analytics technologies” [10]. Users’ profiles can be easily inferred by the data collections of these data [11–13]. Moreover, these huge databases can be correlated thanks to multiple data mining techniques, resulting in “a continuous stream of profiles that can be tested and enhanced to better service those that ‘use’ them” [12]. Among these techniques, data aggregation is particularly relevant for the scope of this paper<sup>7</sup>. Thus, data from various IoT sources need to be grouped together from similar or diverse sources for further processes based on a well-defined data model (e.g., physical locations, device types, etc.)<sup>8</sup>. As stressed by the report of Article 29 Data Protection Working Group, “once the data is remotely

---

<sup>3</sup> Conclusion of the General Advocate Sharpston, Opinion delivered on 17.06.2010 about the joined cases C-92/09 and C-93/09.

<sup>4</sup> See Article 8(2) of the EU Charter of fundamental rights.

<sup>5</sup> The broad notion of security may be misleading since a proper distinction needs to be done between information security and cyber-security. The former underpins the protection of data and information, while the latter generally refers to the ability to protect or defend the use of cyber-space from cyber-attacks, encompassing therefore a broad range of risks governance.

<sup>6</sup> Enisa has developed a methodology which assists the development of applications in a secure manner, in order to decrease the number and severity of IoT vulnerabilities [45].

<sup>7</sup> Cfr. with Rajagopalan and Varshney [46] for a specific case-study on wireless sensor networks.

<sup>8</sup> Many authors have begun to reason in terms of “group privacy” and “collective data protection”, since this kind of data collection and processing treat groups rather than individuals; cfr. with [47,48].

stored, it may be shared with other parties, sometimes without the individual concerned being aware of it. In these cases, the further transmission of his/her data is thus imposed on the user who cannot prevent it without disabling most of the functionalities of the device. As a result of this chain of actions, the IoT can put device manufacturers and their commercial partners in a position to build or have access to very detailed user profile” [14]. Leaving aside further reflections on consent which fall outside the scope of the present investigation, the focus lies in the risks underpinned by users’ profiling [15]. Profiling is not illegal *per se*: recital 48 of the GDPR thus states that data subjects should be informed about the existence of profiling (that is, the construction of profiles), and the consequences of such profiling (that is, the consequences of applying such profiles). On a preliminary basis, it becomes vital to ascertain the nature of data that are going to be used to create users’ profiles. A crucial step of a cautious risk-analysis in IoT sector should outline whether the data processed are personal or non-personal, in order to identify the applicable regulatory framework.

Finally, from a privacy preserving perspective, IoT systems pose severe concerns when it comes to address the confidentiality of communications<sup>9</sup>. It has been acknowledged by the proposal for the adoption of the so-called ePrivacy Regulation, by pointing out at recital 15 that the full protection of the rights to privacy and confidentiality of communications should apply to the transmission of machine-to-machine communications, in order to promote a trusted and secure Internet of Things.

## II. The interrelation between non-personal data and metadata in the context of IoT

This section will address firstly the content of IoT communications, i.e. “data”, and the underlying distinction in personal and non-personal data. Secondly, the focus will shift on the metadata accompanying the communications.

The notion of non-personal data is not clearly defined. Thus, even the European Regulation for the free flow of non-personal data provides a negative definition, i.e. “data other than personal data as referred to in Article 4(1) of Regulation (EU) 2016/679”<sup>10</sup>. Additionally, not only the definition of “personal data” is intentionally designed as broadly by the European legislator<sup>11</sup>, but also the identifiability criterion is dynamic and context-dependent, which, similar to “relate to”<sup>12</sup>, cannot be established in an absolute way<sup>13</sup>. It results that legal certainty is even more difficult to obtain.

The non-personal nature of such data might encompass a wide spectrum of information: machine-generated data and commercial data, whether they have never been personal, i.e. data not relating to an identified or identifiable person, or subsequently anonymized [16].

At the dawn age of IoT’s hyper-connection, data reuse and data mining, it will become more and more arduous to discern whether a piece of information will not impact the

---

<sup>9</sup> See recital 15 of the Directive 2002/58/EC: “A communication may include any naming, numbering or addressing information provided by the sender of a communication or the user of a connection to carry out the communication”.

<sup>10</sup> See article 3(1), EU Regulation 2018/1807 for the free flow of non-personal data.

<sup>11</sup> The ECJ has endorsed this broad understanding of the concept of personal data: it is not necessary that all the information allowing the identification of the individual must be in possession of one person (see Judgment of 19 October 2016, Patrick Breyer v Bundesrepublik Deutschland, C-582/14, paragraph 43).

<sup>12</sup> See article 4(1), EU Regulation 2016/679

<sup>13</sup> See Recital 26 of EU Regulation 2016/679

privacy and the right to data protection of an individual [17]. Furthermore, the possibility to single out an individual on the basis of very few data points has become easier [18]. This happens mainly due to Big Data analytics techniques [19], that rely upon huge datasets composed by personal or non-personal data or, as most often happens, mixed datasets combining the two<sup>14</sup>.

Threats to privacy and data protection may as well arise from other data processing than personal, by combining various allegedly non-personal data to infer information related to a person or a group [20,21].

Current practices of market operators show the tendency to implement standardized procedures for the anonymisation of personal data [22], therefore making them non-personal<sup>15</sup>. There is a thriving literature<sup>16</sup> nonetheless aiming at implement algorithms in order to demonstrate how insecure most of the anonymization techniques could be. Organizing, crossing and correlating several datasets with few anonymized personal records may result in the emergence of patterns related to single individuals out [23,24]. In this regard, it is appropriate to consider the case of anonymised statistical data. The EDPS analysed the processing of statistical data, which usually consists of two different phases: “the initial phase while re-linking the data is still possible, and indeed, desired in order to enrich statistical data by linking various datasets<sup>17</sup>; a later phase when statistical data has been prepared, and the keys allowing linking the various datasets can be destroyed” [25]. However, the destruction of the keys does not necessarily convert such statistical data into non-personal data. Additionally, the EDPS clarifies that the input data may be processed in a twofold way: destroyed together with the identification-keys or stored as raw data. As noticed by Graef et al. [26] “even when organisations are only in possession of aggregate statistical data and the initial identifiers have been destroyed, such data might still be considered personal depending upon whether it has been subjected to anonymisation techniques, and whether the latter are considered adequate”<sup>18</sup>. The researches of Sweeney [27] and Narayanan and Shmatikov [28] are two groundbreaking analysis which might be better illustrate how data aggregation works in practice. Among the many merits, the above mentioned examples show how and to what extent data inference and re-identification could hamper the individual’s rights to privacy and data protection, “for example leading to humiliation or even threat to life due to the disclosure of confidential information” [29].

Moving forward on the ambiguous and blurred distinction when it comes to categorize data, now the investigation considers the other face of the same coin, namely metadata. The proposal for the ePrivacy Regulation defines metadata at article 3(c) in a very detailed fashion, acknowledging their sensitive nature<sup>19</sup>: they may expose sensitive information and present significant risks [30].

---

<sup>14</sup> The mixed dataset, for practical purposes, has been referred “to a situation whereby a dataset contains personal data as well as non-personal data and separating the two would either be impossible or considered by the controller to be economically inefficient or not technically feasible” [49].

<sup>15</sup> See Recital 26 of EU Regulation 2016/679

<sup>16</sup> Cfr. *ex multis* with Ohm [50].

<sup>17</sup> The input data are pseudonymised and, through other technical and organisational measures (complaint with article 32 of EU Regulation 2016/679), the risks of re-identification of the individuals are minimised. The pseudonymisation process requires key coding the data: the keys, i.e. the information that links the datasets to the correct individuals, must be kept separately.

<sup>18</sup> For an in-depth analysis, see Article 29 Working Party on anonymisation techniques [51].

<sup>19</sup> See Recital 2 of the Proposal for the adoption of the ePrivacy Regulation

Recent research shows how metadata may be as sensitive as content, outlining individual's information exposure in IoT environments<sup>20</sup>, in terms of destinations of network traffic. Even if encrypted. The data packets<sup>21</sup> communicated (transport layer) from the IoT system to the server are sent with so-called timestamps, i.e. the time and date of the action delivered by the device: in case of aggregated timestamps, one can retrieve timing patterns. Timestamps are metadata: they set the context in which the informational object is formed and shared. While data present elements of ambiguity and subjective interpretation, context metadata (e.g. timestamps) are more meaningful and objective: it is the human experience of the use of informational or physical objects, and their interconnection thanks to IoT, the most valuable resource and also the one less governable by the end-user [31].

In Ren et al. [32], to understand the information exposed during the interaction with an IoT device, the research started with collecting network trafficking, and labelling it afterwards, when devices are powered on. It resulted that diverse non-first-party destinations, e.g. Amazon, Google, Akamai, have received information from the majority of the IoT devices under investigation. Researchers then focused on whether devices send data securely by analysing the means of encryption adopted. Even though unencrypted traffic is a minority of all traffic, substantial information exposure has been identified via plaintext traffic for all devices, categories, interactions, and regions. The personal data -or even sensitive data- exposed in plaintext was limited. Moreover, the authors identified many cases of unexpected behavior, e.g. when a device generates network traffic corresponding to an interaction that either did not occur, or it was not intended by the user. There were cases of devices surprisingly sending audio or video in the uncontrolled experiments, highlighting that concerns about individuals' data exposition by IoT devices is warranted.

The three aforementioned researches are particularly relevant for this paper since they show that even when devices use encryption techniques, the timing patterns of the network traffic enable accurate identification of the interactions that caused the network traffic. "Put another way, an eavesdropper can reliably learn a user's interactions with a device across a wide range of categories, opening the potential for profiling and other privacy-invasive techniques" [32]. Acar et al. introduced a novel multi-stage privacy attack: through machine learning approaches, an adversary can automatically detect and identify types of devices, their actions, states, and related user activities by passively monitoring the wireless traffic of smart home devices. The intrusion works well on both encrypted and unencrypted communications, achieving very high accuracy (above 90%). To mitigate this privacy concern, they propose a new yet effective mitigation mechanism to hide the real activities of the users [33].

Similarly, Takbiri et al. investigate the fundamental limits of user privacy when both anonymization and obfuscation-based protection mechanisms are applied to users' time series of data [34].

However, the research of Ren et al. differs from the other two approaches by developing a machine learning approach which uniquely considers different possible interaction methods between user and device.

---

<sup>20</sup> Their methodology consisted in 34,586 repeatable experiments on 81 devices in two labs, one in the US at North-eastern University's Mon (IoT)r Lab and one in the UK at Imperial College London, over one month.

<sup>21</sup> Reference is made, here, to the data packets in the transport layer (TCP/IP) within the OSI/ISO model.

The three models have demonstrated that illicit profiling as well as privacy and data protection concerns arise, in the IoT domain, even when communications' content is not at stake. And even if it is encrypted. Data packets and thus related timestamps, *per se*, should not be considered *prima facie* personal data since they are the reading of the time-of-day clock when the structured query language (SQL) statement is executed at the application server<sup>22</sup>. These approaches have valuably demonstrated that an eavesdropper might be able to infer, through the recorded timestamp and the patterns they are able to create, valuable information regarding the user. Therefore, these patterns shall be categorized as personal data even when the underlying communication is encrypted: they can nonetheless relate to an individual, and/or the individual can be considered to be identified or identifiable [35].

Dumortier et al. noted that the European Court of Justice's Tele2 ruling (C-203/15) did not argue that metadata was sensitive by definition: "rather, the Court condemned the indiscriminate and universal collection of a very broad set of metadata, given that this data taken as a whole could establish a profile of the individuals concerned, in the context of potentially criminal activity. [...] The processing of metadata, even in the context of electronic communications, can also have very limited data protection implications" [36]. Nevertheless, the above mentioned technical researches have been shown that even when GDPR's appropriate safeguards are established, like means of encryption, metadata have considerable privacy and data protection implications. Acknowledging that the ECJ has broadened the interpretation of personal data afterwards in the Nowak case (C-434/16)<sup>23</sup>, the rationale behind this interpretation is in line with the objective reasoning of the Court of Justice of the European Union in Breyer v Germany<sup>24</sup>: the scope of personal data should be determined by assessing whether there are means reasonably likely to be used to identify individuals, and not merely a theoretical possibility of identification [37]. In our case, the means provided by timing patterns, which allow an adversary to "*reliably* learn a user's interactions with a device across a wide range of categories" [32], are more *reasonably likely to be used* for identification rather than remaining a *theoretical possibility*.

This interpretation must deal with two underlying issues. Firstly, it should be noted that even though the Breyer case offered the Court a chance "to confirm or reject the WP29 guideline 'implied identification = reasonably likely identification', the Court chose not to do so" [38]. The result of the evaluation of what the ECJ considered "identification measures reasonably likely to be taken" was elaborated in order to answer the narrow question posed, and in relation to the circumstances of the case.

---

22

Cfr.

with:

<https://www.ibm.com/support/knowledgecenter/SSFMBX/com.ibm.swg.im.dashdb.sql.ref.doc/doc/r0005886.html>

<sup>23</sup> The Court ruled on the meaning of information relating to a person twice: in the Joint cases C-141/12 and C- 372/12 YS and M. and S. v Minister of Immigration, Integration and Asylum (2016) and in the Case C-434/16 Peter Nowak v Data Protection Commissioner (2017). The *relation* link of the former is interpreted by the Court narrowly, as information about an individual, thus rejecting the broader understanding of [36]. The ECJ endorsed the AG Sharpston's Opinion where, at line 56, considers as personal data "only information relating to facts about an individual". In the Novak case, the ECJ overturned this interpretation. Following the Opinion of AG Kokott, the Court stated that the notion personal data potentially encompasses any information, as long as it relates to the data subject, i.e. when the information is linked to a particular person by reason of its content, purpose or effect (Novak case, para 34-35).

<sup>24</sup> If the CJEU had applied the GDPR, rather than the Data Protection Directive, it would almost certainly have reached a similar conclusion [52].



Secondly, in considering what *means of identification* are reasonably likely to be used, the Court added the factor of legality to the conditions set out by WP29: ECJ ruled that identification would not be reasonably likely if prohibited by law. Purtova, however, rightly points out that the Court's reasoning shall be viewed in a more nuanced way, namely that "a legal prohibition to combine data for identification would make the means of identification 'less reasonably likely to be used', rather than 'not reasonably likely'" [38]. Interestingly enough, another recent research highlights the same privacy-risk scenario but in a context where timing patterns are publicly available: it shows that device identification in blockchain introduces privacy risks as the malicious nodes can identify users' activity pattern by analysing the temporal pattern of their transactions in the blockchain [39].

In conclusion, given that eavesdropping activities, such as sniffing, man-in-the-middle attack and spoofing, in relation to the timing patterns are considered contrary to the law<sup>25</sup>, according to the interpretation endorsed by the Court (but contrary to what stated by WP29) these means of identification are less reasonably likely to be used, if we accept the reasoning of the Court. But, as a matter of fact, they can be used. And the resulting inference might lead to illegal profiling and other privacy-invasive techniques.

I argue therefore that the analysed case-study of IoT systems' timing patterns calls for a necessary reassessment of the abovementioned equation outlined by Article 29 Working Party: accordingly, such metadata are reasonably likely to identify.

### III. Conclusion.

This paper has contributed to show that timestamps related to IoT devices' encrypted data packets can arguably be deemed personal data, even though, *prima facie*, they fall outside any definition of personal data. The case of illegal profiling from adversarial inferences of network timing patterns in IoT devices shows that serious privacy and data protection concerns may arise even though security techniques such as encryption are adopted.

Therefore, equating *every* kind of metadata with content, in terms of legal protection granted by the incoming ePrivacy Regulation, will be crucial. Nevertheless, it should be noted that Article 29 Working Party, commenting on the proposal, singles out as a point of "grave concern" the different level of protection accorded to content and metadata [40].

The necessary equalisation process might deal with the strong assumption made by Purtova, i.e. "if all data has a potential to impact people and is therefore personal, all data should trigger some sort of protection against possible negative impacts" [38]. It is certainly true that if nearly every aspect of the communication is personal data, and therefore data protection regime comes always into play, the "highly intensive and non-scalable regime of rights and obligations created by the GDPR will not simply be difficult but impossible to maintain in a meaningful way" [38]. Notwithstanding, Purtova claims that a broad understanding of personal data may still hold on for a while since the hyper-connectivity of our society has not yet reached a level of maturity such as to justify such a paradigm shift.

---

<sup>25</sup> Cfr. with, *inter alia*, the Italian Criminal Code: articles 615-bis and 615-ter consider the abusive access to a computer or telematic system, or the unlawful interference with individuals' privacy as criminal offences.

However, it may no longer be the case, as testified by the case of IoT devices' metadata. The European Commission released in February 2020 the first pillars of the new digital strategy, aiming at creating a single market for data that will ensure Europe's global competitiveness and data sovereignty. In "A European strategy for data", Brussels announces the creation of sector and domain-specific data spaces [41]. These common European data spaces will ensure that more data becomes available for use in economy and society, while keeping companies and individuals who generate the data under control.

However, the program still heavily relies on a sharp and non-problematic distinction between personal and non-personal data [26]. Thus, at the very first point of the appendix of the Data strategy document, it is argued that the intention of the Commission is to unleash the potential value of using non-personal data in industrial manufacturing, whereas "data generated by individuals are concerned, their interests should be fully taken into account in such a process and compliance with data protection rules must be ensured" [41]. It has been left unclear whether there is a boundary, in such a critical domain, in the relatability of data to individuals.

In this scenario, it is essential to create and consolidate a European data governance model<sup>26</sup>, overcoming the ontological distinction of data, in order to complement and support the entire GDPR system.

#### **IV. Future research.**

Further research should aim at facing up and stimulating the debate on whether encrypted data could be deemed personal data or not in the context of IoT systems [42,43].

#### **Acknowledgments:**

This project has received funding from the European Union's Horizon 2020 research and innovation program under the Marie Skłodowska-Curie grant agreement No. 814177.

#### **References:**

- [1.] Kokott J, Sobotta C. The distinction between privacy and data protection in the jurisprudence of the CJEU and the ECtHR. *Int Data Priv Law*. 2013;3(4):222–8.
- [2.] Docksey C, Hijmans H. The court of justice as a key player in privacy and data protection: An overview of recent trends in case law at the start of a new era of data protection law. *Eur Data Prot Law Rev*. 2019;5(3):300–16.
- [3.] Lynskey O. Deconstructing data protection: The "added-value" of a right to data protection in the eu legal order. *Int Comp Law Q*. 2014;63(3):569–97.
- [4.] Pagallo U. The Impact of Domestic Robots on Privacy and Data Protection. *Data Prot Move [Internet]*. 2016;24(October):387–410. Available from: <http://link.springer.com/10.1007/978-94-017-7376-8>
- [5.] Chaudhuri A, Cavoukian A. The Proactive and Preventive Privacy (3P) Framework for IoT Privacy

---

<sup>26</sup> Cfr. with Pagallo et al. [53]: the authors suggest a middle way between bottom-up and top-down governance models, for the creation of a regulatory model based on hard law and self-regulation, also including the engagement of civil society.

- by Design. *EDPACS*. 2018 Jan 2;57(1):1–16.
- [6.] Cavoukian A. Privacy by design: origins, meaning, and prospects for assuring privacy and trust in the information era. *IGI Glob* [Internet]. 2012 [cited 2020 Feb 11]; Privacy pr:170–208. Available from: <https://www.igi-global.com/chapter/privacy-design-origins-meaning-prospects/61500>
  - [7.] ENISA. Recommendations on shaping technology according to GDPR provisions: Exploring the notion of data protection by default. 2018.
  - [8.] Rayes A, Salam S. Internet of Things From Hype to Reality. *Internet of Things From Hype to Reality*. 2019.
  - [9.] EDPS. Meeting the challenges of big data A call for transparency, user control, data protection by design and accountability. 2015.
  - [10.] ENISA. Privacy by design in Big Data. An overview of privacy enhancing technologies in the era of big data analytics. 2015.
  - [11.] Eskens S. Profiling the European Citizen in the Internet of Things: How Will the General Data Protection Regulation Apply to this Form of Personal Data Processing, and How Should It? *SSRN Electron J*. 2016;
  - [12.] Hildebrandt M. Profiling and the identity of the European citizen. In: *Profiling the European Citizen: Cross-Disciplinary Perspectives*. Springer Netherlands; 2008. p. 303–43.
  - [13.] Pagallo U, Durante M, Monteleone S. What Is New with the Internet of Things in Privacy and Data Protection? Four Legal Challenges on Sharing and Control in IoT. In: *Data protection and privacy: (in) visibilities and infrastructures*. Springer, Cham; 2017. p. 59–78.
  - [14.] Article 29 Data Protection Working Party. Opinion 8/2014 on the on Recent Developments on the Internet of Things [Internet]. 2014 [cited 2020 Jan 31]. Available from: [http://ec.europa.eu/justice/data-protection/index\\_en.htm](http://ec.europa.eu/justice/data-protection/index_en.htm)
  - [15.] Article 29 Data Protection Working Party. Guidelines on Automated individual decision-making and Profiling for the purposes of Regulation 2016/679. 2017.
  - [16.] European Parliament Research Service. Briefing on Free flow of non-personal data in the European Union [Internet]. 2017 [cited 2020 Feb 14]. Available from: [http://www.europarl.europa.eu/RegData/etudes/BRIE/2017/614628/EPRS\\_BRI%282017%29614628\\_EN.pdf](http://www.europarl.europa.eu/RegData/etudes/BRIE/2017/614628/EPRS_BRI%282017%29614628_EN.pdf)
  - [17.] Graef I, Gellert R, Purtova N, Husovec M. Feedback to the Commission’s Proposal on a Framework for the Free Flow of Non-Personal Data. *SSRN Electron J*. 2018 Feb 7;
  - [18.] EDPS. Comments of the EDPS on a Proposal for a Regulation of the European Parliament and of the Council on a framework for the free-flow of non-personal data in the European Union [Internet]. 2018 [cited 2020 Feb 14]. Available from: [www.edps.europa.eu](http://www.edps.europa.eu)
  - [19.] Tene O, Polonetsky J. Big Data for All: Privacy and User Control in the Age of Analytics, 11 *Nw. Northwest J Technol Intellect Prop* [Internet]. 2013 [cited 2020 Mar 3]; 11(5):239–73. Available from: <https://scholarlycommons.law.northwestern.edu/njtip/vol11/iss5/1>
  - [20.] Big Data Public Private Forum. Big Data Technical Working Groups White Paper. 2014.
  - [21.] European Parliament’s ITRE Committee by Blackman and Forge. Data Flows — Future Scenarios: In-Depth Analysis for the ITRE Committee [Internet]. 2017. Available from: [http://www.europarl.europa.eu/RegData/etudes/IDAN/2017/607362/IPOL\\_IDA\(2017\)607362\\_EN.pdf](http://www.europarl.europa.eu/RegData/etudes/IDAN/2017/607362/IPOL_IDA(2017)607362_EN.pdf)
  - [22.] Garante per la Protezione dei Dati Personali. Indagine Conoscitiva sui Big Data. 2020.
  - [23.] Zhao R, Ouyang W, Wang X. Unsupervised Saliency Learning for Person Re-identification. In: *The IEEE Conference on Computer Vision and Pattern Recognition (CVPR)*. 2013. p. 3586–93.
  - [24.] Zheng WS, Gong S, Xiang T. Person re-identification by probabilistic relative distance comparison. In: *Proceedings of the IEEE Computer Society Conference on Computer Vision and Pattern Recognition*. IEEE Computer Society; 2011. p. 649–56.
  - [25.] EDPS. Opinion on safeguards and derogations under Article 89 GDPR in the context of a proposal for a Regulation on integrated farm statistics. 2017.
  - [26.] Graef I, Gellert R, Husovec M. Towards a Holistic Regulatory Approach for the European Data Economy: Why the Illusive Notion of Non-Personal Data is Counterproductive to Data Innovation. *SSRN Electron J*. 2018 Oct 3;
  - [27.] Sweeney L. Simple Demographics Often Identify People Uniquely. *Health (Irvine Calif)*. 2000;671:1–34.
  - [28.] Narayanan A, Shmatikov V. Robust De-anonymization of Large Sparse Datasets. In: *2008 IEEE Symposium on Security and Privacy*. 2008. p. 111–25.
  - [29.] ENISA. Privacy by design in big data: An overview of privacy enhancing technologies in the era of big data analytics [Internet]. 2015 [cited 2020 Feb 18]. Available from: <https://www.enisa.europa.eu/news/enisa-news/privacy-by-design-in-big-data-an-overview-of-privacy-enhancing-technologies-in-the-era-of-big-data-analytics>

- [30.] Conley C. Metadata: Piecing Together a Privacy Solution [Internet]. 2014. Available from: [https://www.aclunc.org/sites/default/files/Metadata report FINAL 2 21 14 cover %2B inside for web %283%29.pdf](https://www.aclunc.org/sites/default/files/Metadata%20report%20FINAL%2021%2014%20cover%2B%20inside%20for%20web%283%29.pdf)
- [31.] Palmirani M, Martoni M. Big data, governance dei dati e nuove vulnerabilità. *POLITEIA*. 2019;XXXV(136):9–22.
- [32.] Ren J, Dubois DJ, Choffnes D, Mandalari AM, Kolcun R. Information Exposure From Consumer IoT Devices: A Multidimensional, Network-Informed Measurement Approach. *Proc Internet Meas Conf* [Internet]. 2019 [cited 2020 Feb 26];267–79. Available from: <https://doi.org/10.1145/3355369.3355577>
- [33.] Acar A, Fereidooni H, Abera T, Kumar Sikder A, Miettinen M, Aksu H, et al. Peek-a-Boo: I see your smart home activities, even encrypted! *ArXiv Prepr arXiv180802741*. 2018;
- [34.] Takbiri N, Houmansadr A, Goeckel DL, Pishro-Nik H. Matching anonymized and obfuscated time series to users' profiles. *IEEE Trans Inf Theory*. 2019 Feb 1;65(2):724–41.
- [35.] Article 29 Data Protection Working Party. Opinion 4/2007 on the concept of personal data. 2007.
- [36.] Dumortier J, Somers G, Jacobs E, Graux H, Debusseré F, Van Camp S, et al. Legal memo with respect to the concept of metadata and its degree of sensitivity under future European e-privacy law. 2018.
- [37.] Mourby M, Mackey E, Elliot M, Gowans H, Wallace SE, Bell J, et al. Are 'pseudonymised' data always personal data? Implications of the GDPR for administrative data research in the UK. *Comput Law Secur Rev*. 2018 Apr 1;34(2):222–33.
- [38.] Purtova N. The law of everything. Broad concept of personal data and future of EU data protection law. *Law, Innov Technol*. 2018 Jan 2;10(1):40–81.
- [39.] Dorri A, Roulin C, Jurdak R, Kanhere S. On the Activity Privacy of Blockchain for IoT. *IEEE 44th Conf Local Comput Networks* [Internet]. 2019 Dec 21 [cited 2020 Mar 2];258–61. Available from: <http://arxiv.org/abs/1812.08970>
- [40.] Article 29 Data Protection Working Party. Opinion 01/2017 on the Proposed Regulation for the ePrivacy Regulation (2002/58/EC). 2017.
- [41.] European Commission. A European Strategy for Data. 2020.
- [42.] EDPS and AEPD. Introduction to the Hash Function as a Personal Data Pseudonymisation Technique. 2019.
- [43.] Article 29 Data Protection Working Party. Statement of the WP29 on encryption and their impact on the protection of individuals with regard to the processing of their personal data in the EU [Internet]. 2018 [cited 2020 Feb 26]. Available from: [https://ec.europa.eu/newsroom/article29/item-detail.cfm?item\\_id=622229](https://ec.europa.eu/newsroom/article29/item-detail.cfm?item_id=622229)
- [44.] Floridi L. The ontological interpretation of informational privacy. *Ethics Inf Technol*. 2005;7(4):185–200.
- [45.] ENISA. How to implement security by design for IoT [Internet]. 2019 [cited 2020 Feb 13]. Available from: <https://www.enisa.europa.eu/news/enisa-news/how-to-implement-security-by-design-for-iot>
- [46.] Rajagopalan R, Varshney PK. Data aggregation techniques in sensor networks: A survey [Internet]. 2006 [cited 2020 Feb 14]. Available from: <https://surface.syr.edu/eecs/22>
- [47.] Pagallo U. The Group, the Private, and the Individual: A New Level of Data Protection? In: *Group Privacy*. Springer International Publishing; 2017. p. 159–73.
- [48.] Taylor, L., Floridi, L., & Van der Sloot B (Eds. . *Group Privacy: New Challenges of Data Technologies*. Springer. 2016;126.
- [49.] European Commission. COMMUNICATION FROM THE COMMISSION TO THE EUROPEAN PARLIAMENT AND THE COUNCIL: Guidance on the Regulation on a framework for the free flow of non-personal data in the European Union [Internet]. 2019 [cited 2020 Feb 19]. Available from: <https://eur-lex.europa.eu/legal-content/EN/TXT/?uri=COM:2019:250:FIN>
- [50.] Ohm P. Broken promises of privacy: Responding to the surprising failure of anonymization. *UCLA L Rev*. 2009;57:1701.
- [51.] Article 29 Data Protection Working Party. Opinion 05/2014 on Anonymisation Techniques [Internet]. 2014 [cited 2020 Feb 17]. Available from: [http://ec.europa.eu/justice/data-protection/index\\_en.htm](http://ec.europa.eu/justice/data-protection/index_en.htm)
- [52.] Borgesius FZ. The Breyer Case of the Court of Justice of the European Union: IP Addresses and the Personal Data Definition. *Eur Data Prot Law Rev*. 2017;3(1):130–7.
- [53.] Pagallo U, Casanovas P, Madelin R. The middle-out approach: assessing models of legal governance in data protection, artificial intelligence, and the Web of Data. *Theory Pract Legis*. 2019;7(1):1–25.

# Big Data and Pandemics: How to Strike Balance with Data Protection in the Age of GDPR

Aiste Gerybaite<sup>a,1</sup>, Paola Aurucci<sup>b1</sup>

<sup>a</sup>University of Torino; University of Bologna; University of Luxembourg

<sup>b</sup>University of Torino

**Abstract.** The paper focuses on technological and legal impact of the Covid-19 crisis, drawing the attention to the convergent nature of Big Data in healthcare emergencies. While, Big Data tools have the potential to prevent, predict, manage or treat arising pandemics, at the same time the use of data driven solutions as raise numerous privacy concerns. European General Data Protection Regulation (GDPR) may fall short when it comes to addressing risks of Big Data analytic tools, in particular when it comes to the collective dimension of data protection rights. However, as shown by the recently issued guidelines of the European Data Protection Board (EDPB) is possible to find a "fair-balance" between public authorities and private entities necessity to implement surveillance measures and the respect of data protection fundamental principles.

**Keywords.** GDPR, Big Data, pandemics

## 1. Introduction

The risk of epidemics and pandemics is as real as ever. Only in the past decade, the world has dealt with Ebola, Zika, SARS and now, the ongoing 2019 Novel Coronavirus pandemic. Correspondingly, due to the widespread use of technologies, various organisations and countries have started investing into using the vast and various data (otherwise known as Big Data) available to prevent, predict, manage or treat arising pandemics. In order to extract knowledge from such Big Data for epidemiology, machine learning tools are applied. For example, novel digitised syndromic surveillance systems have been rapidly adopted by the World Health Organisation<sup>2</sup> in order to assist with the arising risks of epidemics and pandemics such as the outbreak of SARS in 2002[4]. Roberts observes that the emergence of these syndromic surveillance systems which sought to enhance the surveillance and reporting of pandemic risk in the late 20th century

---

<sup>a1</sup> Aiste Gerybaite; Law school of the University of Torino, Torino, Italy; Interdepartmental Centre for Research in the History, Philosophy, and Sociology of Law and in Computer Science and Law (CIRSFID) of the University of Bologna, Bologna, Italy; Computer Science Department of the University of Luxembourg, Luxembourg; E-mail: [aiste.gerybaite@unio.it](mailto:aiste.gerybaite@unio.it)

<sup>b1</sup> Paola Aurucci, Department of Management of the University of Turin, Torino, Italy; E-mail: [paola.aurucci@unito.it](mailto:paola.aurucci@unito.it).

<sup>2</sup> Further- WHO

also facilitated a novel broader turn in practices of surveillance towards the development of new digital surveillance technologies, and the implementation of accelerated data-processing capacities to address contingent pandemic risks[14].

In Europe, the introduction of the General Data Protection Regulation<sup>3</sup> has also changed the way scholars, lawyers, governments, consumers, and developers look at data protection in the context of Big Data. The healthcare sector as any other had to adapt and adopt both, the Big Data tools and the GDPR norms. Google Flu Trends and Reporta are just a few Big Data tools that were deployed to manage and track diseases, both of which brought out concerns relating to data protection and unauthorised surveillance. Once the latest pandemic Covid-19 hit Europe, it has also brought on its feet the EU Data Protection Board and the national EU data protection authorities in order to address the emergency state and the request by member states' governments to deploy Big Data tools for the tracking, surveillance and managing of the epidemic. In particular, special attention requires the analysis of the articles of GDPR in the light of ensuring the balance of the protection of personal and sensitive data during such emergencies.

Through addressing the rise of Big Data within epidemiology and in particular within the monitoring, managing and treatment of epidemics globally (such as Covid-19, SARS and so on), the risks to data protection stemming from the notion of Big Data, and the introduction of the GDPR, the paper tackles the issue of balancing the right to data protection in epidemics and considers that GDPR provides the necessary legal ground for the processing of personal and sensitive data in such context.

## 2. Big Data in epidemiology

The risk of epidemics and pandemics is as real as ever. Only in the past decade, the world has dealt Ebola, Zika, SARS and now, the ongoing Covid-19 pandemic. Correspondingly, due to the widespread of technologies, various organisations and countries have started investing into using the vast and various data (otherwise known as Big Data) available to prevent, predict, manage or treat arising pandemics. In order to extract knowledge from such Big Data for epidemiology, machine learning tools are applied. For example, novel digitised syndromic surveillance systems have been rapidly adopted by the WHO in order to assist with the arising risks of epidemics and pandemics such as the outbreak of SARS in 2002[4]. Roberts observes that the emergence of these syndromic surveillance systems which sought to enhance the surveillance and reporting of pandemic risk in the late 20th century also facilitated a novel broader turn in practices of surveillance towards the development of new digital surveillance technologies, and the implementation of accelerated data-processing capacities to address contingent pandemic risks[14].

Canada is known to be an early adopter of Big Data in healthcare through the creation of the Global Public Health Intelligence Network<sup>4</sup>, a cooperative effort between Health Canada and the WHO. GPHIN uses an automated web-based system which scanned newspapers and other communications globally looking for outbreak indications that were analysed by a multilingual team and where a potential risk was assessed

---

<sup>3</sup> Further- GDPR. Regulation (EU) 2016/679 of the European Parliament and of the Council of 27 April 2016 on the protection of natural persons with regard to the processing of personal data and on the free movement of such data, and repealing Directive 95/46/EC, OJ L 119/1 of 4.05.2016,

<sup>4</sup> Further- GPHIN

communications were sent out to the appropriate stakeholders to take action[4]. Due to the proliferation of internet, emails and social media, new sources of Big Data were identified, which were also used to analyse and detect signals of early infectious disease outbreaks. With the emergence of new sources of data, new systems for Big Data applications for public health and particular pandemics were introduced too. Crowdsourcing systems which captured voluntarily submitted symptoms from the general public through the web/mobiles were introduced that provided rapid feedback about data in real-time (platforms such as FluTracking, Reporta and Flu Near You) [8].

With the proliferation of sources of the data available for the prevention, detection and management of pandemics, the data analytics field has also expanded. In machine learning, unsupervised learning tools have been used for outbreak detection, and surveillance while supervised learning tools are used for spatiotemporal hot spot detection[12]. Further, in epidemiology particularly, machine learning is integrated into causal inference techniques in order to predict or discover various pandemics[12]. Lastly, machine learning computational tools and verification methods systems allowed to improve the sensitivity and specificity of signals that are detected are being considered[4].

Despite the emergence and the use of the Big Data technologies, the Organisation for Economic Co-operation and Development<sup>5</sup> in its report on health data in the 21st century observed that one of the central dilemma within public healthcare sector when it comes to using Big Data is the so-called “a lot is known, but little is put into practice” issue[16]. However, OECD also notes that integrating and utilising data sources from both health organisational databases and new Big Data sources (for example, wearables, social media) hold the potential to deliver gains in public health. Sadly, only three of the OECD countries (Canada, Estonia, and the Netherlands) use Big Data sources to improve public healthcare[12]. While the potential of the Big Data is clear, the OECD does not forget to mention the requirement for precise and consistent policies to be designed for safeguarding personal and sensitive data within the context of Big Data in public healthcare.

### *2.1. Big Data risks*

The risks associated to the outbreaks of epidemics or pandemics do not only affect global public health or worldwide economy but also due to the proliferation of digitalisation and the data available bring about unforeseen risks associated to the use of the so-called “Big Data” tools within healthcare when trying to prevent, predict, manage or treat arising pandemics. From the vast and various data collected, a value can be retrieved, and that valuable data can be used in various ways. Big Data in healthcare consists not only of electronic health records but also includes various structured and unstructured data such as clinical decisions, physician’s prescriptions, medical imaging, laboratory data, data from biomedical sensors, health-app collected health-related data, Fitbit data and even social media data in the case of public health. It is also widely accepted that Big Data in healthcare may include personal and sensitive data[2]. While some of such Big Data may be anonymised or pseudo-anonymised, the reality is that Big Data analytic tools are capable of de-anonymising information and through the use of the various analytic tools re-create a profile of an individual to which the data relates to.

Leading ICT consulting firm, Gartner, defines Big Data as “high volume, high velocity, and/or wide variety information assets that require new forms of processing to

---

<sup>5</sup> Further- OECD

enable enhanced decision making, insight discovery and process optimisation.[15]” Thus, when talking about Big Data in healthcare, we refer to data sets which are too large or too complex to be managed with traditional software and would include both structured and unstructured, sensitive personal, personal and non-personal data in anonymised, pseudo-anonymised and raw formats. Interestingly, as it stands today, the GDPR scope excludes anonymised data due to the fact that anonymised data cannot be foreseen to be personal data under the scope of article 4 of GDPR. However, from a technological standpoint, there is a possibility of re-identification if an individual through the use of anonymized data in data analytics tools. This poses a question on whether the GDPR falls short in such scenarios and whether the GDPR is one step behind the technological data analytic capabilities.

In practice, the terms Big Data and Big Data in healthcare are sometimes used interchangeably because both Big Data and Big Data in healthcare would comprise of at least the 3Vs that are used to identify Big Data: volume, velocity and variety. However, when compared, Big Data and Big Data in healthcare have one significant difference-value (through knowledge). Value extractable from Big Data in healthcare is what separates generic Big Data sets and Big Data sets in healthcare.

Due to the diverse sources and types of Big Data used in epidemiology, the privacy risks associated to the use of such Big Data transpire from the notion of Big Data itself and the features attributable to Big Data, the 3Vs: volume, velocity and variety. Historically the trend for data within the public healthcare sector and particularly within epidemiology referred to the lack or incompleteness of the data available, today, as observed by Roberts, due to the analysis of the mass-data sets via automation and algorithmic processing by Google Flu Trends during the outbreak of H1N1, a new shift arose moving from the problematisation of data incompleteness towards the problematisation of data excess[15]. One can conclude that due to data excess personal privacy is affected as algorithmic tools through the use of the Big Data available are now capable more than never to refer to a particular individual.

Furthermore, due to increased dimensionality of data (variety) makes it challenging to determine whether the data is sufficiently anonymised to prevent deductive disclosure of information capable of identifying a person, as noted by Mooney[12]. Increasing amounts of data may create fingerprints that would allow subjects to be re-identified through deductive disclosure[12]. Lastly, the velocity of the Big Data flooding, for example, research network, may lead to cyberattacks as sinister payloads (such as malware) may be hidden in that flow and pass through the network firewall. From the analysis of principle features attributable to Big Data, one may observe a nexus between the legal protection of the personal or sensitive data and the technological security of data in Big Data. One cannot analyse data protection norms without addressing the technological aspect of data security.

In 2017, the EU Parliament noted that in the case of using Big Data, the risk of extracting predictive knowledge from large sets of data for making decisions concerning individuals or/and groups may lead to risks such as manipulation, discrimination or oppression of individuals and/or groups of individuals due to the mishandling of such data[17]. Similarly, the OECD in its report specified that the use of Big Data within the public healthcare sector, in a cross-border scenario encounters four main challenges: 1. data localisation laws and policies; 2. data security threats that discourage data sharing; 3. lack of global standards for data content and interoperability; and 4. commodification and sale of health data on a world market[18]. In fact, since there are no consistent global standards for content or exchange of such Big Data, private sectors actors are doing



business out of it by monetising data. A few years later, in 2019, the Council of Europe issued guidelines concerning the processing of health-related data for GDPR purposes, whereas it outlined the principles such processing should follow. The Council of Europe in its guidelines defined 'health-related data' as "all personal data concerning the physical or mental health of an individual, including the provision of healthcare services, which reveals information about this individual's past, current and future health.[1]" The further elaboration by the Council of Europe on the definition of 'data related to health' and 'health-related data' seems to suggest that the protection of Big Data in healthcare does not only include personal healthcare records but expands to all types of data that can indicate an individual's health status and thus also requires special protection.

Consequently, the Big Data risks from the data protection perspective may be categorized into two dimensions: the individual privacy and the collective dimension of data protection rights when applying Big Data[3][10]. Whilst the risks associated to the individual privacy have been discussed above, a look at the collective dimension of data protection rights and risks related to groups of individuals needs to be analysed as well. Groups of individuals or societies may be manipulated, discriminated or oppressed through the mishandling of Big Data. The collective dimension of data protection rights does not only bring about the legal challenges but also incuse social and ethical issues, particularly with respect to non-discrimination and the right to equal treatment that ought to be addressed by the legislator.

### **3. A balance between data protection and digital epidemiology**

Enhancing the use of digital technology through the creation of a Digital Single Market, is one of the European Commission's main priorities[5].

To achieve it, the EU settled a Digital Single Market strategy[5] in which health is considered a sector where digital transformation could bring benefits for both citizens and enterprises. Digital solutions for health and care have, in fact, the potential to improve access to care, to increase the overall efficiency, quality of care and economic sustainability of the health services. Data is a key enabler for digital transformation and as seen in Paragraph § 2.1 Big Data can be analysed to prevent, predict, manage or treat arising pandemics. The European Commission, in close coordination with Member States took actions to stimulate i) citizens and companies to develop their activities online, ii) innovation and iii) economic growth. At the same time, EU has enacted legislation on data protection, as well as on medical devices, electronic identification and security of network and information systems to facilitate the responsible use of digital technologies in health and care. In few words the aim of the EU is to develop a Single Market where free competition is guaranteed as well as the higher standard of data protection.

For this reason, GDPR tries guarantee the protection of patients' data while ensuring the free movement of these data, which include sharing patient data when is necessary for healthcare and research purposes. However, some doubts on its success remain since as pointed out by Annabelle Gawer the enforcement of the regulation is local while the actors involved in the processing of personal data act at a global and interconnected level[6].

In emergency exceptional situations, like the global outbreak of the COVID-19, the sheer urgency of containing an exponentially spreading virus has thrown it into sharp relief the always present conflict between data protection and right to life, the actual ability of the GDPR to strike a balance between conflicting interests and, eventually,

protection of personal data has become a controversial issue. This last aspect is due to two main related factors. First, the increasing demand from public authorities and private entities for tighter measures that involve the massive processing of different types of personal data to contain and mitigate the effects of the virus. Second, the “wrong” belief that increased surveillance and unlimited limitations to the right of protection of personal data is “a necessary evil” to preserve lives[11].

In this context, the GDPR has been criticized as considered to be an obstacle to the adoption of measures that could reduce the spread of the virus.

However, as specified in Recital 1 and 4 of the GDPR, even if the right to the protection of personal data protection has been recognized as a fundamental right by the Charter of Fundamental Rights of the European Union<sup>6</sup> and by the Treaty on the Functioning of the European Union<sup>7</sup> it is not “absolute”, and it must be considered in relation to its function in society and be balanced against other fundamental rights. In the strike of a fair balance between these fundamental rights and other tasks carried out in the public interest, the EU and Member States should respect the principle of proportionality. According to this principle any limitations to this right of data protection must be, as provided by law, necessary and must genuinely meet the general interest as encamped in article 52(1) of the Charter.

This said, on 16<sup>th</sup> March 2020, the Chair of the European Data Protection Board<sup>8</sup>, Andrea Jelinek, published a statement in which, besides specifying that the GDPR rules, as seen, do not hinder measures taken in the fight against the coronavirus pandemic, it reiterates the importance of protecting personal data even in an emergency context. The same content was highlighted in the statement of 19<sup>th</sup> March[7] in which the EDPB specified the requirements of a lawful processing of personal data in the current emergency context. In particular, Andrea Jelinek, Chair of the EDPB, stressed that “Data protection rules (such as GDPR) do not hinder measures taken in the fight against the coronavirus pandemic. However, I would like to underline that, even in these exceptional times, the data controller must ensure the protection of the personal data of the data subjects. Therefore, a number of considerations should be taken into account to guarantee the lawful processing of personal data.”[7] Thus, the EDPB statement recalls the provisions of the GDPR that should be considered for processing personal data in a context such as the one relating to COVID-19.

In particular, EDPB stressed that Article 6 of the GDPR allows the processing of personal data - without the consent of the data subject - when it is “necessary” for compliance with a legal obligation to which the controller is subject, to protect the vital interests of the data subject or of another natural person, or when it is “necessary” for the performance of a task carried out in the public interest or in the exercise of official authority vested in the controller. Recital 46 specifically recognizes that certain provisions in Article 6 may be relevant for purposes of public health crises such as “monitoring epidemics and their spread or in situations of humanitarian emergencies, in particular in situations of natural and man-made disasters”. Data concerning health, that are relevant in this specific circumstance, are considered as “special categories of data”. The processing of these data is generally prohibited, unless there are specific exemptions in the GDPR or national laws. Article 9 foresees derogations to the prohibition of processing of certain special categories of personal data, such as health information,

---

<sup>6</sup> Further- the Charter

<sup>7</sup> Further- TFEU

<sup>8</sup> Further- EDPB

where it is necessary for reasons of substantial public interest in the area of public health “such as protecting against serious cross-border threats to health” on the basis of Union or national law “which provides for suitable and specific measures to safeguard the rights and freedoms of the data subject”, such as professional secrecy article (2)(i) or where there is the need to protect the vital interests of the data subject under article 9(2)(c) of GDPR. Recital 54 of the GDPR clarifies that in these circumstances - in which processing is necessary for public health reasons - processing special categories of personal data can be done without consent, but it makes clear such processing should not result in the data being processed for other purposes by third parties, such as employers or insurance companies.

Furthermore, with regard to the processing of electronic communication data, such as location data, EDPB mentions the Directive 2002/58/EC<sup>9</sup>, which allows the use of an individual's location data only if made anonymous or with the consent of the data subject. The EDPB stressed that under Article 15 of that Directive, Member States may adopt legislative provisions restricting the rights and obligations contained in the directive if such restriction constitutes a necessary, appropriate and proportionate measure within a democratic society. EDPB adds that “these measures must be in accordance with the Charter of Fundamental Rights and the European Convention for the Protection of Human Rights and Fundamental Freedoms» and should also be «strictly limited to the duration of the emergency”[7].

In conclusion, EDPB specifies that GDPR does not represent an obstacle to the efficiency of prevention and contrast of the epidemic but, at the same time, does not allow the unlimited limitation of a fundamental right. Therefore, to stop the spreading of the epidemic, technological solutions that use anonymous data should be a preferred way forward. The use of personal data will be admissible in emergency situations, however, appropriate safeguard to the right of data protection should be implemented and limited to the duration of the emergency.

After this statement, several Member States have started the process for adopting, “emergency legislation” to fight COVID 19 [13], and decided to make use of their discretionary powers to allow mobile device tracking as a measure to limit the spread of the disease. As a consequence, EU Member States have launched—or are in the process of launching— contact tracing apps to fight the spread of the virus. These initiatives are receiving great attention by general public and, in response, some EU Supervisory Authorities have issued statements in relation to such apps (*e.g.* Italy, Belgium, Germany, Spain and Slovenia). The lack of alignment of these Supervisory Authorities on the requirements and measures that public authorities and private sector bodies that want to use personal data (health data and location data) to track the spreading of COVID-19 should adopt to be comply with EU data protection principles have led EDPB to issue two new guidelines: on the processing of data concerning health for the purpose of scientific research in the context of the COVID-19 outbreak and the guideline on the use of location data and contact tracing tools in the context of the COVID-19 outbreak [8]. This last guideline underlines the difference between location data that can be used for modelling the spread of the virus and monitoring the overall effectiveness of confinement measure and contact tracing that - in order to break the contamination chains - can be used to notify individuals of the fact that they have been in close proximity of

---

<sup>9</sup> Further e-Privacy Directive. Directive 2002/58/EC of the European Parliament and of the Council of 12 July 2002 concerning the processing of personal data and the protection of privacy in the electronic communications sector (Directive on privacy and electronic communications), L 201/37 of 12.07.2002

someone who is eventually confirmed to be a carrier of the virus. Further, it clarifies the data protection conditions and principles that governments and private actors should follow when they want to use these data driven solutions as part of the response to the COVID-19 pandemic. In regard of the first scenario, the EDPB recalls that for location data collected from electronic communication providers shall only be processed in compliance with the Article 6 and Article 9 of the ePrivacy Directive. According to these articles, location data shall only be transmitted to authorities or other third parties if the user has given its consent<sup>10</sup>, or such data has been anonymized. The EDPB mention (again) that - as stipulated under Article 15 of the ePrivacy Directive – there is the possibility for Member States to restrict such provisions through emergency legislation that must be necessary, appropriate and proportionate measures within a democratic society. The Board then acknowledges that rendering data anonymous is highly complex, but suggests that options for effective anonymization of mobile phone datasets do exist. In few words, in the context of pandemic, whenever possible, the processing of anonymized location data should be preferred over the processing of identifiable data. Regarding contact tracing app EDPB doesn't seem to raise objections to the use of contact tracing apps – however – they should be subject to several measures and requirements. The EDPB underlines that such applications must s be voluntary<sup>11</sup>, should respect minimization, purpose and storage limitation principles, should not trace individual movements but rather rely on proximity information. Moreover, these apps should be subjected to a data protection impact assessment (DPIA) prior to their implementation (the EDPB also recommends the publication of the DPIA), app-related algorithms must be auditable and it is also recommended the availability of the app's source code. The EDPB states that these applications can be based on a centralized or a decentralized approach (preferred solution)<sup>12</sup>, yet, they must be based on an architecture relying as much as possible on users' devices and the patient's contact history (or its identifiers) should be transmitted to servers after the confirmation of the COVID-19 diagnosis. Furthermore, the EDPB also recommends that these apps can function without direct identification of individuals and some specific technical requirements should be put in place such as state-of-the-art cryptographic processes, or pseudonymous identifiers exchanging technology between users' mobile.

---

<sup>10</sup> This is valid only for data indicating the geographic position of the terminal equipment of a user which do not constitute traffic data (where separate rules apply)

<sup>11</sup> The Board stresses that the fact that an app is used on a voluntary basis does not necessarily mean that the relevant processing of personal data will be based on consent. Other legal bases may be relevant; in particular Article 6(1)(e) (*e.g.*, processing for the performance of a task in the public interest) may apply. To rely on these legal basis, Member States should adopt a specific legislative measure defining the purpose of the processing and appropriate safeguards. Furthermore, for the processing of special categories of data, the legal basis identified under Article 6 shall be applied only if Article 9 GDPR provides for a specific derogation from the general prohibition to process special categories of data. The EDPB considers that the appropriate Article 9 conditions for processing sensitive data in this scenario could either be that the processing is necessary for reasons of public interest in the area of public health (conditions of art. 9(2)(i) GDPR) or for health care purposes (condition under Art.9(2)(h) GDPR).

<sup>12</sup> The applications should not store any information which may identify COVID-19 positive individuals and possibly infected ones - due to epidemiologically relevant contact - in their centralized servers.

## 4. Conclusions

In this article we have discussed the convergent nature of Big Data in healthcare emergencies, such as the Covid-19 pandemics, and the interrelationship of Big Data in the light of GDPR. The authors also analysed the recent guidance issued by the EU authorities with respect to the processing of personal data for Covid-19 related tools and the strike of balance between the fundamental rights to privacy and health.

The authors of the article argued that, on the one hand, Big Data tools are extremely important when fighting various pandemics, while on the other hand, GDPR may fall short when it comes to addressing risks of Big Data analytic tools, in particular when it comes to the collective dimension of data protection rights. In this respect the authors underlined that the legislator should not only take into account the legal challenges but also address the social and ethical issues, particularly with respect to non-discrimination and the right to equal treatment.

Lastly, through the analysis of the recently issued guidelines, the authors reiterated the constant battle for the need to balance of the fundamental rights, as also noted by the EDPB. The Board underlines that EU data protection law is flexible enough to allow an efficient response to the pandemic without the erosion of individual fundamental rights. However, it notes that governments and private actors should be mindful of a number of considerations when they use data-driven solutions in response to the COVID-19 outbreak.

## 5. Acknowledgement

This project has been partially funded by the European Union's Horizon 2020 research and innovation programme under the Marie Skłodowska-Curie ITN EJD grant agreement No. 81417.

## References

- [1] Council of Europe (2019) Recommendation CM/Rec(2019)2 of the Committee of Ministers to member States on the protection of health-related data
- [2] Council of Europe, European Court of Human Rights, European Data Protection Supervisor EDA for FR (EU body or agency) (2018) Handbook on European data protection law - Publications Office of the EU
- [3] Council of Europe CC of C 108 (2017) Guidelines on the protection of individuals with regard to the processing of personal data in a world of Big Data. Strasbourg
- [4] Dion M, AbdelMalik P, Mawudeku A (2015) Big Data and the Global Public Health Intelligence Network (GPHIN). *Canada Commun Dis Rep* 41:209–214. doi: 10.14745/ccdr.v41i09a02
- [5] European Commission SWD(2015) 100 final, A Digital Single Market Strategy for Europe,
- [6] European Commission (2016) Digital4EU 2016 Stakeholder Forum Report.
- [7] European Data Protection Board (2020) Statement by the EDPB on the processing of personal data in the context of the COVID-19 outbreak, Brussels,
- [8] European Data Protection Board, Guidelines04/2020onthe use of location data and contact tracing

- tools in the context of the COVID-19 outbreak
- [9] Gartner Big Data. <https://www.gartner.com/en/information-technology/glossary/big-data>. Accessed 29 Oct 2019
- [10] Mantelero A (2016) Personal data for decisional purposes in the age of analytics: From an individual to a collective dimension of data protection. *Comput Law Secur Rev* 32:238–255. doi: 10.1016/j.clsr.2016.01.014
- [11] Micozzi FP (2020) Le tecnologie, la protezione dei dati e l'emergenza Coronavirus: rapporto tra il possibile e il legalmente consentito. *BioLaw Journal* 2:1-8. Available at: <https://www.biodiritto.org/content/download/3780/45269/version/1/file/13+Micozzi.pdf>
- [12] Mooney SJ, Pejaver V (2018) Big Data in Public Health: Terminology, Machine Learning, and Privacy. *Annu Rev Public Health* 39:95–112. doi: 10.1146/annurev-publhealth-040617-014208
- [13] Pagallo U (2020) Sovereigns, Viruses, and the Law: The Normative Challenges of Pandemic in Today's Information Societies. Available at SSRN: <https://ssrn.com/abstract=>
- [14] Roberts SL (2019) Big data, algorithmic governmentality and the regulation of pandemic risk. *Eur J Risk Regul* 10:94–115. doi: 10.1017/err.2019.6
- [15] Roberts SL (2019) Big data, algorithmic governmentality and the regulation of pandemic risk. *Eur. J. Risk Regul.* 10:94–115
- [16] Health in the 21st Century - Putting Data to Work for Stronger Health Systems - en - OECD. <https://www.oecd.org/health/health-in-the-21st-century-e3b23f8e-en.htm>. Accessed 14 Jan 2020
- [17] (2017) Resolution of 14 March 2017 on fundamental rights implications of big data: privacy, data protection, non-discrimination, security and law-enforcement (2016/2225(INI))
- [12] (2019) Health in the 21st Century. OECD

4th International Workshop on Intelligent  
Systems for Agriculture Production and  
Environment Protection (ISAPEP'20)

This page intentionally left blank



# Application of Ensemble Learning to Detect *Alternaria Solani* Infection on Tomatoes Cultivated Under Foil Tunnels

Krzysztof SMYKAŁA<sup>a,b,1</sup>, Bogdan RUSZCZAK<sup>a,b</sup> and Karol DZIUBAŃSKI<sup>a</sup>

<sup>a</sup>QZ Solutions Sp. z o.o., Ozimska 72A, Opole, POLAND

<sup>b</sup>Opole University of Technology, Prószkowska 76, Opole, POLAND

**Abstract.** Tomato is one of the most grown and the second most consumed vegetable in the world. *Alternaria solani* is recognized as the most dangerous tomato pathogen. Currently, the diagnostics of this disease requires the proper symptoms assessment of plant tissue damages. Therefore, it is necessary to propose a fast and reliable method able to assess the degree of plants' damage. Hyperspectral measurements and machine learning algorithms are one of the possibilities to address the problem of finding fast and even more important nondestructive plant diseases detection method. The presented work describes the application of two ensemble learning algorithms: Decision tree and Random Forest adapted for *Alternaria solani* detection for two varieties of tomatoes cultivated under foil tunnels. The final model was trained on the hyperspectral measurements from 350-2500nm spectral range. With a resulting accuracy of the method:0.78 and 0.98 for decision tree and random forest algorithms, respectively.

**Keywords.** *alternaria solani*, hyperspectral data, random forest, decision tree, plant disease detection

## 1. Introduction

Tomato (*Solanum lycopersicum*), a native species from South America, is one of the most grown vegetables in the world. It can be grown in various climate conditions from temperate to tropical. Tomato is the second most-consumed vegetable in the world [1]. The world production of this plant is 160 million tons. Tomatoes are a source of well absorbed vitamin C and A [2]. However, tomatoes are very vulnerable to fungal, bacterial and viral diseases such as late blight, powdery mildew or early blight. *Alternaria solani*, the cause of early blight, is commonly referred as most dangerous tomato pathogens [3]. Symptoms of the early blight are pathogenic changes on the leaves, stems, petioles and fruits. Under favorable conditions this disease may result in premature leaf drying and fruit fall, causing 30 - 80% losses in crop yield [4], [5]. Various methods are used to control *Alternaria solani* on tomato e.g. fungicide control and planting plants partially resistant to early blight. However, under high disease pressure, these methods are not sufficient for an effective protection of tomato plants [6]. Currently the diagnosis of this disease is based on assessment of the symptoms of plant tissue damage and the number

---

<sup>1</sup> Corresponding Author, Head of Research and Development at QZ Solutions Sp. z o.o., ul. Ozimska 72A, 45-310 Opole, Poland; E-mail: ksmykala@qzsolutions.pl.

of pathogen spores. Therefore, it is necessary to find fast and reliable methods for assessing the degree of damage to plants [7].

The issue of detecting plant diseases attracts the interest of many researchers, which is reflected in numerous publications [1-12]. This is also the case for researches on tomato diseases [8]–[11]. Publications describe solutions based on standard digital camera (RGB color model) [10], [12], multispectral imagery [13] and hyperspectral imagery [8], [9], [14], [15]. Many authors propose solutions based on hyperspectral measurements with spectrometer in visible, near-infrared, short wave and long wave infrared wavelengths, especially in 350-2500nm range [11], [15], [16]. Also vegetation indices can be used for detecting an early stage of plant diseases [11].

Despite of various publications on usage of machine learning algorithms for analysis of hyperspectral data for plant disease detection there is a lack of researches covering usage of these methods and data in *Alternaria solani* detections for Benito and Polfast varieties crops growing under foil tunnels in natural conditions. Admittedly, Xie *et al.* published researches on detecting *Alternaria solani* in tomato crop, however in his researches a) ELM algorithm was used and b) dataset covers hyperspectral images c) in spectral range 380-1023nm, d) taken from 1 variety (Zheza 809) of tomato e) grown in laboratory conditions [14]. For the comparison the present study covers a) Random Forest algorithm usage on dataset consist of b) hyperspectral reflectance measurements c) in spectral range 350-2500nm, d) taken from 2 varieties (Benito and Polfast) of tomato grown in field conditions (foil tunnels).

## 2. Methodology

### 2.1. Data Collection

Data used for this study was acquired on experimental fields in Poznań (Greater Poland Voivodeship, Poland) by QZ Solutions for a project co-founded by The National Center for Research and Development (POIR.01.01.01-00-1317/17). Measurements were taken by spectrometer ASD FieldSpec 4 Hi-Res Two varieties of tomato were measured – Benito and Polfast. Plants were planted on experimental fields under foil tunnels and divide into two groups – control and inoculated with *Alternaria solani*, as presented in the table 1.

**Table 1.** List of experimental fields used for this study

Field Id	Tomato variety name	Pathogen name
1	Benito	<i>Alternaria solani</i>
6	Benito	Control
13	Polfast	<i>Alternaria solani</i>
18	Polfast	Control

In order to stabilize the measurement system, ASD FieldSpec 4 Hi-Res was turned on 30 minutes before the data acquisition. Then the spectrometer was calibrated with white reference.

Dataset contains hyperspectral measurements of leaf reflectance for visible, near-infrared and short wave infrared wavelengths (350-2500nm). Spectral resolution of the data is 3nm at 700nm and 8nm at 1400/2100nm. Both leaves with and without background were included in the dataset.

### 2.2. Random Forest

Random Forest is a methods consists of multiple decision trees. Each of decision tree is a hierarchy of some true-or-false statements leading to the decision and the trees are different from each other [17]. Random Forest, as an ensemble of decision trees, shares all benefits of decision tree from one hand and making up for some of their deficiencies [17]. Decision trees are useful for visualizing of decision-making process, while Random Forest are more powerful, but hard to interpret type of a model.

Random Forest maintains high accuracy on training data and generalization accuracy [18]. This method can be used for regression and classification problems as well. Random Forest classifiers are successfully applied in agriculture for e.g. crop classification [19] and early detection and classification of tobacco leaves inoculated with TMV [20]. This method is a powerful technique that usually works well without parameters tuning and does not require data scaling. The problem presented in this study is based on learning from the measured leaf reflectance values and classifying the pattern as a leaf inoculated with *Alternaria solani* or as a health leaf. The Random Forest model used for this study is prepared with sklearn framework.

### 2.3. Experiment configuration

The measurements acquired on the field have been converted to a data frame with a structure presented in the table 2. Each data sample consists the reference information – attributes that describe the group, the variety and the disease (the information if the sample indicates a tomato with *Alternaria Solani* infection or the control group). The second group of attribues is the set of reflectance measurements, ranging from 350 to 2500 nanometers. The dataset consists of 50 samples per each group and each class. Each of those samples is a result of a set of 20 consecutive measurements taken on the field using the spectroradiometer. In the tested dataset there are 200 samples (based on 1000 measurements in total). For the purpose o later model trainings the whole dataset was split into train and test sets in proportions 75:25, respectively.

**Table 2.** Exemplary measurements extracted from training set (5 of 1000 measurements) – the columns from 352.0 to 2498.0 were removed to improve readability.

<b>Id</b>	<b>Group</b>	<b>Variety</b>	<b>Disease</b>	<b>350.0</b>	<b>351.0</b>	<b>...</b>	<b>2499.0</b>	<b>2500.0</b>
162	18	Polfast	Control	0.14639	0.20135	...	0.05620	0.05734
93	13	Polfast	Alternaria	0.13539	0.11347	...	0.23540	0.22830
103	6	Benito	Control	0.11659	0.11340	...	0.02218	0.02074
24	1	Benito	Alternaria	0.12174	0.08946	...	0.03038	0.03765
132	6	Benito	Control	0.04130	0.04471	...	0.01830	0.02289

First of all, decision tree was taken under consideration. The decision hierarchy was determined. Pre-pruning method was used to optimize model. Moreover, various pre-pruning parameters were analyzed to determine the best value of the maximum depth parameter. Feature importance analysis was carried out as well.

The second approach was the Random Forest method. An analysis of various numbers of trees in the trained model was performed. As with the decision tree approach, feature importance analysis was carried out.

### 3. Results

As mentioned before, the spectra used in this study cover the range of 350-2500 nm wavelengths with resolution of 3 nm @ 700nm and 8nm @ 1400/2100nm. Reflectance measurements was taken for four classes based on variety.

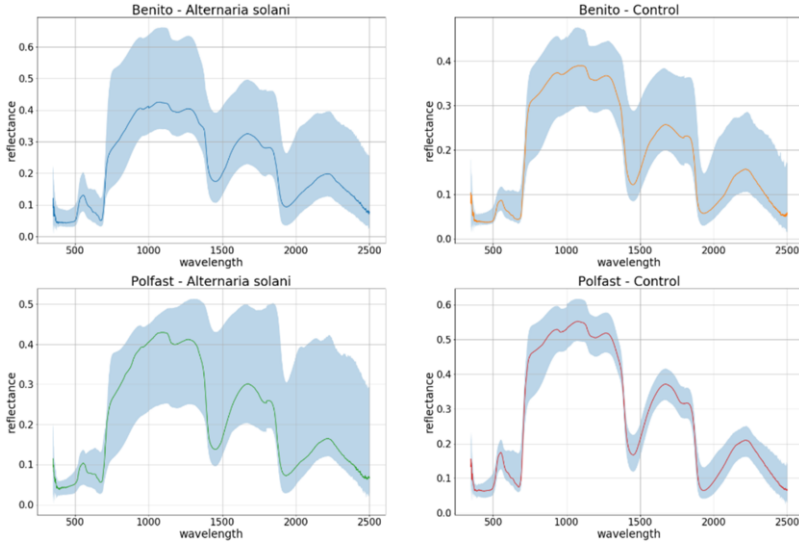

**Figure 1.** Hyperspectral representation of each group (Benito - inoculated, Benito - control, Polfast - inoculated, Polfast - control); Median of spectral data was presented as a solid line, blue background is a visualization of minimum and maximum reflectances

The first studied approach was single decision tree. A decision hierarchy was determined. For full depth tree (max\_depth=7) accuracy of train and test dataset was 1.00 and 0.78 respectively, what could mean the model is overfitted. Pre-pruning is a method for optimizing decision tree by decreasing the depth of the tree. As shown in Fig. 2, depth higher than 4 does not increase accuracy with the test dataset in this particular case.

Accuracy for train and test dataset, for parameter max\_depth=4, was ~0.91 and 0.78 respectively, so the same result on test data can be achieved with optimized tree. Feature importance analysis was performed. The most important bands in the decision process, with feature importance parameter higher than 0.1, were bands 918 and 2353. Only 7 bands were determined as important in the decision process.

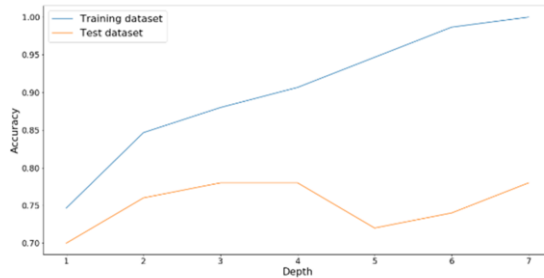

**Figure 2.** Accuracy depends on decision tree max\_depth

The second studied approach was Random Forest. The results of accuracy for train and test data was 0.99 and 0.98 respectively without any tuning. Feature importance analysis was performed. The most important bands in the decision process, with feature importance parameter higher than 0.1, were bands 905 and 982, but 32 bands were important in the decision process.

**Table 3.** Classification report of detected *Alternaria solani* and control sample

Method	Class	Accuracy	Precision	Recall	F1
Decision Tree	Alternaria	0,780	0,731	0,826	0,776
	Control		0,933	0,741	0,784
Random Forest	Alternaria	0,980	1,000	0,960	0,980
	Control		0,962	1,000	0,980

The metrics for the classification report was calculated separately for each approach. Report consist of most informative scores: accuracy, precision, recall and f1-score. The applied random forest algorithm achieved performance should be enough to correctly identify plants affected with the *Alternaria solani*. All: precision, accuracy and recall comes with great numbers.

High accuracy and F1 score were obtained. The method presented herein is not scalable, due to the use of specialized measuring equipment. However, the results encourage further research on the use of ensemble learning to detect *Alternaria solani* and other infections on tomatoes cultivated under foil tunnels. As a next stage of the research new measurements are going to be incorporated into the model to extend the detection to others diseases, such as *Phytophthora infestans*, as well as the use of other machine learning methods associated with ensemble learning.

#### 4. Conclusions

There is real need to provide a non-destructive method of plant diseases detection for tomato cultivators. The information about the type of infection can determine crop treatment methods and help farmers to prevent yield loses. In this work a preliminary model for *Alternaria solani* detection was analyzed and constructed using a Random Forest. To check if the method is able to generalize it was tested against two different tomato varieties (Benito and Polfast) cultivated under foil tunnels. The model was trained using hyperspectral measurements from 350-2500nm spectral range. The final model resulted with the accuracy and F1 score equal to 0.98, and was found satisfying, as it was able to correctly distinguish most presented cases (infected plants and control samples). In addition, feature importance analysis was performed and 32 bands were determined as most significant for the model.

As a future work, new measurements are going to be incorporated into the model to extend the detection with others diseases that also could be crucial for studied varieties.

#### Acknowledgment

This work was partially supported by The National Centre of Research and Development of Poland under project POIR.01.01.01-00-1317/17.

## References

- [1] M. R. Foolad, "Genome mapping and molecular breeding of tomato," *Int. J. Plant Genomics*, vol. 2007, 2007.
- [2] F. Böhm, R. Edge, and G. Truscott, "Interactions of dietary carotenoids with activated (singlet) oxygen and free radicals: Potential effects for human health," *Mol. Nutr. Food Res.*, vol. 56, no. 2, 2012, pp. 205–216.
- [3] W. Song, X. Ma, H. Tan, and J. Zhou, "Abscisic acid enhances resistance to *Alternaria solani* in tomato seedlings," *Plant Physiol. Biochem.*, vol. 49, no. 7, 2011, pp. 693–700.
- [4] V. V. Datar and C. D. Mayee, "Conidial dispersal of *Alternaria solani* in tomato," *Indian Phytopathol.*, vol. 35, 1982, pp. 68–70.
- [5] J. F. J. Grigolli et al., "Characterization of tomato accessions for resistance to early blight," *Crop Breed. Appl. Biotechnol.*, vol. 11, no. 2, 2011, pp. 174–180.
- [6] E. S. Rao, A. D. Munshi, P. Sinha, and Rajkumar, "Genetics of rate limiting disease reaction to *Alternaria solani* in tomato," *Euphytica*, vol. 159, no. 1–2, 2008, pp. 123–134.
- [7] C. H. Bock, G. H. Poole, P. E. Parker, and T. R. Gottwald, "Plant disease severity estimated visually, by digital photography and image analysis, and by hyperspectral imaging," *CRC. Crit. Rev. Plant Sci.*, vol. 29, no. 2, 2010, pp. 59–107.
- [8] P. Moghadam, D. Ward, E. Goan, S. Jayawardena, P. Sikka, and E. Hernandez, "Plant disease detection using hyperspectral imaging," *DICTA 2017 - 2017 Int. Conf. Digit. Image Comput. Tech. Appl.*, vol. 2017-Decem, 2017, pp. 1–8.
- [9] C. Xie, C. Yang, and Y. He, "Hyperspectral imaging for classification of healthy and gray mold diseased tomato leaves with different infection severities," *Comput. Electron. Agric.*, 2017.
- [10] S. Adhikari, E. KC, L. Balkumari, B. Shrestha, and B. Baiju, "Tomato Plant Diseases Detection System Using Image Processing," in *Kantipur Engineering College Conference*, 2018.
- [11] J. Lu, R. Ehsani, Y. Shi, A. I. de Castro, and S. Wang, "Detection of multi-tomato leaf diseases (late blight, target and bacterial spots) in different stages by using a spectral-based sensor," *Sci. Rep.*, vol. 8, no. 1, Dec. 2018, p. 2793.
- [12] S. Stadojevic, M. Arsenovic, A. Anderla, D. Culibrk, and D. Stefanovic, "Deep Neural Networks Based Recognition of Plant Diseases by Leaf Image Classification," *Comput. Intell. Neurosci.*, vol. 2016, 2016.
- [13] J. Fahrentrapp, F. Ria, M. Geilhausen, and B. Panassiti, "Detection of gray mold leaf infections prior to visual symptom appearance using a five-band multispectral sensor," *Front. Plant Sci.*, vol. 10, no. May, 2019, pp. 1–14.
- [14] C. Xie, Y. Shao, X. Li, and Y. He, "Detection of early blight and late blight diseases on tomato leaves using hyperspectral imaging," *Nat. Publ. Gr.*, pp. 1–11.
- [15] X. Wang, M. Zhang, J. Zhu, and S. Geng, "Spectral prediction of *Phytophthora infestans* infection on tomatoes using artificial neural network (ANN)," *Int. J. Remote Sens.*, vol. 29, no. 6, 2008, pp. 1693–1706.
- [16] M. Zhang and Z. Qin, "Spectral analysis of tomato late blight infections for remote sensing of tomato disease stress in California," *Int. Geosci. Remote Sens. Symp.*, vol. 6, no. February, 2004, pp. 4091–4094.
- [17] S. Guido and A. Müller, *Introduction to Machine Learning with Python: A Guide for Data Scientists*. 2017.
- [18] T. K. Ho, "The Random Subspace Method for Constructing Decision Forests," vol. 20, no. 8, 1998, pp. 832–844.
- [19] A. O. Ok, O. Akar, and O. Gungor, "Evaluation of random forest method for agricultural crop classification," *Eur. J. Remote Sens.*, vol. 45, no. 1, 2012, pp. 421–432.
- [20] H. Zhu, H. Cen, C. Zhang, and Y. He, "Early detection and classification of tobacco leaves inoculated with tobacco mosaic virus based on hyperspectral imaging technique," *2016 Am. Soc. Agric. Biol. Eng. Annu. Int. Meet. ASABE 2016*, pp. 1–7.

# Geospatial Technologies in Precision Farming: A Case Study

Md. Jashim UDDIN<sup>1,2</sup>, Peter S. HOODA<sup>2</sup>, Abdus Salam Mohammad MOHIUDDIN<sup>1</sup>,  
Mike SMITH<sup>2</sup>

<sup>1</sup>*Department of Soil, Water and Environment, University of Dhaka, Dhaka 1000, Bangladesh*

<sup>2</sup>*School of Natural and Built Environments, Kingston University London, Kingston upon Thames, KT1 2EE, United Kingdom.*

**Abstract.** The knowledge of spatial variability in soil organic carbon (SOC) is an important consideration in precision agriculture as well as site specific nutrient management. Geostatistical analyses coupled with GIS and GPS are effective tools in assessing the spatial variability and mapping of SOC. A total of 268 soil samples were collected in a systematic grid design (1-minute interval) using GPS covering four sub-districts: Delduar, Melandah, Mirpur and Fultala under two major alluviums - the Ganges and the Brahmaputra. The classical statistics showed that SOC values are normally distributed in the Fultala sub-site whereas in the other sub-sites, the SOC contents were not normally distributed. The semivariogram model also shows that the Fultala sub-site appears to have a strong structure and a gradual approach to the Gaussian model providing the best fit where as the other sites show a weak spatial dependency. Due to salinity and other constrains, Fultala sub-site bears a relatively low cropping intensity and hence tillage and crop management are much lower than the other sites. GIS based interpolated values of SOC ranged from 0.39 to 2.02 % in the Fultala sub-site. Interpolated values of SOC ranged from 0.40 to 2.60% in the Delduar sub-site, 0.40 to 1.35% in the Melandah sub-site and 0.38 to 1.39% in the Mirpur sub-site respectively. Clearly, the sites where SOC is low, a pragmatic and location-based policy should be adopted to maximize SOC sequestration. Therefore, the geospatial technologies can help better management of agricultural land by targeting management practices appropriate to the SOC levels.

**Keywords:** Geostatistics; GIS-GPS; Kriging; spatial variability; precision farming.

## 1. Introduction

Soil organic carbon (SOC) has an important influence on the physical, chemical and biological properties of soil and is critical for improving soil fertility and quality, increasing the water holding capacity of soil, reducing soil erosion, and enhancing crop productivity [1-2].

---

<sup>1</sup>Corresponding author, Md. Jashim Uddin, Department of Soil, Water & Environment, University of Dhaka, Dhaka 1000. Bangladesh; E-mail: [juswe@du.ac.bd](mailto:juswe@du.ac.bd)

With climate change and environmental issues dominating global concerns, SOC has received increasing attention worldwide because of its important role in the global carbon cycle and its potential feedback on the global warming [3-4]. Soil organic carbon and its relation to site characteristics is important in evaluating regional, continental, and global soil C stores and projecting future changes [5].

However, due to high soil heterogeneity, it is difficult to obtain an accurate assessment of SOC stock [6]. As a result, there is a considerable interest in understanding the spatial variability of SOC in different terrestrial ecosystems [7-8]. Geostatistics has been widely used to assess the spatial characteristics of SOC [9]. SOC is a determinant of SOC stock [6], and its spatial distribution is intimately related to the changes in environmental factors [10-11]. However, the relative importance of the edaphic factors as drivers or constraints of spatial heterogeneity of SOC content in the alluvial soils of Bangladesh is not well understood.

GIS is useful to produce interpolated maps for visualization, and for raster GIS maps; algebraic functions can calculate and visualize the spatial differences between the maps [12]. For studies on the spatial distribution patterns of SOC, geostatistics has been widely applied [13-15] and based on the theory of regionalized variables [16], geostatistics provides tools to quantify the spatial features of soil parameters and allows for spatial interpolation. The krigged maps of soil parameters can help to become familiar with the characteristics related to the analysed soil properties and accordingly can plan precision agricultural planning [17].

The vast majority of farmers in developing countries like Bangladesh are smallholder farmers, meaning that they grow food on a small piece of land largely to feed their families. They often make field decisions on the basis of generic recommendations or historical information rather than factual recommendations. Farming practices based on historical information often do not achieve maximum production benefits; thus, it is important that small holding farmers should follow factual/science-based recommendation. In recent years, climate change has also become a burning issue in developing countries like Bangladesh. Considering the above issues, the concept of precision can help increase crop productivity and mitigate CO<sub>2</sub> emissions by sequestering SOC.

This study makes use of GIS and GPS in combination with classical statistics and geostatistics to assess the spatial variation characteristics of SOC in the Brahmaputra and the Ganges alluviums of Bangladesh. The specific objectives of this research were to measure the SOC and to make an outline on precision farming depending on the SOC status.

## **2. Materials and Methods**

### *2.1. Soil sampling, processing and SOC analysis*

Soil samples were collected in one-minute latitude and longitude interval (1 minute = 1600 m and 1 second = 26.5 m), equating to a grid size of 1600 m. Whilst a smaller size grid would have better captured the spatial variability, resource and time



constraints prevented the use of a more intensive sampling strategy. GPS Magellan (Model: 320) was used to identify the geographic coordinates as well as sampling locations. Land and soil resource utilization guides (LSRUG) of the Soil Resource Development Institute (SRDI) were used as a base material during field visits and soil samplings. Four Upazilas or sub-sites (Delduar, Melandah, Fultala, and Mirpur) were selected across the two major alluviums of Bangladesh where they fall under the diverse agro-ecological regions. Delduar and Melandah Upazilas under the Brahmaputra alluvium covered 66 and 80 grid points respectively. Mirpur and Fultala sub-sites under the Ganges alluvium covered 96 and 26 grid points respectively. Thus, 268 soil samples were collected from the 0-30 cm depth on a grid basis across the four sub-sites. Soil samples from each sampling were collected in polythene sample bags. The bags were sealed properly precluding moisture loss from the samples and transferred as quickly as possible to the laboratory for relevant analyses. Prior to analysis, the soil samples were spread on a polythene sheet and big lumps were broken and air dried under shade. The soil samples were then gently ground by rolling a wooden rod and also with a wooden hammer, passed through a 2-mm (10 mesh) sieve, and mixed thoroughly. The samples were then preserved in plastic bags for laboratory analysis. Organic carbon in soil was determined by the wet oxidation method of [18] as described by [19].

## *2.2. Classical statistics and Spatial Analysis*

SOC variability was tested within the sub-sites where a classical statistical analysis was used. This illustrates the trends and the overall variation of the SOC variables. This test includes descriptions of the minimum, maximum, mean, skewness, kurtosis, standard deviation (SD), coefficient of variations (CVs), histogram and Q-Q plots. All the above analyses were done using the statistical package SPSS version 20.0 (SPSS Ins., Chicago, IL, USA). Geostatistical analysis, construction of semivariogram, and spatial structure of SOC variability were performed with GS<sup>+</sup> version 10.0 using Gamma Design Software, Plainwell, Michigan, USA [20]. Spatial interpolation through kriging and IDW were done with the GIS software ArcGIS version 9.3 (ESRI Inc., Redlands, California, USA). Data interpolation through kriging and Inverse Distance Weighting (IDW) were performed in ARCGIS 9.3 [21]. When the spatial structure is strong, krig interpolation was done and on the other hand, when the spatial structure is weak, then IDW interpolation was used.

## **3. Results and Discussion**

### *3.1. Classical statistics and Geostatistics*

Classical statistics of the SOC dataset of the four sub-sites are summarized in Table 1. Mean contents of SOC across the four sub-sites of the two alluviums were different and ranged from 0.69 to 1.14%. From Table 1, it may be noted that Delduar and Fultala sub-sites have very similar mean SOC values and Melandah and Mirpur sub-sites

have similar mean SOC. SOC variation is higher in the Delduar and Fultala sub-sites than the other two sub-sites. Co-efficient of variation (CV) across the four sub-sites varies from 30.9 to 47.8% indicating a moderate variability in SOC. CV values also indicate the trends in mean SOC across the four sub-sites i.e., Delduar and Fultala sub-sites have similar CV whereas Melandah and Mirpur sub-sites have similar CV. Overall, the extent of SOC variability across the sub-sites of the Brahmaputra and the Ganges alluvium soils can be considered as moderate. The moderate CV of SOC across the study sites may be due to the heterogeneity of topographic units and soil types [8].

**Table 1:** Summary statistics of SOC contents in the four subsites of the Brahmaputra and the Ganges Alluviums

Variables	SOC (%)			
	Delduar	Melandah	Fultala	Mirpur
Mean	1.14	0.75	1.13	0.69
Minimum	0.40	0.40	0.30	0.38
Maximum	2.60	1.35	2.30	1.39
SD	0.553	0.246	0.511	0.214
CV(%)	47.8	32.8	45.1	30.9
Skewness	0.30	0.27	0.44	0.25
Kurtosis	0.59	0.53	0.858	0.49

SD= Standard Deviation, CV= Coefficient of Variation,

It is important to test whether the SOC contents followed a normal distribution or not. To test this, two methods were used. First, the histograms of SOC were plotted with a normal distribution curve. This shows that SOC is positively skewed across the three sub-sites except at Fultala. Second, a Quantile-Quantile (Q-Q) plot was used, which also shows that the SOC is normally distributed only in the Fultala sub-site with a straight line. From these tests, it is important to note that SOC datasets do not fall on a straight line in the sub-sites of Delduar, Melandah, and Mirpur; thus Fultala is the only sub-site where SOC is normally distributed. In recent years, spatial dependence models of geostatistics have gained popularity as they allow the quantification of landscape spatial structure from point-sampled data. The understanding of the spatial variability of SOC levels between and within farms is very important for refining the farm management practices and implementing precision farming. The spatial dependence of SOC was determined by the semivariogram analysis. In the current study, the tested SOC in each sub-sites was modeled with linear, spherical, Gaussian or exponential semivariograms with a nugget effect. The values of the different semivariogram parameters i.e., nugget (Co), sill (C+Co), range (Ao), and nugget/sill ratio are given in Table 2. Generally, the nugget effect can be defined as an indicator of continuity at close distances.

**Table 2:** Parameters of the semivariogram models estimated for the SOC contents across the study sites

Sub sites	Model	Nugget (Co)	Sill (C+Co)	Co/C+Co	Range (Ao)	RSS*	R <sup>2</sup>
Delduar	Spherical	0.037	0.330	0.113	0.02	0.006	0.233
Melandah	Linear	0.067	0.067	1.00	0.10	0.005	0.138
Fultala	Gaussian	0.064	0.296	0.216	0.03	0.001	0.946
Mirpur	Exponential	0.029	0.058	0.499	0.07	0.002	0.055

\*RSS= Residual Sum of Squares

The semivariogram for SOC across the four sub-sites are shown in Figures 1-4. The semivariogram of the Fultala sub-site appears to have strong structure and a gradual approach to the range, with the Gaussian model providing the best fit. It shows a nugget (Co) of 0.064; a sill (C+Co) equal to 0.296; range (Ao) equal to 0.03; coefficient of determination (R<sup>2</sup>) of 0.946; and a residual sum of squares (RSS) equal to 0.001. This semivariogram appears to exhibit a pure nugget effect, possibly because of a too sparse sampling to adequately capture autocorrelation. On the other hand, the other three sub-sites (Delduar, Melandah and Mirpur) show similarity to the Fultala sub site regarding the nugget effect, sill, range and RSS. However, the coefficient of determination (R<sup>2</sup>) clearly shows that SOC datasets at these three sub-sites do not adequately fit to any of the semivariogram models. The lowest RSS value is one of the criteria of selecting the best fitted models [22]. In the case of Fultala, R<sup>2</sup>, RSS and nugget-to-sill ratio reveal that at this sub site SOC is strongly spatially dependent (Table 2). The other sub sites i.e., Delduar, Melandah, and Mirpur, show a weak spatial dependency as they have R<sup>2</sup><0.5.

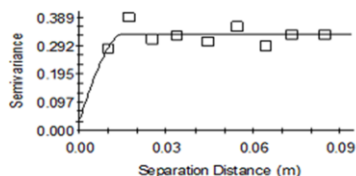
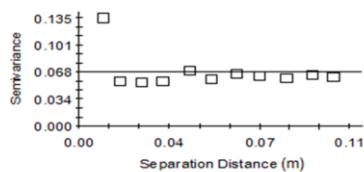
**Figure 1:** The semivariogram model of SOC at the Delduar sub-site of the Brahmaputra alluvium**Figure 2:** The semivariogram model of SOC at the Melandah sub-site of the Brahmaputra alluvium

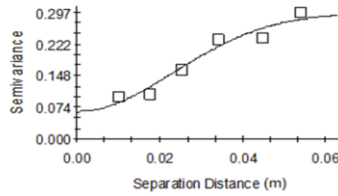

**Figure 3:** The semivariogram model of SOC at the Fultala sub-site of the Ganges alluvium

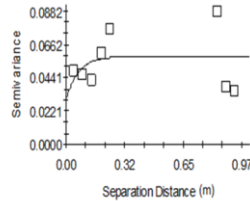

**Figure 4:** The semivariogram model of SOC at the Mirpur sub-site of the Ganges alluvium

Spatial variability of soil properties may be affected by both intrinsic i.e., soil forming factors such as parent materials and extrinsic factors i.e., soil management practices such as fertilization, tillage and general soil management practices [23]. They also added that strong spatial dependency of SOC can be attributed to intrinsic factors whereas weak spatial dependency can be attributed to extrinsic factors. Thus, the strong spatial dependence of SOC across the Fultala sub-site may be attributed by the structural or intrinsic factors which is governed by the larger resolution sampling design. The structural or intrinsic factors are the topographic units, SOC contents, mineral composition and soil type, etc. The possible causes of spatial variability in SOC may be the topographic land units and soil types, though other factors such as land use and management are also associated. The spatial variation in SOC may be partly attributed to the complex topography in the landscape [8]. The Fultala sub-site occupies three diverse physiographic units, Ganges tidal floodplain i.e., saline soils, peat soils with high SOC contents and non-saline soils. Due to its inherent low fertility nature [24], this sub-site bears a relatively low cropping intensity. Hence, tillage and crop management activities are much lower than any other sites.

As a result, the spatial structure of SOC in the Fultala sub-site is not influenced by the soil fertilization and cultivation practices. As such, the spatial dependence remains strong in this sub-site. On the other hand, agricultural activities (such as tillage, irrigation practices; and land use intensification by higher cropping intensity), are the random factors which prevail across the other three sub-sites. Thus, it would appear that the SOC in the three sub-sites lacks spatial dependence. This is possibly attributed due to extrinsic factors of soil fertilization, which weakened their spatial correlation after a long history of cultivation. The weak spatial dependence of SOC across the Delduar, Melandah and Mirpur sub-sites is likely attributed by the human activities

such as tillage, cropping system management, irrigation practices, land use cover, manure and fertilizer, crop residue management and cropping intensity etc. [25].

### 3.2. Spatial Interpolation of SOC

In order to apply agricultural practices precisely and appropriately, it is important to investigate the spatial distribution of SOC across the four sub-sites. The parameters derived from the geostatistical models were used for kriging and inverse distance weighted (IDW) i.e., spatial interpolation by which spatial distribution maps of SOC across the study sites were produced (Figures 5-8). The maps of SOC distribution clearly show how the predicted values are spatially distributed. The interpolated kriging map for Fultala (Figure 5) shows a strong spatial dependence. SOC concentration in this sub-site decreased from south to north, which was apparently related to the nature of soil and topographic conditions. On the other hand, weighted interpolation SOC maps were prepared for the other three sub-sites (Figures 6-8) which showed weak spatial dependence. It may be noted that weighted interpolation is used where data have weak spatial dependence or no spatial dependence. IDW is based on values at nearby locations weighted only by distance from the interpolation location, Bulls eye effect was found in this IDW datasets. Thus, IDW helps to compensate for the effects of data clustering, assigning individual points within a cluster less weight than isolated data points or treating clusters more like single points. IDW-interpolated maps for the other three sub-sites indicate that the spatial structure is dispersed due to the continuous management of the soil resources i.e., a weak SOC spatial dependency. Besides, it should be mentioned that the SOC were concentrated in some particular areas or land types of the Delduar, Melandah and Mirpur sub-sites which may be due to their local variability of land types and differences in land management practices and intensities.

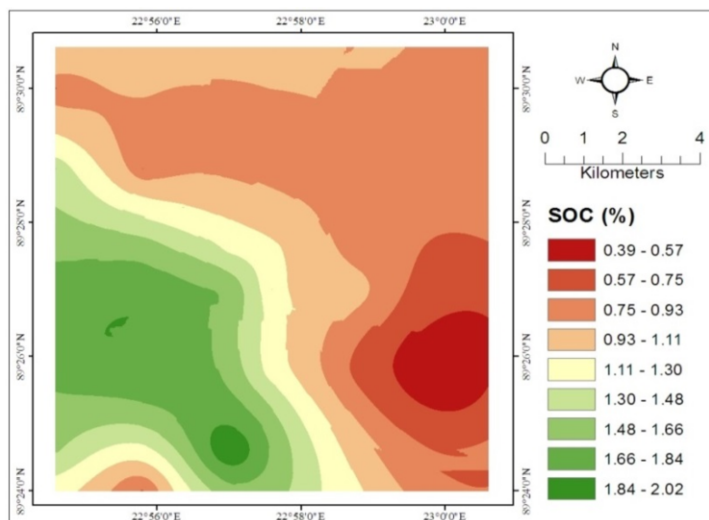

**Figure 5:** Distribution of SOC contents (%) in the Fultala sub-site using Kriging

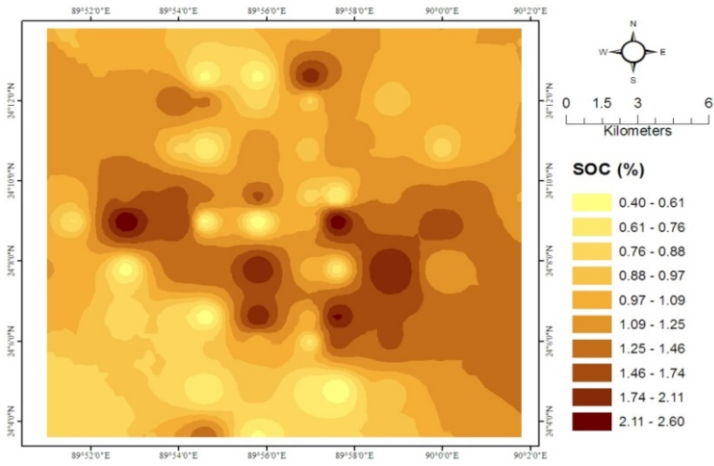

Figure 6: Distribution of SOC contents (%) in the Delduar sub-site using IDW

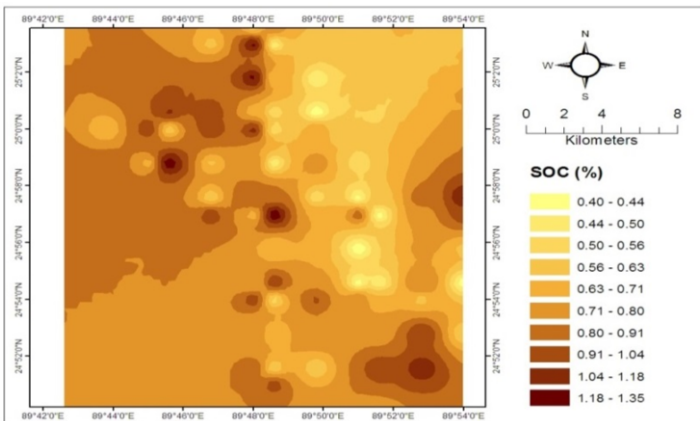

Figure 7: Distribution of SOC contents (%) in the Melandah sub-site using IDW

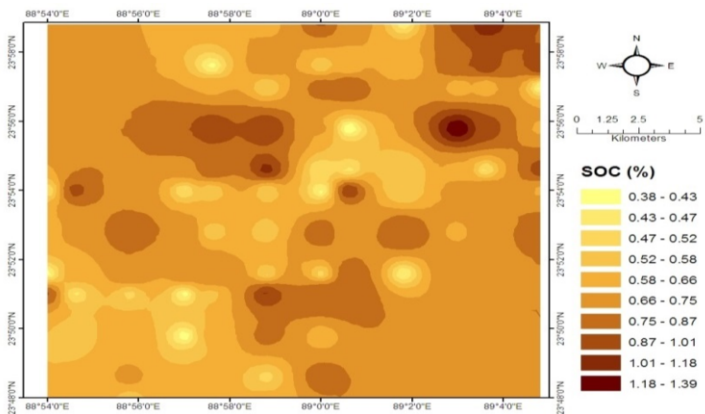

Figure 8: Distribution of SOC contents (%) in the Mirpur sub-site using IDW

In this study, the weak spatial dependent sites possess a relatively flat topography (only 2 m elevation variation), the SOC distribution should not only be linked to water erosion processes, but also to tillage erosion. Indeed, widespread adoption of mechanized agriculture that promotes more intensive continuous tillage accelerates SOC oxidation [26] and predisposes soils to increased erosion [27]. Tillage, especially the conventional 30-cm deep tillage, is one of the major practices that affects SOC. Tillage thus accelerates runoff during the rainy season and destroys natural soil aggregates. This traditional tillage does not leave any residues on the soil surface to reduce rainfall erosivity. Thus, conventional tillage reduces SOC, weakens soil structure, ultimately causing soil compaction and sealing -affecting soil porosity, aeration and decomposition of organic matter that exacerbates the soil pulverization during the dry periods which are also reported in case of conventional tillage [28]. Interpolated values of SOC in the surface layer (0-30 cm), obtained by kriging ranged from 0.39 to 2.02% in the Fultala sub-site (Figure 5). The highest SOC tended to occur in the Fultala sub-site, where the landscape is diverse with low cropping intensity. This sub-site belongs to the south-western coastal plain of Bangladesh where the major land use is the rice-shrimp integrated farming. This topographic diversity mainly causes high variability in SOC. SOC levels are generally reflecting the intensity of agriculture and land management practices [29]. On the other hand, SOC interpolated by IDW ranged from 0.40 to 2.60% in the Delduar sub-site, 0.40 to 1.35% in the Melandah sub-site and 0.38 to 1.39% in the Mirpur sub-site respectively (Figures 6-8). The lower SOC levels in these sub-sites may be attributed to more intensive cropping with high yielding varieties (HYV) of rice.

#### 4. Conclusion

Understanding the spatial variability of SOC is important for best soil management and targeted precision farming practices. The findings revealed that the SOC is low in all study sites. Agricultural activities such as excessive tillage, improper cropping system management, land use intensification by high inputs, etc. are the random factors that prevail which may be responsible for the weak spatial dependence after a long history of agricultural use. While reducing cropping intensity is difficult given the need to increase food production better crop residue management and reduced tillage should be considered to increase SOC levels. It is important to initiate location-based policy to maximize SOC sequestration as well as precision farming in Bangladesh and other similar climatic and framing situations to restore soil health and agricultural productivity at farm level.

#### References

- [1] Rossi J, Govaerts A, De Vos B, Verbist B, Vervoort A. Spatial structure of soil organic carbon in tropical forest-A case study of Southeastern Tanzania. *Catena*. 2009;77:19-27.
- [2] Wang DD, Shi XZ, Wang HJ, Weindorf DC, Yu DS, Sun WX, Ren HY, Zhao YC. Scale effect of climate and soil texture on soil organic carbon in the uplands of northeast China. *Pedosphere*. 2010;20:525-535.

- [3] Davidson EA, Janssen IA. Temperature sensitivity of soil carbon decomposition and feedbacks to climate change. *Nature*. 2006;41:12-15.
- [4] Su ZY, Xiong YM, Zhu JY, Ye YC, Ye M. Soil organic carbon content and distribution in a small landscape of Dongguan, South China. *Pedosphere*. 2006;16:10-17.
- [5] Feng Q, Endo KN, Cheng GD. Soil carbon in desertified land in relation to site Characteristics. *Geoderma*. 2002;106:21-43.
- [6] Don A, Schumacher J, Scherer-Lorenzen M, Scholten T, Schulze ED. Spatial and vertical variation of soil carbon at two grassland sites- implications for measuring soil carbon stocks. *Geoderma*. 2007;141:272-282.
- [7] Arrouays D, Deslais W, Bateau V. The carbon content of topsoil and its geographical distribution in France. *Soil Use and Management*. 2001;17:7-11.
- [8] Liu DW, Wang ZM, Zhang B. Spatial distribution of soil organic carbon and analysis of related factors in croplands of the black soil region, Northeast China. *Agriculture, Ecosystems and Environment*. 2006;113:73-81.
- [9] Evrendilek F, Celik I, Kilic S. Changes in soil organic carbon and other physical soil properties along adjacent Mediterranean forest, grassland, and crop land ecosystems. *Journal of Arid Environments*. 2004; 59:743-752.
- [10] Wheeler CW, Archer SR, Asner GP. Climatic/edaphic controls on soil carbon/nitrogen response to shrub encroachment in desert grassland. *Ecological Applications*. 2007;17:1911-1928.
- [11] Throop HL, Archer SR. Shrub (*Prosopis velutina*) encroachment in a semi-desert grassland: Spatial-temporal changes in soil organic carbon and nitrogen pools. *Global Change Biology*. 2008;14:2420-2431.
- [12] Wang ZM, Zhang B, Song KS, Liu DW, Li F, Guo ZX, Zhang SM. Soil organic carbon under different landscape attributes in croplands of Northeast China. *Plant, Soil and Environment*. 2008;54:420-427.
- [13] Saldana A, Stein A, Zinck JA. Spatial variability of soil properties at different scales within three terraces of the Henare River (Spain). *Catena*. 1998;33:139-153.
- [14] McGrath D, Zhang CS. Spatial distribution of soil organic carbon concentrations in grassland of Ireland. *Applied Geochemistry*. 2003;18:1629-1639.
- [15] Sepaskhah AR, Ahmadi SH, Nikbakht Shahbazi AR. Geostatistical analysis of sorptivity for a soil under tilled and no-tilled conditions. *Soil and Tillage Research*. 2005;83:237-245.
- [16] Webster R, Oliver MA. *Geostatistics for Environmental Scientists*. 2nd edition; John Wiley and Sons Ltd, UK. 2007. 299 p.
- [17] Ramzan S, Wani MA, Bhat MA. Assessment of spatial variability of soil fertility parameters using spatial techniques in temperate Himalayas. *International Journal of Geosciences*. 2017;8:1251-1263.
- [18] Walkley A, Black IA. An examination of the Degtjareff method for determining soil organic matter and a proposed modification of the chromic acid titration method. *Soil Science*. 1934;37:29-38.
- [19] Nelson DW, Sommers LW. Total carbon, organic carbon and organic matter. In: Page AL, Miller RH, Keeney DR, eds. *Methods of Soil Analysis*. Part 2. Agronomy monograph, 2nd edition, ASA and SSSA. Inc. Madison, Wisconsin, USA; 1982. p. 539- 577.
- [20] Robertson GP. *GS+: Geostatistics for the environment sciences*. GS+ user's guide version 10.0. Plainwell, Gamma design software; 2008. 200 p.
- [21] ESRI, Environmental Systems Research Institute, *ARCGIS ver. 9.3*. Redlands, USA; 2000. 198 p.
- [22] Robinson TP and Metternicht G. Testing the performance of spatial interpolation techniques for mapping soil properties. *Computers and Electronics in Agriculture*. 2006;50(2):97-108.
- [23] Cambardella CA, Moorman TB, Novok JM, Parkin TB, Karlen DL, Turco RF, Konopka AE. Field-scale variability of soil properties in Central Iowa soils. *Soil Science Society of America Journal*. 1994;58:1501-1511.
- [24] FRG. *Fertilizer Recommendation Guide*. Bangladesh Agricultural Research Council (BARC). 2018. 274 p.
- [25] Kilic K, Ozgoz E, Akbas F. Assessment of spatial variability in penetration resistance as related to some soil physical properties of two fluvents in Turkey. *Soil and Tillage Research*. 2004;76:1-11.
- [26] Polyakov VO, Lal R. Soil organic matter and carbon di oxide emission as affected by water erosion on field runoff plots. *Geoderma*. 2008;143:216-222.
- [27] Rasmussen PE, Albrecht SL, Smiley RW. Soil carbon and nitrogen changes under tillage and cropping systems in the Semi-arid Pacific North-west agriculture. *Soil and Tillage Research*. 1998;47:197-205.
- [28] Bot A, Benites J. The importance of soil organic matter: key to drought-resistance soil and sustained food production. *Food and Agriculture Organization of the United Nations, FAO*. Rome. 2005; FAO Soil Bulletin 80.
- [29] Uddin MJ, Hooda PS, Mohiuddin ASM, Smith M, Waller M. Land inundation and cropping intensity influences on organic carbon in the agricultural soils of Bangladesh. *Catena*. 2019;178:11-19.



# Towards the Characterization of Agricultural Regions Based on Weather Conditions - Sustainable Agriculture

Jose M. CADENAS<sup>a,1</sup>, M. Carmen GARRIDO<sup>a</sup> and Raquel MARTÍNEZ<sup>b</sup>

<sup>a</sup>*Dept. of Information and Communication Engineering, University of Murcia, Spain*

<sup>b</sup>*Dept. of Computer Engineering, Catholic University of Murcia, Spain*

**Abstract.** Nowadays, precision agriculture has acquired an important role in improving the existing problems in this domain, allowing to increase agricultural production and, therefore, the economic profits derived from it. The general objective of precision agriculture is to help and/or improve decision making regarding the quality, productivity, profitability, resource efficiency and sustainability of agricultural production. One way to carry out this objective is to analyze how suitable a type of crop is in the geographical area in which it is located. In this work, an Intelligent Data Analysis process is used and the study that should lead us to obtain knowledge of geographic regions with similar characteristics from climate viewpoint is started. This should allow us to advise farmers in areas with weather conditions that will cause a lower yields, which types of crops will lead to higher yields and could be well suited to their areas because they are getting good yield in zones with similar weather conditions.

**Keywords.** Precision Agriculture, Intelligent Data Analysis, Sustainable Agriculture, Clustering Analysis

## 1. Introduction

In the agricultural sector, numerous decisions are made every day with the aim of obtaining the best possible yield from crops, both in terms of productivity and the resources necessary to obtain a good production. Nowadays, it is important to support this decision making in the large amounts of data that are being stored from the agricultural environment. This general objective can be achieved by carrying out the grouping of regions with similar weather conditions and then making a yield analysis of each region to advise the farmer of the regions with the worst yield, the kind of cultivation of the regions with a more optimal yield. This can be done by applying an Intelligent Data Analysis process (IDA process) to the large amounts of available data from crops, soils and weather stations that allow a non-experimental data analysis to optimize production and make agriculture more resilient to climate change.

In this work, groupings of regions from different areas of the Region of Murcia (south-east of Spain) are found by means of a clustering technique from the data collected

---

<sup>1</sup>Corresponding Author, E-mail: jcadenas@um.es

from various weather stations. With the preliminary results obtained in this work, in subsequent works an improvement of the IDA process will be carried out, transferring it to the Softcomputing framework that will allow us to deal with imperfect data and, therefore, to express in a more correct way the true nature of the data.

The structure of the work is as follows: In Section 2 works that try to solve problems in agriculture using clustering techniques are reviewed. In Section 3 the clustering technique used to find the region groupings is introduced. In Section 4 the description of both the data used and the results obtained when applying the technique are shown. In Section 5 the different future works to be carried out based on the preliminary results obtained in this work are indicated. Finally Section 6 shows the conclusions of the results obtained.

## **2. Clustering in precision agriculture problems**

Precision agriculture addresses a wide range of agricultural problems with the aim of making crops more sustainable, enabling farmers to maximise their profits and reduce their losses. One of the tools that precision agriculture uses to predict and help to make decisions is machine learning techniques [1]. This work focuses on clustering techniques mainly, with the aim of grouping and differentiating agricultural areas to address problems such as irrigation or inclement weather, among others.

The most common problem faced by the farmers is they do not opt crop based on the necessity of soil and weather conditions, as a result they face serious setback in productivity. This problem can be addressed through precision agriculture. This strategy takes into account several parameters, viz: soil characteristics and types, weather conditions and crop yield. Data collection based on these parameters suggesting the farmer suitable crop to be cultivated. Precision agriculture helps in reduction of non suitable crop which indeed increases productivity, apart from the following advantages like efficacy in input as well as output and better decision making for farming. In this framework, different contributions have been made in recent years. For example, the spatial-temporal change in agricultural distribution in Thailand is analyzed in [2] during the period 2007-2015 using cluster, outlier and hot spots analysis. The conclusions, and main objectives of the analysis, are to support and contribute to the strengthening of energy and food security through adaptation or survival to climate change for the period 2015-2021.

The authors of [3] address the problem of Indian farmers who do not choose to cultivate according to the need for the soil, and therefore face a serious decline in productivity. They propose a system of recommendation through a majority voting assembly model using techniques such as random tree, k-neighbor and naive bayes to recommend a suitable crop.

In [4], the aim is to predict the rain periods for agricultural applications. This method joins years with similar pluviometric characteristics, with the purpose of finding early a pattern that can define the behavior of the distribution of rainfall between the current year. The method was used operationally during the ENSO phenomenon of 1997-1998, and insubordinated to climatological studies. These have allowed different groups of growers to make climate forecasts for the development of their activities.

In [5], a general study and a comparative study on different types of clusters is carried out to group different cultivation areas. Specifically, the evaluation was carried out with data obtained between 2010 and 2015 from three commercial agricultural elders

cultivated with soybean and maize in Brazil. In general, the behaviour of all clustering algorithms was satisfactory for the purpose indicated.

### 3. IDA process based on a clustering technique

Cluster analysis is one of the most outstanding descriptive tasks in the IDA process. The idea is to partition a dataset into groups with similar characteristics. It is an unsupervised task and the groups obtained could be considered as classes.

In this work is proposed the use of the CMEANS clustering algorithm [6] with a heterogeneous distance measure that will allow us working with the nominal and numeric attributes described. In the next Subsection the CMEANS algorithm is described.

#### 3.1. CMEANS Algorithm

A clustering algorithm groups a dataset  $E$  into  $c$  partitions trying to keep the data within the same cluster as close as possible and the clusters as far as possible. The objective function plays an important role in a clustering algorithm. Given a dataset  $E = \{x^1, x^2, \dots\}$ , where each instance is described by  $n$  attributes  $x^i = \{x_1^i, x_2^i, \dots, x_n^i\}$ , in the CMEANS Algorithm the objective function to be minimized is defined using the Euclidean distance  $J_{CMEANS} = \sum_{j=1}^{|E|} \sum_{i=1}^c d(x^j, v^i)$  where  $c$  is the number of clusters,  $|E|$  is the number of available instances,  $v^i = (v_1^i, v_2^i, \dots, v_n^i)$  is the cluster center  $i$ , and  $d(x^j, v^i)$  is a function measuring the distance between the instance  $x^j$  and the cluster center  $v^i$ .

The main steps are shown in the Algorithm 1.

#### Algorithm 1. CMEANS Algorithm

**Input** Dataset  $E$ , Value  $c$ ;  $1 \leq c \leq |E|$

Initialize randomly the cluster centers vector  $v$

**while**  $v^i(t) - v^i(t-1) > \epsilon$  **do**

    Calculate the index sets  $I^i$ ;  $i = 1, \dots, c$  composed with the set of instance indexes that are closer to the cluster center  $v^i$  than to any of the other cluster centers.

    Recalculate the cluster centers according to  $v^i = \frac{\sum_{j \in I^i} x^j}{|I^i|}$

**end while**

As it was previously commented, in this work a heterogeneous distance function is used because the instances can be described by attributes with nominal and numeric values and the cluster centers too,  $F(x^j, v^i) = \frac{\sum_{k=1}^n f(x_k^j, v_k^i)}{n}$  where:

- If attribute  $k$  is nominal:  $f(x_k^j, v_k^i) = 1 - \frac{Card(x_k^j \cap v_k^i)}{Card(x_k^j \cup v_k^i)}$  where  $e_{v_k^i}^j, v_k^i$  are crisp/fuzzy nominal values and  $Card(x_k^j \cap v_k^i)$  and  $Card(x_k^j \cup v_k^i)$  are defined as the cardinality crisp subsets obtained by the union and intersection of  $x_k^j$  and  $v_k^i$ , respectively.
- If attribute  $k$  is numeric:  $f(x_k^j, v_k^i) = |x_k^j - v_k^i|$ , where  $x_k^j$  and  $v_k^i$  are numeric values.

The update of the cluster centers from the crisp partition  $I_i$  is carried out as follows, where  $|I_i|$  is the number of instances belonging to cluster  $i$ :

If attribute  $k$  is nominal:  $v_k^i = \frac{1}{|I_i|} \bigcup_{x^j \in I_i} x_k^j$  or, if it is numeric:  $v_k^i = \frac{1}{|I_i|} \sum_{x^j \in I_i} x_k^j$

## 4. Experiments, analysis and discussion

### 4.1. Information collection and data preparation

This study analyses the Autonomous Community of the Region of Murcia (Spain). The used information is obtained from the Agricultural Information Service (SIAM, <http://siam.imida.es>) which depends on the Murcian Institute of Agricultural and Food Research and Development. The Region covers the following areas and municipalities:

- Altiplano – Yecla, Jumilla, Abanilla and Fortuna.
- Noroeste – Moratalla, Caravaca de la Cruz, Cehegín and Bullas.
- Río Mula – Mula, Pliego, Albudeite and Campos del Río.
- Vega del Segura – Murcia, Beniel, Santomera, Alcantarilla, Molina de Segura, Torres de Cotillas, Alguazas, Ceutí, Lorquí, Archena, Ulea, Villanueva del Segura, Ojós, Ricote, Blanca, Abarán, Cieza and Calasparra.
- Valle del Guadalentín – Lorca, Puerto Lumbreras, Águilas, Mazarrón, Totana, Aledo, Alhama de Murcia and Librilla.
- Campo de Cartagena – Fuente Álamo, Cartagena, Unión (La), Torre Pacheco, San Javier, San Pedro del Pinatar and Alcázares (Los).

Many of these areas focus on agriculture (fruit and vegetables), which represents a strategic sector in the economy of this Region [7]. A crucial aspect in this economy is the agro-food production for export, since it represents a percentage of more than 50% of the regional market. Of the total area of the region, 50% is used for cultivation (67% as dry land and 33% as irrigated land). Figure 1 shows the regional agricultural production differentiating by percentage each kind of crop.

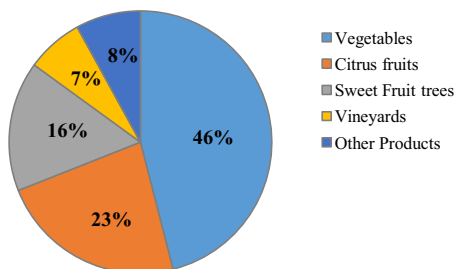
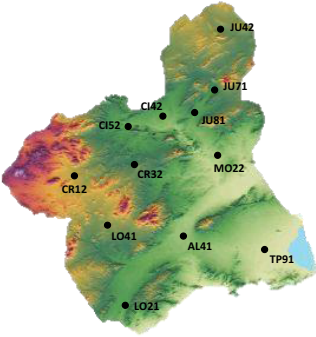

**Figure 1.** Regional agricultural production of different types of crops in the Region of Murcia, Spain

The data collected correspond to 12 weather stations (see Table 1). Each station is equipped with the following sensors and ephemeris: weather vane, radiometer, rain

gauge, data-logger and thermo-hygrometer. The information collected corresponds to 4 years during the periods from 01/12/2016 to 31/03/2019 (approximately the meteorological winter). The initial data obtained from SIAM sensors correspond to values obtained every 5 minutes and these are grouped 12 by 12 to show only values for each hour. For this reason, some of the measurements show the minimum, mean and maximum values for each hour. The type of information obtained is shown in the Table 2. It is important to clarify two measures that have no units, specifically the measure Sunlight is a boolean that indicates whether there is sun or not, while Cooling units is a measure calculated to indicate the hours of cold that support/need crops.

**Table 1.** Description of the weather stations in study of the Region of Murcia, Spain.

Station CR12 (Noroeste) – Altitude 869m Coordinate: 38° 2' 38.24" – 1° 58' 48,67"	
Station CR32 (Noroeste)– Altitude 433m Coordinate: 38° 6' 39" – 1° 19' 27.58"	
Station JU71 (Altiplano) – Altitude 401m Coordinate: 38° 23' 40,01" – 1° 14' 21,58"	
Station JU81 (Altiplano) – Altitude 341m Coordinate: 38° 19' 11,3" – 1° 19' 27,58"	
Station JU42 (Altiplano) – Altitude 658m Coordinate: 38° 39' 31,9" – 1° 11' 8,73"	
Station CI52 (V. Segura) – Altitude 275m Coordinate: 38° 15' 12.59" – 1° 41' 41,89"	
Station CI42 (V. Segura) – Altitude 244m Coordinate: 38° 17' 2" – 1° 29' 46,84"	
Station MO22 (V. Segura) – Altitude 146m Coordinate: 38° 7' 39,04" – 1° 13' 14,36"	
Station TP91 (C. Cartagena) – Altitude 56m Coordinate: 37° 44' 51,81" – 0° 59' 12,02"	
Station AL41 (V. Guadalentín) – Altitude 169m Coordinate: 37° 47' 32,05" – 1° 25' 39"	
Station LO21 (V. Guadalentín) – Altitude 356m Coordinate: 37° 30' 13.86" – 1° 41' 38,07"	
Station LO41 (V. Guadalentín) – Altitude 693m Coordinate: 37° 18' 72" – 1° 49' 6,62"	

**Table 2.** Information collected every hour for each station.

Weather station code	Mean wind direction (°) (meWD)	Cooling units (Hf.R)
Min. relative humidity (%) (miRH)	Mean relative humidity (%) (meRH)	Max. relative humidity (%) (maRH)
Sunlight (s)	Rainfall (mm) (R)	Accumulated radiation (W/m <sup>2</sup> ) (AR)
Mean radiation (W/m <sup>2</sup> ) (meR)	Max. radiation (W/m <sup>2</sup> ) (maR)	Mean wind run (km in to hour) (WR)
Min. temperature (°C) (miT)	Mean temperature (°C) (meT)	Max. temperature (°C) (maT)
Mean wind speed (m/s) (meWS)	Max. wind speed (maWS) (m/s)	

#### 4.2. Datasets, evaluation and analysis of experiments

For this initial study, all measured attributes are used, where for attributes with several values for the same measurement (min, med, max) we will use the mean value attribute. The domain of these attributes is shown in Table 3 (the nomenclature of each attribute corresponds to the information reflected in Table 2).

Therefore, the dataset has 104544 instances with 10 attributes joint to the station code. The CMEANS algorithm is used by varying the number of clusters *c*. CMEANS is executed using the following parameters:  $\epsilon = 0.001$  and *c* taking values from 1 to 15. Evaluation and analysis of the clusters is performed using the following:

**Table 3.** Dataset information

Instances number	104544	Per station 8712					Attributes number 10 + 1 (station)				
Attributes information	meWD	Hf_R	meRH	S	R	AR	meR	WR	meT	meWS	
Numeric	{Minimum	0	-1	5.57	-	0	0	0	0	-9.75	0
	{Maximum	360	1	99.98	-	33	4.22	1173.17	1.76	40.45	11.72
Nominal	S	values {yes,no}									

- Elbow Method: The behavior of the function  $J_{CMEANS}$  is evaluated and analyzed. A point (or zone of points) is located, the so-called elbow, where the improvement of the function  $J_{CMEANS}$  begins to stabilize.
- The attribute of the stations. To analyse each group of the selected cluster we will use the labels of the stations in order to check similar behaviours with respect to different cultivation areas.

4.3. Results of the experiments

Executing the CMEANS algorithm for the different values of  $c$ , the following values of the function  $J_{CMEANS}$  are obtained together with the graph of its behavior (Table 4).

**Table 4.** Behavior of the function  $J_{CMEANS}$  according to the parameter  $c$

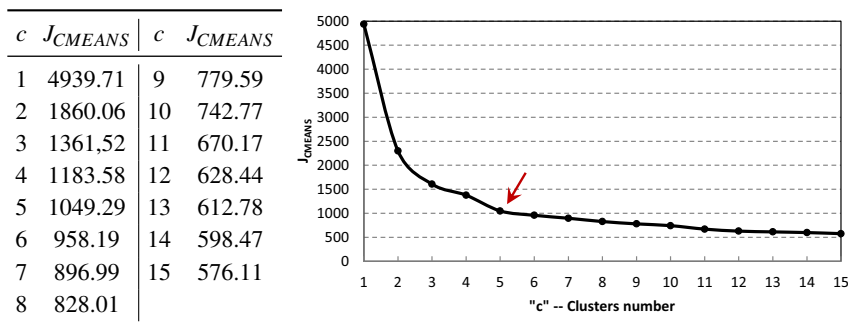

In the figure of Table 4 the size of the cluster  $c = 5$  is highlighted, which indicates the area where the function  $J_{CMEANS}$  is stabilized. The size in instances of the groups of this cluster is the following (in parenthesis the percentage that represents with regard to the total of the dataset): Group 1 = 16029 (14.62%), Group 2 = 16978 (16.24%), Group 3 = 16699 (15.97%), Group 4 = 17471 (16.71%) and Group 5 = 37367 (35.74%).

4.4. Analysis and discussion of the experiments

Table 5 shows the characteristics of the groups according to the values of the attributes. To analyze the results, the domains of the numerical attributes meRH, R, AR, meR, WR, meT and meWS are partitioned in 5 equal parts to discretize them in 5 labels; the domain of the wind direction attribute (meWD) is partitioned using the cardinal points; and the attribute Hf\_R is partitioned with three labels to collect the information that indicates how the temperature is inducing in the rest of the annual cycle of many plants (in particular, the fruit trees). Table 6 displays the different centroids of the cluster with 5 groups by means of the labels of the different centroids.

**Table 5.** Centroids of the 5 groups of the cluster

Group	meWD [0,360]	Hf_R [-1,1]	meRH [5.57,99.98]	S {Y,N}	R [0,33]	AR [0,4.22]	meR [0,1173.17]	WR [0,1.76]	meT [-9.75,40.45]	meWS [0,11.72]
1	253.44	0.20	48.79	N	0.019	0.13	15.10	0.38	12.16	2.52
2	205.12	-0.50	36.95	Y	5.0E-4	1.80	508.83	0.39	17.33	2.59
3	157.86	0.69	75.82	N	0.06	1.78	7.88	0.24	6.60	1.64
4	196.20	0.50	59.70	Y	0.01	1.32	323.46	0.29	10.16	1.93
5	221.01	0.71	77.65	N	0.08	0.02	5.73	0.13	6.05	0.85

**Table 6.** Centroids with labels: VS-very small, S-small, M-medium, L-large, VL-very large; for MeWD, N∈[337.5°,22.5°], NE∈[22.5°,67.5°], E∈[67.5°,112.5°], SE∈[112.5°,157.5°], S∈[157.5°,202.5°], SO ∈[202.5°,247.5°], O∈[247.5°,292.5°], NO∈[292.5°,337.5°]; for Hf\_R, P∈[0,4,1], C∈[-0,2,0,4], N∈[-1,-0,2]

Group	meWD	Hf_R	meRH	S	R	AR	meR	WR	meT	meWS
1	O	C	M	No	VS	VS	VS	S	M	S
2	SO	N	S	Yes	VS	M	M	S	M	S
3	S	P	L	No	VS	M	VS	VS	S	VS
4	S	P	M	Yes	VS	S	S	VS	S	VS
5	SO	P	L	No	VS	VS	VS	VS	S	VS

In addition, the information collected from the different groups with respect to the 12 stations is the following:

- a. Group 5 is the most important with 35.74% of the total instances, and includes the following stations, where the percentage of the instances included of each station is indicated: CR12 (53.55%), JU71 (43.81%), JU81 (48.46%), MO22 (34.62%), CI42 (46.15%), CI52 (51.86%), CR32 (53.76%), AL41 (46.44%) and TP91 (50.25%).
- b. Group 3 (15.97% of instances). This group includes the stations: JU42 (64.12%), LO21 (62.90%) and LO41 (64.66%).
- c. Group 1 (14.62% of instances). This group includes the stations: CR12 (13.54%), JU71 (23.27%), JU81 (19.43%), MO22 (32.70%), CI42 (20.57%), CI52 (16.06%), CR32 (13.57%), AL41 (20.26%) and TP91 (16.05%).
- d. Group 2 (16.24% of instances) contains all stations: CR12 (9.77%), JU42 (10.38%), JU71 (16.30%), LO21 (16.37%), JU81 (15.99%), MO22 (20.44%), CI42 (19.33%), CI52 (17.94%), CR32 (15.53%), AL41 (20.35%), LO41 (12.88%) and TP91 (19.61%).
- e. Group 4 (16.71% of instances) also contains all stations with the following weights: CR12 (23.14%), JU42 (22.59%), JU71 (16.62%), LO21 (17.14%), JU81 (16.12%), MO22 (12.24%), CI42 (13.95%), CI52 (14.14%), CR32 (17.14%), AL41 (12.95%), LO41 (20.43%) and TP91 (14.10%).

Analyzing Table 6 and the information related to the stations in each group, the following patterns are observed:

- Note that all groups obtain a very low average rainfall value for the period analysed.
- Groups 1, 3 and 5 have the common characteristics of very low solar radiation and predominantly non-sunny days.

- Groups 1 and 5 include 9 stations located in the Northwest, Central and South Altiplano, Vega del Segura and Cartagena areas. Group 5 differs from Group 1 by showing south-west winds, positive units of cold, while in Group 1 they are null, more humidity, lower temperatures and almost no wind. This indicates that there are periods of time, between the months of December and March, that the areas have two different meteorological behaviours.
- Group 3 includes the rest of the areas, that is, the 3 stations located in the south and south-east Valle del Guadalestín, and the northern Altiplano. This group has similar meteorological conditions to Group 5 showing differences in wind direction and a higher accumulated radiation.
- Groups 2 and 4 have the common characteristic of predominantly sunny days. The information from these two groups indicates that there are two time periods in which all regions show two different behaviours. In one of them, the temperature is low, positive units of cold, almost no wind from the south, low radiation and average relative humidity; while the other has a medium temperature and radiation, low wind speed from the south-west, low humidity, and negative units of cold.

## **5. A forecast of future objectives**

As it has been commented, in this work there are several elements that can be taken into account to improve the process carried out. A preliminary analysis of these elements is presented below:

1. Expand the number of instances, both complementing the periods of the year (spring, etc.) and with new weather stations in the Region of Murcia.
2. Analyze the different clusters in a more adequate way and taking into account different time periods (which allows us to obtain time groups with different behaviours), it is necessary to design the dataset as time series.
3. As shown in Table 2, there are several measurements that have not been used (minimum and maximum values). In the present work, the attributes with average values have been used. In future situations, attributes represented by fuzzy values (both numerical and nominal) could be used in order to collect all the available information on the measurements with the values (min, med, max) and (med, max).
4. Having datasets that can contain fuzzy attributes, the design and implementation of a clustering technique that is capable of supporting and modeling from instances represented with fuzzy attributes is required.
5. Propose a decision support system that reflects these advances and helps the farmer in making decisions regarding his different crops.

## **6. Conclusions**

In this work, a preliminary study on the groupings of geographical areas of the Region of Murcia obtained using a clustering technique is carried out. These groups have been characterized by their weather conditions in the winter season. As a main conclusion we can say that the technique has been useful to find physically separated areas with similar



characteristics. This is a promising starting point towards achieving the final goal, that is, helping agricultural sustainability. This will cause to improve the performance of certain agricultural areas based on the best performance of similar areas and the use of crops according to weather conditions.

## Acknowledgement

Supported by the projects TIN2017-86885-R (AEI/ FEDER, UE) and RTC-2017-6389-5, granted by the Ministry of Economy and Competitiveness of Spain (including ERDF support).

## References

- [1] Liakos KG, Busato P, Moshou D, Pearson S, Bochtis D. Machine learning in agriculture: A review. *Sensors*. 2018; 18(8):2674.
- [2] Jantakat Y. Spatiotemporal Change for Agricultural Distribution from Municipal to Provincial Scales-based Spatial Clustering Analysis. *International Journal of Building, Urban, Interior and Landscape Technology*. 2019; 14:67-80.
- [3] Reddy AD, Dadore B, Watekar A. Crop Recommendation System to Maximize Crop Yield in Ramtek region using Machine Learning. *Int. J. of Sci. Res. in Science and Technology*. 2019; 6(1):485–489.
- [4] Villalobos R, Retana J. Un Método para el Pronóstico de Lluvias en Costa Rica: Agrupación de años con características pluviométricas semejantes para la creación de escenarios climáticos. *Tópicos Meteorológicos y Oceanográficos*. 2001; 8(1):50–54.
- [5] Gavioli A, de Souza EG, Bazzi CL, Schenatto K, Betzek NM. Identification of management zones in precision agriculture: An evaluation of alternative cluster analysis methods. *Biosystems engineering*. 2019; 181:86–102.
- [6] MacQueen JB. Some Methods for classification and Analysis of Multivariate Observations. In: Le Cam LM, Neyman J, editors. *Proceedings of 5-th Berkeley Symposium on Mathematical Statistics and Probability*. 1967; Berkeley: University of California Press, vol. 1 p. 281–297.
- [7] Fundación Integra. Informes de “Región de Murcia Digital - Economía - Agricultura“. Región de Murcia. Spain. Available from: <https://www.regmurcia.com/servlet/s.SI?sit=c,24,m,3111&r=ReP-23210-DETALLE.REPORTAJESPADRE>

# A Computer Vision Approach to Monitoring the Activity and Well-Being of Honeybees

Sanket KACHOLE, Gordon HUNTER<sup>1</sup> and Olga DURAN<sup>2</sup>

*Faculty of Science, Engineering and Computing,  
Kingston University, U.K.*

**Abstract.** Honeybees, in their role as pollinators, are vital to both agriculture and the wider ecosystem. However, they have experienced a serious decline across much of the world over recent years. Monitoring their well-being, and taking appropriate action if that is in jeopardy, has thus become a matter of great importance. In this paper, we present an approach based on computer vision to monitor bee activity and motion in the vicinity of an entrance/exit to a hive, including identifying and counting the number of bees approaching or leaving the hive in a given image frame or sequence of image frames.

**Keywords.** honeybees; motion assessment; direction identification; computer vision; convolutional neural network, LSTN

## 1. Introduction

Bees are vital contributors both to the agricultural industry and the wider ecosystem, primarily due to their role as pollinators. However, populations of many bee species, including honeybees (*apis mellifera*) and many types of bumblebees (*bombus*), have been in serious decline over the last few decades, particularly in Europe and North America. Various factors, including insecticides, pollution, predators, parasites, diseases, and even microwave EM signals used in telecommunications have been proposed as causes for this decline. Nevertheless, whatever the reasons or it, obtaining a better understanding of the lives of bees in the modern environment, and being able to monitor and preserve the well-being of bee colonies is becoming a higher priority in order to try to stem their severe decline in numbers.

In this paper, we propose and evaluate a method based on computer vision techniques, to monitor honeybee activity close to the entrance/exit to a hive, and attempt to use this to count the number of bees approaching, and the number leaving the hive in a given time interval. This should provide a means of monitoring the level of bee activity in the vicinity of a hive, and to monitor whether the bees are behaving as expected, or whether substantially more bees leave a hive, e.g. due to a swarm occurring, during a day than return later the same day, etc. This should also allow early detection of situations where a hive is in serious decline, e.g. due to disease, parasites or predators, and hence contribute to the promotion of well-being of bee populations. It will complement our other sensor-based approaches to bee monitoring [1, 2]

---

<sup>1</sup> Corresponding Author, School of Computer Science and Mathematics, Kingston University, KT1 2EE, U.K.; E-mail: G.Hunter@kingston.ac.uk

<sup>2</sup> Corresponding Author, School of Engineering and the Environment, Kingston University, London SW15 3DW, U.K.; E-mail: O.Duran@kingston.ac.uk

## 2. Related Previous Work

Various previous authors have proposed several quite different approaches to monitor bee colonies remotely using electronic sensor technology of one form or another. Many of these have been reviewed in [5].

Although radio tracking – either using miniature transmitters attached to the body, or a passive RFID tag - has been used to monitor the movement of larger animals or birds for several decades, the smaller size and body mass of insects resulted in this technique not being used on insects until considerably later. One of the first applications of radio tracking to insect movement was Hayashi & Nakane’s study of dobsonfly (*protohermes grandis*) larvae [6], using a transmitter weighting just 185 mg. This approach has subsequently been applied to tracking a wide variety of insects [7, 8], including bees [9, 10].

Acoustic monitoring of bee colonies has been carried out since at least the 1960s [11], and has more recently been applied to studying important colony phenomena such as swarming [12] and absence of a queen [13]. Other approaches of in-hive monitoring, including monitoring of brood temperature to predict swarming, have also been quite extensively used (e.g. [14, 15]).

However, monitoring the motion of bees in flight is more complicated, and previous attempts to automatically observe and analysis bee activity using computer-vision based approaches have been very limited [16].

## 3. Data Used

The dataset used was a set of 12 videos captured in Summer 2019 using an AXIS P1346 Network Camera (<https://www.axis.com/en-gb/products/axis-p1346>) set up on a tripod approximately 1.5 metres from the entrance to a beehive which contained a thriving colony of honeybees. The frame rate used was 30 frames per second at a resolution of 1920 x 1080 pixels. The videos were each approximately 5 seconds (150 frames) long, giving a total of around 1800 image frames.

## 4. Methodology

### 4.1. Orientation Identification

Bees (including honeybees) are part of the hymenoptera order of insects and thus have wings attached to their thorax, or central part of the body. The head is smaller and lighter than the abdomen (or tail part) of the bee, and hence the bee’s centre of gravity is behind its wings. Therefore, in flight, a bee’s head will be raised relative to its abdomen, making a bee’s direction of flight easy to determine based on the orientation of its body. The typical orientation of a bee’s body during flight is shown in Figure 1. However, before the individual bees could be identified, it was necessary to carry out the following pre-processing steps : (1) Background identification, (2) Background subtraction, (3) Bee bounding box selection, and finally (4) Bee orientation calculation. The first two of these tasks are standard Digital Image/Video processing tasks – see

e.g.[3] for standard methods for achieving these. Bespoke tools were written in Matlab to carry out these tasks. See Kachole [4] for further details.

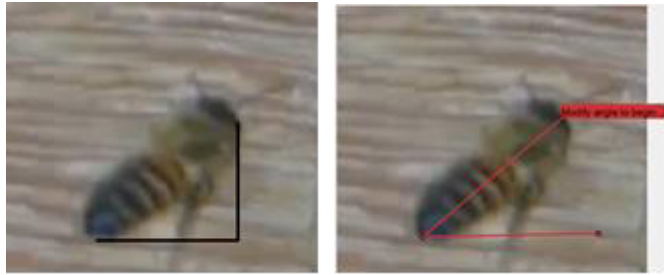

Figure 1 : Close-up image (from our videos) of a bee in flight, close to the wooden hive. The head is clearly above the abdomen, enabling the direction of the bee’s motion to be determined from a single frame. The left-hand image shows the  $x$  (horizontal) and  $y$  (vertical) components of the bee’s oriented dimensions. The right hand image indicates the axis of the bee relative to the horizontal direction. In this case, the bee is oriented in the “upper right” quadrant of the plane, indicating that the bee is moving to the right. Other bees could be oriented in the “upper left” quadrant, indicative of moving to the left,

#### 4.2. Obtaining “Ground Truth” for Training Data

“Ground truth” data was also obtained using our bespoke Matlab labelling tool to manually place rectangular bounding boxes around each bee in a selected number of frames. For each box identified as containing a flying bee, a label was also added to indicate whether the bee was approach or moving away from the hive entrance. An example of a “marked-up” image frame, showing some bees in flight around the hive, is displayed in Figure 2.

#### 4.3. Training a Convolutional Neural Network to Distinguish Bees from Background

Once the Ground Truth had been established, the 2-D U-Net convolutional neural network [17, 18] was trained and then used to preform automatic segmentation of each image. U-Net has various advantages over other types of convolutional neural networks for this task, in that its architecture allows highly accurate segmentations to be performed very quickly despite only requiring a relatively small number of training images. The architecture of a U-Net system has two distinct paths – a contracting path and an expanding path, arranged in a “U” shape which gives the architecture its name. The contracting path is similar to many longer- established convolutional neural networks, consisting of a cycle of two  $3 \times 3$  unpadded convolutions, each followed by a “Rectified Linear Unit” and a  $2 \times 2$  MaxPooling layer with stride 2 pixels.

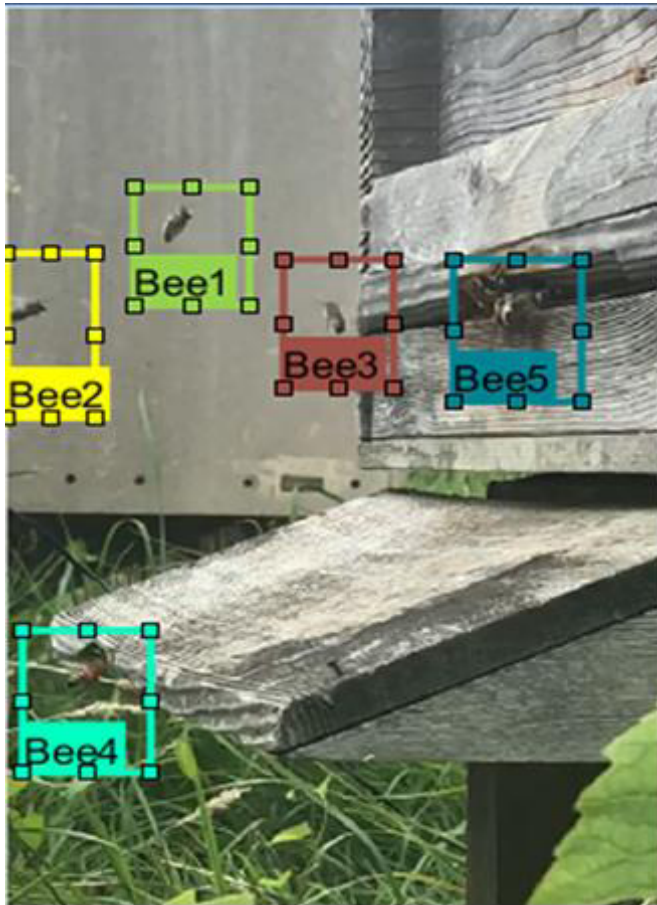

Figure 2 : Ground Truth for one frame – a rectangular bounding box is produced for each bee in the image by a human operator using our bespoke Matlab labelling tool. Note that “Bee1”, “Bee2” and “Bee4” are approaching the hive, whilst “Bee3” is moving away from it, and “Bee5” may actually be a cluster of several bees.

At each stage of this contracting path, the resulting “image” shrinks in size, but the number of feature channels increases. The expansive path performs a sequence of upsampling,  $2 \times 2$  “up-convolutions”, a concatenation with the feature map at the same level of the contracting path and a pair of  $2 \times 2$  convolutions, each followed by the application of a Rectified Linear Unit, with one final  $1 \times 1$  convolution to map the output to any one of the distinct categories being considered. In total, U-Net contains 23 convolutional layers [17]. Its developers state that it is capable of providing precise segmentations despite requiring very few training images, and has recently proved very popular with other researchers. 3D U-Net [18] is a generalization of U-Net which permits the segmentation of volumetric images. A schematic representation of U-Net is shown in Figure 3.

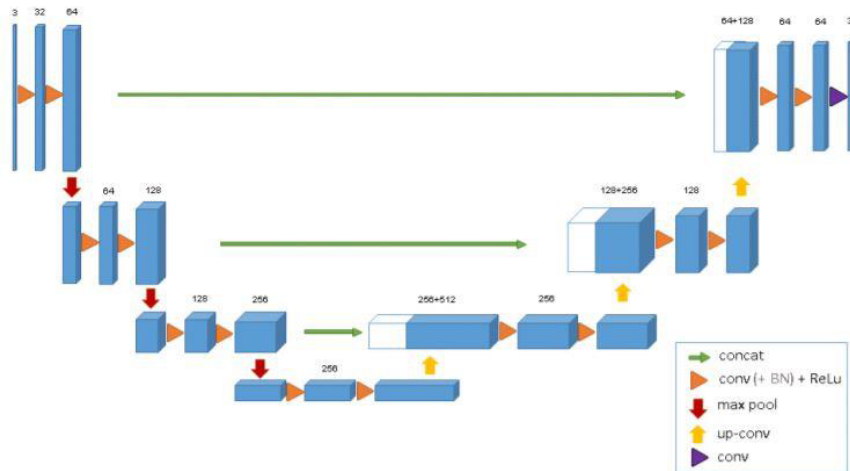

Figure 3 : A schematic representation of the 2D U-Net neural network architecture. “concat” means a concatenation operation, “conv (+BN) + ReLu” means “convolution with Batch Normalisation, followed by Rectified Linear Unit”, “max pool” is Max Pooling, “up-conv” means up-convolutions, and “conv” is a conventional convolution. From [18].

In training our network, we monitored both the Root Mean Squared Error (RSME) across the training dataset and the “Dice loss” function [19] over all images in the dataset :

$$\text{Dice} = 2 |A \cap B| / (|A| + |B|)$$

where A and B are the identified regions in the ground truth and processed images respectively. It takes the value 1 when these regions exactly coincide and 0 if they are disjoint.

During training, it was observed that both the RMSE and the dice loss function both stabilized, at about 20% and 5% of their early peak values respectively, after about 100 iteration cycles through the training data (see Figure 4). Further iterations through the training data only resulted in very modest additional reductions in the values of these metrics. Further details of the implementation can be found in Kachole [4].

In application, the trained U-Net network was used to segment the images into “bees” and “background” (the background could be further sub-divided into “hive” and “vegetation” for the images in our videos, but this sub-categorisation is not used in this study). The binary images, with pixels identified as “bees” displayed in white, and “background” in black, were then subjected to dilation and erosion operations [3] in order to produce a reasonable number of relatively large connected areas of pixels as “bee candidates” and to remove any noise. These been candidate areas could then be counted, have their orientations computed, and compared with the ground truth (where available) for evaluation purposes.

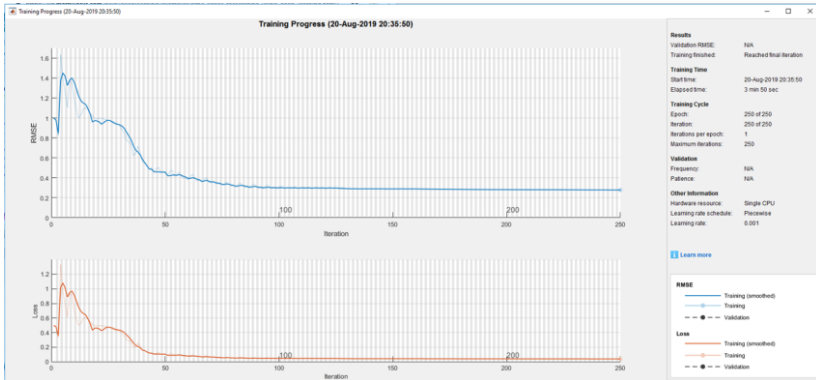

Figure 4 : Variation of Root Mean Square Error (RSME, upper graph) and Dice Loss (lower graph) with respect to number of iterations through the training data during training of the U-Net.

#### 4.4. Monitoring and Evaluation of Bees “Approaching” or “Leaving” the Hive

Once each image frame had been segmented into “bees” and “background”, the number of connected “bee” regions in each frame were counted. This is then taken as the computed number of bees in that frame. The orientation calculator (see section 4.1 above) was also applied to each such connected “bee” region to decide whether that bee was approaching or leaving the hive, or was stationary, and the number in each category in each frame was calculated.

In order to predict the number of bees in each category in future training frames, a Long Short-Term Memory (LSTM) network was used [20] - a recurrent neural network that can cope with both short and long term dependencies and patterns within time series. LSTMs have proved highly successful in correctly identifying such patterns across many different domains. Further details of the implementation can be found in Kachole [4].

## 5. Results and Discussion

### 5.1. Segmentation of Image Frames into Bees and Background

After training, the U-Net network was applied to each image frame in term, to segment that frame into “bees” and “background”(see Figure 5 for an example). The result was compared with the ground truth for each frame, and the average Accuracy calculated :

Accuracy = (Number of pixels correctly classified) / (Total number of pixels in image).

Across the entire dataset, an accuracy of 83.47% was achieved. This compares quite well with other studies on bee classification – Campbell et al [16] achieved a precision of 94% and a recall of 79%, where these quantities are defined by :

$$\text{Precision} = (\text{Number of True Positives}) / (\text{True Positives} + \text{False Positives})$$

$$\text{Recall} = (\text{Number of True Positives}) / (\text{True Positives} + \text{False Negatives})$$

Thus, for the data of Campbell et al [16], the high precision indicates that there were very few False Positives, but the lower recall value shows that there were a substantial number of False Negatives. In contrast, accuracy compares the total number of True Positives and True Negatives (i.e. all correctly classified pixels) with the total number of all pixels in the image frame.



Figure 5 : (Left) Image of hive entrance, with flying bees, (Right) Binary image showing bees only, after background subtraction. The large “blob” in the binary image corresponds to a cluster of several bees in the original image. The orientation of each bee in flight can be used to determine whether it is approaching or leaving the hive.

### 5.2. Counting of Bees, including Numbers Approaching or Leaving the Hive

The total number of bees found, and the numbers approaching and leaving the hive, were computed for each frame, and these values noted over a sequence of successive frames. These counts were compared with the corresponding values obtained as predictions for each frame using the LSTM. A selection of these results are shown in Figures 6, 7, 8.

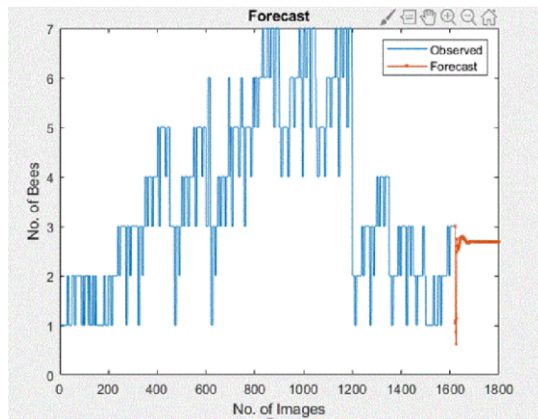

Figure 6 : Total number of bees in each frame against frame number, plus forecast for an additional 200 frames provided by the LSTM.



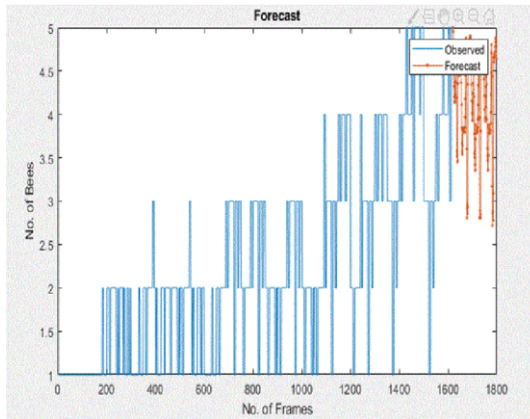

Figure 7 : Number of bees approaching the hive in each frame against frame number, plus forecast for an additional 200 frames provided by the LSTM.

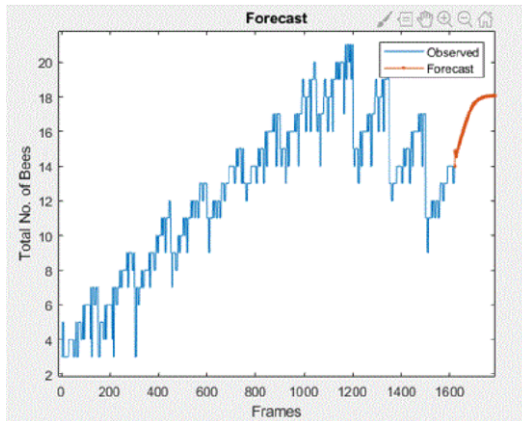

Figure 8 : Number of bees flying away from the hive in each frame against frame number, plus forecast for an additional 200 frames provided by the LSTM.

### 5.3. Discussion

The accuracy of the segmentation of image frames into bee and non-bee (background) regions seems satisfactory, and the performance is comparable to that obtained in other studies. The LSTM predictions of the number of bees flying in total, or towards or away from the hive have certain limitations – not least that the LSTM output is a continuous-valued variable, whereas in reality these counts will always be discrete (non-negative) integer values. This will therefore lead to errors. Assessment of the utility of the LSTM predictions is currently limited by the relatively small amount of data available. It is planned to extend this evaluation in the near future.

## 6. Conclusions and Future Work

We have developed and demonstrated a video-based system using a convolutional neural network which can be trained to distinguish between bees and a background consisting of a wooden hive and green plant vegetation. Furthermore, we are able to detect the orientation of bees in flight in order to distinguish bees which are approaching the hive from those leaving it. We have also developed a counting tool to count the total number of bees, the number approaching the hive, and the number leaving it in each image frame, and trained an LSTM recurrent network to make predictions of these quantities a few frames into the future.

The models we have developed so far have been trained on a rather limited dataset. In order to ensure that our system is robust, substantially more video data should be acquired for both training and testing the network.

A useful potential extension to this video-based work would be to use image frames to identify whether the bees were infested with parasites such as varroa mites (varroa destructor) or suffered from defects (e.g. malformed wings) which might be indicative of diseases being prevalent in the colony. Detection and identification of predator species from images would also be highly valuable to beekeepers. Whilst European common wasps (*vespula vulgaris*) will regularly try to raid beehives to steal honey, and superficially look similar to honeybees (workers of both common wasps and honeybees are around 12 – 17 mm in length) - identifying them might require higher-resolution images - they are not generally considered to be a major threat to bees. Other wasp species, particularly hornets, are a different matter – they are aggressive and may dismember bees in order to feed them to hornet larvae. The European hornet (*vespa crabro*) is normally significantly larger (workers being about 25 mm long) than honeybees or common wasps, and can threaten the well-being of a weak honeybee colony. The Asian hornet (*vespa velutina*) is considered a major threat to honeybees, and has been found in several Mediterranean countries and, in a few isolated cases, in Southern and Central England. Although shorter (at about 20 mm for workers) than the European hornet, the Asian hornet is larger than honeybee or common wasp workers and is quite dark – mainly brown – in colour, but has yellow face and legs [21]. Fortunately, the Asian giant hornet (*vespa mandarinia*) has not yet reached Europe, but is a major predator of bees elsewhere in the World.

The aim of our system is to provide a method for monitoring levels of bee activity to assess their well-being and productivity as pollinators. We are developing a project in collaboration with both academic institutions and NGO development agencies to monitor bees in West Africa to aid environmental protection and promote sustainable development through enhancing cash crop yields via improved levels of pollination of the crop plants' flowers. However, this work is currently just at the planning stage.

## Acknowledgements

We would like to thank the Biodiversity Team, particularly Sivi Sivanesam, and Colm Treacy (KU beekeeper) at Kingston University for allowing us to access and use the University beehives and for some funding towards the cost of the equipment. We are grateful to Alex Matovu and Dilshan Wettamuni for help recording the videos. We would also like to thank the School of Education, Kingston University, for allowing us physical indoor space close to the hives, for storing some equipment and providing access to the hives.

## References

- [1] D. Howard, O. Duran and G. Hunter, “A Low-Cost Multi-Modal Sensor Network for the Monitoring of Honeybee Colonies/Hives” Proceedings of ISAPEP 2018, Rome, Italy, in “*Intelligent Environments 2018*”, pp. 69-78, IOS Press BV., Amsterdam, Netherlands, June 2018.
- [2] G. Hunter, D. Howard, S. Gauvreau, O. Duran and R. Busquets, “Processing of Multi-Modal Signals from a ‘Smart’ Beehive”, *Proceedings of the Institute of Acoustics* (UK), Vol. 41(1), pp. 339-348, 2019.
- [3] R.C. Gonzalez and R.E. Woods, “*Digital Image Processing*” (4<sup>th</sup> Edition), Pearson Publishing, 2018.
- [4] S. Kachole “Computer vision to assess the wellbeing of Honeybees”, MSc project report, Kingston University, U.K., unpublished, 2019.
- [5] R. Scheiner et al, “Standard methods for behavioral studies of *Apis mellifera*”, *Journal of Apicultural Research*, Vol 52 (4), 2013
- [6] F. Hayashi and M. Nakane, “Radio tracking and activity monitoring of the dobsonfly larva, *Protothermes grandis* (Megaloptera: Corydalidae)”, *Oecologia*, Vol 78, pp 468–472, 1989
- [7] M.E. O’Neal et al, “Tracking Insects with Harmonic Radar: a Case Study”, *American Entomologist*, Vol. 50 (4), pp 212-218, 2004.
- [8] W.D. Kissling, D.E. Pattemore, M. Hagen, “Challenges and prospects in the telemetry of insects”, *Biological Reviews*, Vol. 89 (3), pp 511- 530, 2014.
- [9] S. Streit, F. Bock, C.W.W. Pirk, J. Tautz, “Automatic life-long monitoring of individual insect behaviour now possible”, *Zoology*, Vol. 106 (3) pp 169 – 171, 2003
- [10] P. Nunes-Silva et al, “Applications of RFID technology on the study of bees”, *Insectes Sociaux*, Vol. 66, pp 15-24, 2019
- [11] A.M. Wenner, “Sound Communication in Honeybees”, *Scientific American*, Vol. 210, pp 116-124, 1964
- [12] S. Ferrari, M. Silva, M. Guarino & D. Berckmans, “Monitoring of swarming sounds in bee hives for early detection of the swarming period”, *Computers and Electronics in Agriculture*, Vol. 64, pp 72-77, 2008
- [13] D. Howard, O. Duran, G. Hunter and S. Stebel, “Signal Processing the Acoustics of Honeybees (*Apis Mellifera*) to Identify the ‘Queenless’ State in Hives”, *Proceedings of the Institute of Acoustics*, Vol. 35 (1), pp 290 – 297, 2013
- [14] D.S. Kridi et al, “Applications of Wireless Sensor Networks for Beehive Monitoring and In-Hive Thermal Patterns Detection”, *Computers and Electronics in Agriculture*, Vol. 127, pp 221 – 235, 2016
- [15] A. Zacepins et al, “Remote Detection of the Swarming of Honey Bee Colonies by Single-Point Temperature Monitoring”, *Biosystems Engineering*, Vol. 148, pp 76 – 80, 2016
- [16] J. Campbell, L. Mummert, R. Sukthankar, “Video monitoring of honey bee colonies at the hive entrance”, *Visual Observ. Anal. Animal Insect Behav., ICPR*, 8, pp 1-4, 2008
- [17] O. Ronneberger, P. Fischer, T. Brox, “U-Net: Convolutional Networks for Biomedical Image Segmentation”, In: Navab N., Hornegger J., Wells W., Frangi A. (eds) “Medical Image Computing and Computer-Assisted Intervention” – MICCAI 2015, pp 234-241. *Lecture Notes in Computer Science*, Vol 9351. Springer, Cham, 2015
- [18] Ö. Çiçek et al, “3D U-Net: Learning Dense Volumetric Segmentation from Sparse Annotation”, In: Ourselin S., Joskowicz L., Sabuncu M., Unal G., Wells W. (eds) “Medical Image Computing and Computer-Assisted Intervention” – MICCAI 2016, pp 424 – 432. *Lecture Notes in Computer Science*, Vol. 9901, Springer, Cham, 2016
- [19] L.R. Dice, “Measures of the Amount of Ecologic Association Between Species”, *Ecology*, Vol. 26 (3), pp 297–302, 1945.
- [20] S. Hochreiter, J. Schmidhuber, “Long Short-Term Memory”, *Neural Computation*, Vol. 9 (8), pp 1735 – 1780, 1997.
- [21] E. Osterloff, G. Broad “Why Asian hornets are bad news for British bees” <https://www.nhm.ac.uk/discover/why-asian-hornets-are-bad-news-for-british-bees.html> [Last accessed 3 May 2020]

This page intentionally left blank

4th International Workshop on Citizen-  
Centric Smart Cities Services (CCSCS'20)

This page intentionally left blank

# Introduction to CCSCS'20

Fábio SILVA <sup>a,c,1</sup>, Héctor MORETÓN <sup>b</sup>, Cesar ANALIDE <sup>a</sup>, and Paulo NOVAIS <sup>a</sup>

<sup>a</sup>Centro ALGORITMI, University of Minho, Braga, Portugal

<sup>b</sup>University of Leon, Leon, Spain

<sup>c</sup>CIICESI, ESTG, Instituto Politécnico do Porto, Felgueiras, Portugal

Smart Cities can be considered as a new paradigm or a concept that is emerging all over the world as a necessary and unavoidable response to the constant urban population growth and associated technical, material, social, and organizational problems, in order to improve the quality of life of their citizens, and to provide a more economic competitive, sustainable and livable city. The recent development of important technologies, such as low power miniature sensing devices, high-speed wireless and wired communication networks, and high-performance computing systems, enables the creation of new possibilities and capabilities, fostering the opportunities for smart city realizations.

Intelligent solutions to the referred problems, intended to control pervasive computing systems, such as citizen-aware intelligent environments, will help and contribute to the construction of a sustainable smart city, providing value-added, intelligent, adaptive, context-aware, user-centric and sustainability services, with realizations such as smart home/smart building, smart energy, smart mobility, smart parking, smart health or citizens well-being, that is, providing smart services intended to be more efficient, with reduced resource consumption and promoting the well-being and good quality of life of their citizens, without neglecting the benefits of a citizen sensor. With the citizen as an active and proactive actor of the Internet of Things, reliable and definitive solutions for problematics such as Road Safety and Vulnerable Road Users, among others, could finally emerge. However, the smart city realization means everything should be considered in large scale, in real-time, dynamically, with uncertainty with restrictions, and adapt to different objectives. Furthermore, the standard computational intelligence algorithms may be insufficient or not robust enough to deal with smart city big data analytics. Applications geared towards the citizen also implicate different techniques and objectives than normal computational platforms.

The purpose of this workshop is to gather and present new and original research towards citizen-centric solutions within the ambit of intelligent environments and smart cities, capable of active context awareness, automatically changing their functioning in response to discovered context, enabling that way the improvement not only of city efficiencies, but also citizens quality of life.

This fourth edition of the Workshop on Citizen Centric Smart Cities Solutions (CCSCS'20) presents articles centered around citizen centric services and their application inside smart cities, IoT platforms and intelligent services. The themes proposed for this workshop range from the proposition of methodologies for intelligent environments to the analysis of concrete problems such pedestrian and citizen life, traffic, health services

---

<sup>1</sup>Corresponding Authors and CCSCS'20 Chairs: Fábio Silva, Héctor Moretón, Cesar Analide, Paulo Novais; E-mail: fas@estg.ipp.pt, hector.moreton@unileon.es, analide@di.uminho.pt, pjon@di.uminho.pt

or automatic conversational interfaces between services and citizens. These works are used to discuss ideas and propositions that have impact on the relation between people, services and smart cities. This workshop aims to further the discussion in these topics and find common ground and technology applied in solution towards the benefit of the citizen.



# Context-Aware Approach for Cardiac Rehabilitation Monitoring

Godwin Okechukwu OGBUABOR <sup>a,1</sup>, Juan Carlos AUGUSTO <sup>a</sup>, Ralph MOSELEY <sup>a</sup>,  
and Alechia van WYK <sup>b</sup>,

<sup>a</sup>Research Group on Development of Intelligent Environments, Department of  
Computer Science, Middlesex University, London, UK

<sup>b</sup>Department of Natural Sciences, Middlesex University, London, UK

**Abstract.** As technology advances, the usage and applications of context-aware systems continue to spread across different areas in patient monitoring and disease management. It provides a platform for healthcare professionals to assess the health status of patients in their care using multiple relevant parameters. Existing technologies for cardiac patient monitoring are generally based on the physiological information, mostly the heart rate or Electrocardiogram(ECG) Signals. Other important factors such as physical activities and time of the day are usually ignored. We propose a context-aware solution for cardiac rehabilitation monitoring using multiple vital signs from the physiological and activity data of the patient. This research considers the activity of the patient alongside the time of the activity to facilitate physicians decision-making process. We provide a personalised physical activity recognition processing by generating a personalised model for each user. A prototype is presented to illustrate our proposed approach.

**Keywords.** Cardiac Monitoring, Context-Aware, Cardiac Rehabilitation, Activity Recognition

## 1. Introduction

Cardiac diseases such as arrhythmia, stroke and coronary heart disease (CAD) could possibly be managed by monitoring of patients' bio-signals in real-time. The symptoms of these diseases are diverse, ranging from minor chest palpitations, chest pain, fainting(syncope) to sudden heart attack, depending on the type and severity of the heart disease[5]. According to British Heart Foundation statistics report, heart and circulatory diseases cause about 28% of all death in the UK, accounting nearly 170,000 deaths each year, an average of 460 people each day [4]. Public Health England also reported that it cost about 7.4 billion every year for healthcare relating to cardiovascular diseases [9].

Fortunately, the most recent advances in ECG monitoring and with the help of modern mobile phone technology, monitoring a patient at distance has become easier and more accessible. However, it is essential to note that in order to predict abnormalities, a specific vital sign such as heart rate, ECG signals may not provide sufficient knowledge to assist physicians in decision-making [20]. The combination of physiological param-

---

<sup>1</sup>Corresponding Authors: Godwin, Juan; E-mail:go314@live.mdx.ac.uk, J.Augusto@mdx.ac.uk

eters and patient's activity details can go a long way in providing a platform that will enable physicians to make accurate and timely decisions; thereby, offer a better environment for cardiac rehabilitation monitoring. The rehabilitation process offers training and support that enable patients to recover and return to their normal activities [8]. It is the main aspect of secondary prevention of cardiovascular disease [16], which assists patient in the recovery process and provide a means for healthcare professionals to frequently assess the health status of patients using contextual information.

Context-aware approach can provide a platform to aggregate and correlate multiple vital parameters for effective cardiac rehabilitation monitoring. Generally, context-awareness is the ability of a system to use contextual information to provide services that are relevant to the stakeholders based on their preferences and needs [2]. In healthcare, a context-aware system could be regarded as a system that uses patient context details to provide useful information or services to clinicians, patient or relatives. These contexts could be location, time, identity or activity of the considered subject. It plays essential role in the healthcare delivery decision-making process, assisting physicians to effectively and timely monitor patients in their care.

Considering the increase in cardiac death and the financial burden it imposes on the government, individuals and different organisations [5], effective and efficient cardiac condition monitoring system is timely and need to be automated. This work aim to develop a context-aware solution for cardiac condition monitoring to facilitate the physician's decision making process. The proposed system is ongoing research targeting cardiac rehabilitation monitoring using context-aware approach. The work involves data collection from ECG and smartphone sensors, machine learning algorithm training for activity recognition, and personalized recommendation interface for effective monitoring. During the monitoring process, the subject will be required to carry a smartphone running android app for data collection and Holter monitor for ECG signals recording. The contextual information will be aggregated, analyzed and visualized for early abnormality detection, pattern discovery and personalized recommendations. The proposed system takes into consideration the activity of the patient and the corresponding time in decision-making process. We present a scenario below for more understanding of this work.

*Mike was recently discharged from the hospital after suffering from cardiac disease. In order to avoid cardiac readmission, his physician, Dr. Charles needs to keep in touch with him frequently. Mike lives far away from the hospital, therefore creating a barrier for constant visits to the hospital. To constantly monitor Mike's health status and offer personalised recommendations, Dr. Charles need a platform that will generate and correlate Mike's physiological signals and activity data from distance. The platform will enable Mike see his physician's recommendations and adjust accordingly without visiting the hospital.*

The rest of the work is organised as follow: In section 2, we presented related work by other researchers, discussing their strengths and limitations. Section 3 discussed context-aware system for cardiac rehabilitation monitoring. We talked about activity recognition process in section 4. Section 5 discussed the research methodology, while section 6 and section 7 presents experimental analysis and the system prototype respectively. Finally, section 8 shows the conclusion of the work and future research direction.

## 2. Related Work

There are several studies relating to cardiac condition monitoring. However, most of these studies focus on identifying irregularities in a specific vital sign. The authors in [3] introduced a prototype for continuous monitoring of cardiac activity using electrocardiography and heart rate. The system is made up of an intelligent sensor data acquisition system, a processing system based on Bluetooth technology and a communicator for transferring data to a medical server. The researchers in [17] presented android-based heart monitoring system that uses a heart rate monitor data to provide a detailed report about cardiac patient health status, transmit the data to an online database and generate an emergency alert when necessary. The evaluation of the system proved its effectiveness, however, using a single parameter of the considered patient might not provide enough knowledge to the clinician in order to make appropriate decisions [20].

Recently, some authors proposed context-aware system for cardiac patient monitoring, however, research in this area is still in infancy and needs significant improvement. Authors in [12] developed a system that record biosignal of the patients and request for context information when there is abnormality. The patient has to input information about his/her daily life activities. So this system is not fully automatic since it requires the user's intervention. The focus of [7] was in the older adult, they developed a cloud-based system that extracts health parameters from Fitbit device and ECG sensors. The context information of the patient is sent via social media to the patient's doctor, relative or friends when there is an abnormal change. The Fitbit device could only recognize steps of the subject and could not show specific activity performed such as walking, running and sitting. Fitbit device was also used in the work by [10] to collect the steps count of the monitored patient. An intelligent mobile system based on rule decision support system for cardiac patients was introduced by [18]. The system correlates data from the ECG sensor with physical activities such as walking, running and body posture. They used threshold rule to determine the activity of the patient and argued that testing the system with 15 healthy persons proved the effectiveness of the proposed approach. The researchers in [11] also used threshold approach to detect different activities (Lying, Standing, Walking, Jogging) for cardiac disease monitoring and achieved classification accuracy of 94%. Though the approach shows effective; however, using threshold rule to determine the activity of the user might not be the best option due to the wide range of physical activities. Another similar solution was presented by [14], they combined the ECG signals with physical activities for cardiac disease diagnosis. They applied machine learning techniques to recognize human activities. Machine learning provides computation methods and learning mechanism for developing a model to predict a situation based on the ground truth. They recruited seven healthy persons who wore ECG sensor on their chests and carried smartphones in their pockets to collect sensor data. Each subject was asked to perform three different activities (Running, Rest and Walking). The sensor data from the seven participants were aggregated, processed and used to train J48 decision tree algorithms in order to predict the activity of the users when new data without ground truth are fed into the model.

### 3. Context-aware Cardiac Condition Monitoring

The fundamental idea behind context awareness in healthcare is to develop a proactive and efficient system that can adapt to the changes in the patient’s condition and environment [21]. This system makes use of multiple vital signs of the subject to provide useful and real-time information to the physicians. A context-aware system in healthcare could be regarded as a system that uses patient context details to provide useful information or services to clinicians, patient or relatives.

In this work, we consider the ECG signals from Holter monitor, activity data from smartphone and time of the day as essential contexts to provide effective and efficient system for cardiac rehabilitation monitoring. These contexts are selected based on interview with the stakeholders and the quest to present real-time, reliable and energy-efficient system. The system will collect and aggregate a vast amount of data from Holter monitor and smartphone, train algorithms to detect the activity and the corresponding time of the activity. This will enable the physician to monitor and asses the health status of the patient under their care and offer personalised recommendation.

The architecture of the proposed system is presented in figure 1. During the monitoring process, the subject will be required to carry a smartphone running the android app for activity data collection. Android is selected for this research due to the wide use of Android phones around the world. The android app will collect and aggregate a huge amount of data from the smartphone while the Holter monitor will collect and aggregate ECG signals from the user, this form the context acquisition unit. Then, at the modelling and storage stage, the acquired contexts will be presented in an efficient and structured format and stored in a database for retrieval; while at the context reasoning and visualisation stage, relevant features will be extracted from the data and fed into machine learning algorithms. Also at this stage, the outcome of the analysis will be presented as a decision support tool using mobile and web technologies. Finally, healthcare professionals will be able to offer personalised recommendations to the patient based on the contextual analysis. The recommendations could be in the form of text or auditory format advising patient regarding the state of his/her health.

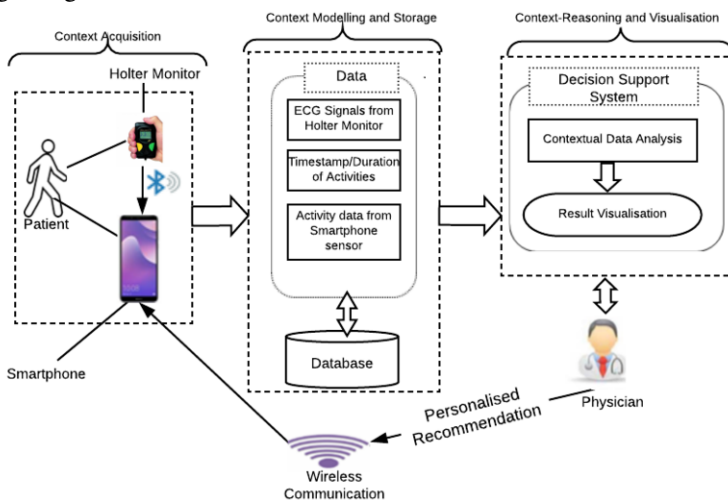
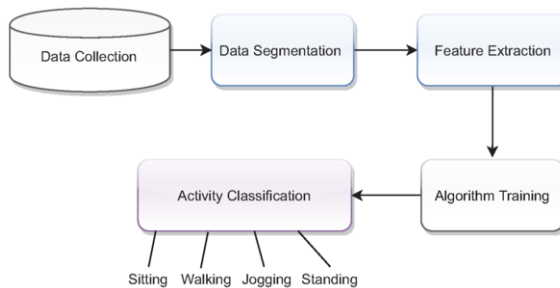

Figure 1. System Architecture

#### 4. Activity Recognition

Physical activity recognition is an essential part of cardiac rehabilitation monitoring [19]. Recognising human activities such as walking and running or human-related actions aims to observe and understand what type of activities or routines performed by the subject at time-interval [22]. The work in [19] pointed out that the primary focus of cardiac rehabilitation is on exercise and needs to be automated. There are several devices and apps available for activity recognition, however, these gadgets and apps are designed for the population and do not consider different patterns by which individuals carry out their physical activities. We present a personalised physical activity recognition system for cardiac rehabilitation monitoring. The system collects sensor data from the patient, trains the algorithms and uses it to recognise his/her activities. This approach will enable the algorithms to recognize the activities with high accuracy [13]. The system also considered the time of the activity in order to guide physician when making a decision for patient.

The built-in accelerometer sensor in modern Smartphones has made it possible to dynamically detect the activity of the user. To recognise user's activity, he/she need to carry the mobile phone while doing daily activities. As indicated in figure 2, the first phase of activity recognition is data collection using mobile app, the mobile app collects the x, y and z coordinates and in most cases along with the timestamps. Secondly, the sensor data are processed and partitioned into equal groups at time-interval representing the segmentation stage. In the third stage, time or frequency domain features are extracted from each group, and finally, the extracted features are used to train machine learning algorithm in order to classify new data without ground truth.



**Figure 2.** Activity Recognition Process

#### 5. Methodology

We adopted the User-Centred Intelligent Environments Development Process (UCIEDP) for this research [1]. The stakeholders are at the heart of this methodology, hence making it crucial to involve the healthcare professionals at the early stage of this work. The initial stage is interview with cardiologist and a cardiac rehabilitation nurse to gather user requirements. The outcome of the interview reveals that physical activity recognition is an essential part of cardiac rehabilitation, this lead to the next stage, activity recognition.

As shown in figures 3, we implemented android app to collect accelerometer sensor data using smartphone. Members of the Research Group on Development of Intel-

ligent Environments of Middlesex University participated in the data collection. Each participant were asked to select the position of the phone and the activity to perform. To have uniform experimental analysis, each person has to select pocket as the position of the phone and carry out four different activities(sitting, standing, walking and jogging). Pocket were selected as the preferred position due to its convenient when doing daily activities. The sensor information were processed and used to train machine learning algorithms for activity recognition. The system detects activity of the subject and the corresponding time of the activity.

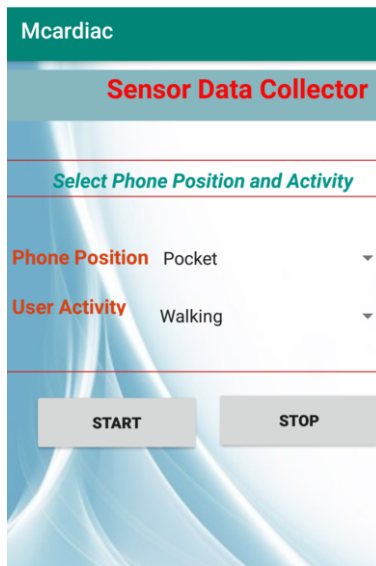

Figure 3. Sensor Data Collection App

## 6. Experimental Analysis

To carry out the experimental analysis, we collected samples of accelerometer data from five volunteers. The participants were asked to put the phone in the pocket and perform four activities; sitting, walking, jogging and standing. The mobile app collects the sensor data at frequency of 50Hz using the built-in function(Sensor\_Delay\_Game) provided by android. The frequency might vary depending on the processing capacity of the smartphone. The mobile app collects the x,y and z coordinates along with the timestamps. The magnitude of the three coordinates was computed to handle orientation problems of the smartphones making it four features; x,y,z, and magnitude. The magnitude (mg) of the total acceleration is computed by the square root of the sum of the squared acceleration of three axes in the Equation below.

$$mg = \sqrt{x^2 + y^2 + z^2}$$

The raw sensor data cannot be used to train machine learning algorithm directly, hence we applied sliding window technique to partition the sensor data into 4 seconds equal windows and extracted some time domain features from each segment. Assuming the

window length as  $w$ , for a given time series  $[x_1, x_2, x_3, \dots, x_n]$ , each window can be expressed as  $[xw_1, xw_2, xw_3, \dots, xw_n]$ , then features were extracted from each window and used to train machine learning algorithms. To provide a robust activity recognition approach, we personalised the activity recognition process by training and testing the algorithm using each participant's dataset individually. Table 1 represents the extracted features for the analysis. Each feature represents an input vector used for the algorithm training. The extracted feature vectors were split into 70% for training and 30% for testing. We compared different machine learning algorithms using WEKA tool as presented in table 2. Each participants dataset were analysed and random forest performed better in teams of classification accuracy.

Random forest is an ensemble machine learning approach that works by averaging several predictions of independent base models [6]. It is developed by combining the prediction of different trees, each of which is trained individually. It can be used for both classification and regression tasks and is capable of handling noise data and can prevent data overfitting. Due to limited space, we present the confusion matrices for only Random Forest across the participants in tables 3,4,5,6,7 . The confusion matrices show the contribution of each activity in the classification accuracy of the algorithm. From the analysis, User2 and User4 had no misclassification while one or more misclassification are recorded in the rest of the users.

Furthermore, the dataset from User1 was used to train random forest algorithms in python environment. Personalised model generated and used to classify new datasets without ground truth. Figure 4a shows the graphical representation of the predicted activities from User1.

**Table 1.** Extracted features for algorithm training

Feature	Equation
Mean	$mean = \frac{1}{N} \sum_{i=1}^N x_i$
Variance	$var = \frac{1}{N} \sum_{i=1}^N (x_i - mean)^2$
Standard Deviation	$std = \sqrt{\frac{1}{N} \sum_{i=1}^N (x_i - mean)^2}$
Minimum Value	$min = MIN(x_i)$
Maximum Value	$max = MAX(x_i)$
Median value	$median = \frac{N+1}{2}$
Standard Error of the Mean(sem)	$sem = \frac{std}{\sqrt{N}}$

## 7. System Prototype

Modern smartphones and wearable devices are contributing immensely to the healthcare delivery process by assisting doctors and healthcare professionals to monitor patients at

**Table 2.** Comparison of different machine learning algorithms

Algorithms	User1(%)	User2(%)	User3(%)	User4(%)	User5(%)	Average (%)
KNN(k=3)	95.24	96.67	95.65	100	90.24	95.55
Random Forest	97.62	100	95.65	100	92.68	97.19
Multilayer Perceptron	95.24	96.67	93.48	100	87.80	95.64
Naïve Bayes	97.62	100	89.13	100	87.80	94.91
Decision Tree(J48)	100	100	84.78	96.55	90.24	94.31

**Table 3.** User1

	Sit	Stand	Walk	Jog
Sit	14	0	0	0
Stand	0	9	0	1
Walk	0	0	10	0
Jog	0	0	0	8

**Table 4.** User2

	Sit	Stand	Walk	Jog
Sit	8	0	0	0
Stand	0	8	0	0
Walk	0	0	6	0
Jog	0	0	0	8

**Table 5.** User3

	Sit	Stand	Walk	Jog
Sit	10	0	0	0
Stand	0	9	1	0
Walk	0	0	11	1
Jog	0	0	0	14

**Table 6.** User4

	Sit	Stand	Walk	Jog
Sit	15	0	0	0
Stand	0	16	0	0
Walk	0	0	18	0
Jog	0	0	0	9

**Table 7.** User5

	Sit	Stand	Walk	Jog
Sit	2	0	0	0
Stand	0	8	0	0
Walk	1	1	4	0
Jog	0	0	0	24

distance. Sensors embedded in these devices could be used to collect and aggregate a large amount of data from patient's biosignals, and analysed to assist doctors in decision-making. The most regularly used tool for cardiac condition monitoring is the Holter monitor. Holter monitor is a portable and continuous monitoring device used to generate and record ECG signals [15]. Some of the modern Holter monitors allow users to wear the device while doing their normal activities and are capable of transmitting user's details to the physicians through mobile phones. The Holter monitor generates ECG signals, and the heart rate of the user can be computed from the signals. Smartphone is equipped with an accelerometer sensor that generates data regarding the movement of the user. The generated raw sensor data are processed and used to train machine learning algorithm for activity detection. The aggregation of the information from these gadgets could assist physicians in decision making. In figure 4, we provide a prototype showing the graphical representation of the activity information from smartphone and ECG signals from the Holter monitor.

The information from the Holter monitor represents the heartbeat at the time interval while the information from the smartphone shows the activity of the user at a time interval. The concept is to enable healthcare professionals to understand the activity of the patients when reading the ECG signals and the heart rate. If there are any irregularities in the signals, the physician can consider the activity of the subject as a guide in decision-making. For instance, if the heart rate is high, and the activity of the user is sitting. The physician might consider it as an abnormality, however, if the heart rate is high and the activity before or during that particular time is jogging, the physicians might argue that the increase in the heart rate might be due to the subject doing a rigorous activity which makes the heart to beat faster. This approach will enable the physician to offer right advice to the patient instead of prescribing unnecessary medications. Furthermore, as physical activity recognition is an essential part of cardiac rehabilitation, the system will enable healthcare professionals to assess the activity level of the patient under their care during rehabilitation monitoring.



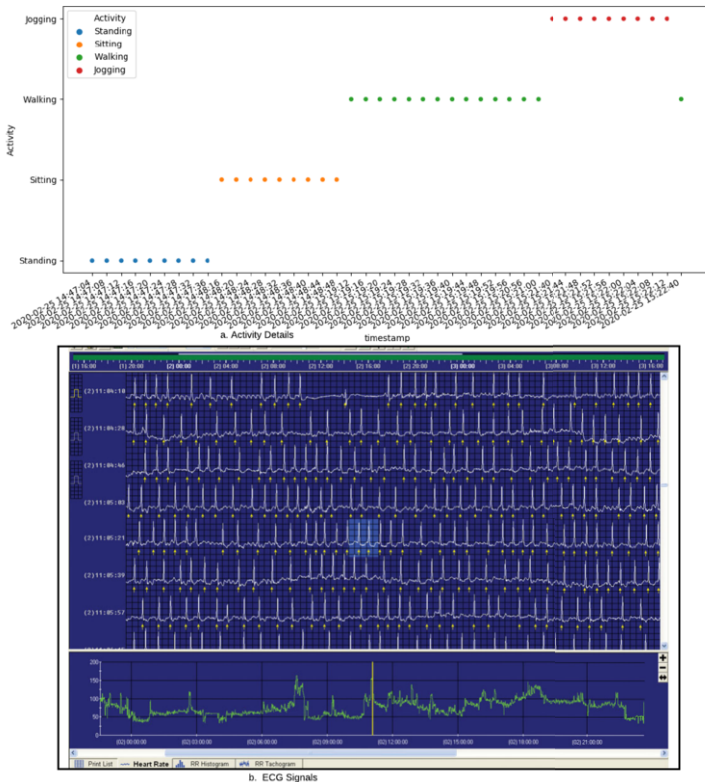

Figure 4. System Prototype Showing the (a) Activity Details and (b) ECG signals

## 8. Conclusion and Future Work

A prototype to illustrate a context-aware approach for cardiac rehabilitation monitoring is presented in this work. We considered the physiological information and activity details of the user in developing a context-aware system. The system could be used as a guide in the decision making process during rehabilitation. Due to the importance of activity recognition during the rehabilitation scheme, we automated the activity recognition process by training machine learning algorithm to automatically detect the activity of the user during the program. To present a robust activity recognition system, we personalised the process by using the individual dataset to train and test the algorithm.

In future, we will investigate more activities and experiment with more volunteers. Furthermore, as this is research in progress, we plan to implement a real-time activity recognition process and provide an interface for effective communication between the patient and the healthcare professional.

## References

- [1] Augusto J, Kramer D, Alegre U, Covaci A, Santokhee A. The user-centred intelligent environments development process as a guide to co-create smart technology for people with special needs. *Universal Access in the Information Society*. 2017;17(1):115–30.

- [2] Augusto JC, Quinde MJ, Oguego CL. Context-Aware systems Testing and validation. In 2019 10th International Conference on Dependable Systems, Services and Technologies (DESSERT) 2019 Jun 5 (pp. 7-12). IEEE.
- [3] Bessmeltsev VP, Katasonov DN, Mazurok BS, Makeev IV, Sluev VA, Morozov VV, Shevela AI. Mobile system for automated remote monitoring of cardiac activity. *Biomedical Engineering*. 2015 May 1;49(1):7-11.
- [4] Bhf.org.uk. (2019). British heart foundation UK factsheet. [online] Available at: <https://www.bhf.org.uk/-/media/files/research/heart-statistics/bhf-cvd-statistics-uk-factsheet.pdf?la=en> [Accessed 10 May 2019].
- [5] Cardiovascular diseases (CVDs) [Internet]. World Health Organization. WHO; [cited 2020 Mar3]. Available from: [https://www.who.int/news-room/fact-sheets/detail/cardiovascular-diseases-\(cvds\)](https://www.who.int/news-room/fact-sheets/detail/cardiovascular-diseases-(cvds)).
- [6] Denil M, Matheson D, De Freitas N. Narrowing the gap: Random forests in theory and in practice. In International conference on machine learning 2014 Jan 27 (pp. 665-673).
- [7] Forkan AR, Hu W. A context-aware, predictive and protective approach for wellness monitoring of cardiac patients. In 2016 Computing in Cardiology Conference (CinC) 2016 Sep 11 (pp. 369-372). IEEE.
- [8] Gay V, Leijdekkers P, Barin E. A mobile rehabilitation application for the remote monitoring of cardiac patients after a heart attack or a coronary bypass surgery. In Proceedings of the 2nd international conference on pervasive technologies related to assistive environments 2009 Jun 9 (pp. 1-7).
- [9] Health matters: preventing cardiovascular disease [Internet]. GOV.UK. [cited 2020 Mar3]. Available from: <https://www.gov.uk/government/publications/health-matters-preventing-cardiovascular-disease/health-matters-preventing-cardiovascular-disease>
- [10] Kitsiou S, Thomas M, Marai GE, Maglaveras N, Kondos G, Arena R, Gerber B. Development of an innovative mHealth platform for remote physical activity monitoring and health coaching of cardiac rehabilitation patients. In 2017 IEEE EMBS International Conference on Biomedical & Health Informatics (BHI) 2017 Feb 16 (pp. 133-136). IEEE.
- [11] Kunnath AT, Nadarajan D, Mohan M, Ramesh MV. wicard: A context aware wearable wireless sensor for cardiac monitoring. In 2013 International Conference on Advances in Computing, Communications and Informatics (ICACCI) 2013 Aug 22 (pp. 1097-1102). IEEE.
- [12] Li JP, Berry D, Hayes R. A mobile ECG monitoring system with context collection. In 4th European Conference of the International Federation for Medical and Biological Engineering 2009 (pp. 1222-1225). Springer, Berlin, Heidelberg.
- [13] Lockhart JW, Weiss GM. The benefits of personalized smartphone-based activity recognition models. In Proceedings of the 2014 SIAM international conference on data mining 2014 Apr 28 (pp. 614-622). Society for Industrial and Applied Mathematics.
- [14] Miao F, Cheng Y, He Y, He Q, Li Y. A wearable context-aware ECG monitoring system integrated with built-in kinematic sensors of the smartphone. *Sensors*. 2015 May;15(5):11465-84.
- [15] Mittal S, Movsovitz C, Steinberg JS. Ambulatory external electrocardiographic monitoring: focus on atrial fibrillation. *Journal of the American College of Cardiology*. 2011 Oct 18;58(17):1741-9.
- [16] Nguyen HH, Silva JN. Use of smartphone technology in cardiology. *Trends in cardiovascular medicine*. 2016 May 1;26(4):376-86.
- [17] Pierleoni P, Permini L, Belli A, Palma L. An android-based heart monitoring system for the elderly and for patients with heart disease. *International journal of telemedicine and applications*. 2014;2014.
- [18] Sannino G, De Pietro G. A smart context-aware mobile monitoring system for heart patients. In 2011 IEEE International Conference on Bioinformatics and Biomedicine Workshops (BIBMW) 2011 Nov 12 (pp. 655-695). IEEE.
- [19] Sarela A, Korhonen I, Salminen J, Koskinen E, Kirkeby O, Walters D. A home-based care model for outpatient cardiac rehabilitation based on mobile technologies. In 2009 3rd International Conference on Pervasive Computing Technologies for Healthcare 2009 Apr 1 (pp. 1-8). IEEE.
- [20] Shanmathi, N. and Jagannath, M., 2018. Computerised Decision Support System for Remote Health Monitoring: A Systematic Review. *IRBM*.
- [21] Varshney U. *Pervasive healthcare computing: EMR/EHR, wireless and health monitoring*. Springer Science & Business Media; 2009 Apr 21.
- [22] Yürür Ö, Liu CH, Sheng Z, Leung VC, Moreno W, Leung KK. Context-awareness for mobile sensing: A survey and future directions. *IEEE Communications Surveys & Tutorials*. 2014 Dec 18;18(1):68-93.

# IoT Architecture Proposal from a Survey of Pedestrian-Oriented Applications

Luís Rosa <sup>a,1</sup>, Fábio Silva <sup>b,a</sup> and Cesar Analide <sup>a</sup>

<sup>a</sup>ALGORITMI Center, Dep. of Informatics, University of Minho, Braga, Portugal

<sup>b</sup>CIICESI, ESTG, Politécnico do Porto, Felgueiras, Portugal

**Abstract.** The significant improvement in the field of Internet of Things (IoT) has made human life more sophisticated. In fact, the IoT is covering devices and appliances that support one or more common ecosystems, and can be controlled via devices associated with that ecosystem. This control is only possible by building an architecture. Whether in indoor or outdoor environments, IoT services are only available to individuals or pedestrians because a IoT architecture enables that the quality of its components (i.e. Cloud/Fog servers, protocol communication and IoT devices) and the way they interact are directly correlated in terms of effectiveness and applicability. This paper aims to provide a comprehensive overview of an architecture in pedestrian-oriented applications in an IoT environment. Moreover, our survey has taken into account the main challenges and limitations of each component of IoT technology.

**Keywords.** Pedestrian-oriented applications, Cloud Computing, IoT Architecture, Open-source IoT platform

## 1. Introduction

The underlying principle of the Internet of Things (IoT) is collaboration, which offers a convenient way to bring together players from private and public sectors, creating new business models and projects. The widespread adoption of smartphones and other mobile devices plays into this as well since so many people now carry or wear devices that support interactions with IoT-driven services. In fact, it represents a comprehensive environment that interconnects a large number of heterogeneous physical objects or things to the Internet and is supported for an high level architecture like Cloud-centric Internet of Things (CIoT), Hub-Centric or Smartphone-Centric with a range of electronic components (i.e. sensors, smartphones, etc) in order to enhance the efficiency of services such as smart human mobility services and other real-time ubiquitous computing applications.

Besides, recent developments in wireless technology have made communication more familiar and reachable to everyone. Along with this, Bluetooth technology and interconnected devices have changed the role of Bluetooth. *"The world is just starting to see now, Bluetooth is everywhere. All these things are being brought into the connected world, and it's all using this Bluetooth Smart."*, Suke Jawanda, a spokesman for the Blue-

---

<sup>1</sup>ALGORITMI Center, Dep. of Informatics, University of Minho, Braga, Portugal; E-mail: id8123@alunos.uminho.pt

tooth Special Interest Group. Both technologies are an action response to the growth of the IoT, improving spectrum efficiency, reducing latency, better mobility support and high connection density.

Independently of the type of connection (via Wireless or Bluetooth) we have the possibility to connect to the Internet or another device. And devices are increasingly relying on edge computing, or compute resources that are geographically closer to devices than traditional cloud resources [1]. Moreover, new applications require real-time computing power, and continue to drive edge computing systems. For instance, a Fog Computing (FC) architecture can represent an alternative to the centralized cloud service called Cloud Computing (CC), given that the connection is not guaranteed, and the continuously increasing number of connected devices represents a challenge for the connection bandwidth. Maybe an approach with multiple layers between the connected device and cloud services would be more appropriated.

Although there are several studies about components of IoT and smart cities, and the application fields of IoT-based solutions are plentiful, the convergence of these two areas needs further academic efforts for the thriving of IoT-based smart cities. For this reason, we are proposing an architecture which displays a set of components mentioned above. It brings together ubiquitous computing with sensors, and other devices such as smartphones, as well as, enabling the ability to connect any device and integrate a cloud with a range of online services in indoor or outdoor environments. The main driver of the communication combines Bluetooth Low Energy (BLE), Wireless Sensor Network (WSN), as well as protocol communications like Messaging Queue, Http or Socket without forgetting a Human Machine Interface (HMI). Therefore, it is beneficial to propose an IoT architecture that is appropriate and smart to handle individual or pedestrian contexts.

This paper is organized as follows. Section 2 addresses related work regarding a generic approach about components of IoT systems and where they can provide services to pedestrians or individuals. Section 3 focuses on the architecture of the IoT system proposed in this paper and a description of its main components. Finally, Section 4 presents the conclusion and future work.

## **2. Related Work**

A typical IoT solution is characterized by many devices (i.e. things) that may use some form of gateway to communicate through a network to an enterprise back-end server that is running an IoT platform that helps integrate the IoT information. This is only relevant if we apply it in real-life contexts. Therefore, we relate some contexts where the elements of IoT help pedestrians in their day-to-day life.

### *2.1. Components of IoT*

There are different ways to connect each IoT component providing specific features and functionality required by any robust IoT solution. One of the most promising architectures aims to connect a smart device, for instance, a sensor module using Raspberry Pi for monitoring and controlling the parameters of an industrial plant and energy management directly to the Wi-Fi network without needing any additional hub to work. Beyond the help of CC which is used to store data, in this cloud centric architecture there is no

need to install additional devices and it can be controlled from the smartphone [2]. Furthermore, the setup process is quite easy and straightforward for the user, but it relies on a connection to the Internet. Another alternative should be used. For instance, the *My Smart BT* project focuses on Android operating system-based Bluetooth Serial Port Profile (SPP) application [3], a smart device that is connected directly to a smartphone via Bluetooth and depends on the proximity of the other device. For real-time data transmissions between the connected devices they should be connected via Wireless internet. However, this architecture does not promote the data storage in a cloud computing platform. In turn, once many smart features could be set up without having a dedicated cloud infrastructure, in an hub-centric architecture a device cloud is also optional. For example, the *SensorHUB* framework provides a unified tool chain for IoT related application and service development [4]. SensorHUB is both a method and an environment to support IoT related application and service development; furthermore, it is an intermediary for connecting a smart device to another device and to the internet, since it usually connects to the Wi-Fi or Ethernet network.

The use of smartphones with control systems and the newest Mobile Network technology (5G), Wireless Fidelity (Wi-Fi) based on the IEEE 802.11 to Bluetooth 5.0 and standard-based low-power wide-area network (LPWAN) protocols are expected to take a big leap in terms of maturity and adoption in coming years [5]. However, if each of them work in an isolated way there are some limitations. First, although Mobile Network infrastructures have improved, enabling numerous devices requires extremely high performance interconnections under strenuous scenarios such as diverse mobility, extreme density, and dynamic environment but this is challenged by latency for some applications, expense and saturation in areas with high user density, whereas terrestrial mobile achieves the connectivity to indoor and ground-mobile users but is economically challenged when user density is sparse or intermittent [6]. The alternative, Wi-Fi, used for file transfers among most of the IoT devices and which includes any type of WLAN product support any of the IEEE 802.11 only serves as a means to enable indoor navigation, namely inside buildings, requiring a WiFi infrastructure. In turn, Bluetooth high-speed technology devices can deliver up to 24 Mbps of data, which is faster than the 802.11 WiFi standard, but slower than wireless-a or wireless-g standards, it is restricted to an indoor positioning area [7].

Because of the convergence of advanced infrastructures, driven by various devices in real-time communication, processing and storing are highly preferred for big data systems. Being part of a layered hierarchical architecture, computation and storage capabilities are distributed over a number of IoT devices that are located in proximity to the device layer. However, due to the location of the underlying IoT devices, which is very distant, the centralized cloud service is not suitable to perform real-time tasks, and some services can not tolerate the possible latency originating from this issue [8]. In other words, the explosive growth of internet-connected devices along with new applications that require real-time computing power continues to drive edge computing systems. Therefore, a decentralized cloud service could be a solution. Fog Computing (FC), first introduced by Cisco, resides in multiple layers between the device and Cloud service. It also represents an extension of traditional cloud-only models and not an alternative [2]. FC highlights the applications and services that include Commuted Vehicle, Smart Grid, Agriculture, Healthcare, Smart Cities, and, in general, Wireless Sensors and Actuator Networks (WSANs) [7]. Fig. 1 shows the conceptual architecture for fog com-

puting, which works as an intermediate layer between the cloud and the users to provide real-time communications.

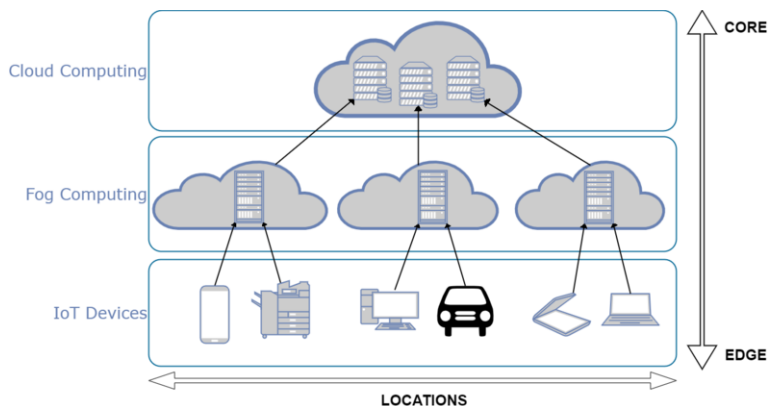

**Figure 1.** Fog/Cloud computing architecture between edge and core (adapted from [9]).

In this paper, it has been discussed how data is stored. In fact, data storage can be done locally on devices or in cloud storages. In the case of the cloud, to take better advantage of its architecture, some services have been developed such as Firebase, Google Cloud Platform (GCP), Deployd, Microsoft Azure or Amazon Web Services (AWS). But, for the purpose of this study, it should run in realtime from Android, iOS and Web applications, include flexible rules to define the data structured, security, handle big data charges and server-side processing and enable NoSQL Database. Moreover, it should provide a service that can authenticate users using only client-side code (decentralized authentication service), ability to deliver messages (MQTT, websockets) supporting protocols to different platforms, as well as bring Machine Learning and strategic features (e.g, event driven or streams) features to applications [10]. Therefore, all these microservice applications should be associated to a complex infrastructure - FaaS (Function-as-a-Service) - that enables code execution in response to events.

The use of Internet of Things (IoT) in this type of cloud-computing service can be presented in multiple case studies. For example, [11] covers how to build IoT applications using arduino sensors and the power of Cloud. Focused on the various issues associated with the idea of Smart City, members of the ALGORITMI Center, Department of Informatics, University of Minho have developed the *SafeCity* project. It offers, among others, traffic flow forecasts; smart notifications (via MQTT); a city map based on the quantification of positive and negative feelings of its citizens and gamification engine to support and promote user engagement. This mobile application is specially focused on data collection and on fulfilling the entire Machine Learning pipeline. In [12] a comparison framework illustrates some factors to compare Fog and Cloud computing data transmission from the edge to the core level of the IoT environment and estimate the dataset with two factors: latency and accuracy analysis.

In summary, features discussed and justified in the given use cases include latency, hardware compatibility, data management and integration of different types of components (i.e. sensors, smartphones, computers and servers). For our study, these components provide more benefits using a decentralized architecture, because each of them is responsible for one of the activities (e.g. monitoring, analysis or collection of data) of the

system, performing its functionality locally, but coordinated with peers. Therefore, once the features of an IoT application are known we will propose a new architecture.

## 2.2. Pedestrian Sensing

The proliferation of technological innovations has led to cities becoming "smart", hence the term "smart cities". And this idea is emerging day by day, once there is an intelligent and sustainable infrastructure in cities that is integrated with advanced technological solutions [13]. Besides 66% of the world population is expected to live in urban areas by 2050 [14]. Thus, it has become an important issue to keep track of footpath traffic and environmental parameters for urban planning, retail development, major event crowd assessments, pedestrian safety, traffic flow management and assessments of street development.

There are projects focused in people counting in high streets and city centres. They provide both real-time and historical data for big data analytics. Business-people looking to open a new shop or restaurant could be given accurate figures for footfall past their proposed location to help them assess the potential for their new venture. Other projects focused in occupancy counting inside public buildings and shopping centres were also implemented via thermal cameras, sensors and Wi-Fi [15] probe requests [16].

Smart Counters are attached to lampposts around the city. They have a wide range of applications in the surveillance of potential areas for the detection of unusual events, tracking customers in retail stores to control and monitor the movements of assets, monitoring elderly and sick people staying at home alone, to recognize and track people [17]. Furthermore, the process of counting people is complicated and very costly in terms of computing and money [18]. For example, in video camera technique, the number of people are determined on the image processing algorithm, allowing an accuracy rate of up to 95% for an indoor surveillance environment and 85% for outdoor applications [19]. Another popular method for human detection is thermal cameras. It is used for vehicle detection, spot smoldering fires inside a wall and detecting overheating electrical wiring. It retrieves information about temperature differences, detecting the infrared energy emitted by an object.

In turn, sensing technology is also used for the identification of objects and people. Among several applications, some potential applications are occupancy counting in smart buildings, bus and railway stations, smart parking systems and the amount of traffic at any given time and counting bicycles [20,21]. A pedestrian crossing is a part of the road painting and is designated for pedestrians to cross a road. Crosswalks are also usually situated where a considerable number of pedestrians is trying to cross a road, for instance near shopping areas, or where exposed road users (such as school children) frequently cross [22]. All this information projects open opportunities for cities to also provide the information directly to the public. Having this sort of information lets people avoid the busiest areas and help reduce any issues on the road, railway stations and helps monitor and support the promotion of healthy travelling and gives a measure of how green or pollution-free areas are within a city centre, or to monitor the effectiveness of sports activity, events and jogging routes within parks where specific rules are needed for the use of pedestrian crossings to ensure safety for example.

These human counting and tracking projects are conducted via broadcasted signals from devices such as smartphones, laptops and tablets. Although the usage of mobile

communication covers a more extended range compared to Wi-Fi or ZigBee [23]. However, both build huge collect data infrastructure, enabling, for instance, an adequate understanding of the ongoing trends of pedestrian activity, helping in planning and responding to emergencies, and the city planner in making decisions quickly or being able to differentiate the peak and off-peak hours of individual zones and track zone-level occupancy tracking [24]. In addition, the data collected is transferred to the server and uploaded on the website for the public, but after some time, we will have enough IoT big data to help quantify the use of footpaths and cycle ways. This creates a city that uses technology to meet the complex needs of pedestrians.

### 3. IoT Architecture Proposal

In subsection 3.1, we discuss the differences between our IoT architecture and other IoT solutions. During the comparison the component's functionality are the key areas that are compared with other IoT architecture proposals. In the following subsection (3.2), the main components of the proposed IoT system are subdivided into four levels: Sensing layer, Network Layer - mainly describes the type of connects between a circuit of Iot devices which is also connected to the Internet - Data Processing Layer, although at a high level, approaches an online server/database architecture and, finally, Application layer.

#### 3.1. Comparison of IoT Platforms

Reflecting each parameter described in Table 1, our IoT architecture matches or adds components that already exist or are considered an innovation within others proposed platforms. From a summarized overview of the comparison, for example, although mentioned within the documentation, IoT Device component is not represented within the architecture of the IBM Watson IoT Platform [25]. Besides, the platforms Sitewhere, Amazon WebService IoT, and the Microsoft Azure IoT Hub further distinguish the concept of "Intelligent" Devices, which have already some kind of logical functionality included. In our architecture that kind of Devices are covered by IoT Device and IoT Middleware components.

**Table 1.** Comparison of various IoT platforms (adapted from [26]).

	<i>Microsoft Azure</i>	<i>Amazon Web Services</i>	<i>IBM Watson IoT</i>	<i>Things.io</i>	<i>SiteWhere</i>
<b>Protocols</b>	HTTP, AMQP and MQTT	HTTP, MQTT and WebSockets	HTTP and MQTT	HTTP, MQTT, CoAP and WebSockets	HTTP, AMQP and MQTT
<b>Hardware</b>	Intel, Raspberry Pi2, Freescale and Texas Instruments	Broadcom, Marvell, Renesas, Texas Instruments, Microship and Intel	ARM, Texas Instruments, Raspberry Pi and Arduino Uno	Hardware agnostic	Hardware agnostic
<b>SDK Language</b>	.Net and UWP, Java, C and NodeJS	Java, C and NodeJS	C#, C, Python, Java and NodeJS	Python, NodeJS, MQTT, NodeJS HTTP, NodeJSCoAP and Joiled Node	Java, Vue, JavaScript, TypeScript and Smarty
<b>3<sup>rd</sup> party Integration</b>	REST API	REST API	REST API	REST API	REST API
<b>Dashboard</b>	Yes	Yes	Yes	Yes	Yes

Obviously, each platform represents the core functionality, i.e., our IoT Middleware within the architecture. The differences lie in the granularity and the number of the components which make up the functionality of the IoT Middleware. Furthermore each plat-



form enables the connection of further Applications. However, we also propose to split the location of big data storage in two ways: Fog Computing (FC) or Cloud Computing (CC). This mean that in the context of pedestrian-oriented application development user can access and share information in anyway and anywhere.

### 3.2. Components of the IoT architecture

This section explains the IoT architecture proposal in detail which maps the descriptions with different architecture areas. We start by defining all components shown in Fig. 2 starting from the top. To clearly distinguish between the concepts presented in this work and similar or equal related architectures mentioned in previous section, we highlight the elements of the reference IoT architecture presented in this work using italics.

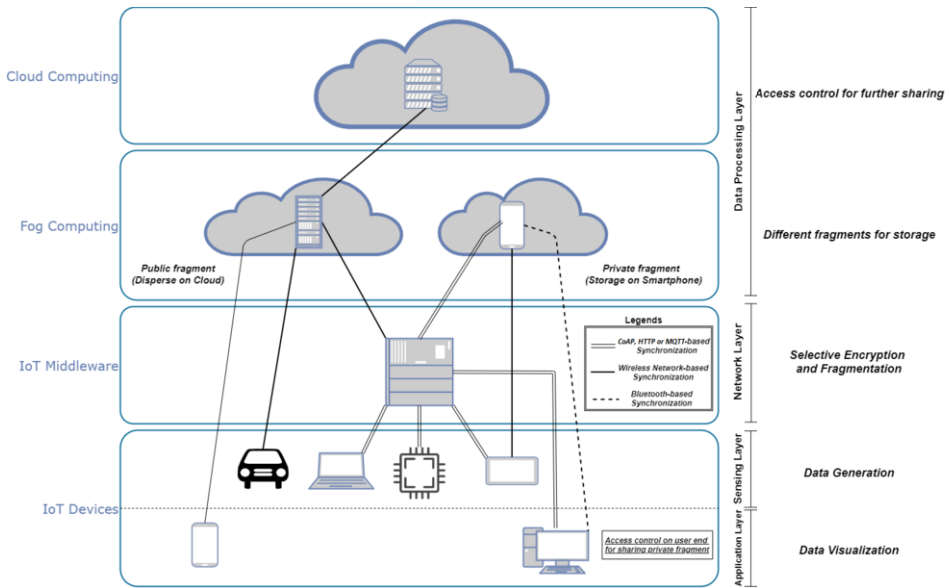

Figure 2. Architecture proposal for pedestrian-oriented applications.

#### 3.2.1. Sensing Layer

In this layer we can include the Data from *IoT Devices* and Commands to *IoT Devices* components of our reference architecture. Devices are either (i) self-contained or (ii) connected to another, bigger system. The *IoT Middleware* represents such a system. Furthermore, they also represent our Sensor and Actuator components. In crowd sensing, the arduino is one the most interesting boards in the sensor family. It is easily connected to a computer and uses the Arduino IDE. It has a built-in antenna and its format is ideal for prototyping environments, fitting easily into a protoboard. Moreover, it integrates a set of sensors like temperature or motion sensors and is used for the collection of data from an object of measurement. Also, the IoT mobile device in this case study can be based on smartphones, smartwatches or other devices where Wireless and Bluetooth connectivity is used for synchronizing mobile devices and transferring data.

### 3.2.2. Network Layer

We propose an action-based framework that acts as middleware (or controller) between the user and smart appliances and which allow the user to control these heterogeneous devices in a federated manner. This middleware maintains the integrity of an instruction sent to the device and employs the mechanism so that only authenticated users can access them. Additionally, it is the central entity of our proposed framework, running on a machine in the vicinity of a FC and CC smart network. We also incorporate Android, IOS or Web applications which receive input from the Human System Interaction (HSI) in smart home appliances.

Although they are not explicitly depicted within the architecture, devices can communicate with the platform via different protocols (i.e. CoAP, MQTT, and HTTP). Based on this, we propose our architecture and the mapping of the open-source IoT platform SiteWhere onto our reference architecture. In this type of IoT platform the concept of a Gateway is present between the devices and the platform [27], but not pictured as a separate component. The main functionality of the platform is provided by the Device Management and the Communication Engine. Consequently, those components are considered the *IoT Middleware* of our reference architecture. The REST APIs and Integration component enables the connection of further Applications to the platform.

### 3.2.3. Data Processing Layer

Assuming all smart devices and smartphones can communicate using different protocols like HTTP protocol, socket or MQTT via Bluetooth or Wireless with this controller, or directly between another smart device (private fragments), other devices can be connected directly with controllers located from outside the home network (public fragment). They offer a service on the fog platform to cater for the need of powerful computation and big data storage capabilities from the form of REST API service. Therefore, this service has a major role to transfer data from edge device (IoT Device) to Fog node and from Fog node to Cloud (Internet).

Increasing device density generates a lot of data and poses new challenges for the IoT infrastructure. For data transmission in a *Fog server*, a smartphone or server is needed. These devices access the user's storage as Fog storage via API. Other features are supported, such as encryption, authentication, and cloud data storage, it is ideal for access control, storage and efficient sharing in real-time. Another advantage is it uses the HTTPS communication protocol that supports bidirectional communication encryption between a client and server. Therefore, in our architecture we will use Software as a Service (SaaS) to relieve this pressure of Big Data Storage, beyond allowing users to connect to the applications through the Internet on a subscription basis, a private fragment for storage on smartphone and a public fragment to disperse on Cloud as privacy policy, using a NoSql Database mainly as a Big Data Sharing centre.

### 3.2.4. Application Layer

The Application component represents software which uses the *IoT Middleware* to gain insight into the physical environment, manipulate the physical world and is responsible for delivery of various applications to different users in IoT. It also implements and presents the results of the data processing layer to accomplish different applications of IoT devices. Moreover, it does so by requesting Sensor data or by controlling physical

actions using Actuators. The role of this layer is to use the data collected from temperature sensor, flow meter and Global Positioning System (GPS) positions, and other data sources that was sent to the Cloud service. And finally, the application user interface receives this information, and must take the required decisions and can also request additional information from the application.

#### 4. Conclusion and Future Work

A more reliable Internet of Things (IoT) architecture is proposed in this paper. The proposed improved layered architecture of IoT is made up of four layers, and there is a sort of function distribution on each layer. It involves an entire ecosystem of tools and services that come together to deliver a complete solution. Knowing its key components and how to integrate them to guarantee a robust and optimized architecture will be a challenge. Regardless of the use case, it should involve at least devices, connectivity, gateways and edged compute. While IoT devices make up the physical hardware component of our solution, connectivity is fundamental for them to send state data and receive commands from our decentralized platform.

Moreover, there are a set of options for how device-to-platform connection is made and it depends on the environment and constraints of the device. This is, if the device is outside and moving around we use cellular connectivity. In indoor environments, Ethernet or Wi-Fi connectivity is a better option. For battery-powered devices lower energy options must be used like Bluetooth or LPWAN. And finally, in gateways and edge compute, in some cases the devices can't connect directly to the central cloud platform or other platforms in intermediate layers and instead require the use of an IoT gateway to bridge the gap between local environment and platform. This gateway is required when using Wireless technologies like Bluetooth and LPWAN, since those don't provide any direct connection to the network or the Cloud. Therefore, due to its reliability and feasibility the proposed layered architecture is useful to many kinds of applications. In future work, there will be a focus on building new model applications based on this proposed IoT architecture.

#### References

- [1] I. Bdt, The Internet of Things: data for development, Technical Report, ITU Internet, 2015.
- [2] P. Battistoni, M. Sebillio and G. Vitiello, Experimenting with a fog-computing architecture for indoor navigation, in: *2019 4th International Conference on Fog and Mobile Edge Computing, FMEC 2019*, 2019, pp. 161–165. ISBN ISBN 9781728117966. doi:10.1109/FMEC.2019.8795307.
- [3] M. Mor, J. Kaur and S.R.N. Reddy, My Smart BT: A Bluetooth-based android application for controlling IoT appliances using graphical analysis of sensor data, *International Journal of Mobile Network Design and Innovation* (2017). doi:10.1504/IJMNDI.2017.089300.
- [4] L. Lengyel, P. Ekler, T. Ujj, T. Balogh and H. Charaf, SensorHUB: An IoT driver framework for supporting sensor networks and data analysis, *International Journal of Distributed Sensor Networks* (2015). doi:10.1155/2015/454379.
- [5] K. Mekki, E. Bajic, F. Chaxel and F. Meyer, A comparative study of LPWAN technologies for large-scale IoT deployment, *ICT Express* 5(1) (2019), 1–7. doi:10.1016/j.ict.2017.12.005.
- [6] M. Giordani, M. Polese, M. Mezzavilla, S. Rangan and M. Zorzi, Towards 6G Networks: Use Cases and Technologies, *IEEE Communications Magazine* (2019), 8. <http://arxiv.org/abs/1903.12216>.

- [7] Y. Perwej, M. Ahmed, B. Kerim and H. Ali, An Extended Review on Internet of Things (IoT) and its Promising Applications, *Communications on Applied Electronics* **7**(26) (2019), 8–22. doi:10.5120/cae2019652812.
- [8] Y. Abuseta, A Fog Computing Based Architecture for IoT Services and Applications Development, *International Journal of Computer Trends and Technology* **67**(10) (2019), 92–98. doi:10.14445/22312803/ijctt-v67i10p116.
- [9] I. Stojmenovic and S. Wen, The Fog computing paradigm: Scenarios and security issues, in: *2014 Federated Conference on Computer Science and Information Systems, FedCSIS 2014*, 2014, pp. 1–8. ISBN ISBN 9788360810583. doi:10.15439/2014F503.
- [10] C. Khawas and P. Shah, Application of Firebase in Android App Development-A Study, *International Journal of Computer Applications* (2018). doi:10.5120/ijca2018917200.
- [11] F. Azzola, ESP8266 (ESP32) With Firebase Real-Time Database: IoT-Controlled RGB LEDs - DZone IoT, 2019, p. 1. <https://dzone.com/articles/esp8266-esp32-with-firebase-realtime-database-iot>.
- [12] M.M. Islam, M. Rahman, A.B. Rabin, M. Golam and S. Bhuyan, International Journal of Advanced Research and Publications Performance Analysis Of FOG And Cloud Computing Data Transmission System In Iot Environment, *International Journal of Advanced Research and Publications* **3**(4) (2019), 95–98.
- [13] T. hoon Kim, C. Ramos and S. Mohammed, Smart City and IoT, Vol. 76, Elsevier B.V., 2017, pp. 159–162. ISSN 0167739X. doi:10.1016/j.future.2017.03.034.
- [14] H. Schaffers, N. Komninos, M. Pallot, B. Trousse, M. Nilsson and A. Oliveira, Smart cities and the future internet: Towards cooperation frameworks for open innovation, *Lecture Notes in Computer Science* **6656** (2011), 431–446. ISBN ISBN 9783642208973.
- [15] Gratton. D.A, WiFi Alliance, 2007, pp. 181–215. ISBN 9781555583101. doi:10.1016/B978-155558310-1/50016-1. <http://www.wi-fi.org/certification/programs>.
- [16] C. Laoudias, A. Moreira, S. Kim, S. Lee, L. Wirola and C. Fischione, A survey of enabling technologies for network localization, tracking, and navigation, Vol. 20, 2018, pp. 3607–3644. ISSN 1553877X. doi:10.1109/COMST.2018.2855063.
- [17] D. Roqueiro and V.A. Petrushin, Counting people using video cameras, *International Journal of Parallel, Emergent and Distributed Systems* (2007). doi:10.1080/17445760601139096.
- [18] J.H. Ziegeldorf, O.G. Morchon and K. Wehrle, Privacy in the internet of things: Threats and challenges, *Security and Communication Networks* **7**(12) (2014), 2728–2742. doi:10.1002/sec.795.
- [19] O. Sidla, Y. Lypetsky, N. Brändle and S. Seer, Pedestrian detection and tracking for counting applications in crowded situations, in: *Proceedings - IEEE International Conference on Video and Signal Based Surveillance 2006, AVSS 2006*, 2006. ISBN ISBN 0769526888. doi:10.1109/AVSS.2006.91.
- [20] V. Paidi, H. Fleyeh, J. Håkansson and R.G. Nyberg, Smart parking sensors, technologies and applications for open parking lots: A review, *IET Intelligent Transport Systems* **12**(8) (2018), 735–741. doi:10.1049/iet-its.2017.0406.
- [21] A.M. Ibrahim, I. Venkat, K.G. Subramanian, A.T. Khader and P. De Wilde, Intelligent evacuation management systems: A review, *ACM Transactions on Intelligent Systems and Technology* (2016). doi:10.1145/2842630.
- [22] G. Pau, T. Campisi, A. Canale, A. Severino, M. Collotta and G. Tesoriere, Smart pedestrian crossing management at traffic light junctions through a fuzzy-based approach, *Future Internet* (2018). doi:10.3390/fi10020015.
- [23] Zigbee Alliance, Home - Zigbee Alliance, 2019. <https://zigbeealliance.org/>.
- [24] B.S. Çiftler, S. Dikmese, I. Güvenç, K. Akkaya and A. Kadri, Occupancy Counting With Burst and Intermittent Signals in Smart Buildings, *IEEE Internet of Things Journal* **5**(2) (2018), 724–735. doi:10.1109/JIOT.2017.2756689.
- [25] J. Guth, U. Breitenbücher, M. Falkenthal, P. Fremantle, O. Kopp, F. Leymann and L. Reinfurt, A detailed analysis of iot platform architectures: Concepts, similarities, and differences, *Internet of Things* **0**(9789811058608) (2018), 81–101.
- [26] P.P. Ray, A survey on Internet of Things architectures, Vol. 30, 2018, pp. 291–319. ISSN 22131248. doi:10.1016/j.jksuci.2016.10.003.
- [27] SiteWhere LLC, SiteWhere: System Architecture, 2019, pp. 1–5. <https://sitewhere.io/docs/2.1.0/guide/architecture/>.

# A Soft Context-Aware Traffic Management System for Smart Cities

Davide CARNEIRO<sup>a,b,1</sup>, António AMARAL<sup>a</sup> and Mariana CARVALHO<sup>a</sup>

<sup>a</sup>CIICESI, Escola Superior de Tecnologia e Gestão, Instituto Politécnico do Porto, Felgueiras, Portugal

<sup>b</sup>Algoritmi Centre/Department of Informatics, Universidade do Minho, Portugal

**Abstract.** The number of large cities is growing, as well as their inhabitants. As population density increases, so do the challenges of managing these spaces. Current cities, both large and small, have to deal with decreasing air quality, noise and air pollution, traffic congestion, and countless other issues that decrease citizens' quality of life. In this paper we propose a soft system for traffic management for smart cities. Context awareness is provided by a connection to city sensors. Traffic management is done by intelligent routing of vehicles, prioritizing not the individual's travel distance or speed, but the overall routes. Thus, routes are defined according to the city's management policies, and may allow to minimize traffic or pollution in certain areas, dynamically. That is, without explicit Human intervention. Such a system may be useful in improving the quality of life in the city for all citizens.

**Keywords.** Smart Cities, Traffic Management, Optimization, Graph, Shortest Path

## 1. Introduction

The current population growth phenomenon is being, somehow, responsible for the current way of life within urban areas. Therefore, cities are being challenged towards, properly, handling the negative externalities felt on the environment, as well as on the citizens' lifestyles and on the governance options [13]. Along the 20th century, the population living in cities increased from 220 million to nearly 2.8 billion, and according with the available forecasts in 2050, that figure will raise to about 6.9 billion, which will be close to almost 70% of the world's population [15].

Motivated partly by this social evolution in recent years, the concept of smart cities (SC) emerged. SC have been attracting an unprecedented amount of attention among different stakeholders, especially those within academia, industry and public policy making. This is mostly due to its major implications in urban planning and design, sustainability, social digitalization and cities' smart governance practices [18,1].

For that reason, it can be said that the smart city concept primary emerged as a solution to solve the problems associated with the exponential growth of urbanization [13]. Smart cities are expected to efficiently manage the growing level of urbanization,

---

<sup>1</sup>CIICESI, Escola Superior de Tecnologia e Gestão, Instituto Politécnico do Porto, Felgueiras, Portugal; E-mail: dcarneiro@estg.ipp.pt

and the amount of energy consumed, improving the citizens' economic standard, as well as raising people's awareness and capabilities to efficiently use and embed information and communication technologies (ICT) [16].

Smart cities will employ information and communication technologies towards being able to contribute for the improvement of citizens' quality of life, enhancing the overall wealth creation. They also favor the adjustment to the proper mobility solutions which could ease up the traffic management, reducing its environmental impacts, and enhancing the amount of interaction with the official authorities in charge [7,16].

Notwithstanding, the amount of complex problems that need to be handled and tackled within the smart cities' ecosystem are favoring the adoption of new technological approaches in which cities could use Big Data in transportation to guide the creation of sustainable and safer traffic systems [10]. These approaches, based in the emergence of IoT devices and the appearance of new data sources will make it possible to examine and predict traffic conditions with an utmost accuracy. This will definitely help to optimize the design of transport services management in a future automated city [9], which will play an important role in the adoption of modern Intelligent Transportation Systems (ITS), as well as in solving problems such as congestion control and peak load reduction [10].

It will also facilitate the construction of an eco-friendly environment by optimizing the vehicles' route planning [12,7], and thus the smart parking approaches that could alleviate the deadlocks in parking problems [16], as well as to create cities with low to zero carbon emissions, through the adoption and development of sustainability practices [15] and by ensuring the alignment of smart cities with the UN sustainable development goals [7].

The best practices, within the context of a smart city, usually highlight an anthropocentric approach for the development of a truly smart and sustainable city [17]. Therefore, the smart city's roadmap path should include and develop the adoption of green approaches which could support the urban development, establishing the proper conditions to ensure the attainment of a sustainable future [6].

In this paper we propose a system developed in accordance to these principles. It considers data from different sources, including sensor streaming data (e.g. environmental sensors, parking availability) and batch data (e.g. map information) and stores it in a way that facilitates the creation of services focused on facilitating traffic management. The main goal is not only for city managers to have access to live data, but also to take decisions that effectively influence traffic management in the city, in order to optimize a specific cost function.

This paper describes the proposed architecture, an implementation of a first prototype, and an example of using this architecture for developing a specific citizen-centric specific service. With the proposed service, a driver can input the desired destination, and the best parking lot will be suggested, as well as the best route there. In this case, the term *best* includes the optimization of the route according to the city's policies (i.e. not necessarily the shortest route) and the prediction of the number of free places in the parking lots, in order to reduce the negative effect of drivers searching for a parking place.

## 2. Problem Statement

As addressed in Section 1, cities are growing in population, and this rises significant and numerous challenges. One of them is clearly traffic management, which impacts negatively the efficiency of the transportation systems, air and life quality, among others. This paper focuses on the problem of traffic management.

Currently, traffic management in cities is done through legislation, and implemented using traffic signs, traffic lights, and similar elements. This traditional way of managing traffic is rather static in the sense that changes are slow and very rare. For instance, if the city intends to decrease traffic in a given central area, it may place traffic signs that forbid or limit the access of certain types of vehicles at given times of the day. On the one hand, this measure will take some time to implement and have associated costs. On the other hand, the measure is not context-aware in the sense that shall pollution or noise limitations be exceeded outside the defined time period, vehicles will still enter that area.

The main goal of this paper is to propose a soft traffic management system, that can complement these traditional measures. It considers a set of services for optimizing traffic at a city level. For instance, instead of each driver optimizing her/his own route through the city, a common route-finding service is used that takes into consideration not only the preferences of the driver (e.g. shortest path, quickest path) but also the preferences and policies of citizens and city managers (e.g. decreasing pollution, noise or traffic in a given area). This might result in some individual situations that are not optimized, but will result in an overall improvement towards the city.

We deem this approach *soft* traffic management in the sense that it does not really enforce decisions. Say a driver uses this route-finding algorithm to go from point A to point B. If the driver is not satisfied with it she/he can always resort to her/his own GPS application and follow a preferred route. However, as citizens gain an increased conscience about the role and impact of each individual on the society, and the importance of Social Capital [4], this kind of systems will gain increased relevance. At the same time, cities can also give back to citizens who decide to contribute to the common cause, namely by providing city services at discount prices, or through other motivators.

Finally, in an era in which driving is becoming autonomous, this kind of systems can be more easily implemented, namely through legislation that could force autonomous cars to abide by the rules and policies of each city they are driving in.

Thus, we believe that the proposed system may be of interest for implementing a wide range of citizen-centric services, that will positively impact the quality of life in cities.

## 3. Architecture

The proposed architecture for addressing the problem described in Section 2 is a layered one (Figure 1). The lowest layer is the *Data Ingestion* one and it includes services for connecting to two types of data sources: streaming and batch.

Streaming data sources include sensors such as environmental sensors to measure air pollution, temperature and humidity sensors, among others. Batch data sources include historic or static data sources, such as city maps, datasets of parks occupation, among others.

Once a connection to a data source is established, a *Data Transformation* stage may ensue. This may include some common data pre-processing tasks (e.g. remove missing data, filters, imputing values) or some more complex and specific tasks such as aggregations. Data transformation pipelines are thus defined *per* data source and are executed whenever new data is obtained from the respective data source.

Next there is the *Storage Layer*. We consider two types of data stores: a relational database and a graph database. The relational database are used to store objects such as historic sensor data or system meta-data (e.g. city management preferences). A MySQL database is used for this purpose.

The graph database, on the other hand, is used for storing connected data such as map information. Graph databases have been a great alternative to relational databases, especially when dealing with complex interconnected data sets. Graph databases offer high scalability, performance and flexibility advantage [11]. In the case of this work the Neo4j database is used. This is a graph database composed of nodes and relationships. Each node represents an entity and each relationship represents how two nodes are related. Neo4j also provides a web-interface and the cypher query language to conduct database operations against the data model.

Once data is stored in either of these databases, it becomes available to be used by the services that are developed and run in the *Service Layer*. A Microservice approach is followed for the development of these services in which functionalities will be implemented separately, by concern. Services can be used in two ways: by composing them to create higher-level services and through requests received from the API.

The *API layer* is the topmost layer and provides access of external applications to the services developed. An example of an application developed using existing services is described in Section 5. The web User Interface (UI), used by the city managers, is also powered by this API. The UI allows for city managers to visualize the state of the city in real time as well as to set or change city management policies (e.g. optimization functions).

#### 4. Intelligent Path Finding Service

This section describes the implementation and functionality of one of the core services: the Path Finding Service. This service, as opposed to traditional driver routing services, does not aim to optimize the path for a specific driver. Instead, it will provide a path that takes into consideration driver preferences (e.g. shortest path, quickest path) but in the frame of city state and management policies. So, a driver may not be directed through the shortest route if this route goes through a pollution hotspot at that time. This section describes the whole process from data acquisition to its use by the driver's navigation system.

The base data that supports this service was acquired from OpenStreetMaps (OSM). OSM is an open source project that provides free geographic data. In OSM, data is represented as nodes, ways or relations. A node represents a point on the earth's surface, and it contains information about the unique identifier of the point (id number), a pair of coordinates (latitude and longitude) and tags with additional information (set of key/value pairs). A way represents linear features and boundaries and it consists of an ordered list of nodes. A relation represents additional information of both elements, nodes and ways, to explain how elements work together.



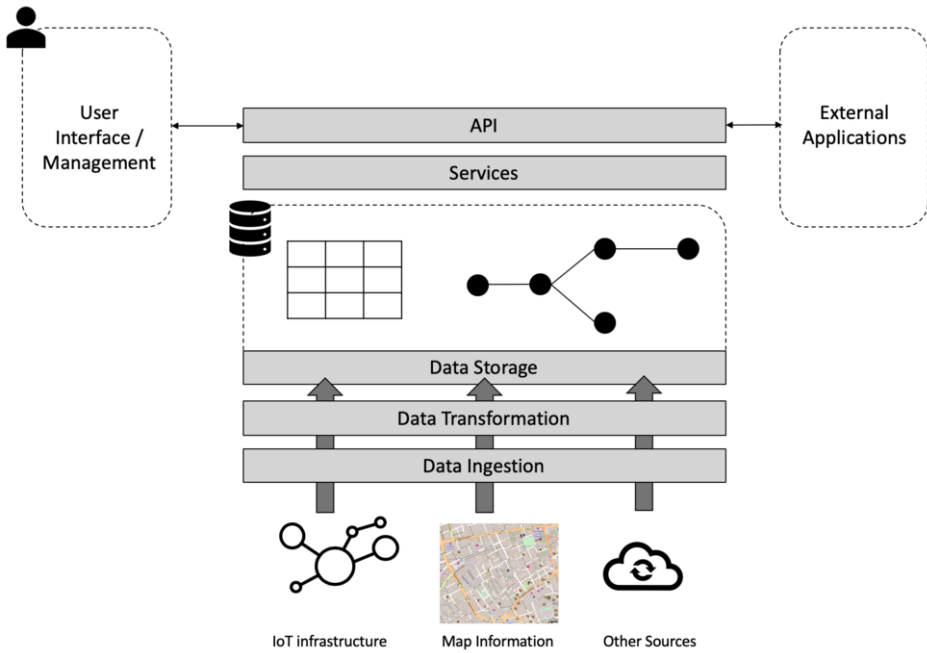

**Figure 1.** Overview of the main elements of the proposed architecture.

Data was extracted from OSM using the Overpass API, which is an OSM provided tool that allows to get the OSM data through an XML query, and it was stored on the graph-database.

A region which includes the whole city of Porto, in Northern Portugal, was selected to extract data. For this area all the nodes and waypoints were acquired.

Next, in the Data Transformation stage, data that was not relevant was excluded, including nodes or waypoints that referred to pedestrian or other types of paths (e.g. steps, cycle ways). New variables were also added to the data. These include the distance between each to connected nodes, calculated through the Haversine Formula [14]. After calculated, distance is normalized (min-max normalization). Three other variables were also added, which quantify three important measures: pollution level, noise level and congestion level. When the data is added these variables are set to 0. The value 0 means the absence of the phenomenon (e.g. low or no congestion) and the value 1 means a very high or critical level. Once the data is transformed it is stored into the graph database.

The Intelligent Path Finding Service is thus implemented as follows. The main goal is, as mentioned previously, to find the *best* path between two points. The notion of *best* is, however, not the traditional one (e.g. shortest, quickest). Here, the quality of a path is given by an optimization function that will take into consideration the characteristics of the path and the city's traffic management preferences.

Traffic management preferences are defined by city managers through the UI. Managers do so by creating a weights vector  $W$  that includes four values:  $w_d$ ,  $w_n$ ,  $w_c$  and  $w_p$  ( $w_d + w_n + w_c + w_p = 1$ ). These variables represent, respectively, the weight of distance, noise pollution, congestion and air pollution. So, if the city manager wants to prioritize the minimization of noise, she/he may attribute weights of 0.1, 0.7, 0.1, 0.1. On the other

hand, a weights vector of 1,0,0,0 would hold results similar to the drivers' individual navigation services.

In order to find the best path, this service uses a modified version of the Dijkstra algorithm [2]. Specifically, the concept of *distance* is now given by a weighed sum of the properties of the way (geographical distance, pollution, noise and congestion). Thus, paths will tend to reflect the city managers' preferences.

A change in the preferences of the managers and/or on the state of the city (e.g. an increase in the level of pollution or traffic in a given area) will thus lead to potential different routes. More importantly, these routes do not optimize the path of each individual driver in the city but optimize all their paths, according to the city's preferences.

## 5. Validation

This section describes the validation that was conducted of the architecture and of the Intelligent Path Finding Service. Validation was carried out in two ways: through the development of a prototype of the User Interface; and through the development of an external application that uses the service. Given that, at the time of the writing of this paper, we still had no access to real sensor data, this section also describes how data was generated to validate the proposed approach.

### 5.1. User Interface

Given the absence of sensor data, we opted to simulate these data by allowing city managers to define their own areas of pollution, congestion or noise. On the one hand, they can do so in order to simulate actual pollution/noise/congestion hotspots in the city. On the other hand, this simulation tool can also be used to analyze different scenarios and how traffic would be routed.

To insert a hotspot, a city manager has two options. Under the first one, he selects the desired type of hotspot (i.e. pollution, noise or congestion), defines its severity (a number between 0 and 1), clicks a point in the map, and then drags to create a circle with a given radius. The effect of this is that all nodes and connections inside the circle will be updated with a new value for the selected phenomenon. The intensity of the phenomenon decreases from the center to the edge of the circle, proportionally to the distance to the center.

Under the second option, the user may select a group of nodes (such as a specific road) and create a hotspot that is not circular but that applies only to the selected nodes. This second option is mostly used for signaling congestion.

Figure 2 shows three excerpts from the UI. Figure 2 (a) shows the definition of a new air pollution zone in a given region of the city. Figure 2 (b) shows how traffic is routed between two specific points if the preferences of the city favor the minimization of traveled distance ( $W = 1, 0, 0, 0$ ). Figure 2 (c), on the other hand, shows traffic routing if preferences favor the minimization of air pollution ( $W = 0, 0, 0, 1$ ).

### 5.2. Integration of Intelligent Path Finding Service

In order to validate the integration of the Intelligent Path Finding Service, a specific application was developed. The main goal of the application is to find the most adequate parking spot for a driver in a given area of the city.

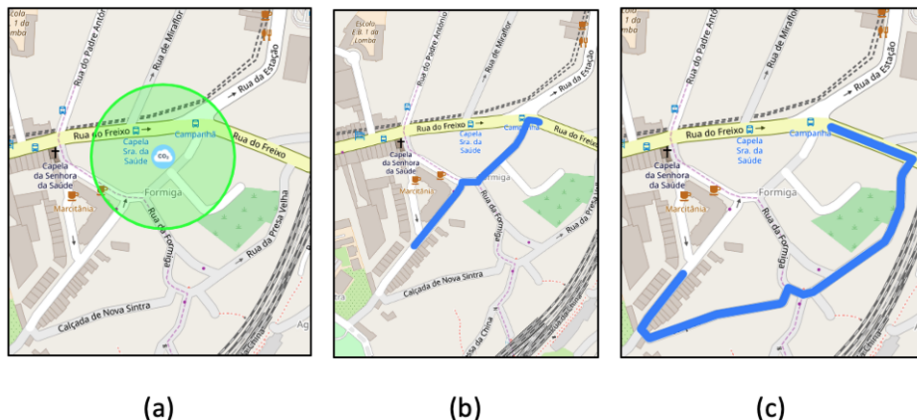

**Figure 2.** Details of the prototype of the interface: (a) creating a hotspot of pollution in a given region of the city; (b) traffic routing with  $W = 1, 0, 0, 0$  (minimizing distance); (c) traffic routing with  $W = 0, 0, 0, 1$  (minimizing air pollution).

To implement this application, historic data from several parking spots was used. Specifically, data from the Santa Monica dataset was used, which describes the state of parking lots every 5 minutes, 24 hours a day. Given that this dataset does not describe parking lots in the same city of the map data, parking lots were given random positions inside the map. The data was transformed in order to extract relevant features such as day, month, year, hour of the day, week day, among others. The problem was thus not treated as a time-series one. Figure 3 shows the typical fluctuation of the distribution of available parking spots during the day, for a specific parking lot. It shows how in certain hours of the day it is common for a parking lot to have very few or no free parking spots.

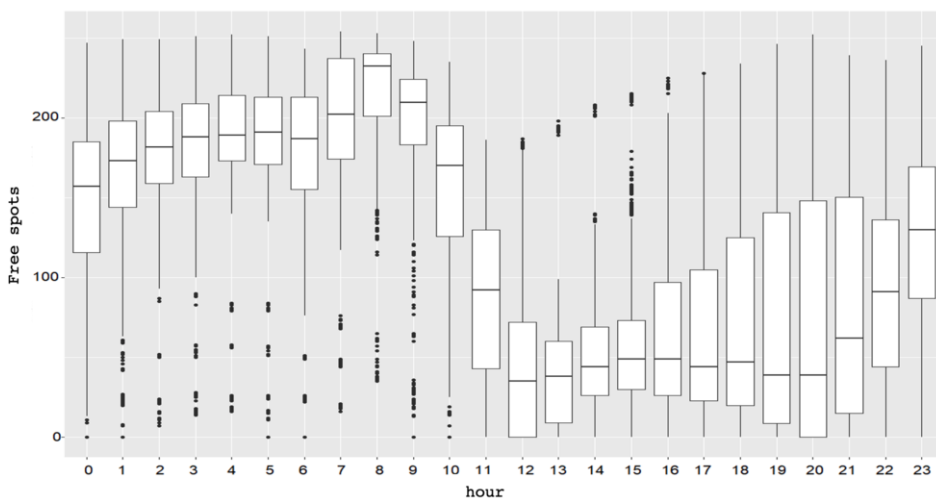

**Figure 3.** Typical fluctuation of free parking spots in a parking lot during the day.

**Table 1.** Performance of the best configuration model found for each model after parameter optimization through grid search.

Model	$r^2$	mae
GLM	0.56	137.27
Deep Learning	0.95	39.43
GBM	0.89	53.48

Then, several configurations of three Machine Learning models were trained to predict the number of free parking spots at a given time and parking lot, using a Grid Search scheme with cross-validation. The first model tested was a Deep Learning model [8] with different architectures of hidden layers and three different activation functions: Rectifier, Tanh and Maxout. The second model was a Generalized Linear Model (GLM) [3] and the third was a Gradient Boosting Machine (GBM) [5]. The performance metrics of the best model of each type is detailed in Table 1.

The deep learning model, given its superior performance, was thus selected to power the developed application. Thus, using this application, a driver first picks the point in the city where she/he wants to go. The application uses the Intelligent Path Finding Service to compute the best path to that point, as well as the estimated time of arrival.

Then, it predicts the number of available free parking spots in nearby parking lots and picks the one that has more expected free spots. The calculated path is then updated, to have as destination the selected parking spot. And it is this final spot that is provided to the user.

This application, which can be seen as an example of building on top of an existing service to provide a useful service for citizens, has several advantages. On the one hand, it optimizes the route of the driver in accordance with the city's rules, minimizing air pollution, noise or congestion as desired. Moreover, it selects the parking lot with the higher predicted number of free spots. This allows the driver to park more quickly, thus minimizing the negative impact of driving around searching for a free parking spot.

## 6. Conclusions and Limitations

In this paper we presented an innovative approach for managing traffic in a smart city. It relies on several key factors: real-time sensor data, city maps, and an engagement of citizens to abide by the systems decisions. The main limitation of the presented work is that it does not yet use real sensor data. Although a prototype of the system was implemented, it was validated using simulated data or data extracted from existing online datasets that are from a different city of the map used.

Still, we believe that the approach is worth pursuing in the sense that it might encompass advantages at several levels for a city. Its main distinguishing feature is that, instead of optimizing the behavior of each citizen in a selfish way, it optimizes for the greater good. That is, it defines individual routes while considering not only the preferences of the individual citizens but also the city preferences and policies.

Thus, as shown in Figure 2, a route may not necessarily be the shortest for a given driver if it optimizes other concerns of the city (e.g. minimizing air pollution). Moreover, the system is dynamic in the sense that routes may be different depending on the state of the city. This is especially useful to quickly react to significant changes in air pollution,

for instance, something that is impossible to do with traditional methods that require the use of specific road signs, for instance.

In Future Work, we will proceed to integrate the proposed system with live data from the city's sensors and assess how traffic would be routed under different preferences and under different conditions.

Concluding, we believe that this system is particularly useful in a time in which autonomous vehicles start to reach our roads. Indeed, while a human driver may always ignore the common good and just use their own navigation system, an autonomous vehicle may be programmed to obey the management policies of the city it's driving in. All in all, this type of systems could result in optimized traffic systems that put the citizen in the center, and optimize traffic so that the quality of life in the city is improved.

## Acknowledgments

This work was supported by FCT - Fundação para a Ciência e a Tecnologia, through project UIDB/04728/2020.

## References

- [1] BIBRI, S. E., AND KROGSTIE, J. Smart sustainable cities of the future: An extensive interdisciplinary literature review. *Sustainable cities and society* 31 (2017), 183–212.
- [2] DIJKSTRA, E. W., ET AL. A note on two problems in connexion with graphs. *Numerische mathematik* 1, 1 (1959), 269–271.
- [3] DOBSON, A. J., AND BARNETT, A. G. *An introduction to generalized linear models*. CRC press, 2018.
- [4] DUBOS, R. *Social capital: Theory and research*. Routledge, 2017.
- [5] FRIEDMAN, J. H. Greedy function approximation: a gradient boosting machine. *Annals of statistics* (2001), 1189–1232.
- [6] GAZZOLA, P., DEL CAMPO, A. G., AND ONYANGO, V. Going green vs going smart for sustainable development: Quo vadis? *Journal of cleaner production* 214 (2019), 881–892.
- [7] ISMAGILOVA, E., HUGHES, L., DWIVEDI, Y. K., AND RAMAN, K. R. Smart cities: Advances in research—an information systems perspective. *International Journal of Information Management* 47 (2019), 88–100.
- [8] LECUN, Y., BENGIO, Y., AND HINTON, G. Deep learning. *nature* 521, 7553 (2015), 436–444.
- [9] NAGY, A. M., AND SIMON, V. Survey on traffic prediction in smart cities. *Pervasive and Mobile Computing* 50 (2018), 148–163.
- [10] NEILSON, A., DANIEL, B., TJANDRA, S., ET AL. Systematic review of the literature on big data in the transportation domain: concepts and applications. *Big Data Research* (2019).
- [11] ROBINSON, I., WEBBER, J., AND EIFREM, E. *Graph databases*. " O'Reilly Media, Inc.", 2013.
- [12] SAHARAN, S., BAWA, S., AND KUMAR, N. Dynamic pricing techniques for intelligent transportation system in smart cities: A systematic review. *Computer Communications* (2019).
- [13] SILVA, B. N., KHAN, M., AND HAN, K. Towards sustainable smart cities: A review of trends, architectures, components, and open challenges in smart cities. *Sustainable Cities and Society* 38 (2018), 697–713.
- [14] SINNOTT, R. W. Virtues of the haversine. *Sky Telesc.* 68 (1984), 159.
- [15] SODIQ, A., BALOCH, A. A., KHAN, S. A., SEZER, N., MAHMOUD, S., JAMA, M., AND ABDELAAL, A. Towards modern sustainable cities: Review of sustainability principles and trends. *Journal of Cleaner Production* (2019).
- [16] ULLAH, Z., AL-TURJMAN, F., MOSTARDA, L., AND GAGLIARDI, R. Applications of artificial intelligence and machine learning in smart cities. *Computer Communications* (2020).
- [17] YIGITCANLAR, T., KAMRUZZAMAN, M., FOTH, M., SABATINI-MARQUES, J., DA COSTA, E., AND IOPPOLO, G. Can cities become smart without being sustainable? a systematic review of the literature. *Sustainable cities and society* 45 (2019), 348–365.

- [18] ZHENG, C., YUAN, J., ZHU, L., ZHANG, Y., AND SHAO, Q. From digital to sustainable: A scientometric review of smart city literature between 1990 and 2019. *Journal of Cleaner Production* (2020), 120689.

# Optimising User Experience with Conversational Interface

Marco Gomes<sup>a,b,1</sup> António Miguel Costa<sup>b</sup> Cesar Analide<sup>a</sup> Paulo Novais<sup>a</sup>  
Fábio Silva<sup>a,b</sup>

<sup>a</sup>Algoritmi Centre, University of Minho, Braga, Portugal

<sup>b</sup>CIICESI, ESTG, Instituto Politecnico do Porto, Felgueiras, Portugal

**Abstract.** User Experience is perhaps one of the main aspects that maintain a customer loyal to cloud-based solutions or *SaaS*. With the rise of the natural language processing techniques, the industry is looking at automated *chatbot* solutions to boost and expand its services. This article presents a practical case study of the implementation of a *chatbot* solution to complement a *CRM* software called *FOX-AIO*, and then quantify as possible, following the most appropriate guides and answers available, the *UX* optimization. To achieve the goals of this solution without "reinventing the wheel", we present possible architectures to use at the top of some open-source and available tools on the market, with a special relief in the framework *RASA* to create the conversational system. This paper refers to a few use cases that are hypothetically possible to improve the user experience of an existing software system using a conversational interface on top of that. Also, we have proven the people should prefer using a conversational interface because of his simplicity, defended by a better score in the *SUS* scale, 70 against 58 to the traditional *UI*, and by the *HEART* framework.

**Keywords.** User Experience, Natural Language Processing, *RASA*, *SUS*, *HEART* framework

## 1. Introduction

The idea of investing and studying the concept of developing a conversational interface at the top of a conventional system using the *user interfaces (UI)* to communicate was yielded due to the market growth of the cloud services. Indeed, the world market for cloud services is projected to grow by 17.5 % to a market value of 214.3 billion from 182 billion dollars by 2018, according to *Gartner, Inc* [5]. Also, "cloud services are shaking up the industry", in line with Sid Nag, vice president researcher at *Gartner* [5]. Additionally, the latest *Gartner* surveys show that more than a third of designs look at cloud service investments as a top-priority investment, impacting the market offers. Besides, since the online cloud services are growing from year to year, and providing the best possible experience in a paid service, one should consider all the alternatives on the way we want to give service.

Like the private sector, changing business processes for smart cities encompasses several challenges in delivering more personalized, digital services to their citizens. In-

---

<sup>1</sup>Algoritmi Centre, University of Minho, Braga, Portugal; E-mail: marcogomes@di.uminho.pt.

deed, many case studies in citizen services today fall into five categories: answering questions, filling out and searching documents, routing requests, translation, and drafting documents [10]. However, the advance of these services remains bounded by government resources and the limits of both human creativity, limiting the speed of progress that would be expected in this field. Therefore, this work tries to tackle down this obstacle by deploying a chatbot and a conversational interface on a commercial platform (*FOXAIO*<sup>2</sup>, which is the software that was used to create the conversational interface on top of a *CRM* (Customer Relationship Management) system). The idea is to gain insight into these issues by performing several experiments that can help develop more robust "citizen-centric" conversational interfaces and chatbots that personalize and contextualize services.

The idea was to create a *chatbot* widget on the current *UI* where the client of the software can use freely, optimizing the execution of repetitive processes and renouncing from a psychological operator. The main goal was to implement a scalable, easily maintainable *chatbot*, which interacts with *FOXAIO*, in short, can answer a few use cases correctly at the start. These use cases considered in this work were the following:

1. Obtain the balance of a specific customer at the moment.
2. Get the latest task for a specific customer, and the possibility to open it in the current interface.
3. Get the most debtor customers.
4. Get the won values by opportunities for a specific customer in a specific year.

In this short paper, we report our ongoing work. The rest of the paper is structured as follows. In the following sections, we present an overview of the related work, our solution approach, and the experiments carried out. Finally, it is given the conclusions and future work.

## 2. Related work

The *chatbots* can come in two flavors: rule-based and *AI* bots. The ones that come with rule-based *bots* answers to questions based on the predefined rules embed into them. Unfortunately, rule-based bots aren't able to answer questions that exhibit patterns for which these bots weren't designed, that's why machine learning techniques holds such potential in the area of *chatbots*. In this section, we will briefly introduce the most promising deep learning techniques used in Natural Language Processing (*NLP*) for the intent classification (problem to identify the goal of a user in the conversational interface) and the Dialog Management *DM* technology.

### 2.1. Word embedding

There are several definitions of the term *word embedding*, but in general, it can be defined as the numerical representation of words, usually in a vector form. Being more specific, these are word representation vectors, where relative similarities correlate with semantic similarities [8]. These vectors could be a resource for feeding a machine learning algorithm. There are two popular methods for the described operation, *Glove* (Global Vec-

---

<sup>2</sup>[www.foxaio.com](http://www.foxaio.com)



tors for Word Representation), which is an unsupervised learning method and *Word2Vec*, which is an efficient predictive model for learning word embedding of raw text [8].

## 2.2. Continuous Bag-of-Words Model

The objective of the *CBOW* technique is pretty simple, computing the conditional probability of a target word given the context words surrounding it across a window of size  $k$  [14]. On that technique, the non-linear hidden layer is removed, and the projection layer is shared for all words. Thus, all words get projected into the same position (their vectors are averaged). We call this architecture a bag-of-words model as the order of words in history does not influence the projection [11].

## 2.3. Skip-gram Model

Initially introduced in *Efficient Estimation of Word Representations in Vector Space* [11], where the under-laying principle is simple, predicting the surrounding context words given the central target word. which is the exact opposite of the *CBOW* technique. More precisely, each word is used as an input to a log-linear classifier with a continuous projection layer, and then words are predicted within a range before and after the current word [11].

## 2.4. Tensorflow Embedding by RASA

The bag-of-words approach proved to be a good baseline [6], but it can have some limitations on the practice case. The lack of vector words of some essential words, for example, is one of the better-known problems that's especially true if we work with languages other than English. The *framework RASA* introduced a technique, called *Tensorflow Embedding Pipeline*, which instead of using pre-trained embeddings and training a classifier on top of that, it trains word embeddings from scratch. It is typically used with a bag-of-words technique to counting how often distinct words of the training data appear in a message and provides that as an input for the classifier. This technique presented in 2018, was developed by the team *RASA*, but was inspired by the paper *StarSpace* [13]. The *StarSpace* is a general neural model purpose with the objective of efficient learning entity embeddings for solving a wide variety of the problems; one of the cases that can be applied is in intent classification for a conversational *AI* system [13].

## 2.5. Recurrent Neural Networks (LSTMs)

The *RNNs* or Recurrent Neural Network is a neural network model proposed in the 80's by (*Rumelhart et al., 1986; Elman, 1990; Werbos, 1988*) for modelling time series [12]. The main feature of this type is that it can retain past information from received input, allowing us to discover temporal correlations between events that could be distant from each other's input in the data. It can also be said; they're a neural network with loops allowing the information to persist. In recent years there has been quite a success applying *RNNs* in the most variable problems, speech recognition, translation, image captioning. This success comes from the use of Long Short Term Memory Networks (*LSTMs*), which are a type of *RNNs* that work in many cases, much better than the standard model,

almost all exciting results gained from the use of *RNNs* are complemented by their use. The *LSTMs* are designed to avoid a problem present in the *RNN* version. The long-term dependency problem is, in a nutshell, the situation that a simple *RNNs* can contain a gap on transporting the contextual information between the networks, this problem has been explored in depth by *Bengio* in [2].

## 2.6. Approaches for the DM

The management of the responses generated by a conversational interface is done from the *DM* component. In the document "Approaches for Dialog Management in Conversational Agents" [7], there are 3 referred types of approaches to create an *Dialog Management System*.

1. Handcrafted (rule-based) approach.
2. Probabilistic (statistical) approach.
3. Hybrid approach.

The *handcrafted approach* is designed by the handcrafted dialog managers. They define the state of the system and the policy by a set of rules which are created by the developers and the domain experts.

The *probabilistic approach*, instead of defining the set of the rules to the dialogue system, probabilistic the *DM* learns for the rules from the actual conversations.

The *hybrid approach* is next to the pure rule or statistical method, but since that, some work has been done to combining the advantages of both approaches. These hybrid approaches are an essential step toward introducing data-driven elements into available dialogue agents. This approach should use a neural network combined with coded constraints and rules [7,4].

## 3. Measuring the UX

Nowadays, it's possible to do a wide range of common tasks "in the cloud", some of them which were only possible to do in native client applications (e.g., "Photo Editing"). For the professionals of the *UX*, one of the keys of this shift is the ability to use the webservice log data to track product usage on a large scale. If we apply additional instrumentation, it's also possible to run the famous *A/B* controlled tests that can compare the interface alternatives, but this raises an important question. What criteria should they be compared from an *user-centered* perspective?.

We still have the low-level and direct metrics, the *Pulse Metrics* (Page Views, Uptime, Latency, Seven-day active users, Earnings). At the same time, businesses should still track these metrics, they should remember that they lack context for measuring *UX*, we can define that by a simple example, an average time of 5 minutes on the system might mean users are extremely engaged with the product, or they are just not finding the content they need.

### 3.1. HEART framework

Based on the problems which were introduced on the *PULSE* metrics, these metrics should work as a complementary framework.

The *HEART* framework comes from five categories, Happiness, Engagement, Adoption, Retention, and Task Success. These categories should be from each team must define the metrics that will use to track progress towards goals.

### 3.2. The System Usability Scale (SUS)

The usability is a narrower concept than user experience since it focuses on goal achievement; however, it is still fundamental to measure the overall user experience of a system. The *System Usability Scale* is targeted to provide a "quick and dirty" reliable tool to measure the usability of a system. It's a simple ten-item in *Likert* scale with five response options for respondents, from strongly agree to disagree strongly, and then, giving a global view of subjective assessments of usability [3].

## 4. Chatbot Architecture Design

The design of the architecture for the conversational system was made by using the *toolkit Botkit* linked to the *NLU* component. We have multiple channels from where the user has been logged in, from the *CRM* itself or from another messaging platform available. Once the authenticated user sends a message, the *DM* implemented on the top of the *Botkit framework* would listen to it, correctly the *middleware* should redirect the received message text to the intended *NLP* component implemented with the *Rasa NLU*. This component would be responsible for converting the raw text into meaningful information back to the *Botkit*, with due intent and entities. Once we have the purpose of objects in the *DM* system, we would need to code every possible flow of the conversation based on every intent. Meanwhile, some issues can come up when the user correctly identifies the first intent he wants, but, in the middle of the conversation, we could request another intent, which is out of scope in the scripted dialogue by the developer. Yet, in fact, with a correct semantic context for the domain of the agent, it would originate an error or a wrong response. Indeed, assuming a specific domain of the conversational system implies having a lot of intents scripted, which makes it challenging to maintain and scale a correct script flow from one intent to another. Ideally, this *rule-based* approach would be the best solution to a *Q&A* agent or a very simple *chatbot* who would only resolve a few tasks for a long-view perspective.

Modeling a conversational system that somehow can maintain a state of the conversation and respond to the user request in the current context can be a difficult task (an interesting overview of this can be found in the research [9]). Taking this into account, we found it more comfortable to use a different approach than the *rule-based* system. Hence, we choose to use the *Rasa Core* component as the *DM* system, which works on the top of an artificial neural network or, in other words, improving the conversation flow by adding learning capabilities. Figure 1 details *DM* and a deeper explanation the can be found in the article *Rasa: Open Source Language Understanding and Dialogue Management*.

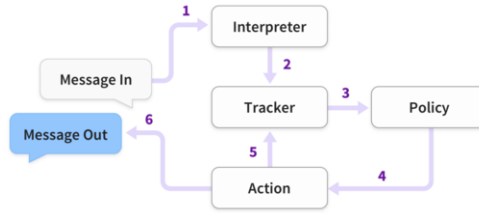

**Figure 1.** Rasa Core DM architecture, source: Rasa Open Source Language Understanding and Dialogue Management

We also developed a widget to interact with the conversational system from the current *UI* of the software. This conversational widget required an interface to interact with the conversational system, which can also be called by a channel. To do it, we implemented a `socket_channel` class in the language *Python* on the top of the conversational system to interact with the core system by a socket protocol. This class is responsible for accepting the connections from the *UI* widget of the interface, transporting the required details for a correct accessing to the *API* of the *CRM*.

## 5. Experiments and Results of Conversational Interface

To tackle some of the previously identified problems of the *NLU* component in the conversational interface, it was necessary to measure the quality of the training data. The underlying objective was to improve model performance in classification tasks. Therefore, some experiments were carried out. In particular, we were interested in feeding our model with more utterances for each intent from real people. To achieve that, we did some online surveys to trying to fetch the test *dataset*; we collected something like 25/35 utterances for each intent. Following, we depict some results obtained and point out some conclusions.

### 5.1. Pre-trained Embedding Approach with SpaCy Portuguese Model

To distinguish the best classifier pipeline to our *NLU* component, we tested the *datatest* with the *pre-trained* vector approach<sup>3</sup>.

Despite the good results on the intent confusion matrix (Figure 2) for the *pre-trained embedding* approach, if we evaluate the confidence on the distribution intents at the test *dataset*, as we can observe the histogram at the figure 2, it's visually noticeable that the confidence is not so good, this is because there's a lot of words already pre-trained from the *Spacy Model*. An immediate consequence of that is the probable confusion with some words that we expect to be meaningful in this specific context. In a real-world scenario, this case would be hazardous to identify an intent with the level of confidence around the 0.5 (50%). Indeed, this could generate an out of the context conversation and also a lot of misses on predicting the intent correctly.

<sup>3</sup><https://spacy.io/models/pt>

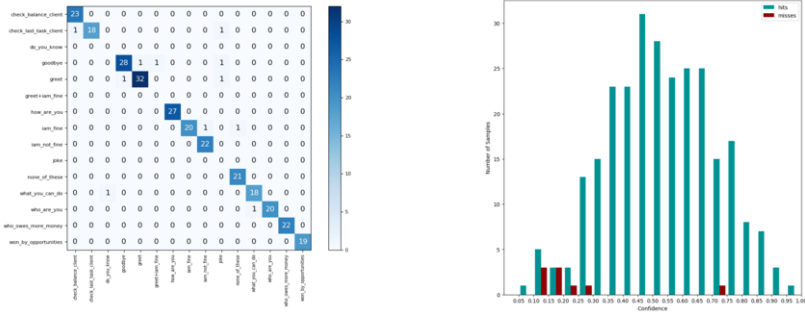

Figure 2. Confusion Matrix and Histogram Confidence of *pre-trained spacy model*

### 5.2. Rasa Tensorflow Embedding

One of the main advantages of using this technique is the fact that it is inherently language-independent. Meanwhile, it is not reliant on right word embedding for a specific language but can be adaptable on the particular domain since it trains the words from scratch can expect good results from the current context of the *chatbot*.

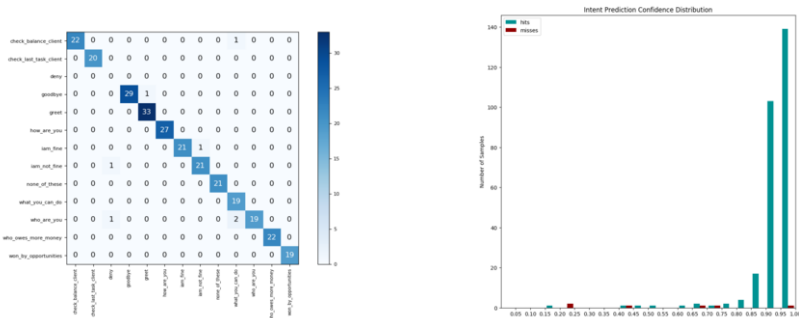

Figure 3. Confusion Matrix and Histogram Confidence of *rasa tensorflow model*

The results plotted in the *Histogram* figure at 3 are better than the results obtained from the *pre-trained model* in the 2. On the one hand, we can point out that almost all of the intents from the test *dataset* were predicted over 0.85 (85%) of confidence, which is a satisfactory accurate value for a real use case. On the other hand, the main disadvantage of using this approach is the possibility of failing some specific words which are not present in the training *dataset* yet. Moreover, in some cases, this model can contain a gap of *overfitting* in which it would be required to tackle it with more data. It is also possible to observe some fails with intents in the histogram, falling below 50%. We expect these failed intents to be undertaken if we manage to get more contextual cues from the user’s interaction with the *CRM* software.

### 6. UX Optimisation Results

To summarize the improvement of the *UX* over the traditional *UI*, we will discuss the results we obtained from tracking the introduced metrics and the necessary surveys.

#### 6.1. Applying HEART metrics

In the first instance, it is presented all the charts we created to visually summarize the results of the *HEART* framework, and further, we will detail it.

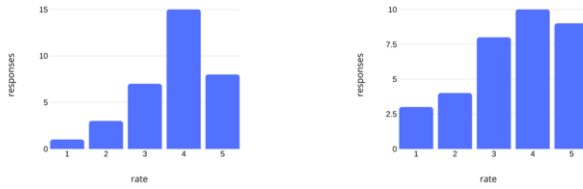

Figure 4. Happiness Metric Survey Question 1 and 2

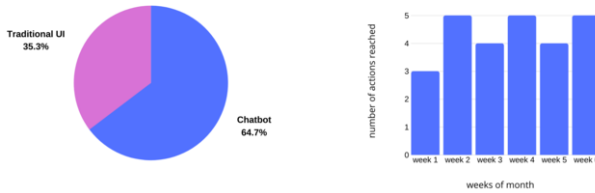

Figure 5. Happiness Metric Survey and Adoption Metric Results

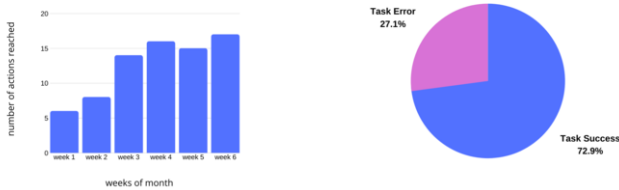

Figure 6. Retention Metrics Result and Task Success Metric

In order to analyze the happiness metric, was created a small survey with main objective to identify the satisfaction level, some of them in a *Likert* scale and others with a short text or multiple-choice, with the following questions:

1. Did you find the *chatbot* easy to use? (figure 4)
2. Did the *chatbot* help you to perform the requested tasks? (figure 4)

3. At performing the requested tasks, would you prefer to use the *chatbot* or the traditional interface ? (figure 6)
4. Did you find it hard to perform the requested tasks?, if yes, why?

To evaluate the engagement metric, the individual logging sessions logging the session duration on the conversational interface was considered. We gathered around 100 entries in the database and obtained an average session length of 236 seconds, which outlines a session length of around 4 minutes. For the adoption metric, we use the total users of the system who logged in within 30 days are around 70/80, the second graph in Figure 6 shows how many new sessions on the system archived the goal of "get client balance" within seven days that ran for a month and a half. One can say, subjectively, that most of the users were keeping trying the conversational system, which is satisfying. Following the same method to retrieve the adoption results, we implemented the retention metric. The first graph in Figure 5 depicts the data stored by the logging class of the conversational interface to measure the same quantification; it's visible that the number of users using the conversational interface to get the information by dialogue is increasing over the time. Finally, to assess the task success metric, we logged every successful goal reached on the database, as well as the failed actions. By failed action, we mean the situation in which a user tried to reach the goal of the use cases available, and the conversational interface was not able to identify that correctly, or even worse, the intent prediction failed. The second graph in Figure 5 depicts the success ratio versus the error ratio stored by a month and a half.

## 6.2. System Usability Scale Case

For a different view and perspective of the user experience optimization, we analyzed the system's usability from a user's perspective. To compare the conversational interface against the current user interface of the software, it was necessary to create the 10-item *Likert* scale presented in the article [3]. The questionnaire was targeted to the specific features of the *chatbot*. To obtain the result of the *SUS* tool, which should yield a single number representing the overall usability of the conversational interface, having individual items on the scale, it was necessary to sum the score contribution of each item. Each item's score contribution was ranged from 0 to 4. For the item's 1,3,5,7 and 9, the score contribution was the scale position minus 1. For the items 2,4,6,8 and 10, the score was five minus the scale position, and finally multiplying the sum of scores by 2.5, it generated the overall value of the *SUS* [3]. The following results were generated by the proposed *Likert* scale, which has been filled by 29 persons, the current users who are familiar with the software. In the *SUS* scale perspective, the *Chatbot* is the winner, which obtained a result of 70. Meanwhile, according to the study at [1], this number is above average. The traditional user interface of the software scored 58, which is below the average. However, these scores should only be considered as a sample of the experience, since the results were only considered using the use cases on the study. Expanding this to a sophisticated use case scenario, it should probably be quite different.

## 7. Conclusion

Taking into account the accomplished work, it can be said the developed solution is satisfying. The results obtained can lead to improvements to get the most precise feedback as possible, and therefore, improving the *UX* in a better way. Indeed, several improvements could be made to boost the robustness of that solution, such as adding a sentiment analyzer to identify the positive or negative responses from the authenticated user or enabling different *NLP* covered languages. There is still a long way to go for conversational systems in all of the cases before they can be used entirely untouched by the human hands.

## Acknowledgements

The work has been partly supported by RISEWISE (RISE Women with disabilities In Social Engagement) project under the Agreement N 690874 and by FCT Fundação para a Ciência e a Tecnologia (Portuguese Foundation for Science and Technology) within the Project Scope: UID/CEC/00319/2020. This work has also been supported by FCT - Fundao para a Ciência e a Tecnologia, through project UIDB/04728/2020.

## References

- [1] Aaron Bangor, Philip Kortum, and James Miller. Determining what individual sus scores mean: Adding an adjective rating scale. *Journal of usability studies*, 4(3):114–123, 2009.
- [2] Y. Bengio, P. Simard, and P. Frasconi. Learning long-term dependencies with gradient descent is difficult. *IEEE Transactions on Neural Networks*, 5(2):157–166, March 1994.
- [3] John Brooke et al. Sus-a quick and dirty usability scale. *Usability evaluation in industry*, 189(194):4–7, 1996.
- [4] Davide Carneiro, André Pimenta, José Neves, and Paulo Novais. A multi-modal architecture for non-intrusive analysis of performance in the workplace. *Neurocomputing*, 231:41–46, 2017.
- [5] Katie Costello and S Hippold. Gartner forecasts worldwide public cloud revenue to grow 17.5 percent in 2019. *Gartner, Stamford, USA*, 2018.
- [6] Katrin Erk and Noah A Smith. Proceedings of the 54th annual meeting of the association for computational linguistics (volume 1: Long papers). In *Proceedings of the 54th Annual Meeting of the Association for Computational Linguistics (Volume 1: Long Papers)*, 2016.
- [7] Jan-Gerrit Harms, Pavel Kucherbaev, Alessandro Bozzon, and Geert-Jan Houben. Approaches for dialog management in conversational agents. *IEEE Internet Computing*, 23(2):13–22, 2018.
- [8] Amit Mandelbaum and Adi Shalev. Word embeddings and their use in sentence classification tasks. *arXiv preprint arXiv:1610.08229*, 2016.
- [9] Michael McTear. Conversation modelling for chatbots: current approaches and future directions. *Studientexte zur Sprachkommunikation: Elektronische Sprachsignalverarbeitung 2018*, pages 175–185, 2018.
- [10] Hila Mehr, H Ash, and D Fellow. Artificial intelligence for citizen services and government. *Ash Cent. Democr. Gov. Innov. Harvard Kennedy Sch., no. August*, pages 1–12, 2017.
- [11] Tomas Mikolov, Kai Chen, Greg Corrado, and Jeffrey Dean. Efficient estimation of word representations in vector space. *arXiv preprint arXiv:1301.3781*, 2013.
- [12] Razvan Pascanu, Tomas Mikolov, and Yoshua Bengio. On the difficulty of training recurrent neural networks. In *International conference on machine learning*, pages 1310–1318, 2013.
- [13] Ledell Wu, Adam Fisch, Sumit Chopra, Keith Adams, Antoine Bordes, Jason Weston. Starspace: Embed all the things! *CoRR*, abs/1709.03856, 2017.
- [14] Tom Young, Devamanyu Hazarika, Soujanya Poria, and Erik Cambria. Recent trends in deep learning based natural language processing. *IEEE Computational Intelligence Magazine*, 13(3):55–75, 2018.



# Review and Replication of CoAP and MQTT Attacks for Dataset Generation

Jose Aveleira-Mata<sup>a,1</sup>, Armando Ibán-Sánchez<sup>b</sup>, María Teresa García-Ordás<sup>b</sup>, Isaías García-Rodríguez<sup>b</sup> and Héctor Alaiz-Moreton<sup>b</sup>

<sup>a</sup>*Research Institute of Applied Sciences in Cybersecurity (RIASC) MIC, Universidad de León, 24071 León, Spain*

<sup>b</sup>*Escuela de Ingenierías, Universidad de León, 24071 León, Spain*

**Abstract.** This work addresses an approach for generating a dataset collection based on an executive review of attacks on application layer protocols of the IoT environments, such as CoAP and MQTT. In the smart cities, the IoT devices have a significant role and their security becomes very important. Due to the fact that special characteristics of IoT devices in terms of processing power, energy savings and cost, makes them a more heterogeneous method of communication than conventional networks. The use of these protocols raises new challenges in the cybersecurity. In order to address security without increasing the complexity of IoT systems, the network traffic must be analyzed in deep with machine learning techniques. Therefore, network traffic datasets are of high importance to detect threats through a dynamic intrusion detection system based on intelligent models. So, the system implemented and shows in this paper is a viable way to generate dataset where attacks described are included.

**Keywords.** Internet of things, IoT, Intrusion detection systems, Datasets, MQTT, CoAP, Cybersecurity

## 1. Introduction

Internet of things offers new possibilities in the Smart cities home and industry environments, this improves the quality of life, increasing efficiency and productivity, being able to make real time decisions and create new business opportunities. In order to construct Smart Cities, the IoT environments are very important. The use of sensor and actuators makes the integration with the humans suitable. Smart Cities must be safe [1]. For this reason, a challenge is keeping safe the systems included in the Smart Cities such as the IoT devices. That is the reason why the number of new IoT devices connected to the Internet is growing exponentially [2].

This kind of objects, called IoT devices, can be sensors, actuators, embedded systems, smart devices, and mobile phones [3]. Common functionalities include collecting information from physical systems, connecting to the Internet to send data to the cloud or other edge devices.

To optimize these communications, it uses lightweight protocols and different communication networks that require low power consumption.

---

<sup>1</sup> Corresponding Author E-mail: jose.aveleira@unileon.es

There are a category of protocols situated in the low-level of TCP/IP such as 6Lowpan and ZigBee using IEEE802.15.4, Bluetooth LE (BLE), RFID, NFC and Z-Wave[4]

On the other hand there is a set of protocols that connect directly to the Internet using WiFi with protocols in the application layer such as MQTT, CoAP, XMPP and DDS [5].

New challenges arise in the security of IoT systems because of their special characteristics, such as the variety of networks and protocols, the low processing capacity of the devices, the reduction of development costs of new devices, and the security configurations predetermined by the users [5]. One of the most significant recent attacks is the Mirai attack (September 2016 [6]) This attack exploited the special features and vulnerabilities of IO devices to infect them and create a botnet that attacked the dns service provider, with a distributed denial of service (DoS) attack, affecting all Internet traffic.

The implementation of Intrusion Detection Systems (IDS) is a good way to implement a safety system in the IoT systems. This is a good solution due to analyse the network traffic with no additional requirements to the system [7]. The IDS classified into Signature-based Intrusion Detection Systems (SIDS) and Anomaly-based Intrusion Detection Systems (AIDS).

In order to test IDS and create new anomaly detection algorithms based on Machine and Deep Learning Techniques, datasets are needed to collect network traffic with attacks on the systems [8]. The most popular dataset with network traffic is KDD99 with network traffic and attacks generated in the third International Knowledge Discovery and Data Mining Toolkit and its improved version NLS-KDD, and the AWID [9] dataset with collection of WiFi network attacks. It is well known the use of these datasets Machine learning techniques have been applied extensively in the area of AIDS [10]

One problem in approaching security in IoT is that there are no public datasets with data from attacks in IoT environments, since it is the data from the sensor and actuator data (temperature and humidity)[11], Therefore, it is important to collect information about IoT environments that attack the specific vulnerabilities of these protocols. This fact makes that the security is especially critical in application layer protocols [12] Therefore in our work we focus on the well-known protocols in IoT environments such as MQTT and CoAP.

## **2. Review of attacks MQTT and CoAP protocols**

The well-known application layer protocols in IoT are CoAP and MQTT for performance in IoT systems [13] [14][15]. About them there are several researches to implement a security level of security. The Pre-Shared Key mode enforces the usage of a transport layer security mechanism (DTLS or TLS) [16]. The use of distributed Usage Control (UCON) framework [17]. Implement security by blockchain-based authentication [18].

However in case of the use of protocols without implementing any security additions, only with the description of their standard in a way that do not affect the performance [19] or use them from third-party applications may be susceptible to specific vulnerabilities by their character, which we will describe below

## 2.1. MQTT protocol vulnerabilities and attacks

The Message Queue Telemetry Protocol (MQTT) is a light publication/subscription messaging protocol, which works on TCP, designed for M2M (machine to machine) communications. MQTT is based on an extremely lightweight broker-based publish/subscribe messaging protocol, for small code footprints (e.g., 8-bit, 256KB ram controllers). being an excellent solution for connecting devices in networks with low bandwidth [19].

This protocol has been applied in a variety of embedded systems. For example, hospitals use this protocol for patient health monitoring [20], Facebook uses this protocol for messaging applications [21].

The architecture of the MQTT protocol follows a star topology, with a central node that acts as a server or broker, which is the responsible for managing the network and transmitting messages, like the example of the Figure1. The communication is based on topics thus, a client of the broker publishes the message on a topic and the clients that wish to receive a message must subscribe to this the topic. The communication can be 1 to 1, or 1 to N and in real time.

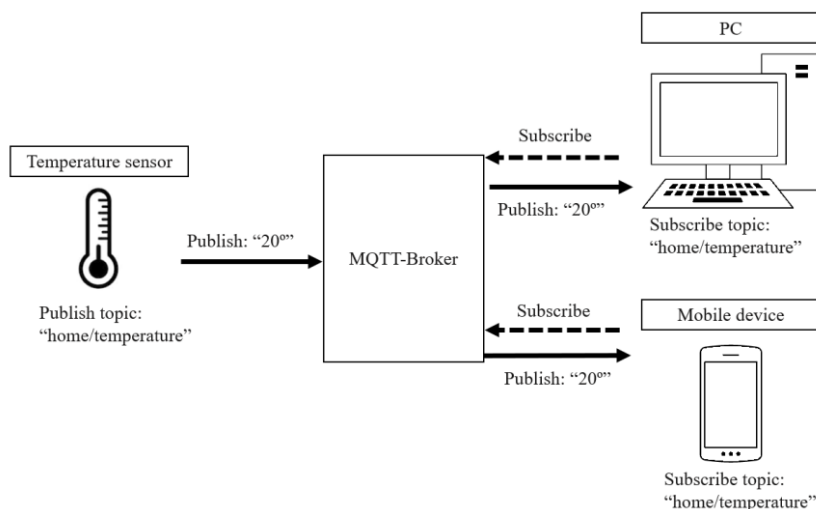

Figure 1. Example MQTT Publish/Subscribe Architecture.

Following a set of attacks are showed:

**The denial of service attack DoS:** in the MQTT structure the broker centralizes the communication and uses a default port for communications 1883, An attacker could detect systems that use this protocol with Shodan [22]. Once the broker has been detected it can be attacked with tools for the analysis of the performance [23] it is possible to force the number of connections. This collapses the server and deny the normal service of the system. Solutions to this problem have been proposed [24].

**The man-in-the-middle attack (MitM):** MQTT packet composition is thanks to this is a very lightweight protocol Table 1. It uses a fixed header with length of 2 bytes ,an optional message-specific variable length header and message payload [25].

Table 1. MQTT Message

Bit	7	6	5	4	3	2	1	0
Byte 1	Message type				DUP	QoS		RETAIN
Byte 2	Remaining length							

An attacker can be able to in the middle of the communications by modifying the content of the package and change the content [26] . In the first step performs an ARP (Address Resolution Protocol Poisoning) poisoning using the Kali Linux tool called Ettercap [27]. Once between a sensor and the broker, it is possible to filter the packets with the Nfqsd tool [28] and modify the payload of the MQTT packet.

**Intrusion of foreign connections into the system:** the protocol has special characters for maintenance as the # character. Thank to this special character can be seen the messages of all topics [29]. An attacker can find brokers on the network where an authentication procedure is not implemented. [22]Thus, the attacker can use the libraries of a MQTT client such as Mosquitto or Paho [30], in order to subscribe the broker as a system client and permitting full access to confidential information and view topics and messages.

## 2.2. CoAP protocol vulnerabilities and attacks

The Constrained Application Protocol (CoAP) standardized as RFC7252 works in the application layer and was designed to offer the functionality of the HTTP model. Enabling the message exchanges asynchronously together with the UDP transport layer protocol, simplifies the transport information [31]. One of its objectives is to reduce as much as possible the need to fragment the packages that are transmitted through the system, maintaining the size of the messages [32].

This protocol is applied in different IoT environments, for example, it has a direct application in Mobility Management for Healthcare Services [33] or in smart home [34].

It implements the REST architecture and more specifically the RESTful structure, so that a client, using methods such as GET, PUT, POST and DELETE, sends the server a request to perform a specific action on a resource on the server itself, with the servers providing access through an URI [35].

**CoAP Amplification DoS Attack:** CoAP is vulnerable to an amplification attack described in RFC7252 [36]. CoAP servers respond to a request with a response packet. This response packet can be significantly larger than the packet in the request, because CoAP allows to send more blocks in custom sizes, very small in case attack. This feature converts CoAP clients into potential Denial of Service (DOS) attack nodes [37]. When the nodes enable the use of NoSec security mode, the UDP protocol cannot verify the source address inside the sent packet [38], An attacker can trigger an amplification attack by generating a denial of service, by placing the victim's IP address in the source address of a request packet, to force the server to generate a larger packet that will be directed to the victim.

**The man-in-the-middle attack (MitM):** as well as happened in MQTT protocol. There is the possibility to be situated between a client and the server using ARP poisoning. At the beginning, the attacker sniffs and captures the network traffic. Analysing the CoAP packages get the URIs of the system and the size of the packages, in this way it is thank to know the size the packets malformed packet error is prevented. In a second step, the attacker can modify the information using the filters of the Ettercap tool, and change the protocol to UDP which the CoAP works, and substitute the information of parts of the packet to alter its values.

**Cross-protocol attack:** this vulnerability is contemplated in the RFC7252 the attack consists of switching to a CoAP endpoint by capturing the IP address and port, so that it sends packets to a false source address. CoAP, is vulnerable to this attack because of similarity with other protocols that work on UDP ( non-context based) [39], as DNS for example.

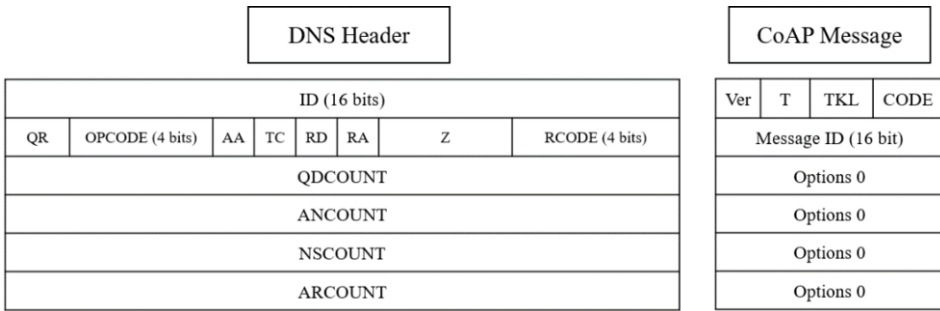

**Figure 2.** Head DNS vs CoAP Message

The DNS ID field corresponds to the CoAP T, TKL and code fields (Figure 2). The ID field is a 16-bit identifier. The T field corresponds to a 2-bit integer, the TKL field is another 4-bit integer, the code field is an 8-bit integer, and a field called “Ver” is a 2-bit integer that will always be 1 (01 in binary). Due to the simple structure of the frame previously showed an attacker can observe the connection between a client and a server and match 16 bits of the ID with the 16 bits that make up T, TKL, code and View, composing the CoAP packets. In this way, the direct communication is possible from attacker to victim [40], since the firewall rules that would prevent it are evaded and also allows communication between the CoAP end point and the victim.

### 3. Solution Architecture

This section addresses the solution developed to obtain datasets of the MQTT and CoAP protocols. We have created two environments that collect the real traffic of the IoT systems. With the aim of generating realistic datasets, these environments work like a real environment with Internet traffic and traffic from the IoT systems. IoT systems are attacked considering the previously described vulnerabilities after an exhaustive study of protocols vulnerabilities, for each attack we take the Timestamp with tagged the frames. For generating the datasets in the environments, it takes fields common to all the frames of the generated traffic (28 fields), these fields include the system times, the relative time of the collection, the origin and destination MAC and IP addresses. It also

takes all the fields that compose the MQTT protocol (38 fields) and all that compose the protocol, CoAP (56 fields). In both networks the traffic is collected from a router configured with OpwenWrt [41], which stores all the network traffic in PCAP files.

For the development of the environment with MQTT traffic, we have used a broker developed in node.js based on the “Mosca” library, a sensor of distance HC-SR04, an actuator that consists of a relay. Everything developed in NodeMCU boards with the libraries “pubsub” [42], to interact with them a web application has been created, to which they access a PC and a smartphone.

The following attacks are carried out on this environment:

- DoS attacks from another computer using the malaria-MQTT software.
- MitM attacks with a Kali Linux distribution and the Ettercap tool.
- Intrusion attacks with client CoAP mosquito.

For the development of the environment with CoAP traffic, we have developed a server using Raspberry Pi in node.js with the node-CoAP library, with URIs to obtain resources and the observe mode launched, this mode is able to send simulation numbers in real time. As clients for this server we use the Chrome Copper plugin (Cu4cr) [41], and a JavaScript client.

The following attacks are performed on this environment:

- Amplification: the attacker uses a different personal computer, supplanting the IP and using other copper client with the smallest possible block size.
- Cross-protocol through DNS to COAP adapting the native-dns-packet.js [43] library to simulate CoAP packages.
- With Kali Linux adapting Ettercap filters to replace CoAP package information.

Due to the complexity of PCAP files, we have developed a custom application named "Web Dissector", for offering a web user interface quickly and easily, generating dissected and tagging datasets according to the needs of the research. We have utilized the Tshark tool [44] for dissecting the protocol fields taken by the Wireshark Protocol Reference, in this case MQTT and COAP. Next, the application tags frames as attack and normal considering the text file whit timestamps of when attacks were made, the functionality of the application is represented in Figure 3. As a result, we obtain CSV files that compose the datasets with attacks of each environment. The developed architecture can be seen in the Figure 4.

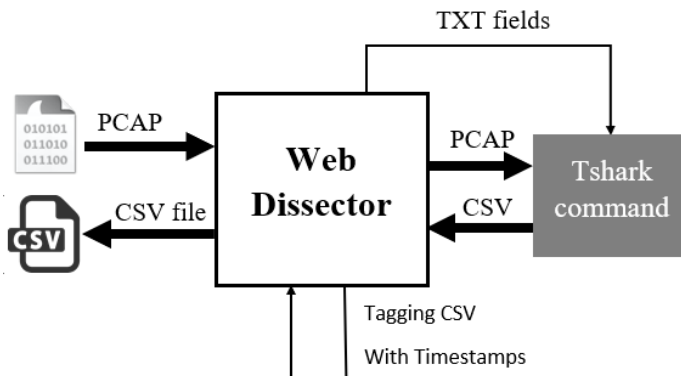

Figure 3. Web dissector functionality

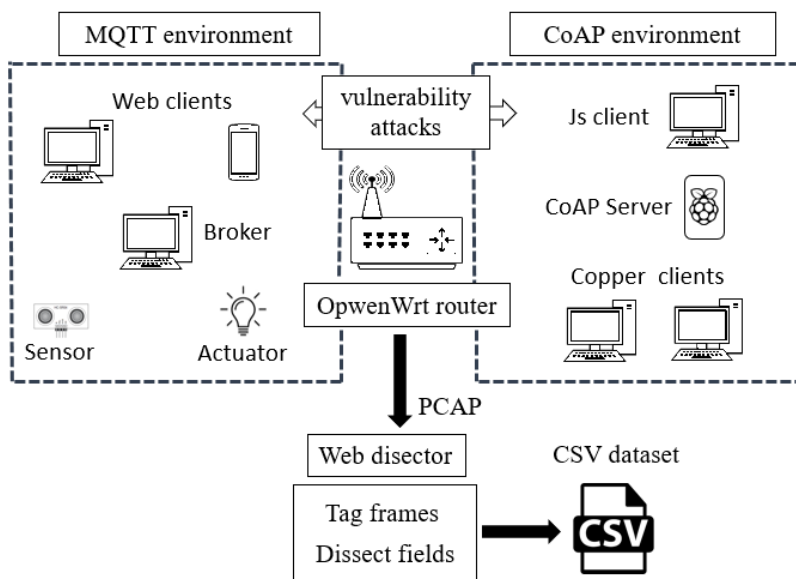

Figure 4. Solution Architecture

The fields selected in these datasets can be optimized using feature selection methods. With machine learning techniques it is possible to create intrusion detection models that can be implemented in IDS [45].

#### 4. Conclusion and Future Work

The IoT environments are becoming more relevant, the special characteristics of the IoT devices cause it to use light protocols that improve communications. A good solution for improve the security can be the development of IDS. Considering the protocols of the application layer MQTT and COAP, we analysed a set of specific vulnerabilities of each protocol, developing an architecture to obtain the datasets with tagged attacks in each environment.

Future work will use these datasets to train models with Machine and Deep Learning solutions, that can detect attacks., After the models obtained will be that deployed in an AIDS. This way, we obtain a system specialized in the security of IoT environments, and can detect the different attacks in a real-time IoT environment with no increase in the complexity of the communication.

The architecture and the method of work proposed can be easily adapted to generate new datasets in IoT environments. Moreover, other protocols could be implemented in other networks such as Bluetooth or ZigBee, researching the particular vulnerabilities of these protocols, creating new environments and using different types of sniffers to capture the data. Therefore, this data can be dissected and tagged in the same way as in the proposed system, making it possible to generate new datasets that address more layers of network security and that can be implemented in the AIDS.

## Acknowledgments

This work is partially supported by (i) Instituto Nacional de Ciberseguridad (INCIBE) and developed Research Institute of Applied Sciences in Cybersecurity (RIASC); (ii) Junta de Castilla y León, Consejería de Educación, Project LE078G18. UXXI2018/000149. U-220.

## References

- [1] F. Al-Turjman, H. Zahmatkesh, and R. Shahroze, "An overview of security and privacy in smart cities' IoT communications," *Trans. Emerg. Telecommun. Technol.*, no. June, pp. 1–19, 2019, doi: 10.1002/ett.3677.
- [2] V. Krotov, "The Internet of Things and new business opportunities," *Bus. Horiz.*, vol. 60, no. 6, pp. 831–841, 2017, doi: 10.1016/j.bushor.2017.07.009.
- [3] B. A. Tama, A. S. Patil, and K. H. Rhee, "An Improved Model of Anomaly Detection Using Two-Level Classifier Ensemble," *Proc. - 12th Asia Jt. Conf. Inf. Secur. Asia/JCIS 2017*, pp. 1–4, 2017, doi: 10.1109/AsiaJCIS.2017.9.
- [4] S. Al-sarawi, M. Anbar, K. Alieyan, and M. Alzubaidi, "Internet of Things (IoT) Communication Protocols : Review," pp. 685–690, 2017.
- [5] S. Sinche et al., "A Survey of IoT Management Protocols and Frameworks," *IEEE Commun. Surv. Tutorials*, vol. 1, no. c, pp. 1–1, 2019, doi: 10.1109/comst.2019.2943087.
- [6] C. Kolias, G. Kambourakis, A. Stavrou, J. Voas, and I. Fellow, "DDoS in the IoT," *Computer (Long Beach. Calif.)*, vol. 50, no. 7, pp. 80–84, 2017, doi: 10.1109/MC.2017.201.
- [7] P. S. Nandhini and B. M. Mehtre, "Intrusion Detection System Based RPL Attack Detection Techniques and Countermeasures in IoT: A Comparison," *Proc. 4th Int. Conf. Commun. Electron. Syst. ICCES 2019*, no. Icces, pp. 666–672, 2019, doi: 10.1109/ICCES45898.2019.9002088.
- [8] A. Khraisat, I. Gondal, P. Vamplew, and J. Kamruzzaman, "Survey of intrusion detection systems: techniques, datasets and challenges," *Cybersecurity*, vol. 2, no. 1, 2019, doi: 10.1186/s42400-019-0038-7.
- [9] M. Usha and P. Kavitha, "Anomaly based intrusion detection for 802.11 networks with optimal features using SVM classifier," *Wirel. Networks*, vol. 23, no. 8, pp. 2431–2446, 2017, doi: 10.1007/s11276-016-1300-5.
- [10] I. S. Al-Mandhari, L. Guan, and E. A. Edirisinghe, "Investigating the Effective Use of Machine Learning Algorithms in Network Intruder Detection Systems," in *Advances in Information and Communication Networks*, 2019, pp. 145–161.
- [11] N. Koroniotis, N. Moustafa, E. Sitnikova, and B. Turnbull, "Towards the development of realistic botnet dataset in the Internet of Things for network forensic analytics: Bot-IoT dataset," *Futur. Gener. Comput. Syst.*, vol. 100, pp. 779–796, 2019, doi: 10.1016/j.future.2019.05.041.
- [12] G. Nebbione and M. C. Calzarossa, "Security of IoT Application Layer Protocols: Challenges and Findings," *Futur. Internet*, vol. 12, no. 3, p. 55, 2020, doi: 10.3390/fi12030055.
- [13] S. Hamdani and H. Sbeyti, "A comparative study of COAP and MQTT communication protocols," *7th Int. Symp. Digit. Forensics Secur. ISDFS 2019*, pp. 1–5, 2019, doi: 10.1109/ISDFS.2019.8757486.
- [14] D. Thangavel, X. Ma, A. Valera, H. X. Tan, and C. K. Y. Tan, "Performance evaluation of MQTT and CoAP via a common middleware," *IEEE ISSNIP 2014 - 2014 IEEE 9th Int. Conf. Intell. Sensors, Sens. Networks Inf. Process. Conf. Proc.*, no. April, pp. 1–6, 2014, doi: 10.1109/ISSNIP.2014.6827678.
- [15] A. Larmo, A. Ratilainen, and J. Saarinen, "Impact of coAP and MQTT on NB-IoT system performance," *Sensors (Switzerland)*, vol. 19, no. 1, 2019, doi: 10.3390/s19010007.
- [16] S. Zamfir, T. Balan, I. Iliescu, and F. Sandu, "A security analysis on standard IoT protocols," *2016 Int. Conf. Appl. Theor. Electr. ICATE 2016 - Proc.*, pp. 1–6, 2016, doi: 10.1109/ICATE.2016.7754665.
- [17] A. Rizos, D. Bastos, A. Saracino, and F. Martinelli, "Distributed UCON in CoAP and MQTT Protocols," in *Computer Security*, 2020, pp. 35–52.
- [18] O. T. P. Authentication, "Securing MQTT by Blockchain-Based OTP Authentication," 2020, doi: 10.3390/s20072002.
- [19] F. Siddiqui, J. Beley, S. Zeadally, and G. Braught, "Secure and lightweight communication in



- heterogeneous IoT environments,” *Internet of Things*, no. xxxx, p. 100093, 2019, doi: 10.1016/j.iot.2019.100093.
- [20] K. Chooruang and P. Mangkalakeeree, “Wireless Heart Rate Monitoring System Using MQTT,” *Procedia Comput. Sci.*, vol. 86, no. March, pp. 160–163, 2016, doi: 10.1016/j.procs.2016.05.045.
- [21] E. G. Davis, A. Calveras, and I. Demirkol, “Improving packet delivery performance of publish/subscribe protocols in wireless sensor networks,” *Sensors (Switzerland)*, vol. 13, no. 1, pp. 648–680, 2013, doi: 10.3390/s130100648.
- [22] S. Andy, B. Rahardjo, and B. Hanindhito, “Attack Scenarios and Security Analysis of MQTT Communication Protocol in IoT System,” no. September, pp. 19–21, 2017.
- [23] C. Bao, X. Guan, Q. Sheng, K. Zheng, and X. Huang, “A Tool for Denial of Service Attack Testing in IoT,” p. 5, 2016.
- [24] M. Ge, J. B. Hong, W. Guttman, and D. S. Kim, “A framework for automating security analysis of the internet of things,” *J. Netw. Comput. Appl.*, vol. 83, no. November 2016, pp. 12–27, 2017, doi: 10.1016/j.jnca.2017.01.033.
- [25] K. Grgić, I. Špeh, and I. Hedi, “A web-based IoT solution for monitoring data using MQTT protocol,” *Proc. 2016 Int. Conf. Smart Syst. Technol. SST 2016*, pp. 249–253, 2016, doi: 10.1109/SST.2016.7765668.
- [26] Z. Čekerevac, Z. Dvorak, L. Prigoda, and P. Čekerevac, “Internet of Things and the Man-in-the-Middle Attacks – Security and Economic Risks,” *MEST J.*, vol. 5, no. 2, pp. 15–5, 2017, doi: 10.12709/mest.05.05.02.03.
- [27] R. Colelli, S. Panziera, and F. Pascucci, “Securing connection between IT and OT: The Fog Intrusion Detection System prospective,” *2019 IEEE Int. Work. Metrol. Ind. 4.0 IoT, MetroInd 4.0 IoT 2019 - Proc.*, pp. 444–448, 2019, doi: 10.1109/METROI4.2019.8792884.
- [28] R. Gerganov, “nfqsd @ github.com,” 2018. <https://github.com/rgerganov/nfqsd> (accessed Jul. 15, 2018).
- [29] A. Luoto and K. Systä, “IoT Application Deployment Using Request-Response Pattern with MQTT,” in *Current Trends in Web Engineering*, 2018, pp. 48–60.
- [30] R. A Light, “Mosquitto: server and client implementation of the MQTT protocol,” *J. Open Source Softw.*, vol. 2, no. 13, p. 265, 2017, doi: 10.21105/joss.00265.
- [31] D. Londoño and S. Céspedes, “Performance evaluation of CoAP and HTTP/2 in web applications,” *CEUR Workshop Proc.*, vol. 1727, pp. 25–27, 2016.
- [32] D. H. Summerville, K. M. Zach, and Y. Chen, “Ultra-lightweight deep packet anomaly detection for Internet of Things devices,” *2015 IEEE 34th Int. Perform. Comput. Commun. Conf. IPCCC 2015*, pp. 1–8, 2016, doi: 10.1109/IPCCC.2015.7410342.
- [33] J. Hwa Jung, D. Kyu Choi, J. In Kim, and S. Joo Koh, “Mobility management for healthcare services in coap-based iot networks,” *Int. Conf. Inf. Netw.*, vol. 2019-Janua, pp. 7–12, 2019, doi: 10.1109/ICOIN.2019.8718156.
- [34] J. Castro and F. Losilla, “Uso del protocolo CoAP para la implementación de una aplicación domótica con redes de sensores inalámbricas,” p. 42, 2014, [Online]. Available: <http://repositorio.upct.es/bitstream/handle/10317/4163/pfc5908.pdf;sequence=1>.
- [35] I. Andrea, C. Chrysostomou, and G. Hadjichristofi, “Internet of Things: Security vulnerabilities and challenges,” *Proc. - IEEE Symp. Comput. Commun.*, vol. 2016-Febru, no. August 2017, pp. 180–187, 2016, doi: 10.1109/ISCC.2015.7405513.
- [36] “coap\_rfc @ iotestware.readthedocs.io,” 2014. [https://iotestware.readthedocs.io/en/master/coap\\_rfc.html](https://iotestware.readthedocs.io/en/master/coap_rfc.html).
- [37] D. R. Thomas, R. Clayton, and A. R. Beresford, “1000 days of UDP amplification DDoS attacks,” *eCrime Res. Summit, eCrime*, pp. 79–84, 2017, doi: 10.1109/ECRIME.2017.7945057.
- [38] S. Kim, S. Lee, G. Cho, M. E. Ahmed, J. (Paul) Jeong, and H. Kim, “Preventing DNS Amplification Attacks Using the History of DNS Queries with SDN,” in *Computer Security -- ESORICS 2017*, 2017, pp. 135–152.
- [39] A. G. Roselin, P. Nanda, S. Nepal, X. He, and J. Wright, “Exploiting the remote server access support of CoAP protocol,” *IEEE Internet Things J.*, vol. PP, no. c, pp. 1–1, 2019, doi: 10.1109/jiot.2019.2942085.
- [40] A. P. Castellani, T. Fossati, and S. Loreto, “HTTP-CoAP cross protocol proxy: An implementation viewpoint,” *MASS 2012 - 9th IEEE Int. Conf. Mob. Ad-Hoc Sens. Syst.*, vol. 2012-Janua, pp. 1–6, 2012, doi: 10.1109/MASS.2012.6708523.
- [41] Mkovatsc, “Copper4Cr @ github.com,” 2018. <https://github.com/mkovatsc/Copper4Cr>.
- [42] Knolleary, “pubsubclient @ github.com,” 2019. <https://github.com/knolleary/pubsubclient>.
- [43] Timothy J Fontaine, “native-dns-packet @ github.com,” 2014. <https://github.com/tjfontaine/native-dns-packet>.
- [44] “tshark @ www.wireshark.org,” *wireshark*, 2020.

- pages/tshark.html.
- [45] H. Alaiz-moreton, J. Aveleira-mata, J. Ondicol-garcia, A. L. Muñoz-castañeda, and C. Benavides, "Multiclass Classification Procedure for Detecting Attacks on MQTT-IoT Protocol," vol. 2019, 2019.

# Managing Preference Profiles in Multi-User Intelligent Environments

Juan Carlos AUGUSTO<sup>a,1</sup>, Andrés MUÑOZ<sup>b</sup>

<sup>a</sup>*R.G. on Development of Intelligent Environments, Department of Computer Science, Middlesex University London, U.K.*

<sup>b</sup>*Polytechnic School, Universidad Católica de Murcia, Spain*

**Abstract.** Development of Intelligent Environments have been so far mostly ad-hoc and here we investigate one fundamental bottleneck which needs to be addressed to facilitate more effective developments in the future: handling of user preferences in a multiple user environment. This paper analyzes some cases which combine different approaches to manage users preferences combining services at higher and lower levels with user-led and environment-led approaches. We assess some practical pros and cons in each of these combinations as well as some more fundamental building blocks which developers need to reflect on from a scientific point of view before embarking on the engineering of these systems.

**Keywords.** Intelligent Environments, User Preferences, Multi-user Environments, System Design

## 1. Introduction

Intelligent Environments (IE) [1] should be designed to satisfy their users. Most environments are inhabited or used by several users, which leads to decision making dilemmas for the environment [2]. We are investigating ways of representing user preferences and reasoning with the partial orders they represent, in an attempt to automate systems more aligned with user's expectations [3].

Managing user preferences is not new and has been done before within closely related communities such as Pervasive Systems, Ubiquitous Systems and Ambient Intelligence (see for example [4,5]). However, these previous proposals tend to be focused on one user, or more focused on the environment than the humans or assume a "one solution fits all" approach, none of which we think are entirely satisfactory. We think there is scope for a deeper and more ambitious debate which our community should have to support the next evolutionary step in our area, which is reaching certain maturity for single users but still being very basic for the most common multiple-users scenarios.

In this paper we attempt to highlight some of the challenges awaiting us and provide a framework which facilitates discussions and debate about this topic. First we introduce the basic components, concepts and notation which facilitates the explanation of some the challenges we are concerned about. Then we explain some of the scenarios which

---

<sup>1</sup>R.G. on Development of Intelligent Environments, Dep. of Computer Science, Middlesex University London, U.K.; E-mail: J.Augusto@mdx.ac.uk

we believe need further study. Finally, we explore some of the conceptual tools which we think need considering from a more scientific perspective as a preparation to the engineering of such systems with a deeper understanding.

## 2. System Architecture

Consider an Intelligent Environment  $\xi$ , examples could be a smart home, a smart office, a smart hospital. Each of these have associated a number of users<sup>2</sup>  $\Upsilon = \{U_1, \dots, U_u\}$  where each  $U_i$  may have an associated scale creation process which associates scales with users:  $S(U_i) \rightarrow S_{U_i}$ . But, what sort of process would that be?

Sometimes these scales may be external so the scale creation process can be as simple as accepting it. Other times users can be guided in a process to create a personalized scale. See examples of generic scales in Fig. 1(a) below for visitor, adult and teenager, although these could be also for a specific person, say the adult could be John or Alice.

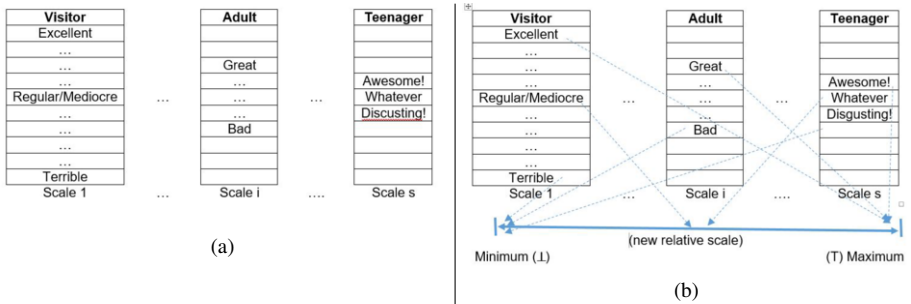

**Figure 1.** a) Examples of individual preference scales; b) Different individual scales being mapped into a system master/reference scale.

To facilitate discussion of various issues related to preferences scales management we will assume each scale  $S_{U_i}$  can be represented as an ordered list (we will assume here they are ordered in growing level of importance) of adjective labels  $A_i = [a_1, \dots, a_z]$  some of which may be synonymous (represented as a set of equally meaningful options), leading to a number  $E$  of meaningful adjectival elements represented, so  $E \leq z$ . For example, in Fig. 1(a) if we assume meaningful adjectival labels were provided in each cell with dots, user visitor will have 11 adjectival labels but only 10 values represented, because Regular and Mediocre are considered by that person to have the same meaning and value:  $S_{visitor}=[\text{Terrible}, \dots, \{\text{Regular, Mediocre}\}, \dots, \text{Excellent}]$ . In some environments it may be that visitors are associated with a default preferences profile, whilst in others it may be the person has a historic profile stored and retrieved at arrival, or it may be generated at arrival based on information provided by the user or the system, so for example when John, a hypothetical user, is detected as a visitor in  $\xi$  he is allocated with the profile  $S_{John}=[\text{Terrible}, \dots, \{\text{Regular, Mediocre}\}, \dots, \text{Excellent}]$ . For some user, say “x”, it could be the case that  $U_x=[ ]$  because they do not have one or do not want to have a preferences profile in a given environment. Therefore, the system will not be able to consider those

<sup>2</sup>Typically human, although non-human entities like pets and robots can be considered users of an environment too and with rights to have preferences.

individuals preferences in its decision making, and as a result the system decisions may be less aligned with the user preferences and perhaps have a less satisfactory experience of that environment. Scales can be imported externally from the user or they can be created on demand as a new user arrives to an environment. In any case we will expect the information from a user can be linked with indices and even when stored internally with scales from other users these indices help us identify which elements of the merged scale belong to which user. As a simplifying assumption in these scenarios we can assume a U.N.A. (unique name assumption) mechanism can be worked out so that all labels in the system can be univocally attached to different individuals without confusion.

In Intelligent Environments there is a need to understand how a user will perceive the adequacy of the services being exposed to. Also as these environments are usually shared there is also a need to understand how the perceptions from different users relate to each other and how the system can manage these combinations of value scales. Hence one of the main topic concerning us in this study is how  $\xi$  can integrate the scales of its users (see Fig. 1(b)). The new environment “master scale”  $S_\xi$  should be able to accommodate and combine all scales from all users in that environment  $\xi$ .

The preference integration problem augments its complexity when we assume each  $\xi$  has a number of associated services the environment is supposed to manage in favour of the users. We can represent these services as a set  $\Sigma = \{\sigma_1, \sigma_2, \dots, \sigma_s\}$ , which we assume non-empty given we are assuming an environment which can do at least something useful. As a result, each user may have a different scale for each service, represented as  $S_{U_i}^{\sigma_j}$ , that will need to be integrated with the rest of users scales for that service. So we have some interesting variables emerging here already, different users, different services, and different value scales about what users consider better or worse.

It could be that these user value scales have some metrics attached and in the ideal case if these metrics are the same or there are well known systems to transform one metric system into the other then allows us to immediately relate the elements of both scales. Say we have two users of an office, Alice and John, and  $S_{Alice}^{temperature} = [\text{chilly, mild, hot}]$ ,  $S_{John}^{temperature} = [\text{cold, temperate, warm}]$ . There is no way as such to determine whether what Alice has in mind when stating the environment is mild is the same than what John means when stating the the environment is temperate. Without this information we do not have a way to order them and the system does not know whether temperate is the same than mild or colder or hotter and by how much. As a result, we will apply the following process: we assume each adjective label has attached a value, so that if  $A_i = [a_1, \dots, a_z]$  is a list of adjective labels,  $v(A)$  gives us a vector  $[v(a_1), \dots, v(a_z)]$ , e.g.  $S_{Alice}^{temperature} = [(\text{chilly}, 20^\circ\text{C}), (\text{mild}, 25^\circ\text{C}), (\text{hot}, 30^\circ\text{C})]$  and  $S_{John}^{temperature} = [(\text{cold}, 17^\circ\text{C}), (\text{temperate}, 22^\circ\text{C}), (\text{warm}, 26^\circ\text{C})]$ . Merging these two individual scales in one will result in  $S_\xi^{temperature} = [(\text{John\_cold}, 17^\circ\text{C}), (\text{Alice\_chilly}, 20^\circ\text{C}), (\text{John\_temperate}, 22^\circ\text{C}), (\text{Alice\_mild}, 25^\circ\text{C}), (\text{John\_warm}, 26^\circ\text{C}), (\text{Alice\_hot}, 30^\circ\text{C})]$ . Should it have been  $S_{John}^{temperature} = [(\text{cold}, 41^\circ\text{F}), (\text{temperate}, 77^\circ\text{F}), (\text{warm}, 95^\circ\text{F})]$  then the merging would have resulted into  $S_\xi^{temperature} = [(\text{John\_cold}, 5^\circ\text{C}), (\text{Alice\_chilly}, 20^\circ\text{C}), (\text{Alice\_mild}, 25^\circ\text{C}), (\text{John\_temperate}, 25^\circ\text{C}), (\text{Alice\_hot}, 30^\circ\text{C}), (\text{John\_warm}, 26^\circ\text{C})]$ . We will discuss towards the end of the article the formalities of operations such as merging of scales.

Sometimes these values  $v(a_i)$  may not be available and the system will have to apply some default assimilation process, for example, if an incoming scale  $S$  has to be assimilated into a system global scale  $S_\xi$ , then it could be considered that the highest value of

$S$  is assimilated with the highest value of  $S_{\xi}$  and internal values in between are proportionally spread out. Say  $S_{\xi_1} = [\perp = b_1, b_2, b_3, b_4, b_5 = \top]$ , and  $S_{\xi_2} [\perp = l_1, l_2, l_3, l_4 = \top]$ , then the merging could result on  $S_{\xi} = [\{b_1, l_1\} b_2, l_2, b_3, l_3, b_4, \{b_5, l_4\}]$  and unknown values calculated relative to border neighbour known values, for example the  $v(l_3) = (v(b_3) + v(b_4))/2$ .

Therefore we expand our initial basic concept of a user scale into a list of pairs (adjective\_label, value(adjective\_label)):  $S_{U_i} = [(a_1, v(a_1)), \dots, (a_z, v(a_z))]$ . As we expressed at the beginning, some scale levels may have more than one adjective label associated with the same meaning or relative value within the scale, for example having more than one word to refer to the same sensation of warmth. So the most complete description is:

$$S_{U_i} = [\{(a_1, v(a_1)), \dots, (a_1^n, v(a_1^n))\}, \dots, \{(a_z, v(a_z)), \dots, (a_z^m, v(a_z^m))\}]$$

Each system may consider what is the standard internal translation unit, could it be numerical or not. For simplicity, we assume  $\mathbb{R}$  (actually a suitably finite subset of it will be enough) as the internal universal numerical scale all values can be ultimately compared through. Hence, when throughout this article we refer users scales:  $S(U_i) \rightarrow S_{U_i}$ , we refer to them as in the sense discussed in the paragraph above, that is with a value function attached in each of these components, even if this sometimes may return trivial values because the scale as not been provided with meaningful values.

### 3. Scales Integration Scenarios

There are various different ways of organizing preferences and their management and most likely there is no single way which is the best for all environments. Consider for example the variety of needs amongst environments with such diversity of privacy, security, population and objectives as smart homes, smart offices, smart hospitals, smart shopping, etc. However, it is in the interest of our community to explore, understand and find recipes which can work for at least certain subsets of those problems.

Two interesting conceptual dimensions which we think may help to conceptualize this problem are:

- Whether the user's scale is about his/her perception of the whole IE  $\xi$  or is about each specific service  $\sigma_i \in \Sigma$  of  $\xi$ . Hence, we have two categories we are interested in exploring:  $\xi$ -type and  $\sigma$ -type.
- Whether the management system is such that it allows different external profiles to be accommodated in the system or not. We can call these *Human-led* or *System-led*, meaning in the former the system should adapt to the scale the user is bringing whilst in the later the user has to fit in her/his preferences into what the system offers.

We explore these four combinations (in no particular order) for a smart office scenario:  $\xi$ -type / Human-led (Fig. 2a);  $\sigma$ -type / Human-led (Fig. 2b);  $\xi$ -type / System-led (Fig. 2c); and  $\sigma$ -type / System-led (Fig. 2d).

While exploring the scenarios, we will take into account the four opposing forces involved in the design of IEs in accordance with the Intelligent Environment manifesto [1], namely Cost, Complexity, Services and Privacy as illustrated in Fig. 3a.

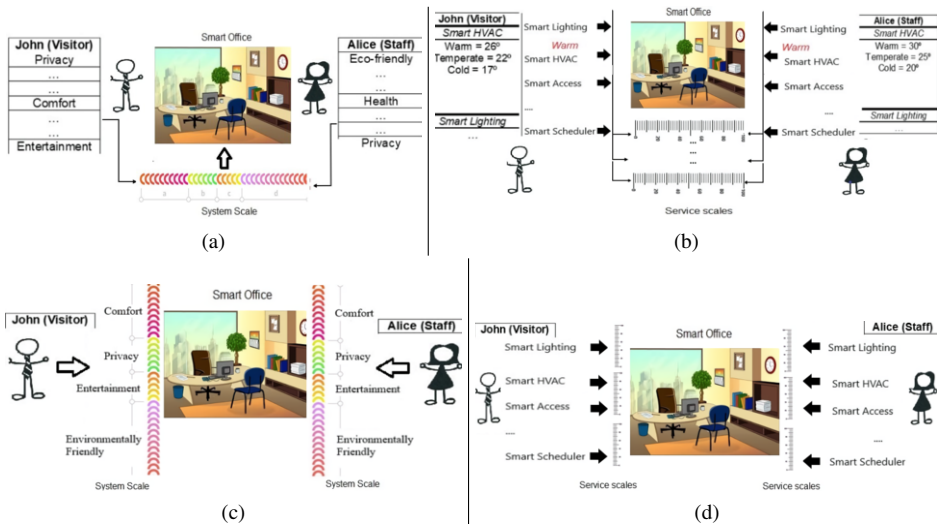

**Figure 2.** Four combinations of user preferences: a)  $\xi$ -type/Human-led scenario; b)  $\sigma$ -type/Human-led scenario; c)  $\xi$ -type/System-led scenario; d)  $\sigma$ -type/System-led scenario.

Let us suppose that there are two users interacting in this smart office scenario, Alice and John, who are co-working and sharing the same office. Alice is a staff member of the company whereas John is a visitor from an abroad branch of the same company. Let us explore how the definition of their preferences is performed in each scenario of Fig. 2.

In the  $\xi$ -type / Human-led scenario (Fig. 2a), both users are prompted to express their own order of preferences for any IE. Thus, users are free to choose any valid preference language for the smart environment and to include any kind of possible preference, either it can be processed by the specific smart environment or not. Note that some preferences values may coincide for different users (e.g., “Privacy”). In this case, John indicates to the IE that the privacy issues in the office (i.e., a secure and non-shared Internet connection but also shading windows to avoid sideways glances) are the most important element for him, followed by the availability of comfort elements, and stating that the entertainments options in the office (e.g., notification about leisure activities with co-workers or automatic management of entertainment spaces in the office) is the least important element. On the other hand, Alice indicates to the IE that her main preference is to use the available services in an environmentally-friendly way (e.g., reducing the use of lighting or HVAC devices), which is preferred to the use of office elements devoted to create a healthy workplace, and finally the least important elements for her are the ones related to privacy issues. This scenario presents several challenges. First, there should exist a (preferably standard) language to express the users preference that is understood by the IE. Ontologies [6,8] may come here as a useful resource. Secondly, the users preferences should be translated to the IE preference scale. For example, in Fig. 2a a system scale is shown where each segment (*a*, *b*, *c* and *d*) represent a preference element in the system. Note that these preference elements will not necessarily be the same as the users preference ones (for example, it could be that without further guidance John’s “Comfort” concept may be represented in the IE as the “Health” concept). As a result, a matching process is needed to solve this problem. Ontology matching or alignment [7] could be applied here. Finally, conflicts in IE will arise when different users’ preference orders

affect to the same elements in the IE. For example, John's privacy preference resulting in shading the windows will imply in using more lights, which conflicts with Alice's eco-friendly preference on reducing the use of artificial lights. A possible solution based on argumentation was provided by the authors elsewhere [2]. This scenario introduces a high complexity due to the large amount of external information to be integrated in the system and the merging operators involved in this task. This includes the capability of the system of "understand" the different languages in which the external user preferences could be expressed, augmenting the cost of the system for each language to consider. Besides that, the services offered may not be clear to the users as they perceive the system as a whole unit, so they cannot express their preference for a specific service. Finally, privacy matters should be taken into account as the users may own different preference profiles on different IEs (e.g., the preference profile for a smart home will be different to the preference profile for a smart office). As a result, it must be clear which preferences are being communicated to the new IE and which ones are to be kept out.

In the  $\sigma$ -type / Human-led scenario (Fig. 2b), the users are now prompted to define their preferences for each service available in the IE (e.g., smart lighting, smart HVAC, etc.). In this case, each user defines his/her preferences value for the possible states of each service. For example, in the case of the smart HVAC with three possible states: warm, temperate and cold, the users could assign a numerical temperature value to each state. Then, they could order these states for each service and send the information to the IE. The challenges found in this scenario are the following. First, the states of each service may be unknown for new users who are not previously registered in the IE. In fact, these users may import their preference profile from their previous IE and they may want to use it in the new IE. It is even possible that some services that were available in their former IE are not available in the new IE any more. Then, a matching process is needed again between the users preference information for each service and the actual services in the IE. This process may include the translation of the users preferred value (e.g., warm) to the actual value in the service (28°C). Other challenges are the language used to express the preferences for each service and the potential conflicts among users preference, as discussed in the  $\xi$ -type / Human-led scenario. Note that in this case, even though two users prefer the same value for a service, it may lead to a conflict. For example, in Fig. 2b both John and Alice prefer the HVAC to be activated as "warm", however their concept of "warm" is different since John considers it as 26°C whereas Alice does it as 30°C. This scenario introduces a higher complexity and cost than the previous one ( $\xi$ -type / Human-led), since the dependence of external information now increases for each new service included in the user preferences. However, the user perceives a better alternative to manage services. Again, privacy needs to be consider since different user profiles for the same service in different IEs may coexist.

In the  $\xi$ -type / System-led scenario (Fig. 2c), each user is presented with a predefined preference list that should be ordered by them. In this case, the preference list is the same for every user. For example, John and Alice are presented with a list including 4 preference elements, namely "Comfort", "Privacy", "Entertainment" and "Environmentally Friendly". In this system it should be decided how the preferences are ordered, taking into account if total orders are required or if partial orders are allowed, or if each preference element is given a weight or numerical value, etc. A challenge identified here is how the IE will behave as an integral unit to satisfy the most of the preference requirements of a user. Another challenge is related to conflicting preference in multi-user sce-



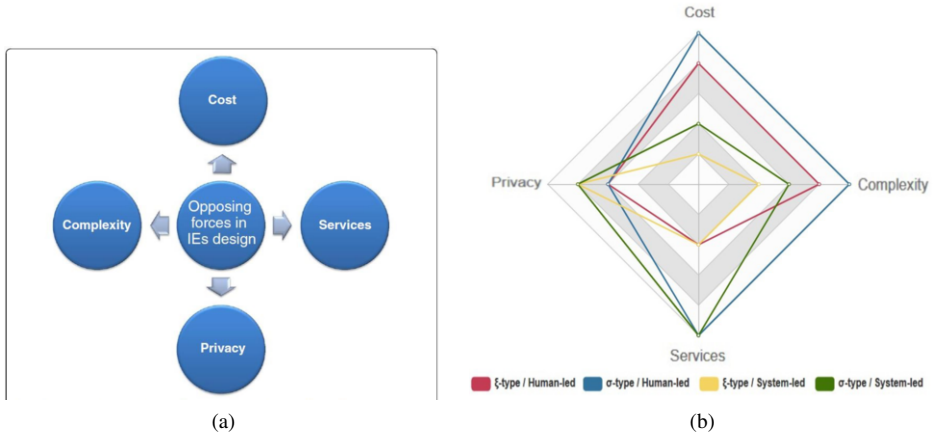

**Figure 3.** a) Opposing forces in IE development [1]; b) Relationships of the IE driving forces  $\xi$ -type/ $\sigma$ -type and Human-led/System-led scenarios.

narios, as discussed for the previous scenarios. The complexity and cost of this scenario are lower than in two previous scenarios, since no external information regarding user preference needs to be integrated, and for this reason too, privacy matters could be more easily managed. However, the system is more restricted with respect to the definition of preferences than in the previous scenarios, and therefore users are constrained to the language imposed by the system, reducing the user’s perception about the management of the services offered.

Finally, in the  $\sigma$ -type / System-led scenario (Fig. 2d), each user is presented with a predefined scale for each service. In this case, users need to configure the value for each service within the parameters offered by the service. The most likely challenge here is dealing with conflicting values for each service for different users. Another challenge could be the situation of services for the same user “competing” among them, e.g., a user indicating a high preference on services offering comfort features but also a high preference on using eco-friendly services. This problem may be solved by the users themselves by stating an order among services, but it could be a rather complicated process when a large number of services are offered and no explicit connection among them has been foreseen. Therefore, an automatic way of solving this problem will be desirable. The opposing forces in the design of IEs for this scenario follow the same rationale than in the  $\xi$ -type / System-led scenario, with a small increase in complexity and cost due to the necessity of managing different services, whilst improving the user’s perception on the services offered as they can now be managed separately. From the above scenarios we can see different forces at play and competing with each other, and it seems one principle is emerging for engineers to pose to the project funders. If we accept an IE as a system which should aim to maximize the perceived effect of context services by the environments users [3], then human-led systems requiring a large amount of information so the system can make more informed choices may be favoured. However, if there are budget restrictions then system-led options will be simpler to design and create, although the system may be less satisfactory. In all multi-user options there will be disagreements, just the more effort is gathered from user preferences the more information the system may have to consider exceptions instead of applying blanket decisions to all. Fig. 3b summa-

rizes the mutually competing of the opposing forces in these scenarios. It is observed that the *Human-led* scenarios are expected to have the highest cost and complexity, due to the large amount of information to be integrated in them and the processes associated to this task. Likewise, the  $\sigma$ -type scenarios are expected to be more complex and costly than  $\xi$ -type ones, due to the management of services for the same user and also the management of the same service among different users. Regarding the Service dimension, it is obvious that the *System-led* scenarios are the ones offering a broader palette of services. Finally, it can be considered that *System-led* scenarios could preserve better the user privacy, as they do not need to be fed with user's profiles imported or created in other scenarios.

#### 4. Preparing the Technical Ground

At a more technical level, we can consider the question of what conceptual tools developers will need should they try to make user preferences a more systematic and better organized part of their system creation. So far we have considered the following ones.

##### 4.1. Elementary Operations

Here we define some simple tools which will help in the next subsections.

Given a scale  $S = [e_1, \dots, e_l]$ ,  $\text{length}(S)=l$  is the number of elements in the scale. Remember a scale can have non-atomic elements with some of the elements consisting actually of a set of adjective labels which are considered to have the same overall meaning, some sort of synonymous as far as the scale concerns. So if  $S = [\{(cold, 5)\}]$ ,  $S' = [\{(cold, 5)\}, \{(hot, 25)\}]$  and  $S'' = [\{(cold, 5)\}, \{(hot, 25)\}, \{(warm, 25)\}]$  then  $\text{length}(S) = 1$ ,  $\text{length}(S') = 2$ , and  $\text{length}(S'') = 2$ . As "preferential synonyms" are sets we can use the usual set operations such as cardinality to work out in how many ways a concept is described by a user. We can also use the usual list operations, for example to retrieve an element which is in the  $i$ -th position or an element which adjective label or value meet certain properties.

Also it will be often necessary to compare two elements from two different scales. Here several options open up based on how literal and strict the match between these two elements is expected to be. For example, if one element in the John's temperature preferences scale is  $e_1 = (warm, 30^\circ C)$  and the other element in Alice's temperature preferences scale is  $e_2 = (warm, 30^\circ C)$  then that is an exact match. If we compare  $e_1 = \{(warm, 30^\circ C)\}$  and  $e_2 = \{(warm, 30^\circ C), (hot, 30^\circ C)\}$  the answer is not so obvious: the content of  $e_1$  is in  $e_2$ , however strictly speaking  $e_1$  is structurally different to  $e_2$  as the later contains a "scale synonymous". Thus, a comparison which is 'modulo "scale synonymous"' will be intelligent enough to return true, one which is too literal will return false. As a result, we can define two match operations:

*Literal element match* ( $e_1 \doteq e_2$ ):  $e_1 = \{(a_i, v(a_i)), \dots, (a_i^{k_i}, v(a_i^{k_i}))\} = e_2$

*Similarity element match* ( $e_1 \simeq e_2$ ):]

$$e_1 = \{(a_i, v(a_i)), \dots, (a_i^{k_1}, v(a_i^{k_1}))\} \text{ and } e_2 = \{(a_j, v(a_j)), \dots, (a_j^{k_2}, v(a_j^{k_2}))\}$$

This can be "adjective label based": there is at least one  $a_i^{k_m}$  and one  $a_j^{k_n}$  such that  $a_i$  and  $a_j$  are the same adjective label. Or, it can be "adjective value based": with some  $a_i^{k_m}$  and some  $a_j^{k_n}$  such that  $|v(a_i^{k_m}) - v(a_j^{k_n})| < \delta$  for some pre-specified  $\delta$ , i.e., the

values are “close enough” regarding a context. These types of matching ignore the possible presence of various synonyms for some elements in any of the scales.

#### 4.2. Built-in Operations

Let be  $S_1 = [\dots \{(a_i, v(a_i)) \dots (a_i^{k_1}, v(a_i^{k_1}))\} \dots]$ ;  $S_2 = [\dots \{(a_j, v(a_j)) \dots (a_j^{k_2}, v(a_j^{k_2}))\} \dots]$  then the following *Logical Scale Operations* can be considered:

*Compares*=( $S_1, S_2$ ): a Boolean function returning true when both scales  $S_1$  and  $S_2$  are “equivalent” and false otherwise. We can again establish different criteria based on how strict the matching has to be at element level:  $e_1 \doteq e_2$  or  $e_1 \simeq e_2$  or other element comparison operator.

*Inclusion*( $S_1, S_2$ ): a Boolean function returning true when all elements of  $S_1$  are in  $S_2$  and false otherwise. This function again depends on how equality amongst elements is defined, whether literal or approximate.

Let be  $S$  and  $S'$  two arbitrary well-formed scales in the sense discussed above, then the following *Build Scale Operations* can be considered:

*Add*( $e, S, S'$ ): adds  $e$  at the appropriate place in list  $S$  resulting in  $S'$ .

*Delete*( $e, S, S'$ ): extracts  $e$  from  $S$  resulting in  $S'$ .

*Replace*( $e, e', S, S'$ ): replaces  $e$  by  $e'$  in  $S$  resulting in  $S'$ .

*Transfer*( $S, S', S''$ ): provided  $length(S) = length(S')$  then for each  $i$ -th  $e$  of  $S$  the value of  $e$  overrides the value of the  $i$ -th element  $e'$  in  $S'$  and the resulting list is  $S''$ .

And the following *Scale Level Operations* can be considered:

*Absorbing*(*incomingScale*,  $S, S'$ ): is an (adjective value) ordered merge, based on the values of each adjective label so that elements in “incomingScale” are added to  $S$ , resulting in  $S'$ .

*Detaching*(*outgoingScale*,  $S, S'$ ): for all elements in “outgoingScale” it effectively Delete( $e, S, S'$ ).

#### 4.3. System Properties

We can define an algebraic structure with the set of possible scales definable over a bounded fragment of  $\mathbb{R}$  as the carrier and have associated the operations outlined above. Investigating this in more depth is a task we will not pursue here, although we recognize the value of investigating algebras with different properties which will affect the expectations from the developers in terms of the trade-off between feasibility of implementation and predictability of operations.

Algebraic structures have intrinsic properties derived from the initial assumptions imposed over them, however in our field we also have a growing number of consumer expectations which are external to the system and system engineer are increasingly under pressure to accommodate. For example, nowadays technology consumers are becoming more aware of their rights over their own data, and consequences of legislation such as GDPR give consumers more rights (and developers more obligation) on *traceability* of their data. This overall property over the set of scales in a system requires that data which is linked to a specific user should be traceable within the system in case a user requests his/her history to be removed. This can be achieved in practice in many ways depending on the way the databases are implemented. In general terms:

An environment  $\xi$  is *scale-traceable* if for every user  $U_i$  and scale  $S_{U_i}$ , it is possible to apply  $\text{Detaching}(S_{U_i}, S, S')$ .

## 5. Conclusions and Future work

Creating intelligent environments is a challenging enterprise as our community has discovered in so many years of hard work before. However, some progress has been made and there is an increasing expectation that multiple user environments should and could be more feasible now. So we have analyzed above one important bottleneck, namely the lack of shareable resources for developers which want to tackle such systems. Most multiple users environments are created pretty much in an ad hoc manner.

Our approach above is a first look at this problem and it will not be hard to persuade us many more things need to be considered. As a first approach we have made some assumptions which in practice may require relaxing to be useful. For example, we assumed that given  $S_{U1} = [\perp_1, \dots, \top_1]$  and  $S_{U2} = [\perp_2, \dots, \top_2]$  then  $\perp_1 \equiv \perp_2$  and  $\top_1 \equiv \top_2$ . How operations are affected when this assumption is removed and either or both of  $\perp_1 \equiv \perp_2$  and  $\top_1 \equiv \top_2$  do not hold, or we do not know, or is not accepted by one of the sides?

We have analyzed how these essential building blocks can be achieved in a system. ‘A priori’ we see various competing reasonable ways to develop these and we considered four of those which combine different possible and valid approaches to manage users preferences. These combine services at higher and lower levels with user-led and environment-led approaches. We did the exercise of exploring some of the practical pros and cons in each of these combinations to trigger some reflections on potential developers. We hope this will spark some discussion and sharing of tools which will help to treat development of multiple user environments in a more organized and professional way.

## References

- [1] J. C. Augusto, V. Callaghan, D. Cook, A. Kameas, and I. Satoh, “Intelligent Environments: a manifesto,” *Human-centric Computing and Information Sciences*, vol. 3, no. 1, pp. 1–12, 2013.
- [2] C. Oguego, J. Augusto, A. Muñoz, and M. Springett, “Using argumentation to manage users preferences,” *Future Gener. Comput. Syst.*, vol. 81, no. C, p. 235-243, 2018.
- [3] J. C. Augusto and A. Muñoz, “User preferences in intelligent environments,” *Applied Artificial Intelligence*, vol. 33, no. 12, pp. 1069–1091, 2019.
- [4] E. Papadopoulou, S. Gallacher, N. K. Taylor, M. H. Williams, and F. R. Blackmun, “Context-aware user preferences in systems for pervasive computing and social networking,” in *1st Int. Conf. on Context-Aware Systems and Applications*, Vietnam, P. C. Vinh et al., Eds., vol.109. Springer, 2012, pp. 10–17.
- [5] S. Gallacher, E. Papadopoulou, N. K. Taylor, and M. H. Williams, “Learning user preferences for adaptive pervasive environments: An incremental and temporal approach,” *TAAS*:(8)1, pp. 5:1–5:26, 2013.
- [6] T. R. Gruber, “A translation approach to portable ontology specifications,” *Knowledge Acquisition*, vol. 5, pp. 199–220, 1993.
- [7] V. Rajeswari, M. Kavitha, and D. K. Varughese, “A weighted graph-oriented ontology matching algorithm for enhancing ontology mapping and alignment in semantic web,” *Soft Computing* (23)18:8661-76, 2019.
- [8] M. Martnez-Garca, A. Valls, and A. Moreno, “Inferring preferences in ontology-based recommender systems using WOVA,” *Journal of Intelligent Information Systems* (52)2:393-423, 2019.

2nd International Workshop on Intelligent  
Environments and Buildings (IEB'20)

This page intentionally left blank

# Multi-Scaled Outdoor Temperature Models Within the London Building Domestic Stock of Westminster

Mohammed BAKKALI<sup>a,b,1</sup>

<sup>a</sup>The Bartlett School, University College London, UK

<sup>b</sup>ICT Research Laboratory, International University of Rabat, Morocco

**Abstract.** There is a lack of understanding the impact of urban environment on local temperatures. This deficit is partially due to some overlapping issues within different numerical modelling approaches especially when it comes to the scale in which every model operates and to the implementation of multi-scaled strategies. These overlying problems leave a knowledge gap that should be explored further. Multi-scaled stratagems are sometimes implemented and this requires to go through a best practice approach. There are discrepancies between temperature models, for instance, whether they operate at city scale or at street scale. This is comprehensible since each model is programmed for specific research purposes. Nevertheless, some attention needs to be paid to these overlapping issues in order to target more efficient and reliable output results. One way of tackling the issue is through analysing key spatial features and different parameterization schemes in accordance to the applied governing equations that act on every temperature model. Land use, street canyons and buildings were defined as key spatial features that generate relevant urban parameters for aerodynamic and thermodynamic surface forcing. The approach adopted in this paper hires the vision established in the UK EPSRC funded project on the development of a local urban climate model for the intelligent design of cities (LUCID) and it employs its different physics and other based temperature models. The LUCID temperature models worth investigating whether there is a possible lack of synergy behind their application and it needs to highlight some of the reasons behind inconsistencies in output results. The LUCID models were therefore used.

**Keywords.** Urban environments, local temperature models, numerical modelling, multi-scaling, surface forcing, discrepancies

## 1. Introduction

This research is interested in the way urban environments impact local temperatures. The LUCID models were developed for the assessment of temperature levels in central London, mainly, urban heat islands. Different models were developed. Two models calculated temperature levels at city-scale, namely, the London site specific air temperature model (LSSAT) [1] and the London unified model (LondUM) [2 - 4]. The atmospheric dispersion modelling system temperature and humidity model (ADMS T & H) [5] calculated temperature levels at neighbourhood scale. The Outdoor Room model calculated temperatures at street scale [6]. All the models were developed and

---

<sup>1</sup> Corresponding Author: The Bartlett, UCL Institute for Environmental Design and Engineering, Central House, 14 Upper Woburn Place, WC1H 0NN London, UK; E-mail: mohammed.bakkali.10@ucl.ac.uk.

ran separately. This research tries to depict discrepancies between different temperature models and why they occur.

Another version of ADMS urban was used recently along weather research and forecasting (WRF) model in order to estimate air pollution levels within central London as a part of a downscaling approach for air pollution modelling by the environmental research group in Kings College London [7]. Other international researchers coupled WRF model with the Energy Plus model, WRF was used for the meteorological boundary conditions for Energy Plus. Energy Plus calculated energy use for archetypal buildings in idealised canopies in every spatial grid of few kilometres each. The calculation of energy use was used in order to estimate manmade heat emissions, which were in turn integrated into the energy balance model of WRF for a better estimation of outdoor air temperatures [8 - 10]. This numerical approach was based on two way coupling. Similar investigations were tested in this research. Most of the discrepancies between the LUCID models were related to different numerical capabilities and sensitivities coming mainly from their respective modelling details of the surface forcing within the surface layer in addition to how smartly and efficiently different governing equations and urban parameterization schemes were used. Numerical discrepancies were based on time lag and amplitude of temperature levels. In terms of computational cost, the LondUM model was expensive, however, the other models were accessible and they were easily operated. For more reliable calculated local temperature profiles, the use of measurements from a local weather station would have been the best option. London however still lack reliable local weather database. Therefore, multi-scaled temperature models could be a useful alternative in this context. The LondUM model was the most reliable model among the LUCID models, although, temperature levels were calculated at  $z=10$  metres equivalent to the theoretical blending height. Calculated temperatures were then extrapolated to pedestrian levels using the Monin Obukhov Similarity Theory (MOST). Calculated temperature profiles from city scale models could be used as initial boundary conditions for temperature modelling in neighbourhoods, streets and buildings (see, figure 1). More specifically, the aim of this research was to understand the impact of local building domestic stock on diurnal outdoor temperature variations along with their effects on energy demand in the long run.

## **2. Developing a multi-scaling approach**

This research explores the reasons behind the discrepancies between the LUCID models [11], which could be of great helpfulness once applied to energy demand, comfort, health and hazards' models and hence it allows the development of more useful public policies. Results from the following four LUCID models were used: LondUM, LSSAT, ADMS T & H model and Outdoor ROOM model along with the chartered institute of building services engineers design summer year (CIBSE DSY). These models calculated temperature perturbations within central London. Both the spatial features of buildings and land use were considered. For Westminster City Council, two temperature models were run, i.e. ADMS T & H model for the effect of land use on temperature perturbations at neighbourhood scale with a spatial resolution of 15 metres x 15 metres and outdoor ROOM model for the effects of physical characteristics of street canyons on radiant, air and operative temperatures. Calculated



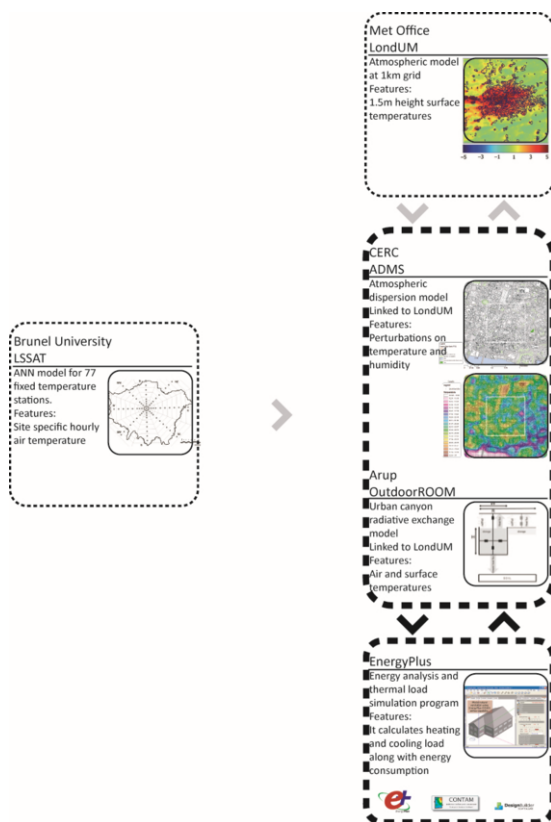

Figure 1. The LUCID temperature models.

temperatures were then compared with output results from other remaining models, namely LondUM model that was run at a spatial resolution of 1km x 1km (including results at a height of 1.5m) for long and short-term periods and LSSAT model that was deduced from specific locations within central London. Some variability and differences were interpreted by plotting different temperature profiles. Most of which were certainly related to the way the physics were encompassed and the way urban environments were parameterised in every model, i.e. governing equations and urban parameterisation schemes along with potential coding errors.

From citywide to street scale, the effects of increased spatial resolution and data on temperature perturbations were considered. This led to more localised temperature models that are well-informed in terms of land use distribution, radiation effects within canyons and building thermo-physical properties. The models helped in having better insights on the way various housing building fabric within Westminster City Council impacts local temperatures.

This research investigated spatial characteristics along with diurnal outdoor temperature variations. Spatial features such as floor space index (FSI), ground space index (GSI), wall-to-volume ratio and building typology were included.

Surface coverage parameter or ground space index (GSI) expresses the compactness of an area; it is calculated by dividing the built area by the plan area [12 - 13].

This is the ratio of a surface covered by buildings from a total surface of a given area. From the same research work [14], this was found to have very little correlation with heat energy demand. Heat energy demand increased with decreasing surface coverage. The correlation coefficient was found to be 0.40.

Floor space index (FSI) expresses the built intensity of an area. The ratio between the total internal floor area of buildings and the land upon which they sit for a given sample area. From the LSE Cities research work [14], it was found to be a good parameter for predicting heat energy demand via a logarithmic relationship with heat energy demand decreasing with increasing density. The correlation coefficient was approximately equal to 0.77.

Wall-to-volume ratio is the ratio of external facades' surface of a building to the entire volume of that building. It was found from the same source [14] to show a linear relationship with heat energy demand increasing with increasing wall-to-volume ratio. The correlation coefficient was 0.80.

Building typology describes the form and function of individual buildings. For heating energy demand in residential buildings, compact urban blocks perform the best and detached housing performs the worst.

This research will include an investigation of the London domestic building stock of Westminster City Council.

The following data was used to accomplish these researches: Ordnance Survey MasterMap data, UKMap data, LIDAR height data, Virtual London model (frontal and planar area indices), Met Office Reading Urban Surface Exchange Scheme (MORUSES), The London Air Quality Network (LAQN), UK Climate Projections 2009 (UKCP09), Weather Underground data, UK National Statistics Neighbourhood Statistics, DECC Statistics, Household Energy Efficiency Database (HEED), Non-Domestic Energy Efficiency Data Framework (NEED), CCWorldWeatherGen, Climate Change World Weather File, Generator for World-Wide Weather Data, ArcGIS, Geographic Information System, The London Energy and Greenhouse Gas Inventory, DEFRA, BIS.

### **3. Outdoor temperatures within the domestic Building stock of Westminster City Council**

#### *3.1. Urban structure*

Seven construction eras were identified in this district of Westminster City Council. Most of the studied building stock was built prior to World War II. This included the following construction categories: Historic to end Georgian, early and middle Victorian, late Victorian to Edwardian and World War I to World War II. Another important domestic building stock was built after World War II and this includes the post war's regeneration, sixties and seventies constructions and post seventies developments. This research investigated many effects of the urban fabric on outdoor temperatures. Maximum building's height over the selected district was approximately 63 metres. Georgian buildings were quite high from 21 to 34 metres and some of the buildings were 63 metres high. Middle Victorian buildings were between 6 – 15 and between

### Housing Typology

#### Building type

- Point block slabs
- Flats 4-7 storeys
- Line built walk up flats & purpose built mews 3-4 storeys
- Tall purpose shared discrete houses & maisonettes
- Tall terraces 3 plus storeys
- Two storey terraces with large T
- Two storey terraces with small or no T
- Linked and strep linked two storey
- Normal size semis
- Bungalows & single storey houses
- Normal detached houses
- Large detached houses



0 0.25 0.5 1 1.5 2 Kilometers

#### Housing Typology

##### Building age

- Historic to end Georgian
- Early and middle Victorian
- Late Victorian - Edwardian
- WW1 to WW2
- Post war regeneration
- Sixties and seventies
- Recent years
- Unknown age



0 0.25 0.5 1 1.5 2 Kilometers

#### Housing Typology

##### HEIGHT

- 0 - 6
- 6.1 - 15
- 15.1 - 21.5
- 21.6 - 34
- 34.1 - 63



0 0.25 0.5 1 1.5 2 Kilometers

**Figure 2.** The distribution of different building types over a district in Westminster City Council (on the top), Age of buildings from historical to post seventies constructions (bottom left) and Building height distributions (bottom right).

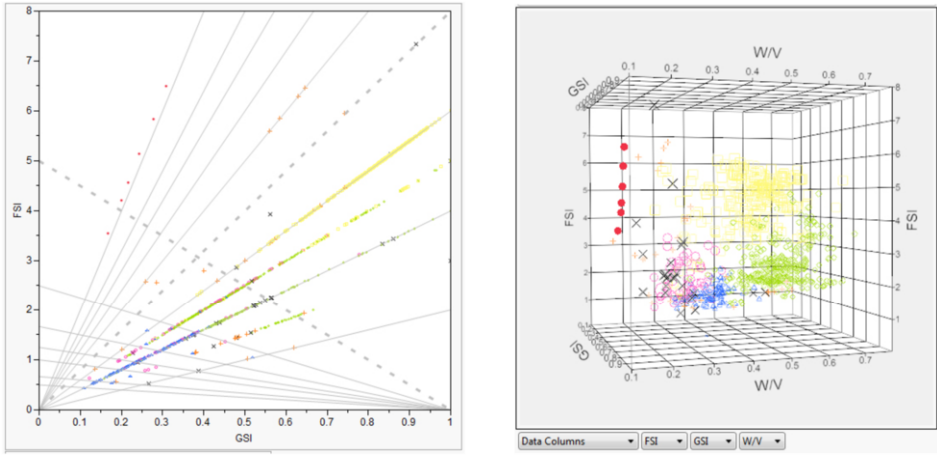

Figure 3. Urban spatial features within the district using the Space Matrix: FSI, GSI and wall-to-volume ratios (W/V).

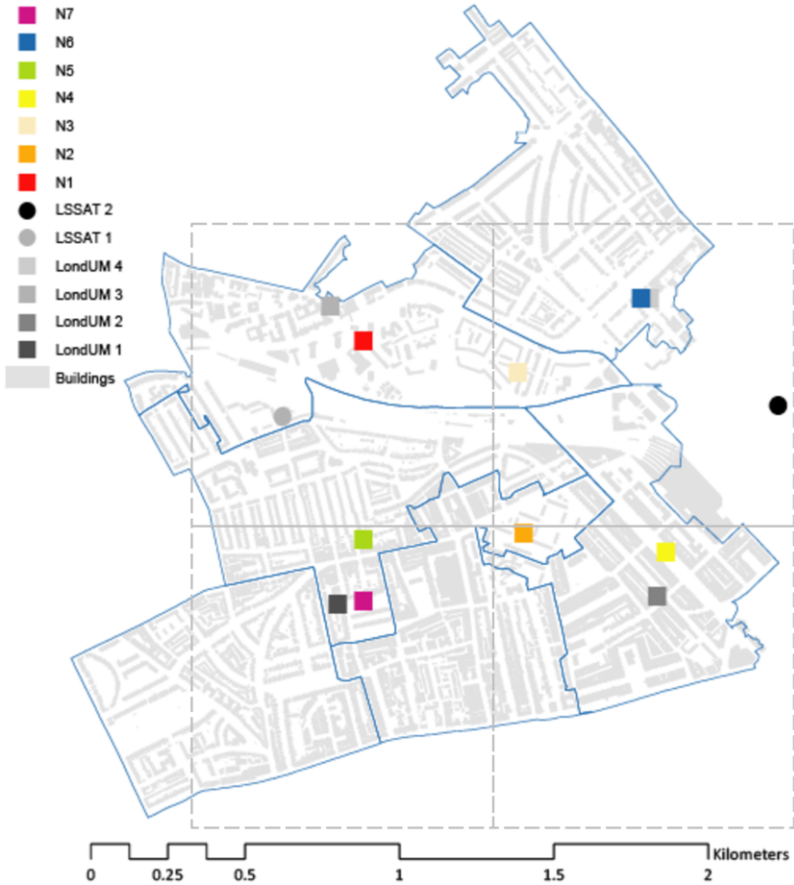

Figure 4. This map shows locations where LSSAT, LondUM and ADMS T & H models were used for temperature calculations.

15 – 21 metres high. Post war buildings were diverse and building's height varied between 6 – 63 metres with high tower blocks. Twelve building types were defined in this case study. Two storey terraces and tall terraces of three storeys or over formed most of the building stock. Linked and step linked two storeys, large and normal detached houses, line built walk up flats and purpose built mews 3 to 4 storeys and tall houses and maisonettes formed also an important part of the building stock.

The Space Matrix was used so that spatial features were assessed in terms of built intensity, compactness and the size of the building envelope surface via FSI, GSI and W/V. These parameters were quite diverse in the presence of a very rich building stock. Data from Ordnance Survey MasterMap and Cities Revealed was used for this research.

### *3.2. Temperature models*

The colourful, grey and black spots show the centre of each calculated spatial grid where, for instance, the LondUM was operated at 1km x 1km resolution. Every grid had different set of urban parameters values. The figure above shows how the LSSAT and the LondUM covered calculations over Westminster City Council (see, figure 4). Temperature profiles were established from five different models as cited earlier. It covers one of the hottest weeks measured ever in London extending from 14<sup>th</sup> to 19<sup>th</sup> July 2006. The outdoor temperature models were whether statistical, artificial neural network based or physical. CIBSE DSY, LSSAT and LondUM operated at city-scale, ADMS T & H operated at neighbourhood-scale and Outdoor ROOM operated at street-scale were all used. The first research stage involved looking at correlations between urban spatial characteristics: building typologies, building height, FSI, GSI, wall-to-volume ratios and temperature perturbations. In previous researches, such as those carried out by LSE Cities [14] about the impact of building form on residential heating's energy demand showed that building's height and wall-to-volume ratios were very strong parameters while surface coverage ratio was a mild parameter with insignificant impact on heating energy demand [14]. Different key spatial parameters were combined into the 'Space Matrix' diagram [12]. This diagram was developed at the Faculty of Architecture at Delft University of Technology; it allowed every building to have a unique spatial fingerprint with the intensity FSI, the compactness GSI, the height L and pressure on non-built space OSR. The four variables were calculated using the same series of data- gross floor area, built area and plan area- which made them mathematically related. Particular interest was paid at the relationship between these spatial features and temperature perturbations. New urban parameters encompassing characteristics about the envelope of buildings could also have a crucial importance. Parameters such as wall to volume ratios were, for instance, used. This work was inspired by previous studies on building geometry such as external wall surfaces to buildings' volume ratios and plan depth of buildings [15].

### 3.3. Outdoor temperatures around Tower buildings

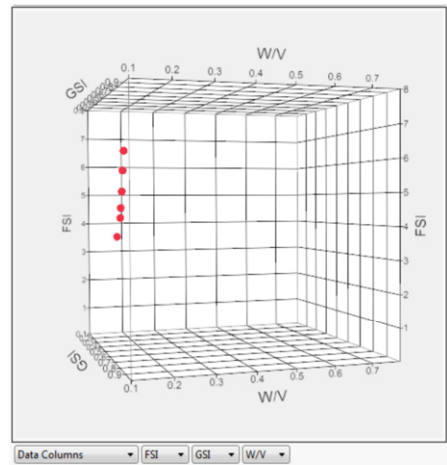
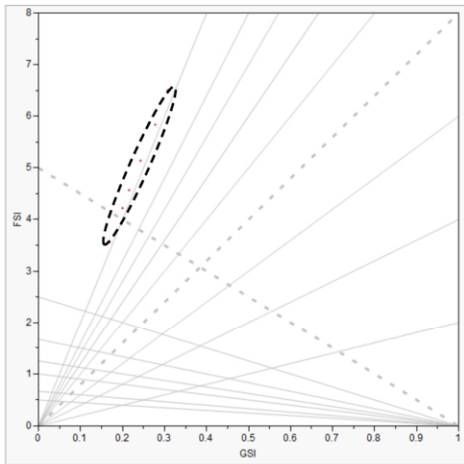
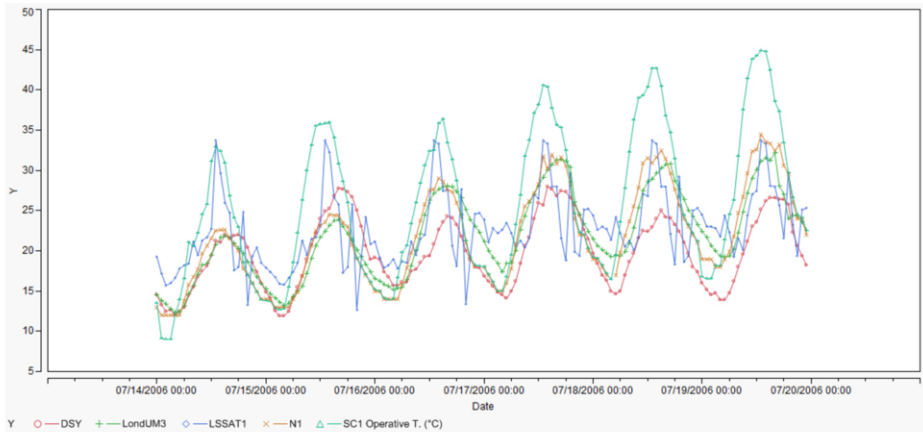

**Figure 5.** Modelled daily variations of outdoor temperature distributions near tower buildings on the top and urban spatial features are described by using Space Matrix (bottom).

The urban spatial features based on a multi-variable density concept ‘Space Matrix’ consisting of three indicators. The tower blocks have a relatively higher built intensity  $FSI = 3.5 - 6.5$ , lower coverage  $GSI = 0.15 - 0.3$  (the relationship between built and non-built space) and spaciousness  $OSR = 0.1 - 0.24$  (non-built space at the ground). The

statistical model CIBSE DSY estimated maximum temperatures at 26 degrees on 19<sup>th</sup> July 2006. This model was calculated based on measurements from weather station at Heathrow airport. This does not reflect the urban effects on temperature levels. The new DSY does however include the urban effects on temperatures based on measurements from the London Weather Centre in Holborn and St James's Park. The temperature model was calculated by the single layer urban canopy model Outdoor Room, which overestimated temperature levels over the period of 14<sup>th</sup>–19<sup>th</sup> July 2006. These results were therefore not taken into account for comparison purposes between different temperature models. This issue highlighted the fact that such a street canyon model is inappropriate for the calculation of temperature levels around tower blocks located in an open urban and/or negative space. The statistical model CIBSE DSY underestimated temperature levels on 19<sup>th</sup> July 2006 by approximately five degrees compared to the LondUM. During the same hot day, the calculated LSSAT and ADMS T & H temperature profiles estimated maximum temperatures by two degrees higher than the LondUM and by seven degrees higher than the CIBSE DSY model. The ADMS T & H model overestimated temperature levels during the whole day except in the first few hours of the day. The LSSAT model underestimated temperature levels during the rest of the day except for the pick temperature levels. All diurnal temperature profiles were smoothly calculated by the models, except the LSSAT model, which included more temperature fluctuations. This might be due to the inclusion of the effects of more detailed mechanical and thermal turbulence within street canyons and the urban canopy.

### *3.4. Outdoor temperatures around Terraced buildings*

The urban spatial features of the terraced buildings with multi-storey with small or no T have very diverse spatial characteristics. Most of the buildings, however, have lower built intensity FSI = 0.5 - 2, lower coverage GSI = 0.1 -0.45 and higher spaciousness OSR = 0.27 -1.8. The temperature model for street canyons Outdoor Room estimated the highest values of temperature levels around 35 degrees on 19<sup>th</sup> July 2006. The CIBSE DSY model underestimated temperature levels by approximately six degrees compared to the LondUM on the same day. The LSSAT model estimated maximum temperature levels same as the ADMS T & H model with lower temperature levels during the day and higher temperatures during the night compared to the LondUM. ADMS T & H estimated maximum temperatures two degrees higher than the LondUM, higher temperature levels during the day and lower temperatures during the first few hours of the day. All temperature models were smooth for daily variations except the LSSAT model, which caught more temperature fluctuations. However, during pick time all temperature models fluctuated. The CIBSE DSY, LondUM and Outdoor ROOM calculated maximum Temperatures at the same hour/time. LSSAT and ADMS T & H models calculated pick temperatures at the same time.

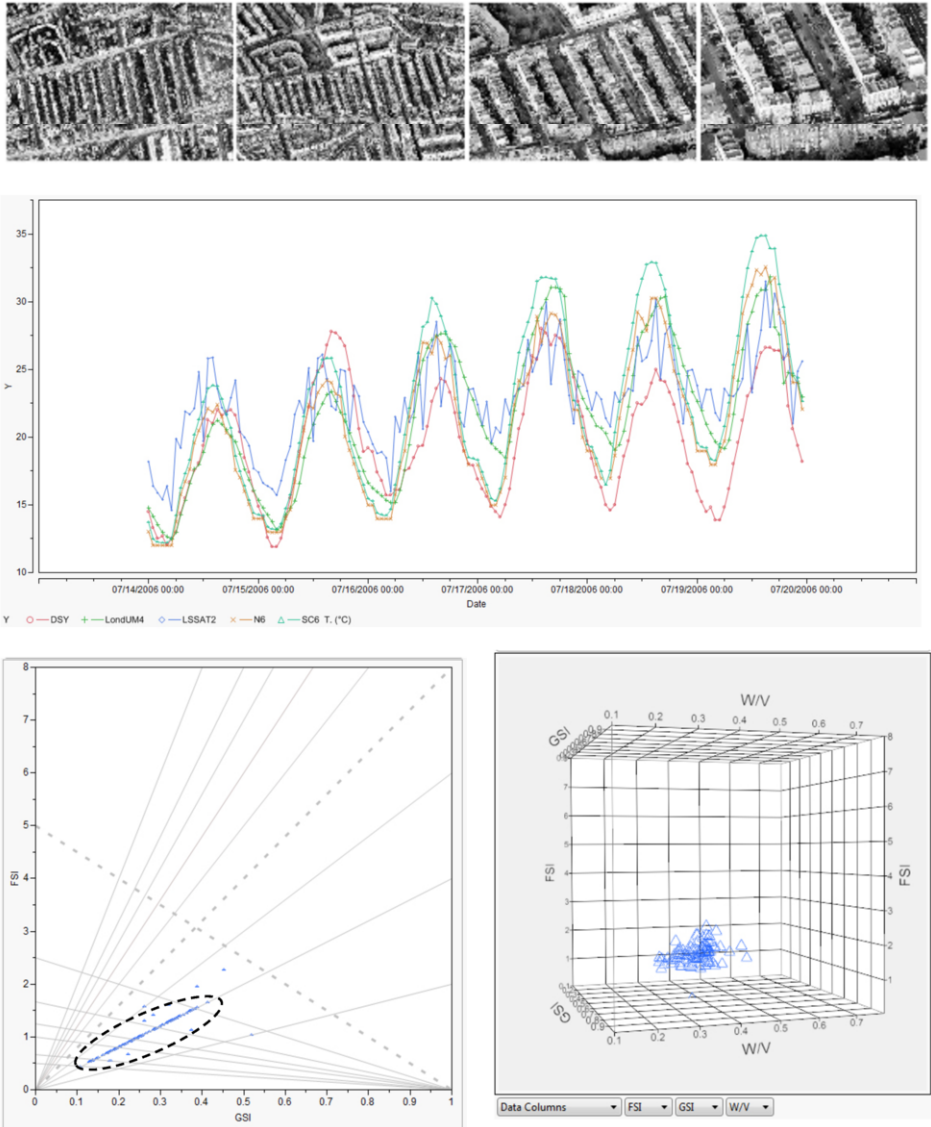

Figure 6. Modelled daily variations of outdoor temperature distributions near terraced buildings on the top and urban spatial features are described by using Space Matrix (bottom).

#### 4. Modelling discrepancies

Different temperature models were calculated. The LSSAT model overestimated temperature levels before sunrise and after sunset. This could be explained through the effects of emitted long wave radiation that were absorbed during daytime and triggered later. This artificial neural network based model was probably able to take into account the effects of long wave radiation on air temperatures. The street canyon model Outdoor Room overestimated temperature levels during daytime. An explanation to



that could come from the effects of buildings' fabric thermal mass and radiant temperatures inside the canyons. This physical model performed better in continuously built street canyons, such as in-between terraced houses. When Outdoor Room model was applied to a street in-between tower blocks, the model in general overestimated maximum temperatures. The neighbourhood scale model ADMS T & H estimated temperatures quite well in general except during the early hours of the day. This model estimated radiation through a simplified mathematical function that made the patterns of radiation unrealistic. Heat storage might therefore be underestimated during the early hours of the day. The LondUM model was relatively the most reliable model for the estimation of outdoor air temperatures. It was used in this research as a "benchmark". In the absence of measured weather data, the LondUM model could be used as initial meteorological boundary conditions for neighbourhood and street-scales' modelling. The old CIBSE DSY model underestimated temperature levels during the heat wave of 2006. This statistical model was based on measurements from Heathrow airport and this is why extra temperatures were somehow overlooked. CIBSE developed recently a new version of the DSY model, which is designed to take into account the urban effects on temperatures such urban heat islands. The new model was therefore developed based on meteorological measurements in central London. Simple atmospheric and energy balance modelling cannot depict the vertical flows accurately as most of the implemented canopy models are idealised. This is the consequence of a simplified surface forcing where vertical fluxes of momentum and heat coming from punctual buildings in realistic urban canopies are underestimated. Most of the calculated flows are simplified and become mainly horizontal and advective. Some of the wall surfaces of idealised canopies are fixed at the blending height above which the flow becomes horizontal and advective. Therefore, the inertial sublayer and the mixing layer are considered and in contrast the roughness sublayer that includes the urban canopy details is simplified. The distribution of the urban geometry and its aerodynamic and thermodynamic characteristics are homogeneous and averaged. In addition, some of these simple canopy models operate at coarse spatial resolutions. Some models simplified surface forcing because they operate over larger geographical zones such as the LondUM model. Regarding the other models operating at finer scales, they adopted roughly similar mathematical models, for instance, the Outdoor Room model is a single layer urban canopy model which has roughly the same surface forcing characteristics as MORUSES scheme implemented in the LondUM model. It represents therefore a stand alone version that requires much less computational resources. The difference is that such a model will have some difficulties in terms of local urban meteorological boundary conditions. The same thing applies to ADMS T & H for neighbourhood scale simulations where the radiation scheme was much simplified which does not fulfil realistic temperature conditions. This local scale model operates well in terms of land use's impact on temperature perturbations. The impact from buildings, is however, underestimated. Most of these stand-alone models represent a lighter version of meso-scale modelling such as the LondUM and they have problems with the upwind fluxes, initial meteorological boundary conditions and the roughness sublayer. In complex modelling, the surface mechanical and thermal forcing is faithfully modelled in order to describe more realistic physics [16]. In addition to the mixing layer and the inertial sublayer, the physics within the roughness sublayer are taken into account. The wall surface of these models is located at the ground surface ( $z=0$  metres ) and their spatial features are more realistic. Vertical flows from momentum and heat are therefore taken into account and simulated realistically. This,

for instance, includes shear and buoyancy driven flows. The urban canopy includes buildings and trees' geometries, their physical characteristics, land cover, water and green surfaces. These models can be operated either with lower or higher computational costs. Initial meteorological boundary conditions are better solved than simplified models. These complex models operate at higher spatial and time resolutions than simple models and this helps in catching more detailed information about averaged and instantaneous flow fields and different meteorological scalars.

## **Conclusion**

In this article, multi-scaled temperature models involving models with simplified and/or idealised urban canopy layers (LUCID) were investigated. This looked at some discrepancies within their output results. Some spatial features within Westminster's domestic building stock were parameterised using the Space Matrix diagram in order to correlate them with local outdoor temperature models. The discrepancies mostly emerge from the type of the radiation scheme implemented within the models' code. There might be a complementary approach regarding simple and complex modelling of temperatures and how these can inform issues related to health, energy and so on. The effects of the roughness sublayer on the atmosphere are very simplified. However, such effects are more detailed within complex models. These models calculate detailed physics within the roughness sub layer and the urban canopy at building levels and pedestrian levels. Their added value arises from their ability to bring more useful information in terms of diurnal, maximum, minimum and instantaneous calculations of different physical meteorological scalars such as temperatures while simple models are more useful for seasonal and averaged calculations.

## **Acknowledgement**

Thanks go to the UK Engineering and Physical Sciences Research Council Doctoral Training Grant and to the LUCID project research team members Prof. Mike Davies, Prof. Philip Steadman and Dr. Anna Mavrogianni from University College London, Dr. Jake Hacker from ARUP and Dr. Jenny Stocker from Cambridge Environmental Research Consultants Ltd.

## **References**

- [1] Kolokotroni, Maria et al., 2010. A validated methodology for the prediction of heating and cooling energy demand for buildings within the Urban Heat Island: Case-study of London. *Solar Energy*, 84(12), pp.2246-2255.
- [2] Bohnenstengel, S. I et al., 2011. Simulations of the London urban heat island. *Quarterly Journal of the Royal Meteorological Society*, 137(659), pp.1625-1640.
- [3] Porson, A., Clark, P.A., Harman, I. N, Best, M.J. & Belcher, S. E, 2010a. Implementation of a new urban energy budget scheme in the MetUM. Part I: Description and idealized simulations. *Quarterly Journal of the Royal Meteorological Society*, 136(651), pp.1514-1529.
- [4] Porson, A., Clark, P.A., Harman, I. N, Best, M.J. & Belcher, S. E, 2010b. Implementation of a new urban energy budget scheme into MetUM. Part II: Validation against observations and model intercomparison. *Quarterly Journal of the Royal Meteorological Society*, 136(651), pp.1530-1542.
- [5] Hamilton, I.G. et al., 2009. The significance of the anthropogenic heat emissions of London's buildings: A comparison against captured shortwave solar radiation. *Building and Environment*, 44(4), pp.807-817.
- [6] Harman, I. N & Belcher, S. E, 2006. The surface energy balance and boundary layer over urban street canyons. *Quarterly Journal of the Royal Meteorological Society*, 132(621), pp.2749-2768.
- [7] Mayor of London, 2010, *Cleaning the air The Mayor's Air Quality Strategy*.

- [8] KIKEGAWA et al., 2006. Impacts of city-block-scale countermeasures against urban heat-island phenomena upon a building's energy-consumption for air-conditioning. *Applied Energy*, 83(6), pp.649-668.
- [9] Kikegawa, Y., Y. Genchi, H. Yoshikado, and H. Kondo, 2003: Development of a numerical simulation system toward comprehensive assessments of urban warming countermeasures including their impacts upon the urban buildings' energy demands. *Appl. Energy*, 76, 449–466.
- [10] Salamanca, F., Krpo, A., Martilli, A., Clappier, A., 2010. A new building energy model coupled with an urban canopy parameterization for urban climate simulations - part I. Formulation, verification, and sensitivity analysis of the model. *Theor. Appl. Climatol.* 99 (3e4), 331e344.
- [11] International Association for Urban Climate, 2010. *Urban Climate NewsQuarterly Newsletter of the IAUC*.
- [12] Haupt, P. & Pont, M.B., 2004. *Spacemate: The Spatial Logic of Urban Density*, IOS Press/Delft University Press.
- [13] Haupt, Per & Berghauser Pont, M., 2005. *The Spacemate: Density and the Typomorphology of the Urban Fabric*. Available at: [http://miranda-pina.dpa-etsam.com/files/01.Spacemate\\_Berghauser\\_haupt.pdf](http://miranda-pina.dpa-etsam.com/files/01.Spacemate_Berghauser_haupt.pdf).
- [14] LSE Cities and EIFER, 2014, *Cities and energies, urban morphology and heat energy demand*, final report.
- [15] Steadman, P., Evans, Stephen & Batty, Michael, 2009. Wall area, volume and plan depth in the building stock. *Building Research and Information*, 37(5-6), pp.455-467.
- [16] Bakkali M., Inagaki A., Ashie Y., Yoshida Y., Kanda M., Raasch S., 2015. Thermal large eddy simulation with sensible heat flux distribution from various 3d building geometries, *Journal of Japan Society of Civil Engineers*, vol.71, issue 4, pp.I\_433-I\_438.

# Modelling Effects of Rooftop PVs on Outdoor Temperatures: The Case of Low Latitude Neighbourhoods

Asmaa ZAZ<sup>a,1</sup>, Mohammed BAKKALI<sup>b</sup>, Mohammed OUASSAID<sup>c</sup>,  
Yasunobu ASHIE<sup>d</sup>, Mounir GHOGHO<sup>e</sup>

<sup>a,c</sup> *Engineering for Smart and Sustainable Systems Research Centre, Mohammedia School of Engineers(EMI), Mohammed V University (UM5), Rabat, Morocco*

<sup>d</sup> *Building Research Institute, Tsukuba, Japan*

<sup>a,b,c</sup> *ICT Research Laboratory (TICLab), International University of Rabat (UIR), Rabat, Morocco*

**Abstract.** The impact of solar photovoltaic panels (PV) on urban climates has been investigated in a number of recent studies, which resulted in contradictory findings. In this paper, we address this issue by conducting a simulation-based comparative study of neighbourhoods in Casablanca with and without rooftop PV panels. Using an urban energy balance model, building surface temperatures were computed for each surface patch from ground, roofs and facades with a spatial resolution of 2 m x 2m for horizontal surfaces and 2m x 1m for vertical surfaces. A 3D heat map was obtained, allowing to visualize temperature differences within an area of 500m x 500m. Results show that the installation of solar PV leads to a cooling effect of buildings' roof surfaces during daytime, with a decrease of temperature reaching 5.1°C.

**Keywords.** PV roof, micro-climate, urban environment, surface temperature.

## 1. Introduction

Casablanca is Morocco's largest city, and economic capital and Casablanca-Settat region is the most populated area in Morocco, with 6,861,739 inhabitants or 20% of the Moroccan population [1] Over the years, its industrial activity has become denser and diverse, and different global giants have opened their major industrial and commercial units. In fact, this economic metropolis has set out a vision to itself to be one of the most important economical and business hubs in Africa, and particularly as the best investment destination, by dint of its attractive geographic location, top-notch logistics and transportation infrastructure. However, Casablanca-Settat region represents more than 1/3 of national GDP (Gross Domestic Product) [2]. This has a positive impact on the Moroccan economy and in contrast a negative impact on the environment.

<sup>1</sup> Corresponding Author at: Department of Electrical Engineering, Mohammed V University (UM5), Mohammedia School of Engineers (EMI), Rabat, Morocco, E-mail: asmaazaz2017@gmail.com

The ministry of environment has drawn up an action plan to clean up this region, based on several projects including but not limited to the use of clean energy and the implementation of energy efficiency in the residential and services building stock. Various roofing technologies have been promoted for generating electricity, reducing building energy consumption, and/or mitigating urban heat islands (UHI) [3]. Photovoltaics panels (PVs) are one of the most viable technologies for use in urban environments, replacing existing building cladding materials [4]. The increased adoption of such a technology can also be attributed to the decreasing cost of PV modules, and their increasing efficiency [5]. In addition to generating clean energy, Building Integrated Photovoltaics (BIPV) can have an impact on the surrounding urban environment. Replacing conventional buildings' envelope components such as roof tiles, asphalt shingles, facade elements, and shading devices with photovoltaic modules [6], can alter radiative patterns between surfaces and the atmosphere, so they can exert certain impacts on temperature and air flow fields [7]. Some studies suggest that PVs induce day and night time cooling effects. For example, a Weather Research and Forecasting (WRF) simulation conducted in Osaka City in Japan [8], showed that during daytime, cooling effect on roof surfaces is estimated to 2.1°C. During night time, cooling effect on roofs is approximated to 1.4°C. Other simulations done in Australia [9], have shared similar conclusions, finding that the installation of PV systems over Sydney, reduces summer maximum temperatures by up to 1 °C. Other studies prove the opposite by claiming that photovoltaic panels increase temperatures within their surroundings. Well, some experiments [10] deduced the effects of a large-scale implementation of PVs in Tucson, Arizona in three different biomes: natural semiarid desert ecosystem, solar photovoltaic installation, and an “urban” parking lot as a typical source of urban heat island (UHI) . Each location extends for a 1 km<sup>2</sup> area. Temperatures over a PV plant were regularly 3–4 °C warmer than wild lands at night, equivalent to twice of that generated by the UHI. Based on the above, the aim of the present paper is to investigate and analyse, through numerical modelling, the thermal impact of rooftop PVs on local temperatures. For comparison-wise, we conducted the same analysis for each case study in one hand with PVs and on the other hand without PVs.

## 2. Urban energy balance model

### 2.1 Outdoor 3D Irradiation

The governing equations are set as follow:

- Absorbed solar and short wave length radiation from the sun, the atmosphere and the surroundings urban surfaces at every surface patch:

$$S_i = A_i \alpha_i I_i \quad \text{Where } I_i = \beta_i I_{direct} \cos \theta_i + F_{Si} I_{diffuse} \quad (1)$$

$$R_{Si} = A_i \alpha_i \sum_{j=1}^m G_{Sj} F_{ji} \quad \text{Where } G_{Sj} = (1 - \alpha_j) \sum_{i=1}^n G_{Si} F_{ij} \quad (2)$$

- Net long wave length radiation at different urban surfaces:

$$L_i = A_i F_{Si} \varepsilon_i \sigma T_a^4 (a + b\sqrt{e}) \quad (3)$$

$$R_{Li} = A_i \varepsilon_i \left( \sum_{j=1}^m G_{Lj} F_{ji} - \sigma T_i^4 \right) \quad \text{Where } G_{Lj} = \varepsilon_j \sigma T_j^4 + (1 - \varepsilon_j) \sum_{i=1}^n G_{Li} F_{ij} \quad (4)$$

## 2.2 Outdoor Energy Budget

Ambient air temperature and wind velocity are uniformly distributed and forced from site measurements or through general circulation and/or regional numerical modelling. Weather conditions are more relevant to the model when wind velocities are lower. Surface temperature at each solid surface patch designated as  $i$  is calculated through its energy budget [11] (eq. 5). Latent heat can be considered, for instance, if the solid surface patch  $i$  contains water (eq. 9) and sensible heat is estimated (eq.8). Conductive transient heat through construction layers in building roofs, walls and ground is calculated by means of the unsteady state one-dimensional thermal conduction equation applied at the normal direction across each solid surface patch  $i$  and its constituent construction layers (eq. 6 - 7). The effect of building thermal bridges is not considered here.  $G_i$  is used for outdoor boundary conditions of solid surface patch  $i$ . The Finite Difference Method (FDM) is used to fully discrete transient heat conduction in each solid surface patch  $i$  and time step  $t$ . The implicit Euler Method is used for time discretisation. The Newton Method is used to solve the latter equation especially for long wave radiation. Indoor building surface temperature such as walls, ceilings and floors were then determined accordingly.

- Outdoor energy balance equation at each solid surface patch  $i$ :

$$S_i + R_{S_i} + L_i + R_{L_i} + G_i + H_i + E_i = 0 \quad (5)$$

$$G_i = A_i k_i \left. \frac{\partial T_i}{\partial x} \right|_{x=0} \quad (6)$$

- Unsteady state one-dimensional thermal conduction equation:

$$\rho_i c_i \frac{\partial T_i}{\partial t} = \frac{\partial}{\partial x} \left( k_i \frac{\partial T_i}{\partial x} \right) \quad (7)$$

- Sensible heat flux at solid surface patch  $i$ :

$$H_i = A_i h (T_{adjacent} - T_i) \quad (8)$$

- Latent heat flux at solid surface patch  $i$ :

$$E_i = A_i L \beta h_q (q_a - q_i) \quad (9)$$

## 3. Low latitude neighbourhoods

Casablanca city is composed of 16 boroughs. Applying multi-objective analysis method, we simulated two different building typologies (see, figure 1). An industrial area: Ain Sebâa borough and a residential area: Hay Hassani borough. The geometric characteristics of urban forms, such as buildings' Plan Depth, Open Space Ratio, Site Coverage Ratio and Frontal Area index have significant impacts on a environmental performances, such as daylight availability, Sky View Factors, receivable solar radiation and outdoor air flow [12]. We selected two different zones of 500 x 500 m<sup>2</sup> from each borough (see, figure 2). Then, a geo-referenced height grid describing the elevation of the two sites were built, from a digital surface model (DSM). The resolution of the grid was 2 x 2 m<sup>2</sup> for horizontal surface patches and 2 x 1 m<sup>2</sup> for vertical surface patches.

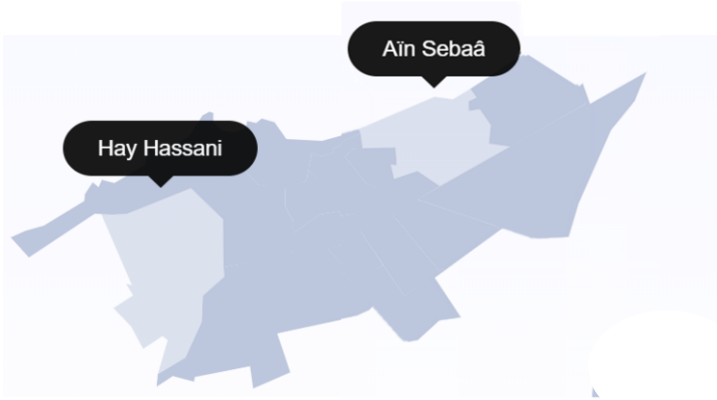

Figure 1. Boroughs of Casablanca city.

### 3.1 Input files

The model uses a building height matrix as input, as well as thermo physical properties of building materials, such as albedo, thermal diffusivity, refractive index, density, specific heat capacity, evaporation efficiency and emissivity. Further inputs require appropriate weather data for every hour of the day, describing temperature, humidity, air pressure, wind direction and speed and solar irradiation. Cloud cover is not included. Regarding construction materials, we consulted the Moroccan DTU (Unified Technical Document), which is a specifications document that defines the standards for buildings' construction works, benchmarks of execution and implementation within local rules. Thus, walls must be built in double partition, and the roofs must have a good waterproofing as shown in figure 2.

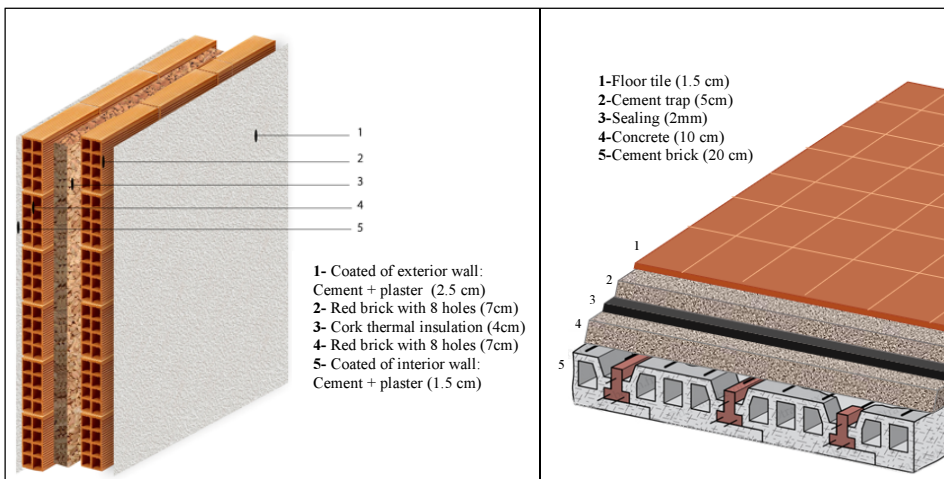
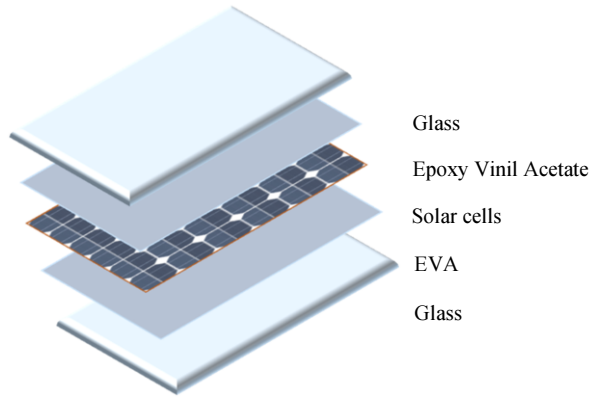

Figure 2- Double wall partition (left) and Construction materials of a rooftop (right).



**Figure 3.** Materials of photovoltaic panels.

The PV panel is made of five layers [13], as schematically described in figure 3 and table 1. From the lower side towards the upper side exposed to the sun, we usually have a glass (0.1 mm thick), a layer of an encapsulant material (typically Epoxy-Vinyl-Acetate, EVA, 0.5 mm thick), solar cells (0.35 mm thick) separated in their plane by few millimetres of encapsulant, another layer of EVA like the previous one, and finally a glass cover(3.20 mm thick).

**Table 1.** Thermo physical properties of each PV cell layer [14]

Material	Conductivity (W/m K)	Density (kg/m <sup>3</sup> )	Specific heat (J/kg K)
Glass <sup>pvi</sup>	0.78	3000	500
EVA	0.12	1200	1250
Silicon	168	2330	677
EVA	0.12	1200	1250
Glass <sup>pvo</sup>	0.78	3000	500

<sup>pvi</sup> Means PV innermost layer.

<sup>pvo</sup> Means PV outermost layer.

### 3.2 Simulation day

Based on values of Global Horizontal Irradiance (GHI) from an annual meteorological database extending from June 2018 to June 2019, we chose May 31<sup>st</sup>, 2019 for numerical modelling as the value of recorded solar irradiation was as high as 1139 Wh/m<sup>2</sup> at 13:00.

### 3.3 Numerical modelling

We gathered the data required to calculate the urban energy balance between conductive, convective and radiative fluxes. The model calculated surface temperatures every hour in every surface patch in the roofs, ground and facades. To be able to quantify the thermal impacts of PVs, we conducted simulations for two different scenarios: rooftops with PVs and the rooftops without PVs.



#### 4. Results and Analysis

The main focus was made on the thermal effects of solar panels on urban environments. Therefore, we plotted calculated surface temperatures in both scenarios with and without the implementation of PVs, allowing us to analyse such effects. The second focus was made on whether building typologies and the implantation of PVs could imply some building indoor thermal loads involving whether gains or losses. So we identified two generic typologies in both residential and industrial urban settings (See, figure 4). Such settings differ in terms of their spatial features mainly regarding building geometry, density and function. Although the impact of land use classifications on temperature distributions is considerable it was not included in these simulations. For instance, we specified window to wall ratio for each case. Which led us to estimate that windows cover an area of 15% of the total facade area of industrial buildings and 30% of residential one. We then simulated the two building types assuming they are made from the same construction materials and under the same climatic conditions.



**Figure 4.** 500 m<sup>2</sup> study area. At right: Residential zone. At left: Industrial zone.

##### 4.1 PV effects on residential buildings (Hay Hassani)

Over all selected time windows (see, figure 5), wall and ground temperatures don't change experience a significant shift from a scenario to another, while roof temperatures after the implementation of PVs are lower than those of standard roof scenario (without PV). The implementation of PVs reduces roof surface temperatures by approximately 0.9°C at 10h00 and by 1.8°C at 13h00. This cooling effect reaches its maximum value of 5,1 °C at 15h00. At 18h00, the cooling is less important, but still significant and attain 3,4°C.

##### 4.2 PV effects on industrial buildings (Ain Sebaa)

Similarly, to the case of residential buildings, the figure 6 shows that standard roofs remained warmer than those covered by PVs throughout the day.

10 h00

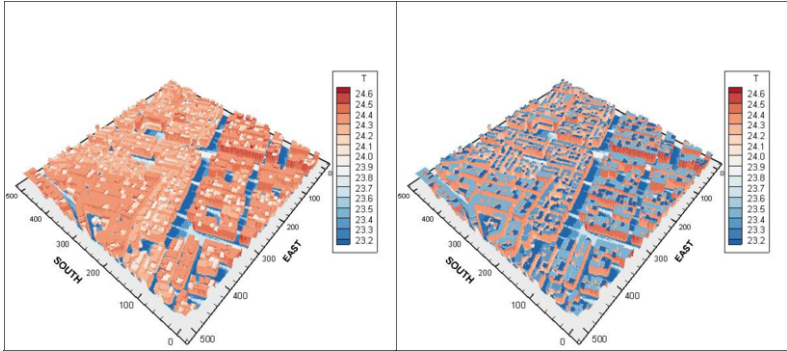

13 h00

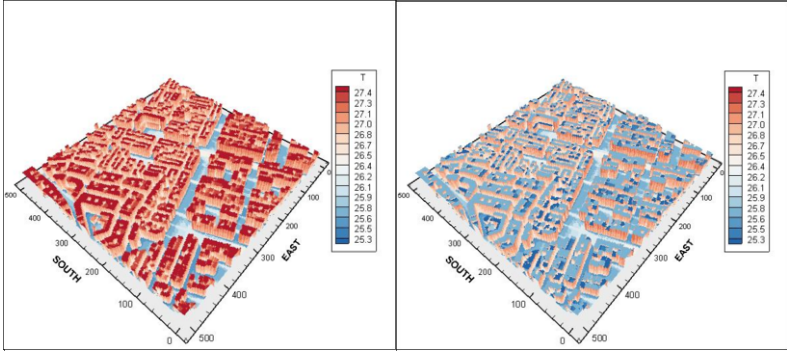

15 h00

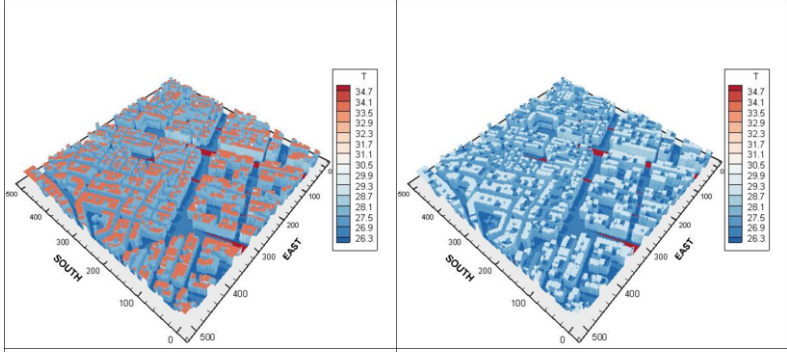

18 h00

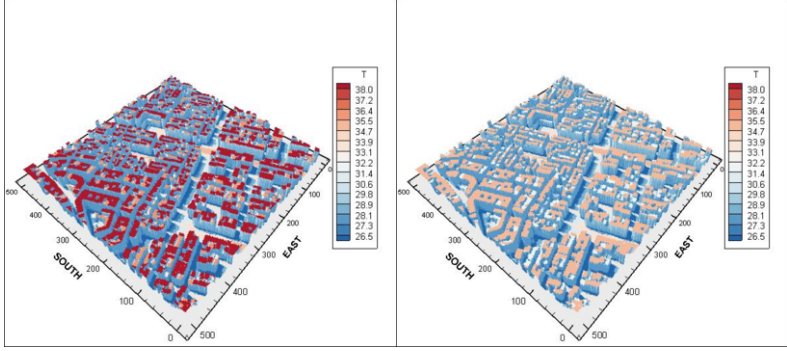

**Figure 5.** Impact on hourly surface temperatures (°C) after the installation of PVs in a residential neighbourhood: Hay Hassani. **Left column:** buildings without PVs. **Right column:** buildings with PVs.

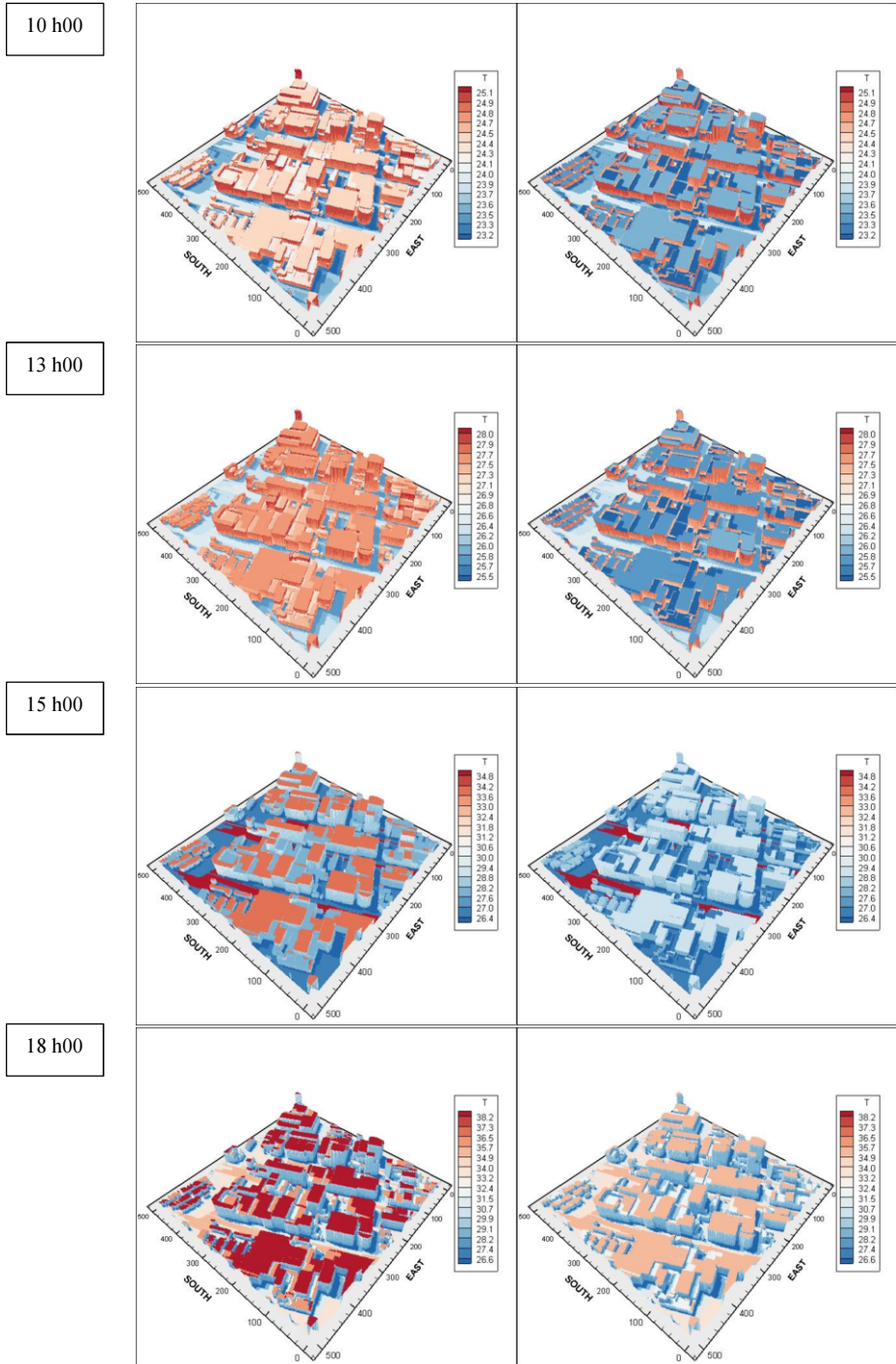

**Figure 6.** Impact on hourly surface temperatures (°C) after the installation of PVs in an industrial neighbourhood: Ain Sebaa. **Left column:** buildings without PVs. **Right column:** buildings with PVs.

The difference in roof surface temperatures between the two scenarios (with and without PV) was calculated at various times. For example, at 10h00, cooling effect was around 0.9°C, and 1.9°C at 13h00. At 15h00, the impact of the photovoltaic panels was quite strong, even larger than during daytime, with a cooling reaching 5°C. At 18h00, this cooling effect is reduced to 3.6°C. Wall and ground temperatures are consistently identical in the two scenarios for every hour.

## 5. Conclusion

This paper presents an investigation on the thermal impact of PVs on urban environments. As a preliminary analysis, we have calculated surface temperatures of buildings with and without the incorporation of PVs. This method was applied to two neighbourhoods of an area of 500 m<sup>2</sup> each in Casablanca city. Results show that PVs induce a cooling effect on buildings' roofs, during the daytime, starting from 0.9°C to 5°C. Contrariwise, wall and ground temperatures are consistently identical in the two scenarios. Moreover, we conducted the same simulations in the two different places (residential and industrial one), with the aim of evaluating whether buildings' density, shape and function could affect their indoor thermal loads, especially cooling loads. As a result, roof surface temperatures were similar as for as the cooling effect, for every hour.

## 6. Future studies

The deployment of PVs is good for both producing clean energy and for decreasing temperatures. However, we still have to evaluate PVs effects along hot and cold seasons, particularly in winter, when the cooling could probably be negative and may increase the need for domestic heating, and therefore more energy consumption.

## References

- [1] The last General Census of Population and Housing of 2014 carried out by the High Commission for Planning
- [2] <http://wecasablanca.com/en/invest>
- [3], [5] Adam Scherba, David J. Sailor\*, Todd N. Rosenstiel, Carl C. Wamser. Modeling impacts of roof reflectivity, integrated photovoltaic panels and green roof systems on sensible heat flux into the urban environment. *Building and Environment* 46 (2011) 2542e2551.
- [4] Theocharis Tsoutsos, Niki Frantzeskaki, Vassilis Gekas. Environmental impacts from the solar energy technologies. *Energy Policy* 33 (2005) 289–296
- [5] Yiping Wang, Wei Tian, Jianbo Ren, Li Zhu, Qingzhao Wang. Influence of a building's integrated-photovoltaics on heating and cooling loads. *Applied Energy* 83 (2006) 989–1003
- [6] Haider Taha. The potential for air-temperature impact from large-scale deployment of solar photovoltaic arrays in urban areas. *Solar Energy* 91 (2013) 358–367
- [7], [15] Aiza Cortes, Yuji Murashita, Tomohito Matsuo, Akira Kondo, Hikari Shimadera, Yoshio Inoue. Numerical evaluation of the effect of photovoltaic cell installation on urban thermal environment. *Sustainable Cities and Society* xxx (2015) xxx–xxx
- [8] S. Ma, M. Goldstein, A. J. Pitman, N. Haghdadadi & I. MacGill. Pricing the urban cooling benefits of solar panel deployment in Sydney, Australia. 2017
- [9] Greg A. Barron-Gafford, Rebecca L. Minor, Nathan A. Allen, Alex D. Cronin, Adria E. Brooks & Mitchell A. Pavao-Zuckerman. The Photovoltaic Heat Island Effect: Larger solar power plants increase local temperatures. 2016
- [10] Adam Scherba, David J. Sailor\*, Todd N. Rosenstiel, Carl C. Wamser. Modeling impacts of roof reflectivity, integrated photovoltaic panels and green roof systems on sensible heat flux into the urban environment. *Building and Environment* 46 (2011) 2542e2551.

- [11] Mohammed Bakkali and Yasunobu Ashie, Developing a Three-dimensional thermal load and urban surface temperature model to assess the impact of Tokyo UHI countermeasures on energy use, Architectural Institute of Japan (AIJ), (2013) 871-872.
- [12] Haider Taha. The potential for air-temperature impact from large-scale deployment of solar photovoltaic arrays in urban areas. Solar Energy 91 (2013) 358–367
- [13] Adam Scherba, David J. Sailor\*, Todd N. Rosenstiel, Carl C. Wamser. Modeling impacts of roof reflectivity, integrated photovoltaic panels and green roof systems on sensible heat flux into the urban environment. Building and Environment 46 (2011) 2542e2551.
- [14] Sourav Khannaa, K.S. Reddyb, Tapas K. Mallick. Optimization of finned solar photovoltaic phase change. International Journal of Thermal Sciences 130 (2018) 313–322.

## Nomenclature

$a, b$ [-] Constants from Brunt's formula	$I_{direct}$ [W/m <sup>2</sup> ] Incident direct solar radiation
$\alpha_i$ [-] Absorption coefficient at solid surface patch i	$I_i$ [W/m <sup>2</sup> ] Total direct and diffuse solar radiation at solid surface patch i
$A_i$ [m <sup>2</sup> ] Area of solid surface patch i	$k_i$ [W/m.K] Thermal conductivity
$\beta$ [-] Evaporation efficiency	$L$ [J / kg] Latent heat from evaporation
$\beta_i$ [-] Solar view factor at solid surface patch i	$L_i$ [W/m <sup>2</sup> ] Absorbed long wave length radiation from the atmosphere at solid surface patch i
$C_a$ [J / kg.K] Specific heat capacity of air	$\rho_a$ [kg/m <sup>3</sup> ] Density of air
$C_i$ [J/kg.K] Specific heat capacity of solid surface patch i	$\rho_i$ [kg / m <sup>3</sup> ] Density of solid surface patch i
$COP$ [-] Coefficient of performance of AC systems	$q_a$ [kg/kg] Specific humidity of ambient air
$e$ [mmHg] Water vapour pressure	$q_i$ [kg / kg] Specific humidity of solid surface patch i (Mostly ground surface)
$\epsilon_i$ [-] Emissivity of solid surface patch i	$R_{Li}$ [W/m <sup>2</sup> ] Absorbed long-wave radiation from urban surroundings and total emitted long wave length radiations from solid surface patch i
$E_i$ [W/m <sup>2</sup> ] Latent heat flux at solid surface patch i	$R_{Si}$ [W/m <sup>2</sup> ] Absorbed short wave radiation from urban surroundings
$F_{ji}$ [-] View factor at solid surface patch i	$S_i$ [W/m <sup>2</sup> ] Absorbed incident solar radiation from the sun and the sky at solid surface patch i
$F_{Si}$ [-] Sky view factor at solid surface patch i	$T_{adjacent}$ [K] Temperature of adjacent outdoor air
$G_i$ [W/m <sup>2</sup> ] Conductive heat flux at solid surface patch i	$T_a$ [K] Temperature of ambient air
$G_{Lj}$ [-] Long wave length radiosity of solid surface patch j	$T_i$ [K] Surface temperature at solid surface patch i
$G_{Sj}$ [-] Total short wave radiosity from solid surface patch j	$W_{heat}$ [W/m <sup>2</sup> ] Total waste heat from AC systems per building then averaged per m <sup>2</sup>
$h$ [W/m <sup>2</sup> . K] Convective heat transfer coefficient	$\theta_i$ [rad] Angle formed by incident direct solar radiation and normal vector of solid surface patch i
$h_i$ [W/m <sup>2</sup> . K] Convective heat transfer coefficient of solid surface patch i	$\sigma$ [W/m <sup>2</sup> .K <sup>4</sup> ] Stefan-Boltzmann Constant
$h_q$ [kg/m <sup>2</sup> .s (kg/kg)] Mass transfer coefficient	
$H_i$ [W/m <sup>2</sup> ] Sensible heat flux at solid surface patch i	
$I_{diffuse}$ [W/m <sup>2</sup> ] Incident diffuse solar radiation	

# Intelligent Thermal Storage in the Balearic Islands Hotels with Solar Energy

Andreu Moià-Pol<sup>a,1</sup>, Pere RULLAN<sup>a</sup> and Bartomeu ALORDA<sup>b</sup>

<sup>a</sup>*Department of Physics – Energy Engineering Research Group (GREEN)*

<sup>b</sup>*Department of Physics – Electronic Systems Group (GSE)*

**Abstract.** The Balearic Islands are a representative example of tourist islands, with more than 2.500 Hotel and touristic industries, which implies with its approximately a half million available beds, an increase in 50% of the population during high season. High energy consumption in hours with low Renewable energy production represent additional problems. Hotels consume the 15% of the total energy in the Balearic Islands. Data from 27 Hotels was studied in order to investigate the levels of energy consumption and sustainability taking into consideration future zero emissions scenarios with solar energy production. This paper analyses available data concerning energy consumption in hotels, with a focus on Electric demand (most of them from HVAC systems). The main goal is to determine a mathematical model for predicting the energy consumption, and coupling it as much as possible to the solar energy production. To reach this goal, smart buildings can foster energy efficiency and tackle the reduction of CO<sub>2</sub> emissions within the atmosphere. Hotels can guarantee adequate lighting, ventilation, cooling rates, along with other aspects of building demands in real-time. Monitoring and sensing combined solutions with simple and efficient control strategies are the main contributors to advanced sustainable building technology. The implementation of smart strategies such as thermal storage.

**Keywords.** Energy Audits, Hotel, Energy Efficiency (EE), Solar Energy, Smart Energy

## 1. Introduction

Buildings are responsible of the 24% global emissions and their CO<sub>2</sub> emissions reductions are a key element in fighting climate change. Within the Balearic Islands, Buildings represent more than 70% of the electric demand, and more than 30% of the total primary energy. Government has approved a plan to decarbonize the islands in 2050 with a 100% renewable energy sources (RES) on the electrical grid.

Nowadays, energy efficiency in buildings is a prime objective for energy policy at regional, national and international level. Especially in Europe, where many new policies have been applied. Energy consumption in hotels is amongst the highest in the non-

---

<sup>1</sup> Department of Physics – Mechanical Engineering Area. University of Balearic Islands, Ctra. Valldemossa km. 7, 5, 07122 Balearic Islands (Spain), e-mail: andreu.moià@uib.es.

residential building sector in absolute values (an average of 150 kWh/m<sup>2</sup>) [9]. This difference lies on the efficiency processes and the unitary consumption of the users (especially in thermal necessities when considering the diverse external temperatures and the divergent comfort temperature between native dwellers and visiting tourists).

Considering the fact that a building's operational costs will grow with time and that problems only get worse unless some actions are taken, there is a clear need for proper building maintenance, refurbishment or retrofitting (upgrading). Such actions should focus on the building's structural elements and installations, which can also improve energy performance and indoor air quality.

The hotel sector is uniquely placed to provide the impetus for change in business behavior within tourism, because of its multiplier effect on guests, staff and suppliers, as well as the central role that hotels play within local communities. Additionally, possible energy conservation techniques for EE and exploitation of RES have a unique demonstration potential and a high exposure to millions of people that visit hotels at one time [8].

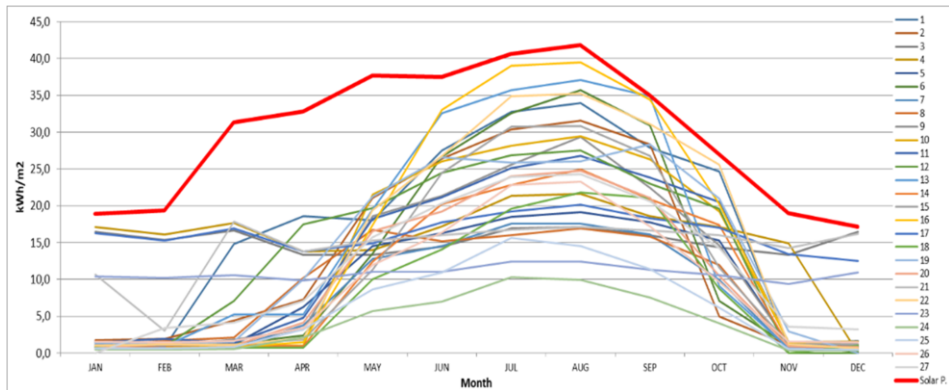

**Figure 1.** Monthly Energy consumption of different Hotels in Balearic Islands kWh.

Hotels are usually located in areas with high seasonal energy loads, frequently with high energy cost and low supply (i.e. islands). Most of the Mediterranean Hotels have a consumption profile correlated to the solar radiation at summer, especially in August, they have the maximum occupation, when the solar radiation and the temperature reach its maximum values and there are less cloudy days. The energy consumption in the HVAC arrives to most of the hotels to the 50% from the total energy [9]. The solar energy is the easiest to install in the Mediterranean Buildings. The potential form thermal collectors can reach 500-1000 kWh/m<sup>2</sup> year of collector area and for PV 200-400 kWh/m<sup>2</sup> year. Actually less than 10% of the Hotels in Balearic Islands have ST systems, and the implementation of PV in the Spanish Hotels is very low due to until October 2019 there was taxes that make difficult to install, but the last year has start to increase, but is too low to arrive to the Government objectives. 27 Hotels have been analyzed in detail, 70% of them are 4 stars, and the 15% are 3 the other 15% are 5 stars, with the energy consumption by month some results are presented in this paper in order to help

to the Government to apply policies and see the solar potential for these sector. As it can be seen on figure 1, the unitary energy consumption from 27 hotels compared with the solar potential, it seems feasible to arrive to Zero energy buildings with solar energy. Nevertheless, during the month there are several days with low solar radiation, which makes it mandatory large energy storage.

## 2. Objectives

The objectives of the present article are to estimate mathematical models for the energy consumption in Hotels and afterwards integrate solar energy to reach a real zero CO<sub>2</sub> emissions. The information derived from the energy consumption curves of a given geographical location and the instantaneous consumption of the largest energy consumption sectors of the same area can provide us with a first approach to understand the problems and the possible technical solutions. An in depth analysis of a significant number of energy audits of different industries and buildings can provide us with the necessary information needed for an extrapolation of the energy demand. Furthermore, this will shed light for new ways for energy saving and integration of RES.

For tourist areas, the biggest energy consumer is the tertiary building sector, and especially hotels. However, they usually have a centralized energy production which makes this analysis easier. Energy audits can help hotel companies find out energy management problems and improve energy efficiency, as well as indicating to the government the adequate energy policies to apply.

## 3. Case study. Balearic Islands

The tourist industry is amongst the most dynamic areas within the services sector, and this is especially the case in Southern Europe (France, Greece, Italy, Spain and Portugal) [9]. The Balearic Islands have historically been one of the primary tourist destinations; there are about half a million beds available, and it is the first destination for Spain. Many successful hotel companies that have emerged during the last few years are now exporting their experience to other expanding destinations.

However, one problem of the Balearic Islands energy model is that it is based on imported fossil fuels [2], only the 3% of the energy is from RES.

### 3.1. Hotels

The last years have been performed more than 250 energy audits for hotels. These audits represent 10% of all hotel buildings, and their usage sums up to more than 12 million of nights spend. From these audits, we discern that the energy more used in the Islands' hotels is the electric, owing to 54% of the total energy consumption, while gas and diesel are not used in all the hotels. The factors for predict the energy consumption are de Cooling Degree Days, Heating Degree Days and number of Night Spend.



**Table 1** Category of the Balearic Hotels and electric consumption 2017. Source; DG. Tourist. CAIB.

Category of Hotels	Number	beds	Unitary electric consumption (KWh/bed year)	Total Electric consumption (MWh/any)	Emissions (Ton of CO <sub>2</sub> )
4* - 5*	368	114.385	2.220	133.353	213305
3*	288	83.242	1.398	61.300	97753
2*	105	15.016	949	7.539	11970
Apartments	933	93.499	650	60.774	51050
Other touristic.	848	146.830	350	51.391	43168
<b>TOTAL</b>	<b>2.542</b>	<b>452.972</b>	<b>1.328</b>	<b>314.356</b>	<b>417.247</b>

With the increase in standard of living, services that were considered as luxurious now are included in the basic services, as the hotels have improved the buildings and they have increase the facilities, like SPA and acclimatized pools. It is hard to convince hotel owners that even if solar energy or heat recovery systems were used only for heating water that this amount to a saving of more than the 18% of the total energy consumption, as well as a saving in this energy cost, amounts, and a reduction in CO<sub>2</sub> of about one kilogram per night spent. Usually the hotels have three thermal systems, one for DHW and heating another for cooling and other for freezing area. For increase the energy efficiency of the system the Hotels have to change the facilities design and unify the three systems in one, with the maximum heat recovery.

The most important factors that until now with the most influence on the unitary consumption are: the HVAC service and the occupancy.

New generation Heat Pumps with new refrigerants can substitute completely the boiler; they condensation system can work at more than 60°C and the evaporation system can arrive to -10°C with high efficiency. For increase the energy efficiency and the Renewable Energy of the system the Hotels have to change the facilities design and unify the three systems in one, with the maximum heat recovery with solar collectors (ST and PV), and for have a large self-consumption the electricity from the PV systems has to be stored most of it thermal tanks (heating and cooling) and a few amount in batteries.

The usual ice storage system with compression machine are working during night time when electricity prices and the ambient temperature are low [11]. This energy may come from wind energy that is not used during night hours. The stored cooling energy is then used to cover peak cooling demands in the afternoon of the next day. Recent studies indicate that solar electric compression refrigeration and solar absorption refrigeration are the solar cooling options with the highest energy saving potential [12]. Both technologies can complement each other very effectively. During peak hours of cooling demand and solar radiation, the solar production is at its highest point, and solar absorption provide its maximum power. On the other hand, ice generation during night is the most feasible way of storing excess night energy to help tackle cooling demands during days of low radiation but excessive ambient temperature.

In our case the system will be working during the day time when the solar energy radiation is higher and store the heat and cool energy. In the hotels will be necessary to use Ice Storage Systems, in this way we can unify Air Conditioning(AC) systems with refrigeration and decrease the storage volume. On the other hand, the close coincidence of the maximum solar radiation with both the cooling loads and the peak electricity demand indicates that solar assisted refrigeration may be an interesting option to handle successfully the issue of reducing peak electricity demand due to air-conditioning.

Glycols systems can be used as well, but with an increasing of the volume storage, without Ice the storage has to be 5 times higher. The option of simple electricity compensation of conventional cooling installations by electricity from grid connected PV panels has its advantages and disadvantages when compared to solar thermal absorption cooling. In order to increase the self-consumption and a high thermal storage reducing the electric storage more expensive than the thermal, has been simulated an Optimal system integrating all the thermal systems in one system with heat and cold storage. Heat recovery from the HP with ST will reduce to zero the DHW from fossil fuel consumption. The PV combined with cooling storage will reduce to zero the cooling and freezing consumption. The heating consumption could be reduced to zero with HP with ST and PV. The other electric consumption will have to implement smart strategies, but a few percentages will have to be stored in batteries or in other technologies like Fuel Cell with Hydrogen and Hydrolysis, in order to arrive to highest self-consumption system, avoiding as much as they can the injection of electricity to the grid, and zero fossil fuel consumption.

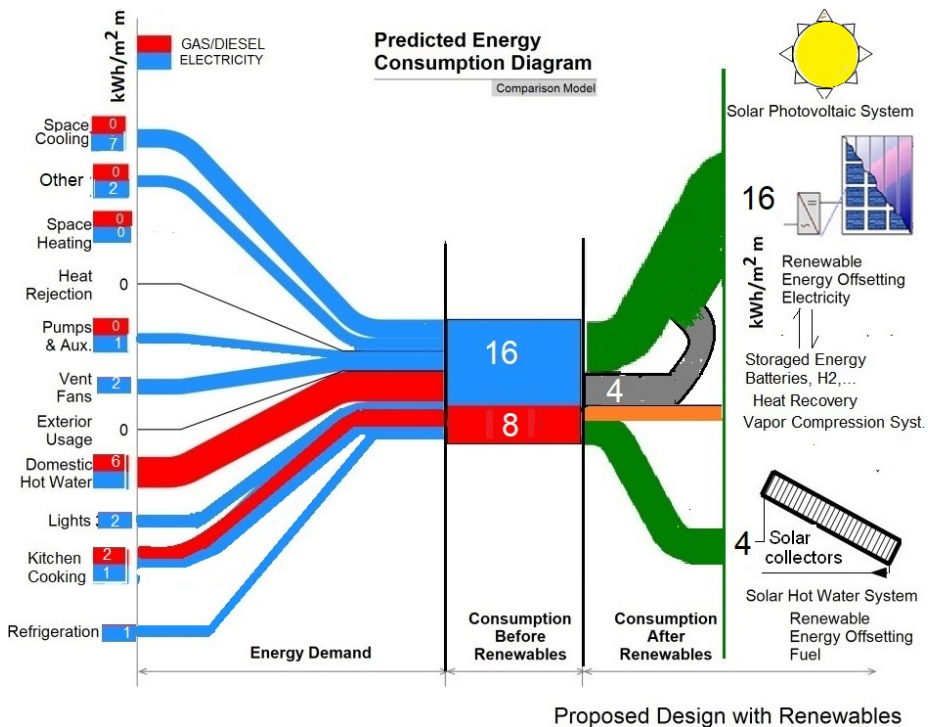

Figure 2. Energy Sankey diagram in a Hotel at Balearic Islands in kWh/m<sup>2</sup> in August.

See at the figure 2 the Sankey diagram with the new model in August, the highest energy consumption month in the Balearic Islands Hotels and in most of the Mediterranean hotels, when the temperatures and solar radiation are higher. The annual average energy consumption is about 150 kWh/m<sup>2</sup>, and in August the average is about 24 kWh/m<sup>2</sup> and can arrive to 40 kWh/m<sup>2</sup>, see at the figure 2 the new smart energy production in the hotels. The hotels will need between a 10 to 20% of the total surface with solar collectors in order to arrive to zero emissions.

**Table 2** New scenario of the Balearic Hotels with Zero Emissions at 2050.

Category of Hotels	Number	beds	Consumption (MWh/year)	PV MWp	ST m <sup>2</sup>
4* - 5*	368	114.385	133.353	212	343.155
3*	288	83.242	61.300	97	208.105
2*	105	15.016	7.539	12	30.032
Apartments	933	93.499	60.774	51	93.499
Other touristic.	848	146.830	51.391	43	73.415
<b>TOTAL</b>	<b>2.542</b>	<b>452.972</b>	<b>314.356</b>	<b>355</b>	<b>748.206</b>

With the real energy consumption from 2016, with the new scenario, the new consumption could be proportionally to the solar radiation, using Thermal Storage and some chemical storage (Batteries, Hydrogen,..). The highest use of electricity is destined principally for air conditioning which makes the energy consumption per night spend vary during the year, this consumption could be easy stored in buffer tanks and used to make an intelligent control.

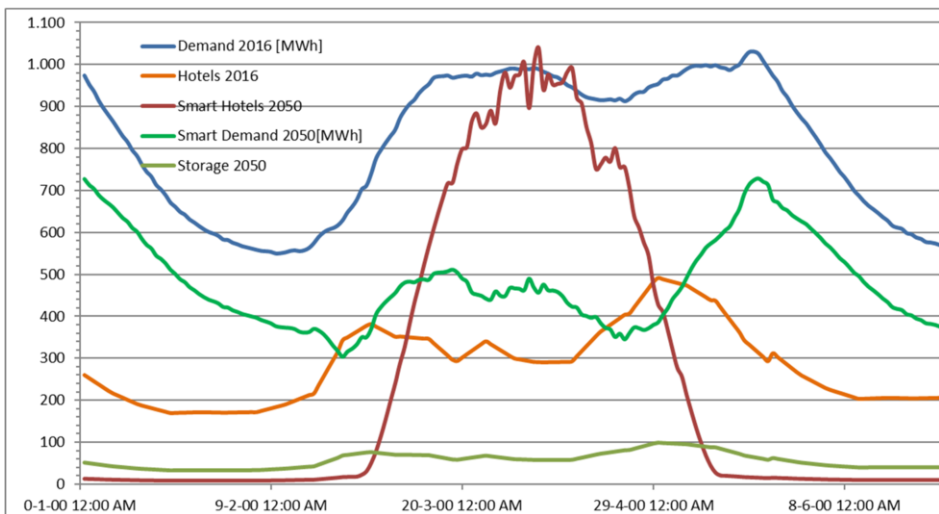

**Figure 3.** Simulation of intelligent Hotels with thermal storage at Balearic Islands Electric System in August.

In a future scenario with hotels with 100% with solar energy the demand of the Electric system will be reduced in some hours a 50% and in others a 30%, reducing the impact of the tourism in the Energy system. Only with competitive technologies, is possible to

arrive to Zero emissions in 2050, but these will need a total refurbishment and new design of the energy systems in the Hotels and in the rest of the buildings.

#### 4. Conclusion

Applying a smart systems and Solar Energy to the hotels can result in a large economic, energetic saving and a reduction in CO<sub>2</sub> emissions without change in client comfort and increase the RES integration, especially the Solar PV systems. By changing from fossil fuels for renewable energy sources (like photovoltaic and solar thermal), we can arrive at zero or even negative building energy. Promoting and investing on renewable energies to combat CO<sub>2</sub> emissions is the way to stop to discharge more than 350,000 tons per year with a properly electric mix. The overall zero balance in the Balearic Islands system is overall positive in the order to cover Tertiary sector consumption.

#### References

- [1] Andreu Moià Pol, Miquel Alomar Barceló, Ramon Pujol Nadal, Víctor Martínez Moll. Domestic solar/heat pump heating systems with low and high efficiency collectors in mediterranean areas. Proceedings of the Solar World Congress 2011, Kassel, Germany
- [2] DG de Energia. Govern de les Illes Balears. Estadístiques Energètiques 2017.
- [3] Dascalaki E., Balaras C.A. [2004] XENIOS—a methodology for assessing refurbishment scenarios and the potential of application of RES and RUE in hotels. *Energy and Buildings* 36 (2004) 1091–1105.
- [4] Boletín IDAE:Eficiencia Energética y Energías Renovables (Nº 2,6) Depósito Legal:M-24028-2001, M-18505-2004.
- [5] Pérez-Lombard, L.a, Ortiz, J.b, Pout, C.b .A review on buildings energy consumption information. *Energy and Buildings*. (2010)
- [6] Flourentzou F., J.L. Genre and C.-A. Roulet (2002) “TOBUS software — an interactive decision aid tool for building retrofit studies” *Energy & Buildings*, Vol. 34, pp. 193-202
- [7] Conselleria de Turisme de les Illes Balears. El turisme a les Illes Balears, dades informatives 2017
- [8] M. Karagiorgas, V. Drosou, Th. Tsoutsos. «Solar Energy and RES for the Tourism Sector”, International Conference “RES for Island: RES and RUE for Islands, Sustainable Energy Solutions”, 30-31 August 2004, Larnaka(Cyprus).
- [9] Moià-Pol, Andreu. Diagnosis & Innovation in the energy management at Balearic Touristic Industry (Diagnosi i innovació en els processos de producció i gestió energètica en equipaments turístics de les Illes Balears) , Ph.D. Thesis, Universitat Politècnica de Catalunya, 2012.
- [10] Red Electrica de España <http://www.ree.es/>
- [11] Jan Vetterli, Michael Benz. Cost-optimal design of an ice-storage cooling system using mixed-integer linear programming techniques under various electricity tariff schemes *Energy and Buildings* 49 (2012) 226–234.
- [12] Fong, K.F., Chow, T.T., Lee, C.K., Lin, Z., Chan, L.S., 2010. Comparative study of different solar cooling systems for buildings in subtropical city. *Solar Energy* 84, 227-244.

# New Approach to Indoor Thermal Climate Control Using Natural Building Envelope and Cross Ventilation Techniques

C. Carmona<sup>a,1</sup>, J. Muñoz<sup>a</sup> B. Alorda<sup>b</sup>

<sup>a</sup>*Construction architecture and building engineering group, U. of the Balearic Islands*

<sup>b</sup>*Electronic system group, University of the Balearic Islands*

**Abstract.** Energy savings during construction phases and the lifespan of the building are both important measures to reduce climate change emissions. As well as preventive measures during construction, reductions in embedded CO<sub>2</sub>, building design must consider measures to reduce energy consumption during the normal operation of the building. Particularly in the Mediterranean area, given the high number of sunlight hours and the high solar radiation levels, a decisive factor to maximize energy savings is to introduce natural materials for building envelopes and design passive solutions to improve indoor thermal climate control. Two techniques are analysed in this work: the use of dry Posidonia fiber to isolate the roofs of a real prototype building and, the use of cross ventilation design with the help of an electronic meter to decide when should exterior air flow through dwellings. Both techniques present different advantages in terms of energy savings in the Mediterranean area, allowing to construct and operate buildings more efficiently.

**Keywords.** Thermal indoor management, natural materials, cross ventilation, energy efficiency

## 1. Introduction

The energy consumption impact of buildings must be quantified during design, construction, operation, demolition and waste treatment of buildings. Energy efficiency techniques usually focus on energy consumption during operation phase and several products are oriented to reduce the influence of heating and air conditioning needs on buildings, with households devoting up to 66.6% of the thermal and electric energy consumed to said purpose [1]. In Spain, the construction industry has yet to debate in depth the importance of reducing energy demands and CO<sub>2</sub> emissions produced by materials used during the execution of construction work and the benefits of some traditional local design techniques adapted to the climate characteristics of the building.

In order to consider energy saving measures it is necessary to rethink buildings using more efficient thermal isolation envelope, considering the transport CO<sub>2</sub> emissions requirements to provide those materials at the construction location and introduce traditional passive solutions to manage indoor thermal climate. In this sense, this article

---

<sup>1</sup> Corresponding Author, physics Department, University of the Balearic Islands, Ctra. Valldemossa, km 7.5, Spain; E-mail: cristian.carmona@uib.es.

presents the results obtained on a building prototype located in the Mediterranean island of Formentera where a traditional natural thermal isolation envelope is used combined with another well-known traditional (non-technological) design of ventilation system, based on cross ventilation as an opportunity to introduce appropriate corrective actions in favor of energy savings while maintain the indoor thermal comfort.

The building prototype demonstrates how using dry *Posidonia oceanica* (Neptune grass), a seagrass specie endemic to the Mediterranean, as a form of thermal insulation is consistent with technical requirements of building and constitutes a model that makes it possible to reduce CO<sub>2</sub> emissions more than 50% during construction works [2]. In addition, the energy efficiency of the building is equivalent to an A energy rating for residential buildings, with a consumption of less than 15 kWh/m<sup>2</sup>/year.

The rest of the paper is organized as follows: Section 2 describes the techniques adopted in the building prototype in Formentera. Section 3 describes the building of Formentera and how the traditional techniques are included in the building design. Section 4 highlights the new cross ventilation manager designed. And finally, Section 5 concludes the paper.

## 2. Indoor thermal climate

Traditional architecture methods have been avoided in construction partly due to the growth of new building materials. This behavior has increased the dependence on material-producing industries. Reintroducing traditional construction processes allows local resource providers to be competitive, and reduces substantially transport emissions. In this paper a real building prototype have been analyzed introducing two traditional architecture elements: the use of dry *Posidonia* as insulation for roofs and, the impact of a cross ventilation approach to manage indoor thermal climate in the Mediterranean area.

### 2.1. Natural Building Envelope

The natural materials inclusion in construction projects requires some laboratory evaluation to establish the constructive required parameters according to the technical regulations. The natural material analyzed in this work is the oceanic *Posidonia*. This seagrass grows in the Mediterranean Sea and has been used in traditional construction to cover roofs of small constructions. As *Posidonia* is a vulnerable specie protected by law, its use requires some additional authorization previous to recollection and treatment of the material.

The *Posidonia* was collected from beaches near the location of the building construction area and dried using only solar radiation, following the traditional treatment. It was important to minimize mechanical works, using manual labor and natural procedures in order to reduce embedded CO<sub>2</sub>. Because the *Posidonia* is an organic fiber formed by small parts, the importance of compacting the material during the drying and curing process was analyzed. Furthermore, it was necessary to design a methodology to archive the densities defined by the technical construction project. Initially, a density of 300 kg/m<sup>3</sup> was proposed, which needed to be achievable through manual compression without the need to use mechanical means or pre-compacted systems on site.

In order to characterize the insulation features of this plant, a laboratory experiment is designed to analyze the thermal behavior at different material density. The dry Posidonia is compressed into metal grid box in order to obtain different material density measured by weight. Figure 1 shows one of these metal grids boxes with Posidonia over a weight scale.



**Figure 1.** Dry posidonia brick

These initial laboratory tests determine that the limit density achievable by manual means, even when using traditional tools such as tiles or bottles, does not exceed 215 kg/m<sup>3</sup>. Additionally, the suitability of application of the oceanic Posidonia in a construction system is confirmed, due to both its speed of drying and curing, and its simplicity of storage, transport and application.

**Table 1.** Thermal transmittance characteristics of Posidonia oceanic.

Density (kg/m <sup>3</sup> )	Thermal conductivity (W/m <sup>2</sup> *K)
150	0.049
185	0.044
200	0.043
215	0.041
250	0.039

Table 1 shows the results of thermal transmittance characteristics of the material at various densities. From a light compaction density (150 kg/m<sup>3</sup>), simple manual compactations only using manual pressing by the operator (185 kg/m<sup>3</sup>), high effort manual

pressing systems where the operator compacts the material using traditional tools ( $200 \text{ kg/m}^3$ ) and manual compaction systems where multiple operators use their body weight and tools to achieve better compaction ( $215 \text{ kg/m}^3$ ).

The results of table 1 demonstrate that the use of mechanical systems, which imply a higher cost of application, does not have a significant impact on the final result of thermal transmittance. Additionally, the suitability of using a manual pressing system is determined using traditional compaction tools, such as tiles or bottles.

## *2.2. Cross ventilation in indoor environment*

Cross ventilation consists of taking advantage of the air currents that are generated within a home for its ventilation [3], for this there are two premises that must be met. First one, the building openings through which the air circulates must be sufficiently separated, typically on opposite sides of the house producing a renew of indoor air. And the second one, users must make correct use of that ventilation to maintain an acceptable level of comfort within the house. This last premise is the most critical factor in the efficiency of cross ventilation.

The home user must open and close the windows to achieve levels of ventilation and adequate indoor healthiness. Therefore, it is highly important to have information on when and for how long it is recommended to perform such ventilation. In this sense, the incorporation of cross ventilation technique in the building design level not assure their benefits. It is necessary to inform the user that they should open the windows and allow air to pass through to improve both healthiness and indoor thermal comfort. In this work an electronic system is presented to warn to the home user when it is correct due to there are ideal conditions for ventilation or the deterioration of indoor conditions makes ventilation necessary, or when it is not correct to open the windows for ventilation because the outside temperature or humidity is very far from comfort ranges. Establish when it is necessary to ventilate in order to maintain an adequate comfort range inside is made using the regulations described in ASHRAE 55-2017 [4], where the comfort ranges of a user are determined not only using climatic variables but additionally using variables such as a user's activity, type of clothing or average age. The electronic system proposed was implemented an evaluation in the building prototype of Formentera

## **3. Natural Building Envelope Evaluation in Formentera**

The techniques described in this paper were included in a building prototype constructed in the island of Formentera. The constructed volume is divided into two separate blocks, taking advantage of the fact that the two facades that overlook the street enjoy prevailing winds that passively keep them cool in summer. Two directions and cross ventilation were included in the building thanks to the layout of the living/dining room and kitchen in a Z shape and a bedroom at each end. The entrance to all homes is directly on to the street, restoring the direct relationship typical of rural communities and avoiding the use of elevators, stairs and common areas. Furthermore, they all boast outdoor spaces for private use: ground floor homes have a garden whereas first-floor homes have a terrace with a private staircase. Figure 2 shows part of the building with the windows used for cross ventilation.

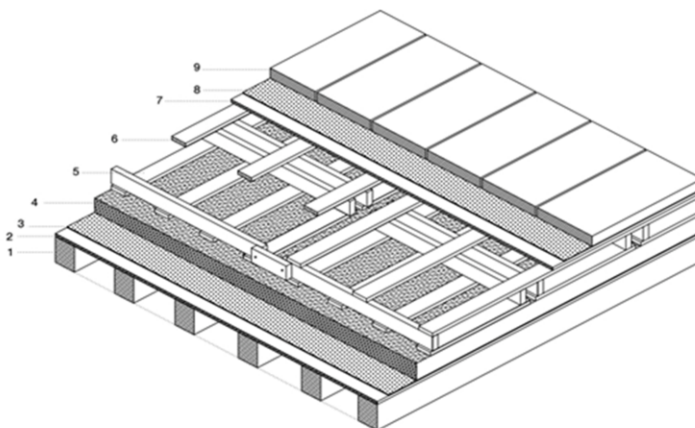



**Figure 2.** Image of the building prototype in Formentera. The building has ground and the first level. The roof is designed to be a terrace. [2]

The final transmittance value needed is limited by the energy saving regulations set forth in the Spanish CTE. Therefore, it is necessary to understand the constructive element, which is made up of multiple layers, as can be seen in Figure 3, where starting from the indoor side and towards the exterior side exposed the layers are:

1. GL-24 laminated wood beams
2. OSB/3 board
3. Riwega Vapor Barrier
4. 250kg/m<sup>3</sup> lightened cement layer
5. Insulating layer by Posidonia
6. Wooden slats 5x10 cm
7. OSB/3 board
8. EPDM waterproof layer and geotextil
9. Stone outer covering



**Figure 3.** Layer section of the roofs including insulation layer made by Posidonia .

The final transmittance of the proposed construction solution, once all its elements have been analyzed is  $0.2164 \text{ W/m}^2\cdot\text{K}$ . This final transmittance of the construction system is more reduced than the limit established by the construction regulations regarding energy saving.

#### 4. New approach to indoor thermal climate control

This work wants to introduce the final user in the indoor thermal climate control strategy. Therefore, an instrument is designed that on the one hand follows the premises of low cost, the reduction of complexity over other existing systems and, allows the inclusion of users in energy management and comfort.

The objective of the proposed instrument is helping to the final user to archive best passive indoor comfort. Analyzing environmental variables such as temperature, humidity and wind speed, the system obtains an image of the current state of both the indoor and the outdoor environments and the analysis of these states allow us to determine the positive or negative of apply cross ventilation to improve indoor comfort.

##### 4.1. Electronic instrument concept

The information presented by the electronic instrument corresponds to a value of **ventilation efficiency potential** ( $E$ ) based on environmental comfort and determined using an algorithm. The control algorithm, called summer operation mode, must be able to measure both indoor and outdoor temperature values, as well as humidity value and outdoor wind speed. The application of the algorithm provides a value of ventilation efficiency potential that in the case of being less than unity ( $E < 1$ ) indicates the need to avoid ventilation with the interior and, in the case of exceeding said value ( $E > 1$ ) the improvement is determined of interior quality in case of ventilation. Equation 1 describes how the proposed algorithm combine the measured variables to obtain the ventilation suitability algorithm for a summer mode of operation:

$$E = \frac{T_i * V_a * \sin \alpha * 100}{T_e * HR_e} \quad (1)$$

where  $T_i$  and  $T_e$  are the indoor and outdoor temperatures respectively,  $HR_e$  is the relative humidity outside,  $V_a$  is the air velocity outside and  $\alpha$  is the main angle of incidence of the wind on the window or ventilation shaft.

Equation 1 is extracted from the provisions imposed in the "Thermal Environmental Conditions for Human Occupancy" ASHRAE Standard 55-2017 [4], in the case of the summer mode of operation. This standard establishes acceptable ranges in terms of temperature, humidity in order to have acceptable levels of comfort.

##### 4.2. Installation and validation

The electronic instrument implemented consist of two modules, see Figure 4: one module must be located in the outdoor side to measure the outdoor variables while the second module is installed indoor. The indoor module includes a third element used to warming the final user about the convenience to perform the cross-ventilation procedure.



**Figure 4.** Modules of electronic instrument. 1 is the outdoor variable measurement module. 2 is the indoor variable measurement module and 3 is the warning signal for the final user.

The electronic instrument has been implemented to be installed in a room where the cross-ventilation elements are available. See Figure 5 to observe the location of each part of the instrument. The location of module 1 is important, because it measure the presence of wind, so it is important install this module in the same building side where the wind is predominant in the area.

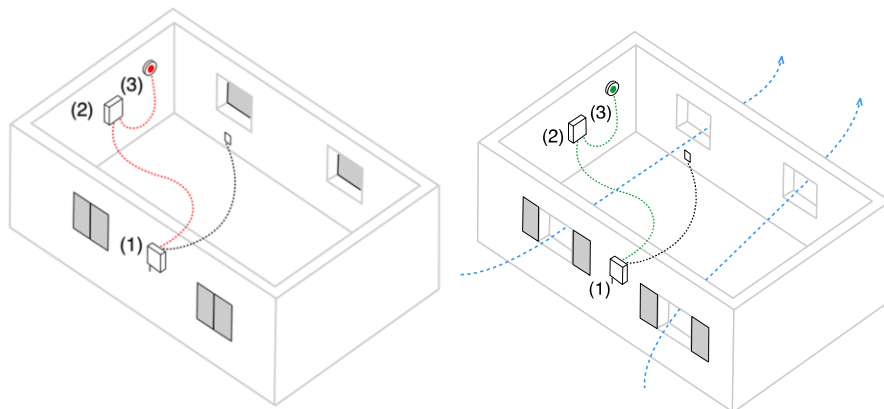

**Figure 5.** Location of instrument modules. (a) the warning led is red, so the cross-ventilation is not recommended. (b) the warning led is green, so the cross-ventilation is recommended.

An example of the final modules installation can be shown in Figure 6. The connection between modules is performed by cable and all the modules are powered by the indoor module, so the indoor module must be installed near an AC electric box.

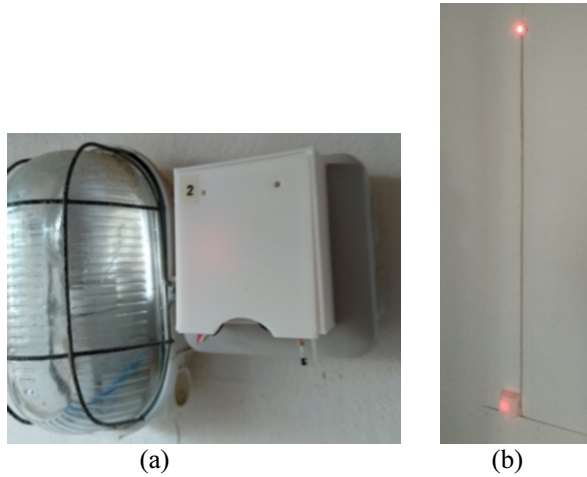
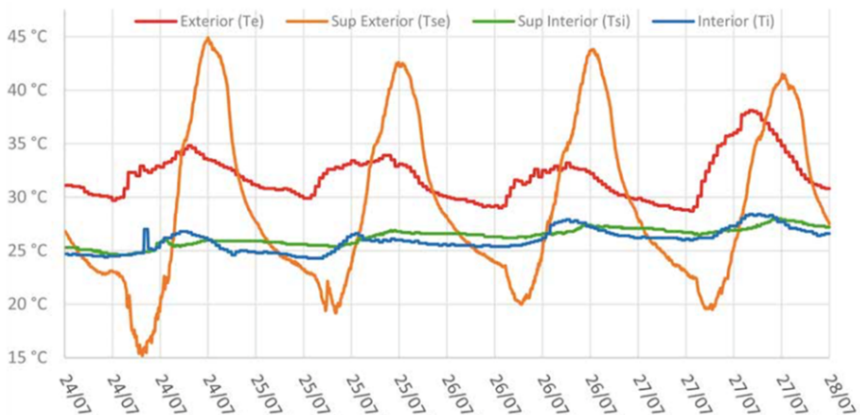

**Figure 6.** Location of instrument modules. (a) outdoor module (b) indoor module and warning led

The validation of the system was performed during a monitoring campaign starting in the solstice of winter and end in the end of summer. This validation process includes indoor and outdoor temperatures, degree of relative humidity and breeze speed inside 8 standard homes, 4 looking north-south and 4 looking east-west. The following tools were used:

- PCE-T150 digital thermometer
- TESTO445 hot-wire anemometer
- PCE-890U surface temperature gun.
- 10 PCE-HT 71N temperature sensors
- 10 PCE-T390 temperature sensors

The results obtained during the campaign demonstrate that the enclosure's insulation works appropriately with constant reductions of 5°C compared to the outdoor temperature and 15°C compared to the outdoor temperature of the surfaces exposed to direct sunlight, as show figure 7.



**Figure 7.** Temperatures of southern facade and indoor temperature ambient

## 5. Conclusions

Two traditional techniques have been analysed in this work: the use of dry *Posidonia* fiber as roof isolation and, the use of a traditional cross ventilation design. Both techniques have advantages, in terms of energy savings, in the Mediterranean area and should be considered to construct and operate buildings more efficiently. A new electronic instrument has been designed and developed in order to help the final user make correct decisions on when to allow external air to flow through the dwelling.

The building prototype was classified as Energy Class A. The roof isolation is a 16-cm thick layer of *Posidonia oceanica* compacted at 185 kg/m<sup>3</sup> with  $\lambda$ : 0.044 W/mK. In summer, the cooling is provided passively by means of controlling external air flow. The windows exposed to sunlight have solar protection, such as a porch, pergola with vines and canes, or shutters made of larch wood.

In winter, passive climate control is dependent on a 90 kW centralized biomass boiler that offers a yield of 92%, which also produces hot water. Additionally, each house logs its energy consumption by means of a Termobox-M heat exchanger.

The openings dimensions have been calculated to ensure that direct radiation occurs on the most unfavorable day of the winter solstice.

## References

- [1] European Commission, EU Energy, 2013, transport and GHG emissions, trends to 2050 reference scenario.
- [2] Life Reusing *Posidonia* web site, <http://eng.reusingposidonia.com>
- [3] Linden, P. F. (1999). "The Fluid Mechanics of Natural Ventilation". *Annual Review of Fluid Mechanics*. 31: 201–238. doi:10.1146/annurev.fluid.31.1.201.
- [4] ASHRAE. ANSI/ASHRAE Standard 55-2017, "Thermal Environmental Conditions for Human Occupancy", American National Standards Institute (2017).
- [5] Muñoz, Joan. & Carmona, Cristian & Horrach, Gabriel & Alorda, B. "APPARATUS FOR THE MANAGEMENT OF A CROSSED VENTILATION SYSTEM", Oficina Española de Patentes y Marcas, 2018, <http://consultas2.oepm.es/InvenesWeb/detalle?referencia=U201830666>.

# Price Relationships of Crude Oil, Biofuels and Food Commodities

Mohcine Bakhat <sup>a,b,1</sup> and Klaas Würzburg <sup>c</sup>

<sup>a</sup>*Research fellow, Economics for Energy, Vigo (Spain)*

*E-mail: mohcine@uvigo.es*

<sup>b</sup>*Business economics department, University Sultan Moulay Slimane (Morocco)*

*E-mail: mohcine.bakhat@usms.ma*

<sup>c</sup>*IESIDE, Business Institute (SPAIN)*

*E-mail: klaas.wurzburg@ieside.edu*

**Abstract.** World agricultural markets have featured unusual price peaks and volatility in the last years. It has been argued that the previously unseen price movements in food prices are related to price peaks of crude oil, where biofuel production is suspected to have created a new link between crude oil and food prices. In this paper we present new evidence on the relationship of food and oil prices. Past investigations on this relationship have mainly applied linear cointegration analysis. However, recent methodological innovations in cointegration analysis allow for a more thorough analysis of the co-movement of commodity prices, detecting asymmetric and thresholds co-movements. These techniques give additional information about the dynamics of price relationships and can identify co-movements that earlier linear cointegration analysis could not detect. Our results indicate that increased biofuel use did indeed create new links between prices food and crude oil, especially so for those food products that have been used to produce biofuel. This finding is surely relevant for policy-making regarding biofuels and should be taken into account when designing programs to incentivize biofuel production and consumption.

**Keywords.** Crude oil, volatility, price relationships, commodities

## 1. Introduction

Several measures and policies have been set out to address the challenges of hunger, environmental deterioration, and lack of energy [1]. One that has obvious relations to all these three “furia” is the promotion and extended use of biofuels. Biofuels have recently been used heavily in the U.S, Brazil, and the European Union; In Europe the EU set out clear targets for biofuel use in the transportation sector - the transport sector is responsible for 57,7% of global fossil fuel use. Clearly, these biofuel initiatives are due to environmental and energy security or energy independence concerns [2,3]. However, almost parallel with the raise of biofuel production and use in roughly 2006, unfavorable conditions in global food commodity markets developed. The FAO estimates that the spikes in food prices in 2008 added 115 million persons to the pool of people afflicted by chronic hunger. Some authors pointed out that the consequences of high food prices are vast, leading not only to starvation itself, but also to migratory and geopolitical instability, which in turn induces new social and economic distortions [4,5].

The new developments on global food commodity markets are attributed to different sources. A mix of causal factors that triggered the first food price spike in 2008: low

---

<sup>1</sup> Corresponding Author, E-mail: mohcine.bakhat@usms.ma

harvests due to unfavorable weather conditions, the exchange rate of the dollar, and high oil prices and increased biofuel use [6]. The view that biofuels have created a new link between oil and food products and that oil price peaks are transferred into food commodity markets is supported by various other authors. The question whether and how the prices of food commodities and oil are linked and what part biofuels play in such a possible link has been one of the most debated topics in energy and agricultural economics during the last years [7].

In this paper we summarize basic facts about biofuels and the new link of oil and food prices. We summarize the results of previous literature on the price links between food commodities and oil. Most previous research applied cointegration analysis, and the results have been incoherent. Some investigations found price links, others did not. This inconsistency of earlier evidence is believed to be due to differences in location, the frequency of the data, modeling specifications, and the particular food and fuels considered, [7; 3]. Moreover, regarding biofuels, there is recent evidence that more and more food product prices are becoming linked with crude oil over time [8,9]. Given this state of the contemporary biofuel research, we set up our analysis to provide new insight: We apply one coherent methodological approach with new superior analytical features to the prices of various food commodities and crude oil and use data after 2000 when biofuel production reached significant levels.

We analyze our extensive dataset of food commodities and oil prices in the same way that most previous research applied: Cointegration. We perform additional cointegration tests that can detect more complex, non-linear relationships. We also perform analysis of possible causalities of co-movements, which give information on which of the two commodities is the leading part and which responds to changes in the other price series. This system of various cointegration and causality tests provides new information on price relationships of crude oil and food commodities, revealing relationships that earlier linear cointegration analysis were unable to detect. Moreover, including various different food commodities in the analysis allows us to draw conclusions on price transmission channels between oil and foods. This enables us to determine how much potential movements are due to biofuels and how much to other forces. The distinction is highly relevant in the light of controversially discussed biofuel policies.

The outline of the paper is as follows: In section 2 we provide an overview of recent developments in biofuels, related policies and market developments. In section 3 we summarize results of previous literature on the biofuel link between food and oil. In section 4 we present the analytical system used to investigate the relationship of food and oil prices based on a new innovative framework of cointegration tests. Results are presented and discussed in section 5. Section 6 concludes.

## **2. Recent developments and facts regarding biofuels**

Biofuel production started approximately in 1990, but total volume and growth was modest. Biofuel production reached significant levels in 2000 approximately, starting out with ethanol and biodiesel following in somewhat later. Figure 1 illustrates world biofuel production since 2000. Ethanol can be produced from sugarcane, sugar beetroot, wheat, barley, and corn and has represented the larger part of biofuel production since 2000. Palm, rapeseed, sunflower, soy and other vegetable oils or animal fats can be transformed into biodiesel. The U.S and Brazil are the main producers of ethanol, while biodiesel is predominantly produced in the European Union.

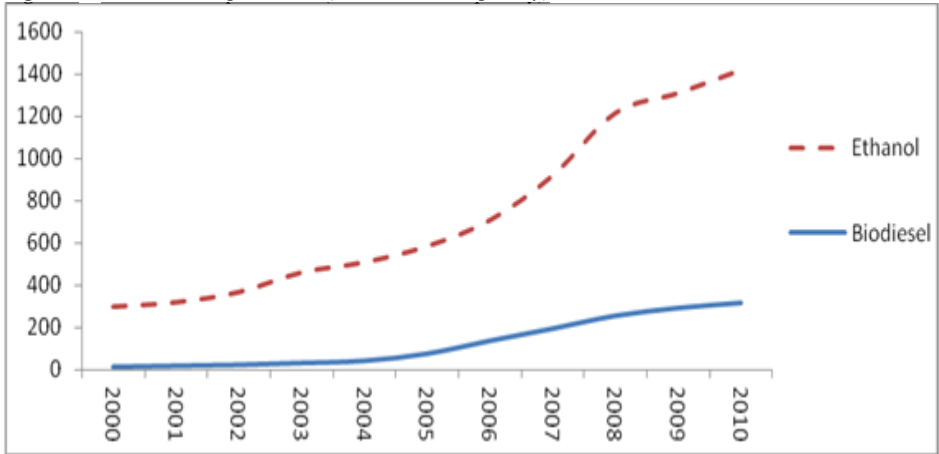
**Figure 1** – World biofuel production (thousand barrels per day)

Source: United States Energy Information Administration.

### 3. Previous research results

The price links between food and oil prices have been mostly investigated empirically by cointegration analysis. The standard cointegration based on Johansen tests and Breitung test suppose linear relationships between two series [10,11]. Some authors could find a linear cointegration relationship between crude oil prices and prices of various commodities [12,13,2,8,3]. However, others studies fail to find any co-movement between crude oil prices and any commodity prices. [14,15].

Only a minor group of studies uses newer cointegration tests (based on Hansen and Seo, test or Enders and Siklos test) that we also use in our analysis [16,17]. These methods are capable of detecting more complex co-movements of data series.

Peri and Baldi apply cointegration analysis based on Hansen and Seo test and find that the cointegration relation of rapeseed and diesel prices is a case of threshold cointegration [18]. Sunflower oil and soybean oil prices are found to have no cointegration relation with diesel, although they do not apply the Ender and Siklos test to check whether these two series do feature threshold cointegration. In another study where threshold analysis based on Hansen and Seo test is used to investigate the price relationship of future contracts of crude oil, gold and eight food commodities [19]. The authors find that only cocoa, wheat and gold move together with crude oil in the long run over the entire sample period. In the same vein, a linear and threshold cointegration analysis (based on Hansen and Seo test) was conducted on crude oil, ethanol and corn prices [20]. The authors of the study find a cointegration relationship from 1999 on where corn and ethanol prices adjust to restore the equilibrium between corn and crude oil prices. In a comparable analysis, results indicated that oil prices are long-run drivers for sugar prices in Brazil, and the adjustment paths of sugar and ethanol prices after oil price impacts are nonlinear [21]. Furthermore, a threshold cointegration analysis was applied to US data on corn, ethanol, oil, and gasoline prices for the US. The study demonstrates the existence of a strong link between corn and energy prices, where energy price increases trigger price increases for corn through the ethanol market [22].



However, past researches do not allow for a definite conclusion on whether biofuel production and consumption created a new link between food and oil prices. Additional research is necessary. A new feature of this study is the use of an extensive set of cointegration test that we explain in the following section. The combination of different cointegration analyses helps us to verify to what extent methodological techniques used in the previous literature are a source for the different results. In this way our study sheds light on how price relations really are, providing more precise information than the earlier studies summarized previously.

#### **4. Data and methodological setup**

Price transmission between food and crude oil can happen on the basis of different logical and theoretical grounds. First, energy is an important input in the production process of foods. Crude oil is central for the propulsion of agricultural machinery and transport of food products. This provides a clear theoretical link between prices of crude oil and food – henceforth referred to as the “input-channel”. In addition, the input-channel there is also the arguably new link between food and oil prices due to the increased use of food products as biofuels – henceforth referred to as the “biofuel-channel”. It is thus important to distinguish between the price transmission channels and design an analytical framework capable of differentiation between them to isolate real biofuel effect.

##### *4.1 Data*

We intent to distinguish possible price effects through the input-channel from those that work through the biofuel-channel we create three groups of commodities. The first group consists of food products which can be (and have been) converted into biofuel: maize (corn), soybean oil, sunflower oil, palm oil, sugar. For this group both price transmission channels (input-channel and biofuel-channel) should be at work. The other groups are designed to serve as a control group where the biofuel channel should not be at work theoretically. Therefore, we also install two control groups to investigate possible interactions: Non-biofuel food products (wheat, rice, beef) and Non-edible agricultural products (rubber, coffee, wool).

The price data on the food commodities plus crude oil were taken from the International Monetary Fund database available under [www.imf.org](http://www.imf.org). Our series consists of monthly data from January 2000 to April 2011 to avoid possible distortions due to these different data patterns (This gives 114 observations).

##### *4.2 Methodology*

To detect price co-movements in this paper we used both linear and non-linear cointegration methods. Different types of cointegration tests exist. The linear cointegration tests based on Johansen tests [10] and Breitung test [11,23] suppose linear co-movements. However, a readjustment reaction to the long-run equilibrium can be conditional on the magnitude of the shock; an adjustment only takes place if a certain threshold is surpassed, for example. Such asymmetry often arises with a threshold close to zero, meaning that the asymmetric reaction regions refer to positive or negative shocks. Since linear cointegration analysis does not account for such asymmetric reactions, other cointegration methods must be employed. These methods were provided by Hansen and Seo [16] and Ender and Siklos [17], who test if the cointegration relationship is better

described if a threshold ECM is specified, accounting for two regimes separated by a threshold.

The asymmetric/threshold cointegration tests mentioned above are follow-ups of linear cointegration tests. They are applied after the linear cointegration test of Johansen [10] and Breitung [11,23]. This is what we do in our system of cointegration tests. If the initial linear cointegration test yields “linear cointegration” between two price series, the Hansen and Seo test can be applied to test, whether this relationship is indeed linear or whether an asymmetric/threshold relationship better describes the found cointegration. In case the initial linear cointegration test finds “no cointegration”, the Ender and Siklos cointegration test can be applied to verify whether there is indeed no relationship or whether there is cointegration of an asymmetric/threshold type (which the initial linear test could not detect due to the strict linearity assumptions).

The asymmetric threshold tests also provide information about the adjustment speeds back to long-run equilibrium in case of short-run deviations. This is an important part of the analysis.

The (re)adjustments and (re)adjustment speeds require some more technical detail to explain: In general the long-run cointegration relationship can roughly be described by the following simplified condition:<sup>2</sup>

$$Y_t = \alpha + \beta X_t + \varepsilon_t$$

where  $Y_t$  represents the price of one of the non-crude oil commodities whose relationship with the crude oil price is investigated (for example the soybean oil price),  $X_t$  is the crude oil price and  $\varepsilon_t$  is the error term (the deviation). Rearranging yields:

$$\varepsilon_t = Y_t - (\alpha + \beta X_t)$$

The long-run equilibrium would expect  $\varepsilon_t$  to be zero, but in the short run this will frequently not be the case. The value of  $\varepsilon_t$  can be affected by the two prices. It becomes bigger, representing a positive deviation, if either  $Y_t$  is unusually high or  $X_t$  is unusually low (or both), and vice versa.<sup>3</sup> The second step of the analysis is concerned with the short-term white noise disturbance  $\mu_t$ . Introducing this disturbance yields  $\Delta\varepsilon_t = \rho \varepsilon_{t-1} + \mu_t$ . If  $-2 < \rho < 0$  is satisfied the long-run equilibrium with symmetric adjustment is accepted. Nevertheless, recent evidence indicates that this condition is often not satisfied in cases of asymmetric adjustment patterns. For these cases alternative approaches are provided, for instance by Enders and Siklos [17] who propose two modifications to this simple model in order to test for asymmetries: a threshold autoregressive (TAR) model, and a momentum-threshold autoregressive (M-TAR) model. These specifications assume that the speed of adjustment of prices will depend on the size of the price deviation in the previous period with respect to a certain threshold  $\tau$ . Deviations from the long-run

---

<sup>2</sup> For a detailed technical description of the cointegration methods applied here consult our article [24].

<sup>3</sup> Hence the value of  $\varepsilon_t$  does not provide information about which of the prices was responsible for the short run deviation, it might be either one of them or both.

equilibrium occur in two different regimes (above and below  $\tau$ ), and their corresponding adjustments can either have the same speed (symmetry) or different ones (asymmetry).<sup>4</sup> Two different analyses exist to shed more light on the direction of causalities, that is, which price is more likely to move exogenously and which is more likely to perform the adjustment movement afterwards or which price series “leads” the other. The first one, called “momentum equilibrium adjustment path” (MEAP) is a by-product of the ECM in the threshold cointegration analysis. Alternatively, the Granger causality test can also provide additional evidence as to whether, and in which direction, price transmission is occurring between oil and the other commodities. Technically, the results of the MEAP and Granger causality tests are used to define which price series “leads” the other. The combination of different cointegration tests applied in this study and described above yields the maximum detail about the co-moving dynamics of data series that contemporary cointegration analysis can provide. Earlier analysis applied much simpler analytical systems to commodity price pairs.

## 5. Results and discussion

Before cointegration analysis the stationarity of the first differences of each price series must be affirmed. The tests yield that the data are valid for cointegration analysis.<sup>5</sup> As described in the methodology section the framework of cointegration tests can yield three different results for each pair of commodity prices (where a pair always consists of the crude oil price and the price of one of the other commodities): No cointegration, linear cointegration, and threshold integration. In the following we will comment on all relevant test outcomes for each commodity pair.

### *Test results of price pairs*

There is no evidence indicating the presence of cointegration between the crude oil price and the price of the following commodities: maize, beef, wool and rubber.

The majority of the commodities feature threshold cointegration of their prices with the crude oil price. Soybean oil, sugar, coffee, palm oil, and rice were identified as threshold cointegrated with crude oil by the Enders and Siklos test. Sunflower oil and wheat were found to have threshold cointegration with crude oil by use of the Hansen

---

<sup>4</sup> If the price deviation of the previous period is below the threshold, so  $\varepsilon_{t-1} < \tau$ , the non-crude oil commodity price is below its long-run equilibrium value augmented by the value of the threshold ( $Y_{t-1} < \hat{Y} + \tau$ ); and If  $\varepsilon_{t-1} \geq \tau$  the non-crude oil commodity price is above its long-run equilibrium value augmented by the value of the threshold ( $Y_{t-1} > \hat{Y} + \tau$ ). Therefore, if the deviation from the long-run equilibrium in the previous period is larger than the threshold  $\tau$ , the speed of adjustment is then different from when the deviation is smaller than the threshold. Threshold cointegration is particularly interesting if the threshold value is found to be close to zero, meaning that the two regimes correspond (roughly) to positive and negative deviations.

<sup>5</sup> This I(1) condition is tested by use of three unit root tests: Augmented Dickey-Fuller (ADF), Philips-Perron (PP) and Breitung, the latter being consistent to structural breaks.

and Seo method. Hence, seven out of the ten commodity price pairs analyzed are threshold cointegrated with the crude oil price.

The following commodity prices feature asymmetric adjustment speeds with crude oil prices: Soybean oil, sugar, sunflower oil, coffee. No such differences in the adjustment speeds for the two threshold regimes are found for palm oil, rice, and wheat; the adjustment speeds are symmetric.<sup>6</sup>

The momentum equilibrium adjustment path (MEAP) and Granger causality provide some insightful results. For soybean oil, both the momentum equilibrium adjustment path and Granger causality test report a clear result. They both indicate that the soybean oil price tends to move before the crude oil price; in other words: the crude oil price is more likely to perform the adjustment movement to restore long-run equilibrium; soybean oil prices lead crude oil prices, especially so for deviations smaller than the threshold. Soybean oil is the only commodity where both causality tests indicate a coherent result. For other causalities found, only one of the tests indicates a price leadership. The results suggest that soybean oil and palm oil prices lead crude oil prices. The crude oil price is found to lead only the price of sugar.

#### *Test results concerning groups of different food and agricultural product categories*

The results found by the system of cointegration and causality tests applied in our study are particularly interesting in light of the different groups of food and agricultural commodities that were defined previously. These three groups are:

- Biofuel foods (corn, sugar, sunflower, soybean, palm oil)
- Non-biofuel food products (wheat, rice, beef)
- Non-edible agricultural products (rubber, coffee, wool)

In four out of five cases of biofuel foods, a clear price relationship with crude oil could be identified (sugar, soybean, sunflower, palm oil), and three of these cases are also more complex and asymmetric in adjustment speeds (sugar, soybean, sunflower oil). The first control group consisting of food products with indirect theoretical transmission with crude oil yields less complex price relationships.<sup>7</sup> The two cases of cointegration with crude oil (rice and wheat) are symmetric, beef prices appear to have no correlating relationship with crude oil prices. For the third group, the alternative control group of agricultural products for which only the input-channel can be expected to take effect, we find the weakest evidence of price relationships with crude oil among the three groups. Hence, there are some indications that the price links in the first group of biofuel foods are strongest and most complex. The price links with crude oil become somewhat weaker and simpler in the second group of non-biofuel foods, and are weakest in the third group

---

<sup>6</sup> Asymmetric threshold cointegration means that the adjustments speeds back to long-run equilibrium are different in the two regimes divided by the threshold. This is the case for soybean oil for example, where deviations above the threshold of -0,014 are eliminated at a rate of 0,7% per month (relatively slow), and deviations below the threshold are eliminated at a rate of 25,5% per month (relatively fast). Symmetric threshold cointegration means that there is no difference in the adjustment speeds to long-run equilibrium for the two regimes (for palm oil, for example). Note also that the Enders and Siklos method can provide concrete numbers of adjustment speeds while the Hansen and Seo method can only indicate which one is faster, but not by how much.

<sup>7</sup> Recall that these food commodities feature a substitution relationship (wheat, rice) or production factor relationship (beef) with biofuel foods.

of agricultural products that are not edible. As a consequence, the results indicate some additional complexities in price transmission and price links with crude oil due to the use of food products for biofuel production.

This evidence is not entirely coherent, however. This is because corn, which is heavily used in biofuel production in the US, does not show any price links with crude oil. A possible explanation of this finding is that corn is processed into biofuel mostly in the US and consequently they hypothesize that the high US subsidies made the production of ethanol with corn profitable in the US, no matter what the energy prices in the fossil markets were [19]. This could have unlinked crude oil and corn prices, and would explain why no cointegration relationship between corn and crude oil prices was found for our dataset.

Our system of different cointegration tests and analytical tools can provide more information on the cointegrating relationships of the price pairs which are relevant when analyzing the results for the three different commodity groups. Three out of the four cases of asymmetric adjustment speeds of price links are from the biofuel category, indicating that most complexity of price links with crude oil are in the biofuel food category: For soybean oil and sugar, the price equilibrium with crude appears to reinstall quicker for positive than for negative deviations. This means, if we suppose that the short-run deviations originate from crude oil prices, soybean and sugar prices return much faster to their equilibrium with crude oil prices in case of crude oil price increases than for crude oil price decreases.<sup>8</sup>

Apart from the asymmetry of adjustment speeds, the overall values of the adjustment speed results do not allow for concrete conclusions on differences between categories of food or agricultural commodities. The range of values for the adjustment speeds towards the price equilibrium with crude oil is not different for those foods that are used for biofuel production and those that are not.<sup>9</sup>

The calculations on the causalities in price transmission do provide some additional insight. The only cases where crude oil does not assume the leading part in the price relationship are in the biofuel food category. The results show that some biofuel foods (soybean, palm oil) do move before the oil price. In the case of sugar, the oil price seems to assume the price-leading part.<sup>10</sup> In the other categories of non-food and agricultural commodities, either no causality is found or the oil price is the price-leader.

Summing up, our results show that price links with crude oil are possible also without any biofuel impact. At the same time the results provide some soft, albeit not

---

<sup>8</sup> For sunflower oil we found that the adjustment is asymmetric as well; adjustments are faster when the deviations are above the threshold. However, this threshold is different from zero in this case.

<sup>9</sup> Adjustment speeds for biofuel foods are: sugar 7-14.4% per month; soybean oil 0,7-25.5% per month; palm oil 15%. The only price pair outside the biofuel food category that allowed for a calculation of adjustment speeds is coffee (1.2-8.2 %). Also note that the econometric tools could not provide information on adjustment speeds in all cases.

<sup>10</sup> Relating these results to earlier research provides some interesting additional information: The importance of soybean oil in the determination of prices of other commodities in the biofuel group is in line with earlier results [15], who found that soybean oil prices lead the prices of other edible oil seeds. They did not find cointegration between prices of oil seeds and crude oil, however. The sugar result is particularly interesting when considering earlier results [14], who found that sugar prices lead the prices of the four other food commodities that were included in their analysis.

entirely coherent evidence that the increased production and use of biofuels has affected the price links of food commodities with crude oil. Growing biofuel use has led to closer links of food and oil prices and possibly more complex interconnections between oil and food prices since 2000, more so for those foods that are used in biofuel production than for those that are not.

## **6. Conclusions**

Given the bulk of research that has been carried out on the price links of food commodities and crude oil in the last years, the added value of our analysis on the matter is twofold. First we apply a system of different contemporary cointegration tests which enables us to unveil co-movements that could not be detected by analytical tools of earlier efforts. The combined tests provide new details about the co-movement dynamics regarding asymmetries, adjustments speeds and causalities, rendering important new information for actors and policy makers in these markets. Secondly, we present result for different categories of food and agricultural products and their price relationships with crude oil. This is important since a possible correlating price relationship of food commodities and crude oil is theoretically possible even without any biofuel production, because crude oil is an important production factor for food and agricultural products. Hence, finding a cointegration relationship for crude oil and food commodities does not necessarily mean that biofuel use plays any role in this relationship. Therefore, it is necessary to investigate the price relationship of different food and agricultural products, distinguishing between those food products that are used for biofuel production and those that are not. In this way differences in the strengths and characteristics of price relationships between the typical biofuel foods (like corn, sugar, soybean etc) and other food and agricultural products can be observed. This provides information on how much stronger the price link with crude is for biofuel foods than for non-biofuel foods. The extensive system of cointegration tests of our analysis is helpful in this endeavor, because it provides additional information on the price relationships which is then used to detect differences between the types of food and agricultural commodities.

The results of our cointegration analysis provide some moderate evidence that biofuel production has increased the link between food prices and oil prices. Generally, the most complex price links with crude oil are found for those foods that are used for biofuel production, but not exclusively so. Some more complex price relationships (asymmetries and complex causalities) are also found for a price relationship between crude oil and an agricultural product that is neither edible nor used for biofuel production (coffee), but most of these complex price relationships are found for the typical biofuel foods (sugar, soybean, sunflower, palm oil). Given that no cointegration relationship with crude oil prices could be identified for one of the most prominent biofuel foods (corn), the results are not entirely coherent and unanimous. This leads us to conclude that our analysis provides some indications of biofuel production providing an additional link between food and oil prices, but the evidence is not entirely coherent and clear. More research, particularly following our approach to analyze price links with crude oil for different food products (with different theoretical price transmission channels and biofuel impacts), may be necessary to draw clear-cut conclusions.

## References

- [1] J.C., Escobar, E.S., Lora, O.J., Venturini, E.E., Yañez, E.F. Castillo, Biofuels: Environment, technology and food security, *Renewable and Sustainable Energy Reviews* **13**, (2009), 1275-1287.
- [2] N., Hao, G., Colson, B., Karali, M., Wetzstein, Food before Biodiesel Fuel? *Selected Paper prepared for presentation at the Southern Agricultural Economics Association (SAEA) Annual Meeting, Orlando, Florida*, (2013), 3-5.
- [3] I., Hassouneh, T., Serra, B.K., Goodwin, J.M. Jil, Non-parametric and parametric modeling of biodiesel, sunflower oil, and crude oil price relationships, *Energy Economics*, **34**, (2012), 1507-1513.
- [4] B., Senauer, food market effects of a global resource shift toward bioenergy, *American Journal of Agricultural Economics*, **90**(5), (2008), 1226-1232.
- [5] R., Sari, S., Hammoudeh, C.L., Chang, M., McAleer, Causality Between Market Liquidity and Depth for Energy and Grains, (2011) available at <http://ssrn.com/abstract=1817022> (accessed on June 7th 2011)
- [6] P.C., Abbott, C., Hurt, W.E. Tyner, What's driving food prices? *Farm Foundation Issue Report, Farm Foundation, Oak Brook, IL*, (2009).
- [7] D., Zilberman, G., Hochman, D., Rajagopal, S., Sexton, G., Timilsina, The Impact of Biofuels on Commodity Food Prices: Assessment of Findings, *American Journal of Agricultural Economics* **95**(2), (2013), 275-281.
- [8] P., Ciaian, d'A., Kancs, Interdependencies in the energy-bioenergy-food price systems: A cointegration analysis, *Resource and Energy Economics*, **33**, (2011), 326-348.
- [9] L., Kristoufek, K., Janda, D., Zilberman, Correlations between biofuels and related commodities before and during the food crisis: A taxonomy perspective, *Energy Economics*, **34**, (2012), 1380-1391.
- [10] S. Johansen, Statistical analysis of cointegration vectors. *Journal of Economic Dynamics and Control*, **12**, (1988) 231-254.
- [11] J., Breitung, Rank Test for Nonlinear Cointegration. *Journal of Business & Economic Statistics*, **19**(3), (2001), 331-340.
- [12] H.A., Abdel, F.M., Arshad, The impact of petroleum prices on vegetable oils prices: evidence from cointegration tests. *Oil palm industry economic journal* **9**(2), (2009), 31-40.
- [13] K., Chaudhuri, Long-run prices of primary commodities and oil prices, *Applied Economics*, **33**, (2001), 531-538.
- [14] Z., Zhang, L., Lohr, C., Escalante, M., Wetzstein, Food versus fuel: what do prices tell us?, *Energy Policy*, **38**, (2010), 445-451.
- [15] T.H., Yu, D.A., Bessler, S. Fuller, Cointegration and Causality Analysis of World Vegetable Oil and Crude Oil Prices. Selected Paper prepared for presentation at the *American Agricultural Economics Association Annual Meeting, Long Beach, CA July 23-26* (2006).
- [16] B.E., Hansen, B., Seo, Testing for two-regime threshold cointegration in vector error-correction models. *Journal of Econometrics*, **110**, (2002) 293-318.
- [17] W., Enders, P. L., Siklos, Cointegration and Threshold Adjustment, *Journal of Business & Economic Statistics*, **19**(2), (2001), 166-76.
- [18] M., Peri, L., Baldi, Vegetable oil market and biofuel policy: an asymmetric cointegration approach, *Energy Economics*, **32** (3), (2010), 687-693.
- [19] V., Natanelov, M.J., Alam, A.M., McKenzie, G., Van Huylbroeck, Is there co-movement of agricultural commodities futures prices and crude oil? *Energy Policy*, **39**, (2011), 4971-4984.
- [20] E., Elmarzougui, B. Larue, On the Evolving Relationship between Corn and Oil Prices, (CREATE) Working Papers - Center for Research on the Economics of the Environment, Agri-food, Transports and Energy, (2011).
- [21] K., Balcombe, G. Rapsomanikis, Bayesian Estimation and Selection of Nonlinear Vector Error Correction Models: The case of the Sugar-Ethanol-Oil Nexus in Brazil, *American Journal of Agricultural Economics*, **90**(3), (2008), 658 - 668.
- [22] T., Serra, D., Zilberman, J.M., Gil, B.K., Goodwin, Nonlinearities in the U.S. corn-ethanol-oil-gasoline price system, *Agricultural Economics*, **42**, (2011), 35 - 45.
- [23] J., Breitung, Nonparametric tests for unit roots and cointegration. *Journal of Econometrics*, **108**, (2002), 343-363.
- [24] M., Bakhat, K., Würzburg, Co-integration of Oil and Commodity Prices: A Comprehensive Approach, *Economics for Energy*, Working Paper WP FA05/2013, (2013).

# Parametric Building Design Options Within Voronoï Diagram Based Urban Fabric

Fatima-Ezzahra LAAROUSSI<sup>a,1</sup>, Bahia NOUH<sup>b</sup> and Mohammed BAKKALI<sup>c</sup>

<sup>a,c</sup>*Greenwish Sustainable Design and Consulting Ltd, London, UK*

<sup>b</sup>*The National School of Architecture of Rabat, Morocco*

**Abstract.** More convenient methods to analyse and to understand the built heritage in countries with similar spatial features as Morocco are required. The elaboration of a systematic digital based method for designing newly built spaces encompassing all design scales seems to be worthwhile. After carrying out few tests on the feasibility of articulations between different design scales, the building scale seems to be challenging. This building design issue represents an opportunity for additional and enriching explorations with a view to understand and make from the local heritage more responsive to future challenges with regard, for instance, to sustainability and resilience. As hypotheses, we suggested Voronoï diagram and Hankin's method as mathematical approaches among others to improve the design process in such urban settings with such heritage defies. We decided to carry on with the hypothesis of Voronoï diagram exclusively in this article. The design approach aims to analyse, to understand, to systematise and to digitalise the design process. The approach is based on deep research emphasising the link between building design and algorithms. The method uses CAD tools and computational programming. After investigation, it turned out that the application of such an approach on the design of a cultural facility could be useful to the local community. The site is located in the Bouregreg valley in Rabat, Morocco. It implies nice development opportunities between the city of Rabat and the city of Salé. The research process led us to the establishment of a facility that is well integrated vis-à-vis its surroundings. We were able to pay attention to raised difficulties encountered during the design of buildings. We suggested interesting spatial solutions so as to be converted into algorithms. This carefully influenced our choice for building volumes, indoor layouts and spatial distributions. It turns out that the Voronoï diagram hypothesis works well. The final design seems to be satisfactory from heritage, sustainability and resilience point of view.

**Keywords.** Parametric building design, Voronoï diagram, urban fabric, local heritage, algorithms, sustainability, resilience

## 1. Introduction

Voronoï diagram appears in nature, for example, on the neck of a reticulated giraffe, the shell of a turtle, dragonfly wings, human or animal skin cells, some types of fungi, plant leaves, trees and many other examples. Constructions aim to maintain close contact with the living past while having the desire to make something new. Traditional buildings in Morocco have a strong bond with Islamic architecture. This architecture extended from the middle east to the western coasts of North Africa. Morocco, the land of the setting sun, shows itself as a kingdom of traditions, but it is also a country that entered modernity. Islamic architectural art is characterized though assimilating useful

---

<sup>1</sup> Corresponding Author: Greenwish Sustainable Design and Consulting Ltd, 4 Benjamin Adams House, 7 King's Scholars Passage, SW1P 1FZ, London, UK; E-mail: f.laaroussi@greenwishconsulting.com.



cross disciplinary knowledge. During the last decade, many researches were carried out apropos the application of the Voronoï diagram in the design process of the built environment. New design strategies emerged such as parametric design in urbanism [1], parametric landscape design approaches for urban green infrastructures [2], urban form-finding parametric model based on the study of spontaneous urban tissues [3], application of Voronoï diagram as treehouse design tool [4], parametric urban design exploration [5], examining the use of Voronoï diagrams in architecture [6], components for parametric urban design in Grasshopper from street network to building geometry [7], design explorations of performance driven geometry in architectural design using parametric modeling and genetic algorithms [8].

## **2. A new design approach: Delaunay triangulation and Voronoï cells**

In order to raise awareness among various actors and decision-makers vis-à-vis heritage in Morocco and elsewhere. The inspiration should come from local culture, tradition, crafts, architecture and more essentially from nature. Nature created a living and a dynamic system based on light and universal laws of balance and conservation. Designers are required to achieve well balanced design solutions. In this research, the designed urban fabric is inspired from the Voronoï diagram found in several organisms in nature. Voronoï and Hankin are two approaches that offer opportunities for rationalization of urban spaces and architectural details linking and bonding local heritage to different opportunities of modernization and making from newly built spaces more sustainable and resilient spaces. The notion of diagram, as a conceptual and technical tool, could catalyse the emergence of new architectural strategies. Voronoï diagram makes it possible to respond, in particular and in an algorithmic way to many types of problems. The working method is entirely digital. It relies on CAD tools and algorithms. It is based on the following points: Researching links between space, nature and algorithms, digital programming on Grasshopper and Rhinoceros covering the Voronoï diagram, the definition of an attractive architectural programme, the delimitation of an appropriate site. The algorithms developed are fairly clear to intervene from urban scale to finer scales. On the other hand, there are no existing algorithms to conduct architectural design within the Voronoï diagram. Hence, dozens of buildings have been designed within the cultural facility with the CAD tool so as to test the feasibility of these buildings in terms of their functionality, heritage and sustainability concerns. This part of the design process embodies a strong research contribution. Despite the design was developed in CAD, it has the potential to be integrated into an algorithm that deals with built spaces at different scales. This type of design is not yet available in the literature and especially within Moroccan urban settings. The research work led us to new volumes, building layouts, new openings, textures, colons and suitable materials. The method aims to designing algorithms in grasshopper, developing Voronoï diagram from neighbourhood scale till construction details and involving further building parameterization considering daylighting, natural ventilation, heating, cooling and so on. We propose a new design method that considers local heritage issues. The proposed Voronoï based urban fabric covers aspects such as land use decision making, massing and greening. The first step was based on using "Global Mapper". It consists in focusing in a specific site such the medina of Rabat and locating the mosques within it, the Voronoï diagram was therefore generated (see, figure 1).

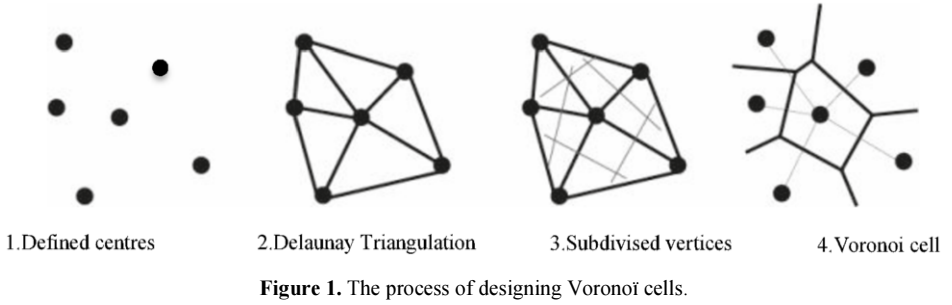

### 3. Design approach applications

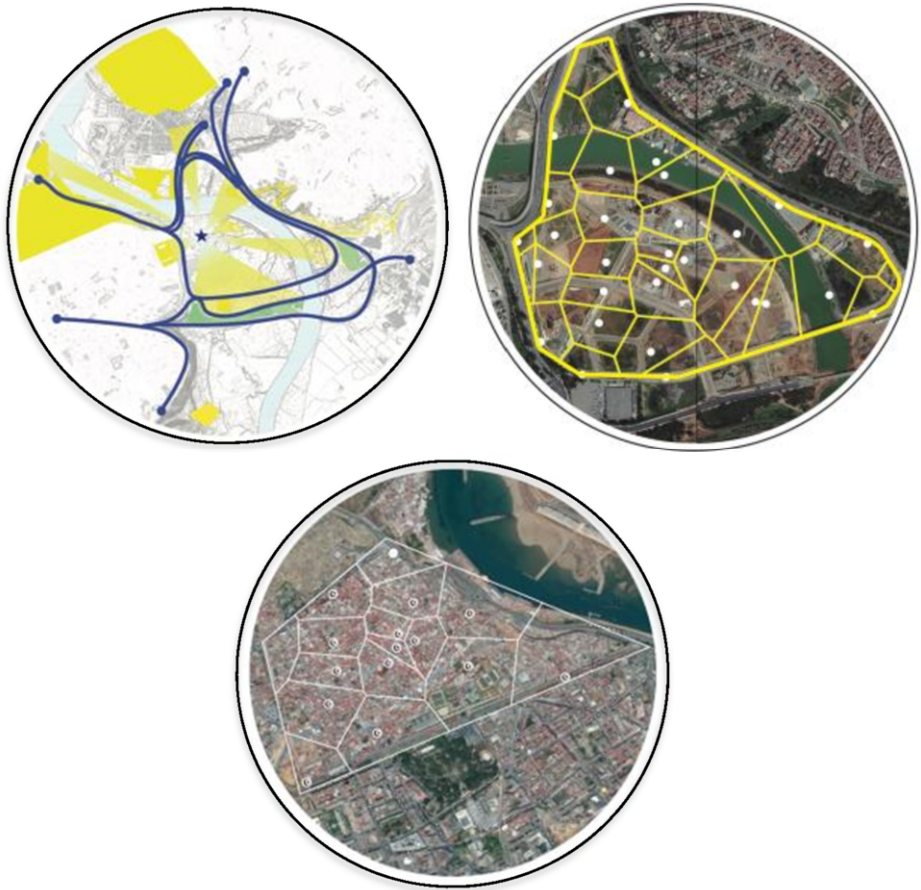

**Figure 2.** The site on the top left showing connectivity and vistas, the site on top right showing the implementation of Voronoï cells and the process of generating Voronoï cells from Mosques' distributions in the medina of Rabat on the bottom.

The design was carried out over the second sequence of the Bouregreg Valley Special Development Plan, called Al Saha Al Kabira, which extends from the Hassan II Bridge to the ONCF Bridge over an area of 122Ha (see, figure 2). Voronoï diagram was implemented on many different scales during the design process of the cultural facility from neighbourhood scale, building scale and urban design till construction details such as facades. During the research we came up with many interrogations such as if local heritage could be explored via new design methods exploring the modelling of existing organisms in nature on macro and micro scales. This could lead to design introverted façades within patios, interior courtyards, and to develop new concepts related to historical urban fabric such as this found in medinas with its irregular shapes that are difficult to understand sometimes. Our questionings covered how we could design an urban fabric that is both contemporary and anchored in the local heritage providing for current and evolving needs, how could we design smart envelopes and new technologies in order to meet sustainability, resilience and enrich local heritage and how we could set up functional building layouts within a very restrictive Voronoï based urban fabric building scale.

#### **4. Multi-scale Voronoï diagram based urban fabric**

##### *4.1. City scale: Land use decision-making*

Medinas are composed of many important facilities such as Mosques, zawiyas (monasteries), madrasas (schools), souks (markets), foundouks (hotels), bazaars (marketplace or street where goods and services are exchanged), arts and crafts, fountains and so on and so forth. Here, we picked up mosques in the medina of Rabat and we applied some geometrical operations involving both Delaunay triangulation and Voronoï cells (see, figure 3). Such geometries represent connectivity between those facilities in the form of alleys and/or streets. At neighbourhood scale, Voronoï cells are locally subdivided in order to generate an other level of Voronoï cells. The dimensions of this level of cells represent courtyard buildings and the cells are established based on courtyards and patios located at the centre of each cell (see, figure 3).

##### *4.2. Neighbourhood scale: Massing and greening*

The cultural facility contains the following spatial programme: Five public gates, a fortification wall, green and negative spaces both inside and outside the wall (see, figures 4 and 5). The programme encompasses the following buildings: workshops, restaurants, media library, gallery, performing arts, museum, games and climbing, music conservatory, kiosks, a worship building and reception/orientation building.

##### *4.3. Building scale: Parametric design options*

- Games and music conservatory buildings

Games and climbing building: This building is reserved for games (see, figure 6). It is spread over two open floors. A floor dedicated to different games for adults and children. A second floor converted into a climbing club. The shape of the building

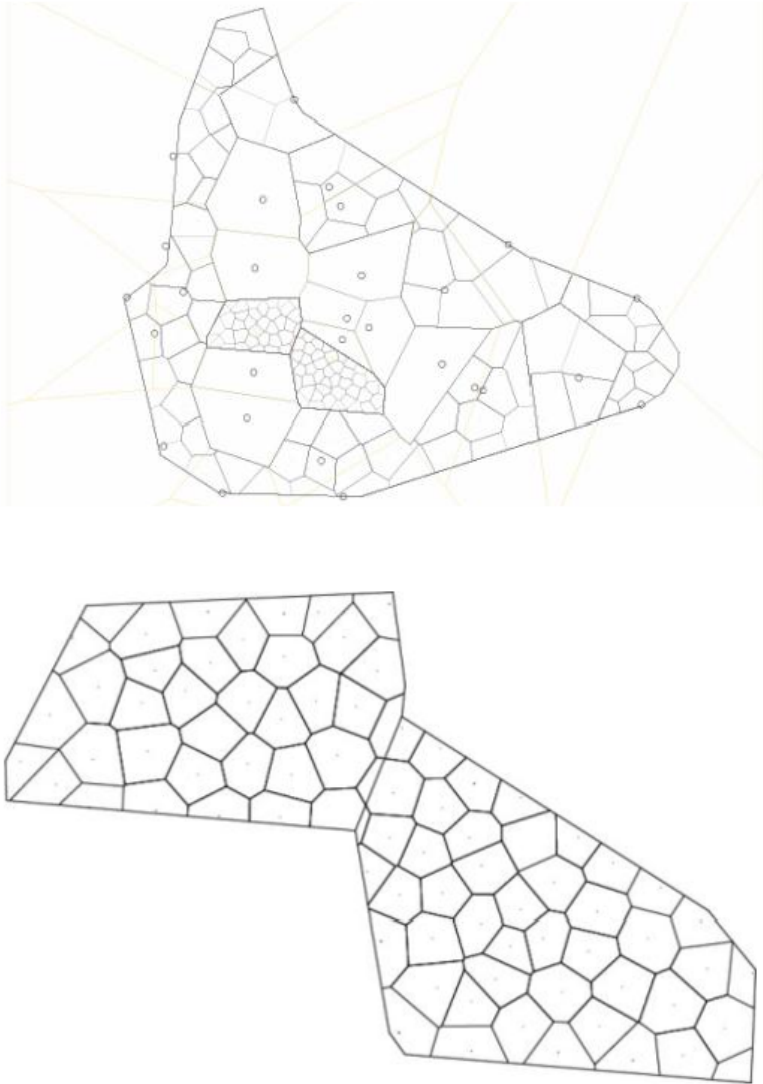

**Figure 3.** Multi-scale implementation of Voronoï diagram, city scale on the top and neighbourhood scale on the bottom.

reduces the effect of the wind on facades. We will round all the corners of the polygon so that we can extrude a compact and resilient shape.

**Music conservatory:** One of the most important buildings is the music conservatory. It is unique (see, figure 6). The design is done over a narrow polygonal plot. The conservatory's spaces are music workshops that require acoustic performance to optimize sound environment in the building. We decided to round the four corners of the Voronoï cell, with semicircles where musicians, guitarists, trumpeters and violinists will be housed. Each space has the form of a semicircle oriented towards the place of the master.



Figure 4. The layout of the cultural facility.

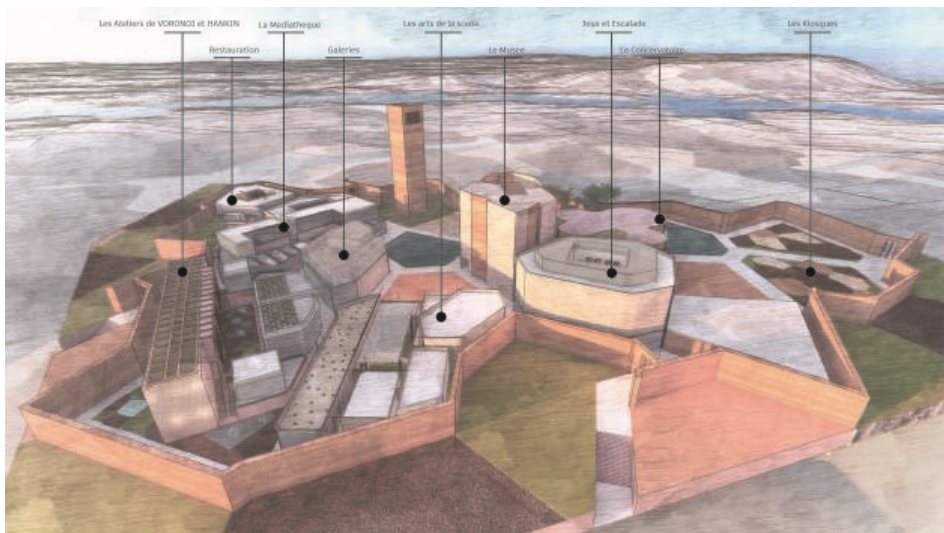

Figure 5. Three – dimensional visualisation of the cultural facility.

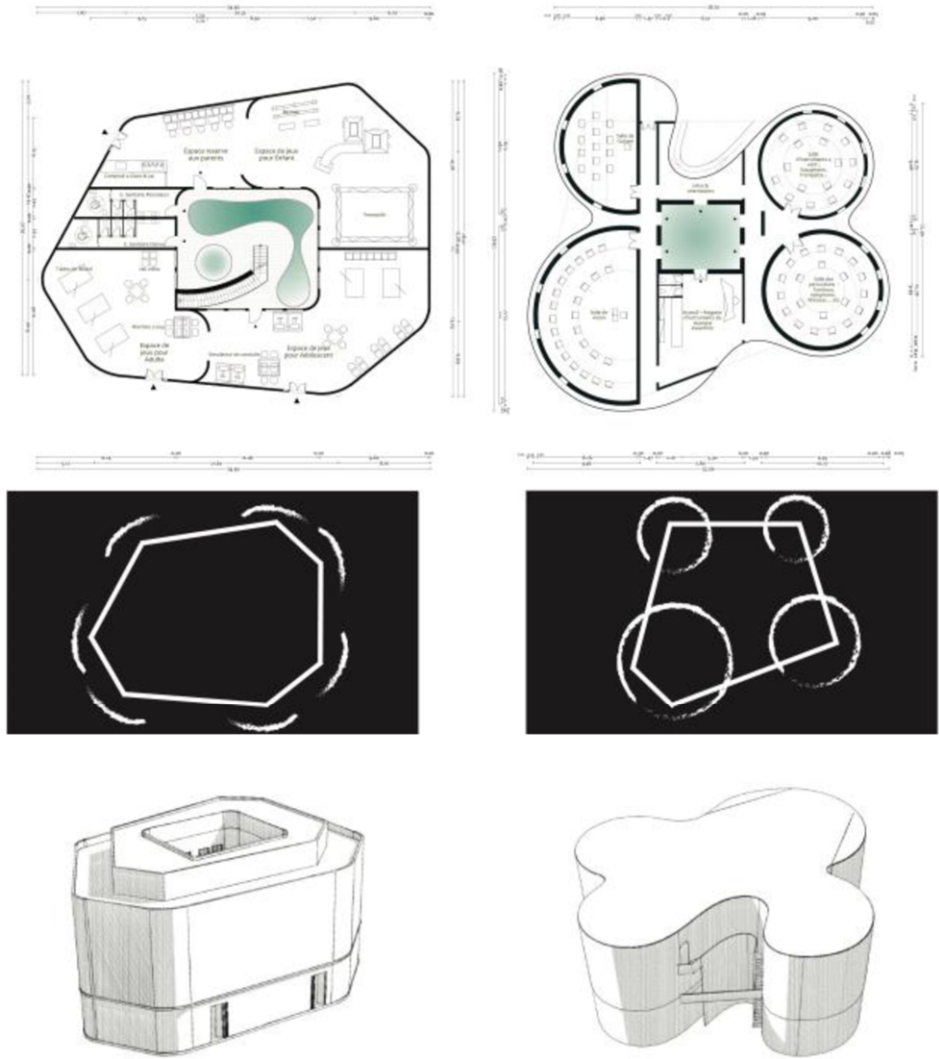

Figure 6. Games building in left column, music conservatory in right column.

- Gallery and worship buildings

Worship building: This Voronoï cell is the cell intended for spiritual functioning (see, figure 7). It will be used for meditation, prayer and meetings between people of different faiths. The layout of this plot reveals a great challenge to bring together a mosque, a synagogue and a meditation space. They are reserved for people of different cults. The concept of this building is to divide it into spaces according to functions that are organized around a large patio.

Gallery: The prism of the gallery occupies a whole cell of our diagram (see, figure 7). Its layout remains almost faithful to the initial shape of the Voronoï diagram. A set of volumes is created in the upper part of the building. Its volumes are defined according

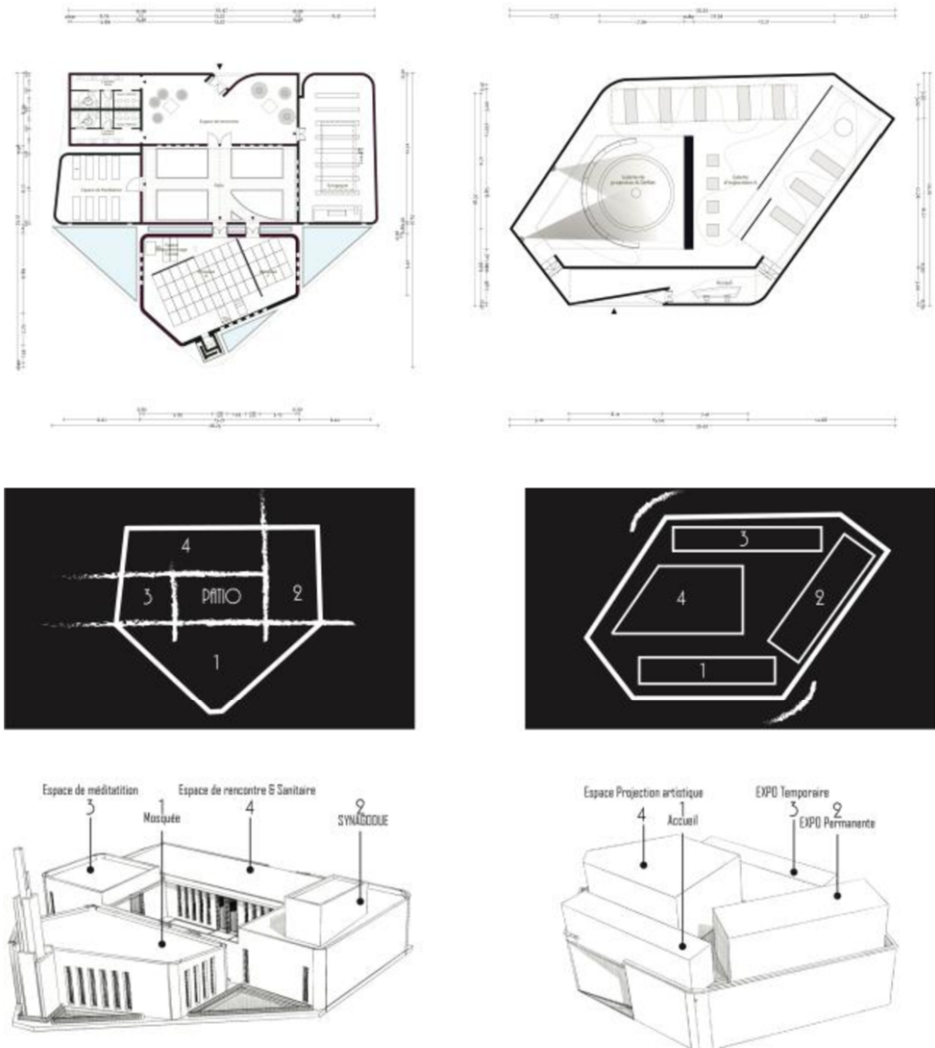
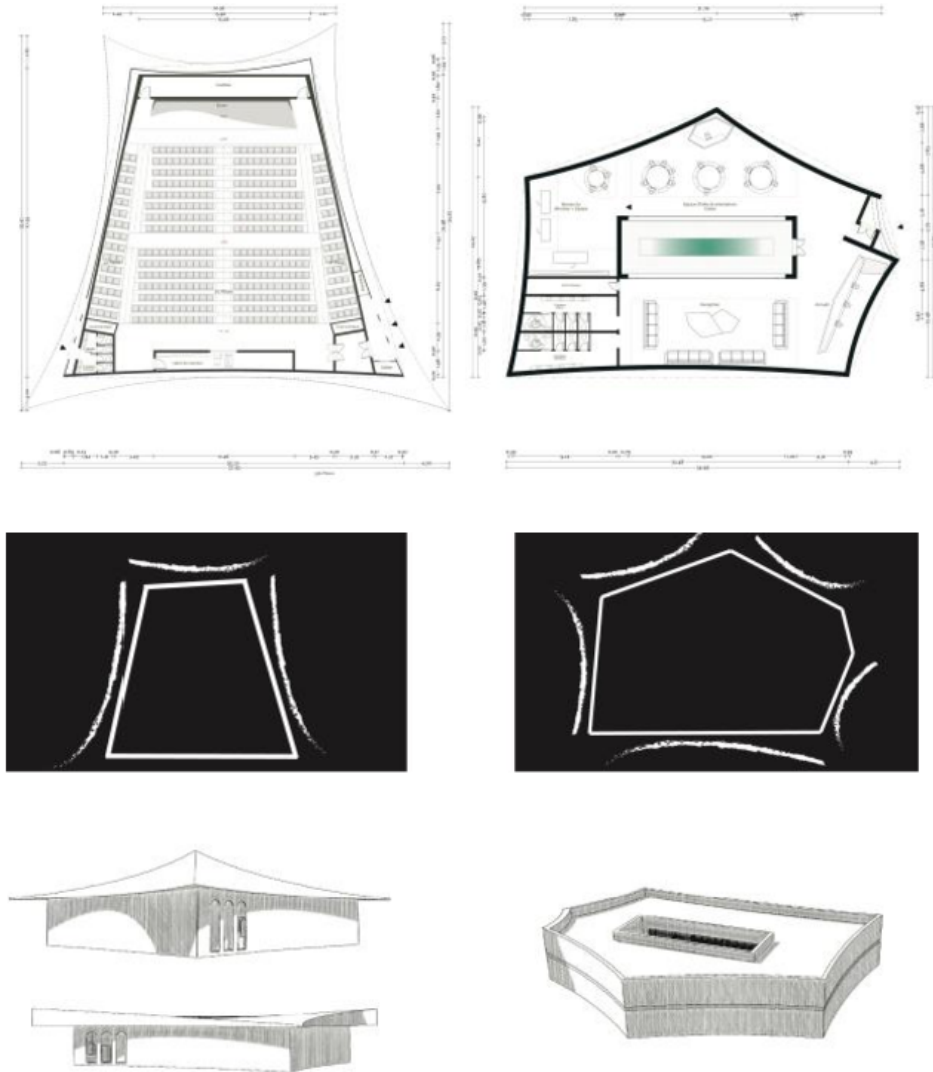

Figure 7. Worship building in left column, gallery in right column.

to the limits of the interior spaces of the gallery. They will be used in particular for lighting, creating a very interesting play of light. Rounded corners to reduce sharp angles are difficult to achieve in construction.

- Cinema and reception buildings

Cinema: The building is reserved for a cinema hall (see, figure 8). The shape of the cell makes it easier to arrange the underground stage of the cinema. The proposed concept curves the three sides of the plot which will serve as a double skin which hides the rigid form of the space. The choice of these curves is made to bring more energy efficiency, this means that, given the reduction in the surface exposed to the weather, it will take less energy to heat and/or cool the interior space of the building.



**Figure 8.** Cinema in left column, reception building in right column.

**Reception and orientation building:** The reception building is reserved for first contact with visitors to the cultural complex (see, figure 8). A building has a patio, its adobe walls rise to reach the height of the wall. Curved walls designed in the same way as the cinema building and for the same energy reasons, adding a big "bonus" in terms of energy efficiency. The patio has several roles, in this case it will play a very important role in daylighting as well as natural ventilation.

- Workshops





The building shelters the most important workshops of the cultural facility. An equivalent of two Voronoï cells were merged in order to handle such an important building programme. The following design step involved subdividing the whole plot of land so as to find the right modules for indoor spaces and the same operations was held for outdoor spaces. Among the building features, the design of an important courtyard, balancing between curved and linear shapes and designing performant double skin facades.

## Conclusion

It is essential to explore other disciplines and to produce not only beautiful cities and buildings, but also to promote life quality. The built environment influences the spirit of human kind. The cultural facility consisted of designing a place for cultural dissemination, with the idea of matching negative spaces to buildings and the large landscape “valley” between the cities of Rabat and Salé. Adding to this, the understanding and the integration of contemporary challenges of buildings. The site constitutes the basement of urban and architectural design that emphasizes heritage, sustainability and resilience. The design approach aimed to design a cultural facility in the heart of the Bouregreg valley in order to create a landmark, a rich, complete and sensitive cultural centre for the two twin cities with a desire to be sustainable and to innovate.

## Acknowledgement

Thanks go to the the National School of Architecture of Rabat, the Bouregreg development agency and Greenwish sustainable design and consulting Ltd.

## References

- [1] Çalışkan, Olgu. “Parametric Design in Urbanism: A Critical Reflection.” *Planning Practice & Research* 32, no. 4 (August 8, 2017): 417–43. <https://doi.org/10.1080/02697459.2017.1378862>.
- [2] Charalampidis, Efthymios, and Ioannis Tsalikidis. “A Parametric Landscape Design Approach for Urban Green Infrastructure Development,” 2015.
- [3] Cheddadi, Mohammed Aqil, Kensuke Hotta, and Yasushi Ikeda. “AN URBAN FORM-FINDING PARAMETRIC MODEL BASED ON THE STUDY OF SPONTANEOUS URBAN TISSUES,” n.d., 10.
- [4] Harwiansyah, Fajar Dzikri, and I Gusti Ngurah Antaryama. “APPLICATION OF VORONOI DIAGRAM AS TREEHOUSE DESIGN TOOL” 4, no. 7 (2016): 16.
- [5] Huang, Weixin and Weiguo Xu. “Parametric Urban Design Exploration in a Graduate Design Studio.” In *Proceedings of the 17th International Conference on Computer Aided Architectural Design Research in Asia / Chennai 25-28 April 2012*, Pp. 559–568.
- [6] Şahin, Ali, and Betül Hatipoğlu Şahin. “EXAMINING THE USE OF VORONOI DIAGRAMS IN ARCHITECTURE ON A STUDENT PROJECT,” 2017. <http://acikerisim.karatay.edu.tr:8080/xmlui/handle/20.500.12498/766>.
- [7] Schneider, Christian, Anastasia Koltsova, and Gerhard Schmitt. “Components for Parametric Urban Design in Grasshopper from Street Network to Building Geometry.,” 68–75, 2011.
- [8] Turrin, Michela, Peter von Buelow, and Rudi Stouffs. “Design Explorations of Performance Driven Geometry in Architectural Design Using Parametric Modeling and Genetic Algorithms.” *Advanced Engineering Informatics*, Special Section: Advances and Challenges in Computing in Civil and Building Engineering, 25, no. 4 (October 1, 2011): 656–75. <https://doi.org/10.1016/j.aei.2011.07.009>.

1st International Workshop on Research on  
Smart Grids and Related Applications  
(SGRA'20)

This page intentionally left blank

# A Framework for Microservice Migration and Performance Assessment

Eugenio RUBIO-DROSDOV <sup>a,1</sup>, Daniel DÍAZ-SÁNCHEZ <sup>a</sup>, Andrés MARÍN-LÓPEZ <sup>a</sup> and Florina ALMENARES <sup>a</sup>

<sup>a</sup>*Department of Telematics Engineering, University Carlos III of Madrid*

**Abstract.** In a large Smart Grid, smart meters produce tremendous amount of data that are hard to process, analyze and store. Fog computing is an environment that offers a place for collecting, computing and storing smart meter data before transmitting them to the cloud. Due to the distributed, heterogeneous and resource constrained nature of the fog computing nodes, fog applications need to be developed as a collection of interdependent, lightweight modules. Since this concept aligns with the goals of microservices architecture (MSA), efficient placement of microservices-based Smart Grid applications within fog environments has the potential to fully leverage capabilities of fog devices. Microservice architecture is an emerging software architectural style. It is based on microservices to provide several advantages over a monolithic solution, such as autonomy, composability, scalability, and fault-tolerance. However, optimizing the migration of microservices from one fog environment to other while assuring certain quality is still a big issue that needs to be addressed. In this paper, we propose an approach for assisting the migration of microservices in MSA-based Smart Grid systems, based on the analysis of their performance within the possible candidate destinations. Developers create microservices that will be eventually deployed at a given infrastructure. Either the developer, considering the design, or the entity deploying the service have a good knowledge of the quality required by the microservice. Due to that, they can create tests that determine if a destination meets the requirements of a given microservice and embed these tests as part of the microservice. Our goal is to automate the execution of performance tests by attaching a specification that contains the test parameters to each microservice.

**Keywords.** Smart Grid, Microservices, Testing, Internet of Things.

## 1. Introduction

An Smart Grid is an intelligent scattered infrastructure that controls the energy requirements in a supportable and economic way with the facility of reliable communication systems for controlling and monitoring. The objective of Smart Grids is to give an efficient framework for energy trading between consumers. Scattered intermittent energy generation and storage need to be controlled and observed logically via the Internet. To tackle growing complications and the huge volume of data produced by the immense usage of devices (i.e., sensors, smart meters, and actuators), robust processing resources

---

<sup>1</sup>Corresponding Author: Eugenio Rubio-Drosdov, Department of Telematics Engineering, University Carlos III of Madrid, 28011, Leganés, Madrid; E-mail: eurubiod@pa.uc3m.es

are required, which must be processed, accessed, stored, and managed by cloud computing. However, the response time and latency in cloud computing are increased by increasing the number of smart devices, which causes deviations for some delay-sensitive applications and smart devices.

Nowadays, the production and usage of Fog computing environments are increasing very rapidly. A Fog environment is a highly virtualized platform that extends the cloud computing to the edge of the network so that computation, storage, and networking services can be performed locally. The stated characteristics of fog computing are most beneficial such as: location awareness, minimum latency, geographical distribution, massive number of devices, mobility, real-time applications, and heterogeneity. Fog devices are distributed, heterogeneous and resource constrained. Hence, applications need to be modeled as collections of interdependent, lightweight modules that can be easily deployed onto these Fog nodes.

Driven by the latest container technology, microservice architecture decomposes a monolithic cloud application into a collection of small services. Each service operates a unique process and connects via a well-defined, lightweight mechanism in order to achieve a business objective. With microservices, users can easily build and maintain large and complex applications in many scenarios but especially in Internet of Things (IoT) and Machine to Machine (M2M) ones. Containers perform execution isolation at the operating system level: a single operating system instance can support multiple containers, each running within its own, separate execution environment. A container is a standardized unit of software. It is a lightweight, stand-alone, executable package of a piece of software that includes everything needed to run: code, runtime, system tools, system libraries, settings.

Furthermore, launching a containerized microservice would not be possible without container orchestration frameworks that manage and deploy containers across clusters, on demand. With orchestration, containers are automatically reconfigured, scaled, upgraded, updated, and migrated without disrupting applications and services. Due to this, containerized microservices are an efficient implementation that reduces infrastructure usage and maintenance cost in IoT environments where frequent changes to devices and applications are required. However, this architecture can overcome some of the difficulties faced with monolithic applications, it also ended up raising some challenges such as: orchestration complexity in the deployment of multiples services, managing and controlling tests, coordinate changes, to define the service boundaries, and to control shared libraries and code reuse. Moreover, orchestrating a microservices architecture brings another challenge, which is to properly migrate containerized microservices from one host to another.

The purpose of this work is to assist microservice migration process. We focus on concluding which feasible destination is the best decision when migrating containerized microservices when computational tasks are moved from one computational environment to another, i.e., when Smart Grid computational tasks needs to be deployed within an available fog which fog environment should be chosen based on pre-defined rules.

Nowadays, solutions are focused on dividing tasks into smaller ones and deploy them in several destinies. They propose different models that predicts hosts performance based on their behaviour. However, the size of the models in large microservice installations are not approachable. These solutions are not optimal due to they take time that in an environment that is subject to continuous mobility does not seem worthwhile to us.

In order to select the destination that best meets the microservice requirements, we consider destination performance tests. However, the functionality of a microservice may rely on other microservices. Due to this, with the idea of not disturbing the operation of the destinations under test, this work proposes to attach mocks in order to simulate dependencies when testing, resulting in test isolation which establish tests boundaries. The architecture proposed in this paper is designed to overcome the execution of performance tests by attaching a specification that contains the test and mocking parameters to each microservice.

The remainder of this paper is organized as follows. Section 2 presents a review of the related work. Following that, section 3 describes the proposed architecture. Section 4 depicts the implementation of the proposed architecture on a use case scenario. Furthermore, while section 5 presents the experimental tests and validation procedures, as well as the obtained results. Finally, section 6 summarizes the conclusions and future work.

## 2. Related Work

### 2.1. Load Balancing

Managing containerized applications in clustered environments involves scheduling and deploying containers within several compute nodes. In addition to management tasks, container load balancing is a key principle that makes sure the applications are running efficiently. Load balancing can improve the Quality of Service (QoS) metrics, including response time, cost, throughput, performance and resource utilization. Load balancing is one of the main challenges and concerns in microservice environments. It is the process of assigning and reassigning the load among available resources in order to maximize throughput, while minimizing the cost and response time, improving performance and resource utilization as well as energy saving. Therefore, providing the efficient load-balancing algorithms and mechanisms is a key to the success of microservice environments.

The offloading decision can be static or dynamic [1] [2]. When the decision is static, the program is partitioned during development. Static partition has the advantage of low overhead during execution. However, this approach is valid only when the parameters can be accurately predicted in advance. Wishbone [3] uses a profile-based approach to partition applications, specified as a data-flow graph of operators, between sensor nodes and servers. The partitioning mechanism in CloneCloud [4] is off-line, and aims to pick which parts of an application's execution to retain on the device and which to migrate to the cloud. It tries to extrapolate the binary pieces of a given process whose execution on the cloud would make the overall process execution faster. The output of such analysis is then used to build a database of pre-computed partitions of the binary; this is used to determine which parts should be migrated on the cloud.

In contrast, dynamic decisions can adapt to different run-time conditions, such as fluctuating network bandwidths. Dynamic approaches may also use prediction mechanisms for decision making. Most dynamic decisions incur higher overhead because the program has to monitor the run-time conditions. Even for programs with dynamic decisions, the tasks that may potentially be offloaded are identified during program development. The MAUI project [5] provides a programming environment where developers an-

notate which methods of an application can be offloaded for remote execution. Each time a method is invoked and a remote server is available, MAUI uses its optimization framework to decide whether the method should be offloaded. Once an offloaded method terminates, MAUI gathers profiling information that is used to better predict whether future invocations should be offloaded. The work presented in [6] and [7] divide applications into tasks according to task control flow graphs and a partition algorithm, respectively. They obtain program computation workload and communication cost with cost analysis and express them as functions of runtime parameters, and then the parametric partitioning algorithm will find the optimal program partitioning corresponding to different ranges of runtime parameters.

In order to make migrations meaningful, we think that some questions need to be considered when making decisions such as (1) is it a task big enough to be worth dividing?, (2) how easy is to monitor the status of tasks? and (3) is there any decision policy to be satisfied? Load balancing is complex, and it may be difficult to obtain all required information when making task migration decisions. As a result, getting optimal solutions may be not possible in real scenarios. Instead, suboptimal solutions can be tried choosing a part of decision factors like most of proposed solutions do. The described works emphasize how the tasks can be divided before or after their deployment. These works propose different models that fit these tasks to predict their performance based on the behavior they have during their living in an environment. However, several works argue why existing approaches cannot simply be applied to microservices [8] [9]. Traditional performance models based on the notion of distinct (virtual) machines are inadequate. The size of the models, as large microservice installations may consist of tens of thousands of service instances. Unlike traditional models, it is not sufficient to discover the relevant structural entities, such as clusters or services, and extract static parameters from runtime data. Due to that, this work proposes to make short-term tests of microservices in the different possible destinations. In this way, what performance the different microservices offer can be extrapolated and are not needed to be stored.

## 2.2. *Microservice's Performance Testing, Mocking and Monitoring*

Test challenges for adopting the microservices architecture include the same ones found in distributed systems in general: inter-service communication and coordination between services. In fact, microservices bring another challenge, which is to properly split the application in several components. This means that we now have to establish the test boundaries of each service, which will have a set of tests to evaluate its compliance with the existing requirements. Moreover, this set of tests may involve other services, which imposes a challenge to track the test dependencies within each microservice.

There are several works that focus on performance evaluation. The work presented by Amaral et al. [10] compare the performance of CPU and network running benchmarks in master-slave and nested-container models of microservice architecture and provides a benchmark analysis guidance for system designers. Kao et al. [11] present a framework that aims to provide software testers with an integrated process from test cases design, test scripts generation, to test execution. Based on the test cases designed by software testers and the appropriate software artifacts preserved by the framework, it generates the corresponding performance test scripts, which can be executed by specific performance test tools (the test tool integrated with the performance test framework is Apache



JMeter). The architectural model presented by de Camargo et al. [12] allows automating the execution of performance tests in applications that are based on microservices architecture. Their proposal is to embed the test specification in each service.

Performance-relevant data in microservice architectures can be collected from the microservice inside a container, from the container, and from interrelated microservices. There are several application performance management tools that particularly focus on monitoring microservice architectures. Kieker [13] is an extensible framework for monitoring and analyzing the runtime behavior of concurrent or distributed software systems. It provides measurement probes for application performance monitoring and control-flow tracing. Elascle [14] is a cloud/application agnostic auto-scaling engine and monitoring system. Elascle itself may be deployed as a microservice on the application cluster manager node and establishes monitoring and auto-scalability automatically. The work presented in [15] presents a service quality model for multi-tier cloud applications deployed by microservices. The use of QoS parameters in the definition of Qualitative Meta data Markers can aid the software engineering tools in the composition of the microservices according to the monitored values for metrics linked to the non-functional requirements. In the work published in [16] the authors present a framework called Py-Mon that uses the Docker management API to obtain statistics of resources used by containers. The work presented in [17] uses libraries to monitor processes inside the containers, thus allowing the effective monitoring of a container that performs a multiservice or multi-process environment. In Osmotic monitoring, the manager agent that is responsible to manage the monitoring of microservices runs in the cloud. The work presented in [18] brings an assessment of the use of Docker containers versus the use of Virtual Machines. To verify the QoS parameters to be compared for evaluation, the authors monitored the CPU usage by the installed Docker process, not verifying the parameters of the containers that are being executed or even of the processes internal to the containers.

Therefore, testing microservices is a hard task due to microservices variety and dependencies between them when constituting a whole functional service. When writing automated unit tests, developers often deal with software artifacts that have several dependencies [19]. In these cases, one has the possibility of either instantiating the dependencies or using mock objects to simulate the dependencies' expected behavior. By simulating its dependencies, developers gain focus: the test will cover only the specific unit and the expected interactions with its dependencies. To support the simulation of dependencies, mocking frameworks have been developed (e.g., Mockito<sup>2</sup>, EasyMock [20], and JMock [21] for Java, Mock<sup>3</sup> for Python), which provide APIs for creating mock (i.e., simulated) objects, setting return values of methods in the mock objects, and checking interactions between the component under test and the mock objects. Past research has reported that software projects are using mocking frameworks widely [22] and has provided initial evidence that using a mock object can ease the process of unit testing [23].

This paper aims to unite concepts: to make short-term tests on possible destinations with the idea of concluding which of them will respond to the required benefits mocking dependencies.

---

<sup>2</sup><https://site.mockito.org/>

<sup>3</sup><https://docs.python.org/3/library/unittest.mock.html>

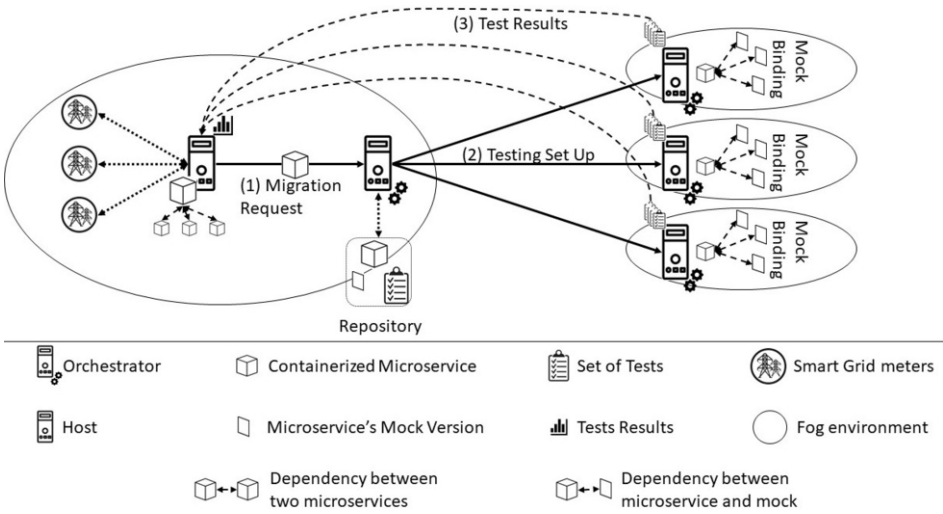

Figure 1. Framework architecture

### 3. Framework Architecture

As result of deploying a containerized microservice architecture, hosts might have instantiated several containerized microservices. In order to constitute a whole functional service, a microservice might be bound to others making communication between them possible. As seen in Section 2, when scheduling and deploying containers within several compute nodes, load balancing is a key principle that makes sure the applications are running efficiently. Orchestration is the traditional way of handling these tasks. With orchestration, there is typically one controller that acts as the Orchestrator. An orchestrator can be used by both developers and operations for an agile service development, integration and implementation, or to schedule updates and tasks. Reliability can be achieved through the application of orchestration rules which can ensure service recovery in case of failure.

In our architecture we propose that a microservice definition should have attached two components: (1) a mock version of the microservice, and (2) a set of tests that can be run. The mock version of a microservice simulates its relevant features. In addition, the set of tests can be used to measure specific parameters. Mocks, tests and measured parameters are specified and provided by the developer of the microservice. When a microservice is deployed in the architecture, the orchestrator has access to its mock version and tests through a repository.

When the orchestrator receives a migration request, the set of tests that can be run and the mock versions of the bound microservices are extracted from the repository. This package is forwarded to the feasible destinations. Firstly, each host instantiates the microservice and does mocks' binding. After this set up, the set of tests are run. Each test gathers its results and sends them back to the source microservice's host.

Based on results, the microservice decides which of the feasible destination better meets its policies. Policies are rules on which microservices base their migration decisions. The parameters that the tests collect can be used to generate rules. When a microservice is deployed, it offers the user the possibility of generating different rules.

**Table 1.** Host features

Device Name	CPU Speed (Ghz)	Number of Cores	RAM (Gb)
D1	2	1	1.9
D2	2	2	1
D3	2.66	4	2

These policies are the result of the interaction between the microservice and the user. The microservice gives a list of the parameters that the tests measure and the user, through an interface provided by the microservice developer, decides the configuration of the policies. For instance, if a test collects information on how long it takes to execute a task, the user could generate a decision rule that says "choose the destination that offers the minimum time".

Figure 1 depicts the performance testing framework architecture proposed adapted to a Smart Grid environment. As can be seen, measures from the Smart Grid meters are collected and computed within containerized microservices. If a migration request is sent to the fog orchestrator it configures the testing set up in the available fogs and the testing results are sent back to the orchestrator, which will decide which fog best suits the needs of the migrant microservice.

#### 4. Test Case Scenario

To validate the proposed architecture, we have developed an small environment depicted in Figure 2. As can be seen on the left side of the image the source host has a Containerization Software (Docker 19.03.5) running. There are two small services which are implemented inside containers: (1) a face detection software built using the Open Source Computer Vision Library (OpenCV) in Java, and (2) a webcam container from Docker Hub. The service provided by these two microservices is to do face detection through the webcam. Face detection is the process of concluding how many faces are in the picture. Each of these microservices, as described in Section 3, has attached a set of tests and a mock version of itself. In addition, there are three hosts running Docker and there is an orchestrator which is aware of all the architecture hosts. The details of these hosts are listed in Table 1. The host in charge of orchestration is a 2.9 GHz six-core CPU and 32 GB RAM.

##### 4.1. Mocking

The mock version of the microservice is a set of MockServer's Expectations. MockServer (MS) is a server configured to return specific responses for different requests via HTTP or HTTPS. When MockServer receives a request it matches the request against active expectations that have been configured, if not matches are found a 404 is returned. The webcam mock version will provide the same image with 8 people people on it.

##### 4.2. Testing

As seen in Section 3, when a request arrives to the orchestrator, three steps are followed in order to do testing in each feasible destination:

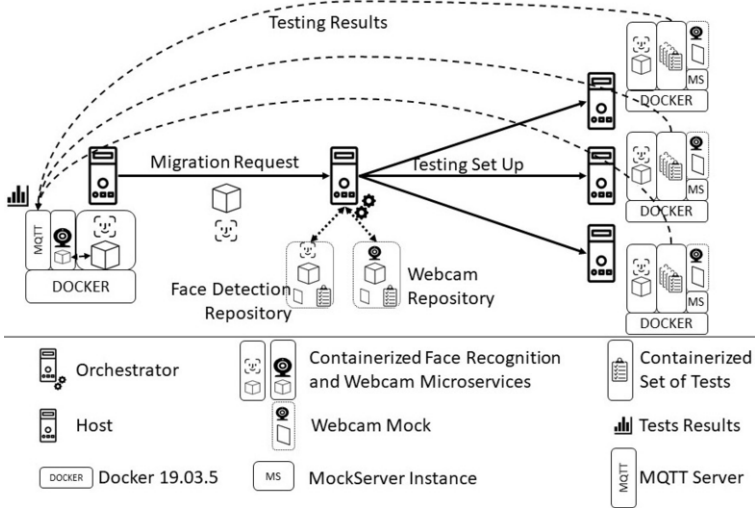

Figure 2. Test case scenario

1. MockServers Configuration. Each host has a MockServer 5.9.0 container instantiated in Docker. The orchestrator uses the MS Expectations of each bound microservice of the migrating microservices in order to configure the MockServers.
2. Microservice Instantiation. The migrating microservice container (the face detection microservice) is instantiated in each Docker instance and it is bound to the MockServer. Due to that, the migrating microservice will do requests to the MockServer and the answer will depend on the configured expectations.
3. Run Tests. Testing the software within the containers is handled using JUnit. Each test is a small JUnit Java class with several test methods. These tests are containerized and instantiated in Docker. In this case, there is a single test which collect the time required to do face detection (*face\_detection\_timing*). When this measure is collected, it is posted into the source host using MQTT protocol.

### 4.3. Policies Definition

When a microservice is instantiated in a host, it provides the user with the option to generate rules using a minimum lexicon and regular expressions: *CHOOSE DEVICE WITH parameter (MIN || MAX || (EQUALS\_TO DOUBLE\_VALUE))*. When the rule is established, it is stored by the microservice. When tests results are gathered and sent to the source, this rule is applied. In case of face detection microservice, the specified rule was *CHOOSE DEVICE WITH face\_detection\_timing MIN*.

## 5. Results and Discussion

We have run the test case scenario explained in Section 4 ten times in order to conclude if the same destination is chosen when applying the previously defined rule. Table 2 shows the results of the tests. Due to these measures, the orchestrator chooses which device will host the microservice. As can be seen, D3 is the device chosen every time, a decision that could be expected taking into account its characteristics (see Table 1)).

**Table 2.** Face detection timing (in seconds)

D1	2.61	2.80	2.92	2.74	3.65	3.55	2.34	2.26	2.59	2.10
D2	1.78	2.00	2.05	1.80	1.91	1.93	1.80	1.80	2.09	1.87
D3	<b>1.46</b>	<b>1.39</b>	<b>1.53</b>	<b>1.36</b>	<b>1.35</b>	<b>1.45</b>	<b>1.44</b>	<b>1.54</b>	<b>1.63</b>	<b>1.72</b>

## 6. Conclusions and Future Work

Going beyond the existing state-of-the-art work, in this paper we proposed an architecture considering end-devices capable of running containerized services. By adopting the proposed architecture, when the orchestrator receives a microservice migration query, it is capable of deploying the ephemeral infrastructure needed to do microservices' testing and take decisions due to their results. The proposed architecture was tested via a use case scenario in which a microservice needed to be migrated. The obtained results showed that testing containerized microservices within the feasible destinations is viable. We believe that the time necessary to carry out the tests and to be able to make decisions when choosing the final destination of the microservice is affordable. Due to the development of the IoT, this work can be implemented for many types of infrastructures. From personal context devices to massive and public environments. This work focuses on supporting mobility of computational tasks taking full advantage of local capabilities and resources within a given environment.

## Acknowledgements

This research was partially funded by the Ministry of Economy and Competitiveness through TEC2017-84197-C4-1-R and by the Comunidad de Madrid (Spain) under the project CYNAMON (P2018/TCS-4566), co-financed by European Structural Funds (ESF and FEDER).

## References

- [1] Kumar, K., Liu, J., Lu, Y. H., Bhargava, B. A survey of computation offloading for mobile systems. *Mobile Networks and Applications*. 2013 Apr;18(1):129-140.
- [2] Zhang, W., Tan, S., Xia, F., Chen, X., Li, Z., Lu, Q., Yang, S. A survey on decision making for task migration in mobile cloud environments. *Personal and Ubiquitous Computing*. 2016 Apr;20(3):295-309.
- [3] Newton R., Toledo S., Girod L., Balakrishnan H., Madden S. Wishbone: profile-based partitioning for sensor network applications. *Proceedings of the 6th USENIX Symposium on Networked Systems Design and Implementation*; 2009 Apr 22-24; Boston, MA, USA; 9, p. 395-408.
- [4] Chun B. G., Ihm S., Maniatis P. Naik M., Patti A. Clonecloud: elastic execution between mobile device and cloud. *Proceedings of the sixth conference on Computer systems*; 2011 Apr 10-13; Salzburg, Austria; p. 301-314.
- [5] Cuervo, E., Balasubramanian, A., Cho, D. K., Wolman, A., Saroiu, S., Chandra, R., Bahl, P. MAUI: making smartphones last longer with code offload. *Proceedings of the 8th international conference on Mobile systems, applications, and services*; 2010 Jun 15-18; San Francisco, California, USA; p. 49-62.
- [6] Wang C., Li Z. Parametric analysis for adaptive computation offloading. *Proceedings of the ACM SIGPLAN 2004 conference on Programming language design and implementation*; 2004 Jun 9-11; Washington DC USA; 39(6); p. 119-130.
- [7] Ou S., Yang K., Liotta A. An adaptive multi-constraint partitioning algorithm for offloading in pervasive systems. *Proceedings of the Fourth annual IEEE international conference on pervasive computing and communications*; 2006 Mar 13-17; Pisa, Italy; 10; p. 125.

- [8] Heinrich, R., van Hoorn, A., Knoche, H., Li, F., Lwakatare, L. E., Pahl, C., Schulte S., Wettinger, J. Performance engineering for microservices: research challenges and directions. Proceedings of the 8th ACM/SPEC on International Conference on Performance Engineering Companion; 2017 Apr 22-27; L'Aquila, Italy; p. 223-226.
- [9] Tyszbrowicz, S., Heinrich, R., Liu, B., Liu, Z. Identifying microservices using functional decomposition. SETTA: International Symposium on Dependable Software Engineering: Theories, Tools, and Applications; 2018, Sep 4-6; Beijing, China; p. 50-65.
- [10] Amaral, M., Polo, J., Carrera, D., Mohamed, I., Unuvar, M., Steinder, M. Performance evaluation of microservices architectures using containers. Proceedings of the 14th International Symposium on Network Computing and Applications; 2015 Sep 28-30; Cambridge, MA, USA; p. 27-34.
- [11] Kao, C. H., Lin, C. C., Chen, J. N. Performance testing framework for rest-based web applications. Proceedings of the 13th International Conference on Quality Software; 2013 Jul 29-30; Naging, China; p. 349-354.
- [12] de Camargo, A., Salvadori, I., Mello, R. D. S., Siqueira, F. An architecture to automate performance tests on microservices. Proceedings of the 18th International Conference on Information Integration and Web-based Applications and Services; 2016 Nov 28-30; Singapore, Singapore; p. 422-429.
- [13] Van Hoorn, A., Waller, J., Hasselbring, W. Kieker: A framework for application performance monitoring and dynamic software analysis. Proceedings of the 3rd ACM/SPEC International Conference on Performance Engineering; 2012 Apr 22-25; Boston, Massachusetts, USA; p. 247-248.
- [14] Khazaei, H., Ravichandiran, R., Park, B., Bannazadeh, H., Tizghadam, A., Leon-Garcia, A. Elascalle: autoscaling and monitoring as a service. Proceedings of the 27th Annual International Conference on Computer Science and Software Engineering; 2017 Nov 6-8; Markham, Ontario, Canada; p. 234-240.
- [15] Knight, L., Stefanic, P., Cigale, M., Jones, A. C., Taylor, I. J. Towards a methodology for creating time-critical, cloud-based CUDA applications. Proceedings of the 3rd edition in the series of workshop on Interoperable infrastructures for interdisciplinary big data sciences; 2018 Jan 18; Amsterdam, The Netherlands.
- [16] Großmann, M., Klug, C. Monitoring container services at the network edge. Proceedings of the 29th International Teletraffic Congress, 2017 Sep 4-8; 1; p. 130-133.
- [17] Souza, A., Cacho, N., Noor, A., Jayaraman, P. P., Romanovsky, A., Ranjan, R. Osmotic monitoring of microservices between the edge and cloud. Proceedings of the 2018 IEEE 20th International Conference on High Performance Computing and Communications; IEEE 16th International Conference on Smart City; IEEE 4th International Conference on Data Science and Systems (HPCC/SmartCity/DSS); 2018 Jun 28-30; Exeter, United Kingdom; p. 758-765.
- [18] Preeth, E. N., Mulerickal, F. J. P., Paul, B., Sastri, Y. Evaluation of Docker containers based on hardware utilization. Proceedings of the 2015 International Conference on Control Communication & Computing India ; 2015 Nov 19-21; Trivandrum, India; p. 697-700.
- [19] Spadini, D., Aniche, M., Bruntink, M., Bacchelli, A. To mock or not to mock? an empirical study on mocking practices. Proceedings of the 2017 IEEE/ACM 14th International Conference on Mining Software Repositories (MSR); 2017 May 20-21; Buenos Aires, Argentina; p. 402-412.
- [20] Freese, T. EasyMock: dynamic mock objects for JUnit. Proceedings of the 3rd International Conference on Extreme Programming and Flexible Processes in Software Engineering; 2002 May; Sardinia, Italy, p. 2-5.
- [21] Freeman, S., Mackinnon, T., Pryce, N., Walnes, J. jMock: supporting responsibility-based design with mock objects. Proceedings of the 19th annual ACM SIGPLAN conference on Object-oriented programming systems, languages, and applications; 2004 Oct 24-28; Vancouver, BC, CANADA; p. 4-5.
- [22] Mostafa, S., Wang, X. An empirical study on the usage of mocking frameworks in software testing. Proceedings of the 14th International Conference on Quality Software; 2014 Oct 2-3; Dallas, USA; p. 127-132.
- [23] Marri, M. R., Xie, T., Tillmann, N., De Halleux, J., Schulte, W. An empirical study of testing file-system-dependent software with mock objects. Proceedings of the 2009 ICSE Workshop on Automation of Software Test; 2009 May 18-19; Vancouver, BC, Canada; p. 149-153.

# A Testbed Based Performance Evaluation of Smart Grid Wireless Neighborhood Area Networks Routing Protocols

Juan Pablo Astudillo León<sup>a,1</sup>, Luis J. de la Cruz Llopis<sup>a</sup>

<sup>a</sup>*Department of Network Engineering, Universitat Politècnica de Catalunya (UPC), Barcelona, Spain.*

## Abstract.

Smart Grid networks have a data communication network associated with the electrical energy distribution infrastructure. This network connects all the subscribers' homes with the data control centers of the supplying companies, which in turn have access to the global Internet network. They are in charge of transporting the needed information between the elements that comprise the electricity network and the control centers. A part of these networks is the so-called Neighborhood Area Networks (NANs), which transports the data from the subscriber's home to some data concentrators. This article presents a comparison of the performance of different routing protocols that can be used in this part of the data network, when a wireless technology is selected. For this comparison, a hardware testbed has been implemented, with a simple initial configuration, which allows the comparison of the OLSR v1, OLSR v2 and HWMP protocols. The numerical results are presented in terms of network throughput, protocol overhead, number of retransmissions, network transit and packet transfer times.

**Keywords.** Smart Grid Neighborhood Area Networks, wireless mesh networks, wireless ad hoc networks, OLSR, HWMP, hardware testbed.

## 1. Introduction

The evolution of the traditional electric system towards the Smart Grid (SG) has attracted research in different areas. For instance, the improvement of the performance of the SG data communication network has focused the work of numerous research groups. In a near future, many services will be provided by this communications network such as control messages, maintenance, billing and all sort of user-generated applications. Some of these services are of crucial importance for the proper functioning of the electricity distribution network, and therefore must be transmitted with the highest level of reliability, security and availability.

The Smart Grid data communication network is comprised in different parts, where each one of them fulfills different purposes. The different smart meters (SM) devices and other hemo appliances are interconnected through the Home Area Network (HAN). Be-

---

<sup>1</sup>Corresponding Author.

sides, the HANs are interconnected by the Neighborhood Area Network (NAN), where wired (Power Line Communications (PLC)) and wireless (Wireless Adhoc or Mesh Networks) technologies have been considered. Finally, a wired or wireless backbone allows the interconnection between the NANs and the control centers.

The goal of this work is the evaluation, by means of a hardware testbed, of some multi-hop wireless network technologies (and specifically their routing algorithms) in the context of the Smart Grid Neighborhood Area Networks (SG NANs). For this purpose, a comparison will be made between two wireless network technologies: the classical ad hoc networks [1] in multi-hop mode and operating with the OLSR (Optimized Link State Routing) routing protocol [2, 3], and the mesh networks as defined also in the environment of the IEEE WLAN networks [4] (previously known as IEEE 802.11s) operating with their own HWMP routing protocol (Hybrid Wireless Mesh Protocol).

The rest of the paper is organized as follows. In Section 2, some related work is presented. Section 3 describes the testbed configuration, and section 4 presents and analyzes the obtained results. Finally, the conclusions are summarized in Section 5.

## **2. Related work**

Most of the research involving routing protocols for Smart Grid Neighborhood Area Networks is performed through network simulations. For instance, authors in [5] present a modification to the Optimized Link State Protocol (OLSR) aiming to satisfy the required level of reliability in NANs. They provided an adapted quality of service to the different data traffics through a combination of different basic metrics. The same authors had previously presented in [6] a performance evaluation and comparison of OLSR and HWMP (IEEE 802.11s) routing protocols, together with a classification of the main AMI application traffics.

In [7], authors present a multigate communication network, based on IEEE 802.11s for Smart Grids where more than one gateway is taken into account, together with real-time traffic scheduling and a multi-channel routing protocol. Furthermore, the authors propose a heuristic backpressure scheme, where every node evaluates the state of its neighbors before selecting one of them as the best next hop. On the other hand, authors in [8] propose the HWMP-NQ protocol which is a modification of the basic HWMP to provide different quality of service (QoS) requirements based on each smart grid data application. To this end, the computation of the airtime link metric is modified. Another modification of the airtime link metric calculation method was presented in [9]. The authors focused their work to give more importance to the upstream communication from smart meters to the concentrator. They also highlight the need for congestion control mechanisms when the network size is increased. With this goal in mind, a congestion control mechanism, which takes into account possible emergencies in the network, and applies also multi-channel allocation and traffic differentiation techniques, is presented in [10].

Some of the same authors of [9] make in [11] a study of the HWMP routing protocol, to identify its weakness, both from the HWMP protocol itself (route instability and route recovery) and from the integration with Smart Grid networks (oversimplified calculation of airtime link metric and the need of traffic differentiation). Here, a modification of the airtime link metric computation is also proposed, as well as a proposal for



the path selection mechanism. A new path selection mechanism is presented in [12] for the HWMP in conjunction with a multi-channel allocation. In this work, the paths are assigned differentially according to the quality of service demanded by every traffic.

When using physical hardware, several routing protocols for multi hop wireless networks are studied and evaluated in Community Networks [13] [14] [15]. The platform mainly used to conduct experiments in Community Networks is the Community Lab testbed [16]. In another work, authors in [17] present the implementation of a OpenWRT OS based testbed for Content Centric Networks (CCN). They analyze the performance of Optimized Link State Routing (OLSR) protocol in an indoor scenario. For the evaluation, they considered hop count, delay and jitter metrics. Their experimental results show that the nodes in the testbed were communicating smoothly with low values of delay and jitter.

In this paper we present a comparison of the performance of different routing protocols used in wireless mesh networks (OLSRv1, OLSRv2 and HWMP) in the context of SG NANs. This comparison has been made through experiments carried out on a real network platform, where the network nodes have been implemented on Linux embedded devices.

### 3. Testbed configuration

As previously said, in order to measure and compare the performance of the different routing protocols in a context of SG NANs, a testbed consisting of a series of Linux embedded devices acting as smart meters nodes has been implemented. In this first series of experiments, we have opted for a linear chain topology, in which the number of intermediate nodes between the source and the destination (data concentrator) of the information is increased (see Figure 1, where every smart meter or station STA is represented together with its coverage area). As will be seen in the results section, increasing the number of hops implies an increase in the use of all the channels of the network under study, with the consequent degradation of the quality of service parameters.

In this first work on the hardware platform, it has been chosen to focus the study on the performance obtained based on the use of different routing protocols. For this, a simple network configuration has been taken into account in which only the first node acts as the source of data, modeling the different home appliances that can be found inside homes. In future works the results will be generalized, considering more complicated network topologies, and including the possibility of having all the network nodes acting as generators and relays of data flows.

#### 3.1. Testbed setup

The measurement setup is based on up to four smart meters (STAs) and one data concentrator. These devices have placed in our lab to model a linear chain topology network. Each device consists of a Raspberry PI 3 device configured either in mesh or ad hoc mode according to the experiment. In mesh mode, each node is configured as a mesh station (MSTA) with the same mesh ID and channel. On the other hand, in ad hoc mode, each node is configured with the same ESSID and channel. In addition, every node has a connection to its direct neighbors one hop away. Hence, it is necessary to ensure the devices do not have connections with the nodes two hops away as presented in Figure 1.

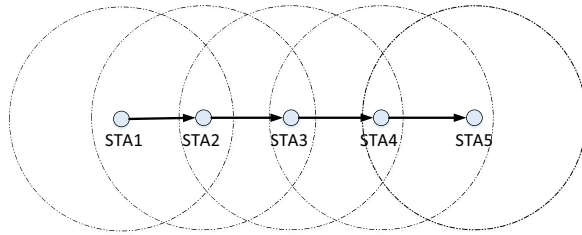

Figure 1. Linear Chain topology.

### 3.2. OLSRv1, OLSRv2 and HWMP implementations

The OLSRv1 and OLSRv2 implementations were downloaded from the OLSR.org project [18]. OLSR.org has two major projects and a minor one. The first one is the OLSRv1 [2] implementation called *olsrd* and the second is the *OLSR.org Network Framework* (OONF) project. The latter contains the implementation of NHDP [19] and OLSRv2 protocols [3] called *olsrd2*. The Dynamic Link Exchange Protocol (DLEP), which aims to extract information from the radio for the design of new metrics, is also implemented in OONF as *DLEP*. On the other hand, the mesh implementation (HWMP) does not need any additional libraries to be installed at the physical devices.

### 3.3. Testbed controller

The testbed implemented is based on a network controller developed in *Python*. It is implemented and running in the first network node (STA1). The controller automatically generates the data flows among the information source (leftmost STA) and the destination (rightmost STA). In order to generate these data flows, the network tool *Iperf3* was also installed in the controller (see Figure 2). In this work, these flows simulate the data generated by SG NAN applications that do not need a reliable connection being established, and so, the UDP protocol has been selected. Each data flow is based on the target throughput, the number of runs, routing and transport protocols, and the number of intermediate nodes. In addition, the controller transmits control packets to the rest of the network nodes in order to save the results generated by *iperf3*, and to enable also traffic captures in every node to get all the exchanged traffic. To carry out the experiments, the parameters shown in Table 1 were configured.

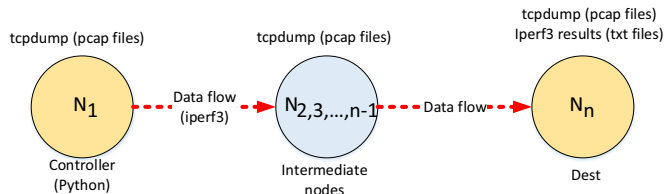
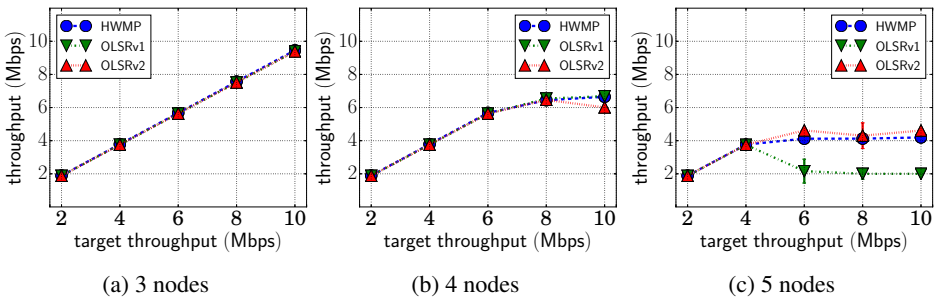

Figure 2. Testbed controller.

**Table 1.** Parameters configured

Parameter	Value
Physical layer	802.11g.
Main scenarios to be evaluated	3, 4 and 5 STAs (including the data concentrator)
Separation between nodes	1 m.
Transmission power	1 dbm.
Target throughput	2, 4, 6, 8, 10 Mbps.
Number of runs per protocol	50.
Run time	100 s.
Confidence Interval (CI)	95%.

**Figure 3.** Throughput measured on the destination node.

## 4. Experimental results

Several runs were conducted in order to evaluate the network performance in terms of network throughput, protocol overhead, network transit time, MAC layer retransmissions and packet transfer time. To evaluate all the network performance parameters, the whole traffic was captured (*pcap files*) through the *tcpdump* network utility.

### 4.1. Network throughput

The throughput represents the number of bits per second received correctly. The obtained measured includes all the layer headers except for the physical layer (Radio Tap Header v0). The headers taken into account for the throughput measurement are listed in Table 2. Figure 3 shows the delivered throughput (and its 95% confidence interval) for different network sizes (3, 4, and 5 nodes), for different target throughput (2, 4, 6, 8 and 10 Mbps), and for the three protocols under evaluation (OLSRv1, OLSRv2 and HWMP). It can be observed how as the network size is increased, it becomes more congested, and therefore, the throughput decreases. However, the throughput decrement is lower when the OLSRv2 and HWMP protocols are used. It must be kept in mind that, when using wireless channels, each additional node in the network causes an increase in the use of channels in its coverage area, which in turn extends to more distant areas of the network

**Table 2.** Protocol header sizes (Bytes)

Protocol	OLSRv1	OLSRv2	HWMP
IEEE 802.11 QoS Data Frame	26	26	38
Logical-Link Control	8	8	8
IPv4	20	20	20
UDP	8	8	8

#### 4.2. Control traffic

All the nodes transmit periodically some control traffic to keep the network topology. Table 3 presents the message types used by each protocol. Our developed network tool identifies the routing protocol, management frames and signaling messages. Therefore, according to the port number and message type, we calculate the amount of control traffic used by each routing protocol. For all the experiments, the routes lifetimes has been set with their default values.

**Table 3.** Message types

OLSRv1	ID	OLSRv2	ID	HWMP	ID
HELLO	1 or 201	HELLO	0	PREQ	130
TC	2 or 202	TC	1	PREP	131
MID	3	DSCP	192	PERR	132
HNA	4				

Figure 4 shows how the HWMP protocol loads the network with less control traffic for all the evaluated network sizes. On the other hand, the OLSRv2 protocol uses more control traffic due to its implementation (olsrd2) uses additional signaling for the Neighborhood Discovery Protocol (NHDP) and Dynamic Link Exchange Protocol (DLEP). Besides, olsrd2 has also implemented the extension proposed by [20] to use multiple routing topologies. To this end, a Differentiated Services Code Point (DSCP) message is sent periodically.

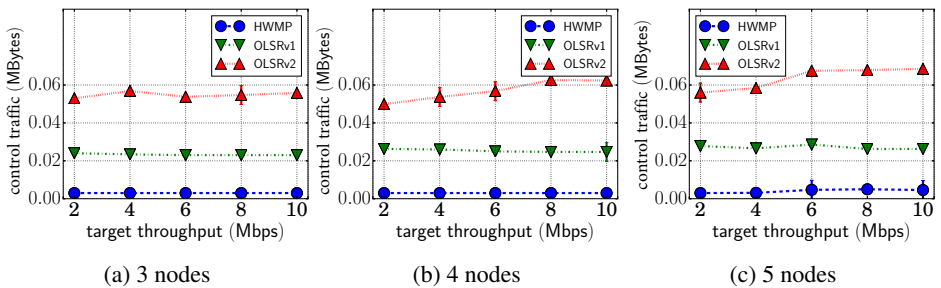
**Figure 4.** Protocol overhead measured on the destination node.

### 4.3. Number of retransmissions

In this subsection, the number of MAC layer retransmissions is evaluated. For this purpose, our network tool analyzes the *Frame Control field* at each frame received and verifies whether the *Retry* flag is set to 1 or not. If this flag is set to 1, the received frame is a retransmitted frame. The results are shown in Figure 5. It can be seen that the number of retransmissions is similar for all the protocols, and for all the different network sizes. In particular, Figures 5b and 5c show that there is no more free time for (re)transmissions (congested network) when the target throughput exceeds the value of 8 and 6 Mbps respectively. Therefore, they are blocked by the medium access mechanism itself.

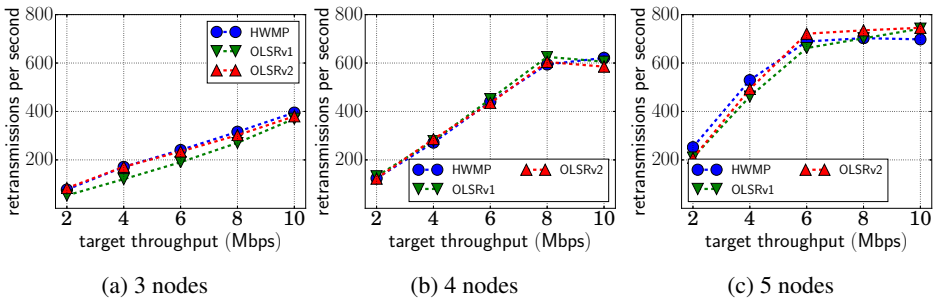

Figure 5. Number of retransmissions measured on the MAC layer.

### 4.4. Network transit time

The transit time is the time that packets need to go from the source to their destination through the intermediate nodes. It must be taken into account that the application fragments the datagrams into several data blocks when their size exceeds the maximum transfer unit (MTU). Therefore, each datagram will have a unique identifier and each fragment has an offset value that will be used in the receiver to reassemble the datagram. The use of the datagram identifier together with the offset value is used as a single identifier in our network tool to calculate the transit time of each datagram. The results are depicted in Figure 6. As it can be observed, as the number of intermediate nodes increases, the transit time also increases. However, the HWMP shows a lower increment of this parameter.

### 4.5. Packet transfer time

The transfer time represents the total time elapsed from the packet arrival and departure times at one network node. The measurements are based on the schematic shown in Figure 7. For this purpose, ICMP messages have been used, where the ICMP Request or Reply are generated at the first STA or last STA respectively. Among the different components of the transfer time (packet headers processing, queuing, medium access and transmission times), in this section we are interested in the evaluation of the processing time. In this sense, only one ICMP message is generated every two seconds to avoid queueing delays and MAC layer retransmissions. On the other hand, as shown also in Figure 7,

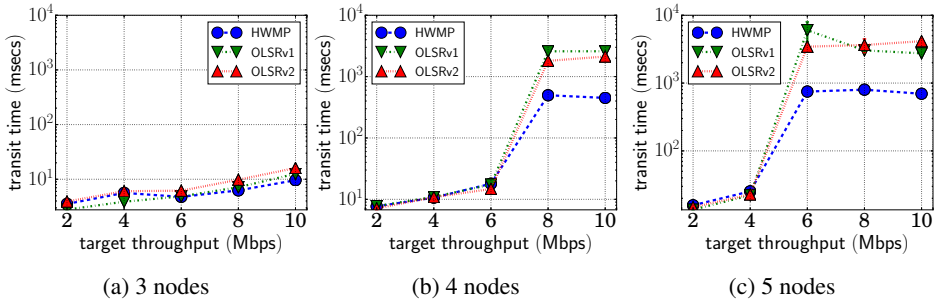

Figure 6. Network transit time.

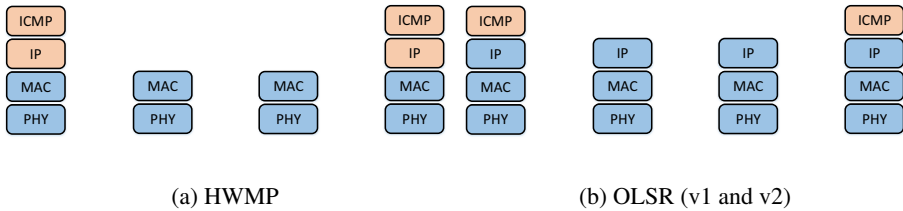

Figure 7. Layers involved in packet retransmission.

with OLSRv1 and OLSRv2 the PHY, MAC and IP layers are involved in forwarding the packets, while with HWMP the IP layer is not necessary.

For all the experiments, the same hardware/software and workload configurations have been used. The objective is that each of the intermediate nodes maintains the same execution time of the processing tasks. For this calculation, the end nodes are not considered since they add processing time for the generation of ICMP Request and Reply messages. Table 4 shows the protocols and packet headers lengths. The transfer time estimation is based on the analysis of 2000 traffic captures (*pcap files*) per protocol.

Table 4. Packet headers length (Bytes)

Protocol	ICMP (Request)			ICMP (Reply)		
	OLSRv1	OLSRv2	HWMP	OLSRv1	OLSRv2	HWMP
Radiotap	13	13	13	36	36	36
QoS Data	26	26	38	30	30	42
LLC	8	8	8	8	8	8
IPv4	20	20	20	20	20	20
ICMP	64	64	64	64	64	64
<b>Total</b>	<b>131</b>	<b>131</b>	<b>143</b>	<b>158</b>	<b>158</b>	<b>170</b>

The results obtained are shown in Figure 8. As can be seen, HWMP exhibits the minimum transfer time as expected, given that fewer communication layers are involved to retransmit the data frames. It is important to note that in the transfer time analyzed, in addition to the processing time, the times corresponding to the access mechanism (interframe spaces, backoff and acknowledgment times) are also included. Therefore, as a future line of work, our network tool will be extended to allow the evaluation of just the

process time. The main objective is to obtain a model for this time that could be included in network simulations.

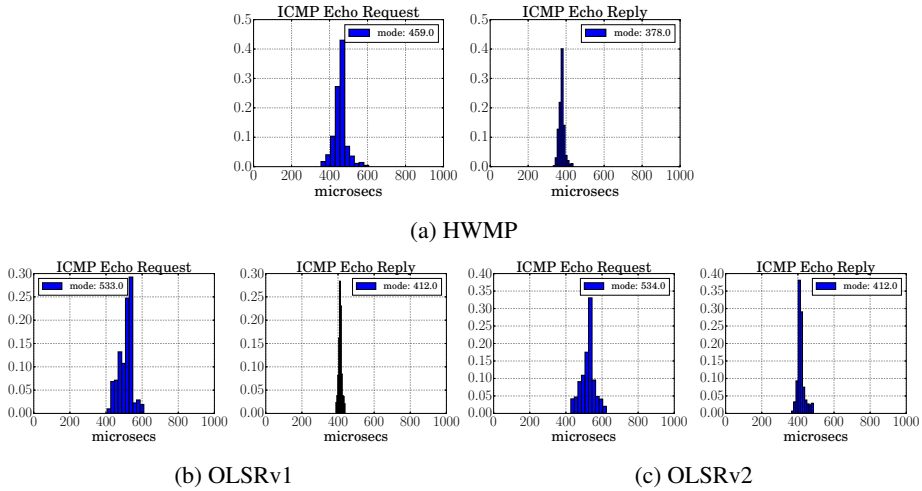

Figure 8. Transfer time (pdf)

### 5. Conclusions

This work is focused on the evaluation of the network performance of different wireless network routing protocols in the context of Smart Grid Neighborhood Area Networks. The evaluation is carried out by means of a hardware testbed based on Linux embedded devices. Each device represents a wireless smart meter, with the first one generating data flows to the data concentrator. A network controller was developed to drive the tests, managing the data flows generation and capturing all the exchanged traffic through different network utilities. Finally, the controller analyzes and processes all the traffic and events generated for all the protocols under evaluation.

OLSR and HWMP protocols were evaluated in terms of throughput, transit time, protocol overhead and transfer time. The obtained results have allowed quantifying the performance that can be expected from a wireless multi-hop network in terms of throughput and network transit time when it is built by Linux embedded devices. This can be very useful if we are planning to develop such a Smart Grid data communication network. Besides, a slight improvement in performance has been observed when using the HWMP protocol. Future works will be focused on more complex network topologies, where all the nodes act as information sources and packet relays.

### Acknowledgment

This work was supported by the Spanish Research Council under project MAGOS (TEC2017-84197-C4-3-R), and Juan Pablo Astudillo León is the recipient of a full scholarship from the Secretaría de Educación Superior, Ciencia, Tecnología e Innovación (SENESCYT), Ecuador.

## References

- [1] "IEEE Computer Society", *IEEE Std 802.11-2016. IEEE Standard for Information technologyâ€”Local and metropolitan area networks. Part 11: Wireless LAN Medium Access Control (MAC) and Physical Layer (PHY) Specifications.*, New York, 2016.
- [2] T. Clausen and P. Jacquet, "Optimized Link State Routing Protocol (OLSR)," *Internet Engineering Task Force (IETF)*, vol. 4, p. 75, 2003. [Online]. Available: <https://www.ietf.org/rfc/rfc3626.txt>
- [3] T. Clausen, C. Dearlove, P. Jacquet, and U. Herberg, "The Optimized Link State Routing Protocol Version 2," Tech. Rep. 7181, apr 2014. [Online]. Available: <https://tools.ietf.org/html/rfc7181>
- [4] IEEE Computer Society, *IEEE Std 802.11s, IEEE Standard for Information Technologyâ€”Local and metropolitan area networksâ€”Part 11: Wireless LAN Medium Access Control (MAC) and Physical Layer (PHY) specifications. Amendment 10: Mesh Networking.*, New York, 2011.
- [5] Y. Tsado, K. Gamage, B. Adebisi, D. Lund, K. Rabie, and A. Ikpehai, "Improving the Reliability of Optimised Link State Routing in a Smart Grid Neighbour Area Network based Wireless Mesh Network Using Multiple Metrics," *Energies*, vol. 10, no. 12, p. 287, feb 2017. [Online]. Available: <http://www.mdpi.com/1996-1073/10/3/287>
- [6] Y. Tsado, K. A. A. Gamage, D. Lund, and B. Adebisi, "Performance analysis of variable Smart Grid traffic over ad hoc Wireless Mesh Networks," in *2016 International Conference on Smart Systems and Technologies (SST)*. IEEE, oct 2016, pp. 81–86. [Online]. Available: <http://ieeexplore.ieee.org/document/7765637/>
- [7] H. Gharavi and B. Hu, "Multigate Communication Network for Smart Grid," *Proceedings of the IEEE*, vol. 99, no. 6, pp. 1028–1045, jun 2011. [Online]. Available: <http://ieeexplore.ieee.org/document/5768102/>
- [8] X. Deng, L. He, X. Li, Q. Liu, L. Cai, and Z. Chen, "A reliable QoS-aware routing scheme for neighbor area network in smart grid," *Peer-to-Peer Networking and Applications*, vol. 9, no. 4, pp. 616–627, jul 2016. [Online]. Available: <http://link.springer.com/10.1007/s12083-015-0331-5>
- [9] J.-S. Jung, K.-W. Lim, J.-B. Kim, Y.-B. Ko, Y. Kim, and S.-Y. Lee, "Improving IEEE 802.11s Wireless Mesh Networks for Reliable Routing in the Smart Grid Infrastructure," in *2011 IEEE International Conference on Communications Workshops (ICC)*. IEEE, jun 2011, pp. 1–5. [Online]. Available: <http://ieeexplore.ieee.org/document/5963578/>
- [10] J. P. Astudillo León and L. J. De la Cruz Llopis, "Emergency aware congestion control for smart grid neighborhood area networks," *Ad Hoc Networks*, vol. 93, p. 101898, 2019.
- [11] J. Kim, D. Kim, K.-W. Lim, Y.-B. Ko, and S.-Y. Lee, "Improving the reliability of IEEE 802.11s based wireless mesh networks for smart grid systems," *Journal of Communications and Networks*, vol. 14, no. 6, pp. 629–639, dec 2012. [Online]. Available: <http://ieeexplore.ieee.org/document/6412861/>
- [12] J. P. Astudillo León and L. J. De la Cruz Llopis, "A joint multi-path and multi-channel protocol for traffic routing in smart grid neighborhood area networks," *Sensors*, vol. 18, no. 11, p. 4052, 2018.
- [13] Freifunk, "Freifunk is a non-commercial initiative for free wireless networks." [Online]. Available: <https://freifunk.net/en/>
- [14] "Athens wireless metropolitan network." [Online]. Available: <http://awmn.net/content.php>
- [15] Funkfeuer. [Online]. Available: <https://www.funkfeuer.at/>
- [16] L. Navarro, R. B. Vinas, C. Barz, J. Bonicioli, B. Braem, F. Freitag, and I. Vilata-i Balaguer, "Advances in wireless community networks with the community-lab testbed," *IEEE Communications Magazine*, vol. 54, no. 7, pp. 20–27, jul 2016. [Online]. Available: <http://ieeexplore.ieee.org/document/7509374/>
- [17] A. Barolli, T. Oda, L. Barolli, and M. Takizawa, "Experimental results of a raspberry pi and olsr based wireless content centric network testbed considering openwrt os," in *2016 IEEE 30th International Conference on Advanced Information Networking and Applications (AINA)*, March 2016, pp. 95–100.
- [18] OLSR.org. [Online]. Available: <http://www.olsr.org/>
- [19] T. Clausen, C. Dearlove, and J. Dean, "IETF RFC 6130, Mobile Ad Hoc Network (MANET) Neighborhood Discovery Protocol (NHDP), IETF, 2011," 2011. [Online]. Available: <https://tools.ietf.org/html/rfc6130>
- [20] C. Dearlove and T. Clausen, "Multi-Topology Extension for the Optimized Link State Routing Protocol Version 2 (OLSRv2), RFC 7722 (Experimental)," Tech. Rep. 7722, 2015. [Online]. Available: <http://www.ietf.org/rfc/rfc7722.txt>



# Anomalies Detection Using Entropy in Household Energy Consumption Data

Marta MOURE-GARRIDO<sup>a</sup>, Celeste CAMPO<sup>a</sup> and Carlos GARCÍA-RUBIO<sup>a</sup>

<sup>a</sup>*Department of Telematic Engineering, University Carlos III of Madrid, Avda. Universidad 30, Leganés, E-28911 Madrid, Spain*

**Abstract.** The growing boom in smart grids and home automation makes possible to obtain information of household energy consumption. In this work, we study if entropy is a good mechanism to detect anomalies in household energy consumption traces. We propose an entropy algorithm based on windowing the temporal series of energy consumption. We select a trace with a duration of 3 months from the REFIT project household energy consumption data set, available open access. Entropy can adapt to changes in consumption in this trace, by learning and forgetting patterns dynamically. Although entropy is a promising technique and it has many advantages, as the traces in this data set are not sufficiently labeled to check the correct functioning of the algorithms, we propose to further validate the results using synthetic traces.

**Keywords.** entropy, anomaly, household energy consumption

## 1. Introduction

The electric demand is exponentially increasing. A good solution to manage this demand is the implementation of smart grids, that offer a more efficient energy system with the aim of protecting the environment [10]. Unlike traditional power grids, that are based on the transmission of energy from generators to end users, smart grids use two-way flows of both energy and information [5]. These grids control and manage the network through the use of information and communication technology (ICT) employing control systems and smart meters. Smart meters perform the basic functions of a traditional meter, but can also be used as sensors in the electrical distribution grid. Smart meters are advanced metering tools that obtain information from users' devices and their real-time consumption information.

This information allows to obtain traces of energy consumption both global and disaggregated (specific to each device). Besides, thanks to the information obtained from the devices and the implementation of algorithms, it is possible to detect errors in the energy system [17] and find behavior patterns based on user consumption. Anomalies in energy consumption can be detected, understanding as an anomaly a change in the usual patterns of user behavior. An anomalous behavior would be the failure of a device, a holiday period, etc. The household consumption defines the behavior of its dwellers, but it is not possible to study the behavior of an individual person from this information.

Entropy is capable of detecting anomalies. According to the Cambridge dictionary, an anomaly is “a person or thing that is different from what is usual”. In our previous works, entropy was successfully applied to geolocated traces in order to detect anomalies[7]. In that work, traces were obtained from geolocated publications of users from various social networks to detect possible anomalies as evidence of an unusual event. In the paper [15], entropy was applied to users’ locations to predict their next movement. The traces of mobility were obtained as a sequence of telephone cells captured from their mobile phones.

Following this line of research we want to study if entropy is a good mechanism for detecting anomalies in household energy consumption traces. The main advantage of the entropy-based algorithm over machine learning algorithms is that it does not have a training phase. We start with a set of data available in open access, namely household energy consumption traces from the REFIT project. To validate the results obtained, they are compared with the Random Forest algorithm, which is one of the tools used in previous works to achieve the objective of our work.

The structure of this paper is as follows. Section 2 presents an overview of some related works that apply data mining to trace data to analyze or detect patterns of consumption behavior. In Section 3, we present the data set and its curation. In Section 4, we explain the algorithm proposed and the results obtained, and we evaluate them in Section 5. Finally, we discuss the conclusions in Section 6.

## **2. Related works**

The growing boom in smart grids and home automation makes it possible to obtain information of household energy consumption. This information is stored and, as a result, traces of energy consumption are obtained, and therefore more and more energy consumption data sets are available in open access. As a result, many papers apply data mining to these data sets to analyze or detect patterns of consumption behavior.

A recent work is [16], the results of the model proposed in this article can be used to predict energy consumption and demand, and to learn patterns of energy consumption behavior. Although three data sets are provided to evaluate the proposed model, finally they use a synthetic data set.

In [14], it is shown that due to well-defined usage patterns, it is feasible to accurately predict large scale boiler usage using only smart meter readings. The error of prediction of annual energy consumption ranges from 2-3 kW h, using ANFIS (Adaptive Neuro-Fuzzy Inference System) demand prediction methodology, a type of artificial neural network.

In [9], it is demonstrated that it is possible to recognize daily domestic activities (e.g. preparing food, taking a shower) using aggregate energy consumption readings and environmental sensors. After the test phase, the proposed approach had an average accuracy of 90 %. The results show that the proposed method can correctly detect multiple household activities and estimate the energy consumption of the activities.

The two previous articles use a data set that includes energy consumption data for 20 households in Loughborough (United Kingdom) during the period 2013 - 2015, containing measures of aggregate consumption and of individual consumption of nine devices, with time stamps and a sampling frequency of 8 seconds [13]. This data set was published

by the REFIT project (<http://www.refitsmarthomes.org>), a project that aims to help reducing household energy demand. This is achieved through advice on making decisions based on data from intelligent houses. The REFIT project ran from 2012 to 2015 and it was a partnership of three UK universities, Loughborough, Strathclyde and East Anglia, and had ten industry partners to maximise the impact of the research.

The following two articles belong to the Smart\* project, whose objective is to optimize household energy consumption. In [3] they present a method to avoid the detection of occupation in a house by controlling the thermal energy. They use the storage of energy present in an electric water heater to mark whether someone is at home or not. In [1] they propose a methodology for modelling electrical loads by monitoring a variety of charges. This methodology could be used to create synthetic traces of energy consumption.

Entropy is an information theory concept, it is a way to measure the expected uncertainty of a series of symbols belonging to an alphabet. There are works that detect anomalies in various fields using entropy, some of them focus on detecting malware based on anomalous patterns in the network [2], or detecting anomalous events in videos through pattern recognition [11].

This paper proposes the use of entropy to detect anomalies in traces of household energy consumption. In this work we want to evaluate if it is possible to detect anomalies in traces of energy consumption in homes using mechanisms based on entropy, to know if something different than usual is happening in the house. Doing this, it will not be possible to detect that a specific person has a different behavior since it deals with houses and a priori it is not known if one or more persons live in the same house. In general, a family tends to behave one way Monday to Friday and another on weekends. An example of detecting something anomalous could be that the inhabitants of the home are out on vacation, that some device is defective or suffers a breakdown.

### 3. Household energy consumption traces

In order to accomplish the purpose of this work, we have analyzed traces of energy consumption from different homes to study the behavior of users. We wanted to check if entropy was capable of detecting behavior that is different or anomalous from the usual behavior of the residents of each household.

First of all, it should be mentioned that this work is based on the data set published by the REFIT project. The choice of these data set is because it is public and it contains information from some houses for quite a long time. Although the traces in this data set are not labelled, there are surveys that inform us about how many people lives in each house, or their occupational situation. In addition, the characteristics that influence energy consumption and occupation of houses that participated in the project are known. The characteristics are dwelling age, number of appliances, dwelling type and size.

Twenty households were monitored with a sampling frequency of 8 seconds. The traces contain active power measurements, measured on watts, of the household as an aggregate, as well as of 9 different devices. The houses had 10 measurement sensors, one for the household aggregate and the remaining for single device monitoring. For each house there is a file that contains the measurements taking for the monitored period. The most commonly monitored devices are fridge, freezer, washer, washing machine, dishwasher, computer and television.

It must be borne in mind that our work does not focus on an exhaustive study of the energy consumption of a house, but the main aim is to detect anomalies in consumption. The purpose is to work with a fragment of data that makes it easier to draw the most realistic conclusions possible to the problem.

### 3.1. Data processing

We process the data set in Python with the purpose to analyze the energy consumption traces. This data set needs transformations to facilitate the analysis and to be able to obtain correct results. Once the data transformation was done, as the quantity of data was excessive, we decided to resample the series in 60 minutes intervals and average the values over these intervals. In addition, we decided to remove from the data set the days for which there was no sample. We carried out these transformations in the data set with the aim to facilitate the analysis, reduce computation time and simplify searching for periods in the data set for which there are no temporary breaches.

In the data set there were many interruptions in which there were no samples. Breaks indicate periods when no measurements are available, data were not available for the study due to hardware fails, network routing problems, household mistakes, etc. On average, the uptime of the houses traces is 88% of the total monitoring time. Time breaks do not follow any pattern or have any periodicity and they are not always the same length, they can be hours or days.

These temporary breaches produce a leap in temporal continuity and this can affect the results of analysis. We had three options to cure the data, to extract the longest consecutive set without errors, to cut the pieces with errors or to fill those pieces with errors with estimated values.

The interruptions are an issue in calculating entropy because its calculation needs a temporal continuity to obtain a coherent result. Therefore we decided to select the longest period without interruptions. We got a long enough period in house 8, a period of three months from 2014-04-08 to 2014-07-01, and we use this fragment to carry out the study of household aggregate consumption. In this paper We focus on the consumption of house 8 since it is the most complete and with more data.

The devices monitored during the study period belonging to this house are fridge, freezer, washer dryer, washing machine, toaster, computer, television site, microwave and kettle. Additional information is shown in the Table 1.

**Table 1.** Additional information about the house [13]

House	Occupancy	Dwelling Age	# of Appliances	Dwelling Type	Size
8	2	1966	35	Detached	2 bed

## 4. Solution development

Entropy is a way to measure the uncertainty of a random variable. Entropy is a concept of information theory, see [6] and [4] for more information.

Be a discrete random variable  $X$  with an alphabet  $\mathcal{X}$  and is its probability function, *Probability Mass Function (PMF)*,  $p(x) = \Pr(X = x), \forall x \in \mathcal{X}$ .

$$H = - \sum_{x \in \mathcal{X}} p(x) \log_2 p(x) \quad (1)$$

Based on this equation,  $H$  is the uncertainty measure of the random variable  $X$ . Due to the logarithm in base two, the value of entropy is measured in bits.

#### 4.1. Implementation of entropy calculation

If we define the aggregate consumption of a house as a random variable, its alphabet has a very wide range of values because the consumption varies constantly. For this reason, consumption bands are useful, that is, to transform the values of the variable into discrete and ordered values in order to reduce the existing alphabet. This process will imply a decrease in the value of the entropy because there is less variation.

We apply entropy to the data set to study the evolution of energy consumption. When we calculated the entropy of the household aggregate, we observed that entropy had very small variations if we took into account the measures of consumption from the beginning to each sample,  $i$ . This is because a peak consumption or an atypical consumption lasts for a small amount of time, less than one day. Since many samples are available to estimate entropy, a longer duration outlier consumption would be needed to appreciate the variation. For this reason we calculated the entropy with a specific window size, in this case, the size of `win` is 2, 4 or 6 weeks to look at the behavioral changes taking into account these time windows. In addition, we decided to normalize entropy in order to facilitate the compression of the graphs obtained in the entropy calculation. This is an effective way to achieve good results in the comparison of graphs.

In the Figure 1 we can see four lines represented in different colors, each one is a window size. The blue line has no window, this means that the entropy is calculated from the initial moment to each sample. For this reason there are no big variations in the value of the entropy, it remains more constant than the other lines. The remaining lines suffer more variations, as the size of the window decreases the entropy experiences a greater deviation. The explanation lies in the way of calculating entropy, when there are many samples an unusual behavior with longer duration is needed. On the contrary, when there are few samples, even if an unusual behavior is short-lived, it will be reflected in the entropy result.

### 5. Evaluation of the results obtained

In this section the results will be evaluated from the graphs obtained. Information about the houses that carried out the REFIT project can be found in [8]. But, before evaluating the results, it should be noted that we do not have much information about the inhabitants of the houses. For example, we know that house 8, on which we have focused in this work, it is inhabited by a retired couple. However, this does not provide us with information about the routine of them nor does it provide knowledge about the context of the household, for instance, temperature or season.

We compare the aggregate consumption graph with the graph resulting from applying entropy. A variation in energy consumption implies a variation in entropy. On the days when consumption increases more than usual or there is a peak in consumption, the evolution of entropy also undergoes a small deviation, we see it in Figure 2.

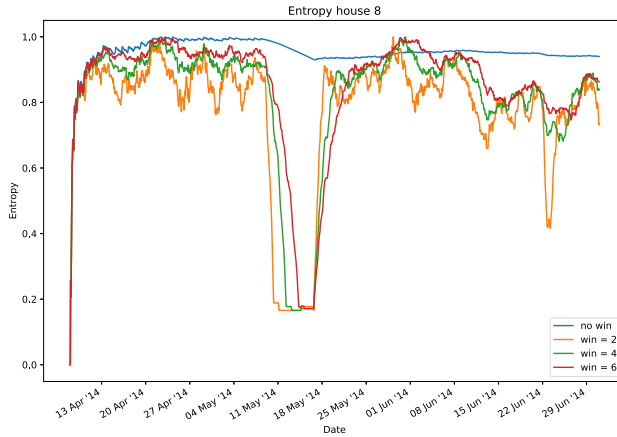
**Figure 1.** Entropy house 8

On the other hand, we study consumption behavior for each day of the week. If we take into account the hour plus the day of the week we see that the energy consumption follows a repetitive behavior. For example, in Figure 3 we see that the consumption of Wednesdays is repetitive, that is, all Wednesdays have a similar consumption.

Entropy takes into account the frequency of consumption values, an anomaly in energy consumption would be a variation in these values. It does not matter at what time the energy consumption increases if the consumption increases in a similar way.

### 5.1. Comparison of results

The traces are not sufficiently labeled to be able to know when there has been a real anomaly and to be able to check the correct functioning of the algorithms.

As we do not know if the results obtained are correct, we decided to compare with the Random Forest algorithm to validate our results. We selected this machine learning regression algorithm because it has shown good results in problems with hourly and daily repetition patterns like the one in the data set we are going to handle [12].

The aim of the prediction in a time series is learning from the past and predicting the future. To make the prediction, we divide the data set between the training set and the test set. We use fragments of four weeks duration (24 samples per day). Following the process carried out in the last reference, we used 3 weeks of training and one week of test. This division of the data set is a good percentage for machine learning algorithms.

For the prediction, we use the date as an input feature, keeping in mind the time of the day and the day of the week to the prediction, and the output feature is the aggregate consumption per hour. As a result we got a model that considers the time and day of the week and captures a periodic behavior. The model shows fairly high reliability with a  $R^2$  equals a 0.74, this result is shown in the Figure 4.

We conducted a qualitative analysis based on a comparison with the algorithm of machine learning, Random Forest. We intend to compare the results obtained and study if both algorithms detect the anomalies. In the Figure 5 we observe the evolution of entropy

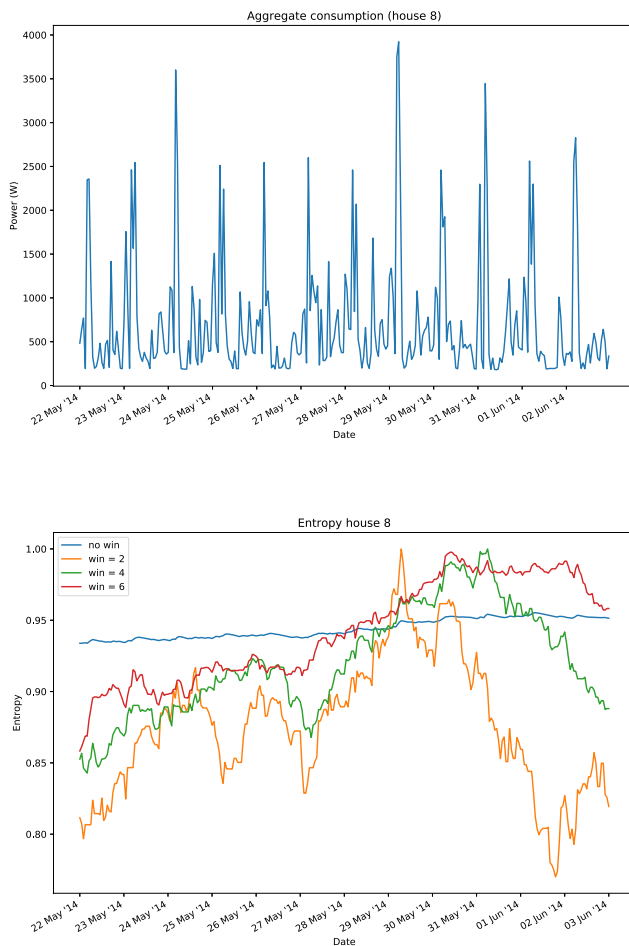
**Figure 2.** Entropy (house 8)

and the difference between the real value and the predicted value by the Random Forest algorithm, respectively.

The variation of entropy on June 22 corresponds to a discrepancy between the actual value and the value predicted by Random Forest. This means that Random Forest has incorrectly predicted the value of consumption, so we can think that something strange has happened that day. That said, it should be noted that Random Forest relies on time frequency to predict values and entropy in the frequency of consumption values. This means that if two days have the same consumption but with a time lag, entropy would not consider it an anomaly. However, the Random Forest algorithm would consider them different, and therefore, it would be considered an anomaly.

**Figure 3.** Entropy house 8 (Wednesday)

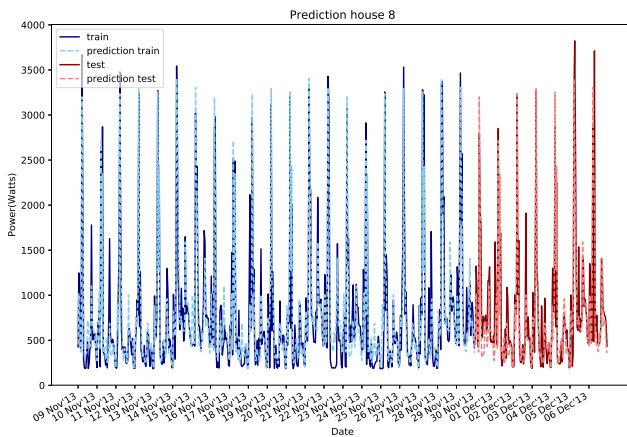
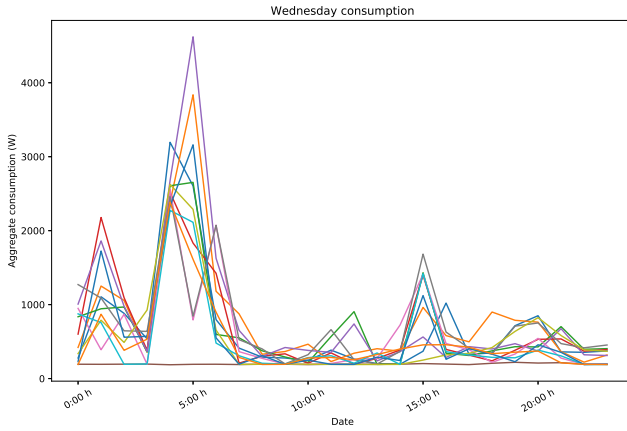

**Figure 4.** Data set prediction (feature POSIX)

### 6. Conclusions

This paper studies the possibility of detecting anomalies in traces of energy consumption by means of a technique based on entropy. An analysis of the aggregate consumption of different households is proposed in order to find unusual behaviors.

We analyzed the main advantages and disadvantage about entropy found in this research. The main advantage of the entropy-based algorithm over the automatic learning algorithm is that there is no training phase. This means that the algorithm from the beginning starts to detect anomalous behaviors. In addition, entropy can adapt to changes in consumption, based on learning and forgetting patterns dynamically. The algorithm has a minimum computational cost, in future works we will be able to validate if this algorithm is really a fast and efficient algorithm.

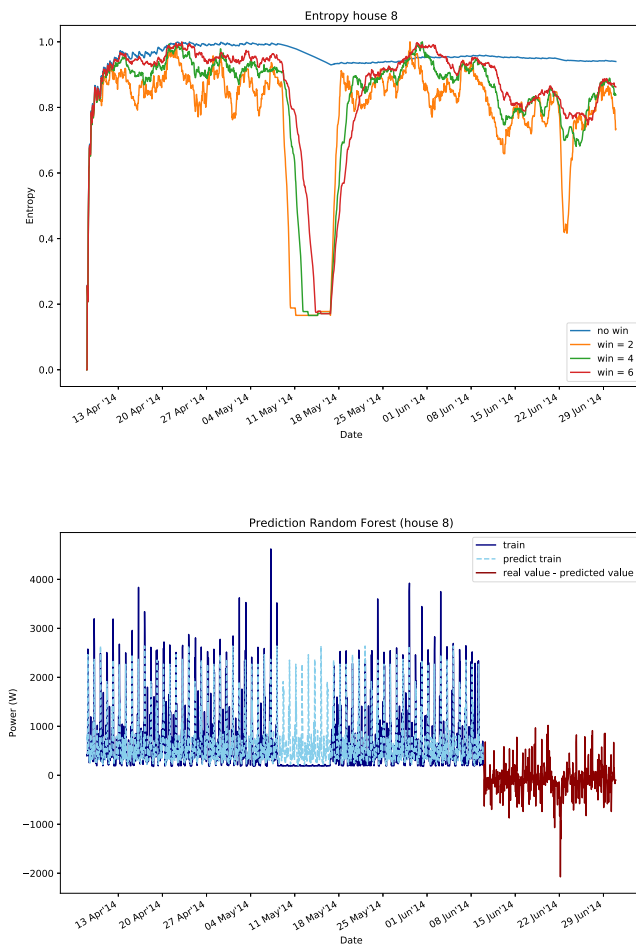

**Figure 5.** Entropy and Random Forest

The most relevant disadvantage of this algorithm is that it does not take into account the temporal frequency of the samples. Entropy measures the frequency of occurrence of events. In practice, this means that consumption samples are independent of time. On the contrary, Random Forest algorithm can detect time and day-dependent user behavior patterns. In short, entropy does not find such precise temporal routine changes. However, we do not need this precision to study anomalies in energy consumption traces.

On the other hand, it is important to emphasize that an exhaustive analysis of energy consumption cannot be carried out without information on household devices and information on the inhabitants as well as on their routine. For example, device failure, holiday periods, family visits, etc. This is because changes in consumption behavior will be found but it will not be known why they occur.

Therefore, although entropy is promising and has many advantages, it is necessary to validate the results obtained on synthetic traces. For this reason it would be very significant to obtain a collection of energy consumption traces from households where there is

comprehensive information on the behavior of the inhabitants of the houses. In this way, all the necessary information would be available to carry out an analysis, and anomalous events or periods could be forced to validate the proposed algorithm. As a future work, one option is the creation of synthetic traces from real traces to obtain a more extensive data set and with a greater amount of information. Traces would be created following patterns and setting limits obtained from real traces.

## Acknowledgments

This research was partially funded by the Ministry of Economy and Competitiveness through TEC2017-84197-C4-1-R and by the Comunidad de Madrid (Spain) under the project CYNAMON (P2018/TCS-4566), co-financed by European Structural Funds (ESF and FEDER).

## References

- [1] Sean Barker, Sandeep Kalra, David Irwin, and Prashant Shenoy. Empirical characterization and modeling of electrical loads in smart homes. In *2013 international green computing conference proceedings*, pages 1–10. IEEE, 2013.
- [2] Przemysław Berezziński, Bartosz Jasiul, and Marcin Szpyrka. An entropy-based network anomaly detection method. *Entropy*, 17(4):2367–2408, 2015.
- [3] Dong Chen, David Irwin, Prashant Shenoy, and Jeannie Albrecht. Combined heat and privacy: Preventing occupancy detection from smart meters. In *2014 IEEE International Conference on Pervasive Computing and Communications (PerCom)*, pages 208–215. IEEE, 2014.
- [4] Thomas M Cover and Joy A Thomas. *Elements of information theory*. John Wiley & Sons, 2012.
- [5] Xi Fang, Satyajayant Misra, Guoliang Xue, and Dejun Yang. Smart grid—the new and improved power grid: A survey. *IEEE communications surveys & tutorials*, 14(4):944–980, 2011.
- [6] Yun Gao, Ioannis Kontoyiannis, and Elie Bienenstock. Estimating the entropy of binary time series: Methodology, some theory and a simulation study. *Entropy*, 10(2):71–99, 2008.
- [7] Carlos Garcia-Rubio, Rebeca Díaz Redondo, Celeste Campo, and Ana Fernández Vilas. Using entropy of social media location data for the detection of crowd dynamics anomalies. *Electronics*, 7(12):380, 2018.
- [8] Tom Hargreaves, Charlie Wilson, and Richard Hauxwell-Baldwin. Learning to live in a smart home. *Building Research & Information*, 46(1):127–139, 2018.
- [9] Jing Liao, Lina Stankovic, and Vladimir Stankovic. Detecting household activity patterns from smart meter data. In *2014 International Conference on Intelligent Environments*, pages 71–78. IEEE, 2014.
- [10] William A Mogel. Smart power: Climate change, the smart grid and the future of electric utilities. *Energy Law Journal*, 31(1):183, 2010.
- [11] LM Molnár, Sz Nagy, and I Mojzes. Structural entropy in detecting background patterns of afm images. *Vacuum*, 84(1):179–183, 2009.
- [12] Andreas C Müller, Sarah Guido, et al. *Introduction to machine learning with Python: a guide for data scientists*. ” O’Reilly Media, Inc.”, 2016.
- [13] David Murray, Lina Stankovic, and Vladimir Stankovic. An electrical load measurements dataset of united kingdom households from a two-year longitudinal study. *Scientific data*, 4:160122, 2017.
- [14] DM Murray, J Liao, L Stankovic, and V Stankovic. Understanding usage patterns of electric kettle and energy saving potential. *Applied Energy*, 171:231–242, 2016.
- [15] Alicia Rodriguez-Carrion, Carlos Garcia-Rubio, and Celeste Campo. Detecting and reducing biases in cellular-based mobility data sets. *Entropy*, 20(10):736, 2018.
- [16] Shailendra Singh and Abdulsalam Yassine. Big data mining of energy time series for behavioral analytics and energy consumption forecasting. *Energies*, 11(2):452, 2018.
- [17] Hahn Tram. Technical and operation considerations in using smart metering for outage management. In *2008 IEEE/PES Transmission and Distribution Conference and Exposition*, pages 1–3. IEEE, 2008.

# Monitoring Electricity Consumption Based on Time Series Analysis

Rebeca P. DÍAZ REDONDO<sup>a,1</sup>, Ana FERNÁNDEZ VILAS<sup>a</sup> and  
Alberto ESTÉVEZ CALDAS<sup>a</sup>

<sup>a</sup>*Information & Computing Lab, AtlanTTIC Research Center, University of Vigo, Spain*

**Abstract.** Smart meters provide fine-grained accurate readings that can be analysed for a more efficient energy consumption monitoring. Using the energy readings as input data, we seek to obtain building energy consumption patterns, to detect anomalies in these patterns and to compare patterns from different buildings. With this aim, we introduce a hybrid methodology that combines several techniques based on time series analysis: (i) statistical and visualization approaches, (ii) techniques for decomposing time series, (iii) algorithms for checking the consistency and fluctuation of the data and (iv) algorithms for comparing time series shapes. Our experiments used a large data set that gathers the energy readings from different buildings in a university campus.

**Keywords.** smart meter, smart grid, time series analysis, approximate entropy, seasonal ESD, FastDTW

## 1. Introduction

The Smart Grid combines advances in both electric engineering and information and communication technology with the aim of defining a unified system for control, maintenance and management of the electricity grid. Within this new scenario, national and European regulations have strongly encouraged companies to update their systems to improve the efficiency of the energy management. One of the elements that support monitoring the energy consumption are smart meters. The potentiality of these devices goes far beyond the capabilities of the traditional metering devices. The later focused on providing the information needed for billing purposes. However, smart meters provide fine-grained accurate readings (even every minute) and send this data in real time to a central system. The advantages of energy real-time readings are twofold: for consumers and for energy companies. Consumers would be aware of their energy consumption to adopt new consumption strategies. Energy companies would infer consumption patterns and predict needs and potential peaks of activity to establish appropriate energy plans and the best fees. In fact, this data may support deeper analysis of individual and collective consumption for householders, buildings or even neighborhoods that would detect possible failures in electronic systems or falsified metering [9]. What is more, it would be pos-

---

<sup>1</sup>Corresponding Author: Rebeca P. Díaz Redondo. Information & Computing Lab, AtlanTTIC Research Center, University of Vigo, Campus Universitario de Vigo, s/n, 36310, Vigo, Pontevedra, Spain; E-mail: rebeca@det.uvigo.es

sible to provide more accurate predictions on real-time fluctuations [1], which already reflect moments of human activity. This information would be used to prevent failures in the grid before they affect the consumer, to prevent attacks on the electricity distribution infrastructure [11] and to foresee finer adjustment of the system and increases energy efficiency.

In this paper, we introduce a methodology that combines different time series analysis techniques to identify consumption patterns for energy consumption in buildings, using as source of data the readings provided by smart meters. Our objective is to obtain building energy patterns, to detect anomalies in the energy consumption and to compare energy patterns from different buildings. With the aim of validating our proposal, we have used real energy readings from different buildings at the University of Vigo (Spain).

This paper is organized as follows. Sect. 2 describes the technologies used and the data set for the experiments. Then, in Sect. 3 we describe the steps we followed for our study and the results obtained. Finally, in Sect. 4 we detailed our future work.

## 2. Materials and Methods

For our purpose, we have used different techniques used to analyse time-series, since this is the usual mathematical representation for the energy consumption readings available from smart meters. These techniques are described in Sect. 2.1, whereas in Sect. 2.2 we described the dataset that we have used for our analysis.

### 2.1. Background

For our analysis, we have used time-series analysis. A time series is a sequence of discrete-time data taken most commonly at successive equally spaced points in time. Time series can be stationary, if its trend is constant over time, or non-stationary, if it changes over time. They can have stationary effects if certain trends occur repeatedly at the same points in time. In general, a time series  $x_t$  can be decomposed as a function of the following three components: trend, seasonality and irregularity or noise. *Trend* model the long-term progression of the series; thus, increase, decrease or stationary patterns can be identified. *Seasonality* models the behaviour that occurs at regular intervals in a series. These patterns may vary but, while trends disappear after a period of time, seasonality occurs within a regular period. Finally, *irregularity or noise* usually represents unexpected behaviour, i.e. the unpredictable part of the series. The two most popular models for decomposition of time series are (i) the additive model and (ii) the multiplicative model. The former suggests that the mentioned components are added together to create the time series ( $y(t) = trend(t) + seasonality(t) + noise(t)$ ). It is considered the most appropriate if the magnitude of the seasonal fluctuations of the series does not vary when the trend varies. The latter suggests that the components are multiplied to create the time series ( $y(t) = trend(t) * seasonality(t) * noise(t)$ ). This is more appropriate if the magnitude of the seasonal fluctuations of the series increases and decreases proportionally to the trend.

In our study, we are going to use the following techniques to analyse time-series: Approximate entropy, Seasonal Hybrid ESD and FastDTW; which will be describe in the following subsections.

### 2.1.1. Approximate entropy

Approximate entropy technique was developed [5] to measure the regularity of the values in time series, as well as to measure the unpredictability of the fluctuations. Based on entropy analysis, approximate entropy reflects the likelihood between different patterns of observations that are partially similar. Thus, a time series that contains many repetitive patters has a relatively small value of approximate entropy, whereas another one that represents a less predictable sequence has a higher value of approximate entropy. Se assume a given set of  $N$  samples gathered over time (same frequency) and represented as a vector:  $u(x) = [u(1), u(2), \dots, u(N)]$ . Besides, in the approximate entropy technique a moving window of size  $m$  samples is defined to check the regularity over time. Approximate entropy is formally defined as:

$$ApEn = \phi^m(r) - \phi^{m+1}(r)$$

where  $\phi^m(r) = (N - m + 1)^{-1} \sum_{N-m+1}^{i=1} \ln(C_i^m(r))$  and  $C_i^m$  represents the distance or proximity between similar samples but at different points of the time series. For this, a sequence of vectors  $x(1), x(2), \dots, x(N - m + 1)$  are created from the original vector or time series  $u(x)$  using the moving window of size  $m$ . Each of these vectors can be defined as  $x(i) = u(i), u(i + 1), \dots, u(i + m - 1)$ . Thus,  $C_i^m$  is obtain as the number of these vectors ( $x(1), x(2), \dots, x(N - m + 1)$ ) whose distance is less than an input parameter  $r$ . The distance is defined as follows:  $d[x(i), x(j)] = \max|u(i + k - 1) + u(j + k - 1)|$  and represents the distance between two vectors  $x(i)$  and  $x(j)$  given by the highest difference between their respective scalar components. Parameter  $r$  is usually known as the coincidence acceptance tolerance. Thus,  $m$  gives information about the length of compared data and  $r$  specifies the filtering level

### 2.1.2. Seasonal Hybrid ESD

The Seasonal Hybrid ESD (*Extreme Studentized Deviate*) algorithm [12] [13] is an anomaly detection algorithm that uses time series decomposition to extract the residual component of the time series and then applies the ESD procedure [6] to detect unexpected values. Using these two steps, this procedure is able to detect two kinds of anomalies: (i) global, i.e. beyond the expected seasonal maximum and minimum, and (ii) local, i.e. those that would remain hidden by seasonality. The Seasonal Hybrid ESD receives two inputs: the time series ( $u(x) = [u(1), u(2), \dots, u(N)]$ ) and the number of iterations to be performed in the ESD test. The output will be a vector of anomalies detected by the procedure. First, the algorithm extracts the seasonal component  $S_x$ , by applying a time series decomposition. Then, it calculates the median of the original data  $u(x)$  and the residual value , this information will be used by the ESD algorithm to obtain the result: the anomalies vector.

The ESD algorithm is a generalization of the Grubbs test [4] and only needs the upper bound on the number of anomalies to work  $k$ . First, the ESD algorithm computes the following test statistic for the  $k$  most extreme values in the data set (time series):  $C_k = \frac{\max_k |u_k - \bar{u}|}{s}$ , where  $\bar{u}$  represents the sample mean and  $s$  represents the sample standard deviation, respectively. Then, the test statistic is compared with a critical value computed as follows:

$$\lambda_k = \frac{(n-k)t_{p,n-k-1}}{\sqrt{(n-k-1+t_{p,n-k-1}^2)(n-k+1)}} \quad k = 1, 2, \dots, r$$

if the value is considered anomalous, it is removed from the data set and the critical value is recalculated from the remaining data. This process is repeated  $k$  times, classifying values as anomalies if they meet the condition  $C_k > \lambda_k$ .

### 2.1.3. FastDTW

The DTW (*Dynamic Time Warping*) algorithm [10] [2] compares time series could be "warped" non-linearly in the time dimension in order to find the optimal alignment between them. It is often used to check similarities among time series, to perform classification tasks and to find out corresponding regions between two series of data. The main drawback of this algorithmic approach is its complexity,  $O(N^2)$ , which entails a really computation load and resolution time for long time series, such as those with thousands of samples. However, in the literature, there is a variation known as FastDTW [7].

FastDTW, indeed, has a linear time and space complexity  $O(N)$  and it uses a multi-level approach that recursively obtains a solution from a coarse resolution and refines the projected solution. FastDTW obtains good results that improve the accuracy over other existing methods in the literature. The FastDTW algorithm is organized into three levels. The first one, or *coarsening or reduction phase* reduces the time series into a smaller time series that represents the same shape as accurately as possible according to the demanded resolution. This process is repeated different times using different resolution values. The second one, also known as *projection phase*, finds the minimum distance warp path at the lowest resolution. This warp path is used as initial point for guessing the minimum distance warp path for higher resolution time series. Finally, the third phase, or *refinement*, refines the warp path project from the lower resolution time series through local adjustments of the warp path.

## 2.2. Dataset

Building name	Samples	Building name	Samples
Telecomm. Engineering School	52,632	Central Library	52,632
Faculty of Biology	52,632	Filomena Dato	17,520
Industrial Eng.School (city centre)	52,632	Industrial Eng. School (Campus)	52,632
CACTI	17,520		

**Table 1.** Available data per building

For our analysis, we gathered data from the energy consumption at the University of Vigo between 2014 and 2018 (four years) from different buildings (laboratory buildings, classroom buildings, administrative buildings, etc.) and with a frequency of 1 hour. The data was aggregated and so, the first step was cleaning and organizing the data in order to split it into readings from different energy meters and buildings. In order to do so, we have used the MPAN identifier (*Meter Point Administration Number*) to obtain tables

that include the date and time, and the energy consumption (kWh). The actual volume of available data is summarized in Table 1.

The hourly consumption data from each building was organized to obtain the time series, one per building in Table 1, and an initial exploratory analysis (statistical, and visualization) was one to identify the main characteristics of the data. Visualization of the data helps to understand the trend and seasonality of the time series, and it was easy to perceive the evolution of energy consumption in days, weeks and seasons (terms and tuition and non-tuition periods). Besides, and as expected, we have visually perceived the existence of outliers in the data by using simple boxplots. Additionally, we have worked using the information available about the most relevant events and holidays that may infer in the energy consumption in the campus per year (Table 2 summarizes this data for 2018).

Date	Event	Date	Event
25-03-2018 - 01-04-2018	Easter	01-05-2018	Labour Day
21-05-2018	Heatwave	17-05-2018	Galician Literature Day
25-07-2018	Feast of St. James	15-08-2018	Local public holiday
12-10-2018	National public holiday in Spain	01-11-2018	All Saints' Day

**Table 2.** Main events during 2018 that may affect the energy readings

### 3. Methodology and Results

The electricity consumption time series are non-stationary, as they have a trend variance over time. These data often present stationary effects, since it is possible to identify behaviours that recur periodically at certain periods, such as holidays or weekends. Several methods of time series analysis are available, depending on the objectives pursued. The goals, in this case are: on one hand, to determine the trends of the data and detect the possible anomalies; and, on the other hand, to compare consumption patterns according to the type of building.

Our proposal is applying the following steps for the analysis of the energy readings time series. First, as it is usually needed, we have prepared and cleaned the data set for the analysis. We have checked the available data and organized the information into different time series: one per building. Then, we have faced the trends of these time series. For this, we have applied statistical and visualization approaches, as well as techniques for decomposing time series, which give us information about the distribution of the data and the potential outliers. After that, we have focused on analysing the consistency and fluctuation of the data. With this aim, we have applied entropy-based techniques and S-H ESD algorithm (Sect. 2.1.1 and 2.1.2). Finally, we have compared the information from different buildings, to highlight the difference in the consumption patterns. For this objective, we have used the FastDTW algorithm (Sect. 2.1.3).

The obtained results are actually organized according to these three steps and focus on two specific buildings of the University of Vigo, the Telecommunication Engineering School (TES) and the Central Library (CL), since these two represent two different kinds of consumption patterns: a building dedicated to tuition and laboratories and another one dedicated to administrative tasks.

### 3.1. Consumption analysis: Trends

The initial exploratory analysis (2013-2018) concluded with the summary of Table 3, showing a higher consumption in the Central Library and a higher standard deviation (almost 50% higher). The yearly boxplots of the two buildings (Fig. 1) shows an increment in consumption in the TES from 2013 to 2015. However, from 2016 on, the median, the interquartile range and the consumption peaks decrease. In the Central Library, the average consumption increases from 2014 to 2017, but both median and the interquartile range do not have a clear pattern. In 2018 both parameters decreased.

Parameter	Telecommunication Engineering School (kWh)	Central Library (kWh)
Mean	93.458955	125.133373
Dev. Standard dev.	28.913021	43.324626
Min.	0	5
25%	73	89
50%	85	118
75%	112	147
Max.	212	288

**Table 3.** Statistical characterization of the consumption data

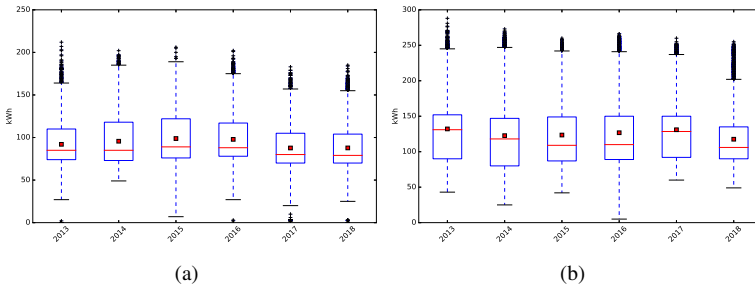

**Figure 1.** Yearly boxplot: (a) Telecommunication Engineering School and (b) Central Library

The boxplot for specific days of the week (figure 2) shows that the consumption median stays stable in both buildings during business days (from Monday to Friday). The consumption peaks and the interquartile range, however, show slight variations. The interquartile range in the TES shows similar values on Mondays, Tuesdays and Thursdays, whereas they are lower on Wednesdays and Fridays. As expected, the consumptions are lower on non-working days in both buildings. A lower interquartile range and some outliers are also detected in these days. This could represent an extraordinary activity in the TES, and opening hours during public holidays -in preparation for examination periods- in the Central Library.

We have used the multiplicative decomposition time series approach [3] for our time series. Being more specific, we have used the Statsmods [8] provided within the Python libraries<sup>2</sup>. The decomposition (Fig. 3) confirm the consumption trends obtained in our first statistical approach. For the TES specifically, a slight increasing trend in

<sup>2</sup><https://www.statsmodels.org/stable/index.html>



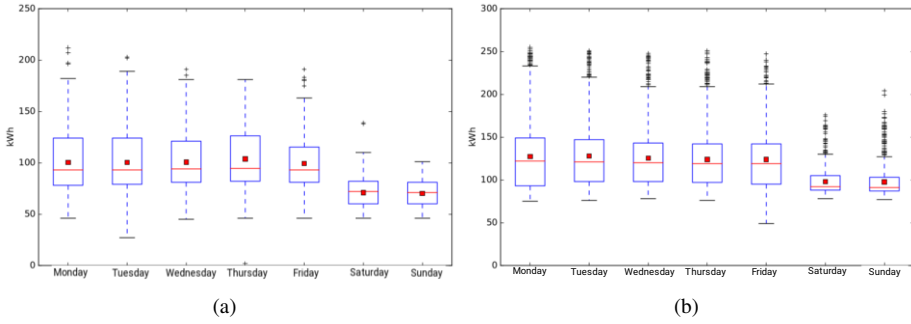

**Figure 2.** Boxplot for different weekdays: (a) Telecommunication Engineering School and (b) Central Library

consumption can be seen until the beginning of 2015. In that year the trend is roughly horizontal and from 2016 on the trend starts to decrease until September 2017, when the teaching activity restarts and the trend changes. A new period of decreasing trend starts in 2018 and continues until the next academic year. Thus, the consumption in the TES presents a recurring yearly pattern: it shows an increasing trend that starts at the beginning of the academic year and lasts until the end of the first term; the beginning of the new calendar year marks the start of a decreasing trend, which is especially noticeable when the academic year ends. There is also a clear consumption pattern in the Central Library. The consumption values remain stable from the beginning of the year until June. This month starts a decreasing trend that lasts until September. The trend increases from this month until the end of the year.

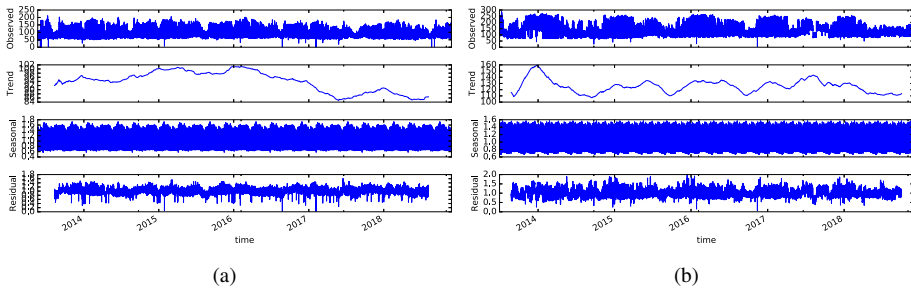
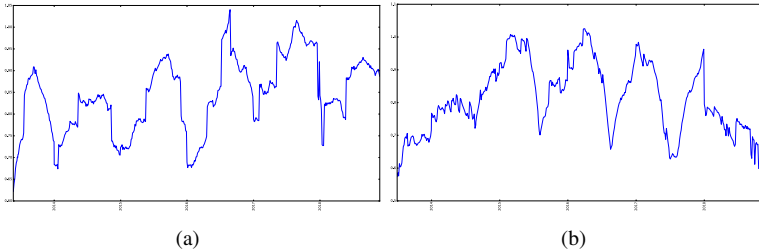

**Figure 3.** Decomposition of time series: (a) Telecommunication Engineering School and (b) Central Library

### 3.2. Consumption analysis: anomalies

Regularity and fluctuations of the data were analysed by using the approximate entropy algorithm (Sect. 2.1.1). We have performed a tuning procedure to select the window size that was finally set at 2 months (1,344 hours) and the results are depicted in Fig. 5. The entropy peaks are detected in July, August and September, which can be explained by the end of the teaching activities, the activation of the air conditioning and the subsequent start of the new academic year, respectively. Then the patterns become more regular and entropy starts to decrease in the TES until it reaches its minimum at the end of the year. This is due to the Christmas period, when the staff of the TES leaves for holidays.

Another significant increase in the approximate entropy is detected every year at the end of May. This probably results from the examination period of the second term in the school. Entropy in the Central Library reaches minimum values in September, whereas April and May show maximum values.



**Figure 4.** Approximate entropy analysis: (a) Telecommunication Engineering School and (b) Central Library

In order to automatically detect these outliers, we have used the S-H ESD algorithm (Sect. 2.1.2), setting the input parameter (maximum number of anomalies) at 200 (i. e. 200 iterations). In Fig.5 are depicted the results in 2018 for both buildings. The data from the TES reflects local anomalies around August and the data from the Digital Library detects local anomalies between January and February, which are probably related to the geothermal heating system. The global anomalies in both buildings are coherent with the potential reasons summarized in Table 2. Finally, other anomalies have been detected in both time series, but there is not enough information to indicate a specific causes.

### 3.3. Comparative analysis

We have compared the time series of the two buildings during 2018. First we have obtained their trends and, then, we have applied the FastDTW algorithm (Sect. 2.1.3). Both building trends (Fig. 6(a) and 6(b)) decrease at the first quarter of the year. Whereas this decreasing trend continues in the Central Library, in the TES it flattens. Both trends are very similar from June to the End of the year, although the changes are significantly higher in the TES. The analysis done with the FastDTW algorithm (Fig. 7) verifies what the previously mentioned figures graphically show: the trends stay very similar in both of them until April; from then and until mid-July the values from the Central Library and those from the TES differ (the consumption is lower in the first building); this gap widens significantly from July on (this difference could be caused by the end of the examination period); finally, when the new academic year starts, the trends in both buildings become similar again.

## 4. Conclusions

The data collected by smart meters opens new challenges in the energy consumption management. In this paper, we focused on consumption monitoring by analysing the energy readings from different meters in different buildings in a university campus. We have concluded that the joint application of well-know techniques for time series allows us to obtain consumption patterns, detect anomalies and compare the energy performance

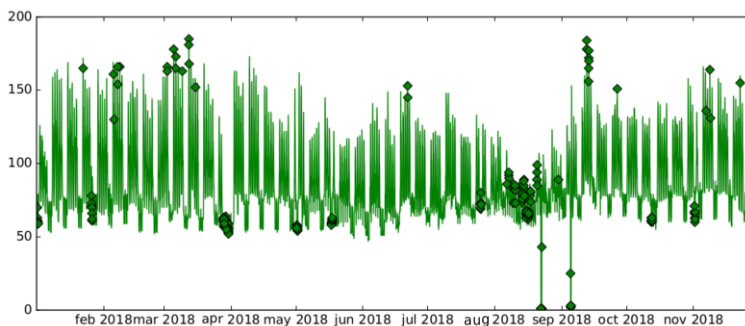

(a)

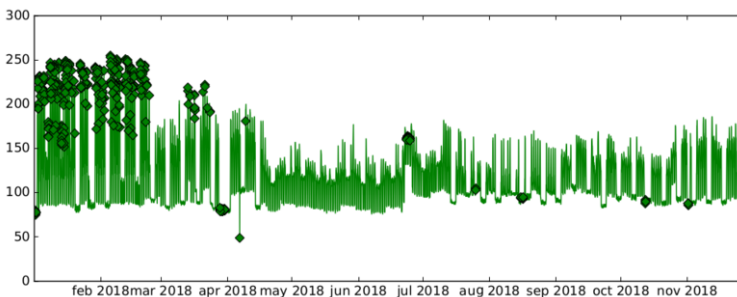

(b)

**Figure 5.** S-H ESD anomaly analysis in 2018: (a) TSE and (b) Central Library

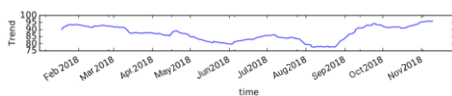

(a)

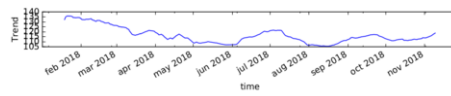

(b)

**Figure 6.** Trends: (a) Telecommunication Engineering School and (b) Central Library

of different buildings. Our analysis applied (i) statistical and visualization approaches, (ii) techniques for decomposing time series, (iii) algorithms for checking the consistency and fluctuation of the data (approximate entropy and Seasonal ESD) and (iv) algorithms for comparing time series shapes (FastDTW algorithm). Using a set of already known dates that could cause changes in the energy readings, we have found that all of them were detected by the algorithms used. We are currently working of extending this analysis to other buildings and to discover, applying clustering techniques, different patterns of energy consumption.

**Acknowledgment**

The authors would like to thank the European Regional Development Fund (ERDF) and the Galician Regional Government, under the agreement for funding the AtlanTTIC Re-

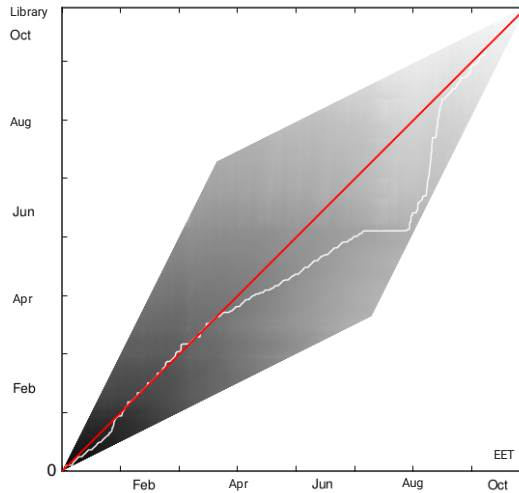

**Figure 7.** Comparison using *FastDTW*

search Center, and the Spanish Ministry of Economy and Competitiveness, under the National Science Program (TEC2017-84197-C4-2-R)

## References

- [1] Francesco Benzi, Norma Anglani, Ezio Bassi, and Lucia Frosini. Electricity smart meters interfacing the households. *IEEE Transactions on Industrial Electronics*, 58(10):4487–4494, 2011.
- [2] Donald J Berndt and James Clifford. Using dynamic time warping to find patterns in time series. In *KDD workshop*, volume 10, pages 359–370. Seattle, WA, 1994.
- [3] Jianguang Deng and Panida Jirutitijaroen. Short-term load forecasting using time series analysis: A case study for singapore. In *2010 IEEE Conference on Cybernetics and Intelligent Systems*. IEEE, 2010.
- [4] F. E. Grubbs. Sample criteria for testing outlying observations. *Ann. Math. Statistics*, 21:27–58, 1950.
- [5] Steven M Pincus. Approximate entropy as a measure of system complexity. *Proceedings of the National Academy of Sciences*, 88(6):2297–2301, 1991.
- [6] Bernard Rosner. Percentage points for a generalized esd many-outlier procedure. *Technometrics*, 25(2):165–172, 1983.
- [7] Stan Salvador and Philip Chan. Toward accurate dynamic time warping in linear time and space. *Intelligent Data Analysis*, 11(5):561–580, 2007.
- [8] Skipper Seabold and Josef Perktold. Statsmodels: Econometric and statistical modeling with python. In *Proceedings of the 9th Python in Science Conference*, volume 57, page 61. Scipy, 2010.
- [9] John E Seem. Using intelligent data analysis to detect abnormal energy consumption in buildings. *Energy and buildings*, 39(1):52–58, 2007.
- [10] Pavel Senin. Dynamic time warping algorithm review. *Information and Computer Science Department University of Hawaii at Manoa Honolulu, USA*, 855(1-23):40, 2008.
- [11] Chunming Tu, Xi He, Zhikang Shuai, and Fei Jiang. Big data issues in smart grid—a review. *Renewable and Sustainable Energy Reviews*, 79:1099–1107, 2017.
- [12] Rafael G Vieira, Marcos A Leone Filho, and Robinson Semolini. An enhanced seasonal-hybrid esd technique for robust anomaly detection on time series. In *Anais do XXXVI Simpósio Brasileiro de Redes de Computadores e Sistemas Distribuídos*. SBC, 2018.
- [13] Zheng Yi Wu, Yekun He, and Qiao Li. Comparing deep learning with statistical control methods for anomaly detection. In *WDSA/CCWI Joint Conference Proceedings*, volume 1, 2018.

# On the Automation of Auditing in Power Grid Companies

Sergio CHICA-MANJARREZ <sup>a,1</sup>, Andrés MARÍN-LÓPEZ <sup>a</sup>,  
Daniel DÍAZ-SÁNCHEZ <sup>a</sup>, and Florina ALMENARES-MENDOZA <sup>a</sup>

<sup>a</sup>*Telematic Engineering Department, Universidad Carlos III de Madrid, Leganés, Madrid, Spain*

**Abstract.** Auditing is a common task required to secure networks. This becomes of utter importance in power grid companies, the authorities of electricity supply. An increasing number of connected devices makes the use of semi automatic or fully automated auditing imperative. The inventory system has to incorporate the auditing results and subsequently integrate them in the security assessment of the company. The risk metrics incorporate the severity of exposures and facilitate the selection of vulnerabilities that have to be mitigated, according to the risk appetite of the company. This automatic approach has to address scale and privacy issues of large companies. In addition, connections from foreign domains that carry out the auditing involve additional risks that must be considered to effectively test the likelihood and depth of the found vulnerabilities.

In this paper we discuss the requirements of an automatic auditing system and present AUTOAUDITOR, a highly configurable module which allow companies to automatically perform pentesting in specific assets.

**Keywords.** security, privacy, auditing, scalability, containers.

## 1. Introduction

Auditing is one of the common tasks required to secure networks. In power grid companies, the growing number of connected devices requires an automatic or semi automatic approach to auditing.

To facilitate continuous security assessment, auditing has to be integrated with the inventory system, which has to reflect the actual assets of the company together with the metadata containing the security information: releases and patch status history, known vulnerabilities and their respective severity information. The risk metrics incorporate the severity of exposures and will facilitate the selection of the vulnerabilities that have to be mitigated, according to the risk appetite of the company.

The integration of auditing with the inventory system requires an automatic or semi automatic approach to achieve the continuous monitoring required for the security assessment. Furthermore, automatic approaches have to address scale, privacy issues and handle the heterogeneity of equipment and networks of power grid companies. In case

---

<sup>1</sup>Corresponding Author: Telematic Engineering Department, Universidad Carlos III de Madrid, Leganés, Madrid, Spain. Email: schica@pa.uc3m.es

of outsourced study, i.e. a security company, connections from foreign domains carrying out the auditing involves additional risks and extra work for IT allowing controlled but potentially harmful malware required to effectively test the likelihood and depth of the found vulnerabilities.

This paper addresses an automated solution which may be part of an automated security control assessment, as described in NISTIR-8011 Volume 3 and 4 [1,2].

We have already mentioned that an automated solution is easier to integrate in the inventory system and in the continuous monitoring processes. Besides controlling and replicating the automated auditing is cheaper, faster and scales better than manual auditing. Also it can be conducted easily in isolated environments where the costs involved in manual intervention are expensive.

In section 2 we present related automatic auditing systems, some of them using machine learning. We will discuss the benefits of an initial manual audit performed by an expert, that is automatically configured and adapted to test devices in heavily segmented networks with monitored and restricted access. In section 3 we discuss the requirements of an automatic auditing system in the field. In section 4 we present the main aspects of the design of the proposed AUTOAUDITOR, a highly configurable auditing system which allows a company to automatically perform pentesting in specific assets. Finally we presents some results and draw some conclusions.

## 2. Related Work

Security assessment is being a great challenge for all stakeholders in smart grid ecosystem, e.g., operators, developers, governments, regulators, technology vendors, consumers, etc., because interconnection between legacy infrastructures with Internet exposes the grid to a multitude of risks. Security assessment is defined as “a circular process of assessing assets for their security requirements, based on probable risks of attack, liability related to successful attacks, and costs for ameliorating the risks and liabilities”, according to the standard developed for handling the security of power systems and associated information exchange, IEC TS 62351 [3].

The US National Institute of Standards and Technology (NIST) and the Dept. of Homeland Security (DHS) are working in defining capabilities of automation support for ongoing security control assessments such as software asset management (SWAM) [1] and software vulnerability management (VULN) [2]. Security control assessment is a crucial part to manage information security risks across a company. Risk management is a complex and multifaceted activity, which starts establishing a realistic “risk frame” where assumptions about threats, vulnerabilities, consequences/impact and likelihoods are identified, followed by information security assessment and monitoring [4]:

- *Software Asset Management* capability is defined as part of Continuous Diagnostics and Mitigation (CDM) process. Its main purpose is to control risk created by unmanaged or unauthorized software installed on a supervised network. The authorized software installed on every device is inventoried and can be as small as a line of source code or as large as a software suite made up of multiple products, thousands of individual executables, and countless lines of code, e.g., firmware, BIOS, operating systems, applications, services and malware. Thus, a software as-

set is usable and automated, being described in terms of Common Platform Enumeration (CPE) names.

CPE is a standardized method of describing and identifying classes of applications, operating systems, and hardware devices present among an enterprise's computing assets. For that, the use of software identification (SWID) tags for identifying software installed is included. A CPE name includes at least four unique attributes: part, vendor, product and version, and four additional attributes: language, sw\_edition, target\_hw and update. These second group of attributes are used to identify where software vulnerabilities may be found.

SWAM supports vulnerability management and configuration settings management. Likewise, it directly supports Hardware Asset Management (HWAM), because checking software asset requires to know where it was or should be installed.

- *Software Vulnerability Management* addresses defects present in software on the network. Thus, once software and hardware are part of the inventory, VULN capability provides visibility into the vulnerabilities in software authorized to operate or access to the company's network(s), in order to manage and patch them in an appropriate manner. Vulnerable software is software in use on a system that has a vulnerability, but has not yet been patched or otherwise mitigated, being a key target of attackers in order to initiate an attack [2]. VULN manages and assesses directly two kinds of software flaws: Common Vulnerabilities and Exposures (CVEs), whose program works with software providers, vulnerability coordinators, bug bounty programs, and vulnerability researchers to provide a list of publicly disclosed vulnerabilities, and Common Weakness Enumeration (CWE), which provides identifiers for weaknesses that result from poor coding practices and have the potential result in software vulnerabilities.

Researchers, developers and industry have developed tools for automating these capabilities. The project Software Assurance Marketplace (SWAMP) led by Prof. Miron Livny at the Morgridge Institute for Research at the University of Wisconsin, Madison, offers a service to provide continuous software assurance capabilities to researchers and developers. They also offer a self-contained, standalone version of SWAMP[5]. Besides this tool, there are many other available, some of them as part of the Blackhat arsenal or/and Kali, which try to automate mainly vulnerability assessment such as:

- *DeepExploit*[6] is a fully automated penetration test tool linked with Metasploit. It initially launches a nmap scan and from the OS guess and ports discovery it launches an automated attack. Among the execution possibilities, it may be launched in a self-learning mode (using reinforcement learning).
- *VAPT framework*[7] is an automated Vulnerability Assessment and Penetration Testing tool that identifies vulnerabilities, retrieves exploits from open databases, e.g., ExploitDB, and performs penetration tests. The results are stored in graph-based database, Neo4j, at each stage.
- *APT2*[8] is a console-based Automated Penetration Testing Toolkit, whose results are stored locally and used to launch exploits and enumeration modules. This performs a nmap scan or import the results of other scanners.
- *Archery*[9] uses open source web and network vulnerability scanners (e.g., zap, nmap, openvas, selenium, etc.) to create a vulnerability assessment and management tool.

- *Lynis*[10] is a shell-script that runs on \*NIX-based operating systems. It is an extensible security audit and vulnerability analysis tool, which performs security tests to check configuration errors, software vulnerabilities, or weaknesses, in order to perform vulnerability assessments and penetration tests.
- *CROZONO framework*[11,12] allows gathering information about possible attack vectors and performing automated penetration tests from autonomous devices (e.g., drones, robots, etc.) that could ease the access to the logical infrastructure of an industrial facility [11]. This framework has a key feature because it generates reports about gathered information identifying weak points and exposure levels.
- *Faraday platform*[13] reuses the available tools in the community to perform penetration-tests. This introduces the concept of Integrated Penetration-Test Environment (IPE), which automates distribution, indexation and analysis of the data generated during a security audit.
- *Intrigue Core*[14] discovers assets (i.e., applications and infrastructure) and vulnerabilities utilizing APIs and OSINT techniques to discover an attack surface. This can be used from a docker image or web interface.
- *Leviathan framework*[15] is a python-based audit toolkit which includes service discovery (using Shodan and Censys), brute force, SQL injection detection and running custom exploit capabilities. This tool allows to do massive scans (using masscan) on several systems at once.
- *Trommel*[16] is a python tool that sifts embedded device files to identify potential vulnerabilities, such as, protocol key files, email addresses, shell scripts, etc. It integrates vFeed for in-depth vulnerability analysis.

A comparative can be found in the Table 1. We can see none of the tools support all the analyzed characteristics. Our approach supports the smart grid companies to design, perform and integrate their tests in their continuous auditing processes. Besides we aim at using containers, library objects and well known components in pentesting, and to use common network infrastructure to provide autonomy to the auditing companies.

**Table 1.** Comparative of tools to automate SWAN and/or VULN

	Asset Mgmt	VULN	Pen. tests	Shared logs	full automation
DeepExploit	-	-	X	-	-
VAPT	X	X	X	-	-
APT2	-	-	X	-	-
Archery	-	X	X	-	-
Lynis	X	X	X	-	X (docker)
CROZONO	-	-	X	-	X (dron&robots)
Faraday	-	-	X	-	-
Intrigue Core	X	X	-	-	X
Leviathan	X	-	X	-	X
Trommel	-	X	-	-	-

On the other hand, researchers have proposed some solutions focused on smart grids and IoT. In [17], an ISO/IEC 15408-2 compliant security auditing system based on a blockchain network as the underlying communication architecture is proposed



for IoT. This has been designed mainly to record (as a block) and share security events (or incidents). A practical risk assessment method applied to Austrian smart grid is presented [18]. The method follows a twofold approach: a conceptual and an implementation-based assessment. For the conceptual assessment uses a reference architecture based on Smart Grid Architecture Model (SGAM) [19], in order to analyze the deployed architectures, or that will be deployed in the near future, for mapping them to SGAM. The outcome of this first phase is a risk matrix and mitigation strategies. Then, the implementation-based assessment consists of evaluating details of systems, such as poor configurations and potential software implementation vulnerabilities. This second phase deals with existing systems that allow for a security audit that allow to assess the security with respect to the potential attack vectors and vulnerabilities, resulting in a set of possible exploits.

### 3. System Requirements

In this section we review the requirements of AUTOAUDITOR, the automated auditing system we propose for power grid companies.

We start by dealing with the requirements regarding the devices to test, concerning the fingerprinting of devices, and the vulnerabilities database(s) and vulnerability meta information that are required. We review the requirements for connection configuration, and for planning and executing the pentesting. We end with the requirements about the results gathering.

#### 1. Testing heterogeneous devices.

The system should be able to test elements of different types: smart meters, smart meters concentrators, other smart grid equipment (power chargers, etc.), networking elements (switches, routers, proxies, gateways) and servers in the core of the company's network(s).

#### 2. The auditing process must fingerprint the devices (equipment under test or EUT for brevity).

Given the wide variety of devices contemplated, the system should perform a semi automatic fingerprint of the EUT. The system will be supervised by the company to achieve a highly accurate fingerprinting of element type, operating system, communication protocols, software components (vendor and version) and other characteristics. The fingerprinting process output can be used by the company to update the company inventory. This will bring two additional benefits: increase the accuracy of the fingerprinting process and improve the automatic inventory with an additional on-line source.

Inaccuracies in the automatic fingerprinting may be detected manually or in the reconciliation with the inventory system. Such inaccuracies can be also incorporated in the system to improve the fingerprinting of the EUT model. This procedure can help the company to confirm the inventory with respect to production elements at different points of their network. For instance, imagine we test a smart meter X and end with a fingerprinting test procedure. The company can run this test to confirm that a given population of smart meters of type X, according to the inventory are indeed of type X, and have not been replaced by other element type.

### 3. Include known vulnerabilities and their metadata.

Starting from the fingerprint of the EUT, the system must retrieve the potential vulnerabilities according to open source databases like mitre cve, cvedetails, vuldb, openvas, exploitdb, securityfocus, securitytracker, x-force exchange, etc. The system will gather the vulnerability and severity information metadata.

Zero-day vulnerabilities and exploits are out of the scope of this work. The proposed approach towards zero-day(s) is to have the devices subject of the continuous monitoring processes and further inspected by behaviour analysis. Such behaviour analysis may trigger alerts and subsequent manual inspection, or even subject to preventive block or quarantine.

### 4. The test plan should be configurable and include attack vectors that are executable and demonstrable.

If the system is instructed to test the vulnerabilities, the system will select among the potential vulnerabilities of the EUT only the set of attack vectors which have available exploitation modules, ready to be executed against the EUT. The selected modules will be included in a test plan. The test plan will be encapsulated in some format which allows manual editing to include other modules and attack vectors. The test plan can include parameters, either manually defined or template based.

### 5. The connection of the testing unit with the EUT must be highly configurable and work across different networks.

The equipment of a power grid operator is scattered along the geography of the region or country supplied by the operator. The operator internal routers and firewalls ensure the separation of the interconnecting networks. The system must include the capability of defining configurable connections including different network parameters for running the different tests.

### 6. The execution of the test plan can be scheduled manually or according to inventory system needs.

The encapsulated test plan can be manually or automatically executed, according to the inventory system needs to update the data regarding the included assets and their related security information (vulnerability meta information). The test will fire the instantiation and execution of the tests. That may require instantiating connection elements according to the defined connection configuration and the concrete parameters of the test coming from the inventory system or the manual execution.

### 7. The output of the test execution must be in a format suitable for the inventory system.

The execution of the system will output evidences of the vulnerabilities tested. Those results must be in a format that can be linked to the inventory system. This information is part of the security assessment to better assess the vulnerabilities and incorporate the likelihood of the success of each of the different attacks.

### 8. The execution of the test plan must scale with the number of EUT.

The number of required test execution may involve a large number of resources, but it must scale with the number of EUTs. A suitable level of parallelization is required to ensure that auditing process finish according to the scheduling.

## 4. System Design

We have identified 8 requirements. Some of them are very demanding for automatic systems. Some of the tools we have reviewed claim to be completely automatic, thanks to self-learning capabilities. But they require an initial learning step in a sandboxed environment. It is not advisable to use such tools in a real environment until enough knowledge has been collected. Moreover, they require dry-run execution under manual supervision until they have been sufficiently tested. Though machine learning is valuable, we propose an initial step where experts perform manual testing to the different devices. AUTOAUDITOR will perform an automatic discovery of devices, and it also can be fed from the inventory system. With the input of the manual tests and the list of devices, AUTOAUDITOR will assist to create the templates for testing the devices in the list. The fingerprinting of the devices will be improved with the results of the tests results.

The requirements 1), 2), and 8) are related to the scalability and heterogeneity of the testing. We first thought of designing the system as a cloud service so that companies can pay for the resources they need. This solution requires not only to be integrated in some existing cloud service provider (CSP), but it will also require setting up dynamic connections of the EUT to the cloud, something that may not be easy nor acceptable from the point of view of the security policies of the companies. Besides the direct costs there may be marginal required by the CSP to maintain the basic infrastructure. Those are the main reasons of using containers, that can be deployed and run in the premises of the company to be audited.

### 4.1. Use of Containers

Containers allow to package up applications with all of the parts it needs, such as libraries and other dependencies, and ship it all out as one package. Containers are lightweight than virtual machines (VMs), and container applications start and stop faster than VMs, between 100 to 250 times faster. This is mainly because containers do not abstract the hardware but the OS. That also imply that containers are not hardware isolated, and they should not share hardware with critical mission applications. Containers can also be deployed in clouds and container-based applications are not so tightly-coupled to a cloud as applications using concrete cloud APIs. According to the 2019 Cloud report from Flexera more than half (61%) of enterprise employees are currently using or experimenting with Container as a Service technology. Docker is a very popular container engine, and there are python libraries such as `docker-compose` for defining and running multi-container Docker applications.

### 4.2. Connection Configuration Assistance

With regards to requirement 5), we have identified four potential scenarios where the company:

1. Provides the system with the EUT, making it physically accessible to the auditing system. This facilitates the execution of the vulnerability assessment, i.e. everything is local, but it has a large cost and demands a complex logistic.
2. Provides a container or virtual image of the EUT, making it locally accessible to the auditing system. This facilitates the execution of the vulnerability assessment, but does not scale well in the auditing system site.

3. Participates with the auditing system to set up a secure connection, typically using a VPN. This connection must be performed through a specific VPN configuration. Units in different networks will have their own VPN configuration. The company is responsible of the VPN parameters for the tests. The auditing system will assist the company to generate the configuration files. This also requires scalability in the auditing system site.
4. Receives a composition including container apps and virtual switches. The auditing system assists the company to configure a local (in the company internal network) VPN connection to the EUT and the tests are executed locally. This is the scenario that scales better.

The chosen option is 4 because it scales better and does not require scalability on the auditing site. It involves the VPN configuration for executing the specified modules locally at the company site. Once the test device is connected with the EUT, the tests will be executed and the evidences collected.

### 4.3. Vulnerabilities

According to requirement 3) the system must perform the fingerprinting of the EUTs. This also facilitates collecting the known potential vulnerabilities in open sources such as MITRE's CVE. We are using CVEScanner[20], the result of a previous work. CVEScanner creates databases of vulnerabilities per year, scraping the information from the open database `cvedetails.com`. Different databases may be merged and shipped together with the auditing tool, so that future scans do not need to repeat the search in open sources, drastically improving the scanning time. The scanner performs a fingerprint of the EUT and outputs the vulnerabilities of the detected product and versions. We are including the vulnerabilities in the database that have publicly available metasploit modules as shown by `cvedetails`, but other sources may also be added.

We consider CVE reference plus the severity according to CVSS 3.x metrics. That metadata is incorporated in the database of vulnerabilities and linked to the inventory entries. The company will end with an enhanced risk assessment regarding the feasibility of the tested attacks against the identified vulnerabilities. The company will further evaluate the cost of the security measures required to correct the vulnerabilities.

## 5. Implementation Details

AUTOAUDITOR workflow starts with the CVEScanner and the list of metadata about the potential vulnerabilities in the database, including the available metasploit modules. The list is saved in JSON format and the expert supervises and configures the attack plan, which is then encapsulated for execution according to requirements 4) and 6). The configuration also comprises the VPN connection including addresses and credentials.

AUTOAUDITOR outputs the composition of the containers including the connection and the audit application. The composition is then manually instantiated the first time so that the expert can verify its correctness. After potential corrections are made, the company launches the automatic deployment and execution of as many instances as required for the EUTs. Finally the results are collected for introduction in the inventory system.

## 6. Results

To test the correct behaviour of the system, we have developed a closed environment including the EUTs, the VPN server and the application performing the audit. It is orchestrated as a python application that sets up the configuration, the composition, instantiates the components, launches the auditing and collects the results. Such results should be similar to the ones obtained in a company, without the time required to instantiate the EUTs, which we have modeled as a couple of vulnerable containers. The auditing process will test CVE-2012-2122 and CVE-2014-0160 in first place and then CVE-2012-1823, CVE-2014-0160, CVE-2014-6271, CVE-2018-10933 and CVE-2018-15473. We have performed the test 500 times in a Intel(R) Core(TM) i7-7700HQ CPU @ 2.80GHz. First test spent 23.08 seconds in average, with a standard deviation of 12.05, including the initial run which required downloading the image. Second one took 36.12 in average, with a standard deviation of 11.96. Auditing time relies entirely on analyzed vulnerabilities. Some of the vulnerabilities were non-deterministic, a fact that correlates with high standard deviation and dispersion of data in Figure 1.

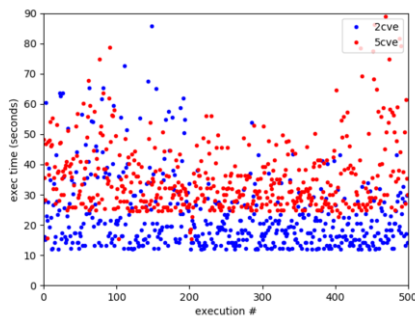

Figure 1. Auditing times, 2 and 5 vulnerabilities

## 7. Conclusions

Power grid companies deal with a large number of heterogeneous networks and devices. We consider they should connect their inventories with automatic or semiautomatic auditing system, to assess the security of their infrastructure. We have reviewed the newest auditing tools and have identified the requirements to propose a better solution, that we have called AUTOAUDITOR. This system builds upon previous works and facilitates the fingerprinting of devices and updates their security state by automatically running tests with the available pentesting modules. The system allows the flexible configuration of the VPN connection so that the auditing can be run totally under the control of the company. We have done some experiments to show the system performs fast enough to be included in power grid companies workflow. A survey among relevant persons of the involved companies will be performed to check the acceptance of a tool like this.

## Acknowledgments

This work has been supported by National R&D Projects TEC2017-84197-C4-1-R, TEC2014- 54335-C4-2-R, and by the Comunidad de Madrid project CYNAMON P2018/TCS-4566 and co-financed by European Structural Funds (ESF and FEDER).

## References

- [1] K. Dempsey, N. Goren, P. Eavy, and G. Moore, "Software asset management," National Institute of Standards and Technology, Tech. Rep. Technical Report NISTIR 8011 Vol. 3, 2018.
- [2] K. Dempsey, E. Takamura, P. Eavy, and G. Moore, "Software vulnerability management," National Institute of Standards and Technology, Tech. Rep. Technical Report NISTIR 8011 Vol. 4 (Draft), 2019.
- [3] IEC, "Part 1: Communication network and system security – introduction to security issues," IEC/TS, Tech. Rep. 62351-1, 2007.
- [4] J. T. F. T. Initiative, "Sp 800-39. managing information security risk: Organization, mission, and information system view," National Institute of Standards & Technology, Gaithersburg, MD, USA, Tech. Rep., 2011.
- [5] B. Aydemir and C. Stienen. (2019 (accessed Apr. 2020)) Swamp-in-a-box v1.34.5. [Online]. Available: <https://github.com/mirswamp/deployment/>
- [6] I. Takaesu. (2018 (accessed Apr. 2020)) Deepexploit: Fully automatic penetration test tool using machine learning. [Online]. Available: [https://github.com/130-bbr-bbq/machine\\_learning\\_security/tree/master/DeepExploit](https://github.com/130-bbr-bbq/machine_learning_security/tree/master/DeepExploit)
- [7] ((accessed Apr. 2020)) Veracode vulnerability assessment software. [Online]. Available: <https://www.veracode.com/security/vulnerability-assessment-software>
- [8] A. Compton and A. Lane. (2016 (accessed Apr. 2020)) Apt2: an automated penetration testing toolkit. [Online]. Available: <https://tools.kali.org/information-gathering/apt2>
- [9] A. Tiwari. (2019 (accessed Apr. 2020)) Archerysec: Centralize vulnerability assessment and management for devsecops team. [Online]. Available: <https://archerysec.github.io/archerysec/>
- [10] M. Boelen. (2017 (accessed Apr. 2020)) Auditing, system hardening, compliance testing. [Online]. Available: <https://cisofy.com/lynis/>
- [11] S. A. Berta, N. S. Villanueva, P. Romanos, D. Benítez, and M. Pepe, "Croazono: Leveraging autonomous devices as an attack vector on industrial networks," 2016.
- [12] P. Romanos and S. Berta. (2015 (accessed Apr. 2020)) A framework to test your security perimeter with drones & robots. [Online]. Available: <https://github.com/johnjohnsp1/CROZONO>
- [13] G. Riera and M. A. R. Medina. (2015 (accessed Apr. 2020)) python-faraday: A multiuser penetration test ide. [Online]. Available: <https://tools.kali.org/information-gathering/faraday>
- [14] J. Cran, T. Kaiser, and A. Bensalah. (2016 (accessed Apr. 2020)) Intrigue core: Discover your attack surface. [Online]. Available: <https://core.intrigue.io/>
- [15] B. Jopling. (2018 (accessed Apr. 2020)) Leviathan: wide range mass audit toolkit. [Online]. Available: <https://github.com/utkusen/leviathan>
- [16] Kyle. (2017 (accessed Apr. 2020)) Trommel: Sift through embedded device files to identify potential vulnerable indicators. [Online]. Available: <https://github.com/CERTCC/trommel>
- [17] S. Cha and K. Yeh, "An iso/iec 15408-2 compliant security auditing system with blockchain technology," in *2018 IEEE Conference on Communications and Network Security (CNS)*, May 2018, pp. 1–2.
- [18] L. Langer, F. Skopik, P. Smith, and M. Kammerstetter, "From old to new: Assessing cybersecurity risks for an evolving smart grid," *Computers & Security*, vol. 62, pp. 165 – 176, 2016. [Online]. Available: <http://www.sciencedirect.com/science/article/pii/S0167404816300876>
- [19] "Smart grid reference architecture (SGAM)," 2012, [www.cencenelec.eu/standards/Sectorsold/SustainableEnergy/SmartGrids/Pages/default.aspx](http://www.cencenelec.eu/standards/Sectorsold/SustainableEnergy/SmartGrids/Pages/default.aspx).
- [20] F. Alegre. (2019 (accessed Apr. 2020)) Cvesscanner: Nmap security tool used to discover potentially cves that affects services in detected open ports. [Online]. Available: <https://github.com/alegr3/CVescanner>

# 1st International Workshop on Open and Crowdsourced Location Data (ISOCLoD'20)

This page intentionally left blank



# Domain Agnostic Quality of Information Metrics in IoT-Based Smart Environments

AURORA GONZÁLEZ-VIDAL <sup>a,1</sup>, TOMÁS ALCAÑIZ <sup>a</sup>, THORBEN IGGENA <sup>b</sup>,  
EUSHAY BIN ILYAS <sup>b</sup>, and ANTONIO F. SKARMETA <sup>a</sup>.

<sup>a</sup>*Department of Information and Communication Engineering, University of Murcia, Spain*

<sup>b</sup>*Lab for Mobile Communications, Faculty of Engineering and Computer Science, University of Applied Sciences Osnabrück, Germany*

**Abstract.** Thanks to the proliferation of IoT devices that are interconnected, huge amounts of data are being gathered nowadays. The availability of all these new sensors, data sources and open data platforms offers new possibilities for innovative applications and use-cases that are many times dynamic. However, if we plan to depend on data for the optimal provision of services, it is of utmost importance to ensure the quality of data and the quality of information that we are handling in an online manner. Furthermore, geolocalised data provides a richer context in which the quality of information can be measured and in which services are more advanced. In order to support the process of finding the right information, we have defined several metrics in single-sensor and multi-sensor scenarios that are based on statistical analysis, machine learning algorithms and contextual information. We have applied them in two scenarios: smart parking and environmental sensing for smart buildings.

**Keywords.** IoT, Quality of Information, Missing data imputation, Bayesian Maximum Entropy, Autoencoders

## 1. Introduction

With the increasing number of devices in the Internet of Things, the availability of data has massively increased. Smart cities, industry 4.0, social networks, or even agriculture have created dozens of new data sources. This allows the development of new applications and use cases<sup>2</sup>. Due to the heterogeneity and the sheer amount of data sources, there is a need to ensure high quality of the used data to avoid wrong decisions and to increase the user experience for smart applications.

A major requirement for these scenarios is quality analysis metrics for data sources and their monitored data. False or misleading information might cause problems during the processing and usage of the information. This problem reaches from simple misconfigured sensors, which deliver wrong information, to intentionally provided false information with malicious intent, which leads to malfunctioning systems and applications.

---

<sup>1</sup>Corresponding Author. E-mail: aurora.gonzalez2@um.es

<sup>2</sup><http://www.ict-citypulse.eu/scenarios/>

To approach these problems, we integrate quality measures and analysis modules to rate data sources to identify the best fitting data sources to get the needed information.

There are many definitions of Data Quality (DQ). The two predominant ones are:

- Data is of high quality if the data is fit for the intended purpose of use
- Data is of high quality if the data correctly represent the real-world construct that the data describe

In many studies, complex algorithms claim to preserve data quality [1,2], however, they lack straightforward definitions of what quality is. In this work, we define metrics for DQ and compute them in several IoT scenarios for checking their viability.

## 2. Related work and background

Research on data quality became popular starting in the context of databases containing data from multiple data sources. Strong et al. came to the point, that faulty data cost billions of dollars. As a solution, they came up with the term Quality of Information (QoI), which they defined in four categories and defined measurable metrics for each of them [3]. During the next years, several frameworks to address the QoI have been developed. In [4], a general QoI framework has been designed that allows creating measurement models for specific settings and domains. Further development in the context of QoI frameworks has been taken by Bisdikian et al. [5], who described context-independent quality measurements. To do so, they split the data quality into the terms QoI and Value of Information. QoI is also a topic of research in diverse IoT frameworks designed for innovative applications in Smart Cities [6] or in IoT search [7]. A deeper review of data quality for IoT scenarios is done in [8].

Nowadays, IoT data is present in many scenarios and contexts and there exist some domain-specific approaches for estimating DQ such as health [9] or energy consumption in smart grid [10] amongst others. These works define a set of tests as queries that are written to check the properties specified by domain experts using mathematical formulas or natural language, which cannot be easily updated or applied to other problems.

Data quality tools typically address data cleansing, data integration, master data management, and metadata management. Challenges of interest have an impact when choosing a tool: Incorrect data, duplicate data, missing data and other data integrity issues can significantly impact — and undermine — the success of an initiative.

In addition to research work, several business initiatives are proposed, such as Cloudingo<sup>3</sup> for removing duplicates using a graphical interface, Data Ladder<sup>4</sup> for matching and cleaning using templates or Informatica<sup>5</sup>, that is a data quality validation tool that provides a set of data quality checks as queries to validate the syntactic properties of the target data, such as data type and not-null constraint checks. The tool allows users to specify semantic properties to be verified by the tests.

Although these tools are general enough for use in any project, they require domain knowledge to define and update the domain-specific properties. There is a lack of open tools that automatically generate the properties to be checked by the data quality tests.

---

<sup>3</sup><https://cloudingo.com/>

<sup>4</sup><https://dataladder.com/>

<sup>5</sup><https://www.informatica.com/products/master-data-management.html>

In machine learning, clustering is an unsupervised technique that uses intrinsic properties of the data for dividing the studied subjects into several categories. In that division, subjects within a group are similar to each other and dissimilar to the subjects assigned to other groups according to a certain metric and without labelled data.

Clustering techniques have been used in the literature for IoT-based scenarios [11]. In particular, many clustering works have focused on the use of clustering for anomaly detection. Those techniques include, but are not restricted to, K-Means and Hierarchical Clustering [12], Expectation Maximization (EM) [13], Hyperellipsoidal Clustering algorithm for Resource-Constrained Environments (HyCARCE) [14] and Gaussian Mixed Models (GMM) [15]. Autoencoders are another representation learning approach. An autoencoder investigates an efficient encoding from the data in an unsupervised manner. They have also been used for anomaly detection [16]. One-class SVM [17] is an outlier detection algorithm in which the whole training data is assumed to belong to the normal class and any data point outside of this data region is considered as an outlier.

### 3. Data quality metrics

In this section, we describe the metrics that have been defined to calculate and annotate the QoI for IoT data.

#### 3.1. QoI basic metrics

The first set of metrics are based on the ones developed for the IoTcrawler framework [7].

- Completeness ( $q_{cmp}$ ): missing or unusable data instances are represented with this metric. It computes the percentage of the unusable data.
- Timeliness ( $q_{tim}$ ): refers to the time expectation for accessibility and availability of information. In other words, expresses how long the time difference between data capture and the real world event being captured is. In critical IoT applications such as traffic safety and control and managing power systems knowing your timeliness requirements is fundamental.
- Plausibility ( $q_{pla}$ ): this metric shows if received data is coherent according to the probabilistic knowledge of the variables that are being measured.
- Artificiality ( $q_{art}$ ): this metric determines the inverse degree of the used sensor fusion techniques and defines if this is a direct measurement of a singular sensor, an aggregated sensor value of multiple sources or an artificial spatiotemporally interpolated value.
- Concordance ( $q_{conc}$ ): This metric is used to describe the agreement between information of the data source and the information of further independent data sources, which report correlating effects. The Concordance analysis takes any given sensor  $x_0$  and computes the individual concordances,  $C(x_0, x_i)$ , with a finite set of  $n$  sensors ( $i = 1, \dots, n$ ).

#### 3.2. Outlier-based metrics

In machine learning, an outlier is an observation that diverges from an overall pattern. The number of outliers in an indicator of data quality.

We have used an Autoregressive Integrated Moving Average (ARIMA) based framework [18] in order to find innovational outliers, additive outliers, level shifts, temporary changes and seasonal level shifts [19]. The percentage of outliers in the studied sensor is named  $q_{out}$ . We have also studied how much the outlier deviates from what could be considered a normal observation. The outliers are imputed with missForest [20], an iterative Random Forest-based imputation method. Then the difference between the value and the imputation is another metric that has been computed by dividing the difference of each sensors value by the mean, median or mode of the values and then calculate their mean, median or mode ( $q_{mean}$ ,  $q_{median}$ ,  $q_{mode}$ ).

Another way to detect outliers is by using unsupervised methods.  $q_{prob}$  is the probability of belonging to a certain cluster that has been computed using Gaussian Mixture Models (GMM). It informs quantitatively of the anomalous values. The number of clusters is chosen using the silhouette coefficient.

We consider that AutoEncoders (AE) are also appropriate for this task because they learn the normal relationships inherent in the data and, therefore, when looking for anomalies they have a huge potential [21]. The metric based on AE informs us about how the correlations between the different variables of the system behave. AE are a specific type of feedforward neural networks where the input is the same as the output. They compress the input into a lower-dimensional code and then reconstruct the output from this representation. Given that, the metric  $q_{rec}$  is based on the difference between the input and the output value of the AE, in such a way that the greater the reconstruction error, the less concordance there will be between the variables.

To sum up, we have defined 6 new metrics:  $q_{out}$ ,  $q_{mean}$ ,  $q_{median}$ ,  $q_{mode}$ ,  $q_{prob}$  and  $q_{rec}$ .

### 3.3. Geospatial-based metrics

The exact location of measuring the physical world through IoT is highly relevant to extract all insights. In that sense, we have also provided two metrics that are based on the interpolation of all datapoints as if they were missing by using geostatistical models. Those models are Inverse Distance Weighting (IDW) [22] and Bayesian Maximum Entropy (BME) [23]. IDW is a deterministic estimation method where the unknown data points are calculated with a weighted average of the values available at the known points, assuming that sensors that are close are more alike. BME is a knowledge-based probabilistic modeling framework for spatial and spatiotemporal information. It allows various knowledge bases to be incorporated in a logical manner as definite rules for prior information, hard (high-precision) and soft (low-precision) data into modeling.

As defined before, we have computed the difference between the interpolated value and the real one and its mean and median are going to be our metrics, named as:

- $q_{inv\_mean}$  and  $q_{inv\_med}$  for IDW.
- $q_{BME\_mean}$  and  $q_{BME\_med}$  for BME.

## 4. Real scenarios and implementation

In this section, we introduce 3 different IoT scenarios in which the previous metrics are computed and highlight the possible drawbacks. We also introduce how we have used OpenCPU to implement our calculations as a service that is available at any time.

#### 4.1. Parking Data.

This data was collected from 5 private parking sensors located in the city of Murcia <sup>6</sup>. Fig. 1 shows the location of these parking areas.



**Figure 1.** Parking zones

First, we have selected those variables that are useful for our goal: the timestamp and the parking occupation measurements and aggregated the data in 10 minutes intervals. This aggregation can generate redundancies on the timestamps, so we have averaged the result. Storing information about this aggregation process will be useful for the Artificiality metric. We have kept *NA* (not available) instances since they are important for obtaining some quality metrics (Completeness). Given that the data is not measured periodically, a lot of missing values are generated at this point.

For illustrative purposes, we have created a new variable called *real\_time* which adds a random delay to the timestamps, simulating that the data needs some time to be stored. These are some highlights:

- **Completeness:** it consists on counting instance by instance the percentage of non-absent values there are.
- **Timeliness:** we use the random time lag that is included in the data ( $T_{age}$ ), so if we divide it by the arbitrary aggregation time  $W$  (600 seconds, in this case) we get the time that data takes to be available, as follows:  $q_{tim} = 1 - \frac{T_{age}}{W}$ .
- **Plausibility:** If the data of each parking lot belongs to the interval  $[0, C_i]$ , this measure will be said to be plausible and will receive a value of 1. The values of  $C_i$  are: 330, 312, 305, 162 and 220 respectively.
- **Artificiality:** Since we performed aggregation over time, the number of instances used for computing the mean and therefore the aggregated value were considered. Thus, if a data was obtained by means of two data-points taken in the same time frame, its metric of artificiality will be  $\frac{1}{2}$ .
- **Concordance:** we used the geostatistical metrics for covering this concept.
- **Outliers:** given the amount of missing data, we could not use the ARIMA framework for detecting outliers in this dataset.

A subset of the quality metrics and data values are shown in Table 1. Where Park101, ... ,Park105 are the parkings' ids and  $T_{age}$  is the time lag. Fig. 2 shows the histograms of all metrics that could be computed for the parking dataset together with basic statistics.

<sup>6</sup>Their locations are stored in the following web address <http://mapamurcia.inf.um.es/>

timestamp	Park <sub>101</sub>	Park <sub>102</sub>	Park <sub>103</sub>	Park <sub>104</sub>	Park <sub>105</sub>	q <sub>comp</sub>	T <sub>age</sub>	q <sub>tim</sub>	q <sub>pla</sub>	q <sub>art</sub>
2018-03-28 11:50:00	NA	163.33	NA	NA	117.5	0.4	574	0.04	1	0.33
2018-03-28 12:00:00	NA	10000	NA	NA	116.5	0.4	596	0.01	0	0.50
2018-03-28 12:10:00	NA	163.00	NA	10000	116.5	0.6	11	0.98	0	0.33
2018-03-28 12:20:00	NA	165.00	NA	NA	118.0	0.4	299	0.50	1	1.00
2018-03-28 12:30:00	NA	166.00	NA	NA	120.0	0.4	226	0.62	1	1.00
2018-03-28 12:40:00	-1	166.50	NA	NA	119.0	0.6	468	0.22	0	0.50

**Table 1.** Parking observations (number of cars) and quality metrics subset

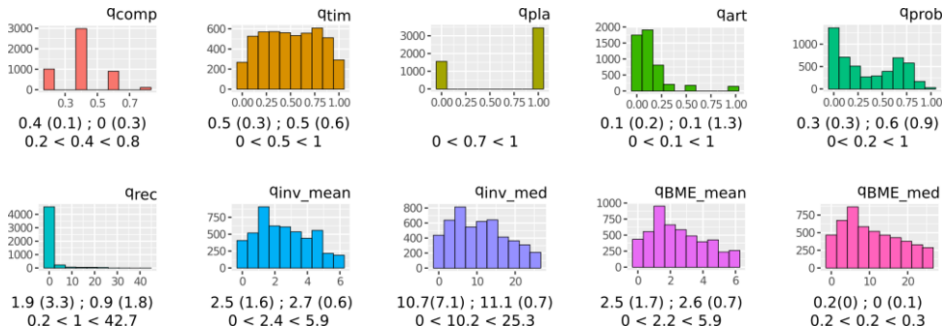

**Figure 2.** Parking metric's histograms and statistics. Statistics are: Mean (sd); IQR (CV) and min < mean < max

#### 4.2. Luminosity Data

In this section, we have studied the monitored luminosity from 4 sensors located in the Pleiades building of the University of Murcia.

First, the data is aggregated using the timestamp as in the previous section, choosing a 10 minutes aggregation time. Table 2 shows the aggregated values and also some of the computed metrics.

time	S <sub>1</sub>	S <sub>2</sub>	S <sub>3</sub>	S <sub>4</sub>	q <sub>comp</sub>	q <sub>pla</sub>	q <sub>art</sub>	q <sub>prob</sub>	q <sub>rec</sub>
2020-01-21 18:00:00	20	55	10	80	1.00	1	1	0.001	0.54
2020-01-21 18:10:00	25	70	20	40	1.00	1	1	0.111	0.48
2020-01-21 18:20:00	NA	70	10	NA	0.50	1	1	0.827	0.33
2020-01-21 18:40:00	20	95	10	65	1.00	1	1	0.701	0.32
2020-01-21 18:50:00	30	30	20	60	1.00	1	1	0.110	0.29
2020-01-21 19:10:00	20	75	10	280	1.00	0	1	0.021	0.29

**Table 2.** Luminosity (lumens) metrics subset: completeness, plausibility and artificiality, anomaly probability and reconstruction metric

Fig. 3 shows the histograms of all metrics that could be computed for the luminosity dataset together with basic statistics. The timeliness metric could not be calculated, since we are not aware of any lag in the storage of the data. Also, the artificiality value always takes the value of 1 because the timestamps of the data are far apart. Therefore, it was

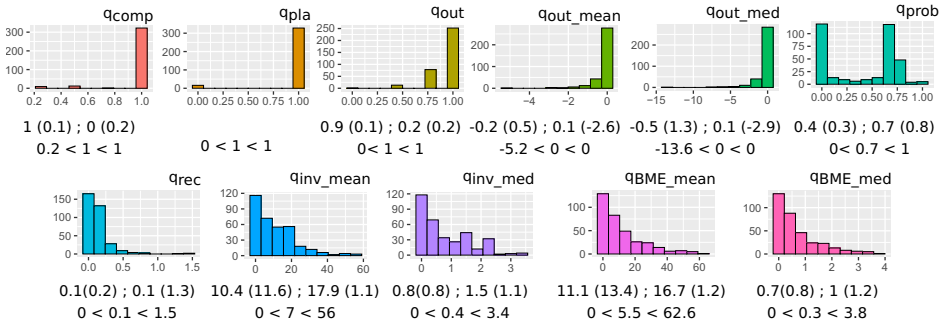

**Figure 3.** Luminosity metric’s histograms and statistics. Statistics are: Mean (sd); IQR (CV) and min < mean < max

not included in Fig. 3. We have also computed the outlier metrics for this dataset using the ARIMA framework and the metrics created in subsection 3.2.

### 4.3. Temperature (°C) and humidity (%) data

Finally, we have a series of temperature and humidity datasets collected by sensors located in the Pleiades building at the University of Murcia.

time	T <sub>1</sub>	T <sub>2</sub>	T <sub>3</sub>	T <sub>4</sub>	T <sub>5</sub>	T <sub>6</sub>	T <sub>7</sub>	H <sub>1</sub>	H <sub>2</sub>	H <sub>3</sub>	H <sub>4</sub>	H <sub>5</sub>	H <sub>6</sub>
06:10:00	17.26	18.53	22.63	3.14e-193	23.40	16.74	23.18	34.90	37.05	36.09	40.02	8.88e-159	29.61
06:30:00	17.26	18.53	22.67	3.14e-193	23.51	16.74	23.18	34.90	36.90	35.87	39.92	8.88e-159	29.22
06:40:00	17.26	18.53	22.69	3.14e-193	23.41	16.74	23.18	36.20	36.35	35.53	39.82	8.88e-159	29.43
07:00:00	17.26	18.84	22.86	3.14e-193	23.39	16.74	23.18	35.65	35.71	35.23	39.61	8.88e-159	29.36
07:10:00	17.26	19.04	22.78	3.14e-193	23.31	16.74	23.18	35.40	35.63	34.89	39.97	8.88e-159	29.53
07:40:00	17.26	18.22	22.74	3.14e-193	23.42	16.74	23.18	35.38	35.24	35.65	39.74	8.88e-159	29.18

**Table 3.** Temperature (°C) and humidity (%) subset

Table 3 shows the temperature and humidity values for the different timestamps.

This dataset is in the ideal conditions to apply all our metrics, and the process goes as follows:

- The timestamp of the measurement is rounded and the average is taken.
- All datasets are joined, using a time union and the mean of the values is calculated.
- For the Plausibility metric, we chose as normal for temperature the interval [10,45] and for humidity, the interval (0,100). The metric takes the value 0 for the measurements out of these intervals. These values have been taken arbitrarily.
- For Artificiality it is enough to count the number of values that were used in the aggregation step. Because the frequency of data collection is very low and the time rounding has been taken from 10 minutes, all values take 1 in the Artificiality metric.
- Next, the outliers of the different time series are detected and the difference of the expected value between the outlier is calculated. This will constitute the different metrics previously calculated, that is, obtain the mean between these values, the mean weighted by the means of each of the sensor series, the similar case weighted by the median and by the mode.

- We perform similarly with the rest of the metrics

Fig. 4 shows the histograms of all metrics that could be computed for the temperature and humidity dataset together with basic statistics. Given that there are sensors that always present too low values, the Plausibility metric is always 0 and we have not included it in Fig. 4. Timeliness was again not possible to compute.

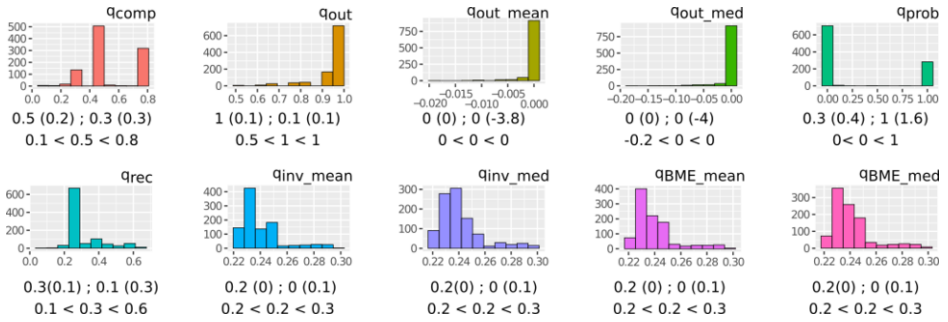
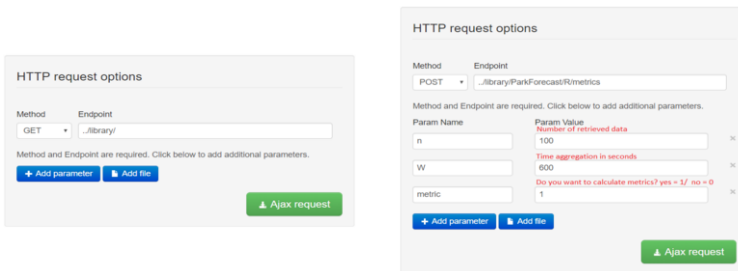

**Figure 4.** Temperature and Humidity metric’s histograms and statistics. Statistics are: Mean (sd); IQR (CV) and min < mean < max

#### 4.4. OpenCPU implementation

OpenCPU is a framework for embedded scientific computing and reproducible research. The OpenCPU server provides a reliable and interoperable HTTP API for data analysis based on R. We used OpenCPU so that our metrics can be computed by any user, since all state in OpenCPU is managed by controlling objects in sessions on a server [24]. For this purpose, an R package was constructed that performs all these calculations and supports a set of URLs in which the data is stored. The package’s functions support the following parameters:

- n: number of data the function will return.
- W: proper time of the system in which the aggregation of times will be realized.
- metric: dummy variable to which a value is assigned depending on whether you want to show the quality metrics or not.



**Figure 5.** OpenCPU interface



When we access the IP where the OpenCPU service is hosted, the interface in Figure 5 (left) appears. In order to compute the metrics a POST method should be established and the endpoint should point the appropriate package and functions, in this case *Park-Forecast* and *metrics*.

## 5. Conclusions and Future Work

In this paper we use a combination of concepts for the calculation of Quality of Information for real-time IoT-based sensor systems and shown its application to a more dataset based approach. The inclusion of an outlier detection framework allows for a more descriptive analysis of the sensor and its data. As future work we plan to incorporate our metrics into real-time systems and see how they influence the quality of results in further analysis and service provision.

## Acknowledgements

This work has been sponsored by MINECO through the PERSEIDES project (ref. TIN2017-86885-R), by the European Commission through the H2020 IoT-Crawler (contract 779852), and DEMETER (grant agreement 857202) EU Projects. It was also co-financed by the European Social Fund (ESF) and the Youth European Initiative (YEI) under the Spanish Seneca Foundation (CARM).

## References

- [1] Y. Fathy and P. Barnaghi, "Quality-based and energy-efficient data communication for the internet of things networks," *IEEE Internet of Things Journal*, vol. 6, no. 6, pp. 10318–10331, 2019.
- [2] A. Gonzalez-Vidal, P. Barnaghi, and A. F. Skarmeta, "Beats: Blocks of eigenvalues algorithm for time series segmentation," *IEEE Transactions on Knowledge and Data Engineering*, vol. 30, no. 11, pp. 2051–2064, 2018.
- [3] R. Y. Wang, D. M. Strong, and L. M. Guarascio, "Beyond accuracy: What data quality means to data consumers," *J. of Management Information Systems*, vol. 12, no. 4, pp. 5–33, 1996.
- [4] B. Stvilia, L. Gasser, M. B. Twidale, and L. C. Smith, "A framework for information quality assessment," *Journal of the American Society for Information Science and Technology*, vol. 58, no. 12, pp. 1720–1733, 2007.
- [5] C. Bisdikian, L. M. Kaplan, and M. B. Srivastava, "On the quality and value of information in sensor networks," *ACM Transactions on Sensor Networks (TOSN)*, vol. 9, no. 4, p. 48, 2013.
- [6] D. Puiu, P. Barnaghi, R. Toenjes, D. Kümper, M. I. Ali, A. Mileo, J. X. Parreira, M. Fischer, S. Kolozali, N. Farajidavar et al., "Citypulse: Large scale data analytics framework for smart cities," *IEEE Access*, vol. 4, pp. 1086–1108, 2016.
- [7] D. Kuemper, T. Iggena, R. Toenjes, and E. Pulvermueller, "Valid. iot: a framework for sensor data quality analysis and interpolation," in *Proceedings of the 9th ACM Multimedia Systems Conference*. ACM, 2018, pp. 294–303.
- [8] A. Karkouch, H. Mousannif, H. Al Moatassime, and T. Noel, "Data quality in internet of things: A state-of-the-art survey," *Journal of Network and Computer Applications*, vol. 73, pp. 57–81, 2016.
- [9] M. G. Kahn, T. J. Callahan, J. Barnard, A. E. Bauck, J. Brown, B. N. Davidson, H. Estiri, C. Goerg, E. Holve, S. G. Johnson et al., "A harmonized data quality assessment terminology and framework for the secondary use of electronic health record data," *Egems*, vol. 4, no. 1, 2016.
- [10] W. Chen, K. Zhou, S. Yang, and C. Wu, "Data quality of electricity consumption data in a smart grid environment," *Renewable and Sustainable Energy Reviews*, vol. 75, pp. 98–105, 2017.

- [11] D. Puschmann, P. Barnaghi, and R. Tafazolli, "Adaptive clustering for dynamic iot data streams," *IEEE Internet of Things Journal*, vol. 4, no. 1, pp. 64–74, 2016.
- [12] M. S. Parwez, D. B. Rawat, and M. Garuba, "Big data analytics for user-activity analysis and user-anomaly detection in mobile wireless network," *IEEE Transactions on Industrial Informatics*, vol. 13, no. 4, pp. 2058–2065, 2017.
- [13] M. Goldstein, "Fastlof: An expectation-maximization based local outlier detection algorithm," in *Proceedings of the 21st International Conference on Pattern Recognition (ICPR2012)*. IEEE, 2012, pp. 2282–2285.
- [14] P. Rathore, A. S. Rao, S. Rajasegarar, E. Vanz, J. Gubbi, and M. Palaniswami, "Real-time urban micro-climate analysis using internet of things," *IEEE Internet of Things Journal*, vol. 5, no. 2, pp. 500–511, 2017.
- [15] J. Diaz-Rozo, C. Bielza, and P. Larrañaga, "Clustering of data streams with dynamic gaussian mixture models: an iot application in industrial processes," *IEEE Internet of Things Journal*, vol. 5, no. 5, pp. 3533–3547, 2018.
- [16] C. Zhou and R. C. Paffenroth, "Anomaly detection with robust deep autoencoders," in *Proceedings of the 23rd ACM SIGKDD International Conference on Knowledge Discovery and Data Mining*, 2017, pp. 665–674.
- [17] B. Schölkopf, J. C. Platt, J. Shawe-Taylor, A. J. Smola, and R. C. Williamson, "Estimating the support of a high-dimensional distribution," *Neural computation*, vol. 13, no. 7, pp. 1443–1471, 2001.
- [18] A. González-Vidal, J. Cuenca-Jara, and A. F. Skarmeta, "Iot for water management: Towards intelligent anomaly detection," in *2019 IEEE 5th World Forum on Internet of Things (WF-IoT)*. IEEE, 2019, pp. 858–863.
- [19] C. Chen and L.-M. Liu, "Joint estimation of model parameters and outlier effects in time series," *Journal of the American Statistical Association*, vol. 88, no. 421, pp. 284–297, 1993.
- [20] D. J. Stekhoven and P. Bühlmann, "Missforest—non-parametric missing value imputation for mixed-type data," *Bioinformatics*, vol. 28, no. 1, pp. 112–118, 2012.
- [21] Y. Ikeda, K. Ishibashi, Y. Nakano, K. Watanabe, and R. Kawahara, "Anomaly detection and interpretation using multimodal autoencoder and sparse optimization," *arXiv preprint arXiv:1812.07136*, 2018.
- [22] D. Zimmerman, C. Pavlik, A. Ruggles, and M. P. Armstrong, "An experimental comparison of ordinary and universal kriging and inverse distance weighting," *Mathematical Geology*, vol. 31, no. 4, pp. 375–390, 1999.
- [23] A. González-Vidal, P. Rathore, A. S. Rao, J. Mendoza-Bernal, M. Palaniswami, and A. F. Skarmeta-Gómez, "Missing data imputation with bayesian maximum entropy for internet of things applications," *IEEE Internet of Things Journal*, 2020.
- [24] A. Zafeiropoulos, E. Fotopoulou, A. González-Vidal, and A. Skarmeta, "Detaching the design, development and execution of big data analysis processes: A case study based on energy and behavioral analytics," in *2018 Global Internet of Things Summit (GloTS)*. IEEE, 2018, pp. 1–6.

# Efficient Collaborative Strategy for Last Mile Package Delivery Optimization: Salamanca Case Study

Roberto Casado-Vara <sup>a,1</sup>, Ricardo S. Alonso <sup>a</sup>, Jose A. García-Coria <sup>a</sup>, Sara Rodríguez <sup>a</sup> and Javier Prieto <sup>a</sup>

<sup>a</sup>*BISITE Research group, University of Salamanca. Edificio Multiusos I+D+i, 37007, Salamanca, Spain.*

*Email: {rober, ralorin, jalberto, srg, javierp}@usal.es*

**Abstract.** The continuous movement of package delivery vehicles in cities is one of the problems affecting urban traffic. These delivery vehicles have a very tight schedule to deliver a high number of packages and improve the experience of customers shopping online. In this paper, we propose a new strategy for collaborative truck routing. This new strategy uses complex network concepts and graphing algorithms to find an optimal route for packages to be delivered on time, reducing the distances that deliverers must travel in cities. To test the efficiency of this new strategy, simulations have been designed for the city of Salamanca (Spain). Those simulations have shown that there is a considerable improvement if delivery companies use the new strategy.

**Keywords.** Last-mile delivery, Vehicle routing, smart mobility.

## 1. Introduction

The delivery of a wide range of products to homes in urban areas is growing in popularity, although it is considered an essential element of the user experience in Internet shipping [1]. Sending goods by train or ship is considered to be cost-effective [2, 3]. However, when the goods arrive at a destination port or warehouse, they must be distributed to their recipients. The last step in the goods supply chain is called the last mile delivery and is considered the most time-consuming, polluting and cost-inefficient part of the supply chain [4]. It is estimated that the cost of the latter delivery ranges from 13% to 75% of the total delivery costs [5], and may be as much as 40% of the price paid by the client [6], which means that increasing its efficiency would be significant. In urban areas, traffic conditions are changing and the behaviour of stakeholders (drivers, cyclists and pedestrians) can make it difficult to meet delivery schedules. Therefore, the premise of our research is that if the last mile delivery of goods is optimized, the level of customer satisfaction will be higher, the environmental footprint of the last mile delivery will be reduced, and traffic congestion, caused by the high number of drivers will be avoided.

---

<sup>1</sup>Corresponding Author: Roberto Casado-Vara E-mail: rober@usal.es

Thus, the aim of this research is to develop a new collaborative strategy enabling delivery trucks to deliver packages more efficiently.

Last mile delivery is one of the largest challenges in Business to Customer e-commerce. The problems caused by the delivery of small packages - most packages sold by companies like Amazon weigh less than 2.2 kg - can be increased due to the growing importance of e-commerce [7]. Furthermore, retailers are faced with increased demands from customers regarding the quality of service: shorter delivery times, just-in-time deliveries, or on-demand deliveries, which can reduce the delivery time to one or two hours [8]. In terms of economy, the need to increase efficiency due to decreasing marginal income has led several of those involved to consider alternatives to increase efficiency in last mile shipping. Among the most classic optimization options is the optimization of vehicle routes or combining freight with passenger transport, for example [9, 10]. Another recent consideration has to do with environmental impact, since it is considered that the shipment of goods in urban areas is responsible for 25% of  $CO_2$  emissions and between 30% and 50% of other pollutants [11]. A short review of the problems associated with last mile routing, which also includes new directions to consider, can be found in Taniguchi *et al.* [12]. A large number of works include the proposal of a mathematical model, in integer or mixed linear programming, although some examples of non-linear programming can also be found. However, many recognize the problem of using this exact mathematical solution, due to the computational cost it entails, especially when solving problems of a considerable size. Thus, [13] indicate that, in their tests, the linear programming model they propose cannot be solved for 30 stops in 4 hours. The one presented in [14], is even more demanding, the authors indicate that their linear programming model needs several hours to obtain a solution for an "apparently" simple example with 10 stops. Realistic size problems are rarely optimally solved by purely accurate methods, the methodology of choice in most cases is metaheuristics [15, 16]. Therefore, many of the articles that include their own formulation of a solution with linear (integer) programming for specific characteristics of the problem, also include one or more heuristics, many of them derive from Artificial Intelligence approaches, to obtain practical solutions to the problem of vehicle routing, optimization of the number of vehicles, optimization of the size/weight of the packages, load distribution points between vehicles, etc. Although all these researches provide an optimal solution to the problem they pose, we have found a research gap in the literature, since most of the solutions require complex mathematical calculations in real time that entail high costs, making them unaffordable for some parcel transport companies.

In this paper, a new strategy has been proposed using on the strong points of the mathematical models based on graph theory and complex networks. This strategy has several steps in which technologies or algorithms whose efficiency has already been proven, are used. The novelty proposed by this research is the combination of those algorithms of network theory with a known level of computational complexity and the techniques of network slicing of complex networks, applied in the solution for the last mile distribution problem. This approach is novel and will allow many more delivery companies to use it since the level of computational complexity is low. In summary, this new strategy consists of 4 stages: in the first one, the map is obtained and the network is built; in the second stage each of the networks building a multiplex is virtualized; in the third stage

the points where the delivery routes will pass are identified and it is determined if their destinations for some of the packages coincide; in the fourth stage, the optimal route for each of the delivery trucks is sought and in case their routes coincide, the packages will be shared in a collaborative way to improve the results of the package delivery in the last mile. The results of this research, although still in the early stages, are quite relevant since it optimizes the current last mile delivery results by approximately 8% on average.

The remainder of this manuscript is described as follows. In Section 2, we present our novel collaborative last mile delivery strategy. In Section 3, a bench of simulations is shown and its findings are presented to verify the outcome of the theoretical approach. Finally, some conclusions are drawn in Section 4.

## 2. Proposed method

In this section we will describe the strategy we propose in this paper to address the problem of last mile delivery. The proposed strategy is a hybrid system with different techniques and algorithms to collaboratively seek the optimal solution to the proposed problem. A map of the last mile delivery area is obtained first and transformed into a weighted graph ( $G$ ) so that the set of vertices ( $V$ ) are the street crossings and the set of edges ( $E$ ) are the streets. Using a GPS, the distances of each of the streets are calculated and the weights ( $w_i$ ) are placed in the  $G_n$ . A virtual graph is then created for each delivery truck, identifying the departure point and the delivery points for each of the packages. Thus, there will be  $n$  graphs ( $G_n$ ) - one for each delivery truck - in which each of the delivery truck routes will be identified. For each of the  $G_n$ , Kruskal's algorithm is applied to find the minimum spanning tree of the  $n$  graphs ( $MSTG_n$ ) [17–20]. Then all the virtual layers where each of the  $G_n$  are projected in  $G_0$  and evaluated if the vertices of two  $MSTG_n$  match (i.e., two packages from two different trucks have the same delivery address). In this case, if the  $MSTG_n$  met at a previous point, if so, it is evaluated which of the two routes of the trucks minimizes the delivery costs and the delivery trucks interchange the packages. Finally, the new strategy recalculates the best routes for the transport trucks, using Dijkstra's algorithm [21–24]. We will now describe this new collaborative delivery strategy in detail. The pseudo-code of those algorithms can be found in [25].

### 2.1. Step 1: Graph design and its weights

A software has been designed that queries google maps via an API, providing a 500 m map around the transport truck. Furthermore, using a GPS application and google maps, the distances of the streets are obtained which serve to calculate the weights of the edges of the network. The software then transforms that map into a weighted graph where the edges are the streets of the map and the vertices are the crossroads of the streets. The weights of the edges are calculated in meters using the information returned by the API. This process is repeated as many times as there are delivery trucks without a graph on the last mile collaborative delivery route.

## 2.2. Step 2: Virtualization of $G_n$

Once a copy has been obtained of the map of the trucks' delivery area, it is necessary to look for some reference points previously set by the delivery company; they can be squares, streets or buildings that serve as a reference. These reference points are going to allow to suppose the different copies of the maps with their respective graphs. Therefore, we have a multiplex of graphs which will allow us to use mathematical techniques of complex networks. By using the multiplex, we can separate the different layers and project them back to the base layer ( $G_0$ ). Each of the layers of the multiplex ( $G_n$ ) is a network, making it possible to use proven network algorithms. In this way, our new strategy will use widely tested algorithms, permitting us to dedicate our time to developing other aspects of the strategy, relying fully on the network algorithms that will be used.

## 2.3. Step 3: Finding the best package routes

In each of the layers of the multiplex, the weighted graphs belonging to each of them have been constructed. Each of the  $G_n$  includes the entire last mile area of the delivery truck  $C_n$  and all the destinations of the packages belonging to each truck  $PC_n^i$ , where  $i$  is the number of the package and  $n$  is the number of the delivery truck. Once we have that graph, we apply Kruskal's algorithm to get the minimum spanning tree for that graph (i.e., we have a route that joins all the points at least once) along with the weights associated to each edge. Then, each of the  $G_n$  is projected in pairs and if any of the vertices of the graphs coincide we will have a common destination for delivery between both trucks. Then the algorithm loop again as much as necessary until all the packages are delivered.

## 2.4. Step 4: Finding the best delivery truck routes

To find the most optimal route in the last mile for each of the packages in step 3, we have found the  $MSTG_n$  for each of the delivery trucks. Once the common destinations for the delivery drivers (if any) have been found, the optimal route for each of the trucks is calculated using the Dijkstra algorithm. In case this route coincides with another delivery truck in any of the  $MSTG$  vertices of both delivery trucks, the truckers will be able to collaboratively exchange the packages so that they arrive at their destination following the most optimal route.

## 3. Results

To demonstrate the efficiency of the new collaborative sharing strategy proposed in this research, 100 replications have been made. This section describes the design of the simulations as well as the comparison of the results with the use of the proposed strategy and without it. The data used are averages of the data collected from local transport companies; their average consumption, average emissions, etc. Section 3.1 details the simulation setup and Section 3.2 quantifies the impact of our new delivery strategy on the selected Key performance indicators (KPIs). The KPIs used to compare results where the new strategy was used and where the usual last mile delivery strategy was used were: Average km per truck, Truck emissions (g/km) and carrier costs.



is insignificant, the strategy implies an average reduction in the kilometres travelled of 4.95%, while the average delivery cost savings amount to 8.65%. Regarding the  $CO_2$  emission reductions in the scenarios proposed in the simulations, it can be seen that, on average, it is reduced by 6.85% daily for each delivery truck. The results without using the strategy have been simulated using google maps and with the information of the habitual routes of the carriers of the last mile of Salamanca.

Scenario	Daily average km per truck	Daily carrier cost (Euros)	Daily $CO_2$ Level
With strategy	153.9	19	23,423.4
Without strategy	161.6	20.8	25,146.57

**Table 1.** Comparisons of strategy and non-strategy delivery kilometers traveled and their daily carrier cost. Also, one can find the average amount of  $CO_2$  emissions of the delivery trucks.

#### 4. Conclusion

This paper proposed a new strategy for the last-mile delivery problem and focused on quantifying its impacts. A modeling approach based on complex network and graph algorithms has been presented. Through a set of simulations inspired by real-life situations in a city, we highlighted the potential impact of collaborative transportation strategies on reducing carrying costs and enhancing the efficiency of services for the selected delivery trucks. Other benefits, in terms of reduced carbon emissions, were also quantified. Those enhancements prove to be quite relevant, especially for developing economies, whose cities have many delivery points (shops) to supply and inadequate logistics infrastructure for managing the increase in demand.

There are several lines of research to be followed in the future. The current work addressed the collaborative delivery in the last mile but there are some limitations in our strategy. We will implement a stochastic system that adds randomness to events that occur in transportation in the last mile, such as traffic jams, vehicle breakdowns that cut off routes, red lights that slow down delivery and so on. This type of decision problems could be of interest for public policy decision making and private delivery companies. Also, we will plan to apply this new strategy in several cities to prove the effectiveness and check for any major variations between the results of the different cities.

#### Acknowledgments

This research has been supported by the project “Intelligent and sustainable mobility supported by multi-agent systems and edge computing (InEDGEMobility): Towards Sustainable Intelligent Mobility: Blockchain-based framework for IoT Security”, Reference: RTI2018-095390-B-C32, financed by the Spanish Ministry of Science, Innovation and Universities (MCIU), the State Research Agency (AEI) and the European Regional Development Fund (FEDER).



## References

- [1] Xiao, Z., Wang, J. J., Lenzer, J., & Sun, Y. (2017). Understanding the diversity of final delivery solutions for online retailing: A case of Shenzhen, China. *Transportation research procedia*, 25, 985-998.
- [2] Wang, Y., Zhang, D., Liu, Q., Shen, F., & Lee, L. H. (2016). Towards enhancing the last-mile delivery: An effective crowd-tasking model with scalable solutions. *Transportation Research Part E: Logistics and Transportation Review*, 93, 279-293.
- [3] Casado-Vara, R., Chamoso, P., De la Prieta, F., Prieto, J., & Corchado, J. M. (2019). Non-linear adaptive closed-loop control system for improved efficiency in IoT-blockchain management. *Information Fusion*, 49, 227-239.
- [4] Moroz, M., & Polkowski, Z. (2016). The last mile issue and urban logistics: choosing parcel machines in the context of the ecological attitudes of the Y generation consumers purchasing online. *Transportation Research Procedia*, 16(2016), 378-393.
- [5] Gevaers, R., Van de Voorde, E., & Vanelslander, T. (2009). Characteristics of innovations in last-mile logistics-using best practices, case studies and making the link with green and sustainable logistics. Association for European Transport and contributors.
- [6] Kong, X. T., Li, M., Yu, Y., Zhao, Z., & Huang, G. Q. (2017, August). Physical internet-enabled E-commerce logistics park platform. In *2017 13th IEEE Conference on Automation Science and Engineering (CASE)* (pp. 406-411). IEEE.
- [7] Chen, P., & Chankov, S. M. (2017, December). Crowdsourced delivery for last-mile distribution: An agent-based modelling and simulation approach. In *2017 IEEE International Conference on Industrial Engineering and Engineering Management (IEEM)* (pp. 1271-1275). IEEE.
- [8] Arslan, A. M., Agatz, N., Kroon, L., & Zuidwijk, R. (2019). Crowdsourced delivery—A dynamic pickup and delivery problem with ad hoc drivers. *Transportation Science*, 53(1), 222-235.
- [9] Pimentel, C., & Alvelos, F. (2018). Integrated urban freight logistics combining passenger and freight flows—mathematical model proposal. *Transportation research procedia*, 30, 80-89.
- [10] Li, B., Krushinsky, D., Van Woensel, T., & Reijers, H. A. (2016). The share-a-ride problem with stochastic travel times and stochastic delivery locations. *Transportation Research Part C: Emerging Technologies*, 67, 95-108.
- [11] [https://www.ertrac.org/uploads/documentsearch/id36/ERTRAC\\_Alice\\_Urban\\_Freight.pdf](https://www.ertrac.org/uploads/documentsearch/id36/ERTRAC_Alice_Urban_Freight.pdf)
- [12] Taniguchi, E., Thompson, R. G., & Qureshi, A. G. (2018). Recent developments and prospects for modeling city logistics. *City Logistics 1: New Opportunities and Challenges*, 1-27.
- [13] Kafle, N., Zou, B., & Lin, J. (2017). Design and modeling of a crowdsourcing-enabled system for urban parcel relay and delivery. *Transportation research part B: methodological*, 99, 62-82.
- [14] Murray, C. C., & Chu, A. G. (2015). The flying sidekick traveling salesman problem: Optimization of drone-assisted parcel delivery. *Transportation Research Part C*, 54, 86-109. doi:10.1016/j.trc.2015.03.005
- [15] Zhou, L., Baldacci, R., Vigo, D., & Wang, X. (2018). A Multi-Depot Two-Echelon Vehicle Routing Problem with Delivery Options Arising in the Last Mile Distribution. *European Journal of Operational Research*, 265(2), 765-778. doi:10.1016/j.ejor.2017.08.011
- [16] Casado-Vara, R., Prieto-Castrillo, F., & Corchado, J. M. (2018). A game theory approach for cooperative control to improve data quality and false data detection in WSN. *International Journal of Robust and Nonlinear Control*, 28(16), 5087-5102.
- [17] Citra, P. (2019, October). The implementation of the Kruskal algorithm for the search for the shortest path to the location of a building store in the city of Bogor. In *IOP Conference Series: Materials Science and Engineering* (Vol. 621, No. 1, p. 012010). IOP Publishing.
- [18] Casado-Vara, R., Martin-del Rey, A., Affes, S., Prieto, J., & Corchado, J. M. (2020). IoT network slicing on virtual layers of homogeneous data for improved algorithm operation in smart buildings. *Future Generation Computer Systems*, 102, 965-977.
- [19] Dey, A., Broumi, S., Bakali, A., Talea, M., & Smarandache, F. (2019). A new algorithm for finding minimum spanning trees with undirected neutrosophic graphs. *Granular Computing*, 4(1), 63-69.
- [20] Wirabudi, A. A., Munadi, R., Rusdinar, A., Rohdiana, D., & Lee, D. H. (2019, July). Design Autonomous Drone Control For Monitoring Tea Plantation Using Dynamic Programming and Kruskal Algorithm. In *2019 IEEE International Conference on Signals and Systems (ICSigSys)* (pp. 103-109). IEEE.
- [21] Zhang, J. D., Feng, Y. J., Shi, F. F., Wang, G., Ma, B., Li, R. S., & Jia, X. Y. (2016). Vehicle routing in urban areas based on the oil consumption weight-Dijkstra algorithm. *IET Intelligent Transport Systems*,

- 10(7), 495-502.
- [22] Casado-Vara, R., Novais, P., Gil, A. B., Prieto, J., & Corchado, J. M. (2019). Distributed continuous-time fault estimation control for multiple devices in IoT networks. *IEEE Access*, 7, 11972-11984.
  - [23] Broumi, S., Bakal, A., Talea, M., Smarandache, F., & Vladareanu, L. (2016, November). Applying Dijkstra algorithm for solving neutrosophic shortest path problem. In 2016 International Conference on Advanced Mechatronic Systems (ICAMechS) (pp. 412-416). IEEE.
  - [24] Qing, G., Zheng, Z., & Yue, X. (2017, May). Path-planning of automated guided vehicle based on improved Dijkstra algorithm. In 2017 29th Chinese control and decision conference (CCDC) (pp. 7138-7143). IEEE.
  - [25] Neapolitan, R. E., & Naimipour, K. (2004). *Foundations of algorithms using C++ pseudocode*. Jones & Bartlett Learning.
  - [26] <https://www.renault.es/turismos/trafic-combi/datos-tecnicos.html>
  - [27] Sheth, M., Butrina, P., Goodchild, A., & McCormack, E. (2019). Measuring delivery route cost trade-offs between electric-assist cargo bicycles and delivery trucks in dense urban areas. *European Transport Research Review*, 11(1), 11.
  - [28] Casado-Vara, R., De la Prieta, F., Prieto, J., & Corchado, J. M. (2019, December). Improving Temperature Control in Smart Buildings Based in IoT Network Slicing Technique. In 2019 IEEE Global Communications Conference (GLOBECOM) (pp. 1-6). IEEE.

# Enhancing the spaCy Named Entity Recognizer for Crowdsensing

Julio FERNÁNDEZ-PEDAUYE <sup>a,1</sup>, Carlos PERIÑÁN-PASCUAL <sup>b</sup>  
Francisco ARCAS-TÚNEZ <sup>a</sup> and José M. CECILIA <sup>b</sup>

<sup>a</sup> *Universidad Católica de Murcia (UCAM)*

<sup>b</sup> *Universitat Politècnica de València*

**Abstract.** Social sensing leverages user-contributed data from social media by considering participants as “social sensors”, i.e. agents that provide information about their environment through social-media services such as Twitter, Facebook or Instagram. Social sensors may serve as a complementary source to physical sensors as (1) they can explain why or how specific events occurred, and (2) they can be deemed to be an alternative source in case that physical sensors malfunction or a sensor network cannot be afforded. However, one of the main challenges for social sensors is to know *where* a particular event has occurred. Social-media services rely on user preferences to geolocate their opinions, which is not really a widespread practice and, therefore, it limits the success of these techniques as early warning systems. In this paper, we analyze the spaCy named entity recognizer (NER), an open-source tool widely used by the community, to identify named entities in Spanish microtexts taken from social networks. The spaCy NER is based on Artificial Neural Networks, and our preliminary results show that further training should be undertaken to increase its accuracy. Indeed, it is well known that supervised methods are domain dependent, so their performance tends to decrease when dealing with target documents that come from a domain different from that of the training dataset. For this purpose, a training tool has been designed to automatically generate datasets suitable for spaCy NER’s training with Twitter-based microtexts in Spanish. Using the dataset generated by this tool, the spaCy NER tool increases its accuracy to 0.7 F-score, defeating by a wide margin the use of other classic datasets such as AnCorá, WIKINER or CONLL for training.

**Keywords.** named entity recognition, spaCy, social sensing, social-media analytics, geolocalization

## 1. Introduction

Mobile crowdsensing (MCS) is a recent research trend based on data collection from a large number of sensing devices [1]. In comparison with traditional physical or hard sensors, MCS is inexpensive, since there is no need to network deployment, and its spatio-temporal coverage is outstanding. Two different approaches of MCS have been distinguished, i.e. (1) mobile sensing, which leverages raw data generated from the hardware sensors that are embedded in mobile devices (e.g. accelerometer, GPS, camera or mi-

<sup>1</sup>Corresponding Author: Julio Fernández-Pedauye Campus de los Jerónimos S/N, 30107 Murcia, Spain; E-mail: jfernandez14@alu.ucam.edu.

crophone, among others), and (2) social sensing (or social networking), which leverages user-contributed data from social media. The latter considers participants as “social sensors”, i.e. agents that provide information about their environment through social-media services after the interaction with other agents. Doran et al. [2] highlighted that social sensors may serve as a complementary or an alternative source to physical sensors. Although physical sensors can identify what happened, social sensors can provide an explanation of why or how specific events may happen. Moreover, social sensors can be deemed to be an alternative source in case that physical sensors malfunction or a sensor network cannot be afforded.

There are several challenges to overcome before unleashing all the potential of social sensors [3,4]. One of these challenges has to do with recognizing and extracting exact named entities (a.k.a. Named Entity Recognition, or NER) like Persons, Locations and Organizations. This is actually very useful to mining information from text for answering a given query [5,6]. Several NER approaches have been used in different Natural Language Processing (NLP) frameworks, such as Chainer<sup>2</sup>, CoreNLP<sup>3</sup>, TensorFlow<sup>4</sup> or Spacy<sup>5</sup>. However, NER procedures are not straightforward to be conducted on texts obtained from social networks, e.g., Twitter [7]. They are usually optimized to deal with long texts that are grammatically correct and their performance degrades due to issues like variability in spelling and presence of grammatically incomplete sentences, which are generally short and noisy. Furthermore, social networks are worldwide and each culture can have different ways of communicating on them, using different languages and even writing in mixed languages with combinations of a wide variety of slang [8]. This dramatically reduces the ability of the NER modules of these frameworks to detect named entities in this context.

The great majority of NER modules of NLP frameworks are based on artificial neural networks (ANNs), which are computing systems vaguely inspired by biological neural networks. ANNs consist of many simple computing units (artificial neurons) organized in sequential layers [9]. Deep Learning (DL) algorithms for developing NER procedures are being particularly successful in this direction (we refer the reader to [10] for an up-to-date review). The success of ANN-based systems are mainly found in the training dataset. There are many NER datasets in the literature. For example, CoNLL [11] was created from newswire articles in four different languages (Spanish, Dutch, English, and German) and focused on four types of named entities - PER (person), LOC (location), ORG (organization) and MISC (miscellaneous). Moreover, AnCora [12] is a multilingual corpus annotated at different linguistic levels consisting of 500,000 words in Catalan (AnCora-Ca) and in Spanish (AnCora-Es). More recently, NER tasks have also been performed on social-media data, e.g. Twitter [13]. Named entities on Twitter are also more variable (e.g. person, company, facility, band, sports team, movie, TV show, etc.), as they are based on user behavior on Twitter. Indeed, a specific workshop is held every year since 2015 for processing noisy user-generated text, such as that found in social media, online reviews, crowdsourced data, web forums, clinical records, and language-learner essays. However, to the best of our knowledge, all tasks related to noisy text are in English and we have not found any Spanish dataset that performs well for

---

<sup>2</sup><https://chainer.org/>

<sup>3</sup><https://stanfordnlp.github.io/CoreNLP/>

<sup>4</sup><https://www.tensorflow.org/>

<sup>5</sup><https://spacy.io/>

training NER modules based on ANNs. In this article, we develop a strategy to train the SpaCy NER module to increase its accuracy when dealing with noisy-generated text obtained from Twitter. First, a dataset is automatically generated from Spanish Wikipedia. Then, the SpaCy NER module is trained with this dataset before an in-depth evaluation is carried out to demonstrate that our solution provides a good framework for Spanish NER with noisy-generated text.

The remainder of this paper is structured as follows. Section 2 introduces the SpaCy NER module, together with a description of the dataset generator and the training procedure. Section 3 presents the evaluation of our model. Section 4 provides some conclusions and directions for future work.

## 2. Method

### 2.1. spaCy Named Entity Recognizer

spaCy is a free open-source library for NLP, written in Python. It includes several features such as NER, part-of-speech (POS) tagging, and dependency parsing, just to name a few. spaCy provides a statistical NER system, which labels contiguous spans of tokens. The spanish NER model identifies several named entities, including locations, organizations and people. Moreover, programmers can include additional classes to the NER module and update the model with new examples. The statistical model is based on a transition system called BILUO. The action of predicting the transition is structured as follows:

$$EMBED \rightarrow ENCODE \rightarrow ATTEND \rightarrow PREDICT.$$

First, spaCy represents words, looking at their context to recalculate these representations. Then, it creates a summary vector of a sentence based on this contextual representation, compiling everything into a single piece of information in order to predict the next transition. In this process, the first step is the embedding, where four characteristics of each word are used, i.e. it standardizes the string, prefix, suffix, and word shape characteristics (digits replaced by d, lower case characters with w etc.), in a technique known as "hashing trick" or "bloom embeddings".

Once the out-of-context word embeddings are obtained, spaCy includes the neighboring words. In the encoding, a convolutional neural network (CNN) is used to concatenate and reduce the dimensionality of up to four words around each word in each case. In the attend stage, the extraction of characteristics is made by taking into account whether there has been a previously labelled entity and functions of arbitrary characteristics are produced. Finally, the prediction stage uses a multilayer perceptron (MLP) to predict the next action to be taken.

### 2.2. Dataset generation for training

The spaCy NER module is trained with the AnCora [12] and WikiNER [14] corpora, which are based on Spanish. As mentioned above, the results of NER procedures for social-network microtexts are not very good. This is particularly true for Spanish, where there are less resources such as datasets, NER modules, etc. To improve the accuracy of the spaCy NER model, we have developed a training corpus of 1,647,142 sentences

(467,126 after balancing) with annotated named entities, including people, places and organizations.

Wikipedia is a free-content encyclopedia with more than 1.5 million articles written by volunteers, texts that may need consensus among contributors and under the possibility of constant review and update. This makes Wikipedia a potential candidate to extract a corpus with thousands of updated phrases every day. Therefore, to achieve this training dataset automatically, an application has been developed to perform the following tasks:

1. **Read the Spanish Wikipedia data:** The application loads Wikipedia sources in XML format. Since the dump files can be several GBs, the scraping procedure must be performed carefully by loading the information in different chunks to avoid memory overflow.
2. **Storing the information:** The information is stored in a relational database, where there is a relationship between articles and the article type. This is important for eventually tagging the information with the targeted named entities.
3. **Cleaning up the information:** Once all the information has been structured in the database, the application proceeds to segment each article into sentences and label the entities found. The correct structuring in a database allows the parallelization and optimization of the process which is translated in a performance improvement.
4. **Annotation:** The annotation is carried out as follows. First, if there is a word that is found in the title of the article, the application assumes it is a noun. In this way, the named entity is tagged with the type of article, which is extracted from the XML Infobox tag. Second, based on the hypertext annotations for the internal reference links that Wikipedia uses to relate articles, we are able to unambiguously extract named entities with the Infobox tag of the article referenced. Finally, a previously trained tagger is used to get the POS tag of each word, where only nouns are selected as candidates. Potential candidates are compared with the titles of articles previously stored in the database; if an article is detected, the named entity is tagged with the associated Infobox tag of the article.
5. **Removing noise:** To avoid introducing noise, phrases that consist of only one entity or phrases below 5 words are discarded.
6. **Clustering:** Once we have the sentences tagged, a clustering of tags is carried out to classify them on the basis of three main tags: person, place and organization.

### *2.3. Training procedure*

The training of the model is performed using the spaCy training tool. In this case, we only train the named-entity detection model, but it would be possible to train others. The corpus is first organized, so that the same amount of samples is maintained for each type of entity. In this way, the model will not be more likely to find one type of entity than another. Moreover, the corpus is then randomly shuffled and, to validate the training, it is separated into 70-10-20 % for training, validation and evaluation respectively. Five groups are created using the K-Fold Cross Validation technique to check the stability of the results. Mini-batches are created incrementally and are passed to the model for training. The number of batches will result in the number of iterations for each training session.

In addition to partitioning training into small batches, the dropout hyperparameter must be adjusted, a percentage used in a regularization technique to avoid over-adjusting the model to the training data. This is an efficient and low-cost computational technique in which some nodes (layer outputs) are "dropped" during training; after several tests, we concluded that 0.1 (10%) is the most appropriate value for this setting. It is worth highlighting that two different models have been developed, one more oriented to formal texts and the other more oriented to non-formal texts. The model trained for formal texts such as news corresponds to the described above, without any additional change. For the model trained for non-formal texts such as tweets, however, several tests have been carried out in the evaluation, concluding with a combination of phrases with all the text converted to lowercase and phrases with the text as it would be formally written. In this way, the model is able to deal with the language variety found in social networks.

### 3. Evaluation

Table 1 summarizes the datasets that were used for evaluation purposes. It should be noted that some of these datasets were used for both training and evaluation. In these cases, and as explained in the Evaluation section, we didn't use the whole dataset for both tasks, but only 80% of the dataset for training and 20% for evaluation, so that over-training results could be avoided. We consider AnCora, CONLL 2002 and WiKiNER as the main "gold standards", as occurs in many other NER methods that were evaluated with these datasets. On the other hand, 'Own Corpus' refers to the automatically tagged corpus described in the Method section, and 'Manually tagged Tweets' corresponds to the model that was evaluated with 500 manually annotated tweets in Spanish.

Corpus	Labeling Mode	Data extraction	Number of sentences
AnCora <sup>6</sup>	Manual	Spanish news wire and a balanced Castilian Spanish corpus (3LB)	17.376
CONLL 2002 <sup>7</sup>	Manual	Spanish news wire articles	10.224
WiKiNER <sup>8</sup>	Automated	Spanish Wikipedia articles	114.058
Own Corpus	Automated	Spanish Wikipedia articles	467.126 (1.647.142 unbalanced)
Manually tagged Tweets	Manual	Spanish Tweets	500

**Table 1.** Dataset description.

Table 2 shows the F-score of the spaCy NER module trained with different datasets to test performance. The F-score considers both the precision  $p$ , which is the number of correct positive results divided by the number of all positive results returned by the classifier, and the recall  $r$ , which is the number of correct positive results divided by the number of all samples that should have been identified as positive. The F-score is the harmonic mean of  $p$  and  $r$ , where the best score is 1 and the worst is 0. Results indicate that by taking 20% of the data set as evaluation the best results are obtained by Own Corpus, i.e. F-score of 0.93. For AnCora, WIKINER and CONLL 2002, the results decrease to an F-score of 0.83.

For the gold standards AnCora and CONLL 2002, results are rather similar among the different training procedures, i.e. 0.65-0.67. It is noteworthy to highlight that the evaluation has not been carried out with the same dataset that was employed for training. The last row is the Manually tagged Tweets dataset, where the best results are reported for the training with Own Corpus (i.e. F-score of 0.7).

Evaluation Set	Training dataset				
	AnCora + WikiNER (spaCy)	Own Corpus	AnCora	WikiNER	CONLL 2002
20% Corpus	0.87	0.93	0.84	0.90	0.83
AnCora	n.a.	0.65	n.a.	0.63	0.67
CONLL 2002	0.61	0.60	0.66	0.60	n.a.
Manually tagged Tweets	0.33	0.70	0.38	0.37	0.36

**Table 2.** F-score of the spaCy NER module trained with different combinations of training datasets and evaluated with the evaluation datasets; n.a. means that the score was not available, because the training dataset is the same as the evaluation dataset.

#### 4. Conclusions and Future work

The detection of named entities, such as location, persons or organizations, is a fundamental task for the development of effective social-sensing tools. However, social sensors rely on social media information, and this information is generally too noisy and grammatically incorrect, limiting the ability of the NER procedures to recognize correct named entities in this context. In this paper, we have carried out an extensive evaluation of the well-known and open-source spaCy NER module. To increase its accuracy, an application has been proposed to automatically develop a training dataset from Spanish Wikipedia. Our results reveal that training the spaCy NER module with the dataset obtained with our application, the F-score improves to 0.7. We are fully aware that this is a preliminary work that evaluates a well-known NER tool with the aim to increase its accuracy. However, with the recent advances in deep-neural networks, we definitely think this is the way to go for opening new paths in developing effective NER tools.

In the future, we will work on disambiguation procedures that could actually help to provide useful information from social sensors. In addition, integrating rule-based methods into our approach could contribute to deriving the fine-grained semantics of named entities.

#### Acknowledgments

This work was partially supported by the Fundación Séneca del Centro de Coordinación de la Investigación de la Región de Murcia under Project 20813/PI/18, and by Spanish Ministry of Science, Innovation and Universities under grant RTI2018-096384-B-I00 and RTC-2017-6389-5.

#### References

- [1] B. Guo, Z. Wang, Z. Yu, Y. Wang, N.Y. Yen, R. Huang and X. Zhou, Mobile crowd sensing and computing: The review of an emerging human-powered sensing paradigm, *ACM computing surveys (CSUR)* **48**(1) (2015), 1–31.
- [2] D. Doran, K. Severin, S. Gokhale and A. Dagnino, Social media enabled human sensing for smart cities, *AI Communications* **29**(1) (2016), 57–75.
- [3] Z. Xu, L. Mei, K.-K.R. Choo, Z. Lv, C. Hu, X. Luo and Y. Liu, Mobile crowd sensing of human-like intelligence using social sensors: A survey, *Neurocomputing* **279** (2018), 3–10.
- [4] D.E. Boubiche, M. Imran, A. Maqsood and M. Shoaib, Mobile crowd sensing—Taxonomy, applications, challenges, and solutions, *Computers in Human Behavior* **101** (2019), 352–370.



- [5] A. Mansouri, L.S. Affendey and A. Mamat, Named entity recognition approaches, *International Journal of Computer Science and Network Security* **8**(2) (2008), 339–344.
- [6] J. Bakerman, K. Pazdernik, A. Wilson, G. Fairchild and R. Bahran, Twitter geolocation: A hybrid approach, *ACM Transactions on Knowledge Discovery from Data (TKDD)* **12**(3) (2018), 1–17.
- [7] J.J. Jung, Online named entity recognition method for microtexts in social networking services: A case study of twitter, *Expert Systems with Applications* **39**(9) (2012), 8066–8070.
- [8] L.C. Yang, B. Selvaretnam, P.K. Hoong, I.K. Tan, E.K. Howg and L.H. Kar, Exploration of road traffic tweets for congestion monitoring, *Journal of Telecommunication, Electronic and Computer Engineering (JTEC)* **8**(2) (2016), 141–145.
- [9] J. Schmidhuber, Deep learning, *Scholarpedia* **10**(11) (2015), 32832.
- [10] V. Yadav and S. Bethard, A survey on recent advances in named entity recognition from deep learning models, *arXiv preprint arXiv:1910.11470* (2019).
- [11] E.F. Sang and F. De Meulder, Introduction to the CoNLL-2003 shared task: Language-independent named entity recognition, *arXiv preprint cs/0306050* (2003).
- [12] M. Recasens and M.A. Martí, AnCora-CO: Coreferentially annotated corpora for Spanish and Catalan, *Language resources and evaluation* **44**(4) (2010), 315–345.
- [13] T. Baldwin, M.-C. de Marneffe, B. Han, Y.-B. Kim, A. Ritter and W. Xu, Shared tasks of the 2015 workshop on noisy user-generated text: Twitter lexical normalization and named entity recognition, in: *Proceedings of the Workshop on Noisy User-generated Text*, 2015, pp. 126–135.
- [14] J. Nothman, N. Ringland, W. Radford, T. Murphy and J.R. Curran, Learning multilingual named entity recognition from Wikipedia, *Artificial Intelligence* **194** (2013), 151–175.

This page intentionally left blank

1st International Workshop on Social Media  
Analysis for Intelligent Environment  
(SMAIE'20)

This page intentionally left blank

# Assessing the Impact of Tweets in Flood Events

Carlos PERIÑÁN-PASCUAL,<sup>a1</sup> José M. CECILIA,<sup>a</sup> Alicia SEPÚLVEDA-MUÑOZ,<sup>a</sup>

Francisco ARCAS-TÚNEZ<sup>b</sup> and Nicolás José FERNÁNDEZ-MARTÍNEZ<sup>b</sup>

<sup>a</sup> *Universitat Politècnica de València (Spain)*

<sup>b</sup> *Universidad Católica San Antonio de Murcia (Spain)*

**Abstract.** Social sensing can provide useful information to help detect, manage and solve problems related to people's lives and physical surroundings. Because of the huge amount of content generated on social media, the problem of social sensing is the varying quality of data, so it is necessary to filter out the irrelevant content returned by search requests. The goal of our research is to develop a knowledge-based system that is able to analyse tweets in Spanish to select the most salient posts with respect to a given problem (e.g. flood events). The main contribution of this article is to describe a measure that computes the salience of tweets by integrating the text-oriented perception of the problem with the network-oriented impact of the message. The system was tested with the natural disaster of a DANA that struck Spain in September 2019.

**Keywords.** Twitter, social sensor, problem detection, topic categorization, sentiment analysis

## 1. Introduction

Social sensing leverages user-contributed data from social media for crowd intelligence extraction. As explained by [1], social sensors may serve as a complementary or an alternative source to physical sensors. On the one hand, social sensors are complementary because they are able to explain why or how specific events occurred. On the other hand, physical sensors may not be available in scenarios where user-generated data are essential, e.g. emergency situations. As stated by [2], "social media has the potential to provide actionable intelligence to emergency services during a crisis". In this context, research aimed at analysing social-media content for disaster-management purposes has increased during the last decade, but "the field of natural hazard monitoring using Twitter remains fairly under-studied" [3]. The goal of this paper is to describe a knowledge-based system for social sensing where the impact of a given tweet with respect to a given problem is computed by taking into consideration not only how reliable we can feel that the message actually describes the problem (i.e. the text-oriented perception of the problem) but also how influential the message was

---

<sup>1</sup> Corresponding author: Universitat Politècnica de València, Escuela Politécnica Superior de Gandía, Paranimf 1, 46730 Gandia (Valencia), Spain; E-mail: jopepas3@upv.es

to other users (i.e. the network-oriented impact of the message). The remainder of this article is organized as follows. Section 2 describes some works related to social sensors for the detection of flood events. Section 3 provides an account of the implementation of our model to detect micro-texts describing problems. Section 4 evaluates the research and, finally, Section 5 presents some conclusions.

## 2. Related Work

Heavy rainfall can lead to severe floods that can cause disruption of critical infrastructures and human activity. Physical sensors in the form of gauging devices can only measure the amount of precipitation or the height of floodwater but not the impact on people's lives, so social sensors become a valuable source of information. Harnessing social media to create situational awareness among citizens, emergency responders and governmental agencies during natural disasters in general, and flood events in particular, has become a relevant research topic over the last few years, where most of these studies have focused on the processing of English micro-texts from a supervised approach.

Two main types of models have been used for detecting flood events in Twitter text data. On the one hand, tweets can be categorized by using machine-learning algorithms, e.g. Naïve Bayes [2,3] or logistic regression [4]. Moreover, [5] compared the performance of Decision Trees, Naïve Bayes, and Random Forests, and [6] compared Support Vector Machine (SVM), Naïve Bayes, and Random Forests; in both cases, Random Forests provided the best results. On the other hand, tweets can be categorized by using neural networks. For example, [7] used BERT (Bidirectional Encoder Representations from Transformers). [8] compared Convolutional Neural Networks with the SVM and Random Forests and demonstrated that results were similar in performance. However, a manual analysis of the errors revealed that neural networks were better at capturing semantic characteristics relevant for the task of detecting flood-related messages.

It should be noted that the performance of supervised classifiers, grounded on machine-learning or neural-network models, is limited by the size and coverage of the training dataset. Moreover, since any event of interest has its own characteristics, the model should be trained with a different dataset for every different emergency situation (e.g. earthquakes, floods or wildfires, among others), so that the performance of the system is not affected. This requirement conflicts with the development of a multi-domain system like ours, which is intended to classify new micro-texts on the ground of dynamically created categories of social problems. For all of these reasons, our solution was aimed at dealing with flood-event detection from a knowledge-based approach.

## 3. Methodology

### 3.1. Collecting Data

Micro-texts are collected by scratching the content of Twitter feeds based on user-

defined settings, such as a list of Twitter hashtags. The acquisition of tweets is performed through the Twitter API with a RESTful web service by setting specific keywords. As messages are stored in an Elasticsearch database, duplicate tweets can be filtered out by checking the MD5 hash generated for each micro-text.

### 3.2. Processing Natural Language

As we adopt a symbolic approach to problem detection, the system is provided with a knowledge base consisting of a number of datasets, e.g. CATEGORIES, SENTIMENTS, NEGATION and MODIFIERS. CATEGORIES is used to store the significant features related to a topic, in the form of stems together with their part of speech (POS). SENTIMENTS holds the stems of words associated with positive or negative polarity. NEGATION and MODIFIERS compose the main source of knowledge for valence shifters, i.e. words and phrases that affect the values of the topic and sentiment attributes of some of the ngrams in the micro-text.

In the first stage, each micro-text is split into sentences, and then each sentence is tokenized and POS-tagged. At this point, a tweet is represented as the vector  $T_m = (w_{m1}, w_{m2}, \dots, w_{mp})$ , where  $w_{mn}$  represents an object for every word that occurs in the tweet and  $p$  is the total number of words. Each  $w_{mn}$  is defined with attributes such as the position in the micro-text, the word form, the stem, the POS, the topic and the sentiment. The next stage consists in detecting significant stems with respect to the topic (i.e. category) and the sentiment. On the one hand, the weight 1 was assigned to the attribute topic of every  $w_{mn}$  in  $T_m$  whose stem and POS was found as a lexical feature  $f_{ij}$  in a category  $C_i$ , which was stored in CATEGORIES. On the other hand, the values  $p$  or  $n$  (i.e. positive or negative) were assigned to the attribute sentiment of every  $w_{mn}$  in  $T_m$  according to the polarity of the stem in SENTIMENTS. Finally, valence shifters are applied to neighbouring words within the micro-text. Negation cues make all the ngrams in the scope be no longer significant for topic and sentiment, so the values of their attributes are re-computed to 0. By contrast, intensifiers and diminishers change the degree of polarity of the ngrams involved by multiplying the values of the above attributes by 3 or 0.5, respectively. Whereas negation cues are applied to all the words within the scope, modifiers act only on the first polar expression that is found in the scope. The scope of valence shifters is three words, where the direction of this scope is determined by the information included in NEGATION and MODIFIERS.

### 3.3. Detecting Problems

We aim to determine the salience of user-generated text data by analysing two dimensions of messages. On the one hand, the text dimension helps us assess the relevance of the message, i.e. if the message contributes to situational awareness for managing a problem related to an in-progress event. On the other hand, the network dimension helps us assess the magnitude of the problem, i.e. we focus on the range of individuals concerned with the problem and the extent of their reactions. In this context, the most salient tweets for a given problem are detected by means of the Problem-Impact Index (PII), which combines the language-aware approach of the Problem-Perception Index (PPI) with the language-agnostic approach of the Tweet-Impact Index (TII). The remainder of this section provides a detailed account of the measures employed to obtain these scores.

### 3.3.1 Computing the Problem-Perception Index

The PPI is calculated not only to measure how reliable we can feel that a given tweet deals with a problem about a given hazard but also to set alert thresholds from which the severity of the problem could be rated. This measure consists of two components, i.e. Category ( $C_i$ ) and Sentiment ( $S$ ), as shown in Eq. (1).  $PPI(T_m)$  outcomes normalized values.

$$PPI(T_m) = \sqrt{C_i(T_m) * S(T_m)} \quad (1)$$

The computation of the PPI involves two steps. On the one hand, we calculate the Category score using cosine similarity as a measure of semantic distance. In our case, we deal with binary values for topic relatedness and the number of topic-related stems in  $T_m$  is equal to or less than the number of relevant features in  $C_i$ . Therefore, the relatedness function between  $T_m$  and  $C_i$  can be reduced to Eq. (2), where  $w$  is the number of words (unigrams) in  $T_m$  that correspond to a category feature of  $C_i$  and  $f$  is the number of all the features that serve to describe  $C_i$ .

$$C_i(T_m) = \frac{w}{\sqrt{w} * \sqrt{f}} \quad (2)$$

Indeed,  $C_i$  is regarded as the function that computes the Category score for a specific tweet with respect to a specific topic of interest. Therefore, a tweet is linked to a given category if the Category score is greater than 0.

On the other hand, we calculate the Sentiment score of given tweet with a measure originally used to assess political positions in texts. Particularly, [9] proposed the logit scale to locate party positions (i.e. left or right) on a continuous scale from the sentences of political texts that were previously coded into these two categories. Indeed, this scaling procedure allows the system to convert the counts of sentiment-coded stems in  $T_m$  into a point on the sentiment dimension by means of Eq. (3), where  $p$  and  $n$  refer to the total value of positively and negatively marked ngrams in  $T_m$ , respectively, and  $\alpha$  is a user-adjustable parameter ranging from 0 to 1.

$$S(T_m)' = \log(p + 0.5) - \log(n + 0.5) \quad (3)$$

$$S(T_m) = \begin{cases} 1 - \frac{1}{\log(|S(T_m)'|+2)} * \alpha & , \text{ if } S(T_m)' < 0 \\ 0 & , \text{ if } S(T_m)' \geq 0 \end{cases}$$

### 3.3.2. Computing the Tweet-Impact Index

Three types of measures have been devised to discover influential users in Twitter [10]:



(a) activity measures, where “users are *active* when their participation in the social network is constant and frequent in a period of time”, (b) popularity measures, where “a user is *popular* when he is recognized by many other users on the network”, and (c) influence measures, where “a user is *influential* whether his actions in the network are capable to affect the actions of many other users in the network”. In our case, activity and popularity measures are not pertinent, since a tweeter who is not very active or popular can post a high-impact message. Therefore, our research focuses on influence measures. In this regard, the inventory of influence measures in [11] was rather inspiring. However, since we are concerned with searching for influential messages instead of influential users, we adapted their measures for our purposes.

In this context, we devised the TII measure, which consists of three components, i.e. Retweet Impact (RTI), Reply Impact (RPI) and Information Diffusion (ID). The TII measure is computed with Eq. (4), where  $q$  is the number of unique users who retweeted  $T_m$ ,  $r$  is the number of unique users who replied  $T_m$ ,  $a$  is the number of unique users who posted original tweets (i.e. neither retweets nor replies) on  $C_i$  after  $T_m$ ,  $b$  is the number of unique users who posted original tweets on  $C_i$  before  $T_m$ , and  $\beta$  is a user-adjustable parameter where  $\alpha + \beta = 1$ .  $TII(T_m)$  outcomes normalized values.

$$TII(T_m)' = RTI * RPI * ID$$

$$RTI = \log(q + 2)$$

$$RPI = \log(r + 2)$$

$$ID' = \log(a + 1) - \log(b + 1) \quad (4)$$

$$ID = \begin{cases} ID' & \text{if } ID' > 0 \\ 1 & \text{if } ID' \leq 0 \end{cases}$$

$$TII(T_m) = \left(1 - \frac{1}{\log(TII(T_m)'+1)}\right) * \beta$$

To gain a better understanding of this measure, an explanation of the notions “time frame” ( $TF$ ) and “time slice” ( $TS$ ) is required. Suppose that  $\tau$  represents the stream of tweets, which are posted along a succession of  $TF$ s. In turn, each  $TF$  consists of a series of  $TS$ s of the same length, which can be seconds, minutes or hours. In other words,  $\tau = \{TF_1, TF_2, \dots, TF_k\}$  and  $TF_m = \{TS_1, TS_2, \dots, TS_n\}$ , where  $k$  and  $n$  represent the number of  $TF$ s and the number of  $TS$ s, respectively. In this context, we use  $TS_r$  to refer to the time slice that becomes the focus of interest, e.g. the  $TS$  in which the tweet under analysis was posted. It is noteworthy that the temporal unit of  $TF$  and  $TS$  should be determined in accordance with the task in mind. For example, in the case of first responders, who must rapidly identify and understand high-impact events,  $TF$  and  $TS$  will be shorter than in the case of a system tailored for journalists.

Suppose that  $P$  contains all the original tweets whose PPI is greater than 0, being  $P \subseteq T$ , then it can be asserted that, for example,  $P_{TS_r}$  represents the set of all the original tweets whose PPI is greater than 0 that were posted in the current  $TS$ , or  $P_{TS_1, TS_3}$  represents the set of all the original tweets whose PPI is greater than 0 that

where posted during  $TS_1$ ,  $TS_2$  and  $TS_3$ . Therefore, back to the ID formula in Equation (4), if  $T_m$  is posted in  $P_{TS_r}$ , then  $a$  can be formally described as  $|P_{TS_1, TS_{r-1}}|$  and  $b$  as  $|P_{TS_{r+1}, TS_n}|$ . It should also be noted that RTI, RPI and ID take into consideration only tweets that were posted in the same  $TF$  in which  $T_m$  was posted.

Unlike the PPI, which takes the form of a static score, the TII provides a dynamic score for  $T_m$ , which becomes static only when  $T_m$  pertains to a past  $TF$ .

### 3.3.3. Computing the Problem-Impact Index

Finally, the PII measure assesses the impact of  $T_m$  on the basis of the PPI and the TII, which can be computed in parallel through Eq. (5).

$$PII = \sqrt{PPI(T_m) * TII(T_m)} \quad (5)$$

The strength of the PII is that the PPI and the TII are complementary. On the one hand, the PPI is derived from semantic information regarding the author's attitude towards the topic of interest, which can serve to detect significant messages that, however, could not be able to generate massive activity on social media. On the other hand, the TII yields insight into data traffic on social networks, which can amplify the signal of the most influential tweets. To conclude, Figure 1 illustrates the whole process of problem detection.

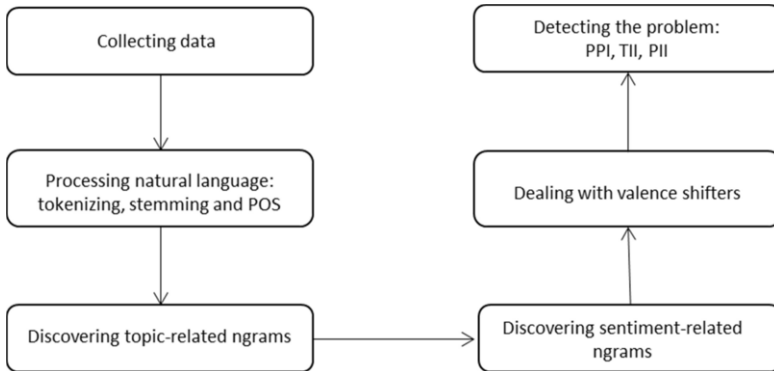
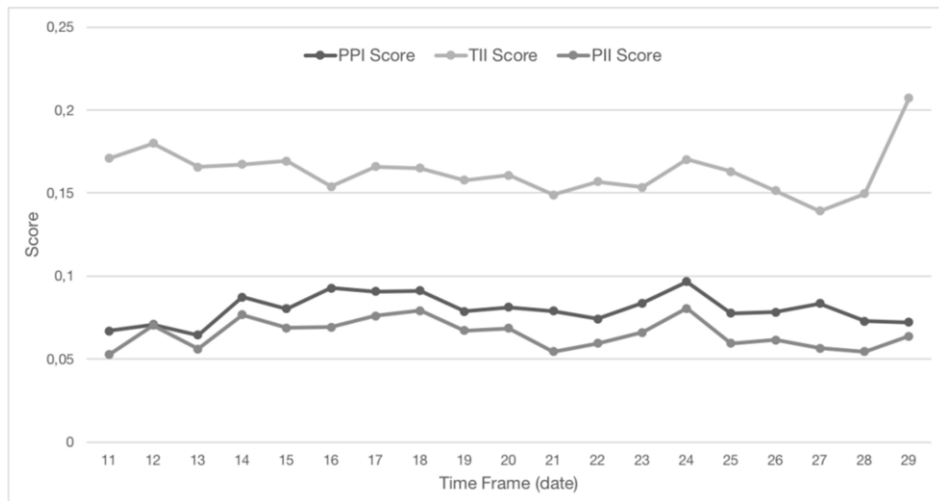

Figure 1. Knowledge-based system for problem detection.

## 4. Evaluation

We evaluated the research with a corpus of 8,036 tweets posted during a slow-moving storm system, officially known as a "high-level isolated depression" (Depresión Aislada en Niveles Altos, DANA), that affected about 30,000 people almost all over Spain in September 2019. In this experiment, five representative words of the event (i.e. DANA, *desbordamiento* [overflowing], *deslizamiento* [landslide], *inundación* [flood], and *lluvia* [rain]) were used to semi-automatically determine the significant

features of this type of category (e.g. *aguacero* [downpour], *anegar* [flood] or *diluvio* [deluge], among many others).<sup>2</sup> Then, tweets dated from 11 to 29 September 2019 were retrieved by setting the significant features of the Flood category as specific keywords through the Twitter API. Figure 2 shows the averaged PPI, TII and PII scores derived for each *TF* (one day). The value of  $\alpha$  and  $\beta$  in Eq. (3) and Eq. (4), respectively, was 0.5.



**Figure 2.** Averaged PPI, TII and PII scores on a time-frame basis.

To contextualize the results, we employed two supplementary information sources: meteorological reports, which give a scientific account of the occurrence of the event, and news articles, which provide insights into the situation of the event. On the one hand, the State Meteorological Agency (AEMET) reported the most relevant facts during the period under study:<sup>3</sup>

- 12 Sept: 300mm of rainfall in 24 hours in East and Southeast Spain (i.e. the provinces of Valencia, Alicante, Murcia, Albacete and Almería)
- 13 Sept: 200mm of rainfall in 24 hours in the provinces of Alicante and Murcia
- 14-15 Sept: the storm is moving Northwest and North Spain
- 16-17 Sept: a new DANA is moving Southwest Spain
- 18 Sept: torrential rain and severe storms in large parts of the country
- 23 Sept: Hurricane Humberto brings heavy precipitation and strong winds on the Northern coast of Spain

<sup>2</sup> The WordNet-based process of lexical expansion was described in [15].

<sup>3</sup> The information was obtained from the 9-15 September report (<https://aemetblog.es/2019/09/20/informe-operativo-de-la-semana-del-9-al-15-de-septiembre-de-2019/>), the 16-22 September report (<https://aemetblog.es/2019/09/23/informe-operativo-semanal-semana-del-16-al-22-de-septiembre-de-2019/>), and the 23-29 September report (<https://aemetblog.es/2019/10/16/informe-operativo-semanal-del-23-al-29-de-septiembre-de-2019/>).

On the other hand, news agencies (e.g. Agencia EFE) reported the adverse effects of the floods:<sup>4</sup>

- 12 Sept: almost 300 people evacuated in Murcia
- 13 Sept: Emergency Response Plan activated in Almería; River Segura overflows; railway services suspended in Murcia, Albacete, Valencia and Alicante; the Government of Murcia strongly recommends not using the car; five people dead
- 14 Sept: President Sánchez visits flood-stricken areas in Alicante and Murcia; overflowing rivers cause the isolation of several populations and many road and railway blockages
- 15 Sept: 1,500 people evacuated from a campsite

We can conclude that the peak areas of PII shown in Figure 2 correspond to (a) the first day of the DANA (i.e. 12), (b) the day after the critical point of the storm (i.e. 14), (c) the arrival of a new DANA (i.e. 17 and 18), and (d) the effects of Hurricane Humberto (i.e. 24).

Moreover, we performed a qualitative analysis to determine if our model is able to select the messages that contribute to understanding the crisis situation on the ground, thus creating situational awareness. In this regard, for example, researchers such as [12] and [13], among others, employed a test dataset where instances had been categorized by crowdsourcing workers on the basis of informativeness (i.e. related and informative, related but not informative, not related, and not applicable). As demonstrated by [14], informativeness proves to be a rather subjective category. For this reason, we chose to classify a sample of the tweets with respect to five categories that are aimed at providing citizens, emergency responders and governmental agencies with actionable information about what is happening in the affected communities during the event:<sup>5</sup>

- Mitigation (i.e. tweets reporting information about actions that can prevent the disaster or reduce the effects of the disaster)
- (6) La falta de limpieza en los cauces es la clave en la tragedia de la gota fría de estos días.
- Preparedness (i.e. tweets reporting information about preparation, emergency plans, staying home and keeping safe, stocking up goods, evacuation, advice for behaviour during the disaster, or monitoring and tracking the disaster)
- (7) La gente de Fulgencio me cuenta que están esperando a que llegue el agua ya a la zona, que ya ha anegado Dolores.
- Impact (i.e. tweets reporting information about closing businesses, disaster-caused deaths, problems with internet and utility services, infrastructure damage, things or people affected, or commuting problems)

---

<sup>4</sup> <https://www.efe.com/efe/espana/>

<sup>5</sup> These categories serve to reflect the main stages in which disaster management is traditionally modelled. Moreover, as suggested by [16], we include Impact, which is crucial for disaster response.

- (8) Cientos de hectáreas continúan anegadas en la zona 0 de la riada del río Segura
- Response (i.e. tweets reporting information about disaster response and recovery organizations, staying in a shelter, getting free meals, emergency power, or rescues of disaster victims)
- (9) Cada gota suma. Han empezado a llegar camiones de @CREAndalucia con toneladas de provisiones de agua para abastecer a las familias afectadas por la #DANA en la provincia
- Recovery (i.e. tweets reporting information about reopening businesses, removing debris, getting back to work, school or home, return of internet and utility services, fund raising and donation, repairing or rebuilding infrastructure, relief actions, or restoration of transportation services)
- (10) El gobierno de la Generalitat aprueba unos míseros 23.500.000 euros de ayuda para los damnificados de las riadas de la pasada semana

In particular, the 100 most-significant tweets in our test dataset, i.e. those with the highest PII score, were manually annotated with the above categories, resulting in the following distribution: 39% Impact, 25% Other, 13% Recovery, 11% Preparedness, 10% Mitigation, and 2% Response. It should be noted that the category Other covers disaster-related tweets that are generally regarded as relevant in other studies but that were irrelevant in this experiment because they do not provide meaningful data to make a decision or solve a problem in the context of this particular event, as shown in Ex. (11) and Ex. (12).

- (11) Un edil de la CUP se ríe de los policías que combaten la gota fría y les amenaza: "Mirad debajo del coche"
- (12) En verdad tenemos lo que nos merecemos por estar cargándonos el planeta así que no se de que coño nos quejamos

Therefore, we conclude that precision in the 100 top-ranked tweets is 0.75.

## 5. Conclusions and Future Work

Social sensing is a two-way communication channel between organizations and individuals, since not only governmental agencies can deliver official information to citizens but emergency managers can also gain insight by monitoring their posts. In this context, this research demonstrated that inspecting user-generated text data allows learning what people are thinking and doing with respect to a given disaster (e.g. flood events), thus providing actionable information to be used in disaster-risk reduction and response. Future research is mainly aimed at applying a multilingual, multidomain and multimodal approach to our model of problem detection.

## Acknowledgments

Financial support for this research has been provided by the Spanish Ministry of Science, Innovation and Universities [grant number RTC 2017-6389-5].

## References

- [1] Doran D, Severin K, Gokhale S, Dagnino A. Social media enabled human sensing for smart cities. *AI Communications*. 2016;29:57–75.
- [2] Spielhofer T, Greenlaw R, Markham D, Hahne A. Data mining Twitter during the UK floods: Investigating the potential use of social media in emergency management. In: 2016 3rd International Conference on Information and Communication Technologies for Disaster Management (ICT-DM). 2016. p. 1–6.
- [3] Arthur R, Boulton CA, Shotton H, Williams HTP. Social sensing of floods in the UK. *PLoS ONE*. 2018;13(1):1–18.
- [4] Barker JLP, Macleod CJA. Development of a national-scale real-time Twitter data mining pipeline for social geodata on the potential impacts of flooding on communities. *Environmental Modelling & Software*. 2019;115:213–27.
- [5] Nair MR, Ramya GR, Sivakumar PB. Usage and analysis of Twitter during 2015 Chennai flood towards disaster management. *Procedia Computer Science*. 2017;115:350–8.
- [6] Moutzidou A, Andreadis S, Gialampoukidis I, Karakostas A, Vrochidis S, Kompatsiaris I. Flood Relevance Estimation from Visual and Textual Content in Social Media Streams. In: Companion Proceedings of the The Web Conference 2018. Republic and Canton of Geneva, CHE: International World Wide Web Conferences Steering Committee; 2018. p. 1621–1627. (WWW '18).
- [7] de Bruijn JA, de Moel H, Jongman B, de Ruyter MC, Wagemaker J, Aerts JCJH. A global database of historic and real-time flood events based on social media. *Scientific Data*. 2019;6(1):311.
- [8] Lorini V, Castillo C, Dottori F, Kalas M, Nappo D, Salamon P. Integrating Social Media into a Pan-European Flood Awareness System: A Multilingual Approach. In: Proceedings of 16th ISCRAM Conference. Valencia; 2019.
- [9] Lowe W, Benoit K, Mikhaylov S, Laver M. Scaling Policy Preferences from Coded Political Texts. *Legislative Studies Quarterly*. 2011 Feb 1;36(1):123–55.
- [10] Riquelme F, González-Cantergiani P. Measuring User Influence on Twitter. *Information Processing and Management*. 2016;52(5):949–975.
- [11] Pal A, Counts S. Identifying Topical Authorities in Microblogs. In: Proceedings of the Fourth ACM International Conference on Web Search and Data Mining. New York, NY, USA: Association for Computing Machinery; 2011. p. 45–54. (WSDM '11).
- [12] Olteanu A, Vieweg S, Castillo C. What to Expect When the Unexpected Happens: Social Media Communications Across Crises. In: Proceedings of the 18th ACM Conference on Computer Supported Cooperative Work & Social Computing. New York, NY, USA: Association for Computing Machinery; 2015. p. 994–1009. (CSCW '15).
- [13] Zhang Y, Szabo C, Sheng QZ, Zhang WE, Qin Y. Identifying Domains and Concepts in Short Texts via Partial Taxonomy and Unlabeled Data BT - *Advanced Information Systems Engineering*. In: Dubois E, Pohl K, editors. Cham: Springer International Publishing; 2017. p. 127–43.
- [14] Perrián-Pascual C, Arcas-Túnez F. The Analysis of Tweets to Detect Natural Hazards. In: Chatzigiannakis I, Tobe Y, Novais P, Amft O, editors. *Intelligent Environments 2018*. Amsterdam: IOS Press; 2018. p. 87–96.
- [15] Perrián-Pascual C, Arcas-Túnez F. Detecting environmentally-related problems on Twitter. *Biosystems Engineering*. 2019;177:31–48.
- [16] Huang Q, Xiao Y. Geographic Situational Awareness: Mining Tweets for Disaster Preparedness, Emergency Response, Impact, and Recovery. *International Journal of Geo-Information*. 2015 Aug 28;4:1549–68.

# Realisation of Usability Tests: A Social Media Marketing Software Development Case

Christina EBERHARTER<sup>a</sup> and Anna FENSEL<sup>b, 1</sup>

<sup>a</sup>*Department of Information Systems, Production and Logistics Management, University of Innsbruck, Austria*

<sup>b</sup>*Semantic Technology Institute (STI) Innsbruck, Department of Computer Science, University of Innsbruck, Austria*

**Abstract.** Social networks such as Facebook, Twitter or LinkedIn opened the door for new ways of online marketing—social media marketing. In order to use social networks efficiently for marketing purposes and reach (potential) customers, marketers rely on social media marketing software (SMMS), supporting companies and individuals with publishing, engaging, promoting or listening on social media networks. In order to make a competitive SMMS, some of the most important quality factors are usability and user experience. In practice, often only user interface (UI) experts are used for design updates as usability tests can be time intensive and costly. Based on the use case of the social media management tool Onlim ([www.onlim.com](http://www.onlim.com)), the extent to which usability tests can detect user experience issues and suggest improvements was studied by conducting a usability lab. The data of 20 participants of the conducted usability lab was used for an in-depth analysis. The analysis identified fifteen usability problems whereas five are system and ten operational problems. Overall only 40% of the problems were resolved through the implementation of a new UI design when not taking usability tests outcomes into account, and 60% of the problems still remain in the new interface or are only partly solved. Therefore, on an example of SMMS, it has been shown that the usability tests on one hand are valuable, and on the other hand, are difficult to incorporate in the development of the software in rapidly evolving fields.

**Keywords.** usability, software development, web applications, social media, online marketing

## 1. Introduction

Nowadays users communicate on a regular basis with each other via online social platforms. According to [7] from Tech Crunch, by June 2017 Facebook had 2 billion monthly active users and was one of the largest social networks with a global reach. Other popular social networks like Twitter and Instagram reported 328 million and 700 million monthly active users, respectively [7]. Besides general social media networks, business social networks gained attractiveness. LinkedIn, for example, has over 310 millions of active users per month in 2020 [2].

---

<sup>1</sup> Corresponding Author: Anna Fensel, Semantic Technology Institute (STI) Innsbruck, Department of Computer Science, Technikerstrasse 21a, Innsbruck, 6020 Austria; E-mail: [anna.fensel@sti2.at](mailto:anna.fensel@sti2.at).

This importance of social media and the resulting opportunity to reach out to target groups, publish information, and engage with customers in a bi-directional way signals an immense value for companies of all sizes and types of businesses. Utilizing social media as part of a company's online marketing strategy often means not only using one social platform but being present on several platforms simultaneously to increase a firm's online visibility and engagement [1]. Managing and monitoring online presence can be a time-consuming task, therefore most organizations make use of online social media management tools to manage their social media accounts. One well recognized social media management tool is Hootsuite ([www.hootsuite.com](http://www.hootsuite.com)), which allows scheduling posts in advance, monitoring, and posting to multiple platforms. Other providers of similar management tools include Buffer ([www.buffer.com](http://www.buffer.com)), TweetDeck ([www.tweetdeck.com](http://www.tweetdeck.com)), and Sprinkler ([www.sprinkler.com](http://www.sprinkler.com)).

Competition among social media management tools is substantial. Since it is easy to switch providers of such Web applications, these providers have the obvious goal of pleasing their users to keep the musing the application. One important factor in achieving user satisfaction is ensuring an application's high usability. If applications are poorly designed and lack ease of use, users will reject them. Therefore, a main objective of Web applications is that the user achieves his or her goal effectively, efficiently, and satisfactorily [14]. According to [3] usability can be defined as "the ease of use and acceptability of product for a particular class of users carrying out specific tasks in a specific environment".

Usability is not a one-time task conducted in the Web application, it is more an iterative process throughout development and beyond. To ensure well-specified usability of the final product, usability itself must be seen as an ongoing series of actions [14]. Usability feedback is currently often difficult to implement practically, but its importance is still considered to be important in theoretical research [5]. In our work, we confirm the latter thesis from a practical perspective.

In the domain of information systems, the term usability is mostly associated with software development and Web applications. As social media management tools can be assigned to the category of Web applications as well, usability also plays a decisive role for these tools. Therefore, based on the example use case of the social media management tool Onlim ([www.onlim.com](http://www.onlim.com)), this paper aims to identify to which extent usability testing of social media management tools can be useful for the improvement of the tools. This leads to the following research question:

➤ To what extent can usability tests detect user experience issues and consequently improvements for the use case of a social media management tool?

The practical questions applicable to the use case included identification of the weaknesses exist in previous user experiences, problems when performing tasks in Onlim, issues resolved over time through a regular software development process without having explicit feedback from a usability test.

The structure of this paper is as follows. Section 2 a theoretical analysis that introduces the background and the state of the art in the main research fields: social media marketing, usability and common usability tests. In Section 3, the use case is explained with some background information about the company, including a description of the software's features and the current UI. Section 4 introduces the applied methodology for the practical application of a usability lab. Section 5 examines into evaluation of the results of the applied method that form the basis for proposing usability improvements for Onlim as well as general recommendations for SMMS. Section 6 concludes the paper.



## 2. Background and Related Work

In the following subsections, two relevant topics are discussed to provide a better understanding of the subject of this work: the content and social media marketing, usability and user experiences within Web applications.

### 2.1. Social Media and Content Marketing

Social media is often used as a synonym for Web 2.0. According to [13], social media is “a group of Internet-based applications that build on the ideological and technological foundations of Web 2.0, and that allow the creation and exchange of User Generated Content”. In general, social media allows people to connect to each other, form communities and share knowledge, experience and user generated content (UGC). In addition, the authors state that UGC describes “the various forms of media content that are publicly available and created by end-users” [13]. A more open definition for self-interpretation is given by [21] who define social media as “the online means of communication, conveyance, collaboration, and cultivation among interconnected and interdependent networks of people, communities, and organizations enhanced by technological capabilities and mobility”.

Web 2.0 and all its forms of social media created a shift in market power and also changed the consumer behavior of individuals. Market power shifted from producers toward the direction of consumers. The main reasons for such a power transfer include that through the new functions of Web 2.0, such as bi-directional communication between users, new created communities and social networks, users are allowed to access more information and knowledge than before [6]. Furthermore, brand information is not only provided through corporate Web sites or mass media, but information and experiences about products are shared by the consumers themselves [6].

Prior to Web 2.0, market power was centralized on the producer side and only traditional marketing was applied. Organizations made use of the marketing mix to reach their goals of creating, communicating and delivering offers that have value to customers. The marketing mix consists of the 4 Ps which stand for *product, price, promotion and place* [21]. Through the emergence of social media marketing, the state that a fifth *P*, which stands for participation, should be added to the marketing mix [21]. The authors argue that consumers' daily lives are changed through social media and therefore marketers also need to reshape how they are doing marketing. Using social media for business and marketing purposes means to take part in it and, particularly if it is to create brand awareness, maintain relationships with customers or promote new products [21]. Participatory systems involving the users actively in the information sharing are currently intensively investigated, including the systems enabling sharing of the data that have a potential private character [10].

### 2.2. Usability and User Experience in Web Applications

As the term usability is widely used in different research fields, there are many definitions. In the field of Human-Computer Interaction (HCI) the most common definition is provided by the International Organization for Standardization (ISO). The standard ISO 9241-11 for human-system interaction [10] defines usability as “the extent to which a system, product or service can be used by specified users to achieve specified goals with effectiveness, efficiency and satisfaction in a specified context of use”.

According to [9] this definition applies best to the perspective of human interaction, as it focuses on the interaction of users with software products and the capability to meet customer expectations. Another widely-accepted definition comes from the Software Engineering (SE) field. ISO 9126-1, the predecessor of ISO 25000, provides the following definition [9]: “the capability of the software product to be understood, learned, operated, attractive to the user, and compliant to standards/guidelines, when used under specific conditions”. This definition sees usability as an attribute of the software product quality and does not necessarily imply the interaction with users as usability is a characteristic that just needs to conform to predefined specifications [9]. As standards define usability in different ways, [4] defined two categories, the “top-down” approach which defines usability as a quality objective with reference to ISO 9241-11 and the “bottom-up” approach which focuses on a product-oriented view where usability is seen as an attribute of software quality with reference to standard ISO 9126. For the purpose of this paper the usability definition from ISO 9241-11 applies throughout.

In Web engineering, usability is seen as a quality factor. Usability describes the product quality from a user standpoint and provides answers to occurring problems between people and technology interaction [17]. Web usability as it is also called in web engineering recognizes the usability definition provided by ISO 9241-11, but also states that the usability definition provided by [18] is commonly used. [18] states, that usability must be “systematically approached, improved and evaluated” in order to have measurable criteria which support the goal to move toward “an engineering discipline where usability is not just argued about”.

One of the most common usability evaluation methods is a usability lab conducted with a small number of participants. Typically, only 5-10 participants take part in such a test, as it requires one-on-one sessions between participant and moderator. This form of a moderated usability study allows the moderator to ask questions about the product itself, records the user’s behavior and gives the participant a set of tasks to complete related to the product. The advantage of such a moderated usability lab is that the moderator can question specific actions the participant performed, providing more insights. Furthermore, the thinking out loud method is often applied so that the participant expresses his/her thoughts out loud while performing the tasks. The whole session is recorded in order to evaluate data afterwards. This form of evaluation is often used in formative studies for iterative design improvement during the development phase [12, 20]. The main metrics collected focus on issues, their frequency, severity and type. Other metrics that are also tracked include performance metrics, such as success rate, task success, error rates, time on task, or efficiency.

### 3. Use Case

A Tyrolean based start-up Onlim ([www.onlim.com](http://www.onlim.com)) that provides online marketing solutions builds the fundament of this work. The main purpose of the usability part of this work is to evaluate the usefulness of usability tests based on a conducted usability lab on the Onlim social media management UI. The results have been compared with a new UI solution to discover if all usability problems are solved through the new UI created by user experience specialists without more extensive user experience testing with users.

The company provided a solution for managing social media profiles. As this market is already well served with Software as a Service (SaaS) applications from competitors,

the company started out by targeting the Austrian Tourism sector and made use of semantically-enabled online communication in their application [8]. The innovative tool set based on semantics, learning algorithms, and rules is the foundation of Onlim and therefore provides an easy-to-use platform for creating, managing and distributing content to several social media channels such as Facebook, Twitter and LinkedIn. An additional new feature is the chatbot which operates on the same platform. The Onlim team creates customized chatbots for customers which can be integrated into corporate Web sites and Web- based applications.

Onlim provided SaaS and comprises several features which make the life of a content marketer much easier in maintaining and feeding their social media channels. Among the main strengths of Onlim are the various content sources like Web sites, blogs or RSS feeds for a semi- automated content creation process. The available functions have included *Dashboard, New Post, Calendar, News Feed, Statistics, Channels, Chatbot LiveChat, Chatbot Content, Tutorials*.

#### 4. Methodology

Here we describe the procedure of the usability lab based on the use case. The lab test is a qualitative user test conducted with the support of an online usability tool that allows background or screener questions, tasks and follow-up questions to be setup. The usability lab is based on the usability study scenarios of [20], a more precise combination of “completing a transaction”, “evaluating navigation and/or information architecture” and “problem discovery” scenarios. Completing transactions and navigation evaluation make use of task success and efficiency metrics. Tasks are defined through a clear beginning and end, and are measured for task success, failures and efficiency. Problem discovery is often used for already existing products in order to identify significant usability issues.

Participants go through a predefined script of tasks and questions. In order to understand the participants’ thoughts as they interact with the tool, the concurrent thinking-aloud technique was applied [12], and the participants were asked to think out loud and give comments during performing the tasks. During the entire session, audio and screen activities were recorded. At the end of the session, participants answered four questions about the tested application, Onlim. The goal of the usability lab was to identify design improvements for an increased user satisfaction and ease of use before comparing it to the latest UI design of Onlim. The following functions/sections were examined:

- Registration and connecting of social media accounts,
- Help function/demo: page guide for new post section,
- Use of suggested RSS feeds and Facebook pages
- Use of calendar and draft function,
- Creation and scheduling of posts.

As a support tool for the evaluation of the usability lab, a Web tool for recording the user interaction was used in order to capture participants’ screen movements and oral comments. The usability testing platform used for the lab was Try My UI ([www.trymyui.com](http://www.trymyui.com)).

Planning a usability lab also requires determining what to measure to get an accurate, overall picture of the user experience. It is crucial to look on performance as well as on satisfaction metrics. Performance focuses on the user’s interaction with the product, whereas satisfaction deals with the user’s thoughts and words about his/her product

interaction. Most of the time, performance and satisfaction go hand-in-hand, although, performance and satisfaction does not always correlate [20]. The following metrics selected to be measured in the usability study were based on performance and satisfaction metrics [20]: *Time on task*, *Task success*, *Task completion perceived by user*, *Single Ease Question (SEQ)*, *Open-ended questions*. For the last metric, the following four questions provided by the online usability support tool were used in the Onlim usability lab:

- o What was the worst thing about your experience?
- o What other aspects of the experience could be improved?
- o What did you like about the Web site?
- o What other comments do you have for the owner of the Web site?

For analyzing the participants feedback, the MAXQDA software for qualitative and mixed methods research ([www.maxqda.com](http://www.maxqda.com)) was used in order to summarize and segment the verbatim comments. The code system for segmenting the answers to open-ended questions is derived from the answers itself.

After defining performance and satisfaction metrics for the usability study, the tasks were further defined based on the main functionality and Onlim's user goals. Table 1 lists the defined tasks which were performed by all participants. In addition to the tasks, each participant was asked to answer four open-ended questions, listed above, after completing the usability lab.

## 5. Results

In addition to the real-life usability study, an online usability study also was performed through crowdsourcing. In total, 20 out of 27 participants could be used for the analysis. Seven participants were excluded due to incomplete data sets. Eleven participants were from the online tester community of the usability testing platform and nine participants performed the real-life usability lab. Fifteen (75%) participants were male and five (25%) were female, all ranging from 18 to 54 years old. All participants were located in North America or Europe, had a college or university degree, and were daily social media users. The maximum length of the usability test was set at 30 minutes, as this was the maximum per-session recording time offered by the support tool, *try my UI*, for individual sessions. Therefore, the six tasks for the usability test, listed in Table 1, were defined in a way that an average experienced Web user could manage all tasks within 30 minutes. The following metrics were measured for the usability lab: time on task, task completion, level of success, and single easy questions. In addition to these metrics, four open-ended questions were asked at the end of the usability lab. The first metric to be measured was the time on task, providing a first impression of the overall performance of the participants for each task. The three longest times were measured for tasks 1, 3 and 6. These are also the tasks with the longest error bars, indicating a broader range of participant time per task results. It was also the first indication that the participants struggled the most with these specific tasks. This was then confirmed through the results of the successful completion rate by task and the level of success metrics. The biggest failure rate was detected in task 3, involving the selection, publishing, and saving as drafts of suggested posts. Also, a quite high rate of problems appeared in the level of success analysis for tasks 1, 4 and 6. The SEQ allowed the participants to rate the level of difficulty for each task (1 = very difficult, 7 = very easy). For all tasks the average SEQ

was above 5 and three tasks were rated with a 6 or higher, indicating that overall the tasks were not perceived as very difficult by participants.

**Table 1.** Task Descriptions

Task ID	Task asked to be performed	Associated functions in Onlim
1	Register to Onlim, connect social media account, walk-through with page guide for post creation	Participants should go to the Onlim page, register themselves and connect one to two of their social media accounts. Afterwards, the page guide walks them through the post-creation process.
2	Select RSS feeds and add a Facebook page	Participants should go to the Content Source page to select RSS feeds and add a Facebook page for using content later created as a post.
3	Select two suggested posts, publish one and save the other one to the draft section	Participant should go to the Suggestion page, save one article as a draft post, and immediately post another article on his social media account.
4	Edit the draft article saved previously and schedule the post for the next day	Participant should go to the Calendar page and edit the previously saved draft by including some additional text and schedule the post for the next day.
5	Create a post including an image and schedule the post	Participant should go to the New Post page, create a new post with text and an image, and schedule the post for later at the day.
6	Change calendar view and reschedule one of the posts'	Participants should go to the Calendar page, change the view of the calendar (detailed to compact view and monthly to day view), and reschedule one of the already planned posts'.

Beside measuring the above-mentioned usability metrics, an in-depth analysis was conducted on the video recording material from each participant to further explore and analyze Onlim's UI for usability problems. Table 2 lists a summary of detected usability problems as structured by Onlim functions. Colored rectangles indicate at which task the problem was detected. Each of the listed usability problems was tracked by how often the same problem appeared. An example is provided to illustrate the type of error made by participants. All usability problems are also categorized by problem type. Two problem types are used to distinguish whether the detected problems are due to system (S) or operational (O) errors. System problems are errors due to Onlim malfunction, such as an error message like "service.account.save\_error" or a wrong message displayed in the chatbot. Operational problems are errors occurring due to incorrect operation of Onlim by users, such as not finding the correct button for an action or the misinterpretation of icons. Table 2 also provides the basis for proposing potential usability improvements for Onlim.

Basing on the usability summary, suggested improvements were defined for each of the usability problems. Furthermore, the detected usability problems were compared to the current Onlim UI since the usability lab was conducted when the previous UI was in place and before UI designers performed a makeover of the UI.

## 6. Conclusions

To discover to which extent usability tests can detect user experience improvements, a usability lab was conducted with 27 participants who used the previous UI version that

existed before the introduction of a new and improved UI design. By identifying usability problems in the older version of the Onlim UI, it was possible to compare the findings against the new UI to see how many problems had been solved without considering the outcome of a usability test. The collected data consisted of video material taken from participants' screens while they performed six predefined tasks. The task ratings included time per task and SEQ as well as answers to four open-ended questions. The participants were also asked to think aloud to provide a better understanding of the reasoning for their performed actions. In the end, a data set for 20 of the participants was used for the analysis. Usability metrics were also measured in addition to an in-depth analysis of the video material to discover exactly where participants made errors and to identify the actions that caused them to struggle while performing the tasks.

Furthermore, the self-reported SEQ metrics rated the task difficulty perceived by the users, also task success perceived by user and provided answers to open-ended questions were analyzed. The time on task provided a first indication that participants struggled the most at Tasks 1, 3 and 6. These results were confirmed through the task completion rate and level of success. The highest failure rate was detected in Task 3 and was confirmed through the found usability problems in the in-depth video analysis. The SEQ indicated that overall the participants found the tasks mostly easy or very easy. This provided a strong indication that there existed actual usability problems in Onlim.

The conducted usability lab involved a qualitative user test categorized as a summative usability study that was described in Section 2. The applied method was based on the usability study scenarios of [21] with a focus on completed transactions, navigation evaluation, problem detection and information architecture. According to [19],

**Table 2.** Usability Problems Summary

Problem ID	Onlim function	Identified usability problems	Problem type	No. of errors	Error examples
1	■ Registration	Notification that password was too short, was shown after clicking "create account".	S	1	User registered through connecting one of his social media accounts. After signing in to his Facebook account and acknowledging the access for Onlim, the user was sent back to the Onlim registration in order to enter a password for his Onlim account. When entering a password, the user chooses a too short password, the notification about the too short password appeared only after he clicked on "create account".
2	■ Registration	User was irritated by "surname" at the registration.	O	1	User was a little irritated by surname. Note: User was most likely from North America.
3	■ Registration	Onlim Web site opened in German language in a new browser tab after clicking on the confirmation link in the registration email.	S	2	In two cases the user chose in the registration form English as language. When he confirmed the registration through the link sent in the email, Onlim Web site opened in German language.
4	■ Connecting social media accounts	Error message "services.account.save_error" when returning to Onlim after connecting the Facebook account.	S	1	User added his Facebook account but deselected the option that Onlim can manage the page. For publish as page, the user clicked on "Not now" and returned to Onlim where than the error

5	■ Page guide	User was not able to find the page guide.	O	4	Some users missed clicking on "Create first post" in order to come to the page guide for post creation or closed it by accident. They were then not able to reopen the page guide.
6	■ Chatbot	Message of the chatbot, that no social media accounts are connected, didn't change when the social media accounts were connected to Onlim (occurred only in the German version).	S	7	One of the users who used the German version of Onlim was irritated by the chatbot message that there were no social media accounts connected even though he had already added his accounts.
7	■ Suggestions (News Feed)	Actions for suggested posts (articles) from the news feed not visible. Down arrow icon was not recognized right away or at all.	O	19	User had problems finding the call to action in order to publish suggested post or save it as draft.
8	■ Suggestions (News Feed)	Post preview in Facebook was irritating for users.	O	6	User assumed the article was already posted on Facebook as the article preview in the Facebook news feed appeared.
9	■ Suggestions (News Feed)	Detailed view of suggested post with like, comment and share icon from Facebook caused irritation.	O	1	User tried to click on the Facebook share icon of the preview in the detailed view of a suggested post in the detailed view.
10	■ New Post	Misinterpretation of "Update" button in new post section.	O	7	User thought he was publishing the post by clicking on "Update" button. They didn't see the down arrow icon for further actions.
11	■ Drafts	Difficult to find draft options in order to perform actions (e.g., edit, schedule) for a saved draft.	O	12	User didn't immediately find possible actions, like editing or scheduling for the saved draft.
12	■ Drafts	Drafts are hidden in calendar section.	O	1	One user mentioned that it would be more natural to him to find this functionality directly in the menu bar.
13	■ Post scheduling	Scroll icon for setting the minutes when scheduling a post didn't work properly as the time picker has a five-minute interval.	S	5	User had problem selecting the correct minutes with the scroll icon for the exact scheduling time (e.g., jumped from 59 to 04 instead to 00).

usability tests with 20 participants can detect between 95% and 98.40% of usability problems. Other methods to find usability problems would include a cognitive walk-through or heuristic evaluation. A heuristic evaluation would be more successful on the level of skill-based and rule-based user performance whereas a usability test is advantageous at a knowledge-based level [19]. In the conducted comparison of heuristic evaluation and user testing by [11], the heuristic evaluation found 34 out of 39 usability problems while the usability test found only 21 problems. A possible reason for the result can be that usability experts are specialized in usability problems that are independent from domains. [19] state that it becomes apparent that these different methods identify partly different information and, therefore, they cannot be compared against each other.

Overall, applying Onlim as a use case tool, this work has identified usability problems. Their comparison to the new features of the newer UI created with only a development process with limited implicit real user feedback, indicated that not all problems were solved through the new UI. In fact, 60% of the detected usability

problems still existed, although some are partly fixed or are system problems. Having identified this, we recommend involving usability testing in the development process of SMM tools and Web applications in general, while also aiming to overcome the possible limitations such as the ones described above (for example, with a more efficient integration of the usability tests in the software development process).

## References

- [1] Akbar Z, Fensel A, Fensel D. (2017, November). Enabling analysis of user engagements across multiple online communication channels. In *Research Conference on Metadata and Semantics Research* (pp. 147-159). Springer, Cham.
- [2] Aslam S. (2020). LinkedIn by the Numbers (2020): Stats, Demographics; Fun Facts. Retrieved April 7, 2020, <https://www.omnicoreagency.com/linkedin-statistics>
- [3] Bevan, N. (1991). What is usability. *Proceedings of the 4th International Conference on HCI*. Stuttgart.
- [4] Bevan, N. (1995). Human-computer interaction standards. *Advances in Human Factors/Ergonomics*, 20(B), 885–890.
- [5] Borsci, S., Federici, S., Malizia, A., & De Filippis, M.L. (2019) Shaking the usability tree: why usability is not a dead end, and a constructive way forward, *Behaviour & Information Technology*, 38:5, 519-532,
- [6] Constantinides E, Fountain SJ. (2008). Special Issue Papers Web 2.0: Conceptual foundations and marketing issues. *Journal of Direct, Data and Digital Marketing Practice* 9, 231–244.
- [7] Constine J. (2017). Facebook now has 2 billion monthly users... and responsibility | TechCrunch. Retrieved April 7, 2020, <https://techcrunch.com/2017/06/27/facebook-2-billion-users/>
- [8] Fensel A, Toma I, García JM, Stavrakantonakis I, Fensel D. (2014). Enabling customers engagement and collaboration for small and medium-sized enterprises in ubiquitous multi- channel ecosystems. *Computers in Industry*, 65(5), 891–904.
- [9] Fernandez A, Insfran E, Abrahão S. (2011). Usability evaluation methods for the web: A systematic mapping study. *Information and Software Technology*, 53(8), 789–817.
- [10] Flouris G, Patkos T, Chrysakis I, Konstantinou I, Nikolov N, Papadakos P, Pitt J, Roman D, Stan A, Zeginis C. (2018, October). Towards a Collective Awareness Platform for Privacy Concerns and Expectations. In *OTM Confederated International Conferences" On the Move to Meaningful Internet Systems"* (pp. 135-152). Springer, Cham.
- [11] Fu L, Salvendy G, Turley L. (2010). Effectiveness of user testing and heuristic evaluation as a function of performance classification.
- [12] Jacobsen J, Meyer L. (2017). *Praxisbuch Usability et UX: was jeder wissen sollte, der Websites und Apps entwickelt*.
- [13] Kaplan A, Haenlein M. (2010). Users of the world, unite! The challenges and opportunities of Social Media. *Business Horizons*.
- [14] Kappel G, Pröll B, Reich S, Retschitzegger W. (2006). *Web engineering: the discipline of systematic development of web applications*. West Sussex: John Wiley & Sons Ltd.
- [15] ISO. (2010). ISO 9241-210:2010 (en), Ergonomics of human-system interaction — Part 210: Human-centred design for interactive systems. Retrieved April 7, 2020, <https://www.iso.org/obp/ui#iso:std:iso:9241:-210:ed-1:v1:en>
- [16] ISO. (2018). ISO 9241-11:2018 (en), Ergonomics of human-system interaction — Part 11: Usability: Definitions and concepts. Retrieved April 7, 2020, <https://www.iso.org/obp/ui#iso:std:iso:9241:-11:ed-2:v1:en>
- [17] Matera M, Rizzo F, Toffetti Carughi G. (2006). Web Usability: Principles and Evaluation Methods. In N. M. Emilia Mendes (Ed.), *Web Engineering* (pp. 143–180). Springer.
- [18] Nielsen J. (1994). *Usability Engineering*. Elsevier.
- [19] Sarodnick F, Brau H. (2011). *Methoden der Usability Evaluation wissenschaftliche Grundlagen und praktische Anwendung*. Huber.
- [20] Tullis T, Albert W. (2013). *Measuring the user experience: collecting, analyzing, and presenting usability metrics* (2nd ed.). Elsevier.
- [21] Tuten TL, Solomon MR. (2013). *Social media marketing*. Boston: Pearson Education.



# Towards a Web Tool for the Analysis of Twitter Profiling Information

Feliciano J. Gómez-Fernandez<sup>a</sup> and Fernando Terroso-Sáenz<sup>a,1</sup>

<sup>a</sup>Universidad Católica de Murcia (UCAM), Murcia, Spain

**Abstract.** In these days and age, Online Social Networks (OSNs) are common ways to keep us in touch with relatives, friends and colleagues. As a result, we are used to share many personal information and opinions in these platforms. However, this might be dangerous for certain types of users, specially the underage ones. For that reason, the present work introduces a preliminary version of a web tool that, on the basis of the posts shared by a user in Twitter, infers and extracts certain personal information from these posts and present it to the user. The goal is to raise awareness among OSN users about how easy it is to uncover aspects of their private life from the data that they share in an Internet platform.

**Keywords.** Online Social Networks, privacy, data analysis

## 1. Introduction

Nowadays, online social networks (OSN) are widely spread in our society. As matter of fact, Facebook has around 2,449 million active users per month whereas Twitter has roughly 340 million active users per month [1].

Given this scenario of massive use of OSNs, one of the key drawbacks of these platforms has to do with the privacy of users, with special interest in the youngest ones because they are more vulnerable. They are not aware that the information they share in these platforms, in either a deliberately or unconsciously manner, could be used to cause them some kind of harm with the right processing. For example, 64% of children between 9 and 16 years old say they include a photograph of their face in their OSN profile, 50% say they include their surname and 29% their school [2].

For this reason, the present work introduces “What Do They Know About Me” (WDTKAM), a novel web application to show the valuable personal information that can be inferred about a person through the analysis of the content that he posts in the OSN Twitter. It is true that there are several existing tools that provide reports about the usage profile of Twitter users. However, most of them focus on providing just quantitative information that maybe not fully understandable by first-time users. Therefore, the goal of WDTKAM is to provide a solution whose analytical outcome can be easily understandable by a wide range of users and, thus, encourage them to adopt basic safety rules in their interaction with OSNs.

The remainder of the paper is structured as follows. Next, an overview the relevant related work is put forward in section 2. Section 3 is devoted to describing in detail the logic structure and the processing stages of the tool. Then, section 4 discusses the main

---

<sup>1</sup> Fernando Terroso-Sáenz, Universidad Católica de Murcia (UCAM), Campus de los Jerónimos, 30107, Murcia, Spain; E-mail: fterroso@ucam.edu.

results of the performed experiments. Finally, the main conclusions and the future work are summed up in section 5.

## 2. Related Work

In the literature we can find several web-based tools that carry out different types of analysis of Twitter profiles, publication of tweets, followers and friends, geo-localization of profiles, etc. Here we list the foremost existing solutions based on the surveys put forward in [3, 4, 5].

- [foller.me](https://foller.me)<sup>2</sup>: this application provides valuable information about any public Twitter profile, collecting almost real-time data on topics, mentions to other profiles, hashtags, followers, location, etc. It is worth noticing that the location-extraction feature is not currently supported in the trial version.
- [accountanalysis.app](https://accountanalysis.app)<sup>3</sup>: this web application allows to evaluate Twitter accounts, showing information about profile automation, number of published retweets or which websites the target account frequently links. It also shows statistical data about daily-publication rates in a graph-based format that compares days of the week with hours of the day, as well as type of tweet, publication interface, hashtags classification and cited users.
- [twitonomy](https://www.twitonomy.com)<sup>4</sup>: this tool, apart from offering useful information to companies in the marketing field, also offers relevant information on user profiles such as statistical data on usage and information of mentions to other profiles, hashtags, followers. It is quite similar to [foller.me](https://foller.me).
- [followerwonk](https://followerwonk.com)<sup>5</sup>: this tool has some free functionalities but the detailed account reports can be only generated by paid version of the tool. Like *twitonomy* and *foller*, it shows statistical data about the target profile, such as hours of use by types of tweets, running time of the followed profiles since their creation, etc. As a novelty, this tool provides a map with approximate locations extracted from the location field of the followed users' profiles. This might lead to some inaccuracies because this field is text free.
- Twitter Analytics<sup>6</sup>: it is the inner tool offered by Twitter, which can be accessed simply by having an account and activate the functionality. It shows data about our tweets, followers and friends, statistical data about the use of the account, summary of activity and so forth.

For the sake of clarity, Table 1 shows a comparative summary of the aforementioned tools and our proposal based on 8 features that have been considered significant when it comes to analyze a Twitter profile, namely,

---

<sup>2</sup> <https://foller.me>

<sup>3</sup> <https://accountanalysis.app>

<sup>4</sup> <https://www.twitonomy.com>

<sup>5</sup> <https://followerwonk.com>

<sup>6</sup> <https://analytics.twitter.com/about>

- Friends: information about the users who are more socially close to target account.
- Usage: information about the time-based use of the OSN split in days of the week, hours of the day, months, years, etc.
- Interfaces: information about the devices or client applications (e.g. mobile phone, web browser and the like) used by the target account to interact in the OSN.
- Multimedia: information about publications (tweets) in which some kind of multimedia content (images, gifs or videos) has been included.
- Interests: information about the interests, hobbies or tastes of the target account.
- Location: information about spatial places where the user of the target account has been according to the geo-tags of the posted.
- Languages: information about the languages used in the publication of the tweets.

	WDTK AM	Foller. me	Accountan alysis	Twiton omy	Follower wonk	Twitter Analytics
<b>Friends</b>	✓	✓	✗	✗	✗	✗
<b>Usage</b>	✓	✓	✓	✓	✓	✓
<b>Interfaces</b>	✓	✓	✓	✓	✗	✗
<b>Multimedia</b>	✓	✓	✗	✗	✗	✗
<b>Interests</b>	✓	✗	✗	✗	✗	✗
<b>Location</b>	✓	✗	✗	✓	✓	✗
<b>Languages</b>	✗	✗	✓	✓	✓	✗

**Table 1.** Comparison between our solution and existing ones for Twitter profile analysis. A check or cross mark indicates that a feature is supported or not by the tool.

As we can see from Table 1, our tool WDTKAM fills in the gaps found in the rest of the existing tools in terms of raise awareness among Twitter users about their privacy and the information they contribute to social networks.

The key difference of WDTKAM with respect existing tools is that in our approach we analyze not only the account of a target user (TU) but also information about its related profiles (friends, followers and the like). This will be described in detail in sec. 3.3. Furthermore, the interface of the tool provides the information in a very verbose approach so that the outcome of the analysis is provided to users in a very clear format. In that sense, our work has certain similarities with the tool presented in [6]. That tool proposes a web-tool to analyze the privacy leaks of a given web page. Like WDTKAM, an easy-to-read interface is presented. However, it focuses on a completely different scenario.

### 3. Tool “What Do They Know About Me” (WDTKAM)

This section describes in detail WDTKAM tool. We should point out that the source code of the tool is freely available in a GitHub public repository<sup>7</sup>. In that sense, Fig. 1 shows the operational workflow of the application. This pipeline comprises the following steps.

To begin with, the TU introduces his Twitter account name (arrow 1 in Fig. 1). Next, WDTKAM makes several calls to the Twitter API different types of information of the provided account name such as the user's profile information (arrow 2), his followers (3), friends (4), tweets (5), favorites (6), lists (7,8,9), locations (10) and received retuits (11). The information obtained from the API is processed and analyzed by the application (12), showing the result of the analysis in a graphic interface (13).

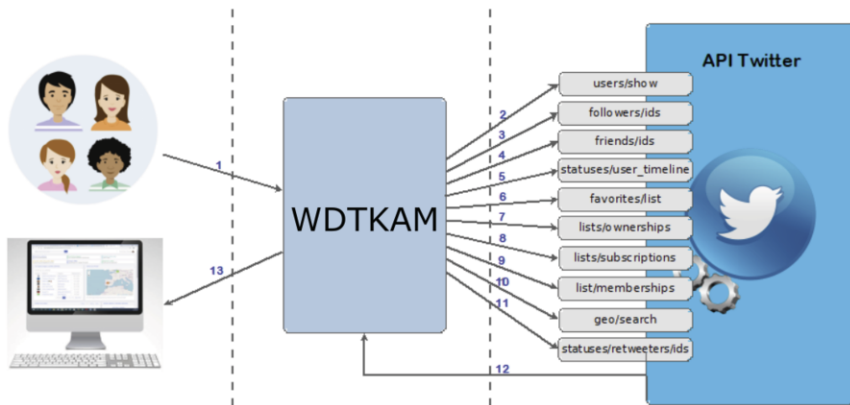

**Figure 1.** General flow of WDTKAM

#### 3.1. Usage of the Twitter Rest API

Twitter provides a ready-to-go Application Programming Interface (API) that allows to extract a varied range of data for a particular account. This API is structured in different methods/calls following a REST approach. In that sense, the Twitter API methods used by WDTKAM to obtain the information about the TU are explained below, following the same order than in Fig. 1.

- GET (users/show)

This method allows to extract many different information associated with the profile such as name, email, location, description, date of creation, url of profile images, number of followers and followed, if the profile is protected and if it is a verified profile.

- GET (followers/ids)

This method returns the followers of the TU.

- GET (friends/ids)

<sup>7</sup> <https://github.com/javicanin/QueSabenDeMi>

The method is extracts the list of user identifiers that are followed by the TU.

- GET (`statuses/user_timeline`)

This method retrieves a list of the most recent tweets published by the TU. For each tweet, the API returns the date of creation, the text, location if it was active, hashtags and mentions, added multimedia content, to all kinds of information about retuits and responses.

- GET (`favorites/list`)

This method returns a list of the last tweets marked as favorites by the TU.

- GET (`lists/ownerships`)

The invocation of this end point returns a structure containing information about the lists on which the TU is the owner or creator.

- GET (`lists/subscriptions`)

This method returns the lists to which the TU is subscribed.

- GET (`list/memberships`)

This call provides the lists of users of which the TU is a member.

- GET (`geo/search`)

The information returned by this method contains data about locations such as name, country, coordinates and a generic administrative classification such as country, city, neighborhood, etc.

- TSG (`statuses/retweeters/ids`)

This method retrieves a list of user IDs that have retweeted any tweet created by the target account.

### 3.2. API limitations

It is worth noticing that Twitter limits the number of calls that an API end-client can make. This limitation which depend on the query made or endpoint invoked. Generally speaking, all queries have a 15-minute window and a call limitation for that window. For example, the GET `statuses/user_timeline` query is limited to 900 calls during that 15-minute time window and each call returns a maximum of 200 results. To overcome this situation, WDTKAM makes use of cursors that allow the incremental extraction of the data.

### 3.3 Analysis of the information

All the data obtained with the aforementioned methods, WDTKAM performs the some analytical tasks. As a result, some personal and private information items related to the target account are extracted. Here we list these items.

### 3.3.1. Mutual followers

Two users are said to be mutual followers when each of them follows the other in a reciprocal way, that is, each of them has the other in their "followers" and "following" lists. The list of mutual followers is of great importance for the tool because it is used to analyze the information about the profiles that are closest to the TU.

To do so, the tool intersects the sets of users extracted from the methods *followers/ids* and *friends/ids* described above.

### 3.3.2. Friends

Another information item that WDTKAM extracts is the list of Twitter users that may be friends to the TU in the real world. The procedure to obtain the user profiles that are the closest to the TU is as follows.

Firstly, the list of mutual followers described in the previous section is filtered by only keeping the users of that list that accomplish the two following conditions,

- a) some of their tweets have been *retweeted* or *replied-to* by the TU,
- b) some of their tweets have been marked with a "like" by the TU,

Secondly, each account in the resulting list is evaluated from two different points of view to decide whether he/she is really a friend of the TU in real life,

- one quantitative that takes into account the number of interactions between the TU and the account, and
- another qualitative that also observes if the interactions are distributed homogeneously in the two criteria described above, taking into account the reciprocity in the interactions.

For example, if the TU has made a total of 100 interactions with another user, it would be reasonable to think that they might have a closer relationship based on the quantitative criterion. Then, the qualitative criterion also observes whether the interactions between the TU and the other user are more or less balanced.

### 3.3.3 Hobbies or interests

An innovative feature of WDTKAM with respect to the state of the art is the analysis of possible hobbies or interests of the TU.

In the current version of the tool, it only considers two pre-defined topics, video-games and Spanish politics. Then, for each topic, a pre-defined list of Twitter profiles or entities considered influential or relevant to any of the two subjects is defined. These profiles are normally marked as *verified* by the Twitter managers.

Next, we obtain the number of profiles of each topic that are followed by the TU. Depending on the resulting number, WDTKAM infers how relevant the topic is for the TU based on pre-defined ranges.

### 3.3.4 Locations

Finally, WDTKAM tries to infer the TU's visited locations through the location field that is freely filled in on his profile. Furthermore, it also checks the meta-data of his tweets so as to detect if any of them includes a geo-reference field.

In that sense, it is well-known that only a very small percentage of Twitter users (around 1%) have activated the geo-tagging of their tweets [7]. Besides, the location feature of a Twitter user profile is just a text-free field. Therefore, many users enter textual data that has nothing to do with locations, resulting in unpredictable responses.

Consequently, in most of the cases, the tool will not be able to infer reliable location data from a given TU.

#### 4. Case of Use

In this section, we describe the full functionality of WDTKAM from a user point of view.

The application has an initial view that allows a TU to introduce his Twitter username as Fig. 2 depicts. Then, the tool performs the API calls and analyses the data as described in sec. 3.3. Finally, the tool transitions to a second view displaying the results of such an analysis (see Fig. 3).

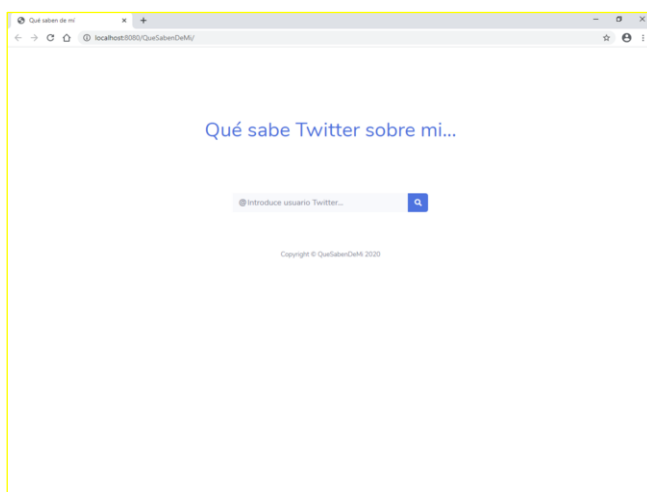

Figure 2. Initial view of WDTKAM (Spanish version).

This second view is divided into two areas. The top area contains a search field to introduce a new target account. Besides, it also contains the profile image of the TU and his user name. The second area corresponds to the rest of the view, which displays the key results of the analysis. Each type of result is shown in a particular panel as listed below,

- Target-account general information: This area shows a palette of small panels containing user-profile information.
- Best Friends or preferred profiles (“*Tus mejores amigos o perfiles preferidos*” in Fig. 3): This panel comprises a table with the user profiles that have been considered to have a closer relationship with the TU according to the procedure described in section 3.
- Map of Locations (“*Dónde usas Twitter*” in Fig. 3): This panel contains the map of locations extracted from the TU’s tweets, if at any time this option was active. This panel also shows the locations obtained from the TU profiling information.
- Twitter usage (“*Cuándo usas Twitter*” in Fig. 3): This panel comprises a plot that informs about the frequency of active use (publications) of Twitter in the format of hours of the day, days of the week, months and years.

- Interface or use devices (“Desde el teléfono, ordenador, aplicación” in Fig. 3) : It shows a graph with the number and type of devices that the TU uses when connects to Twitter. A detailed view of this panel is depicted in Fig. 4.
- Multimedia: this panel shows the tweet with multimedia content (images, animated gifs or videos) with the highest impact among the TU’s followers.
- Interests: this last section shows phrases related to the tastes, hobbies or interests of the target account.

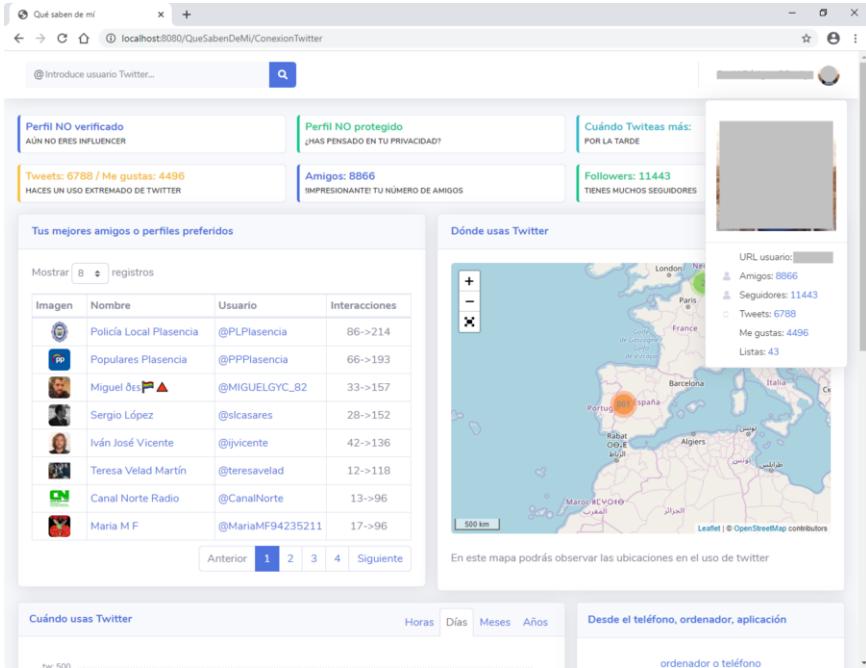

Figure 3. Example of tool view with the analysis results (Spanish version).



Figure 4. Example of the tool panel with the devices that the TU has used to interact with Twitter (Spanish version).



As we can see, the interface of the tool intends to present the results of the analysis in a quite clear manner. This way, a user can realize the simple but meaningful private information that can be easily extracted from the posts that they share on Twitter.

## 5. Conclusions and Future Work

Nowadays, the ubiquity of OSNs makes users to not be fully aware that using these platforms make them to share personal information that can be accessed anywhere in the world, with the consequent privacy issues.

In this scope, the present work introduces WDTKAM, a web tool that tries to offer a different perspective on OSNs, without diminishing the importance of the great social work they perform. Its objective is to raise awareness among OSN users about the privacy issues that the information that they share in OSNs might cause.

To do so, WDTKAM makes use of the functionality provided by Twitter so as to collect all the possible information about a particular account. Then, a simple but effective analysis of the crawled data is done. Finally, the key results are shown in a clear manner by means of a web-based view.

Future work will focus on improving the analysis made by the tool. In that sense, the usage of techniques from the Natural Language Processing (NLP) field will be deeply studied. This way, the tool will also be able to analyze the content of the tweet so as to, for example, uncover the potential hobbies of the target account in a more accurate manner.

## References

- [1] Mejía Llano J. C. Estadísticas de redes sociales 2020: usuarios de Facebook, Instagram, Youtube, LinkedIn, Twitter, Tiktok y otros. From <https://www.juancmejia.com/marketing-digital/estadisticas-de-redes-sociales-usuarios-de-facebook-instagram-linkedin-twitter-whatsapp-y-otros-infografia>, 2020.
- [2] UNICEF Comité Español. Los niños y niñas de la brecha digital en España. From <https://www.unicef.es/publicacion/estado-mundial-de-la-infancia-2018-los-ninos-y-ninas-de-la-brecha-digital>, 2018
- [3] Vermeren I. The Best Twitter Analytics Tools. From <https://www.brandwatch.com/blog/twitter-analytics-tools>, 2019.
- [4] Ángeles M. Las mejores herramientas de pago para análisis de Redes Sociales. From <https://velogig.com/las-mejores-herramientas-de-pago-para-analisis-de-redes-sociales>, 2019
- [5] Gómez Henao D. Top 5 de herramientas de Social Listening para tu negocio. Recuperado de <https://www.smdigital.com.co/articulo/top-5-de-herramientas-de-social-listening-para-tu-negocio/>, 2020.
- [6] Massardier-Meca M., Ruiz-Martínez A., Towards a Privacy Web Scanner for End-Users, Communications in Computer and Information Science, Volume 1208, 2020.
- [7] Huang B., & Carley K. M. A large-scale empirical study of geotagging behavior on Twitter. In Proceedings of the 2019 IEEE/ACM International Conference on Advances in Social Networks Analysis and Mining (pp. 365-373), 2019.

# Performance Evaluation of Clustering Algorithms on GPUs

Juan MORALES-GARCÍA<sup>a</sup>, Antonio LLANES<sup>a,1</sup>, Baldomero IMBERNÓN<sup>a</sup> and José M. CECILIA<sup>b</sup>

<sup>a</sup> *Universidad Católica de Murcia (UCAM)*

<sup>b</sup> *Universitat Politècnica de Valencia (UPV)*

## Abstract.

Social media is revealing itself as one of the main actors in the economic and social revolution we are currently witnessing, and in which the main factors are data and immediacy. Social media is producing a large amounts of data day by day, but this data is of no use unless it is processed for extracting relevant information from it. The efficient analysis of this immensity of data is mandatory to translate these mere data into information applicable to multiple areas. There are many techniques to deal with this problem, but undoubtedly one of the most useful techniques to extract meaningful knowledge from these data has been the clustering algorithms. However, clustering algorithms are cost-intensive from a computational point of view, especially when dealing with large data sets, and therefore require computing resources that offer high performance, which leads to another factor that must be taken into account for the efficient processing of this information, high performance computing. In this article, we show both points of view, the algorithmic one, applying several of the mentioned clustering algorithms, and on the other hand, preparing those algorithms to be executed in high performance computing platforms. Specifically in the article we present tests for the execution of the k-means, FM, and FCM algorithms in CPU and GPU, offering results in terms of efficiency of these algorithms. The results obtained show that an efficient implementation of these algorithms achieve speeds-up of 24x in some scenarios always taking advantage of GPUs.

**Keywords.** clustering algorithms, K-mean, FM, FCM, Social Media

## 1. Introduction

When we talk about social media we mean online communication platforms where content is created by users. This content can be text, audio, or video, all created directly by users using Web 2.0 technologies, and which can make that content visible to everyone. This set of platforms and tools has completely changed the way in which the user interacts with the rest of the users, with the companies and in general, with their environment, making users much more involved in the process of creating new information. In many cases, the individual himself is the creator of the information. Social media is not a inno-

---

<sup>1</sup>Corresponding Author: Antonio Llanes, Campus de los Jerónimos S/N, 30107 Murcia, Spain; E-mail: allanes@ucam.edu.

vative concept, we can find bibliography about from more than a decade ago, like in [1], when began a transition from a user who only consumed what he could find in search engines, to another type of user-content creator.

One might ask whether there are really enough individuals who are considered as such content creators. Well, according to data provided by *We Are Social* and *Hootsuite*, in their study "Digital 2020: Global Digital Overview", almost half of humans has become user-creators of content. A total of 3.7 billion people reaching 47% of the total humanity. Always speaking in terms of monthly active users, (MAU).

It would be pretentious to say that social media is the only responsible for this radical change. Different sectors, such as industry 4.0, social media or precision agriculture (just to mention a few), contribute equally to the creation of all these data. The huge amount of data and the need to process this information generated to extract valuable knowledge, poses a challenging scenario for data-intensive kernels such as clustering. Although the end of Moore's law has been announced for some time [2], generation after generation computer systems continue to increase their performance. The scientific community, being overwhelmed by such a large amount of data, has been forced to gather efforts to reprogramming their software for hardware platforms such as Graphics Processing Units (GPUs), or even Intel Xeon Phi, among others [3]. Despite all the known benefits that such platforms bring, transitioning algorithms to such platforms is relatively costly, and this cost increases further when performance is the goal.

One set of techniques that has been focused for the scientific community is clustering techniques, which, in general terms, attempt to classify a set of individuals into clusters, created on the basis of Euclidean distance, or other types of distance [4]. In these algorithms, individuals are classified within a cluster according to whether their distance (whichever is chosen) is less than that to another cluster. These algorithms have been widely used in different areas, such as medicine [5], economy [6], or food industry [7].

To find a suitable solution in these clustering algorithms, a study of the influence of different parameters and characteristics of the data must often be carried out. In addition they are usually iterative processes that affect the computational cost. We have argued that these clustering algorithms are computationally expensive, since there are studies that claim this, like [8]. That is why, in order to gain efficiency in the execution of the algorithms, we propose the parallelization of them. It is also true that this is not the first time this is done, there are approaches in the parallelization of algorithms already in some articles. One of the first candidate algorithms to be parallelized was the k-means, [9]. Although it should be noted that the clustering provided by the k-means algorithm is a hard clustering, that is, each individual belongs exclusively to a single cluster.

On the other hand, there are clustering algorithms that group individuals into non-dicotomic clusters. These are the fuzzy clustering algorithms. In this article, in addition to k-means, we also work with two such algorithms. The fuzzy c-means, (FCM, [10]), and the Fuzzy Minimals, (FM, [11,12]). Like the k-means, the FCM needs to know previously the number of clusters to be generated. The parallelization of the FCM has been discussed in previous works, [13,14], and in this article is the first time we discuss about the parallelization of the FCM. Finally, with respect to the FM, the advantage that FM presents with respect to the FCM is that the FM does not have the need to know previously the number of clusters. We have previously worked on the parallelization of FM in [15], and here we include it as benchmark.

The rest of the article is structured as described here. In section 2 we briefly present the algorithms we work with, with special emphasis on the parallelization of the FCM, since this is the first time we present it. After that, in section 3 we explain the scenario of the tests and executions carried out as well as the results obtained, to finish with section 4 of conclusions and future work.

## 2. Methods

### 2.1. Clustering algorithms

Clustering algorithms have been broadly used in many areas, reader can look for [16] for details. In this section we briefly describe the three algorithms we work with in this article, k-means, FCM and FM.

#### 2.1.1. K-means

K-means is a known clustering algorithm that is really heavy from a computational point of view. It is an iterative algorithm that seeks to classify data into clusters or groups depending on a distance function. The result will be therefore groups that within them lodge all the individuals that have "more in common" with respect to the rest of individuals of this cluster than with respect to the individuals of other clusters. The  $k$  in "k-means" refers to the number of clusters we are going to work with, and is provided by an input parameter. After this, the algorithm looks for the centroids, which will act as the representative of each of the clusters. To elucidate which cluster an individual will belong to, the algorithm uses the Euclidean distance (in our case), and that cluster whose Euclidean distance is the least to that individual will be the *group* to which that individual belongs. Generically, the k-means algorithm works as follows:

1. Initialization: Indicated by the  $k$  parameter, a concrete number of clusters is established, and then  $k$  centroids are established in the data space. In the initial stage, the centroids can be chosen randomly.
2. Assignment: Each data is assigned to its nearest centroid.
3. Update: The centroids of each cluster are updated, choosing as the new centroid the position of the average data of that cluster.

Steps 2 and 3 are iterated until the centroids are stable, or at least do not move above a threshold distance in each step.

Particularly for this paper, it has been decided to use a k-means implementation of SKLearn for running on CPUs, and RAPIDS for the GPU version. This is the main reason because we don't give more details about its implementation, and we refer the reader to [17] to know details about the CPU version in python, and to [18] for the GPU counterpart version.

The other two algorithms we work with in the article belong to the category of fuzzy clustering. The main characteristic of this fuzzy clustering is that a data or individual now does not have to belong exclusively to one cluster, but to several. Next we will give some details of the FM procedures, initially proposed by Flores-Sintas et.al. in [11].

### 2.1.2. Fuzzy-Minimals

The main difference of the FM algorithm, is that it does not require any input parameter, thus differing from both the k-means algorithm, and the FCM. For an in-depth study of the FM algorithm, we obviously refer the reader to the founder of the algorithm, [11,12], and the authors also carried out a detailed study of the algorithm in [19], so here we present the algorithm in a more general way. As with the k-means algorithm, we will now briefly describe the operation of the FM. From a structural point of view, the algorithm can be described in no more than 4 or 5 steps.

1. Initialization: Establish  $O = \{\}$ ,  $\epsilon_1$ ,  $\epsilon_2$ .
2. Load\_Data:  $X = \{Load\_Data\}$
3. Calculate\_r\_Factor( $X$ )
4. Calculate\_Prototypes( $X$ ,  $r$ , Err1, Err2,  $O$ )

Being  $O$  the output vector with the prototypes found.  $\epsilon_1$  controls when the algorithm finds a minimum, and  $\epsilon_2$  controls when two prototypes are different, so main steps are (3) and (4). Like we talk in [19], the  $r\_Factor$ , (equation (1) is a parameter that measures the isotropy in the data set. The use of Euclidean distance implies that the homogeneity and isotropy of the features space are assumed. Step (3) is the most cost-intensive step in terms of computation. Finally, step (4) is the function that will provide the prototypes of each cluster.

$$\frac{\sqrt{|C^{-1}|}}{nr^F} \sum_{x \in X} \frac{1}{1 + r^2 d_{xm}^2} = 1 \tag{1}$$

where  $X$  is the sample elements,  $|C^{-1}|$  is the determinant of the inverse of the covariance matrix,  $n$  is the number of elements,  $m$  is the mean of the sample  $X$  and  $d_{xm}$  is the Euclidean distance between  $x$  and  $m$ , so  $d_{xm}^2$  is the square of this Euclidean distance.

### 2.1.3. FCM

Finally, FCM is the latter clustering method we use in this article, implemented by authors in CPU and GPU versions. This algorithm allows that an individual data belongs to several clusters with different values of membership. The algorithm, in a general sense, consists of iteratively minimizing a function (equation (2) in our case) until an optimal fuzzy partition is obtained.

$$J_m(U, v) = \sum_{k=1}^n \sum_{i=1}^c (u_{ik})^m d_{ik}^2 \tag{2}$$

$d_{ik}^2$  is the square distance between  $X$  elements and centroids of each cluster, and its calculated as  $d_{ik}^2 = \|x_k - v_i\|_A^2 = (x_k - v_i)^T A (x_k - v_i)$ .

where,

- $X = (x_1, x_2, \dots, x_n) \in R$  are the data.
- $v_i = (v_{i1}, v_{i2}, \dots, v_{im})$ , is the vector with centroids of each  $i$ -cluster.
- $\|\cdot\|_A$  is the induced norm by  $A$ .

- A is a positive dimensional weight matrix.

Concretely, being A the identity matrix,  $d_{ik}^2$  is the square of the Euclidean distance. The weight associated with each square distance,  $(u_{ik})^m$ , is the mth power of the k-data degree of membership to cluster i. When  $m \rightarrow 1$  the optimal partition is closer and closer to an exclusive partition, while when  $m \rightarrow \infty$  the optimal partition is closer to the matrix with all its values equal to  $(1/c)$ . The m values normally used are values in the range [1.30]. Each selection of a particular m-value marks a specific Fuzzy C-Means algorithm according to bezdek [10].

With this in mind, the general procedure of the Fuzzy C-Means algorithms can be formalized in the following steps:

1. Initialize  $c, m, A, y| |A|$ , choose an initial matrix  $U^0 \in M_{jc}$ .
2. Calculate centroids with  $v_i = \frac{\sum_{k=1}^n (u_{ik})^m x_k}{\sum_{k=1}^n (u_{ik})^m}$ ;  $1 \leq i \leq c$
3. Update the fuzzy partition matrix  $U = [U_{ik}]$  with  $U_{ik} = (\sum_{j=1}^c (\frac{d_{jk}}{d_{ik}})^{\frac{2}{m-1}})^{-1}$ ;  $1 \leq k \leq n; 1 \leq i \leq c$
4. If the stop criterion was reached, finish. Otherwise, return to step 2.

The most common stop criteria are: (a) A maximum number of iterations or (b) That the variation in the U-matrix is below a certain threshold  $\|U^{k+1} - U^k\| < \epsilon$ .

With this explanation we present the structure of the FMC algorithm, although it is somewhat denser than the other algorithms, we thought it necessary a little more detail, since this implementation is the main contribution that we present in this article. We will now give some details about its implementation.

To parallelize the algorithm, we planned a test scenario to test the sequential code, and thus analyze where the major bottlenecks are in order to focus our parallelization efforts on those points. We made several runs, obtaining in this way the points in which the sequential algorithm dedicates most of the time. Depending on the input dataset, and depending on the number of columns, for example, usually varies the occupancy factor of different functions, but we can conclude that the most computationally demanding are *multiply*, *dist* and *temp\_dist*, functions all of them, in which matrix multiplication operations, or sums of rows or columns of arrays are performed several times.

The highlights about the parallel version are mainly:

1. Use of Pinned Host Memory. The host data assignments (CPU) are paginated by default. The GPU cannot access data directly from the pageable host memory, so when a data transfer from pageable host memory to device memory is invoked, the CUDA controller must first map a temporary, a pinned host array, copy the host data to the pinned array, and then transfer the data from the pinned array to the device memory. the pinned memory is used as a storage area for transfers from the device to the host. We can avoid the cost of transferring between paged host memory and pinned memory by directly assigning our host arrays to the pinned memory. In this case memory reservation is done with *cudaMallocHost*, instead of *malloc* and *calloc*, and to free memory *cudaFreeHost* is used.

2. Matrix multiplication is performed by calling *cublasDgemm*, a function in the CUDA Basic Linear Algebra Subroutine library (cuBLAS). This same library is also used for the sum of columns in an array, as the sum of rows or columns in an array can be seen as a matrix-vector multiplication, where the elements of the vector are 1s. Through these implementations, it was possible to drastically reduce the execution time

in the calculations of the algorithm, reaching speed-ups that are discussed in section 3. In table 1 we present distinctive features of each algorithm. In the next section we will describe what our test scenario, the available hardware resources, and discuss the results obtained.

Algorithm	Soft Clustering	Nº of cluster pre-fixed	requisites
K-Means	No	Yes	CWS Clusters
FCM	Yes	Yes	CWS Clusters
FM	Yes	n.a.	none

**Table 1.** Distinctive features of algorithms. Soft clustering refers to whether the grouping of a data or individual is exclusive to a cluster or has some degree of membership with respect to other clusters. Respect the number of clusters, K-Means and FCM need an input parameter indicating the number of cluster, however FM does not need prior knowledge of the number of clusters, and it presents the advantage that the clusters do not have to be Compact Well-Separated (CWS).

### 3. Evaluation

This section shows an experimental evaluation of the classification and clustering algorithms (Kmeans, FCM and FM) running on a heterogeneous node with Intel CPUs and an Nvidia GPU. Each of these algorithms is based on different techniques, so we evaluate the performance between different implementations of the same algorithm. First, the hardware and software environment where the experiments are performed is introduced, along with a description of the different benchmarks used. We then detail the evaluation performed.

#### 3.1. Hardware environment and Benchmarking

For our evaluation we used a node with a Xeon(R) Silver 4216 CPU processor with sixteen physical cores (thirty-two threads) running at 2.10GHz with a maximum of 3.20GHz. It has 32 MB of shared L3 cache. It offers support for SSE4.2 (128-bit registers), AVX2 (Advanced Vector Extensions) with 256-bit registers and AVX-512 (512-bit registers) with one FMA (Fuse Multiply ADD).

This node includes a GPU GeForce RTX 2080 Ti (Turing family), with Compute Capability 7.5, 4352 CUDA Cores (68 SM and 64 CUDA Cores per SM), 12 Global Memory DDR5 with 352 Memory Bus, and 48 KB of shared memory per block.

To evaluate the performance of the three algorithms, we will use a numerical database with 100K points with 80 columns each one, comprising five hyper-ellipsoids. With this database, three benchmarks have been configured. The first one is seven data files of 100k rows, 37 clusters and 2, 4, 8, 16, 32, 64 and 80 columns respectively. The second one consists of four data files with 80 columns, 37 clusters and 100, 1K, 10K and 100K rows respectively. The last benchmark is only a file with 100K rows and 80 columns. The data that compose this file are grouped in 2, 4, 8, 16, 32, 64, 128, 256, 512 and 1024 clusters.

### 3.2. Runtime Evaluation

This section shows the results of the evaluation of the different clustering algorithms, varying the number of rows, number of columns and number of clusters. In our case, the rows represent different measurements or records and the columns represent the different variables that are captured in each of the measurements. With this study we intend to evaluate the performance of the three algorithms, and see the scalability of each one as the computer workload increases. Each of the figures presented in this study contains an assessment on both CPU and GPU-based architectures. The CPU-based ones focus on the best thread configuration, using all the available threads in the computation node, in our case, 36 threads in total. With respect to the GPU, we use the device available and described in section 3.1.

Figures 1, 2 and 3 show the performance of k-means and FCM algorithms according to the first, second and third benchmark described in section 3.1. Figure 4 shows the results of the FM algorithm in the first and second benchmarks, since according to the characteristics of this algorithm, we cannot run it with the third benchmark. The reason is that it creates different clusters depending on the input data.

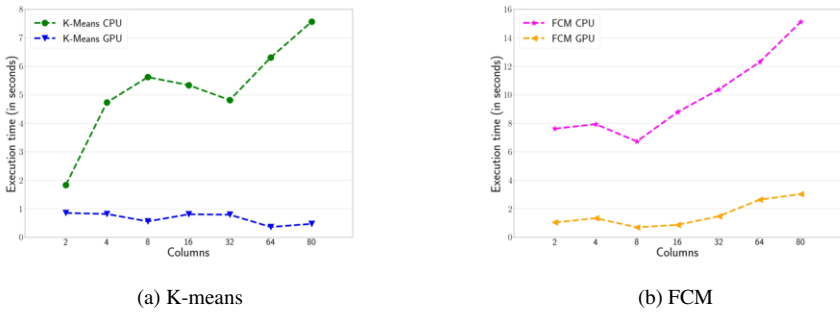
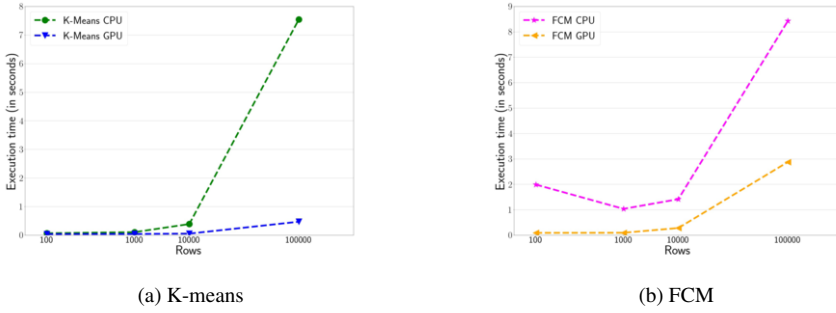

**Figure 1.** Execution time (in seconds) of first Benchmark for K-means (a) and FCM (b) algorithms on CPU and GPU platforms.

The figure 1 shows the evolution of the execution time in relation to the number of columns with the k-means and FCM algorithms. With this data we can say that the use of GPU-based implementations of both algorithms benefits performance. This improvement increases as we increase the number of columns. In figure 1a we can see the evaluation of K-means. This evaluation shows that we can get a speed-up of 17x with the maximum number of columns. In figure 1b we show the performance of FCM. In this benchmark FCM we can get 10x with the maximum number of columns.

The number of rows or records to be processed is another important point to evaluate. Figure 1 shows the evolution of the execution time as the number of rows increases. In both algorithms the CPU-based implementation penalize the performance when the rows exceed 10K records. For values below 10K rows, implementations on both platforms follow similar growth. In particular, in the figure 2a can see the performance of K-means. With this algorithm we can get a speed-up of 16x with 100K records. In figure 2b shows FCM performance. In this case we can get with GPU implementation a speed-up of 11x for sizes lower than 10K rows, and 3x for higher values.





**Figure 2.** Execution time (in seconds) of second Benchmark for K-means (a) and FCM (b) algorithms on CPU and GPU platforms.

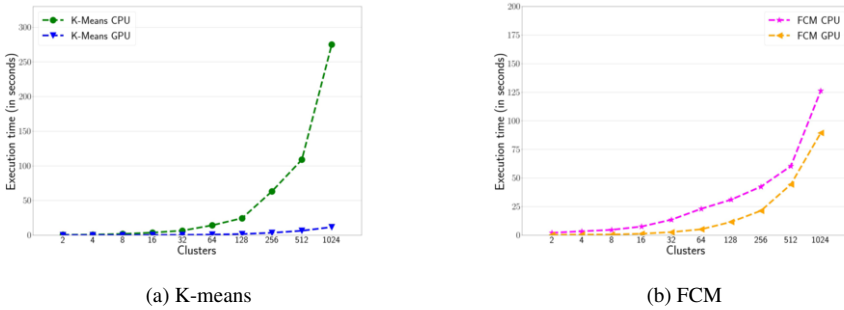

**Figure 3.** Execution time (in seconds) of third Benchmark for K-means (a) and FCM (b) algorithms on CPU and GPU platforms.

Figure 3 evaluates the performance of the K-means and FCM algorithms as the clusters increase. GPU-based implementations provide better performance data than CPU-based implementations, and as we increase the number of clusters, the difference is greater in both algorithms. The figure 3a shows K-means performance in detail. With this data, if we use k-means we can get a 24x speed-up with maximum number of clusters. The figure 3b shows FCM performance. This evaluation shows that we use FCM we can get a 2x speed-up with 1024 clusters.

Figure 4 evaluates the performance of the FM algorithm in the first and second benchmarks with both computing platforms. In both cases, with the GPU implementation we get higher performance with a higher computational workload. Figure 4a evaluates the performance of the first benchmark and we can see the convenience of using CPU when the number of columns is less than 32. When it exceeds 32 columns the CPU performance falls rapidly to the benefit of the GPU. In this benchmark we get a speed-up of 6x with the GPU and the maximum number of columns. With this data we can conclude that GPU performance increases as we increase the columns. Figure 4b shows the performance of the FM algorithm with the second benchmark. In this case we observed a sharp drop in CPU implementation performance from a number of rows greater than 10K. Therefore we achieved a 6x speed-up on GPUs for 100k rows. Overall, we can

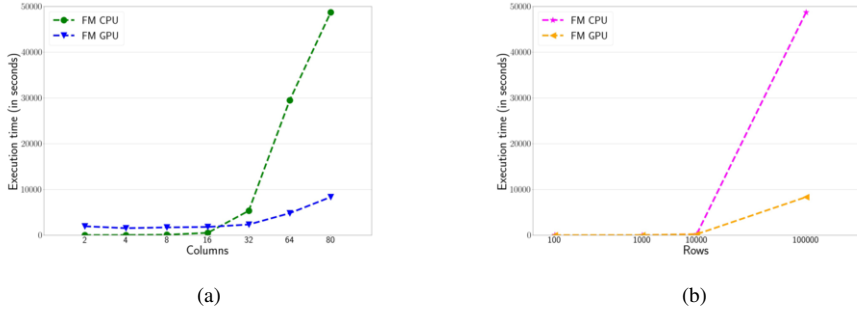

**Figure 4.** Execution time (in seconds) of first (a) and second (b) Benchmark for FM algorithm on CPU and GPU platforms.

conclude that the FM algorithm achieves better performance results with GPU for high computational workloads.

#### 4. Conclusions and Future work

Social media must drive real-time analysis of large datasets to respond to the world's problems in no time. A set of computer tools and platforms have emerged to enable this analysis. Therefore, algorithms must adapt their implementations to take advantage of these new resources. In this case, it has been demonstrated with this study, that the adaptation of three different clustering algorithms to massively parallel platforms can lead to great computational benefits. This article shows the benefits of using Nvidia-based architectures to redefine these algorithms and get bigger benefits than using CPU-based platforms. In all cases of this study, better performance values are obtained by using massively parallel architectures, achieving speeds-up of 24x in some scenarios.

Future work should aim at adapting Social media algorithms to heterogeneous and massively parallel environments, using CPU and multi-GPU environments in a natural way.

#### Acknowledgments

This work was partially supported by the Fundación Séneca del Centro de Coordinación de la Investigación de la Región de Murcia under Project 20813/PI/18, and by Spanish Ministry of Science, Innovation and Universities under grant RTI2018-096384-B-I00 and RTC-2017-6389-5.

#### References

- [1] J.H. Kietzmann, K. Hermkens, I.P. McCarthy and B.S. Silvestre, Social media? Get serious! Understanding the functional building blocks of social media, *Business horizons* **54**(3) (2011), 241–251.
- [2] M.M. Waldrop, The chips are down for Moore's law, *Nature News* **530**(7589) (2016), 144.
- [3] D. Singh and C.K. Reddy, A survey on platforms for big data analytics, *Journal of big data* **2**(1) (2015), 8.

- [4] G.M. Mimmack, S.J. Mason and J.S. Galpin, Choice of distance matrices in cluster analysis: Defining regions, *Journal of climate* **14**(12) (2001), 2790–2797.
- [5] B. Zheng, S.W. Yoon and S.S. Lam, Breast cancer diagnosis based on feature extraction using a hybrid of K-means and support vector machine algorithms, *Expert Systems with Applications* **41**(4) (2014), 1476–1482.
- [6] P.-C. Chang, C.-H. Liu and C.-Y. Fan, Data clustering and fuzzy neural network for sales forecasting: A case study in printed circuit board industry, *Knowledge-Based Systems* **22**(5) (2009), 344–355.
- [7] C. Gimenez, Logistics integration processes in the food industry, *International Journal of Physical Distribution & Logistics Management* (2006).
- [8] S. Dasgupta, *The hardness of k-means clustering*, Department of Computer Science and Engineering, University of California . . . , 2008.
- [9] I.S. Dhillon and D.S. Modha, A data-clustering algorithm on distributed memory multiprocessors, in: *Large-scale parallel data mining*, Springer, 2002, pp. 245–260.
- [10] J.C. Bezdek, R. Ehrlich and W. Full, FCM: The fuzzy c-means clustering algorithm, *Computers & Geosciences* **10**(2–3) (1984), 191–203.
- [11] A. Flores-Sintas, J. Cadenas and F. Martin, A local geometrical properties application to fuzzy clustering, *Fuzzy Sets and Systems* **100**(1–3) (1998), 245–256.
- [12] J. Soto, A. Flores-Sintas and J. Palarea-Albaladejo, Improving probabilities in a fuzzy clustering partition, *Fuzzy Sets and Systems* **159**(4) (2008), 406–421.
- [13] T. Kwok, K. Smith, S. Lozano and D. Taniar, Parallel fuzzy c-means clustering for large data sets, in: *European conference on parallel processing*, Springer, 2002, pp. 365–374.
- [14] S. Rahimi, M. Zargham, A. Thakre and D. Chhillar, A parallel Fuzzy C-Mean algorithm for image segmentation, in: *IEEE Annual Meeting of the Fuzzy Information, 2004. Processing NAFIPS'04.*, Vol. 1, IEEE, 2004, pp. 234–237.
- [15] I. Timón, J. Soto, H. Pérez-Sánchez and J.M. Cecilia, Parallel implementation of fuzzy minimal clustering algorithm, *Expert Systems with Applications* **48** (2016), 35–41.
- [16] A.K. Jain, M.N. Murty and P.J. Flynn, Data clustering: a review, *ACM computing surveys (CSUR)* **31**(3) (1999), 264–323.
- [17] F. Pedregosa, G. Varoquaux, A. Gramfort, V. Michel, B. Thirion, O. Grisel, M. Blondel, P. Prettenhofer, R. Weiss, V. Dubourg et al., Scikit-learn: Machine learning in Python, *Journal of machine learning research* **12**(Oct) (2011), 2825–2830.
- [18] R.D. Team, *RAPIDS: Collection of Libraries for End to End GPU Data Science*, 2018. <https://rapids.ai>.
- [19] J.M. Cebrian, B. Imbernón, J. Soto, J.M. García and J.M. Cecilia, High-throughput fuzzy clustering on heterogeneous architectures, *Future Generation Computer Systems* (2020).

# Representing Human Mobility Patterns in Urban Spaces

Luís Rosa<sup>a</sup>, Fábio Silva<sup>b,a</sup> and Cesar Analide<sup>a</sup>

<sup>a</sup>ALGORITMI Center, Dep. of Informatics, University of Minho, Braga, Portugal

<sup>b</sup>CIICESI, ESTG, Politécnico do Porto, Porto, Portugal

**Abstract.** Human mobility is important in understanding urban spaces. Citizens interact with urban spaces using the available infrastructures, not just in the mobility sector but in public services, and in Information and Communications Technology (ICT) services, that simultaneously record their footprints. Besides, the number of mobile users is increasing very rapidly in the Internet of Things (IoT) era. These additional devices will produce a great amount of data and create new big challenges for network infrastructure. Because of this new connectivity platform, and the fast growth of wireless communication, it's important to discuss the arrival of 5G systems. They will have a large impact on coverage, spectral efficiency, data rate of global mobile traffic, and IoT devices, and in turn it will be possible to analyze the lifestyle and understand the mobility of people, such as the most frequently visited urban spaces. Therefore, this paper is relevant in the context of smart cities and will allow for an easy connection between citizens and technology innovation hub, acquiring detailed data on human movements. Based on the analysis of generated data we try to widen this view and present an integrated approach to the analysis of human mobility using LinkNYC kiosks and 311 Service Requests in New York city.

**Keywords.** Human Mobility Pattern, Device Network Dataset Collection, Smart Cities, Deep Neural Network

## 1. Introduction

Mobility is a term with multiple connotations and one of them relates to the sense of mobility as freedom of movement across physical space. Being "mobile" refers to the movement of individuals or groups from place to place, job to job, or one social class or economic level to another. Nowadays, mobility is not only a social phenomenon, but also includes technologies and services that enable people to move around more freely[19]. As the world keeps changing at an incredibly fast pace, so is the way in which people get from point A to point B. 50% of the world's population lives in urban environments and, by 2040, more than 70% is expected to live in cities. Moreover, we are transitioning into a "sharing" economy: sharing a ride, a home or an office are just examples of what's becoming the norm, instead of being exceptions. Along with this change, we are also witnessing a parallel increase in the use of mobile devices. On the other hand, the social and spatial behavior of individuals is affected by two main conditions. While we are constrained by time, cognition, age, the need for food, etc., each one of us is characterized by personality traits that make us if perhaps not unique, at least different from many

others. Personality psychology conjectured a long time ago that a set of personality traits underlie all aspects of human behavior [13, 18].

These psychological factors along with the reasons which make mobility easier have contributed to the growing interest of the scientific community in studying the existing movement patterns of individuals. Some research projects integrate activities of members of the ALGORITMI Center, Department of Informatics, University of Minho (Braga, Portugal), that are focused on the various problems associated with the idea of "Smart City". The variety of research areas has been treated as an important added value of the smart human mobility. For example, using the potential of ubiquitous computing, the PHESS platform notifies the community about incorrect driving practices. From monitoring and building of community road maps based on driving analysis, this service aims to drive behavioural change and offer intelligent planning to the users [20]. Still related to traffic, researchers forecasted traffic flow in data-scarce environments using ARIMA and LSTM Network models [7]. In smart mobility area, a project tackles the Vulnerable Road Users' (VRUs) problem (non-motorised road users, such as pedestrians and cyclists as well as motor - cyclists and persons with disabilities or reduced mobility and orientation) and provides a proof of concept on crowd sensing for urban security in Smart Cities [8]. And, recently presented in a Doctoral Symposium on Artificial Intelligence, we apply three different Machine Learning techniques such as Convolutional Neural Network (CNN), Long-Short Term Memory (LSTM), and a combined architecture, called CNN-LSTM, to the data generated by LinkNYC Kiosk devices, based on the city of New York, and compare results in predicting human mobility [9]. Based on the experience learned from the studies, we put together a comprehensive tutorial about state of art in mobility research, which introduces and discusses popular crowdsensed data types, different human mobility subjects, and analysis methods.

Nowadays, people's expectations, decisions, habits and life experiences change continuously, influenced by ongoing technology innovations and improvements in the infrastructures of cities. In this new "urban innovation hub", in many cases human movement can be followed digitally. Using empirical mobile phone datasets, this paper attempts to explore spacial distribution and human mobility patterns, as well as the interrelationship between them at the community level. To be more precise, when we analyze these large segments of New York City's population, we will be able to gather knowledge on how and when people are moving around the city.

## **2. Human Mobility: Opportunities in smart cities**

The study of human mobility has intensified in the last decades because to its potentiality. In fact, if applied to socio-economic studies in smart cities, understanding macroscopic mobility patterns can potentially better support decisions and eventually improve quality of life. Our study contemplates a large population of free-willed and autonomous decision-making individuals, but it also takes into account their interaction with mobile devices. However, other factors can be summarized to help us understand how human mobility patterns are established.

## 2.1. Activity-Based Human Mobility Patterns

Understanding the dynamics of daily mobility patterns is essential for the planning and management of urban facilities and services. For the same reason the movements can also be instrumental in understanding and assessing individual and collective mobility patterns. In this paper, aspects of these factors are analysed based on their importance and on how they affect mobility patterns.

### 2.1.1. Individual Mobility Behavior

Identifying individual mobility patterns is of fundamental importance to understand the socioeconomic dynamics behind spatial and human movements. Indeed, early measurements on monkeys, albatrosses and marine predators [16, 21] suggested that animal trajectory is approximated by a Lévy flight model. Human trajectories are explained by random walk and diffusion models such as Lévy Flight (LF) [15], discovered by P. Lévy in the beginning of this century, and Continuous Time Random Walks (CTRW), introduced by Montroll and Weiss in 1965. While in the first the movements of an individual are calculated by random walk processes with a Lévy probability distribution of step lengths that is heavy-tailed, in CTRW the step lengths and the waiting times are distributed according to a Lévy distribution.

Some researchers have extended the use of the term "Lévy flight" to include different human moving contexts. On the basis of these behaviors, assume that the flight distance is well approximated to a power-law function (Eq. 1),  $f(x; a, \alpha)$ , of the form:

$$\tilde{f}(k; a, \alpha) = \langle \exp(ikx) \rangle = \exp(-|ak|^\alpha) \quad (1)$$

This distribution model is defined for  $0 < \alpha < 2$ , otherwise  $f(x; a, \alpha)$  is not normalized ( $\alpha < 0$ ) or gets negative values and cannot be a probability distribution function (PDF) ( $Var(f(x; a, \alpha)) = 0$ ). Here  $a$  represents the units of length. Moreover, it can be thought of as the limit distributions for random walks with steps of sizes distributed ( $N$ ) or the width of the PDF  $f(\frac{x}{N}; a, \alpha)$ . Therefore, in context of the Lévy Flight (Eq. 2) the width is the flight length:

$$x(N) \sim N^{\frac{1}{\alpha}} \quad (2)$$

Now, we introduce the concept of a random waiting time from a one-sided probability distribution. To address random waiting times in the context of CTRW, we begin with Laplace transform where  $f(t; a, \alpha)$  ( $a$  represents the units of time)  $\tilde{\phi}(s; a, \alpha)$ ,  $f(t; a, \alpha)$  is non negative for  $0 < \alpha < 1$ . For  $\alpha = 1$  and  $\alpha = 2$  we get two known special cases, Lorentzian and Gaussian[2] in Eq. 3.

$$f(x; a, 1) = \frac{a}{\pi(a^2 + x^2)} \quad f(x; \frac{\sigma^2}{2}, 2) = \frac{1}{\sqrt{2\pi\sigma^2}} \exp(-\frac{x^2}{2\sigma^2}) \quad (3)$$

For anomalous diffusion we assume the waiting times PDF  $\tilde{\phi}(s; \tau, \beta)$ , and step length PDF  $\tilde{f}(k; \lambda, \alpha)$ . Expand it for small  $k$  and  $s$  and put it into the Montroll-Weiss equation and taking the first order terms gives the Eq. 4.

$$\tilde{f}(k, s) \sim \frac{\tau s^{\beta-1}}{\tau s^{\beta} + \lambda k^{\alpha}} \quad (4)$$

With these equations, three distinct hypotheses can be presented to explore the statistical properties of the population mobility pattern. Firstly, each individual follows a Lévy flight trajectory with jump size distribution. Then, there is a population heterogeneity based on individual distribution, corresponding to the inherent differences between individuals, and it coexists with individual Lévy trajectories.

### 2.1.2. Collective Mobility Behavior

Shifting the attention to the collective level, the scientific community has identified urban moving types based on communities. In 2012, Jiang found that the population can be clustered into several representative groups based on the kind of activity[10]. In its turn, Kang explored human movements in Singapore based on taxicabs usage data and observed a much higher number of trips within a community than trips across different communities [11]. In all of them there are connections between the social and spatial behavior of groups of individuals, and they are used to produce predictive models of mobility.

Although these comprehensive projects have the potential to revolutionize human mobility research, until now our knowledge of the correlation, and aggregation among data has been extremely limited. Using extensive individual mobility records resolved in both time and space can be aggregated for the study of individual traveling between different zones of an urban area. This study can be organized in the framework of Origin-Destination (OD) matrices to provide a relevant high-level picture of human mobility[1]. Therefore, in OD matrix (ODM), for each spatiotemporal trajectory  $T_k$ , there is a flow between the areas  $(i, j)$ , noted  $F(i, j)$  if the two following conditions are met:

1.  $p_1 \subset i$  OR  $(p_2 \subset \text{AND } p_1 \in \text{neighbors list of } p_2)$
2.  $p_n \subset j$  OR  $(p_{n-1} \subset \text{jj AND } p_n \in \text{neighbors list of } p_{n-1})$

where  $T_k$  is composed by a set of  $n$  consecutive points, noted  $T_k = p_1, p_2, \dots, p_i, \dots, p_{n-1}, p_n$ , where:  $p_i = (x_i, y_i, t_i)$  is a record point having a spatial location  $(x, y)$  at moment  $t$ ,  $t_1 < t_2 < \dots < t_{n-1} < t_n$ ,  $i= 1..n$  represents the number of points composing the  $T_k$ .

From conventional (e.g., based on car parking sensors) to technological (e.g., mobile devices), several methods have been explored for the estimation of ODMs. Anyhow, each method collects data that can be spatially and temporally analysed to identify human mobility patterns.

### 2.2. Mobile Network Data

For human mobility studies across many disciplines, mobile network data serves as a primary source of human footprints with georeferenced and time-stamped records of

human communication activities [4]. They are increasing due to the growth of intelligent, and interconnected mobile devices as we shift into the Internet of Things (IoT) era. The shift to an IoT world means that mobile devices such as smartphones, smartwatches, and people are always connected. These personal mobile devices generate a great amount of data about the activities of individuals on a daily basis. This new data source can shed light on everyday human activity both at an individual level and at a collective level. Taking advantage of this approach, called mobile crowd sensing, mobility projects are designed to address the spatial nature of human mobility, to remain independent of social characteristics, and to be comparable across geographic regions and time.

Thanks to the massive adoption of mobile devices the IoT is focusing on operational efficiency and automation. This increasingly connected society together with sophisticated sensor systems has changed not only the data transfer speed but also the scalability, connectivity, and energy efficiency of mobile networks. Thus, for the development of the digital society and to make the IoT work, we need a powerful wireless network that connects different types of devices and transfers large volumes of data fast. This is where the 5G mobile technology can be useful [14].

The move to 5G mobile networks is an action in response to the growth of IoT, improving spectrum efficiency, reducing latency, better supporting mobility and high connection density. This network densification combined with advanced wireless transmission technologies enables a higher throughput per individual user and makes the IoT more available to all [12]. The effect of 5G will be felt on almost every industry like information technology, manufacturing, health etc. Hence, many institutions, technological companies and research organizations are collaborating to form committees towards the research of 5G Technology. For example, supported by the European Commission, the mission of the European 5G Observatory provides updates on all market developments, including actions undertaken by the private and public sectors, in the field of 5G. Since the launches of the first 5G commercial services in late 2018, many commercial 5G networks and services have emerged in Europe. Consequently, a total of 15 players have launched commercial 5G services as of year-end 2019 [6]. The French IoT networking company SigFox has set a target to secure "global" coverage by setting up in China, India, and Russia, finally, and plugging three major gaps in its existing footprint [3]. Together, these projects are essential to explore the information that can be extracted to improve human lives. Based on it, the final goal is being able to transform acquired knowledge into new services for citizens.

### 3. Experimental Case Studies

In this section, we first contextualize two datasets of our study, followed by a description of them. Then, explain the aggregation of all data generated by human interaction with digital devices to explore individual and collective behaviors.

#### 3.1. Contextualization

Human mobility patterns reflect many aspects of life, from the urban planning to daily commute patterns. In recent years, the prevalence of technologies and methods, such as Wi-Fi systems, 3G, 4G, 5G and Bluetooth channels that are fundamental for real-time



communication of location-based data, has driven efforts to collect human mobility data and to mine patterns of interest within this data in order to promote the development of services. In this paper, we mine significant patterns in pedestrian mobility data using neural network technique, and therefore, we survey different approaches that analyze and learn human mobility patterns using Long Short-Term Memory (LSTM) method. But first, in data mining phase, we transform the LinkNYC Kiosks and NYC-311 service datasets into knowledge. This knowledge is expected to be a useful tool in decision-making processes. For an easier analysis and interpretation of knowledge we use the visualization process. Finally, based on the results of the population density in New York City obtained from data mining and visualization processes, given any location of urban area, time period or observed human mobility, we can model and forecast data trends to predict movements in the near future.

### 3.2. Data Sources

LinkNYC is a communication network that brings the fastest available free high-speed Wi-Fi, nationwide calling, a dedicated 911 button, charging ports for mobile devices, and access to selected websites to millions of New Yorkers. The dataset lists locations where a LinkNYC kiosk has been installed, including sites that have replaced public pay telephones (PPT). The census column displays the number of users that connect to LinkNYC devices on a daily basis. Moreover, we also include the weather condition attributes such as temp, precipitation, snowfall, snow/ice and depth.

The NYC-311 service requests aim to provide the public with quick, easy access to non-emergency government services and information, covering issues such as broken traffic lights, noise complaints, parking law enforcement, and potholes [5]. For this service New York City's authorities added two new attributes. The inclusion of the "Intake Channel" attribute, when available, will indicate on which channel a service request was filed by a customer and Borough Block-Lot (BBL), providing parcel numbers identifying the location of buildings or properties. As well as in the study of LinkNYC Kiosks, our attention was also focused on one dataset between 2016 and 2018 and includes the weather condition attributes previously mentioned.

### 3.3. Data Pre-processing

For both datasets being studied, the Knime Platform is used to get a selection of suitable mining techniques. First, data is aggregated to then perform data cleaning. Aggregation is combining various attributes into the "date" attribute (row data separated by a range of days). This environment helps identify missing values as well as values and events that occur repeatedly in the dataset to form certain patterns. While for the LinkNYC Kiosk dataset we replaced missing attribute values with the mean value for that attribute in the database, on 311 Service Requests a frequent pattern is applied to data because it doesn't take into account the sequence of events, but the frequency with which an item occurs. In addition, we merge the weather conditions dataset. This merge is only possible because three datasets of our work use the date as a primary key. A sample of collected data can be seen in Table 1.

Once the data mining process was chosen, and the appropriate dataset was accessed, extracted and prepared, input data must be provided in the amount, structure, and format

suiting to the modeling algorithm. Basically, data exploration will be used in understanding the prediction results of the data mining process. However, the section 3.4 already allows for the visualization and comprehension of the data.

**Table 1.** LinkNYC Kiosks and NYC-311 Service Requests datasets.

Date	Census	Temp (°C)	Humidity (%)	Precip	Wind (MPH)
2016-02-12	646	12	50.3	30.3	2
2017-01-01	888	-1	61.3	29.9	3
...	...	...	...	...	...

### 3.4. Gaussian Distribution

To extract maximum information from our data, we calculate the Gaussian distribution (also known as normal distribution). This distribution is a bell-shaped curve, and it assumes that any measurement census will follow a normal distribution with an equal number of measurements above and below the mean census. To verify that, using Eq. 3 the normal distribution of our data is shown in Fig. 1.

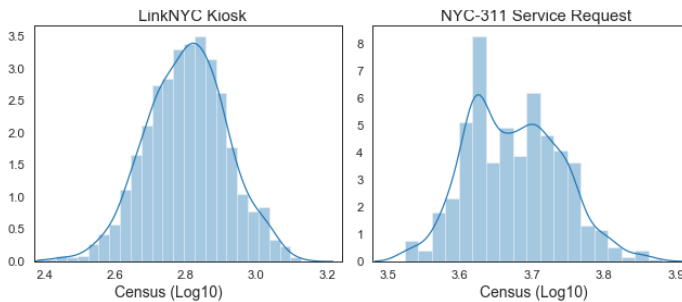

**Figure 1.** Normal distribution of data: density of population in city.

To determine if the data distribution strays from the normal distribution, we calculate the kurtosis and skewness. While the LinkNYC Kiosk data presents a kurtosis and skewness of 0.5 and 0.6, respectively, in the NYC-311 Service, these values are 0.2 and 0.6 respectively. Based on the results, the first dataset displays more satisfactory values. It indicates a Normal Distribution symmetrical in Kurtosis (e.g. values between -0.5 and +0.5) and a moderate skewness (e.g. values between -1 and -0.5 or 0.5 and 1). Therefore, unlike the distribution on the right side, the left side follows the normal distribution.

### 3.5. Model for predicting mobility

After the process of recognizing patterns, we train the data using a deep learning algorithm, for predicting and simulating human mobility. One of the best learning algorithms for time series data is Long Short Term Memory network (LSTM) [17]. To build it layer after layer, the Sequential class is used whereas Dense refers to a Deep multi-layered neural network. Dropout Regularization is used to prevent overfitting or reduce

complexity by randomly zeroing out a few units of different layers in a neural network based on its probability of retention. Moreover, the MixMaxScaler is used to scale the data to speed up the learning algorithm. While EarlyStopping is used to stop the Gradient at a point where it starts to increase again and prevent measure against overfitting. Before fitting the data, we normalize it and split into the train and test set. The model is trained over 100 epochs, number of batch size 70, and 50 LSTM neurons. To improve the performance of model we used k-fold cross-validation such as k=10 becoming 10-fold cross-validation. The outcome is the train and test loss of LinkNYC Kiosk and NYC-311 Service Request datasets.

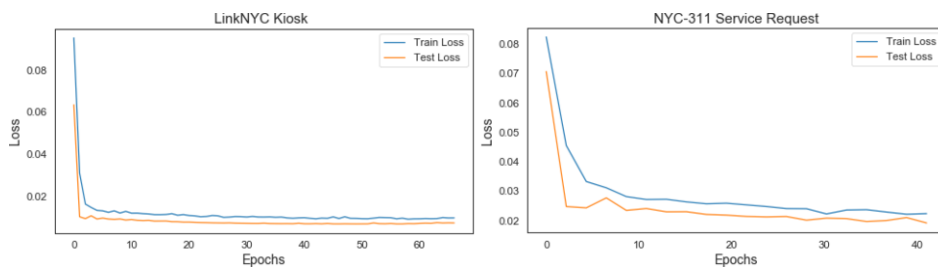

**Figure 2.** Data loss in the train and test sets.

From LSTM training, followed by running a few experiments, we can compare the performance between validation loss and training loss. Based on the results, the training loss is greater than validation loss for Fig. 2. This means that underfitting has occurred, respectively. Additionally, at the deepest level, we can quantify the loss function from Root Mean Squared Error (RMSE) and Root Mean Absolute Error (RMAE) values. They are used to evaluate the qualitative and quantitative trends in the data during validation and testing process. For the LinkNYC dataset the results of these errors are 0.18 and 0.14, but in the NYC-311 Services Requests dataset they are 0.15 and 0.12, so we classify the loss of both datasets as "good". Because, as loss measures the "goodness" of a model, the smaller the loss, the better the model accuracy.

### 3.6. Results

Each mobile devices interaction dataset has near five hundred thousand rows of data. In this case, to predict the sequence of values we also use a deep multi-layered Long Short Term Memory network. This model's settings are the same as the ones used for the train and test loss function. The three-year dataset (2016–2018) was used for validation purposes, and the one-year dataset (2017) was used for testing purposes. Once the neural network is trained, we predict and test data for a one-day forecasting model.

LynkNYC Kiosks and NYC-311 Service Requests show no correlation between the observed and predicted values for forecasting one day for each scenario. In Fig. 3, there are essentially no significant differences between predicted cases. The results of the validation process of both datasets also indicate that the constructed model can achieve equally impressive performance even if parameters have been changed. For example, if the epochs vary from 70 to 100 or the number of units varies from 80 to 150. However, all of these changes do not significantly improve the forecast results. Additionally, they illustrate the weather condition does not influence the forecasted result of the population density interacting with devices (e.g, mobile devices and kiosks).

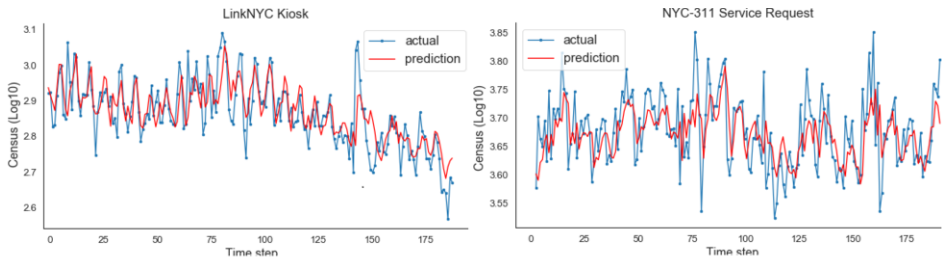

Figure 3. Actual and prediction data.

#### 4. Conclusions

Human mobility has a significant impact within cities. With this paper we demonstrate that technology such as mobile phones, Wifi, and RFID devices can be used to reduce this impact. Moreover, due to its increasing sophistication, these technologies are currently considered one of the major trends. That's why, in the last decade, New York authorities have made a substantial effort to provide interactive devices to users. In response to this growth of available mobile technologies, a new wireless communication and network infrastructure that connect different types of devices operating at high speeds must be taken into account. Therefore, the move to 5G systems brings significant progress to mobility support and high connection density.

Based on these hyper-dense heterogeneous networks, we propose a Data Mining approach that analyses LinkNYC Kiosks and NYC-311 Service Requests data. Besides the spatial, temporal and particular attributes they also take into account information about weather conditions. Both problems were modeled as Long-Short Time Memory algorithm, where the aim was the prediction of the census in multivariate time series. Moreover, several different epoch and batch size configurations in deep learning model and feature selections (using distinct combinations of spatial, temporal and meteorological variables) were tested. In this step, we have concluded that after 100 epochs the outcomes showed no changes, that is, the predictive accuracy did not change.

To our knowledge, this is the first time these datasets are predicted using only meteorological based data and further exploratory research is required. As argued, predicting with this size of dataset was a challenging task. To improve it, we believe that additional information (not available in this study) is required, such as the type of events and reasons that attract people to city centers. In the future, we intend to consider a dataset from a larger timeframe. The proposed model could improve the human mobility prediction accuracy if it analyzed more than three years of data.

#### References

- [1] Françoise Bahoken and Ana-Maria Olteanu Raimond. Designing Origin-Destination Flow Matrices from Individual Mobile Phone Paths The effect of spatiotemporal filtering on flow measurement. *26th International Cartographic Conference*, 2013.
- [2] Peter Becker-Kern, Mark M Meerschaert, and Hans Peter Scheffler. Limit theorem for continuous-time random walks with two time scales. *Journal of Applied Probability*, 41(2):455–466, 2004.

- [3] James Blackman. Sigfox sets 'Zero-G' strategy to underpin 5G/IoT system, secure global network, 2019.
- [4] Guangshuo Chen, Aline Carneiro Viana, and Marco Fiore. Human Trajectory Recovery via Mobile Network Data.
- [5] City of New York. Service request status, 2014.
- [6] Commission European. 5G is really ON in Europe – 5G Observatory, 2020.
- [7] Bruno Fernandes, Fábio Silva, Hector Alaiz-Moretón, Paulo Novais, Cesar Analide, and José Neves. Traffic Flow Forecasting on Data-Scarce Environments Using ARIMA and LSTM Networks. In *Advances in Intelligent Systems and Computing*, 2019.
- [8] Bruno Fernandes, Fábio Silva, Cesar Analide, and José Neves. Crowd sensing for urban security in smart cities. *Journal of Universal Computer Science*, 2018.
- [9] 19th EPIA Conference on Artificial Intelligence. <https://epia2019.utad.pt/>, 2019.
- [10] Shan Jiang, Joseph Ferreira, and Marta C. González. Clustering daily patterns of human activities in the city. *Data Mining and Knowledge Discovery*, 25(3):478–510, 2012.
- [11] Chaogui Kang, Xiujun Ma, Daoqin Tong, and Yu Liu. Intra-urban human mobility patterns: An urban morphology perspective. *Physica A: Statistical Mechanics and its Applications*, 391(4):1702–1717, feb 2012.
- [12] Taras Maksymyuk, Mykola Brych, and Volodymyr Pelishok. Stochastic Geometry Models for 5G Heterogeneous Mobile Networks. *The Smart Computing Review*, pages 89–101, 2015.
- [13] Walter Mischel. Toward a cognitive social learning reconceptualization of personality. *Psychological Review*, 80(4):252–283, 1973.
- [14] Rupendra Nath Mitra and Dharma P. Agrawal. 5G mobile technology: A survey. *ICT Express*, 1(3):132–137, 2015.
- [15] P. Lévy. *Théorie de l'Addition de Variables Aléatoires*. (Gauthier-Villars, Paris), 1937.
- [16] Gabriel Ramos-Fernández, José L. Mateos, Octavio Miramontes, Germinal Cocho, Hernán Larralde, and Bárbara Ayala-Orozco. Lévy walk patterns in the foraging movements of spider monkeys (*Ateles geoffroyi*). Technical Report 3, Behavioral Ecology and Sociobiology, 2004.
- [17] Tara N. Sainath, Oriol Vinyals, Andrew Senior, and Hasim Sak. Convolutional, Long Short-Term Memory, fully connected Deep Neural Networks. In *ICASSP, IEEE International Conference on Acoustics, Speech and Signal Processing - Proceedings*, 2015.
- [18] Ernst Schachtel. Personality. A Psychological Interpretation. *Zeitschrift für Sozialforschung*, 7(1):245–245, 1938.
- [19] Ted Serbinski. Defining Mobility for the Automotive Industry, 2016.
- [20] Fábio Silva and Cesar Analide. Ubiquitous driving and community knowledge. *Journal of Ambient Intelligence and Humanized Computing*, 2017.
- [21] David W. Sims, Emily J. Southall, Nicolas E. Humphries, Graeme C. Hays, Corey J.A. Bradshaw, Jonathan W. Pitchford, Alex James, Mohammed Z. Ahmed, Andrew S. Brierley, Mark A. Hindell, David Morritt, Michael K. Musyl, David Righton, Emily L.C. Shepard, Victoria J. Wearmouth, Rory P. Wilson, Matthew J. Witt, and Julian D. Metcalfe. Scaling laws of marine predator search behaviour. *Nature*, 451(7182):1098–1102, feb 2008.

This page intentionally left blank

## Subject Index

activity recognition	167	drones	72
agent	82	elderly	39
aircraft inspection	72	elderly care	9
algorithms	278	electroencephalography (EEG)	19
<i>alternaria solani</i>	127	energy audits	252
ambient intelligence	9	energy efficiency (EE)	252, 259
anomaly	311	entropy	311
approximate entropy	321	facial recognition	39
artificial intelligence	9	FastDTW	321
auditing	331	FCM	400
autoencoders	343	FIPA	82
automatic code generation	29	FM	400
Bayesian Maximum Entropy	343	fuzzy logic	9
big data	115	GDPR	115
biometrics	5	geolocalization	361
brain computer interface (BCI)	19	geostatistics	133
cardiac monitoring	167	GIS-GPS	133
cardiac rehabilitation	167	graph	187
cloud computing	177	hard real-time systems	62
clustering algorithms	400	hardware testbed	301
clustering analysis	143	HEART framework	197
CoAP	207	home rehabilitation	29
commodities	268	honeybees	152
communication patterns	82	hotel	252
competition	95	household energy consumption	311
computer vision	152	human emotion	19
containers	331	human mobility pattern	410
context-aware	167	HWMP	301
convolutional neural network	72, 152	hyperspectral data	127
COVID-19	5	intelligent data analysis	143
cross ventilation	259	intelligent environments	5, 217
crude oil	268	Internet of Things (IoT)	39, 95, 105, 207, 291, 343
customised exergames	29	IoT Architecture	177
cybersecurity	207	interoperability	95
data analysis	391	intrusion detection systems	207
data protection	105	IP	95
datasets	207	JADE	82
decision tree	127	K-mean	400
deep neural network	410	key performance indicators	29
device network dataset collection	410	kriging	133
digital multimedia	19	last-mile delivery	353
direction identification	152	local heritage	278
discrepancies	229		

local temperature models	229	security	105, 331
LSTN	152	sensors	5
medicine dispenser	39	sentiment analysis	371
metadata	105	shortest path	187
micro-climate	242	smart cities	187, 410
microservices	291	smart energy	252
missing data imputation	343	smart grid	54, 291, 321
mobile application	39	smart grid neighborhood area networks	301
mobile health	5	smart home	9
motion assessment	152	smart meter	321
MQTT	207	smart mobility	353
multi-agent system	9, 82	smart system	39
multi-scaling	229	social media	381, 400
multi-user environments	217	social sensing	361
named entity recognition	361	social sensor	371
natural language processing	197	social-media analytics	361
natural materials	259	software development	381
non-personal data	105	solar energy	252
numerical modelling	229	spaCy	361
OLSR	301	spatial variability	133
online marketing	381	surface forcing	229
online social networks	391	surface temperature	242
open-source IoT platform	177	SUS	197
optimization	187	sustainability	278
pandemics	115	sustainable agriculture	143
parametric building design	278	system design	217
pedestrian-oriented applications	177	telehealth	5
plant disease detection	127	testing	291
power supply	54	thermal indoor management	259
precision agriculture	143	time series analysis	321
precision farming	133	topic categorization	371
price relationships	268	traffic management	187
privacy	105, 331, 391	Twitter	371
problem detection	371	urban environment(s)	229, 242
PV roof	242	urban fabric	278
quality of information	343	usability	381
random forest	127	USB	54
RASA	197	user experience	197
real-time kernels	62	user preferences	217
real-time systems	62	vehicle routing	353
reliability	72	volatility	268
resilience	278	Voronoi diagram	278
Rust	62	web applications	381
safety critical systems	62	wireless ad hoc networks	301
scalability	331	wireless mesh networks	301
seasonal ESD	321		



## Author Index

Alaiz-Moreton, H.	207	Garach-Hinojosa, A.	82
Alcañiz, T.	343	García-Coria, J.A.	353
Almenares, F.	291	García-Ordás, M.T.	207
Almenares-Mendoza, F.	331	García-Rodríguez, I.	207
Alonso, R.S.	353	García-Rubio, C.	311
Alorda, B.	252, 259	Garrido, M.C.	143
Amaral, A.	187	Gennari, F.	95
Analide, C.	165, 177, 197, 410	Gerybaite, A.	115
Arcas-Túnez, F.	361, 371	Ghogho, M.	242
Ashie, Y.	242	Gomes, M.	197
Astudillo León, J.P.	301	Gómez-Fernandez, F.J.	391
Augusto, J.C.	3, 51, 167, 217	Gómez-Portes, C.	29
Aurucci, P.	115	González-Vidal, A.	343
Aveleira-Mata, J.	207	Guerrero-Ulloa, G.	39
Bakhat, M.	268	Gutiérrez, D.	9
Bakkali, M.	229, 242, 278	Holgado-Terriza, J.A.	82
Banda, G.	62	Hooda, P.S.	133
Belkacem, A.N.	19	Hornos, M.J.	39, 51
Bin Ilyas, E.	343	Hunter, G.	152
Bouarfa, S.	72	Ibán-Sánchez, A.	207
Braun, A.	5	Ichikawa, H.	54
Cadenas, J.M.	143	Iggena, T.	343
Campo, C.	311	Imbernón, B.	400
Carmona, C.	259	Jamil, N.	19
Carneiro, D.	187	Jothibasau, K.	62
Carvalho, M.	187	Kachole, S.	152
Casado-Vara, R.	353	Kawakita, Y.	54
Cecilia, J.M.	361, 371, 400	Laaroussi, F.-E.	278
Chiara, P.G.	105	Lacave, C.	29
Chica-Manjarrez, S.	331	Lakas, A.	19
Costa, A.M.	197	Lino, C.	9
de la Cruz Llopis, L.J.	301	Llanes, A.	400
Díaz Redondo, R.P.	321	Marín-López, A.	291, 331
Díaz-Sánchez, D.	291, 331	Martínez, R.	143
Duran, O.	152	Mohiuddin, A.S.M.	133
Dziubański, K.	127	Moià-Pol, A.	252
Eberharter, C.	381	Molina, A.I.	29
Estévez Caldas, A.	321	Morales-García, J.	400
Fensel, A.	381	Moretón, H.	165
Fernández Vilas, A.	321	Moseley, R.	167
Fernández-Coello, Ma.M.	39	Moure-Garrido, M.	311
Fernández-Martínez, N.J.	371	Muñoz, A.	217
Fernández-Pedauey, J.	361	Muñoz, J.	259

Nouh, B.	278	Sepúlveda-Muñoz, A.	371
Novais, P.	165, 197	Serafico, J.	72
Ogbuabor, G.O.	167	Silva, F.	165, 177, 197, 410
Ouassaid, M.	242	Skarmeta, A.F.	343
Ouhbi, S.	3, 19	Smith, M.	133
Periñán-Pascual, C.	361, 371	Smykała, K.	127
Pico-Valencia, P.	82	Tamura, K.	54
Prieto, J.	353	Terroso-Sáenz, F.	391
Puga, H.	9	Tobe, Y.	54
Quinde, M.	3	Uddin, Md.J.	133
Ramírez, M.	9	Vallejo, D.	29
Rodríguez, S.	353	van Wyk, A.	167
Rodríguez-Domínguez, C.	39	Würzburg, K.	268
Rosa, L.	177, 410	Yokogawa, S.	54
Rubio-Drosdov, E.	291	Zamudio, V.	9
Rullan, P.	252	Zaz, A.	242
Ruszczak, B.	127		