

DOI: 10.5281/zenodo.3784283
CZU 621.548



THE PERFORMANCE OF DIFFERENT VERTICAL AXIS WIND TURBINES WITH J-SHAPED BLADES

Ivan Rabei*, ORCID ID: 0000-0003-1097-2463

Technical University of Moldova, 168, Stefan cel Mare Bd., MD-2004, Chisinau, Republic of Moldova

*ivan.rabei@tcm.utm.md

Received: 04.03.2020

Accepted: 05.04. 2020

Abstract. This study is focused on the aerodynamic optimization of Vertical Axis Wind Turbines' blades. A special feature was investigated – the opening at the blade's trailing edge (opened blades). The blades having this element are known as J-shaped blades. The analysis was done experimentally by testing eleven small scale turbines which were organized into four sets. The performance was compared within each set which contained both full and open bladed turbines. Two airfoil types were examined: symmetrical NACA 0018 and asymmetrical FX 63-137, and two types of blades: straight and helical. The compared turbines had the same key parameters and were subjected to the same external conditions. The tendencies clearly favored the J-shaped turbines for all cases. Besides superior productivity, the open bladed turbines started generating power from lower wind speeds. The positive effects of the openings were not the same for all examined cases and were influenced by the airfoil type, blade shape, openings orientation and wind speed.

Keywords: *blade opening, efficiency improvement, helical blades, J-shape, straight blades, vertical axis wind turbine.*

1. Introduction

There is a worldwide ongoing progress regarding the implementation of renewable energy conversion systems [1].

Even more advancement is expected as many countries and regions set future goals of covering close to 100% of their energy needs from renewable energy sources by the year of 2050 [2].

Solar and wind are the main sources. Highly efficient Horizontal Axis Wind Turbines are the first choice applied for converting the wind energy.

Vertical Axis Wind Turbines (VAWTs) family shares much less use mainly due to efficiency and structural issues. VAWTs' main advantage lays in the fact that they are omnidirectional, thus they are more adaptable to variable winds.

Other important advantages associated to VAWTs are listed comparatively by Aslam Bhutta et al [3].

In order to benefit from them, the mentioned problems need to be addressed. This paper is concerned with the efficiency issue.

1.1. Background

The VAWT's efficiency enhancement could come from many sources. Some of them are of external origin on which one can have little to no control at all. For example the wind speed – higher values being associated with higher efficiency [4]. The remaining sources are related to rotor's parameters and constructive features. The straight bladed wind rotor has four main parameters: rotor's height and diameter, blade's airfoil and chord length. From these a few others can be derived: swept area, solidity, rotor's aspect ratio, blade's aspect ratio. Optimizations could come largely from establishing the best combination of them but not only. Particular constructive features related to variable pitch angle [5 - 7], reducing blade tip effects [8 - 9], blade shape (straight, helical, curved) [10 - 11] etc. can be successfully employed for boosting the performance.

This paper addresses a particular blade feature, namely the opening at trailing edge. The blades possessing this element are known as J-shaped blades (the notions opened and J-shaped blades are used interchangeably in this paper). The opening is a type of discontinuity or sharp change done purposefully on the blade's cross section named airfoil. The Figure 1 depicts a full and an opened blade segment. In this particular example the opening size is equal to $1/3$ of the chord length c which is the line that connects the blade's leading and trailing edges. Here the opening is formed by the discontinuous airfoil line that leaves the blade's interior exposed to an eventual air flux.

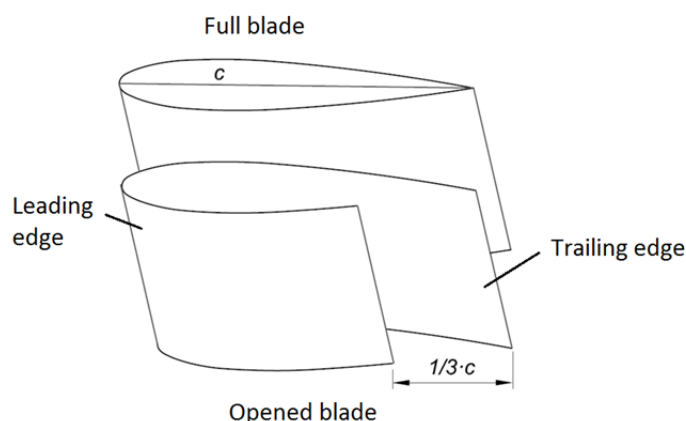

Figure 1. Example of a full and an opened blade.

Various other types with different sizes can exist or be designed but they are not subject of this paper (examples shown in Figure 2).

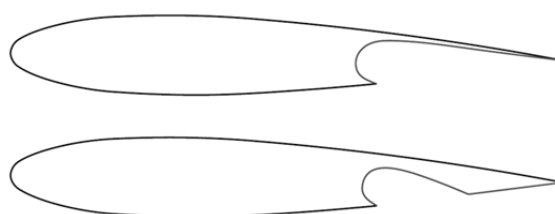

Figure 2. Different types of openings.

The opening effects have been analyzed by some authors. Chen [12] sought to improve VAWT's self-starting abilities by employing opened blades. The author focused on NACA 0015 airfoil. The results obtained by CFD simulations showed no efficiency

improvement. Zamani et al [13] analyzed a straight bladed VAWT using NACA 0015 airfoil and its J-shaped version by using CFD. The authors concluded that J-shaped blades enhance the power and torque coefficients and increase self-starting abilities. Siddiqui et al [14] did experiments on straight bladed Darrieus turbines with conventional and J-shaped blades based on NACA 2424 airfoil. The performance coefficient displayed by the J-shaped rotor was 30% higher than that of its conventional counterpart. Mohamed [15] did a CFD analysis on three wind turbines with blades defined by NACA 0015, NACA 0021 and S1046 airfoils, full and with openings of different sizes. The author does not recommend the J-shaped blades for Darrieus wind turbines as they showed neither efficiency increment nor noise reduction.

1.2. Research goals

The purpose of this paper is determining experimentally how the openings influence the VAWTs' productivity since there seem to be contradictions between the recommendations. The analysis considered the following aspects:

1. Different airfoils might be affected by the openings differently, hence two distinct types were adopted – the symmetrical NACA 0018 and the asymmetrical (cambered) FX 63-137.
2. The opening could be placed either on the blade's inner or outer side (inward or outward, see Figure 3). It was studied if this aspect is of any relevance.

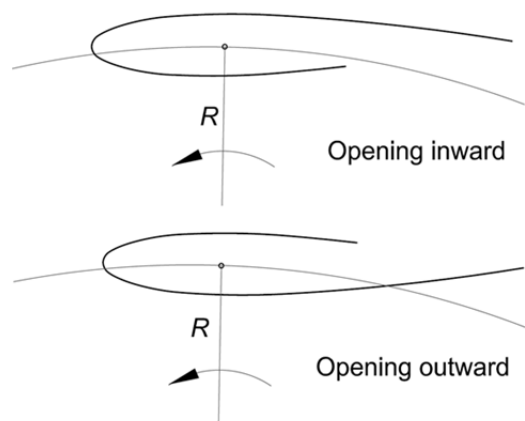

Figure 3. Opened symmetrical airfoils oriented radially inward and outward (R – rotor's radius).

3. The conventional asymmetrical airfoils can be disposed either with the curvature (camber) inward and outward. When adding the openings, four more versions are generated: curvature in opening in, curvature in opening out, curvature out opening in, curvature out opening out (Figure 4). These possibilities were taken into account.

4. The blades can be of different shapes: straight, helical, curved. Openings were adopted for straight and helical bladed turbines. The study is based on observations made on eleven small scale wind turbines tested in the wind tunnel. Particular attention was paid to the conditions in which the turbines were compared. Except the openings for some of them, all compared rotors had the same key parameters.

The blade model addressed in this article has openings formed as in Figure 1 with the size equal to $1/3$ of the chord length c and disposed along the blade's entire length. This size is rather a starting value and there is no particular reason for choosing exactly this one.

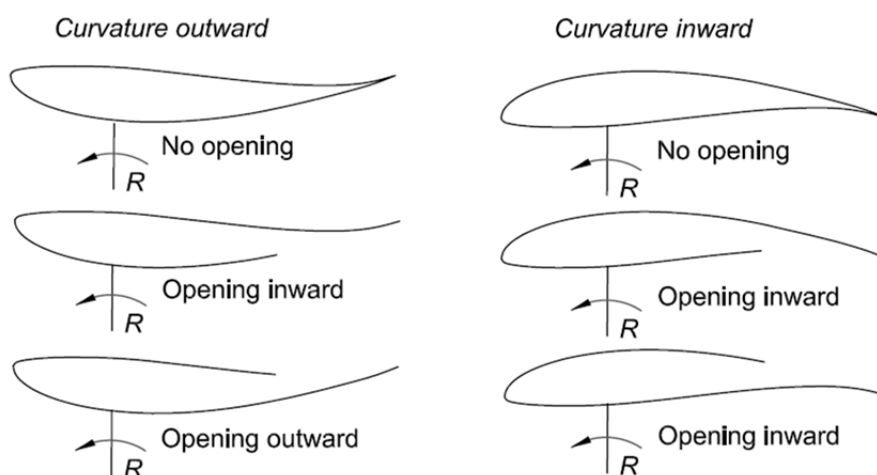

Figure 4. Full and opened asymmetrical airfoils, inward and outward curvature.

The paper is divided into four parts. In the first one the problem is formulated, known information is exposed and research objectives are stated. The second part introduces the theoretical considerations and experimental setting. In the third part the results are presented and discussed. Conclusions are listed in the last part.

2. Methodology

2.1. Theoretical considerations

Four sets of small scale turbines were prepared. Each set was characterized by its proper blade shape and airfoil type. Excluding one, each set consisted of three rotors: first one with full blades; the second had openings oriented outward and the third with inward openings. The turbines' performance reflected by the generated electric power was graphically displayed and the tendencies determined.

Except for the openings and their orientation, all the compared turbines had the same key parameters which refer to: swept area, solidity, number of blades, airfoil, chord length, aspect ratio, height, diameter, blade length and pitch angle. Each of these parameters influences the turbine's performance. By keeping them the same for all compared cases no performance difference was expected to be generated, the only distinction being induced by the openings presence and their positioning.

The definitions and implications of the above parameters are described as follow.

The swept area is the rotor's section crossed by the air flow. Geometrically, it represents the area confined by the rotor's height and diameter. The power P generated by a wind turbine can be calculated with the formula:

$$P = \frac{1}{2} \cdot C_p \cdot \rho \cdot A \cdot U^3 \quad (1)$$

where C_p is the efficiency coefficient; ρ – air density; A – rotor's swept area; U – wind speed. The bigger the area, the more power is generated thus the same value was adopted for all compared rotors.

The swept same area can be confined by different values of the diameter and height. The parameter that deals with this is called aspect ratio, defined as the ratio between rotor's height and its diameter. This feature also influences the turbine's efficiency [16 - 17] thus it was kept the same for all cases.

Solidity σ is the ratio between the area covered by the blades and the swept area. For a straight bladed rotor, it can be calculated with the equation:

$$\sigma = (N \cdot c \cdot L) / A = (N \cdot c) / D \quad (2)$$

where N – number of blades; c – chord length; L – blade length which for straight bladed rotor is equal to its height h ; D – rotor's diameter. For a constant aspect ratio and blade number, the solidity can be modified by changing the blade's chord length, hence the four parameters are strongly related.

Along with the airfoil, the solidity determines the turbine's conversion efficiency and optimal tip speed ratio (TSR or λ). TSR is the ratio between the tangential speed v of the rotating blade and the wind speed U . An example showing the turbine's efficiency C_p for different solidities is depicted in Figure 5.

The graph obtained by QBlade simulation involves a VAWT with the parameters: diameter – 6 m, height – 6 m, NACA 0018 airfoil and four different values for chord length and consequently solidity. Each value comes with its proper peak efficiency (C_p) and tip speed ratio. As solidity strongly influences the turbine's performance each set of rotors considered in this paper was characterized by its proper value.

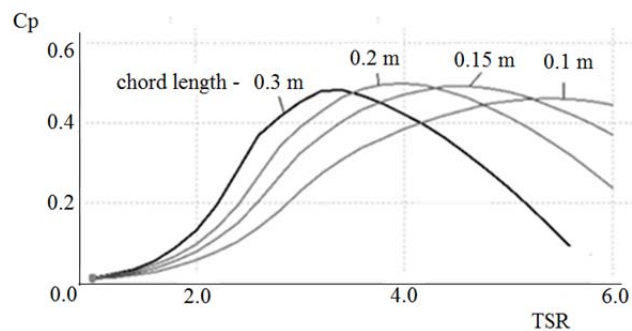

Figure 5. Efficiency coefficient dependence on the solidity determined by different chord lengths.

The pitch angle β is the angle between the chord line and the tangent line of the blade's circular trajectory. It can take positive, null or negative values (Figure 6) and it is normally fixed but there are turbines designed so that the pitch angle varies. A simulation involving the same rotor as above is presented in Figure 7. It can be observed that the efficiency is influenced by the pitch angle. These effects were also noticed in laboratory tests thus the blades for all rotors had the same pitch angle.

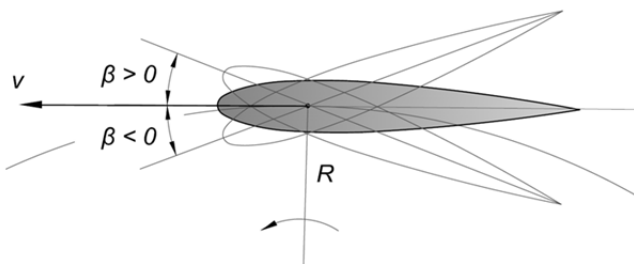

Figure 6. Pitch angle β (v – blade's tangential speed).

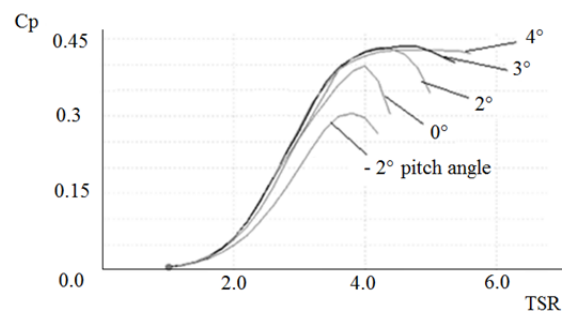

Figure 7. VAWT's efficiency for different pitch angles.

For the case of helical rotors of the same key parameters, changing the helical angle Λ (Figure 8) comes with a change in efficiency. This study involved two sets of helical rotors having the same helical angle.

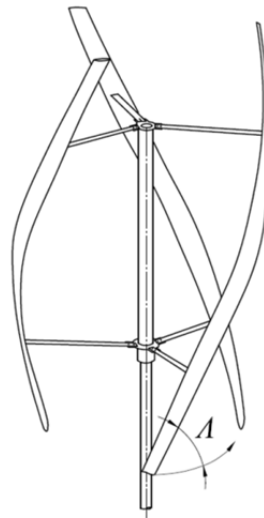

Figure 8. Helical angle Λ .

2.2. Experimental setting

One wind turbine was designed and built so that it allowed changing the blades (Figure 9). This way the tower, supporting arms and electric generator remained the same while the blades that were easily attached formed different wind turbines.



Figure 9. Changing the blades allows forming different VAWTs with the same tower supporting arms and electric generator.

The blades were made by 3D printing. Segments were obtained and then glued together to form an element with the necessary length. The blade was then taped for better rigidity. Figure 10 depicts three straight blades, each from different rotors of the same set. The first one has the opening disposed on one side; the second on the other side and the third has no opening. In this example the blades are defined by the FX 63-137 airfoil.



Figure 10. 3D printed opened and full blades, FX 63-137 airfoil.

A three phase generator was attached to the rotor's shaft. The connection between the two was mediated by a gear train of ratio 1:3.41. The alternating current was transformed into direct current by using a rectifier from which two wires were connected to the NI ELVIS platform with the RElab add-on (Figure 11). This device was specially designed to determine and display via a computer the power generated by a small wind turbine [18].

The wind tunnel Gunt ET 220 was used for the experiments. This machine was designed to test an embedded horizontal axis wind turbine but it was adapted to test vertical axis wind turbines. The tunnel's diameter is equal to 610 mm and the maximum wind speed generated varies around 12 m/s.



Figure 11. NI Elvis II platform with RElab module.

3. Results and discussion

Firstly three straight bladed turbines were prepared. One turbine had full blades; the blades for the second had the openings oriented inward and for the third the openings were oriented outward. Except the openings and their positioning, all rotors were defined by the same main parameters listed in Table 1. The symmetrical NACA 0018 airfoil was used in this case.

Table 1

The parameters of the straight bladed rotors

Rotor's height, (m)	h	0.4
Rotor's diameter, (m)	D	0.4
Number of blades, (λ)	N	3
Blade's length, (m)	L	0.4
Chord length, (m)	c	0.05
Swept area, (m ²)	A	0.16
Solidity, (λ)	σ	0.375
Aspect ratio (λ)	RA	1
Pitch angle, (°)	β	0
Opening length (mm)		16.7
Airfoil type	NACA 0018	

The turbines were tried in the wind tunnel for the following wind speeds: 7.2 m/s, 8.5 m/s, 10 m/s, 11 m/s and 12 m/s. For each wind speed five tests were performed and the average power was calculated. The values obtained are presented in the Table 2 and graphically interpolated in Figure 12.

Table 2

The power produced by three straight bladed rotors, NACA 0018 airfoil

Wind speed (m/s)	7.2	8.5	10	11	12
Generated power (mW)					
No openings	0	0	3.00	14.30	26.20
Openings in	0	4.10	20.50	69.00	125.00
Openings out	0	3.60	21.30	68.14	113.20

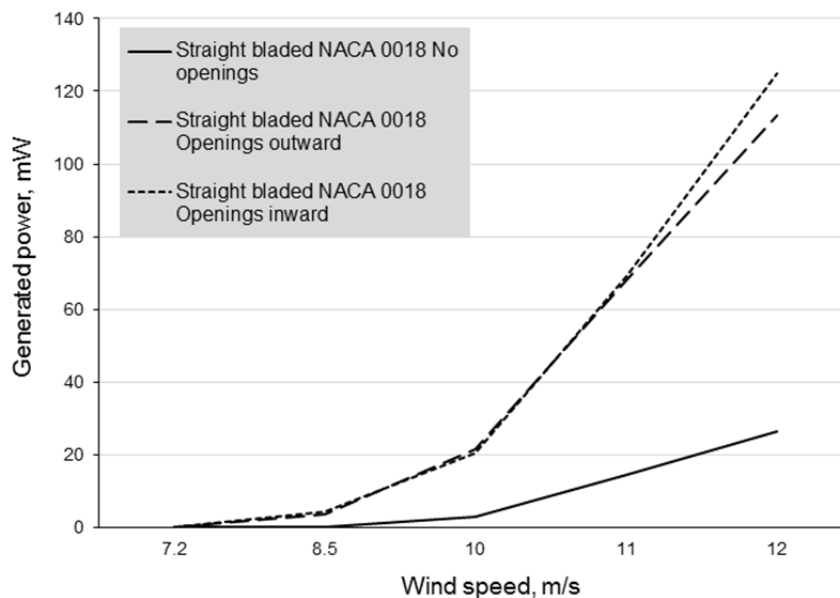

Figure 12. The power generated by the turbines with full and open straight blades, NACA 0018 airfoil.

The tendencies clearly favor the opened bladed turbines over the full bladed one. For example the opening out version generated 4.3 times more power at 12 m/s, 4.7 times at 11 m/s and 7.1 times at 10 m/s. Besides efficiency the J-bladed turbines started generating power from lower wind speeds. There was little difference between the efficiency of inward and outward versions. The noticeable distinction was at 12 m/s when the opening in turbine produced 9% more power.

A second set of three straight bladed rotors were tested, this time with the blades defined by the asymmetrical FX 63-137 airfoil. Laboratory trials showed that the curvature outward mode is more efficient so only this blade arrangement was further investigated. The rotors' main constructive parameters were the same as of the previous set (Table 1) except for the airfoil type. The results are shown in Table 3 and graphically in Figure 13.

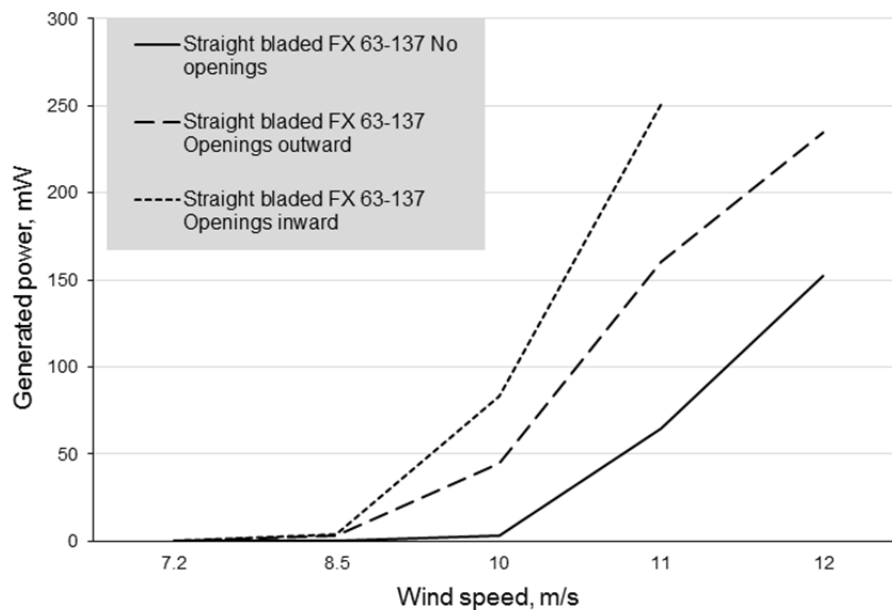

Figure 13. The turbines with full and opened blades, FX 63-137 airfoil curvature outward.

Table 3

The power produced by three straight bladed rotors, FX 63-137 airfoil curvature out

Wind speed (m/s)	7.2	8.5	10	11	12
Generated power (mW)					
No openings	0	0	3.00	64.67	152.33
Openings in	0	4.00	83.00	250.67	Not tested
Openings out	0	3.00	45.00	160.33	234.33

As in previous case, the opened blades came with more generated power but the character was different. There was a distinct difference between the opening inward and outward turbines. At 11 m/s the inward version generated 1.5 times more energy, at 10 m/s – 1.8 times and at 8.5 m/s – 1.3 times.

The opening inward turbine was not tested at 12 m/s as there was the risk of harming the blades due to the high number of rotations per minute.

The least productive opened turbine – the opening out version, generated 1.5 times more energy at 12 m/s than the full bladed turbine, 2.5 times at 11 m/s and 15 times at 10

m/s. As for the previous set the J-shaped turbines started producing power from lower wind speeds.

A third set of three rotors was tried with the parameters presented in Table 4. Here the blades were of helical shape based on NACA 0018 airfoil. The results are depicted in Figure 14 and Table 5.

Table 4

The parameters of the straight bladed rotors		
Rotor's height, (m)	h	0.4
Rotor's diameter, (m)	D	0.4
Number of blades, (λ)	N	3
Blade's length, (m)	L	0.434
Chord length, (m)	c	0.05
Swept area, (m ²)	A	0.16
Solidity, (λ)	σ	0.3416
Aspect ratio (λ)	RA	1
Pitch angle, (°)	β	0
Opening length (mm)		16.7
Airfoil type	NACA 0018	

Table 5

The power produced by three helical bladed rotors, NACA 0018 airfoil					
Wind speed (m/s)	7.2	8.5	10	11	12
	Generated power (mW)				
No openings	0	0	4.00	19.40	35.60
Openings in	0	5.00	27.90	81.57	143.60
Openings out	0	6.60	37.00	108.86	175.60

As for the above cases, the open bladed turbines started generating power from lower wind speeds showing throughout significantly better productivity.

For example at 12 m/s the inward version, which was less efficient than outward version, generated 4 times more energy than the full bladed turbine, at 11 m/s – 4.2 times and at 10 m/s – 7 times.

Unlike the straight bladed turbines of the same airfoil, there was a clear difference between the inward and outward versions, the last one being 1.2 times more efficient at 12 m/s and 1.3 times at 11 m/s, 10 m/s and 8.5 m/s.

The fourth set comprised two helical turbines based on FX 63-137 airfoil curvature outward mode.

First turbine had blades with no openings and for the second the openings were oriented inward. The rotors' main parameters were the same as for helical NACA 0018 rotors except for the airfoil type (Table 4).

The results are shown in Figure 15 and Table 6. For this final case the openings retained the same benefits: more power generation starting with lower wind speeds.

The opened bladed turbine produced 2.6 times more energy at 12 m/s, 3.6 times at 11 m/s and 8.6 times at 10 m/s.

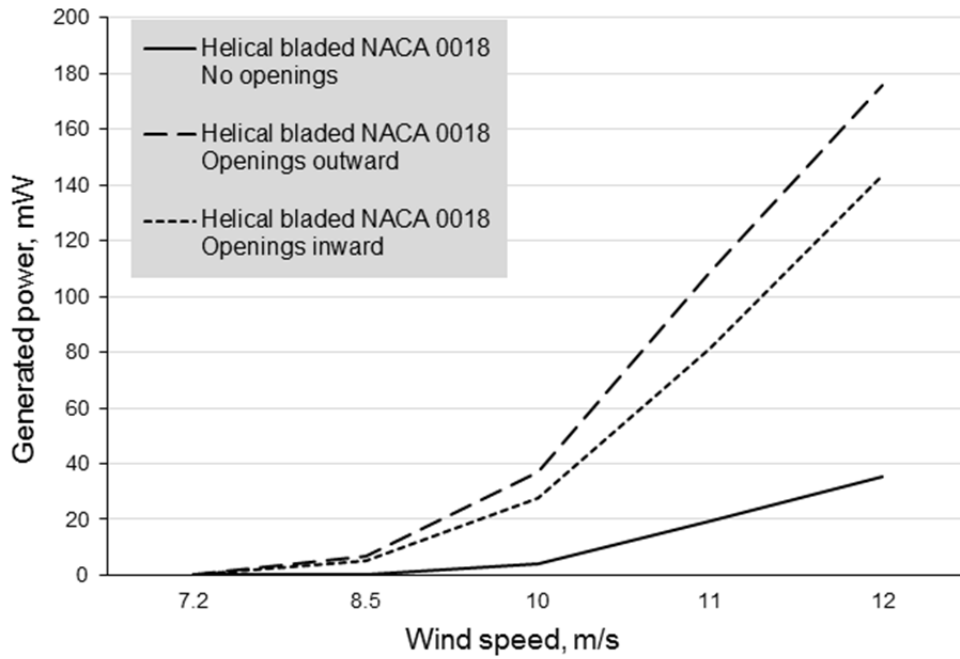

Figure 14. The helical turbines with and without openings at the blades trailing edges, NACA 0018 airfoil.

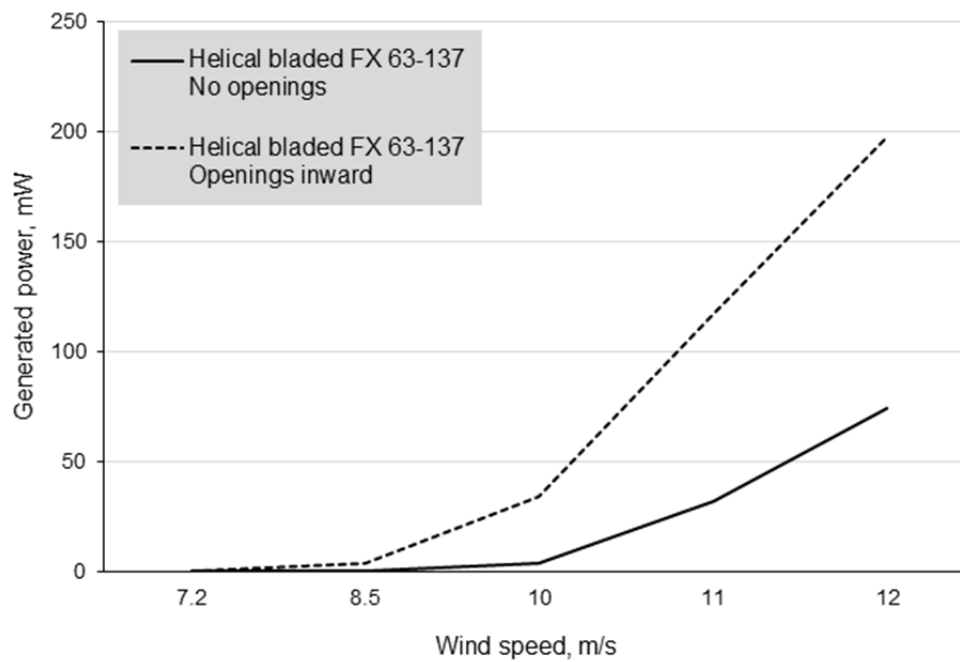

Figure 15. Helical turbines with full and opened blades, FX 63-136 airfoil curvature outward.

Table 6

The power produced by two helical bladed rotors, FX 63-137 airfoil curvature out

Wind speed (m/s)	7.2	8.5	10	11	12
Generated power (mW)					
No openings	0	0	4.00	32.33	74.00
Openings in	0	4.00	34.33	117.00	197.67

It was calculated that the tested turbines operated for a Reynolds number (Re) of about 40000 while for real scale turbines this value is usually higher than 100000. The average relative wind speed was used for the calculation. However the scaling aspects were not of interest here but rather determining tendencies which clearly suggest the potential of J-shaped blades.

4. Conclusions

The goal of the study was to observe performance tendencies displayed by opened and full bladed turbines to determine if the J-blades have any potential for vertical axis wind turbines efficiency boost. Four sets comprising a total of eleven turbines were studied. Except one, each set consisted of three rotors: one with full blades, one with J-blades having the openings oriented inward and one J-bladed with openings outward. Two sets were based on symmetrical NACA 0018 airfoil and the other two on asymmetrical FX 63-137 airfoil. Both helical and straight blades were considered. Except the openings and their orientation, all compared rotors had the same key parameters. The results led to the following conclusions:

1. For all four cases the J-shape bladed turbines generated significantly more energy than their full bladed counterparts. Even for the least favorable case the J-bladed turbine produced 50 % more energy;
2. In all examined instances the J-shaped turbines started producing power from lower wind speeds regardless of opening orientation, airfoil or blade shape (straight or helical);
3. The J-shaped blades came with more productivity but the effects were not the same for all cases. Their impact depends on the airfoil type, blade shape, opening orientation, wind speed.

From the above conclusions a few ideas can be drawn:

- As the openings significantly improved turbines' efficiency, this solution is worth trying when looking to optimize an airfoil. For example when an optimum airfoil is selected and is to be applied for a real VAWT, one can consider analyzing its opened version as it can come with even more performance. If possible, a good idea would be analyzing these aspects experimentally. Studying the optimal opening size is also recommended;
- The J-shaped blades were more productive but the degree of efficiency was not the same for all studied cases. There might be cases for which the openings are less efficient than their full version counterparts, though this was not the case for the present analysis. Generalization on the openings advantages cannot be done yet as more cases need to be studied for a conclusive statistics.

Acknowledgements

The author would like to express gratitude to the laboratory personnel from the Electrical Engineering Department of Technical University of Moldova for their helpful assistance during the tests.

References

1. IRENA. Future of wind: Deployment, investment, technology, grid integration and socio-economic aspects (A Global Energy Transformation paper), International Renewable Energy Agency, Abu Dhabi. (2019) ISBN 978-92-9260-155-3.
[disponibil] https://irena.org/-/media/Files/IRENA/Agency/Publication/2019/Oct/IRENA_Future_of_wind_2019.pdf [Accessat 04.04.2020].

2. European Commission, Communication from the Commission to the European Parliament, the European Council, the Council, the European Economic and Social Committee, the Committee of the Regions and the European Investment Bank, Brussels, 28.11.2018 COM (2018) 773 final.
[disponibil] <https://eur-lex.europa.eu/legal-content/EN/TXT/PDF/?uri=CELEX:52018DC0773&from=EN>
[Accessat 04.04.2020].
3. Aslam Bhutta M. M., Hayat N., Farooq, A.U., et al. Vertical axis wind turbine – A review of various configurations and design techniques. *Renewable and Sustainable Energy Reviews*, 16(4) (2012) 1926–1939. doi:10.1016/j.rser.2011.12.004.
4. Castillo J. Small-scale vertical axis wind turbine design. Bachelor's thesis, Degree program in Aeronautical Engineering, Tampere University of Applied Sciences (2011).
<https://upcommons.upc.edu/bitstream/handle/2099.1/19136/memoria.pdf> (Accessed March 11, 2020).
5. Abdalrahman G., Melek W., Lien F. S. Pitch angle control for a small-scale Darrieus vertical axis wind turbine with straight blades (H-Type VAWT). *Renewable Energy* 114 (2017) 1353-1362. DOI.org/10.1016/j.renene.2017.07.068.
6. Xu Y. L., Peng Y. X., Zhan S. Variable pitch to high-solidity straight-bladed VAWTs for power enhancement. 10th International Conference on Applied Energy (ICAE2018) *Energy Procedia* 158 (2019) 382-387. DOI:10.1016/j.egypro.2019.01.119.
7. Zhao Z., Wang R., Shen W. et al. Variable pitch approach for performance improving of straight-bladed VAWT at rated tip speed ratio. *Applied Sciences* 8 (2018) 957, DOI:10.3390/app8060957.
8. Zhang T. T., Elsakka M., Huang W. et al. Winglet design for vertical axis wind turbines based on a design of experiment and CFD approach. *Energy Conversion and Management* 195 (2019) 712-726. DOI: 10.1016/j.enconman.2019.05.055/
9. Xu W., Li G., Wang F. et al. High-resolution numerical investigation into the effects of winglet on the aerodynamic performance for a three-dimensional vertical axis wind turbine. *Energy Conversion and Management*, 205 (2020) 112333. DOI: 10.1016/j.enconman.2019.112333.
10. Scheurich, F., Fletcher, T. M., Brown, R. The Influence of blade curvature and helical blade twist on the performance of a Vertical-Axis Wind Turbine. 48th AIAA Aerospace Sciences Meeting including the New Horizons Forum and Aerospace Exposition (2010). DOI: 10.2514/6.2010-1579.
11. McIntosh S. C., Babinsky H., Bertenyi T. Aerodynamic modeling of swept bladed Vertical Axis Wind Turbines. 47th AIAA Aerospace Sciences Meeting including The New Horizons Forum and Aerospace Exposition, (2009). DOI: 10.2514/6.2009-840.
12. Chen J., Yang H., Yang M., Xu H. The effect of the opening ratio and location on the performance of a novel vertical axis Darrieus turbine. *Energy* 89 (2015) 819-134. DOI:10.1016/j.energy.2015.05.136.
13. Zamani M., Nazari S., Moshizi S. A., Maghrebi M. J. Three-dimensional simulation of J-shaped Darrieus vertical axis wind turbine. *Energy* 116 (2016) 1243-1255. DOI: 10.1016/j.energy.2016.10.031.
14. Siddiqui A., Memon A. H., Alam M. et al. Performance evaluation of H-type Darrieus VAWT with J-shaped blade geometry at variable pitch angles. AIP Conference Proceedings 2119, 020010 (2019). DOI.org/10.1063/1.5115369.
15. Mohamed MH. Criticism study of J-Shaped Darrieus wind turbine: Performance evaluation and noise generation assessment. *Energy* 177 (2019) 367-385. DOI.org/10.1016/j.ENERGY.2019.04.102.
16. Rabei I., Gutu M. Analysis of the influence of the aspect ratio on the vertical axis wind rotor performance. IOP Conf. Series: Materials Science and Engineering 564 (2019) 012076. DOI:10.1088/1757-899X/564/1/012076.
17. Scheurich F., Brown R. E. Vertical-axis wind turbines in oblique flow: sensitivity to rotor geometry. [Disponibil]
https://pure.strath.ac.uk/ws/portalfiles/portal/3936077/Brown_RE_Pure_Vertical_axis_wind_turbines_in_oblique_flow_sensitivity_to_rotor_geometry_31_Mar_2011.pdf [Accessat 04.04.2020]
18. Cotfas PA., Cotfas DT. Design and implementation of RElab system to study the solar and wind energy. *Measurement*, 93 (2016) 94–101. DOI:10.1016/j.measurement.2016.06.060.