



**AGRICULTURAL, ENVIRONMENTAL & NATURAL SCIENCES**

**SOCIAL, PEDAGOGY SCIENCES & HUMANITIES**

**MEDICINE, VETERINARY MEDICINE, PHARMACY AND BIOLOGY SCIENCES**

**TECHNICAL AND APPLIED SCIENCES**

**REGIONAL DEVELOPMENT AND INFRASTRUCTURE**

**ECONOMIC, MANAGEMENT & MARKETING SCIENCES**

**LEGAL, LEGISLATION AND POLITICAL SCIENCES**



"An investment in knowledge always pays the best interest." Benjamin Franklin

ISSN: 1987-6521; E-ISSN:2346-7541, DOI:10.36962/GBSSJAR  
NOVEMBER-DECEMBER 2019 VOLUME 50 ISSUE 07

GULUSTAN

© SOUTHERN CAUCASUS SCIENTIFIC JOURNALS

# BLACK SEA

SCIENTIFIC JOURNAL OF ACADEMIC RESEARCH

MULTIDISCIPLINARY JOURNAL  
REFEREED & REVIEWED JOURNAL

Index Copernicus Value (ICV) for 2018 – 76.92

IPI Value: 2.42

IARC Impact Factor 2017 – 2.110

Catalogue of Russian Journals Impact Factor (2016) – 0.171

Impact factor РИНЦ 2017-0.041

## JOURNAL INDEXING



RESEARCHERID



zotero



MyScienceWork



**Editors-in-chief:**

**Lia Matchavariani**

Full Professor, Faculty of Exact & Natural Sciences, Dep. of Geography (Tbilisi State University)

**Chiefs by parts:**

**Historical and Natural Sciences**

**Lienara Adzhyieva**

**Tubukhanum Gasimzadeh**

**Social, Pedagogy Sciences & Humanities**

**Eka Avaliani**

**Medicine, Veterinary Medicine, Pharmacy and Biology Sciences**

**Mariam Kharaisvili**

**Technical, Engineering & Applied Sciences**

**Nikolay Kurguzov**

**Regional Development and Infrastructure**

**Lia Eliava**

Kutaisi University. Full Professor. PhD in Business Administration.

**Economic, Management & Marketing Sciences**

**Varadaraj Aravamudhan**

Measi Institute of Management. Associate Professor. PhD in Management.

**Badri Gechbaia**

Batumi Shota Rustaveli State University. Professor. PhD in Economics

**Translation**

**Elmira Valiyeva**

EDITORIAL BOARD LIST SEE PAGE 69

ISSN: 1987-6521; E-ISSN: 2346 – 7541; UDC: 551.46 (051.4) / B-64

©**Publisher:** LTD International Research, Education & Training Center. (UK, London),

**Director and shareholder:** Alexandra Cuco. Lawyer. Portugal.

**Deputy and shareholder:** Namig Isazade. PhD in Business Administration.

**Direktorun müavini və Payçı:** Namig Isazade. PhD in Business Administration.

©**Editorial office:** 71-75 Shelton Street, Covent Garden, London, WC2H 9JQ, UK.

©**Typography:** LTD International Research, Education & Training Center. (UK, London).

**Registered address:** 71-75 Shelton Street, Covent Garden, London, WC2H 9JQ, UK.

**Telephones:** +994 55 241 70 12; +994 51 864 88 94

**Website:** <http://sc-media.org/>

**E-mail:** gulustanbssjar@gmail.com, sc.mediagroup2017@gmail.com

©**Publisher:** NGO International Research, Education & Training Center.

**Deputy and founder of organization:** Seyfulla Isayev. Azerbaijan Marine Academy.

©**Editorial office:** Narva mnt 5, 10117 Tallinn, Estonia.

©**Typography:** NGO International Research, Education & Training Center. BS Journals.

**Registered address:** Narva mnt 5, 10117 Tallinn, Estonia.

**Telephones:** +994 55 241 70 12; +994518648894; +994 55 241 70 09

**Website:** <http://sc-media.org/>

**E-mail:** gulustanbssjar@gmail.com, sc.mediagroup2017@gmail.com, caucasusblacksea@gmail.com

## TABLE OF CONTENTS

<b>Konul Tagiyeva</b>	
DEVELOPMENT OF SECOND LANGUAGE PERSONALITY OF UNIVERSITY STUDENTS AND FORMATION OF COMPETENCE IN FOREIGN LANGUAGE LEARNING STRATEGIES .....	04
<b>Rzayeva Parvana</b>	
THE PEDAGOGICAL IMPORTANCE OF THE JOURNAL “THE EASTERN WOMAN” .....	08
<b>Gunay Shukurova</b>	
NEW AZERBAIJANI PARTY IS THE GREAT POLITICAL SUPPORT OF THE SOUTH CAUCASUS .....	14
<b>Firuzə Hübətova</b>	
THE ROLE OF SOLO TAXONOMY IN ENHANCING COGNITIVE ACTIVITY OF STUDENTS .....	19
<b>Emil Asgarov</b>	
INITIAL RESEARCH OF THERMO-RESISTANT MULTICOMPONENT COMPOSITE MATERIAL .....	26
<b>Paniushkina Marina, Yakovleva Ekaterina</b>	
INTERACTION IN THE FORMATION OF THE UNDERGRADUATE’S ASSESSMENT COMPETENCE .....	30
<b>Salahaddin Yusifov, Allahverdi Hasanov, Rza Safarov</b>	
MATHEMATICAL MODELING OF GASLIFT PROCESSES CONTROL SYSTEMS .....	32
<b>Elmira Veliyeva</b>	
TECHNOLOGIES THAT SAVE AND GROW .....	40
<b>Pashayeva Gunel</b>	
TERMINOLOGICAL VOCABULARY IN THE MODERN AZERBAIJANI LANGUAGE .....	43
<b>Aytakin Hasanova, Gulara Hasanguliyeva, Beyaz Babayeva</b>	
STRUCTURAL VARIATIONS OF CHROMOSOME 9 .....	47
<b>Muhammet İkbal, Aliew, Fuad</b>	
TELEMETRY APPROACH BY CANSAT DESIGN .....	54
<b>Guliko Kiliptari, Merab Sutidze</b>	
ONE COMPLICATED CASE OF THROMBOTIC MICROANGIOPATHY .....	60

## DEVELOPMENT OF SECOND LANGUAGE PERSONALITY OF UNIVERSITY STUDENTS AND FORMATION OF COMPETENCE IN FOREIGN LANGUAGE LEARNING STRATEGIES.

Konul Tagiyeva

Senior Teacher. Azerbaijan State Agrarian University

E-mail: tagiyeva.konul87@gmail.com

### ABSTRACT

The article provides an overview of forming competence in personal foreign language learning strategies as a process which evaluates development of the second language personality in autonomous foreign language learning. The author considers providing proof for formation of language learning strategies' competence to be a factor of a successful development of Azerbaijan university students' second language personality as an objective of the research.

The author formulated the following goals to gain the purpose: 1) analyzing studies on language learning strategies, defining principal trends of foreign language learning strategies' formation; 2) developing a design of forming students' competence, and a plan of its implementation under the conditions of university; 3) drawing a conclusion about the results of the research.

Methodology of anthropological and personality approaches is used in the research. Qualitative analytical, projective generalized, interpretative research techniques including monitoring, observation, questionnaire designs, testing, conversations, training, mathematical statistics techniques are used for problem solving. The author presents research focusing on students' foreign language learning strategies used in different language contexts.

Having analyzed the latest research developments and empirical results of the study the author comes to the conclusion that in order to gain the competence students should (1) be well informed about functioning of the second language personality and foreign language learning strategies; (2) take part in strategic training including teachers' consulting and the complex of tasks on the language learning strategies formation according to students' preferences; (3) have experience of strategies' choice and reflect on their speech strategies; (4) forecast their second language personality development defining prospects of using strategies on their own.

**Keywords:** Competence, foreign language learning, autonomous learning, second language personality, strategy.

### РЕЗЮМЕ

В статье исследуется развитие стратегий изучения иностранного языка студентов университета в самостоятельной работе как процесс, в центре которого вторичная языковая личность со своими особенностями и предпочтениями. Целью исследования является формирование компетенции в области личностных стратегий изучения иностранного языка и обоснование значимости данного процесса для формирования вторичной языковой личности в самостоятельной работе студентов. Для достижения цели автором были сформулированы задачи исследования: 1) провести анализ научных работ по вопросу личностных стратегий изучения иностранного языка; 2) выявить тенденции формирования стратегий, разработать технологию формирования компетентности студентов в области стратегий изучения иностранного языка; 3) сделать выводы по результатам исследования. На основе полученных результатов был сделан вывод о том, что овладение указанной компетентностью является фактором успешного формирования вторичной языковой личности студентов.

**Ключевые слова:** компетентность, изучение иностранного языка, стратегическое изучение, языковая личность студентов, стратегия.

Foreign language learning strategies became an object for study in the theory of foreign language teaching in the sixties of the last century. At the same time scientists' interest grew to such personal factors as cognitive style, social, gender identity, motivation. These concepts entered modern discourse of the theory of foreign language teaching. Learning strategies are rated among general vital strategies of a present-day person at the beginning of the 21st century. The presence of strategies as methods of personal realization in different spheres of the humans is an integral characteristic of self-determination of a personality, ability to plan out the future [Ivanchenko, 2005].

The sources of this knowledge can be found in the theory of radical constructivism, cognitive psychology, synergetics, and other scientific theories of the 20th century. The beginning of forming foreign language learning strategies falls on the school years; the development of the second language personality proceeds a whole life long, while the process of language learning lasts. Without conscious use of foreign language learning strategies, it is difficult to achieve academic

mobility as possibility to form a personal educational trajectory and educational style independently. The theory of development of personal strategies can be viewed as components of the theory of autonomous foreign language learning. The research objective presents a substantiation of the so called strategic competence which is interpreted as a factor of development of students' secondary language personality through forming foreign language learning strategies to facilitate learning efficiency. To achieve the aim, the following tasks were accomplished: 1) to conduct the analysis of studies concerning personal foreign language learning strategies, to define tendencies of forming strategies as a process with the second language personality in the spotlight as the one with its speech peculiarities, individual language experience, motives; 2) to work out a project of forming students' competence and a plan of its realization by means of university students' participation in the strategic training, use of the author's instruction manuals, executable codes for language disciplines at university, elements of e-learning; 3) to process the obtained data, draw conclusion on the research results. The data of the study will be valuable in the process of university education and autonomous foreign language learning.

In the middle of the last century the problem of mastering strategies as an important aspect of forming skills for autonomous learning came into notice of researchers such as: A.U. Chamot, L.Dickinson, H.Holec, J.M. O'Malley, R.L. Oxford, K.Percy, U.Rampillon, A.A. Leontyev, E.I. Passov, G.V. Rogova, V.V. Safonova, S.G. Ter-Minasova. Scientists were engaged in research of students' strategies to define how some of them can achieve success in varying degree while autonomous foreign language learning [Griffiths, 2008; O'Malley et al., 1985]. Different interpretations of the concept of "foreign language learning strategy" appeared at that period of time. Principal trends of foreign language learning strategies' formation In terms of the study the following interpretation should be recognized as an acceptable one: a foreign language learning strategy is based on the prediction plan of activities, defining the near-term outlook of development of students' secondary language personality. Personal strategies are considered to be ways, methods or technologies chosen by students according to peculiarities of their secondary language personality and language experience to progress in mastering a foreign language. The definition of the competence in personal foreign language learning strategies as "development linguistic and sociolinguistic competence in a person's own self" is closely related to the content of the research [Cohen, 2002, www; Faerch, Kasper, 2000, Wenden, Rubin, 1987]. The meaning of the adjective "personal" in research is correlated with the meaning of the noun "personality" in the word-combination "the secondary language personality". "The algorithm of foreign language learning activities, which has been set with the textbook or by the teacher, limits mastering foreign languages, but the procedural aspect of students' individual work remains unconscious at that" [Ovchinnikova, 2006, 103].

Forming secondary language personality as a factor of foreign language training is considered to have been in discourse for many years. The concept "language personality", introduced into scientific practice by V.V. Vinogradov, was developed in works by Yu.N. Karaulov. The latter distinguishes three levels in a structural model of the language personality: a verbal-semantic level, which unites separate words; a linguistic-cognitive level which unites notions or concepts developing in a worldview; a motivational level whose components are proved themselves through communicative and activity needs of the personality [Karaulov, 2011].

According to I.I. Khaleeva, the description of the model of the secondary language personality is carried out taking into account processes which happen while mastering foreign languages [Khaleeva, 2001, 8]. Understanding a foreign-language text means correlating it with their own knowledge and finding its place corresponding to its contents in a worldview, i. e. developing abilities to distinguish motives of a person belonging to foreign community.

Originalities of secondary language personality are reflected in students' personal strategies of foreign language learning which correspond to three levels of the model of the language personality [Cohen, 2002]. Limits of personal strategies are mobile; correction in the course of learning is possible. The set of factors, e. g., "a level of development of linguistic abilities, verbal activity, and psycho-typological characteristics of the person", influences on formation of language learning strategies' competence [Kabardov, Artsishevskaya, 1996, 39].

But the main circumstance, in our opinion, is students' awareness of their speech abilities and opportunities of their secondary language personality, willingness to use language learning strategies, cultivated independently by means of choice, borrowing or speech and cognitive experience. This difficult process of rational exploitation of language learning aptitudes is just students' conscious generating language learning strategies' competence.

Developing a design of forming competence in students' strategies. Groups of strategies are united in a table and are made according to levels of language proficiency, parts of speech activities in the research [Ovchinnikova, Uchimsya rabotat'..., 2013, 10; Ovchinnikova, We study English, 2013, 96]. The stage of comprehension of the concept "personal strategy of learning of foreign language" provides students' acquisition of knowledge about strategies explicitly presented to them by means of teachers' training, the author's instruction manuals, e-learning. The next stage of the formation of strategy is a stage of students' research and experimental work within, so to say, their secondary language personality. The stage supposes students' awareness of their psychological features, level of language proficiency, opportunities to autonomous foreign language learning. Students master methods of observation, questionnaire designs, training, experiments, statistics techniques and reflect the results in their portfolio. A strategy of studying a language is some sequence of skills for achievement of the purpose of studying a language. Independent strategies' formation assumes the ability to make a plan of action in the speech situation, to select necessary skills, to build their sequence and to modify the plan if it is required [Oxford, 1999].

The purpose of this stage consists in training students to form their language learning trajectory which they can build choosing strategies from the table, analyzing and correcting them with check experiments. Then students can choose technologies or techniques in accordance with their secondary language personality. For the sake of formation of future bachelors' foreign language learning strategies strategic training was put into practice through undergraduate course while studies in the lecture-room. Instructors advised a wide use of strategies, and tasks providing students' freedom of choice of strategies according to their preferences and experience exchange among students as well. The training was methodically provided with the author's instruction manuals "We study English" and "Learning English in a team", executable codes for foreign language disciplines at university, and elements of e-learning. Students filled in the table of strategies once a semester. Take, for example, the group "Strategies of listening and understanding foreign language speech":

- I use the strategy of search for familiar words, structures while listening. I "slip" through unknown words, avoid fixing on outside actions, noise;
- I isolate facts, I define logic of events, temporary relations, cause-effect relations (e. g., in dates, names, toponyms); I try to guess meaning of difficult structures; I keep in mind details of conversation while listening;
- I show speech activity (asking again, specification), I signal about my understanding/misunderstanding with mime and gestures; I take information from intonation, pauses, logical stress [Ovchinnikova, We study English, 2013, 100].

The purpose of strategic training is mastering tools for diagnostics, experimenting, transferring "successful" strategies to new learning contents. The task of the teacher was to inform students about the most effective strategies. The teacher used heuristic methods, problem situations while training. Students acted as teachers in micro-groups, analyzing the classmates' use of strategies. The students kept the diary (portfolio) for monitoring and reflection, fixing progress in development of language strategies for a certain period, introduced amendments in their trajectory of studies. There was also a section called "Failures" in the portfolio, including students' own reflection and the plan of mastering this or that strategy. One of the extenders of the range of strategies meeting students' expectation is organization of the process on the basis of the free software e-learning platform Moodle (Modular Object-Oriented Dynamic Learning Environment). The purpose of the system is forming friendly electronic environment of training enabling students' autonomous work, and the organization of interaction among students and teachers [Mikhailova, 2011, 52]. Moodle was used as a stimulating factor for comprehension and development of personal foreign language learning strategies. The table of strategies and questions for discussion were placed in sections of the course. The students' possibilities for consultation and discussion extended in Course Elements: LAMS, Wiki, forum, chat, feedback, and questionnaire.

The author studied also strategies of students of different gender types or gender determined strategies, i. e. caused by a gender factor. The gender factor was shown in preferences to certain types of speech activities, reflected in quantitative and qualitative characteristics of strategies [Griffiths, 2008]. The results have demonstrated that gender features of students of the masculine type are shown in the strategies directed to autonomy in foreign language learning, in preferences for e-learning (78%) [Ovchinnikova, 2006, 123].

## CONCLUSION

Formation of the strategical competence finds expression in qualitative and quantitative strategical development, reflecting changes in characteristics of students' secondary language personality. Students' qualitative strategical analysis was being carried out. New results were received. The so-called "beginners" among firstyear students (the basic level of mastering a foreign language) used more strategies connected with translating (8.5% vs. 6%), more strategies concerning imagination (10.4% vs. 7.4%), but fewer strategies concerning language guesswork or compensatory strategies than students of the average level of mastering a foreign language (2% vs. 4.5%). The beginners were ahead of the figures of strategies used by the advanced students, i. e. the quantitative aspect of beginners' strategies prevails over the qualitative aspect of their strategies by their number. Thus beginners used more laborconsuming strategies, avoiding more difficult but effective ones. The results of the research received on the basis of the final tests' data (2012–2013), questionnaire design, students' observation have showed that there is reason to believe that the formed competence in students' personal foreign language learning strategies facilitated their learning efficiency, promoting a successful development of Russian university students' second language personality. 75% of the students obtained the strategical competence sufficiently so that it can be recognized as a factor of a successful development of their second language personality. So the tasks of the study were accomplished, the objective of the research was gained.

## REFERENCES

1. Cohen A. (2002) Strategies in learning and using a second language. Available at: <http://catalogue.pearsoned.co.uk/educator/product/Strategies-in-Learningand-Using-a-Second-Language/9781408253991> [Accessed 20/02/12].
2. Faerch C., Kasper G. (2000) Strategies in interlanguage communication. Available at: <http://www.academia.edu/1753975> [Accessed 01/10/12].

3. Griffiths C. (2008) Strategies and good language learners. In: Lessons from good language learners. Cambridge: Cambridge University Press, pp. 83-98.
4. Ivanchenko G.V. (2005) Strategii professional'nogo samoopredeleniya i reprezentatsii professionalizma [Strategies of professional self-determination and representation of professionalism]. Psikhologiya. Zhurnal Vysshei shkoly ekonomiki [Psychology. Journal of the Higher School of Economics], 2 (2), pp. 24-51.
5. Kabardov M.K., Artsishevskaya E.V. (1996) Tipy yazykovykh i kommunikativnykh sposobnostei i kompetentsii [Types of linguistic abilities and competences]. Voprosy psikhologii [Issues of psychology], 1, pp. 34-49.
6. Karaulov Yu.N. (2011) Russkii yazyk i yazykovaya lichnost' [The Russian language and language personality]. Available at: [http://www.rusnauka.com/10\\_NPE\\_2010/Philologia/62891.doc.htm](http://www.rusnauka.com/10_NPE_2010/Philologia/62891.doc.htm) [Accessed 01/11/2011].
8. Khaleeva I.I. (2001) Gender v teorii i praktike obucheniya mezh"yazykovoii kommunikatsii [Gender in the theory and practice of teaching interlingual communication]. In: Gender: yazyk, kul'tura, kommunikatsiya [Gender: language, culture, communication]. Moscow: Moscow State Linguistic University, pp. 7-11.
9. Mikhailova N.V. (2011) K voprosu ob interaktivnosti asinkhronnogo vzaimodeistviya sub"ekta uchebnoi deyatel'nosti v elektronnoi obuchayushchei srede (na primere srede Moodle) [On interactivity of asynchronous interaction of a participant in the educational process in an e-learning environment (as exemplified by Moodle)]. Informatika i obrazovanie [Informatics and education], 10 (228), pp. 48-54.
10. O'Malley J.M. et al. (1985) Learning strategies used by beginning and intermediate ESL students. Language learning, 35 (1), pp. 21-46.
11. Ovchinnikova T.E. (2006) Gendernyi podkhod v sovremennom obrazovatel'nom protsesse universiteta [A gender approach in the modern educational process at university]. Orenburg: Orenburg State University.
12. Ovchinnikova T.E. (2013) Uchimsya rabotat' v komande na angliiskom [Learning English in a team]. Orenburg: Orenburg State University.
13. Ovchinnikova T.E. (2013) We study English. Orenburg: Orenburg State University.
14. Oxford R. (1999) Language learning styles and strategies: an overview. Available at: <http://hyxy.nankai.edu.cn/jingpinke/buchongyuedu/learning%20strategies%20by%20Oxford.pdf> [Accessed 15/10/12].



## THE PEDAGOGICAL IMPORTANCE OF THE JOURNAL “THE EASTERN WOMAN”

Rzayeva Parvana

Senior teacher in the Chair of pedagogical and public studies in Guba branch of ASPU. PhD student. Azerbaijan State Pedagogical University.

Email: baku\_2007@mail.ru

### ABSTRACT

In 1923, with the aim of furthering the promotion of political, social and cultural-educational work among women in Azerbaijan, the monthly, literary-art, socio-political journal “The East Woman” has begun to be published.

“The East Woman” journal had to struggle on the most difficult and hardest issues in its early days, it is possible to concentrate this fight mainly around three tasks. The first of these is to save working Turkish women from Sharia, religion and superstition, old traditions, to get them out of the narrow family life and to fight decisively with all appearing forces for the sake of the ability to assimilate their true freedoms; secondly, propagate and encourage them to attract Azerbaijani women captured for centuries under the charism regime, deprived of their rights and freedoms, to new public living quarters, factories and plants, cultural and educational front, the work of council structure; the third was to struggle to create the necessary conditions for women to work properly on the new front. “The East Woman” journal commented on the history, the origin and the content of the work of Maternity and Child Protection in Azerbaijan providing articles of various content relating to the protection of mothers and infants from the first issue. In some articles an advice was given to mothers, an information on maternal and child health was conveyed and fight measures were shown. It was spoken about how to cherish, to feed, to educate children and other issues in the period from birth to the age of kindergarten. In other group articles news about work, measures done in connection with the above mentioned issues was reflected. Thus, research shows that “The East Woman” journal provides extensive information on the creation of maternity and child protection and its responsibilities in Azerbaijan. The journal has conducted great pedagogical propaganda by publishing information, news, materials giving scientific knowledge about nurseries, kindergartens, child care offices, maternity hospitals, children’s hospitals, etc. in its pages.

**Keywords:** journal, issue, child, upbringing, article, author, information.

### INTRODUCTION

As “The East Woman” journal shows, at that time one of the main objectives of protection work of mothers and children was to prevent diseases and deaths among children. Therefore, the journal widely promoted medical knowledge in this sphere and showed the causes of diseases, ways to eliminate them. Although nearly a century has passed since then, articles in this journal that have an educational impact are still relevant today.

In 1923, in Azerbaijan the literary - artistic, social – political, first female journal “East Woman” had been published.

### Importance and action of the journal

The journal sets forward the purpose of involving women in the construction of new life from its first issue. It’s noted in the first issue of the journal in the main article named “Our Purpose”: “From today we start publishing a journal called “The East Woman” in the center of Golden Azerbaijan, that is the gateway of the Eastern world. It is the first time in the history of Eastern women, the woman produces journal by herself being in the head of it and with her own eyes she weeps for her own pain and begins to defend her rights. [3, p.3]

“The East Woman” journal had to struggle on the most difficult and hardest issues in its early days, it is possible to concentrate this fight mainly around three tasks. The first of these is to save working Turkish women from Sharia, religion and superstition, old traditions, to get them out of the narrow family life and to fight decisively with all appearing forces for the sake of the ability to assimilate their true freedoms; secondly, propagate and encourage them to attract Azerbaijani women captured for centuries under the charism regime, deprived of their rights and freedoms, to new public living quarters, factories and plants, cultural and educational front, the work of council structure; the third was to struggle to create the necessary conditions for women to work properly on the new front.

“The East Woman” journal had assumed the leadership position in the struggle to move to a new life and more focusing on mother and child protection and pre-school education on its pages had involved public opinion to this issue and had also awoken initiatives for the establishment and expansion of public housing facilities considered a real tool to save Azerbaijani women from slavery at home.

While turning over the copies of the journal published since 23rd, we have seen the success, progress and development of Azerbaijani women. These pages are full of the history of the struggle for the liberation of Azerbaijani women from their

former forms of living to the transition to socialist living. At the same time, we should note that the history of the throwing of Azerbaijani women to the press and writing is connected to the history of the journal "East Woman".

"The East Woman" journal has published a variety of inscriptions on the protection of maternity and infants from its first issue. These inscriptions can be categorized to the following groups according to their content:

In the first group inscriptions – the history, origin and the nature of maternity and child protection in Azerbaijan is commented.

In the second group inscriptions-an advice was given to mothers, an information on maternal and child health was conveyed and fight measures were shown.

In the third group inscriptions- it was spoken about how to cherish, to feed, to educate children and other issues in the period from birth to the age of kindergarten under the heading "Family education".

In the fourth group inscriptions- news about work, measures done in connection with the above mentioned issues was reflected.

The journal had kept focus these important issues since its inception and had published a wide range of articles about it. Considering important the height of femininity honor and the duties of maternity debt the journal wrote: "Because a woman is a mother of humanity, her being healthy means being healthy of next new generation ...Maternity is so important in its own right that to protect her is the history and social duty of every physician and every citizen" [7, p.32].

That is why the journal had become an organizer of maternity and children protection in Azerbaijan.

"The East Woman" journal had widely promoted the creation of maternity and children protection in Azerbaijan, had commented the work was of great importance and its goals and objectives, almost in its each number.

By researching the journal there is a broad imagination about the posing of the investigated problem, the organization of the work, its past history. It is clear from many materials that, in the 1920s the work of maternity and children protection didn't set at an appropriate level, not only in Russia, but in many cultural and advanced countries of the world and didn't cover a wide mass.

In one of the articles published by the journal, the author writes in the section "The protection of maternity and child" with the sign Dr. Wolfson : "Increasing of mortality among children creates the fear of crashing of the population. The reason of being broader of this situation was World War I. After the war, the illnesses had increased, and the profits of the laborers had worsened dramatically." [8, p. 37] According to the author, all these things have led mass deaths of children.

The author also notes that the countries had feared that there would be no young forces working in production in connection with the losses of child and had begun "to struggle with child losses and the diminishing of the birthdate ". This work had been first organized in France and other European countries, and then had moved to America. The author has investigated the work done in this area by countries on these continents and comes to this conclusion that this work in imperialist countries hadn't been considered a government rank neither at the time of writing, nor before, and only charitable societies had been engaged with this work in a small amount. The author rightly notes that "Only after the establishment of the Soviet power a new and brilliant process has begun in the work of the protection of maternity and children. Serious and societal principles have been laid in the base of this activity" [8, p. 37].

"The East woman" journal, talking about the great benefits of borned children protection, pointing its importance and state importance also offers valuable duties for "motherhood." The journal rightly writes that motherhood is the public duty of woman. A child should not be excluded woman from social activities. it is necessary to do so, let the newborn grow up healthy, sprightly, and let mother's family responsibilities to be lightened and her social activities in production to be enabled.

It's clear from articles published in the journal that in the 1920s, "the protection of maternity and children" as a matter of state had had two purposes.

1. By the way of healing maternity and children, to heal the large number of workers and villagers.
2. To be lightened the work of maternity, to bring up and nurture a healthy generation, liberation of women from cultural and societal slavery through assistance in their work.

What was to be done for all this?

- To open kindergartens, nursery.
- To organize consultancy offices.
- To train staff to work there.
- To provide women appropriate information on protection of maternal and child health.

The journal illuminates the course of the process of the work of maternity and child protection, with giving new materials every year, criticized the defects, was trying to mobilize related organizations, community.

"The science we call pedagogy is still in the form of a newborn child. We have to work hard, very hard for its evolution...We're not going to create a revolution in upbringing. It had been a revolution and had been over. Our task is to complete the revolution building. Those who are trying to complete it will be pleased if they even put a stone in the building" [4, p. 34].

"The East woman" journal that has just been published begins to produce issues from its second issue under the heading "Family upbringing" that important for its period, written purely on the psychological and pedagogical aspect. With first giving an article named " A child upbringing is a subject, too", the journal brought the importance of this work, its practical

role in life to the attention of readers–women. The author notes a child upbringing should not be looked "with a light and insignificant glance". Mothers should bring up "a child with naturally healthy and pure body, persevering to live a decent life and able to continue in accidents that can happen to a person" [2, p. 36]. Also a mother bringing up children must have knowledge and skills in this regard. She should know that what are "the reasons of the growth of the child's body and height, the growth of individual body parts, or the reasons that prevent it, the reasons provided baby's health" [4, p. 36]. The journal found it useful for mother to know not only how to bring up a child physically but also to know the ways of developing him(her) "in terms of both mind and idea". The mother "should know the child's mood and be aware of the science of pedagogy" to be able to answer the child's questions, to develop sensations, thoughts, feelings in a healthy way. While writing how much happiness new speaking child gives mother, the journal requires that every mother should know, child's mood, the science of pedagogy even if its little in order to achieve this goal more effectively. It raises an interesting issue that is of particular importance today in the article: Where, from whom, should the mother, especially the young mother whom we demanded be able to bring up a child physically, mentally, morally and aesthetically, learn it?

**The journal gives a very clear answer to this question.** It writes that family- parents should not forget that their daughters will be future mothers. They should prepare their daughters for this job in a specific area as needed. Then this work should be continued in school. "The school should prepare a sensitive and wise mother from this girl child... The future of humanity and humankind is only in the hands of women.

Thus, the journal had informed also Azerbaijani girls who will become mothers in the future, along with the women who became mothers, about the secrets of child upbringing.

The journal comments issues how to cherish and bring up children from the moment they were born, after the showing of importance of family upbringing as shown above. The journal answers the question "When does family upbringing begin?" so: "From the moment the child steps into the world." [2 p. 33]

The journal notes that the first job is to keep children born to the age of six, i.e school age and to give them appropriate upbringing. To bring children up to the age of 1-6 is not an easy task, the main part of upbringing is dealing with children of this age. Taking into account the upbringing of children of this age in the family it is noted: "The general upbringing of a nation who have no strong family upbringing is rotten and without foundation. Clean and strong family upbringing is the most important factor of the perfection of a nation and of general humanity. School can easily handle children who have the same general upbringing [4, p. 34].

In the article it is emphasized that the articles on the subject of family upbringing will continue in the form of a series. We do not think that the family upbringing issue will be solved radically with the written inscriptions. But if they work with the unity of the people in this area, if each of the authorities talk about these issues, undoubtedly, strong steps can be taken to correct family upbringing.

The journal divides the age of children as follows:

The 1st period - It is a time when the child was first born, it's been about a week.

The 2nd period – It's the time that a child suckles, it lasts for 8-12 months. (The separation of the first and second periods in this way is somewhat optional.)

The 3rd period- the period from the age of one to seven, that is, until the child goes to school.

The 4th period - from the age of seven, until the time when the mind was in the head.

This partition by the Turkish educator Khalil Fikrat in 1923 has no scientific basis and is inconsistent with today's age. But there was a great importance of considering periods and their ages in the development of children.

The journal provides extensive material about child upbringing by periods and it also criticized the remnants of unnecessary past upbringing as needed.

**The first period contains the first week.** Information on physiological changes occurring in his body is given just as a child's born. It is shown that as soon as a baby is born, there is a change in his (her) body. Because some of the members that have not been working so far, begins to operate in a new condition. For example, the lungs get started immediately, the blood circulation changes the shape of the movement, and so on. All this is necessary to know that, not make a mistake in fulfilling natural requirements.

It is noted that a newborn baby should be 50 cm tall and weight 3-4 kg. Most babies lose about 200 grams 3 to 4 days after birth. Lose weight returns within 7-10 days.

Then the journal talks about the issues of understanding a newborn children and how to treat with them. It teaches how to find out the reason of child's crying. It shows that a newborn baby should spend most of his (her) time asleep. If he (she) cries, it is necessary to investigate the reason for his (her) cry. The child may be crying because of nutritional deficiencies, his (her) wet place, cold and bad weather. If a child cries after meeting all his (her) needs, it means, he (she) has any disease. That time the doctor should call, and he (she) should be examined.

The journal writes that to raise a newborn child healthy it is necessary to bath him (her) with soap every day.

The article even explains mothers the rules of bathing children, being from simplest tasks. It is noted that to bath a healthy and strong child the water temperature should be 360 degrees. Babies born prematurely and with relatively weak bodies

need to bath with water at 36.50. These are children 48 cm and weight less than 2.5 kg. During washing, the baby's body must be rubbed with a clean cotton or sponge. The cotton used for washing the child's eyes should be separate and the eyes should be washed separately. After washing, the child should be carefully wiped with a soft towel.

The child should sleep after having a bath. The room the child sleeping should be well ventilated, there must be no dust or the smoke of cigarette absolutely in the room. The temperature of the room should be 200 for normal children and 22-250 for born prematurely or weak children.

Then it is taught the rules how to swaddle the child. The author notes that often children are so tightly pressed with their arms that no limbs of the child move, or even he (she) has difficulty when breathing. Such swaddling is very harmful to the growth of the baby's lungs. While the baby is swaddling the arms should be released and the lower part of the body should be compressed as little as possible.

#### **The journal warns moms about this, talking about some cases that may occur in newborn children.**

One of these is jaundice that can occur between the second day and the sixth day on children. It is noted in the journal that, this case passes by itself after 3-4 days its occurrence. If it doesn't recover, then the doctor should be informed.

Summarizing the first period, to prevent mistakes and errors damaging the child's health the journal recommends them the following:

- While swaddling the child should not be pressed hard.
- The place where the child lives should be dry, soft and clean.
- His (her) eyes should not be opposed to light and the sun.
- Dirty nipple or other harmful substances should not be given to child's mouth.
- Noises affecting his (her) ears should not be made.
- The baby should not be swinging.
- Better cleaning of bottles and nipples while buying artificial food.
- Paying attention to cleanliness when cutting the umbilicus.

"It is the conscience duty of every mother to pay attention to these points." [4 p. 36]

According to "The East Woman" journal, after the first week the baby's milk-sucking period begins, this period lasts till 8-12 months. Here Khalil Fikrat stands on the lunar growth of children, requires parents to pay attention to this issue. If the child's body grows visibly, they should be weighed at least twice or once a week, even if do not need to weigh them often.

Then the author provides information on the child's nutrition under the heading "How much should be a child's food daily"? "According to the experiments so far, it is 90 grams milk for the first twenty-four hours since the birth of a child, 20 grams milk at 48-72 hours, 300 grams milk on the fourth day, 390 grams milk on the fifth day, 470 grams milk on the seventh day, and 500 grams milk at the end of the second week. From the third week, in this way it is possible to determine the amount of milk the children can receive approximately." [5, p. 35]

The author notes that the child's food should be in 1/6 quantity of the body weight in the first three months of the year, in 7/1 quantity of the body weight in the second three months of the first year, in 8/1 quantity in the third three months, and in 9/1 quantity in the third three months.

To determine the amount of milk the baby has taken to his (her) stomach, it is necessary to first measure the baby before feeding, and then weigh him (her) after feeding, and the remaining amount between the two indicates shows the amount of milk the baby is fed. The author also notes that the written above figures are not conclusive. Because there can be sometimes 15 grams oil and sometimes 60 grams oil in a liter of mother's milk. For this, it is not right to try to give milk to the babies in quantity we have mentioned above. "If a child's weight is constantly increasing and he(she) sleeps after eating, then the amount of food may be neglected" [5, p. 36].

The author shows the benefits of breastfeeding and criticizes some healthy mothers not breastfeeding their baby.

Then the author provides information to mothers on giving children extra foods besides breast milk, rules of a suckling child's washing. The baby should be washed before feeding. It is better to bathe a child in the evenings. Because having a bath can soothe nerves and help the child to sleep peacefully. The author states that "it must protect better the child's senses, eyes and ears than this time" [5, p. 37]. The eye should always be protected from much brilliant light and should not move from dark to bright and clear place suddenly. Much brilliant things should not come close to the child's eyes. His (her) ear should be protected from strong and harsh sounds and his (her) nose keeps away from strong and harsh odors. The lines that explain the child's tooth extraction and related changes taking place thereby are also read with great interest. What should mother do this time that, the teeth come out in order and not the child suffer. "The newest measure to be done when baby's tooth comes out is washing the dental meat with cold water tightly... It is useless to cut off the dental meat for rapid out of teeth and reduction of the pain". [7, page 38]

The journal mainly requires greater implementation of the following in children's upbringing in this period:

- Physical upbringing.
- Spirit upbringing.

Food, sleep, movements and cleanliness is included to physical upbringing. The author informs about this one by one and shows its benefits.

Dr. Khalil Fikrat speaks about the role of sensory organs in the child to protect what he sees and hears in children and opens the psychology of how and when emotions occur in children. He shows the work of the mother accordingly.

In the journal the mother's knowing the future of this case in advance is brought to the attention as an important issue with being explained the changes and innovations that occur on the child during his(her) development. For example, when does a child begin to recognize things? According to Khalil Fikrat, the child begins to recognize his surroundings three months after his birth. The author, who skillfully explains the child's behavior during this period, writes: "Three months after the birth of a child, he or she makes practices of catching things. He (she) can't succeed first, then he (she) will catch the thing with the hand, pull it towards himself(herself) and finally tries to bring it to his (her) mouth and then he (she) catch the thing with his(her) hand and learns the shape of the thing and the distance from him(her)." [6, p. 17]

According to the author, from that time the child's ear imaginations begin to wake up. After that he (she) plays his (her) tongue in the form of "lalala" and begins to imitate the words. In the 5th and 6th months he (she) begins to speak in his (her) own language.

The author even explains to the mothers when the child starts laughing: "The baby starts to smile in the second month ... Crying with tears is before smiling. True crying begins in the third month really. He (she) begins to smile in the fifth and sixth months really." [6, p.18]

After giving extensive information about the milking period, the magazine talks about a new era named "childhood cycle" in the next issues. This period lasts from the end of the first age to the age of seven, that is, until the appearance of milk teeth. Therefore, this period is also called as the period of milk teeth. During this period, children are developing more rapidly than in other periods, in terms of "body, spirit, and mind". The author first gives here information about the children's height, weight accretion and heart rates.

According to Dr. Khalil Fikrat, the "childhood cycle" is divided into two parts:

- The first lasts from the end of the first year to the second, third and in some weak children the end of the fourth year. Free movements such as pulling, walking, and running are included in this first part of the childhood cycle." [8, p. 35]
- The second childhood cycle refers to four, five, six ages, and sometimes to seven ages in the weakest children.

The author notes that in the first childhood cycle, the body of children was extremely slim and fine at first times. They are exposed to external influences such as air and water and are often ill. As time goes by, the resistance forces of children to external and harmful influences increases and, as a result, the morbidity and mortality of children are also reduced in that proportion.

The author considers important paying attention to these issues in terms of "body upbringing" in the matter of food rightly. "The child should be used to eat at certain times. While eating a child should eat slowly and should not contaminate clothes. Even if a child sits at the same table as his (her) family, he (she) should not eat his (her) mother and father's food, he (she) should eat his (her) own food, and he (she) should not want anything else." [8, p. 36]

The author also states the importance of upbringing a child's lust an early age that not let the child say "I want" to everything. So that, a child should be accustomed not to be enthusiastic about everything, not to have every motivated thing, that is, to lead their lusts from an early age.

According to Khalil Fikrat's thought, this period is a time when good and bad habits are beginning to root strongly. Issues that seem insignificant to adults are always of a vital importance for a child. To deliver children to the responsibility of mentors having flawed upbringing is unforgivable defect and fault from the point of view of children's health and upbringing.

## CONCLUSION

Thus, research shows that "The East Woman" journal provides extensive information on the creation of maternity and child protection and its responsibilities in Azerbaijan. The journal has conducted great pedagogical propaganda by publishing information, news, materials giving scientific knowledge about nurseries, kindergartens, child care offices, maternity hospitals, children's hospitals, etc. in its pages.

As "The East Woman" journal shows, at that time one of the main objectives of protection work of mothers and children was to prevent diseases and deaths among children. Therefore, the journal widely promoted medical knowledge in this sphere and showed the causes of diseases, ways to eliminate them.

## REFERENCE

1. Askarzada G., Tavakkuloglu A. History of Azerbaijan's Journalism. Baku: 2015, 455 page.
2. Shahverdiyev A .. History of the Azerbaijani press. Baku: Education, 2006, 252 pages.
3. "The East Woman" journal, 1923, no.1
4. "The East Woman" journal, 1923, no.2
5. "The East Woman" journal, 1923, no.4
6. "The East Woman" journal, 1923, no.6

7. "The East Woman" journal, 1923, no.7
8. "The East Woman" journal, 1923, no.8
9. "The East Woman" journal, 1923, no.11

## NEW AZERBAIJANI PARTY IS THE GREAT POLITICAL SUPPORT OF THE SOUTH CAUCASUS

Gunay Shukurova

PhD in the Chair of Azerbaijan and Eastern Europe people history. Sumgayit State University (Azerbaijan)

E-mail: baku\_2007@mail.ru

### ABSTRACT

The article covers the role of the New Azerbaijan Party in the life of South Caucasus. NAP gives the great political support of the south Caucasus. Special place in the article is devoted to the works of the founder and organizer of New Azerbaijan Party (NAP), Heydar Aliyev. The research was conducted with the necessary sources, materials and literature.

**Ключевые слова:** Национальный лидер Гейдар Алиев, партия "Ени Азербайджан", Кавказ.

### INTRODUCTION

At the beginning of the last decade of the twentieth century- on October 8, 1991 the Supreme Soviet of the Azerbaijani Soviet Socialist Republic signed the Constitution act and Azerbaijan faced great tragedies after the country's independence was restored. In fact, the basis of these tragedies was still in the late 80's of the last century. The process of state building, which began after gaining independence, began to be accompanied by great problems and difficulties. Some of these were related to the occupation of Azerbaijan's territories as a result of Armenia's territorial claims to our country and the use of military aggression for this purpose. During the rule of the Soviet Union, Heydar Aliyev was the most prominent statesman against Armenian separatism. It is no coincidence that only a month after the removal of M.Gorbachev from the political power by Heyder Aliyev against the Azerbaijani people by the recommendation and support of the Armenian nationalist in 1987, the latter was given the process of demolition of the Nagorno-Karabakh region by the secret consent of Moscow. During this period Armenia's military aggression has become a serious problem for Azerbaijan's state independence. This problems were not solved, but rather deepened. Another problem that seriously hindered the building of an independent state was related to the incompetent and random people seizing power in Azerbaijan at that time. They didn't have any concrete ideas and programs on indifferent attitude to our national interests, those who didn't have statehood and governance skills, but those political forces who were thinking of their personal interests, the prospects of the independent state of Azerbaijan. Heydar Aliyev said about them later: these people didn't know what the leadership meant to the republic. And they weren't worthy of leadership. That's why they lost their confidence. Everybody should produce a conclusion from this bitter experience. [6]. Unfortunately, the then leaders of Azerbaijan were unable to cope with the new situation, and in many cases the center could not do anything except blindly executing the decisions of Azerbaijan.

As a result, the Sumgayit tragedy has been committed to exclude our people from the world community and to create an excuse for implementing outrageous plans against Azerbaijan, about 250,000 of our compatriots living in their historical lands were expelled from their homeland.

In the early 1990s, an antiseparator-mass protest movement started in front of the territorial claims of neighboring Armenia to the Nagorno-Karabakh territory, and then this movement was strengthened and transformed into a national liberation movement. The wave of rallies and strikes has risen in the country. The deployment of Soviet troops to Baku on 20 January 1990 was a culmination of the hostility policy towards our people.

Heydar Aliyev, who lived in Moscow at that time, did not hesitate to resist any pressure, and objected to the use of weapons against our people and declared our right voice to the world community. In a statement issued by the permanent representation of Azerbaijan in Moscow, he openly pointed out the nature and causes of the January 20 crime and the intentions of the forces involved in the tragedy. The Great Leader later recalled his return from Moscow: "They were following me in Moscow. Even after the January events, repression were prepared for my actions and they wanted to implement them. When I arrived in Baku, my visit was accepted with great enthusiasm, but if I was not allowed to live in Baku by the separatists, I came to Nakhchivan, Nakhchivan got up, Nakhchivan embraced me and embraced me. It seems that my arrival to Nakhchivan was a fate. "[5]. The forces of AXCP-Musavat, who dragged Azerbaijan into the abyss and managed it by the order of others, were ready for everything, only to open the game they wanted, and not to return to Azerbaijan and to lead the people of Azerbaijan. In those years historical events in Nakhchivan and Heydar Aliyev who is a wise person standing in front of these events, played an important role in the Azerbaijani people's self-determination. Heydar Aliyev was in Nakhchivan on July 22, 1990. Sovietization in the USSR began with the initiative and activity of Heydar Aliyev. Heydar Aliyev, who was elected chairman of the Supreme Assembly of the Nakhchivan Autonomous Republic on September 3, 1991, was elected to the Supreme Assembly of the Nakhchivan Autonomous

Republic on August 3, 1991, and was completely abolished by the Communist Party in Nakhchivan Autonomous Republic on August 26, 1991. The forces used all means to protect the USSR. For this purpose, a referendum was held on March 17, 1991. At that time, the Popular Front Party failed to block the referendum by simply dropping off the bill. With the efforts of Heydar Aliyev, Nakhchivan was not allowed to hold a referendum. Nakhchivan Supreme Assembly held its March 14, 1991 ruling, the Nakhchivan Republic remained outside the referendum. This was a major step toward the independence of Azerbaijan, as well as a serious blow to Gorbachev's reactionary policy. Unfortunately, the Azerbaijan Popular Front occupied the political power of the country, which suffered from the crisis. Ayaz Mutallibov, who came to power at the expense of the blood of martyrs on January 20, tried to protect his personality instead of preventing Armenia's aggression against Azerbaijan, ensuring the security of the Azerbaijanis living in Nagorno-Karabakh, launching the army, and other measures, among the leaders of the AXC he was heading to the political games he considered smart. Using the situation, Armenia expanded the scale of the occupation policy. Heydar Aliyev remembered that period: ... I thought that perhaps new people could serve more loyalty to Azerbaijan. It is true that I didn't see so many helpful people among them, but at the same time I supported them, I did.

.... On May 14, 1992 when Mutallibov returned to power again ... Headquarters of the Popular Front immediately appealed to me from Baku. I told them that Mutallibov's coming to power was illegal. I do not accept it, I object to it. I support the people's protest against him.

... They wrote my answer to the audio recorder and repeatedly delivered my statement to gathered in the garden named the 26 former Baku commissars.

... I think that this has helped some to mobilize people [9].

.... But what they should do is to appreciate it, to understand it. On the one hand, it could be that they don't appreciate it, they do not understand - it is personal. But they simply did not manage to manage Azerbaijan. " [2].

Ayaz Mutalibov's government and the AXC-Musavat couple were unable to establish an independent state, uplift their legitimacy, develop statehood, and even disseminated a few minority governance principles from the USSR [9].

The Khojaly tragedy, which was the greatest tragedy of the twentieth century and we suffered the pain at the time when the struggle between the ADR and A. Mutallibov took place. A terrible blow to the national dignity of our people. People who think and evaluate the future of our republic have been concentrated on the historical personality, Heydar Aliyev, who is ready to cross the country for the sake of the patriotic son of Azerbaijan, for save our country from these troubles.

The vast majority of the people were ready for any kind of rebellion for Heydar Aliyev to return to Azerbaijan again.

The only consolation of power and opposition was this amendment to the Constitution was a major obstacle to Heydar Aliyev's coming to power. The age-old synthesis of the Mutallibovs, who regarded themselves as far-sighted and skillful, was the same crafty purpose. On June 26, 1991, the National Assembly of the Republic of Azerbaijan put pressure on Article 1 of the Law of the Republic of Azerbaijan "On Presidential Elections of the Republic of Azerbaijan": "The President of the Republic of Azerbaijan can be elected as a citizen of the Republic of Azerbaijan who is below the age of 35 and not older than 65 years. Citizen has been living in the Republic of Azerbaijan for 5 years and the citizen shall have the right to participate in the presidential elections of the Republic of Azerbaijan under this law [1]. In order to eliminate these antidemocratic changes in April 1992, a group of spiritually-minded people held a 13-day rally in front of the Supreme Soviet of the Republic of Azerbaijan and demanded the removal of the 65-year-old senzes from the Constitution and the registration of Heydar Aliyev's candidacy in the presidential elections.

At the same time, intelligentsia, ordinary people had come to Nakhchivan AR and held meetings with Heydar Aliyev and sought to help from the people to get them out of trouble. Strangely enough, the people in the country were holding rallies in different parts of Azerbaijan, demanding Heydar Aliyev to be returned to the republican leadership. Finally, the great tragedy of the republic, which has historic conditions, led the people away from both the Communists and the front line to the real state of the nation and the nation, to face the historic person - Heydar Aliyev.

In the spring of 1992, an interview with Heydar Aliyev's "If People Call, I'll Come" was published in the Russian press. At that time, the true patriotic intellectuals of Azerbaijan saw the way of the call in the creation of a political party under the leadership of Heydar Aliyev, and with a firm determination, they began to work in a genuine sense. Many people went to Nakhchivan with the idea of creating a party next to Heydar Aliyev's party. Specifically, the proposal to establish the New Azerbaijan Party was first appealed to Heydar Aliyev on July 8, 1992, and five months later, on December 18 of that year, the New Azerbaijan Party was registered at the Ministry of Justice. Over the five months, many events have taken place. On August 25, 1992, in a four-page article under the title "we should call Heydar bey " in the "Ses" newspaper, the creation of the New Azerbaijan Party for the first time was made public.

On 16 October 1992, a new group of patriotic intellectuals was named "Azerbaijan is waiting for your way" to the Heydar Aliyev with the creation of the New Azerbaijan Party in "Ses" newspaper.

The appeal, reflecting the current state of Azerbaijan and the emergence of the dangerous situation in Heydar Aliyev, reflects his wise recommendations, but later appealed not only to the main principles and directions of the NAP but also to the source of a source of comfort to the Azerbaijani people and society. It was a call, and even in the future, who wanted to establish political, economic and cultural relations with independent Azerbaijan, also delighted our foreign neighbors. At the end of the appeal, Heydar Aliyev stated that the establishment of the New Azerbaijan Party was born of an objective necessity and declared his readiness to participate in the activities of such an organization. However, it was impossible to



hold the founding conference of the New Azerbaijan Party in Baku in that period. Therefore, the founding conference of the party was held on November 21, 1992 in the city of Nakhchivan.

More than 550 delegates from different regions of Azerbaijan participated in the meeting. The event was held in a frosty day at the Nakhchivan Drama Theater. In spite of the harsh conditions, the conference lasted for 4 hours and made important decisions there. At the conference, the Party's Program and Charter were adopted and Heydar Aliyev was elected chairman of the New Azerbaijan Party. Shortly after the establishment of the party, Heydar Aliyev said: "The New Azerbaijan Party is a necessity from the social and political processes in Azerbaijan. Many parties emerging in Azerbaijan are parties created by the initiative of individuals and political activists. However, the difference between the New Azerbaijan Party and the Party is that it is a party that has been created under conditions of great hardship, as a result of the movement of its own, without any organizational center, with the desire of those who wish to engage in political activities." [4, p.34-36].

A New Azerbaijan Party was established on November 21, 1992 in Nakhchivan's constituent assembly, fulfilling its historic mission on the establishment and progress of independent Azerbaijan. The renaming of the newly-established party to New Azerbaijan was the result of certain discussions. After the party's creators say that Heydar Aliyev had agreed to lead the new party, the intellectuals proposed different names. After some discussions, the name of the "New Azerbaijan Party", which was proposed by professional journalist Sirius Tabizli, was adopted. Later, Heydar Aliyev said about the party's name as NAP: "The party is called" New Azerbaijan Party ". It is natural and comes from the demands of time. Azerbaijan is a new independent state. In this sense, our party is new. It is the party of all. Our Charter and Program pursue the most democratic principles. " [7].

The conference made a decision on the establishment of the New Azerbaijan Party. NAP's Program and Charter projects were submitted to the conference's representatives and adopted after some amendments and additions. The goals of this party's program are to preserve state independence, to build a strong, civil, legal, democratic, secular state and civil society, to create a socially-oriented stable economy, and to implement legal and political reforms.

In the course of preparation for the founding conference, a group of intellectuals prepared a charter and program initial projects in Baku during a group of intelligent preparations. The colleagues who had experience in this work got acquainted with the layouts and prepared their proposals. First of all, these documents were very large. The challenges facing Azerbaijan's independence are the strengthening of state independence, the establishment of a stable and socially-oriented economy, the establishment of an independent, democratic, legal, secular state, the solution of the Nagorno-Karabakh problem in accordance with national interests, including legality, the main ideological principles of the party, such as civil solidarity, social justice, were not reflected in these documents properly. However, the process of the conference is a result of Heydar Aliyev's work, which is totally different from the Baku, the production of new, compact, full-scale projects. He had to re-write the party's charter and program on its own. When discussing the charter of the party, Heydar Aliyev was very attentive to the participants' opinions and accepted a part of them. Later on, Heydar Aliyev said about the development of the Party's Program and Charter: "Post-interrupted letters to Nakhchivan lead to such a situation that I agreed to the formation of the New Azerbaijan Party. Then preparatory work went on. I asked the current members of the New Azerbaijan Party, our colleagues and friends to come up with a program, a charter. Several projects were prepared and brought to them.

But now I have to say that I personally engaged myself directly with the writing and preparation of the New Azerbaijan Party Program and Charter. I still had to accept the necessity of such a party. But while I was satisfied with my participation in this party, I told her what I needed to build on her. Therefore, I was involved in writing both the program and the charter of the party. You are well acquainted with the Program and Charter, as you know that the Program and Charter are documents on establishing an independent, democratic, legal state in Azerbaijan [8]. The provisions outlined in the Adopted Program of the NAP determined the best way to save Azerbaijan from the crisis.

The program, which was adopted by the NAP congress, gave a clear and pragmatic assessment of the country's independence and the processes that took place in the country after that. "The New Azerbaijan Party is committed to strengthening the state independence, territorial integrity, the creation of a civil democratic legal state, solid peace and social solidarity is a parliamentary-type political party that promotes broad democratic reforms in order to create a stable and socially oriented economy, to ensure the comprehensive development and protection of human rights and freedoms, irrespective of race, nationality, religion and language. " (NAP Program -first edition)

One of the important provisions of the NAP program is the intensive integration of the country into the world community for the strengthening of Azerbaijan's state independence. As a result of the successful foreign policy course by the great leader Heydar Aliyev, this issue has fully found its solution and has become one of the cornerstones of the independence of cooperation in international organizations at an equal level. The foundation of a new era in the life of the party was laid in 1993 by the election of NAP Chairman Heydar Aliyev. The status of the party has changed according to new circumstances, transformed into a ruling party, strengthened its position in the country's political life, and turned into a mass political force and demonstrated high activity in achieving progress in all areas of social life. Heydar Aliyev said: "After coming to Baku, I was elected chairman of the Supreme Soviet, then president. Meanwhile, in separate parties, sometimes it was thought that Heydar Aliyev, as the head of state, would only support the New Azerbaijan Party, which will lead to the party, and the New Azerbaijan Party will be the ruling party. Such views were also within the New

Azerbaijan Party. However, you know that I have made a statement at press conferences once or twice that I have come to the Azerbaijani President, not through the activities of the New Azerbaijan Party, but by the will of the entire Azerbaijani people." [8].

With the return of Heydar Aliyev to power, the second phase of the NAP's development begins. At that time, the YAP faced the task of closely participating in independent state building processes on the one hand and on the other hand as a ruling party to maintain its leading position in the political system of society. Heydar Aliyev says: "When we created the party, we did not think that we would come to power shortly. Though the situation in our country - the situation you are all aware of, all of us was thinking about. The party's formation was connected with the wishes and aspirations of our people to the situation that our country was facing. But shortly afterwards, our party received the status of ruling party in connection with my being elected to the leadership of Azerbaijan, being elected president of the parliament and being elected president." [4, p.32-34]. The first trial phase was then followed by the government's subsequent follow-up, and the second stage was to prove that it was capable of supporting the party without state support.

Heydar Aliyev has once again witnessed the correctness of the political line defined by the New Azerbaijan Party, which has always appreciated the state management competence. After returning to the political power, Heydar Aliyev understood that the prominent statesman is interested in the New Azerbaijan Party's position in the political system of our country and wishes its organization to be shaped as a political power deserving it. Heydar Aliyev also posed a particular attitude to the principles of the NAP on the principles of the public administration system.

The period from 1995 to the I Congress (1999, December) is the next stage of the party's development. During this period, YAP faced the task of fundamentally ensuring the principles proclaimed by the ruling party as the development of political, economic, social and cultural spheres. This period, when democratic principles consolidated and free economic relations were formed, played an important role in the life of the party. Since the establishment of the New Azerbaijan Party, it has begun to demonstrate new type of opposition in both program documents and practice. Unlike other political forces, the party was not the sole purpose of being represented in power

The fact that the New Azerbaijan Party was formed as a strong political organization in late 1995, winning the majority of votes in the parliamentary elections and holding a leading position as a ruling party in the socio-political life of our country was a real reality. Effective use of Heydar Aliyev's political views and political philosophy made the party and the party win big victories.

The period from 1995 to the I congress of the NAP forms the third stage of the party's development. This stage is also chosen by its specificity. Here, the NAP has stopped the task of ensuring the fundamental realization of the principles proclaimed by the ruling party as a political, economic, social and cultural development. This period in which the democratic principles of Azerbaijan strengthened, the rapid integration of our country into the world community and the formation of free economic relations played an important role in the life of the party.

The first congress of the New Azerbaijan Party was held in Baku on December 20-21, 1999. Heydar Aliyev highly appreciated the activity of the New Azerbaijan Party in 1995-1999. He praised the activities of the party during the party's anniversary meeting and the NAP's preparations for the I Congress's first congress in September 1999, at the same time pointing out the shortcomings in this area and gave valuable recommendations on its future activities. These assessments and recommendations have been a major stimulus for the revival of the party's work. The first congress of the New Azerbaijan Party has become an important historical event in the life of the party. The party has already proved itself in the society as a political organization that has been formally organized and ideologically strengthened. At the congress, the new Program and Charter adopted its future directions. Since the establishment of the New Azerbaijan Party, it has begun to demonstrate new type of opposition in both program documents and practice. Unlike other political forces, the party was not the sole purpose of being represented in power.

Heydar Aliyev said at the party's first congress: "There is also a charter, which has not emerged as a party that fights for power. We wrote in the Charter of the Party that the party is created to participate in the social and political life of our country in this difficult period of Azerbaijan and to remove Azerbaijan from this difficult situation, this party is a parliamentary party. That is, we are going through democracy.

When creating the party, no one intended to overthrow the government, since once the opposition forces announce that they will overthrow the government or fight for power. Our party was created to combine healthy thinking, healthy thoughts and people and to participate in solving the country's problems in this complicated life of Azerbaijan, to provide its services" [6].

Speech of Heydar Aliyev at the party congress on the fateful issues of our people is, in essence, a valuable, programmatic character for all the socio-political forces operating in our country. From his speech it is clear that national strategic issues are not solved separately and they are closely interconnected.

Heydar Aliyev praised the historical significance of the establishment of the party at the I Congress of the New Azerbaijan Party, saying: "The New Azerbaijan Party is the most powerful political party with the highest intellectual level in the life of Azerbaijan. The New Azerbaijan Party is a party of Azerbaijan today, a party of Azerbaijan tomorrow, a party of XXI century, a party of the third millennium. The passing of the New Azerbaijan Party congress in such a meaningful, meaningful, organized and optimistic mood will raise the respect of the party in our society even higher and will raise more citizens of Azerbaijan around the New Azerbaijan Party" [3, p. 65-66].

## RESULT

The prominent statesman, national leader Heydar Aliyev is the founder and creator of the New Azerbaijan Party. The mighty statesman Heydar Aliyev headed the New Azerbaijan Party till the end of his life. The high organizational culture of the great leader, the extraordinary mobilization ability gave a strong impetus to the rapid development of the New Azerbaijan Party. Our party, almost all segments of society, unites all age groups. The New Azerbaijan Party is, in essence, a national party. I am convinced that in the coming years our party will also have a leadership capacity. Today, our party is the largest political force in the South Caucasus.

## LITERATURE

1. Constitution of the Republic of Azerbaijan Article 121, 1990, part 2
2. Heydar Aliyev's speech at the solemn meeting dedicated to the 5th anniversary of the establishment of the 4th YAP, November 29, 1997. New Azerbaijan newspaper, December 2, 1997
3. Heydar Aliyev. Independence is forever, Baku-2008, p.504
4. Mehdiyev R. Mafkura, statehood, independence (articles, speeches, interviews) .II volume, Baku, 2006, p.34-36
5. "New Azerbaijan Party: 15 Years on the Road to Rise" dedicated to the 15th anniversary of the establishment of 2 New Azerbaijan Party. Baku, 2007, p. 699, p.
6. Speech of Heydar Aliyev at the meeting of the Organizing Committee for preparation to the NAP I congress, September 4, 1999. "People's newspaper" September 5, 1999
7. Speech of the YAP Babak regional branch at the constituent congress. "East Gate" Newspaper, February 3, 1993
8. Speeches at the nationwide meeting on the occasion of the 1st YAP II anniversary. 19 November 1994. New Azerbaijan newspaper, 22 November 1994.
9. Speech of Heydar Aliyev at the first congress of the NAP.22 December 1999 Materials of the first congress of NAP. Stenographic report. Baku, 2000.

## THE ROLE OF SOLO TAXONOMY IN ENHANCING COGNITIVE ACTIVITY OF STUDENTS

Firuzə Hümbeətova

PhD student. Azerbaijan State Pedagogical University

E-mail: baku\_2007@mail.ru

### ABSTRACT

This article has been dedicated to the use of the SOLO (Observed Learning Structure) model created by Biggs and Collis to enhance student activity, the selection of resources, the use of conceptual comprehension, and to observe the development of students' cognitive activity in biology classes. For this purpose, pupils of 8th "b" and 8th "c" grades (only 56 students) of school № 170 in Sabunchu district of Baku were involved in the research. In the 8-b class, the biology teacher used learning goals, success criteria, and degree of complexity (using the SOLO taxonomy) while preparing each section and course. The tasks and learning goals that the teacher used to illustrate specific topics has been listed in the article. According to taxonomy, the questions and tasks used in the lesson were developed on four levels called "simple concepts", "systematic concepts", "integration" and "abstract thinking". The first two levels relate to deeper comprehension, and the next two levels to deeper learning. In the 8th grade, SOLO taxonomy was not used in teaching the same subjects at all. After the teaching of all the subjects covered by the experiment, the results of the diagnostic tests of pupils 8b and 8c and students' performance were compared. Achievement rates for Grade 8b students applying SOLO taxonomy are 39% higher than that of other students. The results obtained after the application of SOLO taxonomy during the experiment can be referred to the great progress in training based on Pofem training. As a result of systematic and accurate application of SOLO taxonomy it is possible to increase students' cognitive activity and to develop their conceptual comprehension.

**Keywords:** cognitive activity, learning goal, success criteria, biology

Why are children more active at an early age? Although not quite convincing, scientific research shows that a person gets approximately 70% of the information that he or she has acquired throughout his or her lifetime up to 6 years of age. The paradox is that after entering school, the child's cognitive activity begins to slow down to some extent. Why does this happen?

The point is that in preschool a child understands the world as a researcher: he (she) asks questions, uses various sources of information within his (her) capacity to find answers to these questions and primarily based on his (her) own experience. By independently realizing the world that surrounded him (her), the child acts in his (her) own interests.

When entering the first grade, the child falls into a learning environment where he or she is required to abandon his usual, natural learning method. The teacher insists that the child remember what he or she says, listening attentively to him (her). In this way, the student is almost offered to take a passive position, to give up the role of the researcher, and to be satisfied with the information provided by the teacher.

Taking into account that, biology is taught in the VI-XI grades in secondary schools and studying in these classes are students between the ages of 12-17. The phenomenological development that occurs during this period of student life puts educators face to face with specific problems. At this age, the impression is formed on the students and this also places an additional responsibility on the teachers. However, the main purpose of modern education programs is to develop students' cognitive, emotional, and psychomotor skills. In this regard, one of the topical problems of the teaching process of biology is to increase students' cognitive activity. It is very important to keep students from learning the subject mechanically, to attain increasing their cognitive activity in biology classes. In the biology curriculum, the content of the subject is expressed as in the form of standards. Activity in content standards is systematized with the help of taxonomies. These are cognitive, emotional, and psychomotor taxonomies that are important for education.

Standards reflecting cognitive activity are primarily aimed at developing intellectual skills and habits. In cognitive taxonomies related to the name of B. Blum, thinking skills are classified into stages from simple to complex. All stages of cognitive taxonomy are reflected in the standards for each class. In those stages, in each class, they are developed from grade-to-grade, from simple to complex, taking into account the age of each student (Scheme 1).

Scheme 1.

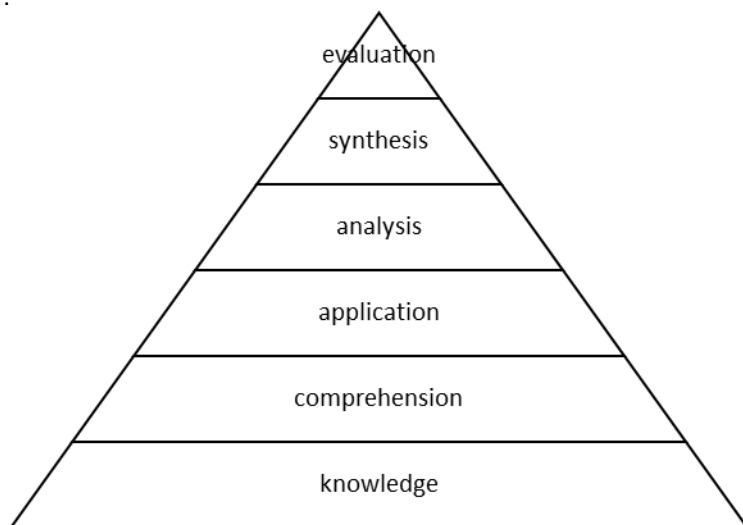

The purpose (or purposes) of each biology lesson should consist of the unity of surface, deep and conceptual comprehension. How to combine these levels of comprehension is determined by the teacher according to the position of the course in curriculum. The most effective model for comprehension these three levels and combining them with learning objectives and success criteria is the SOLO (Observational Learning Outcome Structure) model prepared by Biggs and Collis (1982).

In this model, there are four levels called "simple concepts", "systemic concepts", "integration" and "abstract thinking". These accordingly mean "ideas," "multiple ideas", "coordination of ideas" and "presentation of ideas in abstract form". The first two levels are related to surface learning (for example, picture 1).

Picture 1.

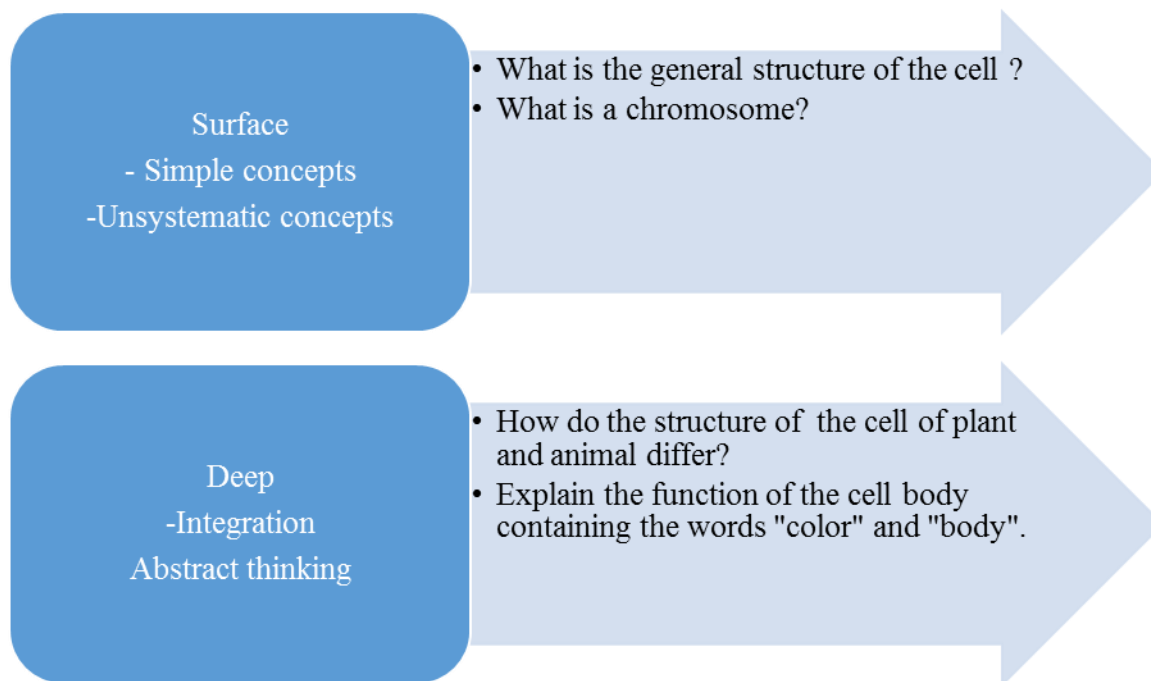

A surface and profound comprehension stimulates to the development of the student's cognitive activity.

Researches show that the tasks and the tests that teachers use in the classroom reveal surface knowledge. The tasks that checking students' deep knowledge or enhancing their cognitive activity aren't almost used. According to our research, indeed, the questions that most teachers ask in biology lessons are surface. The goal should be at least to balance surface and deep learning. Regardless of the purpose of the training, the half of the tasks used in the classroom should check surface knowledge and the other half part deep one.

Abdullayeva Shahla is a biology teacher in Sabunchu settlement, in Baku. She uses learning objectives, success criteria and degree of complexity (using the SOLO taxonomy) while preparing for each section and course in the 8b class. For example, let's take a look at the talk of the musculoskeletal apparatus. The teacher Shahla conducts a diagnostic test before starting the lesson - sometimes with a discussion in the classroom, sometimes with written tests and sometimes by asking three students with different abilities. Then, he works with the students using the sheets of learning objective described in Table 1. There is a perfect system right now, that allows the teacher Shahla to follow student's progress using different learning objectives from the point of view of the level of training they have during their training, as well as allow her (and her students') to know what the success is at different levels of difficulty. In addition, she adds resources, keywords, and other information to each sheet of training goal.

Table 1. An example for learning goals and success criteria classified according to the categories of complexity of SOLO

Training objectives		Success criteria
<b>SOLO 1: Know the chemical composition and types of bone</b>		
Simple concepts	To know the chemical composition of bone and its having got 4 types according to the structure	I know chemical composition of bone and its having got 4 types according to the structure
Integration	To solve the task belongs to the structure of bone, to know the location of bone types in human skeleton in which parts of the body	I can solve the task belongs to the structure of bone, I know the location of bone types in human skeleton in which parts of the body

Training objectives		Success criteria
<b>SOLO 2: To know human skeleton (Head's, trunk's and limb's)</b>		
Simple concepts	To know the names and numbers of bones in the head, trunk and limb	I know the names and numbers of bones in the head, trunk and limb
Integration	To differentiate bones in the head, trunk and limb, to understand with which bones they form a combination	I can differentiate bones in the head, trunk and limb, I can understand with which bones they form a combination

Training objectives		Success criteria
<b>SOLO 3: To know muscles, haustras and knuckles</b>		
Simple concepts	To know the types of muscles, the forms of bone fusion	I know the types of muscles, the forms of bone fusion
Integration	To know the location of the muscle types in which body organs, bone structures in the human skeleton	I know the location of the muscle types in which body organs, bone structures in the human skeleton

It is important to hold a diagnostic exam before teaching each unit. Because, a student's coming to the classroom with what knowledge each year is largely due to his success of past years: literate students achieve more, but students not selected with literacy less. However, the purpose of teacher's training should not be to achieve the increasing cognitive activity in literate students. It may be that the number of literate students in any class is small. But only after determining the initial level of knowledge of the students in this class (even if the activity of the student corresponds to the low level of cognitive taxonomy), the purpose and planning of the training can be determined. Our mission as a teacher is to break this tendency by finding ways for accelerating the progress of students who have started to fall behind in training. We must provide the perception of these students curriculum and learning objectives of the lesson more effectively as possible keeping up with literate students. Because of this, we need to know their learning trajectories, their learning strategies that use now and how ready the student is to train himself (herself).

Thus, the planning of any course must begin with a deep comprehension of what the student knows and is capable of, and how learning can achieve improving the progress and success of each student. The main issue is to provide increasing the effectiveness of all students and achieving the intended results of all students regardless of where the students begin. The experimenting 8b class students of the school number 170 of Sabunchu District, Baku, where the teacher Shahlia works and we are doing research to determine the influence of SOLO taxonomy on the development of cognitive activity of students, acquire simple and non-systematic concepts by participating in the lesson, and then coordinate the concepts and present it in an abstract form. Unlike Thinking Models (such as Piaje), students may begin training at any of these levels, but their ability to coordinate and present in abstract form depends on the students' comprehension of the concepts presenting these operations. Most of the time, have not been formed solid concepts in the students, they are given the task of coordinating and presenting these concepts in an abstract form. Many schools now call themselves "research-oriented schools", as if integration and abstraction can be realized without relying on the full comprehension of concepts. As noted, it is very difficult to establish interdisciplinary relationships and without adapting the questions asked to a rich database of concepts, simply learning "to do research" cannot be considered a good strategy. As given in the work "Visible Learning", teachers should know at what stage of the learning the student makes the most effort, transition of the students trying to learn more surface ideas, these ideas from surface comprehension to the deeper integration and its expression in abstract form should be provided. The main goal here is to work at the level at which the student is currently working, or one step above (+1).

We followed a few biology lessons of the students of the 8b and 8c class of school number 170. Then we performed a diagnostic test in both classes in teaching the theme named "Our internal fluid environment". As I mentioned before, we used the tasks checking both surface and deep comprehension. These tasks were prepared according to the program of biology subject curriculum and Blum taxonomy. The selection of tasks and sources of knowledge also depends on the purpose of the training. The task itself technologically consists of the mixture of any type of student activity, the word "key" that characterizes the category of cognition and the subject of cognition relates to the learned area.

The role of thinking and taxonomy in setting up tasks is as follows:

Knowledge = Recollection (Memory), Perception, Application, Analysis = Logical Thinking

Synthesis = Creative thinking, Assessment = Critical thinking

While the tasks are set up, the key verbs of thinking or Blum taxonomy are used taking into account the age and potential of the students:

Task = Type of Activity + Keyword + Cognitive Object + Presentation Form

Generally, tasks prepared with specific methodology for the implementation of the educational process in each class allow to determine the level of students. The tasks thought in various formats examines:

- the potential of students;
- how he interprets the theory;
- the adequacy of students
- the motivation of the students.

The result of the diagnostic test is shown in Table 2. As can be seen from the table the result of the diagnostic examination of the students of the experimental class applied SOLO taxonomy is higher.

Table 2.

The number of the task	The number of students in grade 8b responding correctly to the task	The number of students in grade 8b responding correctly to the task
1	13	6
2	9	3
3	8	1
4	5	3
5	11	5
6	14	6
7	7	3
8	9	2
9	16	11
10	21	13

In the generalized lesson related to the section “Blood Vessel System”, for determining the percentage of achievement of students in the 8b and 8c grades we did a mini-exam consists of both open and closed tasks. The results of this exam are given in Table 3:

Table 3

№	Student's achievement	Classes	
		8b	8c
1	Understanding the theory	93%	69%
2	Demonstration	87%	49%
3	Mastering Skills	88%	33%

It was also possible to test the compatibility of students' cognitive activity to which level of Blum's taxonomy through this exam too. Because there were tasks corresponding to all levels of taxonomy.

Table 4

№	The level of cognitive taxonomy that the task is appropriate	The quantity of students of 8b grade responding to the task correctly (%-l̄)	The quantity of students of 8c grade responding to the task correctly (%-l̄)
1	knowledge	95%	78%
2	knowledge	92%	80%
3	comprehension	89%	68%
4	comprehension	78%	54%
5	application	77%	51%
6	application	71%	49%
7	analysis	68%	46%
8	synthesis	65%	41%
9	synthesis	57%	45%



10	evaluation	49%	31%
----	------------	-----	-----

One of the most important things a teacher should know about each student is the student's thinking. The strongest theory about student's thinking is Piaje's one. As a result of this prestigious research, Piaje paved the way for great evolution in our thinking. Before increasing the student's cognitive activity, 'building up' knowledge and skills on him (her), the teacher should know the different ways of thinking of his students.

Piaje (1970) considers that children's thinking is formed in the following stages:

1. "Sensorimotor" stage;
2. "preoperative" stage;
3. "specific operations" stage ;
4. abstract operations stage.

Of course, this theory has been subjected to much criticism, has been the object of changes and improvements. According to critics, the weakest aspect of Piaje's theory of development is due to the existence of stable stages associated with specific ages: it is considered that students can be in several stages at the same time (Piaje also does not deny it), it is not legal for stages to be characteristic for this age (Piaje put forward these age periods as a general recommendation), and a serious sequence of stages is impossible. But Keys demonstrated that mastering the skills shown at the stages of cognitive development did not occur in the same tempo and form all areas of knowledge. He showed that the child's processing information and enhancing his active memory capacity may lead to a better overall comprehension.

The main point is that children may think differently than teachers. This means that we should pay attention not only to what children learn but also how they learn. Shayer (2003) has prepared a program "the acceleration of cognitive development" based on three main factors, on the basis of Piagen's theory: an intelligence makes progress in response to difficulties or inaccuracies, therefore, any interference should cause to a certain cognitive conflict; intelligence progresses as we learn to understand and control our cognitive processes; cognitive development is a social process that promotes high-quality dialogue among the younger with the support of teachers. The impact of the program was more than 0.60.

We conducted a small questionnaire with biology teachers at five schools in different schools in Baku. We asked the teachers two questions that we wanted them to answer : What knowledge and concepts are important to teach in teaching biology? What knowledge and concepts can lead to greater cognitive understanding and advancement?

The answers by 50 biology teachers were quite different: some said that all the information in the textbook was important to the student, and that it was important to teach them all. The other part thinks that simple knowledge should be given because of students' ability to succeed and cognitive functioning is different.

There are two types of biological concepts: simple and complex concepts. In biology textbooks prepared in accordance with the requirements of the curriculum both simple concepts (in the lower grades) and complex concepts (upper classes) relating to the same section or topic are given. It actually facilitates the work of teachers, it provides the opportunity to increase students' cognitive activity, to transition from superficial to deep comprehension. Simple concepts correspond to surface comprehension and complex concepts to deep one.

The starting point should be the curriculum when it comes what to teach and to determine the appropriate level of complexity and desirable goals. But, the curriculum has always been a matter of disagreements and debate. One of the differences between different curricula (local, state, national or international) is the succession of goals. That is, may be coming some goals before or after others. There is no evidence to suggest which sequence is better, even the availability or the absence of sequence in some areas is in doubt. But there is a sequence in the biology subject curriculum. But what is important is the gradual increase of the difficulty of the information being taught. The closely connecting of the concept of difficulty with selection of tasks, lessons and lesson results is of great importance. What we want to say is that the "curriculum" may be "the most important element" to choose the subject of instruction, but our taking into account the difficulties, the sense of commitment, the confidence and the conceptual comprehension is also of great importance, requires to have an unanimous opinion among schools. The goal at this time is to have higher expectations about the difficulty level of students.

Let's note that to have a shared vision about achievement will demand teachers when applying the curriculum to have a consensus between themselves and, better, between the schools about what concepts of difficulty and complexity are. At this time, the goal is to have higher expectations of students about the level of difficulty. Thus, when students move to another class and even to school, new teachers' perceptions of difficulty must adapt with previous teachers' perceptions of achievement.

Shayer (2003) offers two basic principles for teachers. First, teachers should look at the preparation of interventions causing to the increasing of the number of students having such thought for students to use higher-level thinking skills during regular classroom activities as their responsibilities, that is, teachers should focus primarily on how students think.

Secondly, training is a collaborative process and requires dialogue. This requires the teachers to pay attention to all aspects of the formation and expression of ideas through mediation among students.

We can conclude that we (teachers) should know the students' past knowledge, how they think, and then we must try the progress of all students towards the success criteria.

#### LITERATURE

1. Veysova Z. Active / Interactive training. Textbook for teachers. Baku, UNICEF, 2007, p.149.
2. Huseynov Ə.M., Maharramov Ə.M. Teaching methods of biology. Baku, ADPU 2003, p.138.
3. Ahmadbayli X., Seyidli Y., Aliyeva N. Biology 8. Textbook for the 8th grade of secondary schools. Baku edition, Baku-2017, p.160.
4. Ahmadbayli X., Seyidli Y., Aliyeva N. Biology 7. Textbook for the 7th grade of secondary schools. Baku edition, Baku-2017, p.160.
5. Con Hatti, Visible training for teachers. Turkey, Teas press, 2018

## INITIAL RESEARCH OF THERMO-RESISTANT MULTICOMPONENT COMPOSITE MATERIAL

Emil Asgarov

Master of Science. Maintenance Superintendent. Technical Integrity department. SOCAR-AQS LLC

Email: emil.asgarov57930@gmail.com

### ABSTRACT

The new approach is to create a multicomponent composite material on a basis of mineral component by defining extreme value of the multi-variable function. It is decided to carry out theoretical analyze first. For theoretical analysis, the effects of component quantity on the parameters (e.g. anti-corrosion and temperature resistance) to be determined by experiments and in all cases the results to be theorized. Thus, the mathematical formula for the relation temperature resistance with components has been determined. In order to evaluate thermos-resistance it is defined multi-variablefunctional relation and with this function it is achieved extreme values on optimum values of each component. Compare traditional thermo-resistant material new material approximately two times lighter than traditional ones. In order to increase the high temperature of this material, a multi-component spatial structure is formed.

On a basis of achieved theoretical results optimal quantity of each component is clarified, anti-corrosion and thermo-resistant materials are made and tested. For example, 5 components thermo-resistant material is tested up to 1500°C and not observed any sign of destruction. The novelty of the approach is to achieve high quality anti-corrosion and thermo-resistant material by defining an extreme value of the multi-variable function.

**Keywords:** thermo-resistant material, multi-variablefunctional relation, thermos-resistance

### INTRODUCTION

Implementation of high-performance materials is the important issues in the high development era of economics and technology.

Geopolimers can be used to create a composit material with a high temperature resistance. The best option is cement based that can resist up to 1600 degrees celcius. The fillers of these materials have a nature of aluminosilicate and high temperature resistant fibres as fillers. A stability of volume changes are required within a wide temperature range for heat-resistant composite materials. Research has shown that the selection of optimal geo cement mix composition side by side with the heat resistant filler is required to regulate the shrinkage/expansion process during heating (G. Kovalchuk, P.V. Krienko, 2009).

High-temperature resistance metals, also known as refractory metals, are much harder at room temperature and usually have a melting point above 2000°C. They are niobium, molybdenum, niobium alloys, tungsten and rhenium and its alloys. Niobium alloy named titanium-zirconium-molybdenum shows the extra ordinary strength and creep resistance in high temperatures. Tungsten however has poor heat resistance; however, it can be alloyed with Rhenium to improve it (Stanford Advanced Materials, 2014).

It is always developed and implemented simple and practical methods to protect common used steel constructions. Currently, in the technique is widely used two component composite materials. One of these components is adhesive, other is filler which commonly consist of synthetics fibers. The functions of these components are very different from one another, so these materials should be regarded as a primary variable composite. For this purpose, the creation and development of multi-component composite materials is of great importance.

### Experimental and theoretical analysis.

In order to create multi-component composite material, first of all it is necessary to create theoretical basis. In our opinion, the use of multivariate complex functions for this purpose is a correct way. It is known that ordinary functional dependency is used for a variable composite material. The extreme value of such a function is derived from the first derivative. In some cases, the proportion of components can be about 300-400 when creating multi-component composite material. Finding extremum quantities by modeling is very complicated. The extremum value in the multivariable function is determined by the help of special differensials. This allow any ratio of the component to be considered. In order to compensate for the extreme value of the desired parameter of the multivariable complex function, the second differential of the complex function, ie quadratic form, is assigned.

In order to define extreme value of the desired parameter of multivariable complex function it is defined the second differential of the complex function, i.e., it's quadratic form.

$PS = F(x, y, z \dots)$  It is defined second differential of PS function, PS- parameter to be searched

$$d^2(PS) = d^2F(x, y, z \dots) \\ = \frac{\partial^2 F(x, y, z \dots)}{\partial x^2} dx^2 + \frac{\partial^2 F(x, y, z \dots)}{\partial y^2} dy^2 + \frac{\partial^2 F(x, y, z \dots)}{\partial z^2} dz^2 + \dots + 2 \frac{\partial^2 F(x, y, z \dots)}{\partial x \partial y} dx dy \\ + 2 \frac{\partial^2 F(x, y, z \dots)}{\partial x \partial z} dx dz + 2 \frac{\partial^2 F(x, y, z \dots)}{\partial y \partial z} dy dz \dots$$

If  $d^2(PS) = d^2F(x, y, z \dots)$  does not change the sign of a certain limit, then there is an extremum

If  $d^2(PS) < 0$  maximum

If  $d^2(PS) > 0$  minimum

If  $d^2F(x, y, z \dots)$  change the sign, then there is no extremum. It means that the component does not have a positive effect on the quality of the multicomponent composite material. The most difficult issue is to determine the sign of  $F(x, y, z \dots)$ . For this purpose the matrix of  $d^2F(x, y, z \dots)$  to be determined.

$$A = \begin{pmatrix} \frac{\partial^2 F(x, y, z \dots)}{\partial x^2} & \frac{\partial^2 F(x, y, z \dots)}{\partial x \partial y} & \frac{\partial^2 F(x, y, z \dots)}{\partial x \partial z} \\ \frac{\partial^2 F(x, y, z \dots)}{\partial y \partial x} & \frac{\partial^2 F(x, y, z \dots)}{\partial y^2} & \frac{\partial^2 F(x, y, z \dots)}{\partial y \partial z} \\ \frac{\partial^2 F(x, y, z \dots)}{\partial z \partial x} & \frac{\partial^2 F(x, y, z \dots)}{\partial z \partial y} & \frac{\partial^2 F(x, y, z \dots)}{\partial z^2} \end{pmatrix}$$

As per *Sylvester's criterion* it is determined the sign of the matrix.

If the main **minor** of the **matrix are positive** then PS is positive,

$$A_1 = \frac{\partial^2 F(x, y, z \dots)}{\partial x^2} > 0 \\ A_2 = \begin{vmatrix} \frac{\partial^2 F(x, y, z \dots)}{\partial x^2} & \frac{\partial^2 F(x, y, z \dots)}{\partial x \partial y} & \dots & \dots \\ \frac{\partial^2 F(x, y, z \dots)}{\partial y \partial x} & \frac{\partial^2 F(x, y, z \dots)}{\partial y^2} & \dots & \dots \\ \frac{\partial^2 F(x, y, z \dots)}{\partial z \partial x} & \frac{\partial^2 F(x, y, z \dots)}{\partial z \partial y} & \dots & \dots \end{vmatrix} > 0 \\ A_3 = \begin{vmatrix} \frac{\partial^2 F(x, y, z \dots)}{\partial x^2} & \frac{\partial^2 F(x, y, z \dots)}{\partial x \partial y} & \frac{\partial^2 F(x, y, z \dots)}{\partial x \partial z} \\ \frac{\partial^2 F(x, y, z \dots)}{\partial y^2 \partial x^2} & \frac{\partial^2 F(x, y, z \dots)}{\partial y^2} & \frac{\partial^2 F(x, y, z \dots)}{\partial y^2 \partial z^2} \\ \frac{\partial^2 F(x, y, z \dots)}{\partial z \partial x} & \frac{\partial^2 F(x, y, z \dots)}{\partial z \partial y} & \frac{\partial^2 F(x, y, z \dots)}{\partial z^2} \end{vmatrix} > 0$$

If pair main minors are positive or single minors are negative, then the quadratic form of searched parameters are negative.

$$A_1 < 0, A_2 < 0, A_3 > 0$$

In our opinion, the use of multiple glues in creation of universal multi-component composite material produce very serious results. In this case, both organic and inorganic materials should be used.

In optimal values of multi - component composite materials it is needed to get the extreme outcome of their desired parameter.

Based on above stated principle it was created high-temperature multi-component composite materials. The testing of these materials has shown that through the components that have the same features, it is possible to obtain multi-component composite material with a higher performance. The effects of one component on the overall material in materials with close-up properties have been demonstrated in the study of durable thermal material. As shown on **Figure 1**, the decrease in the number of one component caused deformation even at 1500°C. **Figure 2** shows that at optimal value of components at 1500°C deformation not observed. In another sample, the change in one component caused destruction of composite material at 1500°C (**Figure 3**).

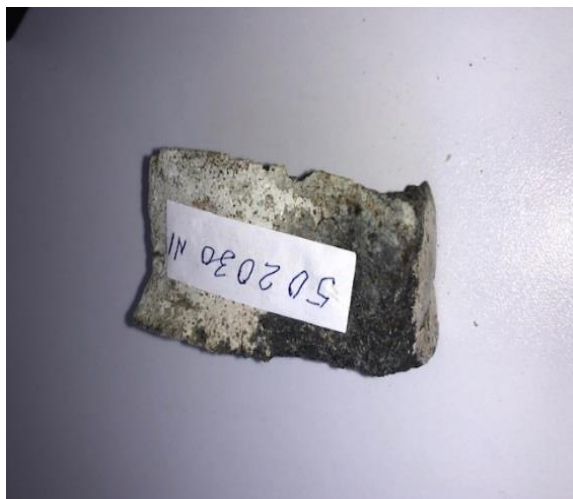

Figure 1.



Figure 2



Figure 3.

Apparently, it is possible to achieve high quality multicomponent composite material from close property components and it is proven by our theoretical and experimental analysis. Applying of multivariable function allows us in a very large temperature range 1500-3000°C to achieve thermo material. The materials have the following physical mechanical properties.

- The heat transfer coefficient can range from 0.2 to 1.5 Kcal / hr.m<sup>2</sup>
- Density 400-1400 kg/m<sup>3</sup>.
- Compressive strength 400/1000 kg/sm<sup>2</sup>.
- Relatively moderate strength, i.e., the ratio of strength to density is 1, in steel this ratio is 0.5.

Such materials are indispensable for the jet engines (rocket, plane and etc.).

Tests have been done in High Temperature Muffle-furnace model: ЧОЛ 12/16 , maximum temperature is 1650°C (Figure 4).



**Figure 4.**

Additionally, the synthetic resin used in the current composite materials loses physical mechanical properties depending on the time, it cause fatigue / aging occurs.

The material preparation technology we offer consists of two stages: dry mix and liquid mix. The ingredients included in the dry mix are mostly mineral. Since the liquid mix consists of a low-density synthetic resin, they are processed in special centrifuge to make it evenly distributed in the finished product. Dry and liquid join together at the preparation time. Their required drying time is controlled by specific components.

## CONCLUSIONS

It is created multi-component composite material by defining extremum of multivariable function.

As per the principle to define extremum of multivariable function it has been established that it is possible to create high-temperature resistant.

The analysis of theoretical and experimental results allows us to improve the theoretical model. Finding the extremum of this multi-variable function allows us to achieve multi-component material. However, the difference between the theoretical and experimental results relatively large (25-30%). This differences show us that the theoretical model needs to be improved.

## REFERENCES

1. G. Kovalchuk, P.V. Krienko, Geopolymers, 2009
2. V. Mittal, Handbook of Smart Coatings for Materials Protection, 2014
3. Michael J Schofield BSc, MSc, PhD, MIM, CEng, Plant Engineer's Reference Book (Second Edition), 2002
4. High Temperature resistance materials by Stanford Advanced Materials | Sep 16 2014.

## INTERACTION IN THE FORMATION OF THE UNDERGRADUATE'S ASSESSMENT COMPETENCE

<sup>1</sup>Paniushkina Marina, <sup>2</sup>Yakovleva Ekaterina

Immanuel Kant Baltic Federal University

Email: <sup>1</sup>MPaniushkina@kantiana.ru, <sup>2</sup>EYakovleva@kantiana.ru

### ABSTRACT

This article demonstrates some approaches to the solution of assessment competence formation problem for a master's student by means of participants' interaction in the university educational process. Description and content of educational interaction are considered. Interpretation of students' assessment competence is given. The article explains the term "assessment situation" in the context of pedagogical interaction in the systems: "teacher-student" and "student-student". Types of assessment situations with their characteristics are shown.

**Keywords:** interaction, assessment competence, bachelor's degree, formation of assessment competence, assessment situation, assessment knowledge, assessment skills, assessment competence of bachelor

### INTRODUCTION

At present, the problem of students' assessment competence formation is quite urgent taking into account current challenges in both higher education and assessment approaches. Today, such educational trends as digitalization, distance learning, and various tests require additional skills for all participants in the educational process. Classical education is being transformed into the digital world: the classical educational system is being transformed into a digital educational environment, active learning methods are becoming interactive ones, paper-based documents are replaced by electronic storage devices, and learning is converted into an educational engineering environment, etc. The current assessment system should be relevant and objective. Many teachers as well as students emphasize the lack of their assessment training, insufficient assessment literacy. Absence of an appropriate subject where students could obtain basic knowledge of correct assessment, including current trends in higher education, might be an explanation.

### MATERIALS AND METHODS

The issue of teaching students assessment skills is becoming the subject of various scientific studies (D. Primerov [2], A. Subbotko [4], etc.), where various approaches, models of assessment and qualimetric knowledge and skills for teachers at the different educational levels are presented.

Therefore, the popularity of pedagogical qualimetrica gives extra knowledge in the development of assessment skills. Students have to know how their results could be shaped. Qualimetrica makes the assessment process clearer and more understandable. Knowledge of all assessment procedures helps anticipate the risks and failures of all students and enhances their motivation to learn.

Thus, higher education students are to possess assessment competence including clear assessment criteria, comprehension of a modern challenging assessment system: the use of a huge number of digital platforms, learning portals (BRS, LMS, etc.) requires much more than just assessment skills. Therefore, "student assessment competence" refers to the holistic system of knowledge, skills, mental and personal qualities, which are required to assess learning achievements.

But how could teachers develop this competence? One of the most efficient ways of successful assessment training is interaction between participants in the educational process. Cooperation is a key prerequisite for assessment activities, since assessment requires feedback, sharing and enrichment of assessment experience. The concept of "interaction" is quite universal. It is the core of various sciences and is the major category of progress. It is presented as a concept for philosophical, psychological and pedagogical aspects. Scientists have invented a huge number of concepts and terms that characterize interaction issue at the terminological level. Interaction means a universal form for development and general modifications of phenomena both in nature and in human society, which enriches each element up to a new state [3]. This concept emphasizes the effective component of interaction being a part of a new professional growth. Educational interaction is represented in the following systems for undergraduate students: "lecturer - student", and "student - student" [1]. The content of interaction evolves with people who take part in this process. These systems reflect the process of training for objective assessment activities implementation.

Moreover, the situational approach is considered as a basis for interaction. It demonstrates a challenging concept which illustrates interaction in assessment activities and introduction of subjects for the educational process as active

participants in the assessment of students' achievements. It ensures the growth of students' mental activity. The concept of "assessment situation" corresponds to a special type of intellectual subjects interaction, which is a specific mental state of subjects in the process of problem solving related to the assessment of educational outcomes. The situational approach allows us to present the learning process as a transformation of various situations aimed at the development of a student's assessment independence, at obtaining the correct assessment experience. The relevant positive psychological climate is of great importance in such circumstances.

## RESULTS

Assessment situations could be hypothetically divided into two types:

1. *Virtual assessment situation*. Students acquire and use assessment knowledge in their classrooms, solve and analyze various assessment dilemmas and ambiguous situations by watching videos or discussing someone else's assessment activities. Students are expected to understand how they get their grades, and which criteria are important for the assessment. Oral assessment requires an assessment approach as well as skills explanation. A written assessment requires a specific criteria list. These criteria should be coordinated with all participants in the educational process. By watching training videos, students solve assessment dilemmas, share and discuss different opinions and make a final assessment decision. This type of interaction allows learning to be objective and ready for appropriate assessment activities and behavior.

2. *Real assessment situation*. A situation arises when students are to assess and rate someone else's knowledge or skills, and explain their assessment behavior. There are different ways to implement it. Firstly, students could make a criteria list for different tasks and exercises. Each assignment should have clear assessment criteria, and students are expected to know all of them. One method is to create a unified list with students. Secondly, they could put marks to their classmates, clarifying their point of view. In such a case, the teacher may organize some debates. Finally, students could explore some educational portals and platforms and prepare projects tailored to their assessment. Thus, the actualization of these situations enriches students' assessment skills and experience. The interaction between active participants in the educational process provides the necessary background: assessment knowledge and skills which students can apply in their studies and even in their future careers.

In conclusion, assessment competence is becoming one of the most essential tools for each student in the fast-changing higher education environment.

## REFERENCES

1. Paniushkina, M. The formation of future teacher's evaluative knowledge and skills: Methodic recommendations / M.Paniushkina; I.Kant Baltic Federal University. — Kazan: «Buk», 2017. — 40 p.
2. Primerov, D. The formation of the evaluative competency of pedagogical students: dissertation: 13.00.08. / Primerov Dmitry Alexandrovich – Chelyabinsk, 2012. – 193 p.
3. Rozhkov, M. Theory and methodology of education / M. Rozhkov, L.Bajborodova. – M.: Vlado, 2010. – 382 p.
4. Subbotko, A The formation of the future teacher's system of evaluative activity: dissertation: 13.00.08. / Subbotko Alexandr Nikolaevich. – Bryansk, 2006. – 170 p.



## MATHEMATICAL MODELING OF GASLIFT PROCESSES CONTROL SYSTEMS

<sup>1</sup>Salahaddin Yusifov, <sup>2</sup>Allahverdi Hasanov, <sup>3</sup>Rza Safarov

<sup>1</sup>Professor of the department of Control and System Engineering, ASOIU. (Azerbaijan),

<sup>2</sup>Professor, Head of department Mathematical Modeling of Technical Systems, Institute of Control Systems, ANAS. (Azerbaijan),

<sup>3</sup>Assistant of the department of Control and System Engineering ASOIU. (Azerbaijan).

E-mail: <sup>1</sup>siyusifov@yahoo.com; <sup>2</sup>hesenli\_ab@mail.ru; <sup>3</sup>rzasafarov@mail.ru

### ABSTRACT

It is offered improved adequate mathematical models taking into account change of structure and phase for description and optimal control of multiphase time-dependent processes which happen in oil wells exploited by gaslift method, expressed by means of a system of differential equations and taking into account using of their stochastic analogues. Conception of system approach demands to develop means providing optimal exploitation of gaslift complex, or to improve most progressive means from existing ones. To approach to the problem from a wider scientific conception, taking into account a stochastic character of the happened processes more complicates mathematical models and hydromechanical equations that we already got into habit are brought to a solution of nonlinear stochastic differential equations.

**Keywords:** oil well, intermittent gaslift, stochastic process, working substance, optimal process.

It is created improved adequate mathematical models taking into account change of structure and phase for description and optimal control of multiphase time-dependent processes which happen in oil wells exploited by gaslift method, expressed by means of a system of differential equations and taking into account using of their stochastic analogues. It has been got a solution by analytical method of a motion process under influence of different phase speeds of the two-phase mixed liquid (Landau-Raxmatulin model) and the nonlinear changing temperature field. It has been shown applied ways of the solution to learning of gaslift processes. A mathematical model and control algorithm of the problem of distribution of the working substance among gaslift wells have been developed. Criteria for optimal distribution of the working substance among wells under its limited condition have been analysed and selected. A software for solution of the problem of optimal distribution of the working substance on the basis of created model has been created. Taking into account a stochastic character of the forces influencing to the system during the vertical motion of gas-liquid mixture through the oil-well tubing an optimal control system of gaslift complex has been created. A more perfect and adequate mathematical deterministic and stochastic model of motion of gas-liquid mixture through the vertical oil-well tubing inside the well is offered. Changing ways of calculation algorithms within of possibilities of the SCADA control system used for optimizing of gaslift complex in mines at present have been investigated. A more perfect and adequate mathematical deterministic and stochastic model of motion of gas-liquid mixture through the vertical oil-well tubing inside the well:

The equation of un interrupting of the flow in the pipe;

$$\frac{\partial \rho_m}{\partial t} + \frac{\partial(\rho_m u_m)}{\partial x} = 0.$$

the equation of changing of the motion quantity;

$$\frac{\partial(\rho_m u_m)}{\partial t} + \frac{\partial(\rho_m u_m^2)}{\partial x} = -\frac{\partial P_T}{\partial x} - \rho_m g - f \frac{\rho_m u_m^2}{2D_i}$$

for incompressible fictitious fluid (mixture):

$$\frac{\partial u_m}{\partial x} = 0.$$

The equation of un interrupting of the flow in the pipe;

$$\frac{\partial \rho_m}{\partial t} + \frac{\partial (\rho_m u_m)}{\partial x} = 0.$$

the equation of changing of the motion quantity;

$$\frac{\partial (\rho_m u_m)}{\partial t} + \frac{\partial (\rho_m u_m^2)}{\partial x} = -\frac{\partial P_T}{\partial x} - \rho_m g - f \frac{\rho_m u_m^2}{2D_i}$$

for incompressible fictitious fluid (mixture):

$$\frac{\partial u_m}{\partial x} = 0.$$

From these equations we find the system of equations characterizing a time-dependent motion of the mixture in the vertical pipe:

$$\frac{\partial \rho_m}{\partial t} + u_m \frac{\partial \rho_m}{\partial x} = 0; \quad (1)$$

$$\rho_m \frac{\partial u_m}{\partial t} = -\frac{\partial P_T}{\partial x} - \rho_m g - f \frac{\rho_m u_m^2}{2D_i}. \quad (2)$$

Where  $g$  is an acceleration of gravity,  $u_m$  – a vertical speed of the fluid;  $P_T$  – a pressure in the pipe;

$f$  – a coefficient of hydraulic resistance ;  $D_i$  – an entrance diameter of oil-well tubing. Boundary condition:

The 1st boundary conditional is for a vertical pipe. It is a condition of flowing of the liquid from the productive layer to the vertical pipe. Using Dupui formula for the vertical well we shall be able to write the boundary conditions

in the well bottom zone as following:

$$Q_i[x = 0] = \frac{J(P_g - P_{wf})}{\rho_i}; \quad (3)$$

$$J = \frac{2\pi kh}{\mu \log[r_e/r_w]}; \quad Q = uA. \quad (4)$$

Quantity of the gas injected into the well  $Q_g[x = 0] = q_i$ . Because of this equals to the quantity of the measurable on the wellhead, extracted gas

$$Q_m[x = L] = kA c \sqrt{\frac{2p_{wh} - p_{sep}}{\rho_m}}$$

$$\frac{\partial^2 p}{\partial r^2} + \frac{1}{r} \frac{\partial p}{\partial r} = \frac{c \sigma \mu}{k} \frac{\partial p}{\partial t}$$

$$u_i = -\frac{2\pi kh}{\mu} r \frac{\partial p}{\partial r}; \quad Q_i = u_i A;$$

$$A = 2\pi r_w^2 h. \quad Q_i[x = 0] = \frac{J(p_g - p_{wf})}{\rho_i};$$

We will use equations of secondly flow of the mixture to get the motion equation for the excited state of the fluid during the gaslift:

$$\frac{\partial \rho_m}{\partial t} + \left(\frac{Q_m}{A_T}\right) \frac{\partial \rho_m}{\partial x} = 0;$$

$$\frac{\rho_m}{A_T} \frac{\partial Q_m}{\partial t} = -\frac{\partial P_T}{\partial x} - \rho_m g - f \frac{\rho_m Q_m^2}{2D_i A_T^2}$$

$$\frac{\partial \rho_m}{\partial t} + \left(\frac{Q_m}{A_T}\right) \frac{\partial \rho_m}{\partial x} = 0;$$

$$\frac{\rho_m \partial Q_m}{A_T \partial t} = -\frac{\partial \rho_T}{\partial x} - \rho_m g - f \frac{\rho_m Q_m^2}{2D_1 A_T^3}$$

The main problem is to specify stable conditions of the mixture motion in the oil-well tubing. Therefore let us characterize changing of the state parameters of the system as following.

$$\rho_m = \rho_{m,0} + \delta\rho; \quad Q_m = Q_{m,0} + \delta Q; \quad \rho_T = \rho_{T,0} + \delta P$$

If we accept the moving fluid as an incompressible environment:

$$\frac{\partial(\rho_{m,0})}{\partial x} = 0; \quad \frac{\partial(Q_{m,0})}{\partial x} = 0; \quad \frac{\partial(\rho_{T,0})}{\partial x} + \rho_{m,0} g + f \frac{\rho_{m,0} Q_{m,0}^2}{2D_1 A_T^3} = 0.$$

In result for the state of the excited motion of the gas-liquid mixture we get:

$$\frac{\partial(\delta\rho)}{\partial t} + \left(\frac{Q_{m,0}}{A_T}\right) \frac{\partial(\delta\rho)}{\partial x} = 0; \quad (5)$$

$$\frac{\rho_{m,0}}{A_T} \frac{\partial(\delta Q)}{\partial t} = -\frac{\partial(\delta\rho)}{\partial x} - \delta\rho g - f \frac{1}{2D_1 A_T^3} (Q_{m,0}^2 \delta\rho + 2\rho_{m,0} Q_{m,0} \delta Q). \quad (6)$$

We get the following expression for a general flow of the mixture. It shows being of this general flow equal to the total of flows of the gas and liquid parts.

$$Q_m = Q_{s,l} + Q_{s,g}, \quad (7)$$

The same we can say for exciting.

$$\delta Q_m = \delta Q_{s,l} + \delta Q_{s,g},$$

$$\delta Q = \delta Q[x=0].$$

Boundary conditions for excitings are as following:

$$\delta Q_m[x=0] = \delta Q_{s,l}[x=0] + \delta Q_{s,g}[x=0].$$

as volume of the gas injected into the oil-well tubing is constant then the condition in the well bottom zone

$$\delta Q_{s,g}[x=0] = \delta(q_{injection}) = 0.$$

The same we can say for oil flows:

$$\delta Q_m[x=0] = \delta Q_{s,l}[x=0] = 0;$$

As a result we get for the general flow in the wellhead

$$(Q_m[x=L]) = \delta Q_{s,l}[t] = v(t).$$

Integrating the motion equation along the pipe in the interval of (0,L) we get the differential equation of the excited flow through the whole oil-well tubing as following

$$\frac{\rho_{m,o}}{A_T} L \frac{\partial(\delta Q)}{\partial t} = -(\delta[x=L] - \delta P[x=0]) - g \left( \left( \int \delta \rho [x=L] \left( \frac{Q_{m,o}}{A_T} \right) dt \right) - \left( \int \delta \rho [x=0] \left( \frac{Q_{m,o}}{A_T} \right) dt \right) \right) - f \frac{1}{2D_1 A_T^3} \left( \left( \int \delta \rho [x=L] \left( \frac{Q_{m,o}}{A_T} \right) dt \right) - \left( \int \delta \rho [x=0] \left( \frac{Q_{m,o}}{A_T} \right) dt \right) \right) Q_{m,o}^2 + 2\rho_{m,o} Q_{m,o} (\delta Q L).$$

Become excitings of the density of the flow environment have been included to this equation. In the previous known investigations this quantity was taken as average or in general as a constant. Therefore in the next investigations the expression of the density was shown as an implicit function of the time. The general symbolical solution of this equation is in the following form  $\delta \rho(x, t) \rightarrow \phi \left( \frac{tQ_{m,o} - xA_T}{Q_{m,o}} \right)$ . Where  $\phi \left( \frac{tQ_{m,o} - xA_T}{Q_{m,o}} \right)$  is any differentiable function and has a wave character. After some mathematical conversions we get:

$$\phi \left( t - \frac{xA_T}{Q_{m,o}} \right) = \delta \rho = \left( (\partial_{Q_g} \rho_m) \delta Q_g + (\partial_{Q_l} \rho_m) \Delta Q_l / \cdot \{ \delta Q_l \rightarrow v(t), \delta Q_g \rightarrow 0 \} \right) = \frac{Q_g(p_l - p_g)}{(Q_g + Q_l)^2} v(t)$$

In the well bottom zone  $x=0$

$$\phi \left( \frac{tQ_{m,o}}{Q_{m,o}} \right) = \frac{Q_g v(t) (p_l - p_g)}{(Q_g + Q_l)^2} = \frac{q_l (p_l - p_g)}{(q_l + Q_{m,o})^2} v(t);$$

In the wellhead  $x=L$

$$\phi \left( \frac{tQ_{m,o} - LA_T}{Q_{m,o}} \right) = \frac{q_l (p_l - p_g) v \left( \frac{tQ_{m,o} - LA_T}{Q_{m,o}} \right)}{(q_l + Q_{m,o})^2}.$$

Integrating the motion equation on the x coordinate along the well we find:

$$\begin{aligned} \frac{\rho_{m,o}}{A_T} L \frac{\partial(v(t))}{\partial t} &= -(\delta P[x=L] - \delta P[x=0]) - g \left( \left( \int \left( \frac{q_l (p_l - p_g) v \left( \frac{tQ_{m,o} - LA_T}{Q_{m,o}} \right)}{(q_l + Q_{m,o})^2} \right) \frac{Q_{m,o}}{A} dt \right) - \right. \\ &- \left. \left( \int \left( \frac{q_l (p_l - p_g)}{(q_l + Q_{m,o})^2} v(t) \right) \frac{Q_{m,o}}{A} dt \right) \right) - f \frac{1}{2D_1 A_T^3} \left( \left( \int \left( \frac{q_l (p_l - p_g) v \left( \frac{tQ_{m,o} - LA_T}{Q_{m,o}} \right)}{(q_l + Q_{m,o})^2} \right) \frac{Q_{m,o}}{A} dt \right) - \right. \\ &- \left. \left( \int \left( \frac{q_l (p_l - p_g)}{(q_l + Q_{m,o})^2} v(t) \right) \frac{Q_{m,o}}{A} dt \right) \right) - Q_{m,o}^2 + 2L\rho_{m,o} Q_{m,o} v(t) \end{aligned} \quad (8)$$

Differentiating expression (8) on time we get the following differential equation to find changing of density of the flow in the well.

$$\begin{aligned} \frac{\rho_{m,o}}{A_T} L \frac{\partial^2(v(t))}{\partial t^2} &= - \left( \frac{\partial(\delta P[x=L] - \delta P[x=0])}{\partial t} \right) - g \left( \left( \frac{q_l (p_l - p_g) v \left( \frac{tQ_{m,o} - LA_T}{Q_{m,o}} \right)}{(q_l + Q_{m,o})^2} \right) \left( \frac{Q_{m,o}}{A} \right) - \right. \\ &- \left. \left( \frac{q_l (p_l - p_g)}{(q_l + Q_{m,o})^2} v(t) \right) \left( \frac{Q_{m,o}}{A} \right) \right) - f \frac{1}{2D_1 A_T^3} \left( \left( \frac{q_l (p_l - p_g) v \left( \frac{tQ_{m,o} - LA_T}{Q_{m,o}} \right)}{(q_l + Q_{m,o})^2} \right) \left( \frac{Q_{m,o}}{A} \right) - \right. \end{aligned}$$

$$-\left(\frac{q_i(p_i-p_g)}{(q_i+Q_{m,0})^2}v(t)\right)\left(\frac{Q_{m,0}}{A}\right)-Q_{m,0}^2+2Lp_{m,0}Q_{m,0}. \quad (9)$$

At last, after some known mathematical conversions we get

$$P[x=0]=p_{w,f}=pR\frac{Q_i[x=0]\rho l}{J};$$

$$\delta p_{w,f}=\delta P[x=0]=-\frac{\delta Q_i[x=0]\rho l}{J};$$

$$\frac{\partial(\delta P[0])}{\partial t}=-\frac{\rho l}{J}\frac{\partial \delta Q_i[x=0]}{\partial t}=-\frac{\rho l}{J}\frac{\partial(v(t))}{\partial t}$$

$$p_{w,h}=\frac{\rho_m Q_m[x=L]^2}{(kA_c)^2}=\frac{\rho_m(Q_{m,0}+\delta Q[x=L])^2}{(kA_c)^2}+p_{sep} \quad =;$$

$$\delta p_{w,h}=\delta P[L]=\delta\left(\frac{\rho_m Q_m[x=L]^2}{(kA_c)^2}+p_{sep}\right)$$

$$\frac{\delta \rho_m Q_m[x=L]^2}{(kA_c)^2}+\frac{\rho_m \delta(Q_m[x=L])^2}{(kA_c)^2}=\frac{Q_g v\left(\frac{tQ_{m,0}-LA_T}{Q_{m,0}}\right)(p_i-p_g)Q_m[x=L]^2}{(Q_g+Q_i)^2(kA_c)^2}+\frac{2\rho_m Q_m[x=L]\delta(Q_m[x=L])}{(kA_c)^2};$$

$$\delta Q_m=\delta Q_{s,l}+\delta Q_{s,g}; \quad \delta(Q_m[x=L])=\delta Q_{s,l}+\delta Q_{s,g}[t]=v(t);$$

$$\frac{\partial(\delta P[L])}{\partial t}=\frac{Q_g(p_i-p_g)Q_m[x=L]^2}{(Q_g+Q_i)^2(kA_c)^2}\frac{\partial\left(v\left(\frac{tQ_{m,0}-LA_T}{Q_{m,0}}\right)\right)}{\partial t}+$$

$$\frac{2\rho_m Q_m[x=L]^2}{(kA_c)^2}\frac{\partial\left(v\left(\frac{tQ_{m,0}-LA_T}{Q_{m,0}}\right)\right)}{\partial t}=[Q_m[x=L]=Q_{m,0}]; \quad (33)$$

$$[Q_i=Q_{m,0}]=\frac{q_i(p_i-p_g)Q_{m,0}^2}{(q_i+Q_{m,0})^2(kA_c)^2}\frac{\partial\left(v\left(\frac{tQ_{m,0}-LA_T}{Q_{m,0}}\right)\right)}{\partial t}+\frac{2\rho_{m,0}Q_{m,0}}{(kA_c)^2}\frac{\partial\left(v\left(\frac{tQ_{m,0}-LA_T}{Q_{m,0}}\right)\right)}{\partial t}.$$

This equation is a differential equation of the excited motion of two-phase liquid in the top part of the well (in the well head). Differentiating equation (8) on time and taking into account expression (9) we find result equations of the motion in the wellhead:

$$\begin{aligned} \frac{\rho_{m,0}}{A_T}L\frac{\partial^2(v(t))}{\partial t^2} &= \left(\frac{q_i(p_i-p_g)Q_{m,0}^2}{(q_i+Q_{m,0})^2(kA_c)^2}\frac{\partial\left(v\left(t-\frac{LA_T}{Q_{m,0}}\right)\right)}{\partial t}+\right. \\ &+ \frac{2\rho_{m,0}Q_{m,0}}{(kA_c)^2}\frac{\partial\left(v\left(t-\frac{LA_T}{Q_{m,0}}\right)\right)}{\partial t}+\frac{\rho l}{J}\frac{\partial(v(t))}{\partial t}\Bigg)-g\left(\left(\frac{q_i(p_i-p_g)v\left(t-\frac{LA_T}{Q_{m,0}}\right)}{(q_i+Q_{m,0})^2}\right)\left(\frac{Q_{m,0}}{A_T}\right)-\right. \\ &\left.-\left(\frac{q_i(p_i-p_g)}{(q_i+Q_{m,0})^2}v(t)\right)\left(\frac{Q_{m,0}}{A_T}\right)\right)-f\frac{1}{2D_1A_T^2}\left(\left(\left(\frac{q_i(p_i-p_g)v\left(t-\frac{LA_T}{Q_{m,0}}\right)}{(q_i+Q_{m,0})^2}\right)\left(\frac{Q_{m,0}}{A_T}\right)-\right.\right. \end{aligned}$$

$$-\left(\frac{q_n(p_i - p_g)}{(q_j + Q_{m,0})^2} v(t)\right) \left(\frac{Q_{m,0}}{A_T}\right) Q_{m,0}^2 + 2L\rho_{m,0}Q_{m,0} \frac{\partial(v(t))}{\partial t}.$$

Stationary flows and the amount of extracted liquid (oil) at that time are more important from the practical side during exploitation time. That is why let us write the differential motion equation for the stationary state

$$-\frac{\partial(P_{T,0})}{\partial x} - \rho_{m,0}g - f \frac{\rho_{m,0}Q_{m,0}^2}{2D_i A_T^2} = 0$$

Integrating of this equation along the well axis is brought to the solution of algebraic equations for finding the average unknown quantity during the stationary flow of the liquid phase in the well.

$$P_{T,0}[x = L = P_{T,0}[x = 0] - \rho_{m,0}gL] - fL \frac{\rho_{m,0}Q_{m,0}^2}{2D_i A_T^2}$$

We use the following known expressions for finding the average volume of extracted liquid and the injected gas:

$$Q_{m,0} = Q_{s,l} + q_i$$

Where  $Q_{s,l}$  is a consumption of the liquid phase. If we express other variables in the equation with  $Q_{m,0}$  then we get the following for the average density of the stationary flow extracted from the well

$$\rho_{m,0} = \frac{p_g q_{injection} + p_l Q_{s,l}}{q_{injection} + Q_{s,l}} = \frac{(p_g - p_l) q_{injection} + p_l Q_{m,0}}{Q_{m,0}}$$

For the average pressure in the exploitation wellhead

$$P_{T,0}[x = L] = \frac{\rho_{m,0}Q_{m,0}^2}{2(kA_c)^2} + p_{sep} = \left(\frac{(p_g - p_l)q_i + p_l Q_{m,0}}{Q_{m,0}}\right) \frac{Q_{m,0}^2}{2(kA_c)^2} + p_{sep} = \left((p_g - p_l)q_i + p_l Q_{m,0}\right) \frac{Q_{m,0}}{2(kA_c)^2} + p_{sep}$$

Where  $p_{sep}$  is the pressure intended beforehand for processing of the system in the separator. At the same time we get the following expression for the average pressure in the well bottom

$$P_{T,0}[x = 0] = pR - \frac{p_l Q_{s,l}}{PL} = pR - \frac{p_l(Q_{m,0} - q_i)}{J}$$

Here the catchment pressure of the liquid in the external boundary of reservoir is signed with  $pR$ . From this we get the following algebraic equation to specify  $Q_{m,0}$ :

$$\left(\frac{(p_l - p_g)q_i + p_l Q_{m,0}}{2(kA_c)^2}\right) \frac{Q_{m,0}}{Q_{m,0}} + p_{sep} = pR - \frac{p_l(Q_{m,0} - q_i)}{J} - \rho_{m,0}gL - fL \frac{1}{2D_i A_T^2} \left(\left(\frac{(p_l - p_g)q_i + p_l Q_{m,0}}{2(kA_c)^2}\right) p_{sep}\right) Q_{m,0}^2 \quad (41)$$

Solution of this equation allows to calculate the average flow rate of the oil well during exploitation by gaslift method in the stationary state and control and finally optimize the well productivity by means of controllable characteristic parameters. Integrating of this equation along the well axis is brought to the solution of algebraic equations for finding the average unknown quantity during the stationary flow of the liquid phase in the well.

$$P_{T,0}[x = L = P_{T,0}[x = 0] - \rho_{m,0}gL] = -fL \frac{\rho_{m,0}Q_{m,0}^2}{2D_i A_T^2}$$

We use the following known expressions for finding the average volume of extracted liquid and the injected gas:

$$Q_{m,0} = Q_{s,l} + q_i \quad Q_{s,l} = Q_{m,0} - q_i$$

Where  $Q_{s,l}$  is a consumption of the liquid phase. If we express other variables in equation (9) with  $Q_{m,0}$  then we get the following for the average density of the stationary flow extracted from the well:

$$\rho_{m,0} = \frac{p_g q_i + p_l Q_{s,l}}{q_i + Q_{s,l}} = \frac{(p_g - p_l) q_i + p_l Q_{m,0}}{Q_{m,0}}$$

These models were created on the basis of simplifications according to correlations based on statistics, were adapted to the activities and politics of the concrete company. Different results for the same object of the different collections is explained with this. Regular or periodic gaslift method is used in more than 60% of the world oil production regions. That is why scientific researches in this area were intensified. Different valuable results have been received got in 15-20 recent years. A process of usage and development of the gaslift method in our country and the world have been fully learnt in this paper. Theoretical and practical requirements necessary for optimizing of these researches, more influential parameters important to be taken into account, usage more progressive and perfect technology and equipment in the measurement and production, possibilities of using existing and purchasable program packages are analysed. Algorithms and software which will be used in the practice have been created.

For the average pressure in the exploitation wellhead

$$P_{T,0}[x = L] = \frac{\rho_{m,0} Q_{m,0}^2}{2(kA_c)^2} + p_{sep} = \left( \frac{(p_g - p_l) q_i + p_l Q_{m,0}}{Q_{m,0}} \right) \frac{Q_{m,0}^2}{2(kA_c)^2} + p_{sep} =$$

$$= \left( (p_g - p_l) q_i + p_l Q_{m,0} \right) \frac{Q_{m,0}}{2(kA_c)^2} + p_{sep}$$

Where  $p_{sep}$  is the pressure intended beforehand for processing of the system in the separator. At the same time we get the following expression for the average pressure in the well bottom:

$$P_{T,0}[x = 0] = pR - \frac{p_l Q_{s,l}}{PL} = pR - \frac{p_l(Q_{m,0} - q_{injection})}{J} \quad (9)$$

In (9) the catchment pressure of the liquid in the external boundary of reservoir is signed with  $pR$ . Taking into account (8) and (9) in (5) we get an algebraic equation to specify  $Q_{m,0}$ .

$$\left( (p_l - p_g) q_i + p_l Q_{m,0} \right) \frac{Q_{m,0}}{2(kA_c)^2} + p_{sep} = pR - \frac{p_l(Q_{m,0} - q_i)}{J} - \rho_{m,0} gL -$$

$$- fL \frac{1}{2D_{A\bar{h}}} \left( \left( (p_l - p_g) q_i + p_l Q_{m,0} \right) \frac{Q_{m,0}}{2(kA_c)^2} + p_{sep} \right) Q_{m,0}^2$$

For the purpose of creating more adequate mathematical model of the considering problem it has been got a solution for the produced mixture for the time-dependent state on the basis of mutual penetrating environments (Landau- Raxmatulin) model by means of taking into account temperature changings along the well. The solution was used in the calculation algorithm. Analysis of the numerous (hundreds of) scientific and technical literature considered by authors has shown that offered algorithms are more complex and perfect. In the former Soviet Union they used calculation models created on the basis of MQUA algorithm. Now in our country OLQA program package is mostly used. Although these program packages are much used universal sets they have been formed as solution sets of linear problems. Expressions got in the

represented paper allow to specify and control suitable exploitation conditions of gaslift oils by means of determining the amount of the liquid volume gathered in gaslift oils and the gathering time.

#### REFERENCES

1. A.B.Hasanov. The Reaction of mechanical systems on time-dependent external influences. Baku. "Elm". 2004. 257 pp.
2. Hasanov A.B., Motion of interpenetrative environments in pipe lines. "Scientific prospects of the XXI century. Achievements and prospects of the new century", Russia, Novosibirsk, №5, 2015. pp. 52-56.
3. Yusifov S.I., Ahmedov C.M. About combined work of the layer and the lift in the problem of continuous gas lift control. " Automation, telemechanization and communication in oil industry", Moscow, №1, 2010, pp. 34-37.
4. Papusha A. N., Kazunin D. V. Dynamics of the poliphase currents in the sea trunk pipelines. - Moscow- Izhevsk: Institute of the computer studies, 2012. - 496 pp.



## TECHNOLOGIES THAT SAVE AND GROW

Elmira Veliyeva

Senior teacher, Azerbaijan State Agrarian University

E-mail: elay\_1976@mail.ru

### XÜLASƏ

Bu məqalədə su təchizatı rejiminin necə düzgün idarəedilməsi ilə torpağın becərilməsi, yağış sularından istifadə, suvarma texnologiyası ilə idarəetmənin necə düzgün istifadə edilməsi qaydalarından söhbət gedir. Dünya üzrə becərilən torpaqların 20 faizi suvarılan ərazilərdir, bu isə ümumilikdə kənd təsərrüfatında mövcud olan torpaqların 40 % deməkdir. Məhsullara verilən suyun miqdarına nəzarət edərək suvarma texnologiyalarının idarəedilməsi onların istifadəsinin asanlaşdırılması məhsuldarlığın yüksək olmasına səbəb olur. Fermerlər məhsula stabil olaraq su verirlərsə o zaman məhsuldarlıq yüksəlir. Bir çox növ bitkilər yağışla suvarma sistemi vasitəsilə öz kök sistemlərini nəm saxlayır və uzun müddət öz suya olan ehtiyaclarını təmin edirlər. Yağış suyu ilə suvarma sistemi inkişaf mərhələsindədir. Məhsulların növbəli əkinə keçməsi vasitəsilə bu sistemi daha da inkişaf etdirmək olar. Növbəli əkin zamanı torpaqda su ehtiyatı daha çox saxlanılır. İnkişaf etdirilmiş, təkmilləşdirilmiş su idarəetməsi vasitəsilə istehsal riskini minimuma endirmək olar. Dünya miqyasında suvarma texnologiyası ilə suvarılan ərazinin təxminən 300 000000 ha dır. Daha çox suvarılma sisteminin inkişaf etdiyi yer Asiyadır. Haradakı düyü istehsalı təxminən 800000000 ha dır və bu isə hər hektardan 5 ton məhsula bərabərdir. Bu isə böyük göstəricidir.

### РЕЗЮМЕ

В этой статье идет речь как правильно управлять режим водоснабжения при выращивании почвы, как использовать дождевую воду и как правильно управлять технологией полива. 20% обрабатываемых земель в мире орошаемы. Это означает 40% всей существующей земли в сельской хозяйстве. Контроль за технологией орошения упрощает его использовать и повышает урожайность. Если фермеры стабильно снабжают водой урожай, то производительность растет. Многие виды растений сохраняют свои корневые системы влажными благодаря своей системе орошения дождевой водой и обеспечивают свои водные ресурсы. в течение длительного времени. Иригационная система с дождевой водой находится в стадии развития. При следующем выращивании продукции эту систему можно развить и доработать. Запасы воды при следующем выращивании урожая больше сохраняются. При развитии и усовершенствовании управления водоснабжением риск производительности можно довести до минимума. Технология полива по всему миру составляют около 300 мю. Место, где развивается иригационная система находится в Азии где выращивание риса составляет 80 мю. гектаров. А это составляет 5 тон с гектара. И это является большим показателем.

Crops are grown under a range of water management regimes, from simple soil tillage aimed at increasing the infiltration of rainfall, to sophisticated irrigation technologies and management. Of the estimated 1.4 billion ha of crop land worldwide, around 80 per cent are rainfed and accounts for about 60 percent of global agricultural output. Under rainfed conditions, water management attempts to control the amount of water available to a crop through the opportunistic deviation of the rainwater pathway towards enhanced moisture storage in the root zone. However, the timing of the water application is still dictated by rainfall patterns, not by the farmer.

Some 20 per cent of the world's cropped area is irrigated, and produces around 40 percent of total agricultural output. Higher cropping intensities and higher average yields account for this level of productivity. By controlling both the amount and timing of water applied to crops, irrigation facilitates the concentration of inputs to boost land productivity. Farmers apply water to crops to stabilize and raise yields and to increase the number of crops grown per year. Globally, irrigated yields are two to three times greater than rainfed yields. Thus, a reliable and flexible supply of water is vital for high value, high-input cropping systems. However, the economic risk is also much greater than under lower input rainfed cropping. Irrigation can also produce negative consequences for the environment – including soil salinization and nitrate contamination of aquifers.

Growing pressure from competing demands for water, along with environmental imperatives, mean that agriculture must obtain more crops from fewer drops and with less environmental impact. That is a significant challenge and implies that water management for sustainable crop production intensification will need to anticipate smarter, precision agriculture. It will also require water management in agriculture to become much more adept at accounting for its water use in economic, social and environmental terms.

Prospects for sustainable intensification vary considerably across different production systems, with different external drivers of demand. In general, however, the sustainability of intensified crop production, whether rainfed or irrigated, will

depend on the adoption of ecosystem approaches such as conservation agriculture, along with other key practices, including use of high-yielding varieties and good quality seeds, and integrated pest management.

### **Rainfed cropping systems.**

Many crop varieties grown in rainfed systems are adapted to exploit moisture stored in the root zone. Rainfed systems can be further improved by, for example, using deep-rooting crops in rotation, adapting crops to develop a deeper rooting habit, increasing soil water storage capacity, improving water infiltration and minimizing evaporation through organic mulching. Capture of runoff from adjacent lands can also lengthen the duration of soil moisture availability. Improving the productivity of rainfed agriculture depends largely on improving husbandry across all aspects of crop management. Factors such as pests and limited availability of soil nutrients can limit yield more water availability per se. The principles of reduced tillage, organic mulching and use of natural and managed biodiversity are fundamental to improved husbandry.

The scope for implementing SCPI under rainfed conditions will depend, therefore, on the use of ecosystem-based approaches that maximize moisture storage in the root zone. While these approaches can facilitate intensification, the system is still subject to the vagaries of rainfall. Climate change will increase the risks to crop production. Nowhere is the challenge of developing effective strategies for climate change adaptation more pressing than in rainfed agriculture.

Other measures are needed, therefore, to allay farmers' risk aversion. They include better seasonal and annual forecasting of rainfall and water availability and flood management both to mitigate climate change and to improve the resilience of production systems.

More elaborate water management interventions are possible to reduce the production risk, but not necessarily to further intensify rainfed production. For instance, there is scope to transition some rainfed cropping systems to low-input supplementary irrigation systems, in order to bridge short dry spells during critical growth stages but these are still reliant upon the timing and intensity of rainfall.

On farm runoff management, including the use of water retaining bunds in cultivated areas, has been applied successfully in transitional climates.

Off-farm runoff management, including the concentration of overland flow into shallow groundwater or farmer-managed storage, can allow for limited supplementary irrigation. However, when expanding over large areas, these interventions impact downstream users and overall river basin water budgets.

Extending the positive environmental and soil moisture conservation benefits of ecosystem approaches will often depend upon the level of farm mechanization, which is needed to take advantage of rainfall events. Simpler technologies, including opportunistic runoff farming, will remain inherently risky, particularly under more erratic rainfall regimes. They will also remain labour intensive.

Policymakers will need to assess accurately the relative contributions of rainfed and irrigated production at national level. If rainfed production can be stabilized by enhanced soil moisture storage, the physical and socio-economic circumstances under which this can occur need to be well identified and defined. The respective merits of low-intensity investments in SCPI across extensive rainfed systems and high intensity localized investments in full irrigation need careful socio-economic appraisal against development objectives.

With regard to institutions, there is need for re-organization and reinforcement of advisory services to farmers dependent on rainfed agriculture, and renewed effort to promote crop insurance for small-scale producers. A sharper analysis of rainfall patterns and soil moisture deficits will be needed to stabilize production from existing rainfed systems under climate change impacts.

### **Irrigated cropping systems.**

The total area equipped for irrigation worldwide is now in excess of 300 million ha and the actual harvested is estimated to be larger due to double and triple cropping. Most irrigation development has taken place in Asia, where rice production is practised on about 80 million ha, with yields averaging 5 tonnes per ha.

Irrigation is a commonly used platform for intensification because it offers a point at which to concentrate inputs. Making this sustainable intensification, however, depends on the location of water withdrawal and the adoption of ecosystem based approaches such as soil conservation, use of improved varieties and integrated pest management.

Surface irrigation by border strip, basin or furrow is often less efficient and less uniform than overhead irrigation. Micro irrigation has been seen as a technological fix for the poor performance of field irrigation, and as a means of saving water. It is being adopted increasingly by commercial horticulturalists in both developed and developing countries, despite high capital costs.

Knowledge-based precision irrigation that offers farmers reliable and flexible water application will be a major platform for SCPI. Automated systems have been tested using both solid set sprinklers and micro-irrigation, which involve using soil moisture sensing and crop canopy temperature to define the irrigation depths to be applied in different parts of the field. Precision irrigation and precision fertilizer application through irrigation water are both future possibilities for field crops and horticulture, but there are potential pitfalls. Recent computer simulations indicate that, in horticulture, salt management is a critical factor in sustainability.

A wide of traditional and innovative rainwater harvesting systems is found in different zone. The technology improves infiltration and increases nutrient availability on sandy and loamy soils, leading to significant increases in yields, improved soil cover and reduced downstream flooding.

#### REFERENCES

1. M.İ. Cəfərov A.H.Babayev Z.A.İbrahimov “ Azərbaycanın təbii sərvətləri və onlardan səmərəli istifadə. Bakı, Qanun nəşriyyatı, 2011
2. A.H.Babayev, V.A.Babayev. Ekoloji kənd təsərrüfatının əsasları. Bakı, Qapp-Poliqraf, 2005
3. Abbasov Ziyad Mehralı oğlu. Kənd Təsərrüfatı maşınqayırma texnologiyası. Dərslik, Gəncə,2016  
Cəmil Hacıyev, Elxan Allahverdiyev, Azad İbrahimov. Suvarma Əkinçiliyi. Bakı, 2012

## TERMINOLOGICAL VOCABULARY IN THE MODERN AZERBAIJANI LANGUAGE

Pashayeva Gunel

PhD in philology, Associate professor.

Azerbaijani language and its teaching methodology. Sumgait State University (Azerbaijan)

### ABSTRACT

In modern life, it is impossible to even talk about writing scientific articles without the use of specific terminology. These facts indicate that the terminology has now transformed into the language's dynamic lexical units. From this perspective, we can conclude that the function of the term in the language is conditioned by the frequency of its use, the level of its representation in the language paradigm, and its suitability to the phonetic and graphic system of the language.

**Keywords:** terminology, system of terminology, language paradigms, Azerbaijani language, polysemy.

The main function of the term is the exact expression of specific concept, and along with this, the term should carry the social and communicative purpose. The term is the carrier of the collective scientific and professional memory. Based on these positions, it should be noted that another function of the term is its informational content (such as media carrier and its transmitter). The informational content of the term determines the frequency of its use in various fields of science and social activity of the person. For example, there is terminology which is of general scientific nature. Such terms wholly and generally relate only to the scientific style (membrane, cell, etc.). There are also words that combine both terminological and general sense, being able to express other concepts. For example, the word «scorpion» in the Azerbaijani language is the name of an insect. Later this zoological term started to also represent the concept of the clock's arrow. This was due to the expansion of semantics by transferring meaning, thus there appeared the phrases like «saatın əqrəbi» (the arrow of the clock), «əqrəb bürcü» (the Scorpio zodiac sign).

**Actuality of the problem.** As you know, language, as a universal sign system, covers the whole world of concepts, events and objects. A feature of the thinking process is also the distinguishing between an object and an event through naming. However, the relationship between the name and the meaning is not unique. In most cases, such a connection is out of the question. On the other hand, the term and the concept are unambiguously interconnected, in this sense, their relationship should be evaluated in a slightly different way. Terms are generally formed when concepts that define any quality or property of an object appear. Comparative terminology, as a branch of linguistics, is closely connected with the everyday life of people, with social processes. According to researchers, at the present stage of language development, terminology is the most dynamically and rapidly developing branch of linguistics. All this creates the basis not only for the formation of metalanguage, but also for explaining the development processes of the base of individual languages. After all, the main thing is not so much the lexical features of the term, but how much its function or what it is used for [1].

**Level of research problem.** The term is a special active participant in the process of knowledge formation and understanding of any situation, a necessary element that can be useful in any area of human activity, contributing to the development of science and education. M.E. Akhmetova, who studied the line of development of the concept of "term", emphasizes that this word is a multifaceted and multifunctional concept of the science of terminology [2, p.22-26]. This word has multifunctionality in linguistics, therefore it is relevant for science.

In linguistics about terms there are a variety of ideas. Researchers write about this, that the term is the main concept of the language, pursuing a special purpose. The term is a special word or phrase adopted in professional activities [3] Based on this definition, we can say that the term is a word or phrase that has a definitive function and explains, names, clarified concepts of the sphere of science, technology, economy and culture. From here follow such functions of terms as nominatives, in formativeness, representativeness. Compared to ordinary words, terms are carriers of an informative function. This function is basic here. Informative terms turn into a dynamic lexical unit.

**The results of the analysis.** A term in any language is a lexical unit and it has a special terminological meaning. This meaning can be expressed in words, special formulas (for example, abbreviations or abbreviations). Development and functioning is the domain of the term and therefore depends on the dynamics of its development. For this reason, the formation, formation and functional features of the terms also depend on extra linguistic factors. If there were no extralinguistic factors, then the term would also lose its information content. Thus, any concept related to the term, more accurately and comprehensively expressing the concept, meets the relevant requirements and the level of development of science. A term belonging to the concept of one sphere can express another concept in another sphere. For example, the word "mouse" is used as the part, tool that controls the computer in information technology, and in zoology it is used to denote a living creature, a rodent. The Azerbaijani language uses the word in its first meaning, in parallel with the word

from the English language “maus”. As you can see, at the end of the 20th century, the new word “mouse” was introduced into the Azerbaijani language terminology system in a new terminological sense. In fact, this term fell into the languages of Europe through a change in the semantic meaning that it wore in English, to a new one, when used in technological systems. By means of tracing paper, this word in a new sense got into the Russian language.

This word, denoting a new meaning through an intermediary language, contributed to the emergence of a new term in the Azerbaijani language. How appropriate is the use of a polysemantic word as a term? As you know, in terminology, words should be concrete, monosemantic and concise. To ensure these qualities, a commission was established in the Republic of Azerbaijan to monitor the development and regulation of terminological vocabulary, as well as to unify the terms. The need to create such a commission was based on the confusion and inaccuracy in the use of terms. With the development of technology, the introduction of technical innovations, new concepts are formed, for which it is necessary to create new terms. Of course, the term is characteristic of the scientific style. Terms of great importance can be considered indicators of the development of language, culture and science.

The term, therefore, is the basic unit of the word, historically formed category. A specific function separates them from ordinary words. Terms constitute a special group of words that experts use in their practice. Terms express certain concepts for a highly specialized field and express meaning in a peculiar form. A scientific and technical concept is expressed by means of a word, but not of an ordinary, but of a term, since this is how one can obtain accurate and specific information about a word. Terms are distinguished by their definitive function, and from the point of view of meaning and method of use, they occupy a special place in the vocabulary of words and contribute to an accurate and concise expression of the meaning of scientific information [3, p.25].

Not every word can act as a term. Only a word with certain characteristic features (monosemantics, lack of expression) can earn the status of use as a term. The concepts of term and termoid are distinguished. Words of a borderline character are called a terminoid, which at some point may become a term. V.A. Tatarinov notes that termoids are term-like, with an indefinite word status. Along with this, he considers it necessary to single out a group of words that can be combined under the name “termonym”. These are words that in the text fulfill the function of a term in the text and even actively participate in the formation of terms [4].

Both the word and the term are lexical categories, but there is a certain difference between the two units. Unlike the process of word formation, term formation takes place under a certain control. A term has a special function, but special names are not terms. The Turkish scientist G. Zulfikar describes the general features of the terms this way: these are words with one meaning, with a stable meaning, clearly, accurately and specifically express the meaning of concepts. Terms are not formed at the level of the national language, however, there are words here that later acquired the meaning of the term [5, pp. 20-21].

The vocabulary of the Azerbaijani language contains many words used as terms. Terms formed in a semantic way, for example, are as follows: address, copy, face, gold, silver, section, throat, ridge, cavity, network, memory, and so on.

As part of speech, terms usually act as nouns. In general, they have the following differences from words:

1. generalized words are lexical units that are equally understood by all, often used in language. The term is a precisely formulated word that defines concepts from the sphere of science and technology;
2. generalized words are used in each of the functional styles, the terms are used more in a scientific style;
3. generalized words are lexical units that are clear to everyone, while the terms express the essence of concepts from different fields of science and technology and therefore can only be understood by specialists;
4. term tend to monosemy, and generalized words clarify their meaning in a certain verbal space [3, p.29].

It is clear that in the language nothing is formed from scratch or without meaning. The formation of each lexical unit is predetermined by necessity. For example, in order to make speech more vivid and figurative, metaphors should be applied, and additional meanings should be introduced. Terms arise as a result of the need for them of developing scientific and technological progress and historical need for this.

Borrowed words that come into the language are subject to phonetic, grammatical, lexical and semantic laws. A borrowing language carries borrowed words through a lengthy process of processing and exposure, appropriating them based on its laws and regulations. Of course, in the assimilation of borrowed words, the duration of their use, the affinity of languages, structure, etc. Borrowings in a language can then be long-lived, when they are graphically adapted to the native words of the language, without violating the norms of this language. S. Sadykova believes that words according to the degree of borrowing should be divided into fully borrowed and partially borrowed. Partially borrowed mainly come with a full meaning or meaning, their lexical and semantic meaning is limited, being used on a limited scale. For example, Baskerville (the name of the font created by the English printer John Baskerville), autoscintigraphy (a method for making cliches with a pattern), hydrophilization (alignment with a solution of hydrophilization of empty spaces in forms for flat printing), ice (cotton fabric; used in printing for binding) , lineage (number of lines, in printing the total number of lines on the printed page), offset (in the general sense, printing with an elastic cylinder) [6, p.29], moderator (group curator). Full borrowings, undergoing complete phonetic, grammatical assimilation, occupy an appropriate place in the composition of the language. Such borrowings are correctly perceived by all, can even be introduced into the composition of generalized words. For example, these are words such as format, computer, folder, graph, broadcast, dictionary, print, author, etc.

When considering the lexical and semantic meaning of borrowed words, it becomes clear that many borrowings have further expanded their meaning and acquired their semantic content. For example, the word “form” is used to mean frames, frames, etc. This word is used in publishing and printing business, in journalistic terminology; as a category of materialist dialectics, in journalism and in general in journalism as elements of form are used as a word, genre structure, composition, plot, etc. 2. The form still happens in the printing industry; it is called the iron frame into which the typographic set is placed. In general, this lexical unit in various fields has different semantics. Types and forms of speech, forms of verbal communication, graphic form of speech, etc. Even in household vocabulary, this word is found quite often. For example, the form of the house, the form of writing, the form of speech, and so on. This word has its primary meaning, it can be said, lost. The loss of borrowed words of their original meaning and the acquisition of new lexical semantic meanings. A fairly common linguistic phenomenon. “In a borrowed language object, the expansion of the meaning of a word or its narrowing, its use in a figurative sense, is understood as a process of semantic transformation” [3, p.295]. The terminology of the Azerbaijani language has come a long way in development, presently presenting a nominative system with a high level of development in accordance with the state of modern scientific and technical terminology. In everyday life, we can say that we meet daily with new terms, new concepts. Such a dynamic development of terms is explained in different ways. One of the reasons is the intensification of the formation of terms in various linguistic fields. The role of the media in the activation of tokens is great. For example, the words infrastructure, highway, or bacterial in recent years are often found in newspaper texts: comprehensive measures to rebuild the road transport infrastructure concern not only the main roads, but also inter-village and intra-village roads [7]; This month, in orchards, irrigation work should be continued, “Bordeaux” liquid or its substitutes should be applied to found bacterial diseases by spraying plants [7], etc.

In these proposals, the terms bacterial, infrastructure, and trunk were used, which were thereby activated. The use of such terms in texts has an impact on the significance of the text, its attractiveness and informativeness; as a result, a certain interest in the context awakens (the issue of informative manipulation). It is believed that such activation is associated primarily with extralinguistic factors that allow the use of terms in large numbers in the media. The second reason for activation is due to the fact that the new term in terms of content can explain a particular concept more accurately. Finally, the third reason is that these words fit well on the tongue, are easy to pronounce, and adapt to the grammatical paradigm of the language [8].

As in other languages, in the Azerbaijani language terms in terms of structure are simple, complex and derivative. The activation of terms occurs under the influence of extralinguistic terms; in general, terms with prefixes in the Azerbaijani language are more multifunctional. Such terms can be easily found in various fields of science: hydro-construction, decontamination, ethnography, macrobenthosis, macro-fauna, and so on.

In general, three functions of the language are distinguished in linguistics: nominative, emotional, and representative. If borrowed words have the indicated functions, then they easily enter the language paradigm, echoing the grammatical and phonetic features of this language. With this approach, the structure of the borrowed element does not have such great significance. Since borrowing can be simple, complex, or derivative, it can also be in the form of collocations or abbreviations. For example: in these two joint reports of UNESCO and the United Nations Development Program, it was emphasized that the support of “creative industrialization”, the promotion and reliable protection of copyright and related rights became an integral part of local economic development programs; In recent years, in our country, State programs have been consistently implemented in the field of sustainable supply of electricity to the electricity sector, ensuring the principle of security here. The Bureau of the Assembly unanimously adopted this decision at the plenary session of the Assembly [9].

In the above examples, various structures of terms are observed: UNESCO, UN (abbreviation), industry, stimulate (stimulate) (simple word), electric power sector, in the bureau of the assembly, plenary session of the assembly (phrase). Based on these examples, we can say that the main and main functions of the terms are nominativity and representativeness. The fact is that the semantics of a term expressing a certain concept is more accurate. S.M.Kharlitsky believes that if the main task of a term is its functions, then it is expressed in the ability to express special concepts. However, “if a term has only a defining, classifying definition, then this is no longer a term. Speaking about the heuristic role of the term, first of all, the role of the term as a language pointer to some general and regular feature of the object is implied. Having blocked the way of variability of the term, we turn it into an instrument of the process of cognition” [10, p.12.21]. This refers to the fact that the term, as a token, has in itself univariance and specific semantics. At its core, the term does not just refer to the language, it is already included in the formed terminological system. The terminological language has the status of a subsystem in a common lexical system. A.A. Reformatsky considers the terminological system as a system of concepts related as any scientific field. In his opinion, if a word has a chance to get ambiguity beyond the terminological framework, then when entering a certain terminology, it definitely loses this chance [11].

However, modern linguistic facts suggest the opposite. For example, in the Azerbaijani language you can come across enough polysemantic terms. For example, *konduktor* - 1) a transmitting element in mechanical engineering, for turning hard materials; 2) the title assigned to engineers or artists; 3) a person who collects fare payment in transport; *kontakt* - 1) communication in diplomacy, 2) a person or a company in economic activity, 3) in physics communication, ending with an electric discharge, etc. The same can be said about the term *ethnography*. For example, despite the fact that this term is

more used in linguistics or literary criticism, this term can also be found in the oil industry. Therefore, often the same term can have different meanings and meanings. As a rule, such terms are called polysemantic, because they can have several meanings [12, p. 26-33]. We believe that one cannot talk about terms, that they are polysemantic. Inside a certain field, they can be used in only one sense. This is based on the fact that in each semantic field the term can be used only in one, definite sense. In contrast, the term-concept refers to a definition, a definition that just defines it. Terms that have the same verbal shell are not ambiguous or polysemantic terms. In terminology, they are called inter-field homonyms. The definition of a term can change regardless of its information capacity [13, p.15].

The polysemy observed in terms indicates that these terms are successfully mastered by the Azerbaijani language and have become an integral part of its paradigm. They are heavily used here. For example, the use of various terms by writers gives us an idea not only about the profession of heroes of works of art, but also decorates his speech: İl boyu işigücü Azneft meydanındaki tennis kortunda tennis oynamaqdır (During the year, their classes are playing tennis courts on Azneft Square ) [14, p.30]; Divarlarda stellajlar düzəldilmişdi, döşəmədə isə cürbəcür yeşiklər düzülmüşdü (Shelves were built on the walls. Various drawers were laid on the floor) [14, s.33].

A nomination of this kind (name) proceeds from the characteristics of the national language. Terminological vocabulary, as a special subsystem of the lexical system, is connected with the literary language by a long and strong connection. As a result, there is a mutual exchange of lexical units. The context in which the term is used, the relationship of the term with this area of the language, belonging to it indicates the existence of this term in this context [15, p. 8-9]. Therefore, there are factors confirming that the term belongs to a certain area of the language sphere. Although context is one such term, the terms themselves are independent of context.

## REFERENCES

1. Vinogradov S.I. The culture of speech / S.I. Vinogradov, O.V. Platonov. - M., 1999 [Electronic resource]. - Access Mode: <http://sbiblio.com/>
2. Akhmetova M.E. Domestic and foreign experience in the study of terminology: the evolution of the concept of "term" in linguistics // Philological Sciences. Questions of theory and practice, Tambov: Gramota, 2014, No. 8 (38): in 2 hours. Part 1, p. 22-26.
3. Sadykova S.A. Azerbaijani language terminology. Baku: Elm, 2011. -- 378 p.
4. Tatarinov V.A. Methodology of scientific translation. Moscow Lyceum, Moscow: 2007. - 526 p.
5. Gamza Zulfikar. The meaning of the terms and the ways of their formation. Ankara: 2011. -- 213 p.
6. Makhmudov M., Akhundov R., Imamaliev R. Explanatory dictionary of publishing, printing and journalistic terms. Baku: 2005
7. The newspaper "Sharg gapysy", 05/02/2014 // URL: <http://serqqapisi.az/index>. (07.17.2014)  
<http://www.pandia.ru/464675/>
8. The newspaper "Azerbaijan", 04/27/2014 // URL: <http://www.anl.az/down> (07/07/2014)
9. Harlitsky S.M. Information structure of the term: author. diss .. cand. filol. sciences. M.: 2003. - 21 p.
10. Reformed A.A. Introduction to linguistics. Aspect Press, Moscow: 1996. - 275 p.
11. Sadigova S.A. Ways of streamlining terms // Turkology, No. 1, 2011. p. 26-33.
12. Zagorovskaya OV Term and terminology. Voronezh: The Scientific Book, 2011. - 146 p.
13. Huseynov I.M. Selected works. In three parts. Baku: Azerneshr, 1988. -- 236 p.
14. Jafarov M.Z. Our language and terminology. Problems of terminology. Baku: 1984

## STRUCTURAL VARIATIONS OF CHROMOSOME 9

Aytakin Hasanova<sup>1</sup>, Gulara Hasanguliyeva<sup>2</sup>, Beyaz Babayeva<sup>3</sup>

<sup>1</sup>Azerbaijan Medical University. Department of Medical Biology and Genetics. Baku, Azerbaijan

<sup>2,3</sup>Azerbaijan Medical University. I Department of Children's Diseases. Baku, Azerbaijan

### ABSTRACT

Partial trisomy of chromosome 9 has relatively frequently been observed in liveborn subjects. In the majority of the reported cases breaks occur in the centric segment of the long arm (q11-q13). Two characteristics of this chromosome part, i.e. 9qh+ and inv(9), have been studied. The results of a study of selected samples do not support an association between 9qh+ chromosome anomaly and reproductive failure. The frequency of inv(9) in different samples agrees with those reported by other investigators (1.11—2.32%). An excess of male carriers was found. Aneusomy of recombination has been observed in one case.

Partial trisomy of chromosome seems to be the most frequently observed type of unbalanced structural aberration of autosomes in liveborn subjects. Up to now 50 cases have been reported. Three of these have been described as 9q trisomy, the others were 9p trisomies

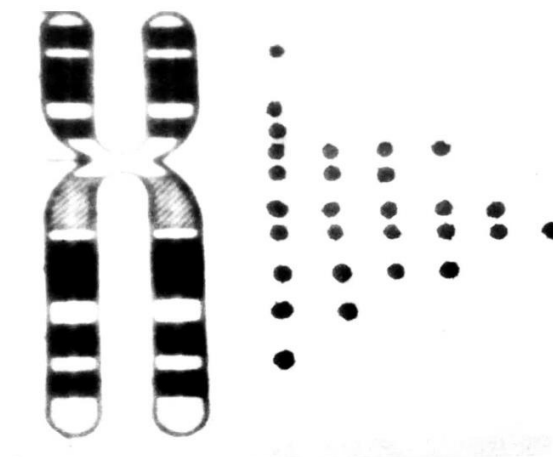

**Fig. 1.** Distribution of the break points on chromosome 9 in cases of partial trisomy. Three cases have been identified as 9q trisomy, twenty-seven cases were 9p trisomy.

(Ramesh et al., Samonte et al., 1996 ;Horvath et al., 2001 ;Senger et al., 1999; Liehr et al., 2002; Park et al. ,1998; Müller-Navia et al.,1995 ). An analysis of the break points in 30 of the reported cases has shown that break mostly occurs in the centric heterochromatin and the adjacent euchromatic band (Fig. 1).

It is surprising that 20 out of the identified cases derived from 3:1 meiotic disjunction. According to a recent study of Verma (1975) one can suppose that the structural abnormality of chromosome 9 promotes failure of segregation due to the shortness of the interstitial segment, i.e. q11—q13. One can also suspect that chiasma forming in the centric heterochromatin can particularly be inhibited for other special reasons.

The observed excess of trisomy for the short arm and centric segment of the long arm may be the result of prenatal selection. Another explanation is that certain points of the long arm, i.e. q11—q13 are especially liable to breakage.





**Fig.2.** Elongation of the centric heterochromatin of chromosome 9 (left) and inversion of the centric heterochromatin of chromosome 9 (right), stained with Giemsa 11.

All these indicate that the heterochromatic part of chromosome 9 must be a remarkable chromosome segment. Some of its characteristics have been discovered in recent years. The composition of the repetitive base sequences in the centric heterochromatin of chromosome 9 has been studied (Mitelman, 1995). There is evidence that this heterochromatin may be active in the first meiosis (Luke et al., 1993). The present paper will deal with two morphologic features, namely variability in size and position (Fig. 2).

#### **SIZE VARIATION OF THE CENTRIC HETEROCHROMATIN OF CHROMOSOME 9**

The DNA content of the centric heterochromatin of chromosome 9—like that of two other autosomes, chromosomes 1 and 16—shows individual variations reflected in the length of the segment in the metaphase. There is no evidence of direct influence of the extreme variants (the very short and the very long segment) on the phenotype of the carriers. On the other hand, some investigators suppose that the extremely elongated centric heterochromatin may cause reproductive failure or can lead to malformed offspring (Verma, 1988).

In four investigated samples we have not found any significant difference in the frequency of elongated centric heterochromatin of chromosomes 1, 9 and 16 (Fig. 3). From these data no connection between the elongation of the centric segments, including that of chromosome 9, and chromosome anomaly or reproductive failure can be established. The discrepancy between our result and that reported by Fryns et al. (1985) is mainly due to the divergent frequency values found in the control groups. More data are needed to reach a definitive conclusion, and in addition, it seems to be necessary to investigate the other extreme variant, the very short centric segment. A decrease of the heterochromatin which probably has a function in meiosis, would have more relevant consequences.

Investigations of subjects with and without elongated centric segments showed that the frequency values of breaks and those of sister chromatid exchanges did not differ from those expected on the basis of the length of the segment (Table 1). We suppose that the reported observations on an excess of breaks and reduplications in several cases with 9qh+ (Macera et al., 1995) can be explained by an individual sensitivity. The other fact worth while mentioning is that all these investigations relating to the fragility of the centric heterochromatin have been carried out with cells from the peripheral blood and the situation may be different in meiosis.

- A: Cytogenetically normal subjects
- B: Subjects with numerical chromosome aberration
- C: Subjects with reproductive failure
- D: Subjects with cytogenetically abnormal offspring

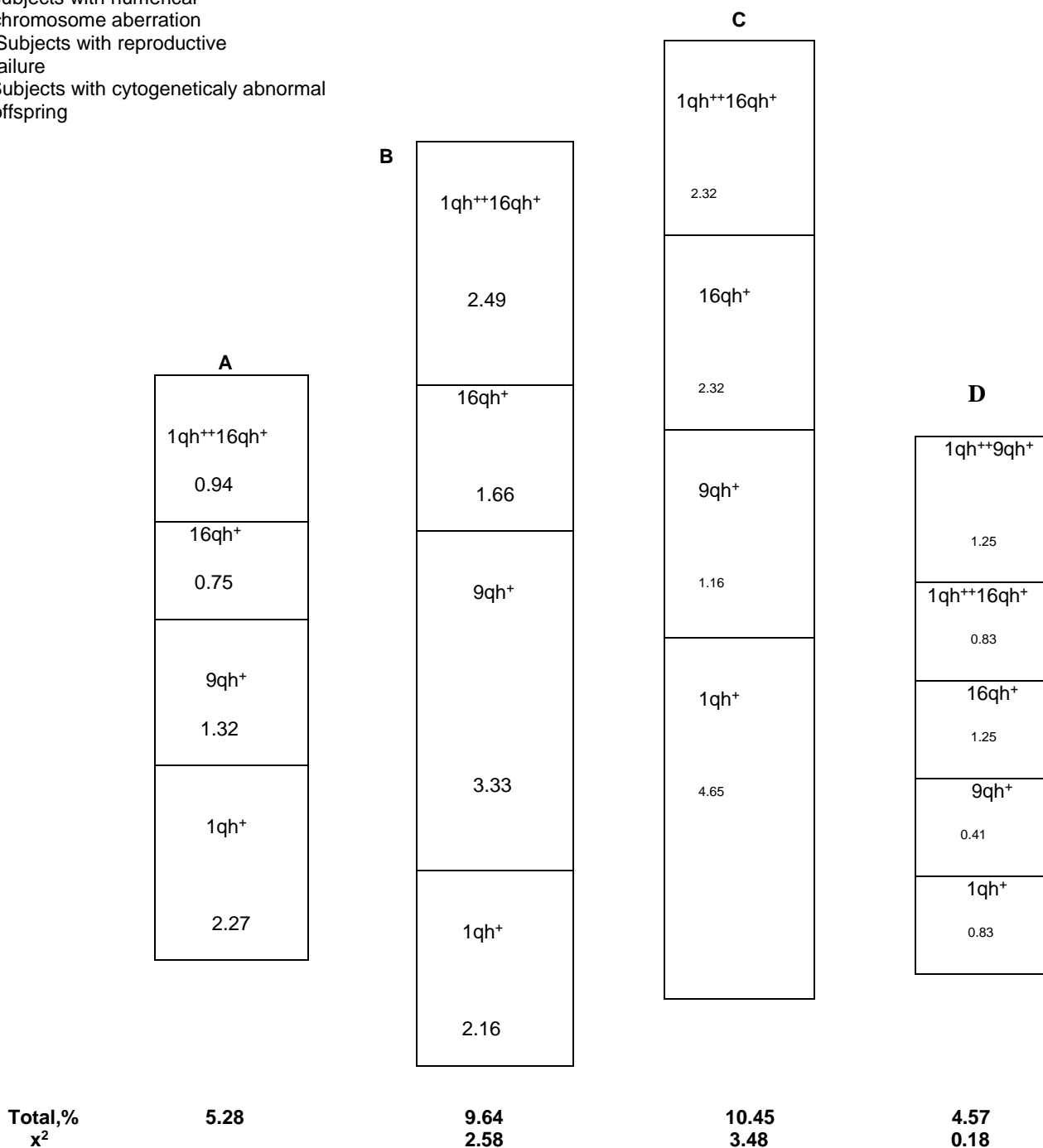

**Fig.3.** Frequency of subjects with elongated centric heterochromatin of chromosomes 1, 9 and 16 in four different samples. Chromosome analysis was made by GAG method.



Fig.4. Abnormal chromosome 9 of a patient whose father has a karyotype 46,XY,inv(9)(p;q)(13;13). Chromosome 9 of a patient can be described as rec(9),dup(qter-q21), del(pter-p21).



Fig.5. The patient with rec(9) when 3 years of age.

#### PERICENTRIC INVERSION OF THE HETEROCHROMATIN OF CHROMOSOME 9

The centric heterochromatin of chromosome 9 is variable in position, too. The frequency values found in three different samples in our study (Table II) are in agreement with those reported by other investigators (Gardner et al., 1996). The relative high frequency of inv(9) observed in all these biased materials might suggest that inv(9) is a simple chromosome polymorphism. At the same time, two observations must be taken into consideration.

The first concerns the sex ratio of the carriers. In our material 13 clinically normal subjects with inv(9) have been ascertained through clinically abnormal offspring and repeated abortions. Eleven were males, two females. A similar sex distribution of carriers has been observed by (Hoo et al., 1993). An opposite sex ratio of clinically normal heterozygotes exists in cases of centric fusion (Table III). The imbalance of the sex ratio in cases of inv(9) may be a chance effect. If it is not, one of the possible explanations is that the development of the female gametes with inv(9) is disturbed.

The second observation that does not allow inv(9) to be regarded as a simple variation is the risk of the offspring. Theoretically, inversion can lead to unbalanced gamete due to the crossing over within the inverted segment. Such anomaly seems to be infrequent in the case of inv(9), but cannot be excluded.

We have recently seen a malformed girl whose father had inv(9). In the karyotype of the child the abnormal chromosome 9 was interpreted as a duplication-deficiency anomaly (Fig. 4). The trisomy for q21-qter and the monosomy for p21-pter have been manifested in mental retardation and some dysmorphic symptoms.

The proposita (Fig. 5) had been born on April 5, 2016 and she was seen for the first time on January 17, 2019. It was difficult to contact her, she took no interest in her surroundings: She was a sad-looking girl, she could not speak and she was not able to stand. She had dolicocephaly, high forehead, flat occiput, slight micrognathia, low set ears, broad-ridged nose and strabismus. Her neck and sternum were short, her hair sparse. Pectus excavatum and bilateral club foot were also observed. She was hospitalized several times due to hyperthermia of unknown origin. She was born to parents who did not practise contraception, in the fifth year of their marriage. This was her mother's first pregnancy. At the time of her birth, her father was 27 years of age and her mother 24. Pregnancy and delivery were uncomplicated, her birth weight was 2,550 g, her length 50 cm. The karyotype of her mother was normal, that of the father 46,XY,inv(9)(p13;q13).



TABLE I

*Frequency of breaks and sister chromatid exchanges in the centric heterochromatin of chromosome 1,9,16*

Subjects	No.of cells inv.	Total	9q00-q13/9q		No.of cells inv.	SCE per cell	1q00-q21/1q		9q00-q13/9q		16q00-q13/16q	
			obs.	exp.			obs.	exp.	obs.	exp.	obs.	exp.
No.1 46,XY,9qh+	400	12	0/0	0.12/0.36	25	4.6	0/4	1.14/4.94	2/4	1.14/3.42	0/0	1.14/2.60
No.2 46,XX,9qh+	400	16	1/1	0.16/0.48								
No.3 46,XX,9qh+,9qh+	200	4	0/0	0.04/0.11								
No.4 46,XX,1qh+,16qh+	400	7	0/0	0.07/0.20	20	5.0	1/5	0.96/4.16	0/2	0.96/2.88	0/0	0.96/2.24
No.5 46,XX	400	11	0/0	0.12/0.36								
No.6 46,XY	400	8	0/1	0.08/0.23	30	6.0	1/7	1.80/5.22	3/4	1.80/5.22	2/3	1.80/4.06

**TABLE II**

Frequency of inv(9) in three different samples

Subjects	Total	Males		Total	Females		Total	Males+ Females	
		inv(9)			inv(9)			inv(9)	
		No.	%		No.	%		No.	%
Malformed subjects	332	2	0.60	308	6	1.94	640	8	1.25
Subjects with reproductive failure	43	1	2.32	43	1	2.32	86	2	2.32
Parents of subjects with chromosome anomaly [excl.inv(9)]	136	2	1.47	134	1	0.74	270	3	1.11

**TABLE III**

Carriers of inv(9) and centric fusion ascertained by clinically abnormal off springs and reproductive failure, respectively

Patients with malformation syndrome	Karyotype examined		Reproductive failure	Karyotype examined	
	Mother	Father		Wife	Husband
46,XX,inv(9)	N	inv(9) pat	5 abortions within 5 years	N	inv(9) pat
46,XX,inv(9)	N	inv(9)	3 abortions within 4years	inv(9)	N
46,XX,inv(9)	N	inv(9)			
46,XX,inv(9)	inv(9)	N			
46,XX,rec(9),dup q	N	inv(9)			
45,X,inv(9)	N	inv(9)			
46,XY,inv(9)	N	inv(9)			
46,XY,inv(9)	inv(9)	N			
46,XX,del(5//p15)	N	inv(9)			
46,XY,del(18)q(21)	N	inv(9)			
47,XY,+mar	N	inv(9)			
45,XY,t(13q14q)	N	t(13q14q)	3 abortions within 2 years	t(13q14q)	N
45,XX,t(13q14q)	t(13q14q)	N	4 abortions within 4years	t(14q15q)	N
46,XY,t(14q21q)	(14q21q)	N	3 abortions and 3 stillbirths within 8 years	t(13q14q)	not inv.
46,XX,t(14q21q)	(14q21q)	N			

It is also possible that chromosomal interaction may cause cytogenetic anomaly, thus meaning additional risk for the offspring of a carrier. Several cases have been reported in the literature where mutation occurred in the gametes of a parent who already carried a chromosome rearrangement. Inv(9) together with other chromosome anomaly was found by Horvath et al. (2001) and in one case [45,X,inv(9)pat, see in Table III] in our material. However, our knowledge is too limited to judge whether there is a chance association or a causal relationship in these cases. This problem, like the others related to the “minor anomalies” of the human chromosomes, will be answered by further studies.

## REFERENCES

1. Verma RS . A reply: pericentric inversion of chromosome 9qh are ‘real’ but the mechanisms of their origin are highly complex *Hum Genet* 1999 **105**: 183–184
2. Verma RS . *Heterochromatin molecular and structural aspects* New York: Cambridge University Press 1988 pp 276–299
3. Mitelman F . *ISCN 1995: An international system for human cytogenetic nomenclature* Basel: S. Karger 1995 pp 1–115
4. Gardner RJM, Sutherland GR . Chromosome abnormalities and genetic counseling In: *Oxford monographs on medical genetics No. 29* New York and Oxford: Oxford University Press 1996 pp 139–158
5. Macera MJ, Verma RS, Conte RA, Bialer MG, Klein VR . Mechanisms of the origin of a G-positive band within the secondary constriction region of human chromosome 9 *Cytogenet Cell Genet* 1995 **69**: 235–239
6. Ramesh KH, Verma RS . Breakpoints in alpha, beta, and satellite III DNA sequences of chromosome 9 result in a variety of pericentric inversions *J Med Genet* 1996 **33**: 395–398
7. Samonte RV, Conte RA, Ramesh KH, Verma RS . Molecular cytogenetic characterization of breakpoints involving pericentric inversions of human chromosome 9 *Hum Genet* 1996 **98**: 576–580
8. Horvath JE, Bailey JA, Locke DP, Eichler EE . Lessons from the human genome: transitions between euchromatin and heterochromatin *Hum Mol Genet* 2001 **10**: 2215–2223
9. Senger G, Weimer J, Claussen U, Chuboda I . Microdissection and reverse chromosome painting In: Wegner RD (ed) *Diagnostic Cytogenetics; Springer Lab Manual* Heidelberg: Springer Verlag 1999 pp 356–375
10. Liehr T, Heller A, Starke H, Rubtsov N, Trifonov V, Mrasek K, Weise A, Kuechler A, Claussen U . Microdissection based high resolution multicolor banding for all 24 human chromosomes *Int J Mol Med* 2002 **9**: 335–339
11. Park JP, Wojiski SA, Spellman RA, Rhodes CH, Mohandes TK . Human chromosome 9 pericentric homologies: implications for chromosome 9 heteromorphisms *Cytogenet Cell Genet* 1998 **82**: 192–194
12. Müller-Navia J, Nebel A, Schleiermacher E . Complete and precise characterization of marker chromosomes by application of microdissection in prenatal diagnosis *Hum Genet* 1995 **96**: 661–667
13. Luke S, Verma RS . Genetic consequences of ‘euchromatic’ band within 9qh region *Am J Med Genet* 1993 **45**: 107
14. Hoo JJ, Szego K, Wong P, Roland B . Evidence of chromosome 9 origin of the euchromatic variant band within 9qh *Clin Genet* 1993 **43**: 309–311
15. Fryns JP, Kleczkowska A, Londers L, van den Berghe H . Unusual chromosome 9 polymorphism and reproductive failure *Ann Genet* 1985 **28**: 49–51

## TELEMETRY APPROACH BY CANSAT DESIGN

Muhammet İkbāl<sup>1</sup>, Aliew, Fuad<sup>2</sup>

<sup>1</sup>Electronic Engineering Department, Gebze Technical University, Turkey.

<sup>2</sup>Electronic Engineering Department, Gebze Technical University, Turkey.

E-mail: <sup>1</sup>mielek@gtu.edu.tr; <sup>2</sup>aliew@gtu.edu.tr

### ABSTRACT

This paper provides an overview for Cansat, auto-gyro and telemetry design. The cansat is developed with an auto-gyro descent system. Additionally, cansat includes a camera and its stabilization system. It is launched by the help of a model solid fuel rocket with a pyrotechnical detachment system.

**Keywords:** Cansat, Auto-gyro, Telemetry

### Concept

Cansat project is based on an idea that provides students to improve their skills on a multidisciplinary satellite mission. Cansat is typically launched to an altitude of 1 km. This flight usually takes around 2.5 minutes. Auto-gyro is used to slow down the descent to 10-15 m/s. A container is used to protect the payload from the stresses inside the model rocket. Payload is the main satellite which includes sensors and microprocessor.

### Cansat launcher

Cansat launcher can be a model rocket, UAV's, helicopters or basically anything that can reach the designated altitude and can carry around 500 grams. For testing a UAV is a more dependable and inexpensive way. We mostly used UAV's and model rockets with parachutes and pyrotechnical detachment systems because of them being the most secure solutions.

### Structure

Structure includes container and payload. For general structure we have used carbonfiber rods and 3D printed ABS.

### Container

Container is Cansat's outer shell that is 30.5 cm long cylinder with a diameter of 12.5 cm including parachute and parachute opening system. It protects the payload from hazards inside and outside the launcher. This subsystem includes a spherical parachute to slow it down to 15-20 m/s and detachment mechanism for payload and container. Cansat's outer shell is a 30.5 cm long cylinder with a diameter of 12.5 cm including parachute and parachute opening system.

Parachute made from Ripstop Nylon that has 11 cm diameters. It has a small hole in the middle to balance stabilization and increase friction with air. While Cansat is in the descending state, the air flow through the holes in the parachute section prevents the payload from tumbling. In addition, the spill-hole at the top of the parachute helps us to avoid tumbling and allows the payload to stabilize.

The concept of release mechanism system is that when the container and the science payload start to fall, the airflow cavities direct the air towards the middle of the main parachute creating higher pressure inside. Then that pressure is used to bust the cut paper open deploying the smaller parachute. Which in turn deploys the main parachute.

### Payload

The payload is the main part of the Cansat. It transmits telemetry, which includes sensors to track altitude using air pressure, external temperature, battery voltage, GPS position, pitch and roll and auto-gyro/ passive helicopter recovery blade spin rate. Due to the low power consumption and efficient design in optimized conditions, we choose single rotor with airfoil for the auto-gyro system.

Payload consist of ABS 3D printed discs connecting with carbon fiber epoxy rods. It is attached to the container with three ring release mechanism that is operated by servo motor. The Payload is powered with 8.4 Batteries are connected as parallel. In this way, we can obtain double battery life. Many components are connected to regulator to supply current efficiently. Switch is located on an accesible place.

A camera is placed on a rotatable part within the camera hub in payload. This rotatable part is where the rotational stabilization occurs and it is connected to the lower servo via a slipping to ensure that the wires don't get winded up when the servo turns.

### Flight Software

C++ language is used as programming language. Visual Basic, Arduino IDE, XCTU DIE are used as development environments. Necessary raw data is received from various sensors and sent to MCU. Through telemetry, the data packages are sent to the ground station via XBEE radios. Electronic circuits are designed on breadboard. Each sensor is tested individually with Arduino and Serial Monitor and telemetry data is sent with XBee Radio Module to computer.

If any complication occurs which ends with system reset during the flight, here is the method for the recovery: Every data is going to be saved to SD card during the flight, and state data is going to be changed with every milestone check. If any reset occurs, the system will start over and go to the last saved state, then continue the flow from that state.

### Indentations and Equations

#### Auto-Gyro Descent Speed Calculations

$$\sigma = \frac{\text{BladeArea}}{\text{DiscArea}} = \frac{NRc}{\pi R^2} \quad (1)$$

$$C_L = \sigma \left( \frac{Rc}{R} \right)^3 \pi \left( \frac{\theta}{3} + \sqrt{\left( \frac{\theta}{3} \right)^2 + \frac{C_d}{4\pi}} \right) \quad (2)$$

$$W = mg \quad (3)$$

$N$  – Number of Blade

$R$  – Blade Radius

$c$  – Chord

$\theta$  – Angle of Attack

$C_d$  – Drag Coefficient

$V$  – Descent Speed

$C_l$  – Lift Coefficient

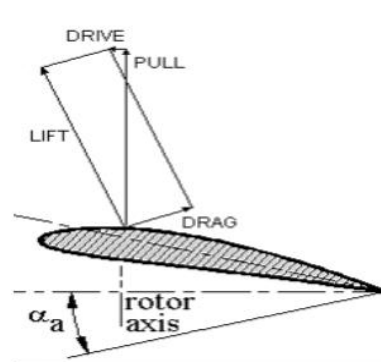

$$C_L = 0.095 * 0.0973 * \pi \left( \frac{\theta}{3} + \sqrt{\left( \frac{3}{3} \right)^2 + \frac{0.012}{4\pi}} \right) = 0.548477$$

According to blades angle of attack, radius and count of blades coefficient lift is:  $C_L = 0.548477$

$Rc/R = 0.97$

$R = 0.17975$  meters

$m = 0.420$  kg

$c = 0.27$  meters

$C_d = 0.012$

$\rho = 1.16$

$g = .80665$

$N = 2$



$$Dia = \sqrt{\frac{4 S}{\pi}} \quad [2]$$

1. The coefficient lift is calculated according to the shape and length of the wing.
  2. The coefficient is found in the KwBl equation.
  3. Kz0 is calculated using KwBl. 4. Vsink (Descent Rate) and rotational speed are calculated with the calculated values.
- [1]

$FR = 0.420 \text{ kg} \cdot 9.80665 \text{ m/s}^2 = 4.12 \text{ N}$	Rotor Force
$\rho = 1.16 \text{ kg/m}^3$	Air density
$tBl = 0.027 \text{ m}$	Blade Chord
$rR = 0.18$	Rotor Radius
$nGl = 5$	Airfoil lift-drag ratio
$\epsilon Bl = -5\sigma = -0,087266 \text{ rad}$	Mean Blade incidence angle
$CABl0 = 0.548477$	Lift Coefficient at 30 angle of attack
$KwRi \approx 0.86$	

$$Kz0 = 0.418642$$

$$KwBl = 0.133336$$

**With these data we estimate a sink rate of:**

$$V_{sink} \approx 10.649 \text{ m/s}$$

$$FR \approx 4.12 \text{ N} \quad nR \approx 2215 \text{ rpm}$$

The rotor rotational speed is:  $nR \approx 2215 \text{ rpm}$

#### A) Payload Landing Calculations with Parachute

$$S = \frac{2mg}{\rho CDV^2} \quad \text{Parachute Size} \quad (4)$$

$$\text{Diameter For Parachute} \quad (5)$$

According to the average air temperature in Texas, air density was determined :

$$\rho = 1.16 \text{ kg/m}^3$$

Weight of container and science payload:

$$\text{Mass} = 0,5 \text{ kg}$$

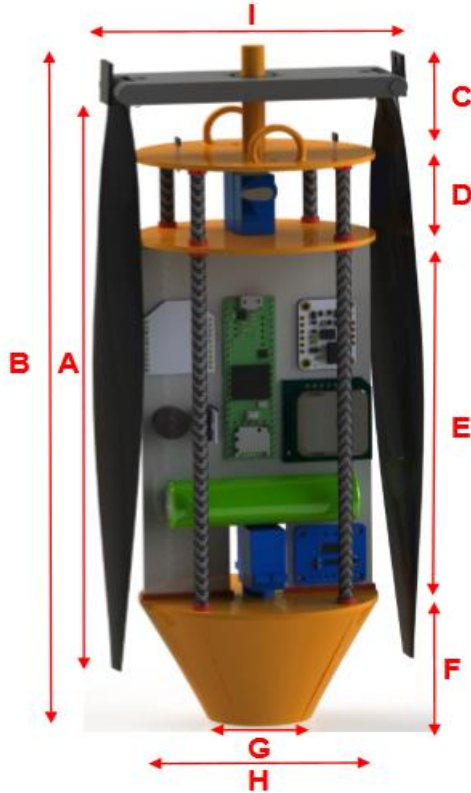

Estimated drag coefficient:

$$C_d = 1,5 \text{ (for elliptical parachute)}$$

$$g = 9,80665 \text{ m/s}^2$$

$$V = 15 \text{ m/s}$$

The radius calculated according to descent speed:

$$R_{\text{total}} = 0.12 \text{ m} \quad R_{\text{hole}} = 0.03 \text{ m}$$

The parachute radius for this parachute is 0.09 m.

#### B) Container Landing Calculations with Parachute

Weight of container:

$$\text{Mass} = 0.08 \text{ kg}$$

$$W = mg = 0.08 \text{ kg} * 9.80665 \frac{\text{m}}{\text{s}^2} = 0.784 \text{ N}$$

$$S = \pi r^2 = 0.0250 \text{ m}^2$$

$$V = \sqrt{\frac{2mg}{\rho C_d S}} = 6.00 \text{ m/s}$$

Container descent speed is **6 m/s**

**Figures and Tables**  
**General Dimensions of the Container**

Letter	Dimension
A	180 mm
B	254.6 mm
C	50 mm
D	30.6 mm
E	139 mm
F	45 mm
G	36 mm
H	82.5 mm
I	100.16 mm

**Figure 1. Payload Dimensions**

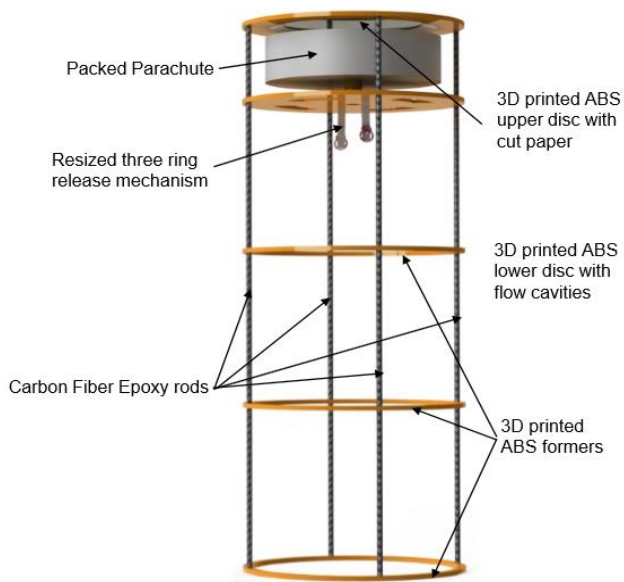

**Figure 2. Container**

## CONCLUSION

The CanSat program provides students to get hands-on experience in a space-related project. It is a great opportunity for the students to get experience from conceptual design, through integration and test, the actual operation of the system. One of the major advantages of the CanSat is that students can be a part of a multidisciplinary project. Thus, it simulates the real-life job experiences and students can actually see the field that they want to work by working on it.

GTU-SAT Team (2018-2019)  
Muhammet İkbal ELEK (Team Leader)  
Fuad ALIEW (Faculty Advisor)  
Eda Nur Hepgöl  
Muhammed Altuntaş  
Nida Korsan  
Şeyma Kurt  
Ömer Emre Polat  
Doğan Can Cirit  
Taha Kavlak  
Berkay Öncü

## REFERENCES

1. Dr-Ing.Holger Duda, Flugphysik der Tragschrauber
2. [Dhttp://airfoiltools.com/airfoil/details?airfoil = e220-il](http://airfoiltools.com/airfoil/details?airfoil=e220-il)

## ONE COMPLICATED CASE OF THROMBOTIC MICROANGIOPATHY

Guliko Kiliptari <sup>1</sup>Merab Sutidze<sup>2</sup>

<sup>1</sup>Head of Critical Care Department of University Clinic after N.Kipshidze. MD, PhD.,Prof.of TSMU (Tbilisi, Georgia).

<sup>2</sup>Head of Neurology Department of University Clinic after acad. Kipshidze.prof. (Tbilisi, Georgia).

Email: gulikiliptari@yahoo.com

### ABSTRACT

#### INTRODUCTION

HUS and TTP is syndroms ,characterized with microangiopathic hemolytic anemia , thrombocytopenia , acute renal failure ,severe neurological violations .Bloody diarrhea is caused with E.Coli(0157:H7).In Georgia revealed other strain –E.coli(0104:H4).We presented case when illness started with bloody diarrhea, oliguria and neurological changing( coma , seizures).. ADAMTS13 levels < 10% with the presence of antibody against ADAMTS13 is characteristic of most adults with TTP and these patients respond to plasma exchange. Testing for ADAMTS13 activity is appropriate in patients with suspected TTP-HUS,. The combination of clinical and laboratory data, activity of ADAMTS13, and response to plasma exchange allows for better differentiation between these thrombotic microangiopathies, which itself is very important considering that both have different treatment options. Thrombotic microangiopathies are diseases characterized by thrombocytopenia, erythrocyte fragmentation, and elevated levels of LDH. Thickening of the arterioles and capillary walls with prominent endothelial swelling and detachment and subendothelial accumulation of proteins and cell debris characterize and define the pathologic lesion seen in all thrombotic microangiopathies . In patients with TTP, severely deficient ADAMTS13 activity has been seen in 25–79% of cases at presentation whereas HUS is not associated with any reduction in activity or absence of ADAMTS13. Patient admitted in hospital after one week from onset of clinical symptoms. Regardless of bacteriological investigations of feces, the microb does not revealed. Progress of disease was severe, with many complication:renal failure with severest neurological violations. Unconsciousness was manifested after hospitalization with generalized seizures.MRI was revealed temporal and parietal cortex damage, later left ischemic damage of left subcortical nodes, what probably was the reason of seizures. LDH and haptoglobin level was referred microangiopathic haemolysis. In the smears of peripheral blood was observed erythrocyte fragmentation. Platelets counts was mildly decreased, FDP increased (D dimer also increased).Therefore genesis of renal failure and coma was thrombotic microangiopathy and other accompanying causes. In this patient, despite such extensive involvement of the CNS, ADAMTS13 activity was not inadequate, the treatment was effective.

#### CONCLUSION

The manifestation of this syndrome sometimes is atypical. We presented the case, when the disease started with bloody diarrhea, vomiting .By fecal bacteriological analysis microbes has not been identified. The adequate assessment of clinical signs in premorbid period, adequate exploration of organ dysfunction, using diagnostic methods after hospitalization and appropriate treatment gives the real chance to convalescence

**Keywords:** HUS, renal replacement therapy, coma, vena cava thrombosis.

#### INTRODUCTION

HUS and TTP is syndroms, characterized with microangiopathic hemolytic anemia, thrombocytopenia, acute renal failure, severe neurological violations .Bloody diarrhea is caused with E.Coli(0157:H7). In Georgia revealed other strain –E. coli (0104:H4).We presented case when illness started with bloody diarrhea, oliguria and neurological changing (coma, seizures).. ADAMTS13 levels < 10% with the presence of antibody against ADAMTS13 is characteristic of most adults with TTP and these patients respond to plasma exchange. Testing for ADAMTS13 activity is appropriate in patients with suspected TTP-HUS,. The combination of clinical and laboratory data, activity of ADAMTS13, and response to plasma exchange allows for better differentiation between these thrombotic microangiopathies, which itself is very important considering that both have different treatment options. Thrombotic microangiopathies are diseases characterized by thrombocytopenia, erythrocyte fragmentation, and elevated levels of LDH. Thickening of the arterioles and capillary walls with prominent endothelial swelling and detachment and subendothelial accumulation of proteins and cell debris characterize and define the pathologic lesion seen in all thrombotic microangiopathies. In patients with TTP, severely deficient ADAMTS13 activity has been seen in 25–79% of cases at presentation whereas HUS is not associated with any reduction in activity or absence of ADAMTS13. Patient admitted in hospital after one week from onset of clinical

symptoms. Regardless of bacteriological investigations of feces, the microb does not revealed. Progress of disease was severe, with many complication: renal failure with severest neurological violations.

**CASE**

32 yrs old women was admitted in ICU with oligoanuria, chills. Diseases started with diarrhea, vomiting, abdominal pain, oliguria, fever. Changes of awareness revealed after generalised seizures. Patient was intubated and started artificial ventilation. Brain CT scan revealed ventricles dilatation, without dislocation of midline structures. After episodes of focal seizures treatment was started with carbamazepin (400mg per day). On EEG revealed generalised, spike slow wave activity (Picture 1)

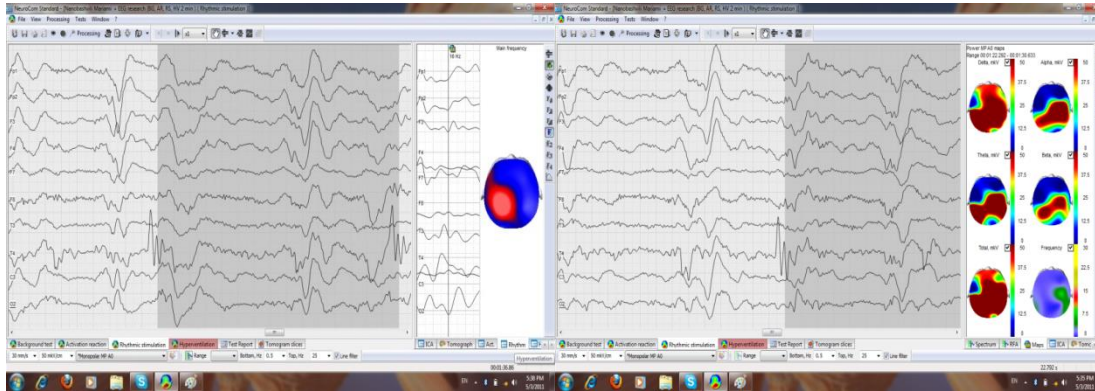

Picture 1 EEG

MRI detected (Flair mode)—cortex damage of left temporal—occipital area (Picture 2), Lumbar aspirate—protein—0.48g/l, leucocytes—7/mm<sup>3</sup>, lymph—68%, neutrophils—32%. In lumbar aspirate was detected HSV 1 vires. After treatment with aciclovir and repeated investigation of lumbar aspirate, HSV 1 vires was not found. Antibacterial treatment was based on bacteriological investigations and suitable antibacterial therapy.

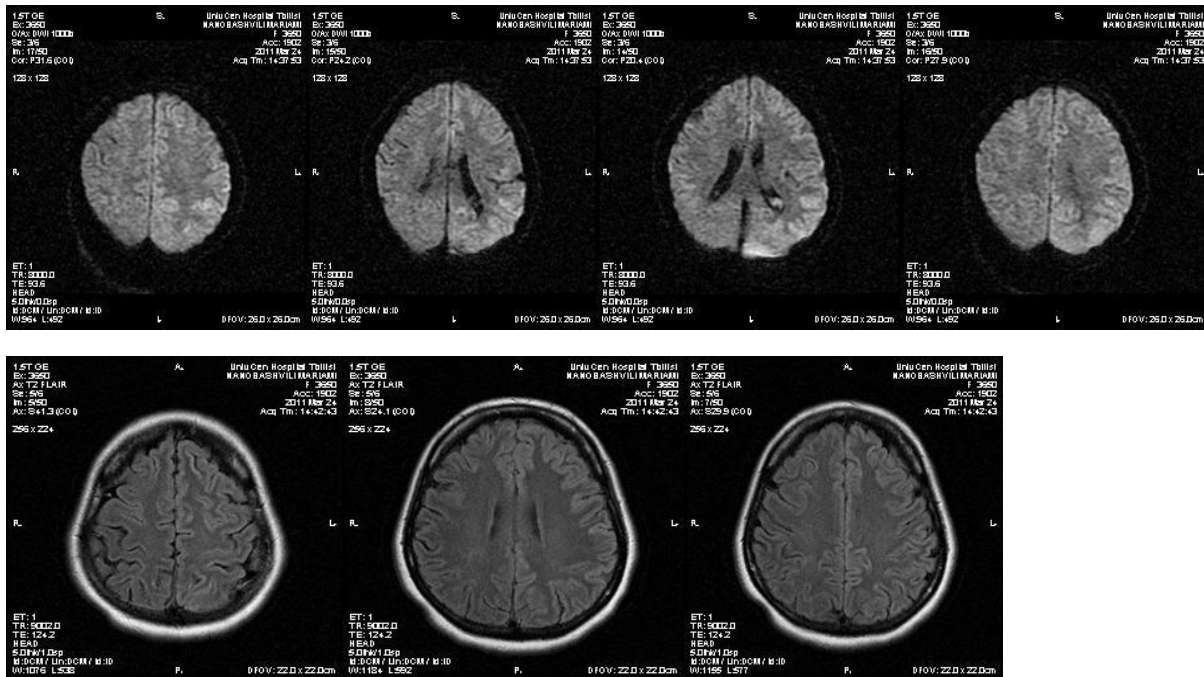

Picture 2. Brain MRI

At first creatinine, LDH and urea level was high (6.72mg/dl, 198 mg/dl, 3916 u/l). After renal biopsy was found 20 glomerulus, in 9 glomerulus was discovered necrotic changing (focal cortical necrosis), in 5 glomerulus --- complex replication of basement

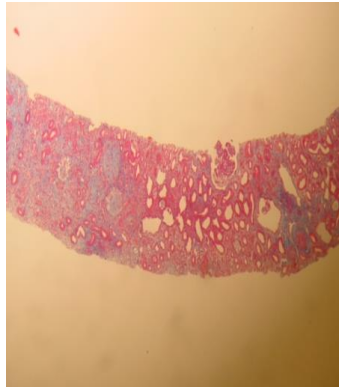

Picture 3

Membrane and enlargement of mesangial matrix (Picture 3,4 )

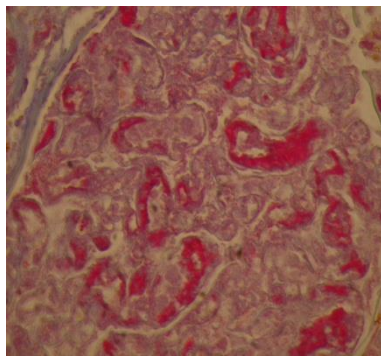

Picture 3. Renal biopsy material

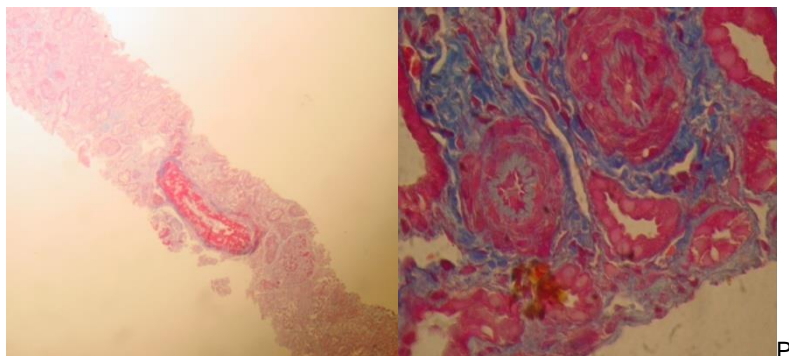

Picture 4. Renal biopsy material

In preglomerular arterioles revealed fibrosis of intima, thrombus into lumen and arterial-arterioles sclerosis. 35% of tubules was necrosed (focal cortical necrosis), remaining part was atrophic with thickening of basament membrane. (Picture 5)

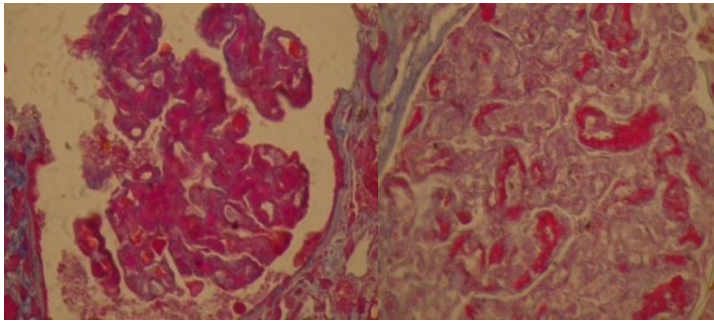

Pict.5 Renal biopsy material

In arterial walls and focal glomerulus was found fibrin/ fibrinogen deposits (Picture 3,4,5). ADAMTS-13 activity was normal –64.9% (N40-130), ADAMTS -13 antigen was 0.46u/ml, slightly decreased, and antibody was not found. ADAMTS inhibitor –3.5 u/ml(N<12u/l)

At first platelets count was decreased—80000/mm<sup>3</sup>, then platelets count returned to normal value. Immunity parameters was normal(schedule1)

CD3 lymphocytes—65%	IgG 14.3g/l(N8-18)
CD4 lymphocytes –45%(N29-57)	IgA 3.4g/l(N 0.9-2.5)
CD4—abs.number—1431(N404—1612)	IgM—0.2g/l(N0.6—2.8)
CD8lymphocytes—20%(N11-38)	IgE—9.19 g/l (N<200)

#### Schedule 1 Immunological tests

Antinuclear antibody was not found. In peripheral blood revealed leucocytosis: white blood cell count--41000/mm<sup>3</sup>, anisocytosis, shisocytosis, poikilocytosis, Neutrophils count 31.4mg/d l

Secondary coagulation hemostasis was changed: decreased antithrombin III, increased soluble fibrin-monomer complex(sched.2)

FDP --21mg%	AT-III----70%
D-dimer 9000 ng/ml(<500ng/ml)	

#### Schedule 2 Tests of coagulation hemostasis

Chest CT scan ---detected pneumonia, abdominal CT scan---fluid accumulation. Brain MRI—detected (T2, Flair) is chemic damage in left subcortical nodes. (Picture 6)



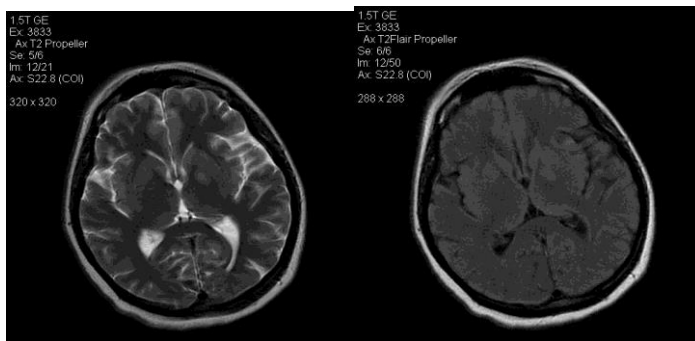
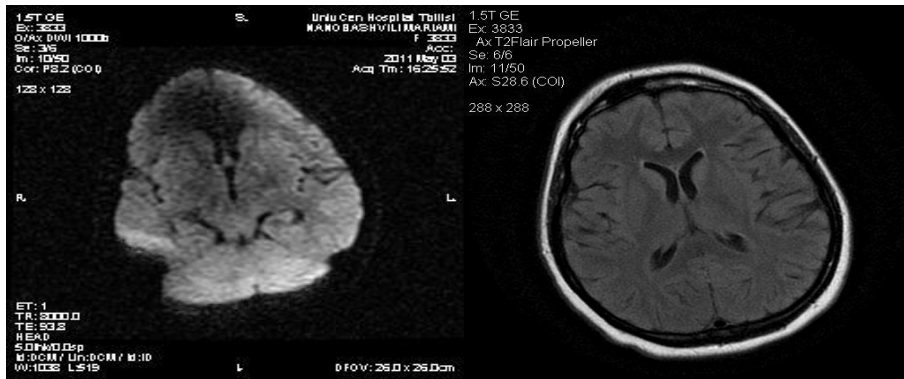

Picture 6

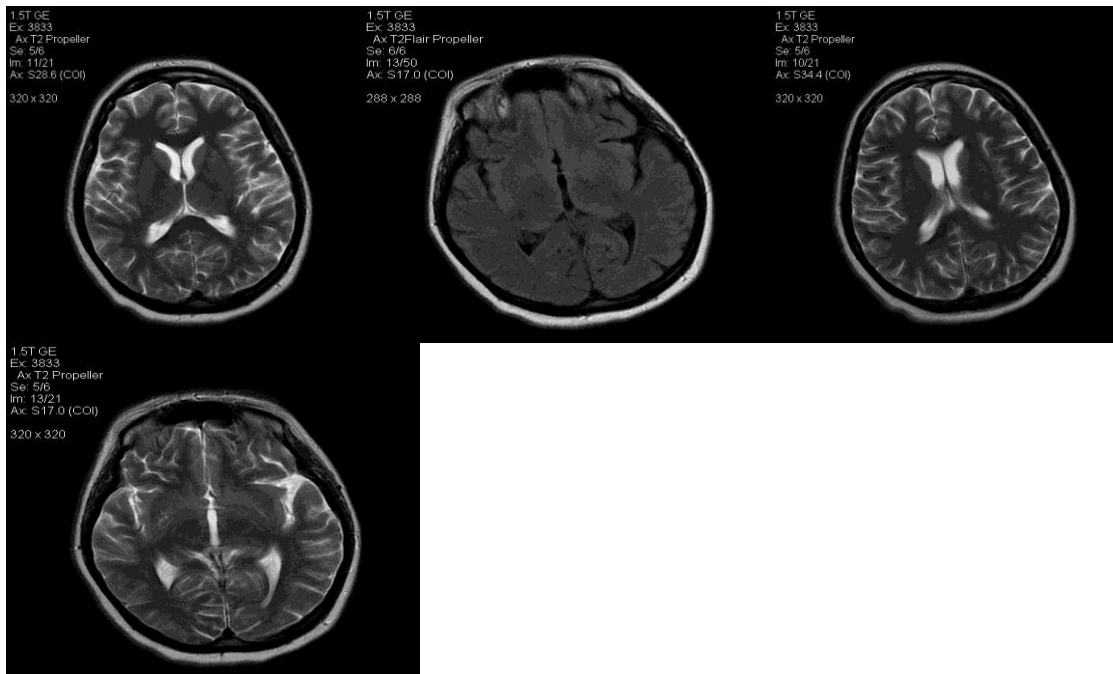

Picture 6 Brain MRI

EEG—detected low amplitude waves, without specific pathological activity (pict7)

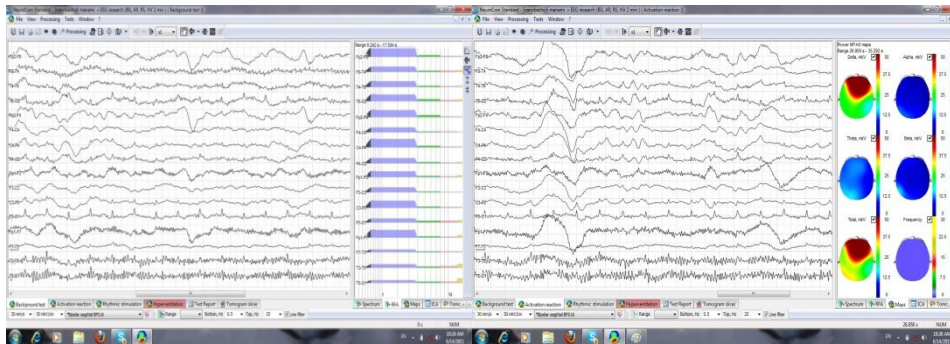

Picture 7 EEG

After 35 day from hospitalization neurological state improved, awareness was adequate, without cognitive violations. Lasted renal replacement therapy. Chest CT scan (Picture 8) detected improvement of lung radiological findings.

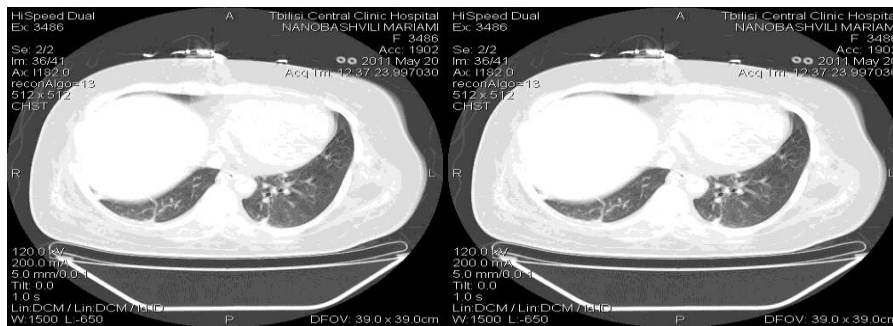

Pict8. Chest CT scan

Patient was extubated, parameters of spontaneous breathing was normal. After one weak revealed abdominal distension, vomiting. Abdomen CT scan and angiography was found bowel distension, dynamic obstruction and excluded mezenteric thrombosis. (Picture 9)

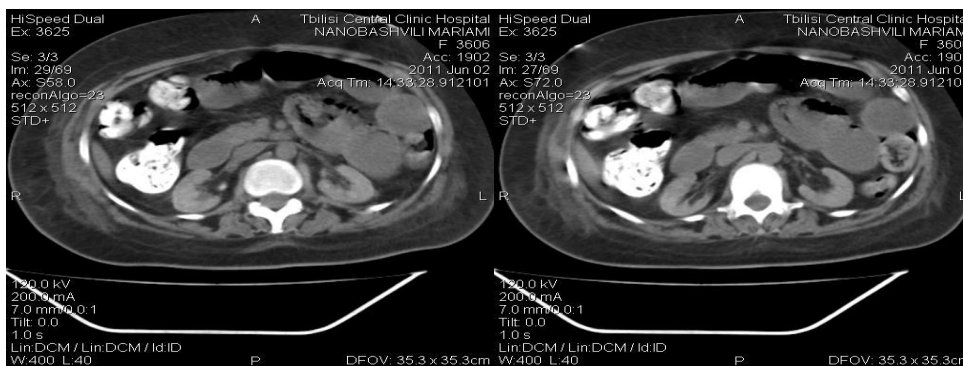

Pict9. Abdomen CT scan

Later patient state was aggravated, developed acute respiratory failure. Chest CT scan detected bilateral pneumonia (Picture 10)

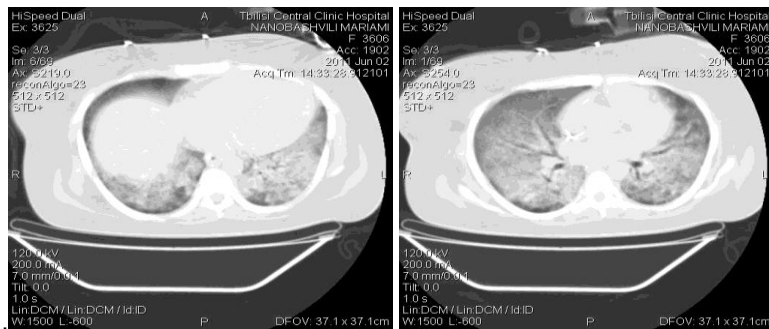

Pict10. Chest CT scan

Low extremity vessels ultrasonography revealed thrombus in common femoral, deep femoral vein. Despite suitable treatment, m.hg). Low extremity vessels ultrasonography revealed thrombus in left external iliac and great saphenous vein. After cavagrophy in vena cava bifurcation area detected filling defects-thrombus --8.2X16.8. and 6.7X 20.8 (pict 11). In infrarenal part of inferior vena cava was performed placement of vena cava filter(Vena Teech LP,B.Braun Medical )

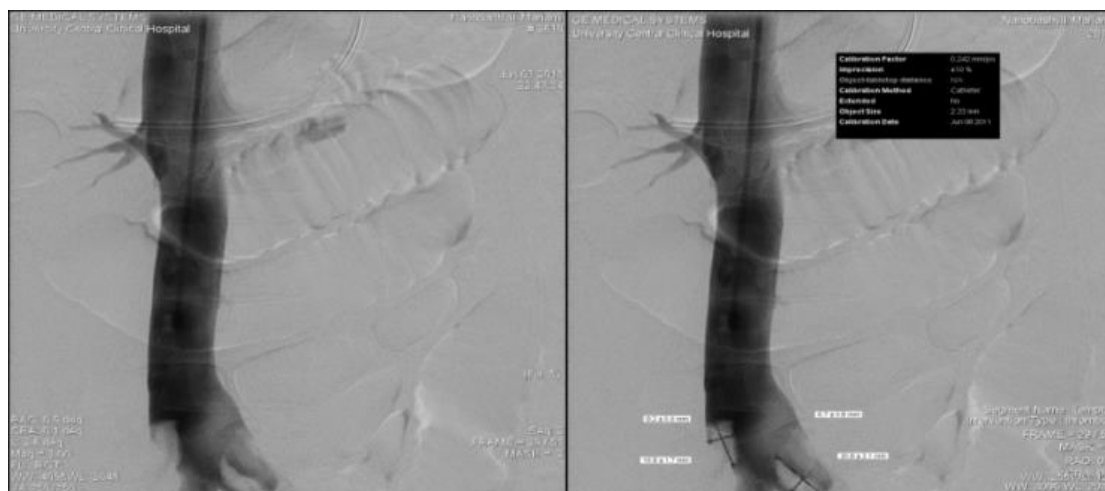

Pict 11.Cavagrophy. Placement of filter

Regardless of suitable treatment developed severe obstructive shock.

**Discussion:** disease started with bloody diarrhea, vomiting. After 7 day from onset patient was admitted in hospital. Identification of microb was not possible with Feces bacteriological analysis. Diagnosis was based on results of renal biopsy and morphological researches, laboratory and clinical parameters. Unconsciousness and right side hemiparesis eveled after seizures. MRI detected left side subcortical nodes ischemic damage. In lumbar aspirate by PCR method detected vires (HSV1).Patient was treated with antiviral drugs (ZOVIRAX),For treatment of sepsis was identified source of infection (pneumonia,VAP). LDH level was high, Haptoglobin level was decreased ,what referred to microangiopathic hemolysis .In peripheral blood smear revealed red blood cells fragmentation ,reduction of platelet count .D dimer and FDP level was increased. After renal biopsy,in arterial wall and in glomerulrs was found fibrin/fibrinogen deposits. Reason of renal failure was thrombic microangiopathy,activation of platelets after endothelium damage and activation of coagulation hemostasis. In several glomerulus detected 35% necrosed tubules and remainig part of tubuls was atrophic. Patient was treated with renal replacement therapy, plasma exchange therapy. Causes of coma was thrombic microangiopathy, also accompanying reasons.For prevention of thrombosis was used anticoagulation ,nevertheless developed DVT, pulmonary embolizm , low vena cava thrombosis. Establishing the diagnosis of TTP / HUS was a 2-step process: verifying the presence of triad of microangiopathic hemolytic anemia and thrombocytopenia, excluding systemic/secondary conditions that would cause this changings. In HUS, an antecedent history of diarrheal illness was presented. Clinical differentiation of hemolytic-uremic syndrome (HUS) and TTP is often

based on the presence of CNS involvement in TTP and the more severe renal involvement in HUS. Level of ADAMTS13 activity was nondeficient. Patients with TTP have either an inherited or an acquired lack of this protease activity whereas those with HUS do not have an abnormality of the enzyme. This patient despite so wide involvement of CNS, ADAMTS13 activity was not deficient. Among other causes, disseminated intravascular coagulation could also cause microangiopathic hemolytic anemia and thrombocytopenia, but it was distinguished by laboratory results.

## CONCLUSION

We presented the case, when the disease started with bloody diarrhea, vomiting. By fecal bacteriological analysis microbes has not been identified. Unconsciousness manifested after hospitalization with generalized seizures. MRI revealed temporal and parietal cortex damage, later left ischemic damage of left subcortical nodes, what probably was the reason of seizures. LDH and haptoglobin level referred microangiopathic haemolysis. In the smears of peripheral blood was observed erythrocyte fragmentation. Platelets counts was mildly decreased. FDP increased (D dimer also increased). Therefore genesis of renal failure and coma was thrombotic microangiopathy and other accompanying causes. In this patient, despite such extensive involvement of the CNS, ADAMTS13 activity was not inadequate, the treatment was effective, including plasma exchange, what suggested that the patient had HUS. The manifestation of this syndrome sometimes is atypical. The adequate assessment of clinical signs in premonitory period, adequate exploration of organ dysfunction, using diagnostic methods after hospitalization and appropriate treatment gives the real chance to convalescence.

## ЗАКЛЮЧЕНИЕ

Мы представили случай, когда заболевание начиналось с кровавой диареей, рвоты. По фекальным бактериологическим анализам микробов не выявлено. Бессознательное состояние проявляется после госпитализации с генерализованными припадками. МРТ выявила повреждения височной и теменной коры, затем левое ишемическое повреждение левых подкорковых узлов, что, вероятно, явилось причиной судорог. Уровень ЛДГ и гаптоглобина отражается на микроангиопатическом гемолизе. В мазках периферической крови наблюдалась фрагментация эритроцитов. Количество тромбоцитов было незначительно снижено. Увеличился ПДФД (также увеличился Д димер). Поэтому генезом почечной недостаточности и комы была тромботическая микроангиопатия и другие сопутствующие причины. У этого пациента, несмотря на такое обширное вовлечение ЦНС, активность ADAMTS13 ADAM не была недостаточной, лечение было эффективным, включая обмен плазмы, что указывало на то, что у пациента был ГУС. Проявление этого синдрома иногда бывает нетипичным. Адекватная оценка клинических признаков в преморбидном периоде, адекватное исследование дисфункции органов, использование диагностических методов после госпитализации и соответствующего лечения дает реальную возможность выздоровления.

## REFERENCES

1. Atypical Hemolytic-Uremic Syndrome: A Case Report and Literature Review
2. Arsalan Rafiq,<sup>A,B,C,D,E,F</sup> Hassan Tariq,<sup>A,B,C,E,F</sup> Naeem Abbas,<sup>E,F</sup> and Roopalekha Shenoy<sup>A,E</sup>, Am J Case Rep. 2015; 16: 109–114. Published online 2015 Feb 24. doi: 10.12659/AJCR.892907
3. Anti-Factor H Autoantibody–Associated Hemolytic Uremic Syndrome: Review of Literature of the Autoimmune Form of HUS. Marie-Agnes Dragon-Durey, Caroline Blanc, Nature reviews Nephrology 8, 622–633, November 2012, doi:10.1038/neph.2012.
4. Platelet count and prothrombin time help distinguish thrombotic thrombocytopenic purpura-hemolytic uremic syndrome from DIC in adults. PARK IA-AM j Clin Pathol-01-MAR-2010;133(3):460-5
5. Therapeutic plasma exchange in patients with TTP-HUS :the 10 year experience of a single center. Kirn - Hematology -01-MAR-2011;16(2):73-9
6. Atypical hemolytic uremic syndrome and thrombotic thrombocytopenic purpura: clinically differentiating the thrombotic microangiopathies. Nester CM, Thomas CP. Eur J Intern Med. 2013;24(6):486–91. [PubMed]
7. Diagnostic criteria for atypical hemolytic uremic syndrome proposed by the Joint Committee of the Japanese Society of Nephrology and the Japan Pediatric Society. Clin Exp Nephrol. 2014;18(1):4–9. [PubMed]
8. Neurological involvement in children with E. coli O104:H4-induced hemolytic uremic syndrome. Bauer A, Loos S, Wehrmann C, et al. Pediatr Nephrol 2014; 29:1607.
9. Thrombotic microangiopathy (TTP and HUS): advances in differentiation and diagnosis. Schneide M-Clin Lab Sci-oi-oct-2007;20(4):216-20
10. Interventions for hemolytic-uremic syndrome and thrombotic-thrombocytopenic purpura, a systematic review of randomized controlled trials. Michaelson-AM j Kidney Dis-01-Feb-2009;53(2):259-72

11. A Case Report and Literature Review of Eculizumab Withdrawal in Atypical Hemolytic Uremic Syndrome. Borja Quiroga , Alberto de Lorenzo ,Cristina Vega ,Fernando de Alvaro, Am J Case Rep, 2016; 17: 950-956
12. Acute neurological involvement in diarrhea-associated hemolytic uremic syndrome. Nathanson S, Kwon T, Elmaleh M, et al. Clin J Am Soc Nephrol 2010; 5:1218.
13. Atypical hemolytic uremic syndrome-Kavanagh D-Curr opin hematol-01-Sep-2010;15(5):432-8
14. Is there a shared pathophysiology for TTP and HUS?-Desch K-j.AM Soc Nephrol-01 sep-2007;18(9):2457-60
15. HUS and atypical HUS. **Blood**. 2017 May 25; 129(21): 2847–2856.
16. Alhamdi Y, Abrams ST. Current pathological and laboratory considerations in the diagnosis of disseminated intravascular coagulation. Ann Lab Med. 2016;36(6):505-512. [PMC free article] [PubMed] [Google Scholar]
17. Nester CM, Barbour T, de Cordoba SR, et al. Atypical aHUS: State of the art. Mol Immunol. 2015;67(1):31-42. [PubMed] [Google Scholar]
18. Kielstein JT, Beutel G, Fleig S, et al. ; Collaborators of the DGfN STEC-HUS registry. Best supportive care and therapeutic plasma exchange with or without eculizumab in Shiga-toxin-producing E. coli O104:H4 induced haemolytic-uraemic syndrome: an analysis of the German STEC-HUS registry. Nephrol Dial Transplant. 2012;27(10):3807-3815. [PubMed] [Google Scholar]
19. Scully M, Goodship T. How I treat thrombotic thrombocytopenic purpura and atypical haemolytic uraemic syndrome. Br J Haematol. 2014;164(6):759-766. [PMC free article] [PubMed] [Google Scholar]
20. Ariceta G, Besbas N, Johnson S, Karpman D, Landau D, Licht C, Loirat C, Pecoraro C, Taylor CM, Van de Kar N, Vandewalle J, Zimmerhackl LB. Guideline for the investigation and initial therapy of diarrhea-negative hemolytic uremic syndrome. European Paediatric Study Group for HUS. Pediatr Nephrol. 2009; 24:687-696 [PubMed] [Google Scholar]

**EDITORIAL BOARD****Honorary Editors:****Archil Prangishvili**

Georgian Technical University. Doctor of Technical Sciences. Full Professor.

**Avtandil Silagadze**

Correspondent committee-man of National Academy of Georgia. Tbilisi University of International Relationships. Doctor of Economical Sciences. Full Professor.

**Badri Gechbaia**

Batumi Shota Rustaveli State University. Head of Business Administration Department. PhD in Economics, Associate Professor.

**Davit Narmania**

Tbilisi State University (TSU), Chair of Management and Administration Department. Professor.

**Elshan Mahmud Hajizade**

Cabinet of Ministers of Azerbaijan Republic. Head of department. Doctor of Economic Science. Professor.

**Lamara Qoqiauri**

Georgian Technical University. Member of Academy of Economical Sciences. Member of New York Academy of Sciences. Director of first English school named "Nino". Doctor of Economical Sciences. Full Professor.

**Lia Eliava**

Kutaisi University. Economic expert in the sphere of economy and current events in financial sector. Full Professor. PhD in Business Administration.

**Liana Ptaschenko**

Poltava National Technical University named Yuri Kondratyuk. Doctor of Economical Sciences. Professor

**Nino Didbaridze**

Microbiology and Immunology Department. Immunologi Direction. Tbilisi State Medical University. PhD MD.

**Nino Gogokhia**

Tbilisi State Medical University. Head of Laboratory the First University Clinic. Professor

**Paata Koguashvili**

Georgian Technical University. Doctor of Economical Sciences. Full Professor. Academician. Member of Georgia Academy of Sciences of Agriculture.

**Sergei S. Padalka**

Doctor of Historical Sciences, Professor, Senior Researcher at the Department of Contemporary History and Policy at the Institute of History of Ukraine National Academy of Sciences of Ukraine.

**Tamar Didbaridze**

Tbilisi State Medical University, First University Clinic. PhD in MD.

**Zurab Khonelidze**

Sokhumi State University. Doctor of Political Sciences. Professor.

**International Advisory and Editorial Board****Australia****Shahid Khan**

Monash Business School. Sessional Lecturer. PhD in Management.

**Vikash Ramiah**

UNISA School of Commerce. Associate Professor. PhD in Applied Finance.

**Azerbaijan****Abbas İsmayılov**

Azerbaijan State Agricultural University. Associate Professor. PhD in Biology Science.

**Almaz Mehdiyeva**

Azerbaijan State Oil and Industry University. Associate Professor. PhD in TS

**Amir V. Aliyev**

Ministry of Health of Azerbaijan Republic Lung Diseases Department. Guba District Central Hospital Head of Department. PhD of Medicine

**Aytekin Hasanova**

Azerbaijan Medical University. I Preventive Medicine Faculty. Deputy of Dean. PhD in Medical Biology.

**Araz Manucheri-Lalen**

Associated Professor, PhD Department of Psychiatry, Azerbaijan Medical University.

**Arif M. Mammad-Zada**

Baku "Geotechnological problems of oil, gas and chemistry", Scientific Research Institute, Professor, Chief Researcher. DS.

**Azer K. Mustafayev**

Turan Medical Clinic. Cardiologist. PhD in Medicine. Azerbaijan.

**Beykas Seyfulla Xidirov**

Azerbaijan State Oil and Industrial University. Head of department. Doctor of Economical Sciences

**Djamil Alakbarov**

A researcher at the Research Institute for Lung Diseases. PhD in medicine. Azerbaijan

**Elchin Suleymanov**

Baku Engineering University. Associate Professor of Department Finance. PhD in Economy.

**Elmira Valiyeva**

Azerbaijan State Agrarian University Senior teacher of the Chair of Languages.

**Emin Mammadzade**

Institute of Economics of ANAS. Economic institute. Phd in Economy. Associate professor.

**Farda Imanov**

ANAS. Georgraphy Institute. Doctor of Georgraphy Sciences. Professor.

**Garib Mamedov**

National Academy of Sciences of Azerbaijan Republic. Academician-secretary of the Department of Agrarian Sciences of ANAS, Academician of ANAS. Doctor of Biological Sciences.

**Heyder Guliyev**

Azerbaijan State Agricultural University. English Teacher. PhD in Philology

**Ibrahim Gabibov**

Azerbaijan State Oil and Industrial University. Doctor of Technical Sciences. Professor

**Jamala Mursalova**

Azerbaijan National Academy of Sciences. Genetic Resources Institute. PhD BS.

**Lala Bekirova**

Azerbaijan State Oil and Industrial University. Azerbaijan National Aviation Academy. PhD.TS

**Leyla I. Djafarova**

Clinic "Medium" Baku. Doctor of Medical Sciences. Professor

**Mahmud Hajizade**

Sector Director of State Fund for Information Technology Development of the Ministry of Communications and High Technologies of the Republic of Azerbaijan, Ministry of Transport, Communications and High Technologies of the Republic of Azerbaijan.

**Rafiq Gurbanov**

Azerbaijan State Oil and Industrial University. Doctor of Technical Sciences. Professor

**Ramiz Gurbanov**

Azerbaijan State Oil and Industrial University. Doctor of Technical Sciences. Professor

**Ramiz Mammadov**

ANAS. Geography Institute. Doctor of Technical Sciences. Professor. Academician.

**Rashad G. Abishov**

Dental Implant Aesthetic Center Harbor Hospital, Azerbaijan State Doctors Improvement Institute. PhD. Azerbaijan.

**Rena Gurbanova**

Azerbaijan State Oil and Industrial University. Associate Professor. PhD in Chemistry.

**Sadagat V. Ibrahimova**

Azerbaijan State Oil and Industrial University. Academician Doctor of Economical Sciences. PhD

**Samira Mammadova**

Sumgayit State University. Senior Teacher of History and its teaching methodology in History Faculty. PhD in History.

**Sayyara Ibadullayeva**

Institute of Botany. National Academy of Sciences. Professor. PhD in Biological Sciences.

**Sevinj Mahmudova**

Azerbaijan State Agrarian University. PhD. Researcher.

**Tarbiz Nasrulla Aliyev**

Innovation Center of National Academy of Azerbaijan Republic. The deputy of director. Doctor of Economical Sciences. Professor

**Tariel Omarov**

Azerbaijan Medical University. Department of surgical diseases. PhD in Medicine

**Tofiq Ahmadov**

Azerbaijan State Oil and Industrial University. Doctor of Geology and Mineralogy Sciences. Professor

**Tofiq Yusif Baharov**

Azerbaijan State Oil Company. Scientific Research Institute. Head of department. Doctor of Geology and Mineralogy Sciences

**Tofiq Samadov**

Azerbaijan State Oil and Industrial University. Doctor of Technical Sciences. Professor.

**Tubukhanum Gasimzadeh**

Azerbaijan National Academy of Sciences. Institute of Dendrology of Azerbaijan NAS. Leading researcher PHD in Biological Sciences, Associate Professor.

**Vusal Ismailov**

"Caspian International Hospital". Orthopedics Traumatology Expert. MD. Azerbaijan.

**Zakir Aliyev**

RAPVHN and MAEP. PhD in Agricultural Sciences, Professor of RAE academician.

**Zakir Eminov**

ANAS. Geography Institute. Doctor of Georgraphy Sciences. Associate Professor.

**Bahrain****Osama Al Mahdi**

University of Bahrain, Bahrain Teachers College. Assistant Professor. PhD, Elementary Education and Teaching

**Bangladesh****Muhammad Mahboob Ali**

Daffodil International University. Department of Business Administration . Professor.

**Belarus****Helena Kallaur**

Polesky State University. MD. Associate Professor

**Tanua Teterinets**

Belarusian State University of Agricultural Technology. Doctor of Economical Sciences. Associate Professor.

**Vladimir Yanchuk**

Belarus State University. Professor. Academy of Postgraduate Education. PhD in Social Psychology.

**Bosna & Hercegovina****Igor Jurčić**

Head of marketing Business group for VSE/SME. Telecommunication Business and Management.

**Ratko Pavlovich**

University of East Sarajevo. Faculty of Physical Education and Sport. Full Professor. PhD in Sport Sciences.

**Brazil****Paulo Cesar Chagas Rodrigues**

Federal Institute of Education, Science and Technology of Sao Paulo. Professor. PhD in Mechanical Engineering.

**Bulgaria****Desislava Stoilova**

South-West University “ Neofit Rilski”. Vice Dean of Faculty of Economics. Associate Professor. PhD in Finance.

**Eva Tsvetanova**

Tsenov Academy of Economics, Svishtov, Bulgaria Department of Strategic Planning. Head assistant professor. PhD in Economy.

**Jean-François Rougé**

University of technology Sofia. Professor researcher. PhD in Management.

**Jean-François Rougé**

University of Technology, Sofia. PhD in Business law

**Milena Kirova**

Sofia University “St. Kliment Ohridski”. Professor. PhD in Philology.

**Croatia****Dragan Čišić**

University of Rijeka. Faculty of Maritime Studies. Full professor. PhD in Logistics, e-business.

**Egypt****Abdelbadeh Salem**

Professor at Faculty of Computer and Information Science, Ain Shams University.

**France****Michael Schaefer**

L'Association 1901 SEPIKE International, Président at SEPIKE International. PhD of Economical Sciences

**Georgia****Anzor G. Abralava**

Georgian Technical University. Doctor of Economical Sciences. Full Professor

**Dali Sologashvili**

State University named Akaki Tsereteli. Doctor of Economical Sciences. Full Professor



**Dali Osepashvili**

Professor of Journalism and Mass Communication TSU (Tbilisi State University), Head MA Program "Media and New Technology"

**Davit Tophuria**

Tbilisi State Medical University. Head of International Students Academic Department, Associate Professor. PhD in HNA.

**Eka Avaliani**

International Black Sea University. Associate Professor. PhD in History.

**Eka Darchiashvili**

Tbilisi State University named after Sv. Grigol Peradze. Assistant of professor. PhD in BA.

**Ekaterine Maghlakelidze**

The University of Georgia, Associated professor, Business, Economics and Management School.

**Enene Menabde-Jobadze**

Georgian Technical University. Academical Doctor of Economics.

**Eter Bukhnikashvili**

Dental clinic "NGM-Innovation Dental". The doctor-stomatologist. PhD in Medicine.

**Evgeni Baratashvili**

Georgian Technical University. Head of Economic and Business Department. Doctor of Economical Sciences. Full Professor

**George Jandieri**

Georgian Technical University; Chief scientist, Institute of Cybernetics of the Georgian Academy. Full Professor

**George Malashkhia**

Georgian Technical University. Doctor of Economical Sciences. Full Professor.

**Giorgi Kepuladze**

Akaki Tsereteli State University, Faculty of Business, Law and Social Sciences, PhD in Economics. Invited teacher.

**Gulnara Kiliptari**

Tbilisi State Medical University. Head of ICU department. Associate professor.

**Iamze Taboridze**

Scientific Center of the Humanitarian Educational University, Head, PhD in Medicine. Associate professor.

**Irma Makharashvili**

Caucasus International University. Dean of Business Faculty. Doctor of Economical Sciences. Full Professor

**Ketevan Goletiani**

Batumi Navigation Teaching University. Dean of Logistics Faculty. Batumi Shota Rustaveli State University. Doctor TS, Professor.

**Larisa Korghanashvili**

Tbilisi State University (TSU) named Ivane Javakhishvili. Full Professor

**Larisa Takalandze**

Sokhumi State University, Faculty of Economic and Business. Doctor of Economic Sciences.

**Lia Davitadze**

Batumi Shota Rustaveli State University. Higher Education Teaching Professional. PhD in Educational Sciences.

**Lia Matchavariani**

Tbilisi State University (TSU) named Ivane Javakhishvili. Full Professor, Faculty of Exact & Natural Sciences (Geography Dep.)

**Loid Karchava**

Doctor of Business Administration, Association Professor at the Caucasus International University, Editor-in-Chief of the international Scientific Journal "Akhali Ekonomisti" (The New Economist)

**Maia Kapanadze**

Georgian State University named Javakhishvili. Doctor of Economical Sciences. Associate Professor.

**Maia Matoshvili**

Tbilisi State Medical University. The First University Clinic. Dermato-Venereologist. Assistant Professor. PhD in DAPS.

**Mariam Darbaidze**

Davit Aghmashenebeli National Defense Academy of Georgia. The Head of Education Division. PhD in Biology.

**Mariam Kharashvili**

Ilia State University. Assistant Professor. PhD MD.

**Mariam Nanitashvili**

Executive Director - Wise Development LTD (Training Centre). Associated Professor at Caucasus University. PhD in Economics

**Nana Shoniya**

State University of Kutaisi named Akakhi Tsereteli. Doctor of Economical Sciences. Full professor

**Natia Beridze**

LEPL National Environmental Agency of Georgia, Invited Expert at International Relations and PR Division. PhD in Political Science.

**Nelli Sichinava**

Akaki Tsereteli State University. Associate. Professor. PhD

**Nino Pirtskhelani**

Associated Professor of Department of Molecular and Medical Genetics of Tbilisi State Medical University.

**Omari Omarimu**

Tbilisi State University named Iv. Javakhishvili. Doctor of Chemical Sciences Professor

**Rati Abuladze**

St. Andrew the first-called Georgian University of the Patriarchate of Georgia. Faculty of Economics and Business Administration. Manager of the Faculty Quality Assurance Office. PhD in Business Administration.

**Rusudan G. Kutateladze**

Georgian Technical University. Doctor of Economical Sciences. Full Professor

**Rusudan Sujashvili**

New Vision University. School of Medicine. Professor.

**Simon Nemsadze**

Georgian Technical University . Doctor of Technical Sciences. Full Professor

**Tamila Arnania-Kepuladze**

Akaki Tsereteli State University. Department of Economics. PhD in Economic.

**Tengiz Museliani**

Georgian Technical University. Academic Doctor of Technical Sciences. Associate Professor

**Timuri Babunashvili**

Georgian Business Academy of Science. Doctor of Economical Sciences. Full Professor.

**Vladimer Papava**

Tbilisi State Medical University. Assistant-Professor. PhD. MD.

**Zaira Gudushauri**

Georgian-Azerbaijan University named G.Aliyev. Associate Professor. PhD. ES.

**Germany****Hans-Juergen Zahorka**

Assessor jur., Senior Lecturer (EU and International Law, Institutions and Economy), Chief Editor of "European Union Foreign Affairs Journal", LIBERTAS - European Institute, Rangendingen

**Alexander Dilger**

University of Münster. Professor of Business Economics. PhD in Economy.

**Greece****Margarita Kefalaki**

Communication Institute of Greece. PhD in Cultural Communication. President of Institute.

**Hungary****Nicasia Picciano**

Central European University. Department of International Relations and European Studies.

**India****Federica Farneti**

University of Bologna. Department of Sociology and Business Law. Associate Professor. OhD in Economic & Management.

**Prasanta Kumar Mitra**

Sikkim Manipal Institute of Medical Sciences. Department of Medical Biotechnology. PhD in Biochemistry.

**Samant Shant Priya**

Lal Bahadur Shastri Institute of Management, New Delhi, Associate Professor in Philosophy PhD in Marketing.

**Sonal Purohit**

Jain University, Center for Management Studies, Assistant Professor, PhD in Business Administration, Life Insurance, Privatization.

**Varadaraj Aravamudhan**

Measi Institute of Management. Associate Professor. PhD in Management.

**Iraq****Rana Khudhair Abbas Ahmed**

Iraq, Baghdad, Alrafidain University College. Lecturer, Global Executive Administrator, Academic coordinator. PhD in Scholar (CS).

**Iran****Azadeh Asgari**

Asian Economic and Social Society (AESS). Teaching English as a Second Language. PhD

**Italy****Simona Epasto**

University of Macerata. Department of Political Science, Communication and International Relations. Tenured Assistant Professor in Economic and Political Geography. PhD in Economic and Political Geography

**Donatella M. Viola**

London School of Economics and Political Science, London, Assistant Professor in Politics and International Relations at the University of Calabria, Italy. PhD in International Relations.

### Jordan

**Ahmad Aljaber**

President at Gulf University. German Jordan University, Founder / Chairman of the Board. Ph.D in Computer Science

**Ahmad Zamil**

Middle East University (MEU). Business Administration Dept. Associate Professor. PhD Marketing

**Ikhlas Ibrahim Altarawneh**

Al-Huessien Bin Talal University. Business Department. Full Professor in Human Resource Management.

**Asmahan Majed Altaher**

Arab Academy for Banking and Financial Sciences. Associate Professor. PhD in Management Information System.

**Sadeq AlHamouz**

Middle East University (MEU). Head Computer Information Systems. PHD. Computer Science.

**Safwan Al Salameh**

Aqaba University. Software Engineering Department. Information Technology Faculty. Professor. PhD.

---

### Kazakhstan

**Alessandra Clementi**

Nazarbayev University School of Medicine. MD, GP. Assistant Professor of Medical Practice and Family Medicine

**Altinay Pozilova**

Sirdarya University. Associated professor. PhD in Pedagogy Science.

**Anar Mirazagalieva**

Astana International University. Vice-President. PhD in Biology.

**Anna Troeglazova**

East Kazakhstan State University named Sarsen Amanjолоv. PhD

**Gulmira Zhurabekova**

Marat Ospanov West-Kazakhstan State Medical Academy. Department of Human Anatomy. Associate Professor

**Guzel Ishkinina**

Ust-Kamenogorsk, Russian Economy University G. Plekhanov, Associate Professor, PhD in Economic science.

**Marina Bobireva**

West Kazakhstan State Medical University named Marat Ospanov. PhD

**Niyazbek Kalimov**

Kostanay Agricultural Institution. PhD

**Nuriya Kharissova**

State University of Karaganda. Associate Professor of Biological Science

**Nikolay Kurguzov**

State University of Pavlodar named S. Toraygirova. PhD. Professor.

**Oleg Komarov**

Pavlodar State Pedagogical Institute. Professor of Department of Economics, Law and Philosophy. PhD in Sociology,

**Zhanargul Smailova**

Head of the Department of Biochemistry and Chemical Disciplines named after MD, professor S.O. Tapbergenova NAC Medical University of city Semey.

---

### Libya

**Salaheddin Sharif**

University of Benghazi, International Conference on Sports Medicine and Fitness, Libyan Football Federation- Benghazi PhD in Medicine (MD)

---

### Latvia

**Tatiana Tambovceva**

Latvian Council of Science. Riga Technical University. Associate Professor at Riga Technical University

---

### Lithuania

**Agne Simelyte**

Vilnius Gediminas Technical University, Associate professor. Phd in Social Sciences (Management)

**Ieva Meidute – Kavaliauskiene**

Vilnius Gediminas Technical University. Vice-dean for Scientific Research

**Vilma (Kovertaite) Musankoviene**

e-Learning Technology Centre. Kaunas University of Technology. PHD

**Laura Uturyte**

Vilnius Gediminas Technical University (VGTU). Head of Project Manager at PI Gintarine Akademy. PhD in Economy.

**Loreta (Gedminaitė) Ulvydiene**

Professor of Intercultural Communication and Studies of Translation. Vilnius University. PHD

**Zhaneta Simanavichienė**

Professor, head of Laboratory Business Innovation University of Mykolas Romeris. Honorary consul of Estonia

**Malaysia****Anwarul Islam**

The Millennium University. Department of Business Administration. Associate Professor.

**Kamal Uddin**

Millennium University, Department of Business Administration. Associate Professor. PhD in Business Administration.

**Morocco****Mohammed Amine Balambo**

Ibn Tufail University, Aix-Marseille University. Free lance. Consultant and Trainer. PhD in Philosophy. Management Sciences, Specialty Strategy and Logistics.

**Nigeria****Bhola Khan**

Yobe State University, Damaturu. Senior Lecturer and Head, Dept. of Economics. PhD in Economics.

**Norway****Svitlana Holovchuk**

PhD in general pedagogics and history of pedagogics.

**Pakistan****Nawaz Ahmad**

The Aga Khan University. Chief Examiner. PhD in Management.

**Poland****Grzegorz Michalski**

Wrocław University of Economics. Faculty of Engineering and Economics. PhD in economics. Assistant professor.

**Kazimierz Waluch**

Pawel Wlodkowic University College in Plock, Assistant Professor at the Faculty of Management. PhD in Economy.

**Robert Pawel Suslo**

Wrocław Medical University, Public Health Department, Health Sciences Faculty, Adjunct Professor of Gerontology Unit. PhD MD.

**Tadeusz Trocikowski**

European Institute for Eastern Studies. PhD in Management Sciences.

**Qatar****Mohammed Elgammal**

Qatar University. Assistant Professor in Finance. PhD in Finance

**Romania****Camelia Florela Voinea**

University of Bucharest, Faculty of Political Science, Department of Political Science, International Relations and Security Studies. PhD in Political Sciences.

**Minodora Dobreanu**

University of Medicine, Pharmacy, Sciences and Technology of Târgu Mureş. Faculty of Medicine. Professor. PhD in Medicine.

**Odette (Buzea) Arhip**

Ecological University Bucuresti. Professor at Ecological University. PhD.

**Russia****Alexander A. Sazanov**

Leningrad State University named A.S. Pushkin. Doctor of Biological Sciences. Professor

**Alexander N. Shendalev**

State Educational Institution of Higher Education. Omsk State Transport University. Associate Professor

**Andrey Latkov**

Stolypin Volga Region Institute of Administration, Ranepa. Sc.D. (Economics), Ph.D. (Politics), professor,

**Andrei Popov**

Director "ProfConsult Group". Nizhny Novgorod Region. PhD

**Anton Mosalyov**

Russian State University of Tourism and Service. Associate Professor

**Carol Scott Leonard**

Presidential Academy of the National Economy and Public Administration. Vice Rector. PhD, Russian History

**Catrin Kolesnikova**

Samara Architectural and Constructional University. PhD

**Ekaterina Kozina**

Siberia State Transportation University. PhD

**Elena Klemenova**

South Federal University of Russia. Doctor of Pedagogical Sciences. Professor

**Galina Kolesnikova**

Russian Academy of Natural Sciences and International Academy of Natural History. Taganrog Institute of Management and Economics. Philologist, Psychologist, PhD

**Galina Gudimenko**

Orel State Institute of Economics and Trade. Department of History, Philosophy, Advertising and Public Relations. Doctor of Economical Sciences. Professor.

**Grigory G. Levkin**

Siberian State Automobile and Highway Academy. Omsk State Transport University. PHD of Veterinary Sciences

**Gyuzel Ishkinina**

Ust-Kamenogorsk affiliation of G. Plekhanov Russian Economy University / Associate Professor, Business, Informatics, Jurisprudence and General Studies sub-department. PhD in Economic science.

**Irina V. Larina**

Federal State Educational Institution of Higher Professional Education. Associate Professor

**Irina Nekipelova**

M.T. Kalashnikov Izhevsk State Technical University. Department of Philosophy. PhD

**Larisa Zinovieva**

North-Caucasus Federal University. PHD. Pedagogical Science. Associate Professor

**Liudmila Denisova**

Department Director at Russian State Geological Prospecting University. Associate Professor

**Lyalya Jusupova**

Bashkir State Pedagogical University named M. Akmully. PHD Pedagogical Science. Associate Professor

**Marina Sirik**

Kuban State University. Head of the Department of Criminal Law, Process and Criminalistics of the State Pedagogical University. PhD in Legal Sciences.

**Marina Volkova**

Research Institute of Pedagogy and Psychology. Doctor of Pedagogical Sciences. Professor

**Natalia Litneva**

Orlov State Institute of Economy and Trade. Volga Branch of The Federal State Budget Educational Institution of Higher Professional Education

**Nikolay N. Efremov**

Institute of Humanitarian Research and the Russian Academy of Sciences. Doctor of Philology. Research Associate

**Nikolay N. Sentyabrev**

Volgograd State Academy of Physical Culture. Doctor of Biological Sciences. Professor. Academician.

**Olga Ovsyanik**

Plekhanov Russian Economic University, Moscow State Regional University. Doctor in Social Psychology.

**Olga Pavlova**

Medical University named Rehabilitation, Doctors and Health, Professor of the Department of Morphology and Pathology, Doctor of biological sciences, physiology

**Sergei N. Fedorchenko**

Moscow State Regional University of Political Science and Rights. PhD

**Sergei A. Ostroumov**

Moscow State University. Doctor of Biological Science. Professor

**Svetlana Guzenina**

Tambov State University named G.R. Derzhavin. PhD in Sociology

**Tatiana Kurbatskaya**

Kamsk State Engineering – Economical Academy. PhD

**Victor F. Stukach**

Omsk State Agrarian University. Doctor of Economical Sciences. Professor

**Zhanna Glotova**

Baltic Federal University named Immanuel Kant, Ph.D., Associate Professor.

### Saudi Arabia

#### Ikhlas (Ibrahim) Altarawneh

Ibn Rushd College for Management Sciences. PHD Human Resource Development and Management. Associate Professor in Business Administration

#### Salim A Alghamdi

Taif University. Head of Accounting and Finance Dept. PhD Accounting

### Serbia

#### Aleksandra Buha

University of Belgrade. Department of toxicology "Akademik Danilo Soldatović", Faculty of Pharmacy

#### Jane Paunkovic

Faculty for Management, Megatrend University. Full Professor. PhD, Medicine

#### Jelena Purenovic

University of Kragujevac . Faculty of Technical Sciences Cacak . Assistant Professor . PhD in NM systems.

### Sultanate of Oman

#### Nithya Ramachandran

Ibra College of Technology. Accounting and Finance Faculty, Department of Business Studies. PhD

#### Rustum Mamlook

Dhofar University, Department of Electrical and Computer Engineering College of Engineering. PhD in Engineering / Computer Engineering. Professor.

### Sweden

#### Goran Basic

Lund University. Department of Sociology. PhD in Sociology. Postdoctoral Researcher in Sociology.

### Turkey

#### Mehmet Inan

Turkish Physical Education Teachers Association. Vice president. PhD in Health Sciences, Physical Education and Sport Sciences

#### Muzaffer Sancı

University of Health Sciences. Tepecik Research and Teaching Hospital. Clinics of Gynecology and Obstetrics Department of Gynecologic Oncologic Surgery. Associated Professor.

#### Vugar Djafarov

Medical school at the University of Ondokuzmayıs Turkey. PhD. Turkey.

#### Yigit Kazancioglu

Izmir University of Economics. Associate Professor, PhD in Business Administration.

### UK

#### Alan Sheldrake

Imperial Collage. London University. Electrical Power Engineering Consultant. PhD

#### Christopher Vasilopoulos

Professor of Political Science at Eastern Connecticut State University. PhD in Political Science and Government.

#### Frances Tsakonas

International Institute for Education Advancement. Ceo & Founder. PhD in Philosophy.

#### Georgios Piperopoulos

Northumbria University. Visiting Professor, Faculty of Business and Law Newcastle Business School. PhD Sociology and Psychology.

#### Mahmoud Khalifa

Lecturer at Suez Canal University. Visiting Fellow, School of Social and Political Sciences, University of Lincoln UK. PhD in Social and Political Sciences

#### Mohammed Elgammal

Qatar University. Assistant Professor. PhD in Finance.

#### Stephan Thomas Roberts

BP Global Project Organisation. EI&T Construction Engineer. Azerbaijan Developments. SD 2 Onshore Terminal. Electrical engineer.

### Ukraine

#### Alina Revtie-Uvarova

National Scientific Center. Institute of Soil Structure and Agrochemistry named Sokolovski. Senior Researcher of the Laboratory, performing part-time duties of the head of this laboratory.

**Alla Oleksyuk-Nexhames**

Lviv University of Medicine. Neurologist at pedagog, pryvaty refleksoterapy. MD PD.

**Anna Kozlovska**

Ukrainian Academy of Banking of the National Bank of Ukraine. Associate Professor. PhD in Economic.

**Bogdan Storokha**

Poltava State Pedagogical University. PhD

**Dmytro Horilyk**

Head of the Council, at Pharmaceutical Education & Research Center. PhD in Medicine.

**Galina Kuzmenko**

Central Ukrainian National Technical University, Department of Audit and Taxation, Associate Professor. PhD in Economy.

**Galina Lopushniak**

Kyiv National Economic University named after Vadym Hetman. PhD. Doctor of Economic Sciences, Professor.

**Hanna Hulciaieva**

Institute of Microbiology and Virology, NASU, department of phytopatogenic bacteria. The senior research fellow, PhD in Biology.

**Hanna Komarnytska**

Ivan Franko National University of Lviv, Head of the Department of Economics and Management, Faculty of Finance and Business Management, Ph.D. in Economics, Associate Professor.

**Iryna Skrypchenko**

Prydniprovsk State Academy of Physical Culture and Sports. Department of Water Sports. Associate Professor. PhD in Physical Education and Sport.

**Katerina Yagelskaya**

Donetsk National Technical University. PhD

**Larysa Kapranova**

State Higher Educational Institution «Priazovskyi State Technical University» Head of the Department of Economic Theory and Entrepreneurship, Associate Professor, PhD in Economy,

**Lesia Baranovskaya**

National Technical University of Ukraine "Kyiv Polytechnic Institute", PhD, Associate Professor.

**Liliya Roman**

Department of Social Sciences and Ukrainian Studies of the Bukovinian State Medical University. Associate professor, PhD in Philology,

**Lyudmyla Svistun**

Poltava national technical Yuri Kondratyuk University. Department of Finance and Banking. Associated Professor.

**Mixail M. Bogdan**

Institute of Microbiology and Virology, NASU, department of Plant of viruses. PhD in Agricultural Sciences.

**Nataliya Bezrukova**

Yuri Kondratyuk National Technical University. Associate Professor, PhD in Economic.

**Oleksandr Voznyak**

Hospital "Feofaniya". Kyiv. Head of Neureosurgical Centre. Associated Professor

**Oleksandra Kononova**

Prydniprovsk State Academy of Civil Engineering and Architecture (PSACIA), Assoc.professor of Accounting, Economics and Human Resources Management department. PhD. in Economic Science.

**Oleksandr Levchenko**

Central Ukrainian National Technical University, Kropyvnytskyi. Vice-Rector for Scientific Activities. Professor.

**Olena Cherniavska**

Poltava University of Economics and Trade, Doctor of Economical Sciences. Professor

**Olga F. Gold**

Ukrainian National University named I.I. Mechnikov. PhD

**Olga I. Gonchar**

Khmelnysky National University, Economics of Enterprise and Entrepreneurship, Doctor of Economic Sciences, Professor.

**Roman Lysyuk**

Assistant Professor at Pharmacognosy and Botany Department at Danylo Halytsky Lviv National Medical University.

**Stanislav Goloborodko**

Doctor of Agricultural Sciences, Senior Researcher. Institute of Agricultural Technologies of Irrigated Agriculture of the National Academy of Agrarian Sciences of Ukraine

**Svetlana Dubova**

Kyiv National University of Construction and Architecture. Department of Urban Construction. Associate Professor. PhD in TS.

Kyiv Cooperative Institute of Business and Law

**Tetiana Kaminska**

Kyiv Cooperative Institute of Business and Law. Rector. Doctor of Science in Economics. .

**Valentina Drozd**

State Scientific Research Institute of the Ministry of Internal Affairs of Ukraine. Doctor of Law, Associate Professor, Senior Researcher.

**Vasyl Klymenko**

Central Ukrainian National Technical University. Department of Electrical Systems and Energy Management. Doctor TS. Professor.

**Victoriya Lykova**

Zaporizhzhya National University, PhD of History

**Victor P. Mironenko**

Doctor of Architecture, professor of department "Design of architectural environment", Dean of the Faculty of Architecture of Kharkov National University of Construction and Architecture (KNUCA), member of the Ukrainian Academy of Architecture

**Yuliia Mytrokhina**

Donetsk National University of Economics and Trade named after Mykhaylo Tugan-Baranovsky., PhD in Marketing and Management. Associate Professor

**Yulija M. Popova**

Poltava National Technical University named Yuri Kondratyuk. PhD in Economic. Associated professor

**Crimea****Lienara Adzhyieva**

V.I. Vernadsky Crimean Federal University, Yevpatoriya Institute of Social Sciences (branch). PhD of History. Associate Professor

**Oksana Usatenko**

V.I. Vernadsky Crimean Federal University. Academy of Humanities and Education (branch). PhD of Psychology.

Associate Professor.

**Oleg Shevchenko**

V.I. Vernadsky Crimean Federal University, Humanities and Education Science Academy (branch), Associate Professor. PhD in Social Philosophy

**Tatiana Scriabina**

V.I. Vernadsky Crimean Federal University, Yevpatoriya Institute of Social Sciences (filial branch). PhD of Pedagogy.

Associate Professor

**United Arab Emirates****Ashok Dubey**

Emirates Institute for Banking & Financial Studies, Senior faculty. Chairperson of Academic Research Committee of EIBFS.

PhD in Economics

**Maryam Johari Shirazi**

Faculty of Management and HRM. PhD in HRM. OIMC group CEO.

**USA****Ahmet S. Yayla**

Adjunct Professor, George Mason University, the Department of Criminology, Law and Society & Deputy Director, International Center for the Study of Violent Extremism (ICSVE), PhD in Criminal Justice and Information Science

**Carol Scott Leonard**

Presidential Academy of the National Economy and Public Administration. National Research University – Higher School of Economics. Russian Federation

**Christine Sixta Rinehart**

Academic Affairs at University of South Carolina Palmetto College. Assistant Professor of Political Science. Ph.D. Political Science

**Cynthia Buckley**

Professor of Sociology at University of Illinois. Urbana-Champaign. Sociological Research

**Medani P. Bhandari**

Akamai University. Associate professor. Ph.D. in Sociology.

**Mikhail Z. Vaynshteyn**

Lecturing in informal associations and the publication of scientific articles on the Internet. Participation in research seminars in the "SLU University" and "Washington University", Saint Louis

**Nicolai Panikov**

Lecturer at Tufts University. Harvard School of Public Health. PhD/DSci, Microbiology

**Rose Berkun**

State University of New York at Buffalo. Assistant Professor of Anesthesiology, PhD. MD

**Tahir Kibriya**

Director technical / senior engineering manager. Black & Veatch Corporation, Overland Park. PhD Civil Engineering.

**Yahya Kamalipour**

Dept. of Journalism and Mass Communication North Carolina A&T State University Greensboro, North Ca. Professor and Chair

Department of Journalism and Mass Communication North Carolina A&T State University. PhD

**Wael Al-Husami**

Lahey Hospital & Medical Center, Nardone Medical Associate, Alkhaldi Hospital, Medical Doctor, International Health, MD, FACC, FACP

**Uruguay****Gerardo Prieto Blanco**

Universidad de la República. Economist, Associate Professor . Montevideo.

**Uzbekistan****Guzel Kutlieva**

Institute of Microbiology. Senior Researcher. PhD in BS.



**Khurshida Narbaeva**

Institute of Microbiology, Academy of Sciences Republic of Uzbekistan, Doctor of biological sciences.

**Shaklo Miralimova**

Academy of Science. Institute of Microbiology. Doctor of Biology Sciences. PhD in BS.

**Shukhrat Yovkochev**

Tashkent State Institute of Oriental Studies. Full professor. PhD in political sciences.

---

**Honorary editorial board members:**

Agaheydar Seyfulla Isayev

Azerbaijan State Oil Academy. Doctor of Economical Sciences. Professor.

Jacob Meskhia

Tbilisi State University. Faculty of Economics and Business. Full Professor.

International Research, Education & Training Center (United Kingdom, London) and NGO International Research, Education & Training Center (Estonia, Tallinn) are publishing scientific papers of scientists on Website and in Referred Journals with subjects which are mentioned below:

### © SOUTHERN CAUCASUS SCIENTIFIC JOURNALS

Gülüstan Black Sea Scientific Journal of Academic Research has ISSN, E-ISSN and UDC numbering:  
ISSN: 1987-6521 (Print), E-ISSN: 2346-7541 (Online), UDC: 551.46 / (051.4)/B-64; DOI prefix: 10.36962

#### AGRICULTURAL, ENVIRONMENTAL & NATURAL SCIENCES

Agriculture, Agronomy & Forestry Sciences  
History of Agricultural Sciences  
Plant Breeding and Seed Production  
Environmental Engineering Science  
Earth Sciences & Organic Farming  
Environmental Technology  
Botany, Zoology & Biology

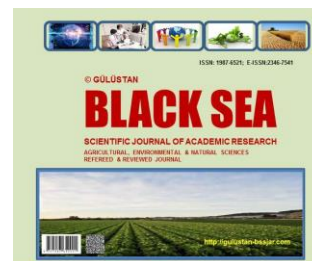

#### SOCIAL, PEDAGOGY SCIENCES & HUMANITIES

Historical Sciences and Humanities  
Psychology and Sociology Sciences  
Philosophy and Philology Sciences  
History of Science and Technology  
Social Science  
Pedagogy Science  
Politology  
Geography  
Linguistics

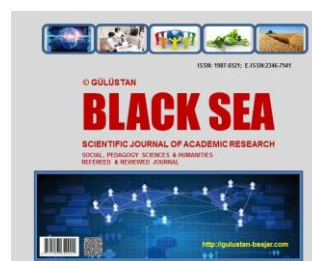

#### MEDICINE, VETERINARY MEDICINE, PHARMACY AND BIOLOGY SCIENCES

Clinical Medicine  
Prophylactic Medicine  
Theoretical Medicine  
Stomatology & Dentistry  
Veterinary Medicine and Zoo  
Drug Technology and Organization of Pharmaceutical Business  
Pharmaceutical Chemistry and Pharmacology  
Standardization and Organization of Medicines Production  
History of Pharmacy  
Innovations in Medicine  
Biophysics and Biochemistry  
Radiology and Microbiology  
Molecular Biology and Genetics  
Botany and Virology  
Microbiology and Hydrobiology  
Physiology of Plants, Animals and Humans  
Ecology, Immunology and Biotechnology  
Virology and Immunology  
History of Biology  
Entomology

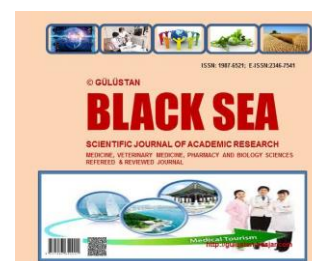

**TECHNICAL AND APPLIED SCIENCES**

Applied Geometry, Engineering Drawing, Ergonomics and Safety of Life  
 Machines and Mechanical Engineering  
 History of Science and Technics  
 Electrical engineering, Radio Engineering, Telecommunications, and Electronics  
 Civil Engineering and Architecture  
 Information, Computing and Automation  
 Mining and Geodesy Sciences  
 Metallurgy and Energy  
 Chemical Technology, Chemistry Sciences  
 Technology of Food Products  
 Technology of Materials and Products Textile and Light-load industry  
 Machinery in Agricultural Production  
 History of Art  
 Project and Program Management  
 Innovative Technologies  
 Repair and Reconstruction  
 Materials Science and Engineering  
 Engineering Physics  
 Mathematics & Applied Mathematics

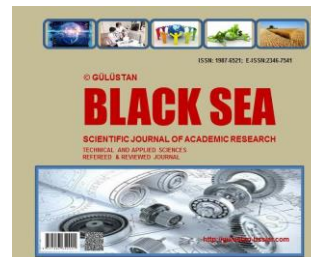

**REGIONAL DEVELOPMENT, OLIMPIC AND PROFESSIONAL SPORT**

History of tourism  
 Theoretical and methodological foundations of tourism and recreation  
 Tourist market , its current state and development forecasts  
 Training and methodological support  
 Physical training  
 Olimpic sport  
 Professional sport  
 People health

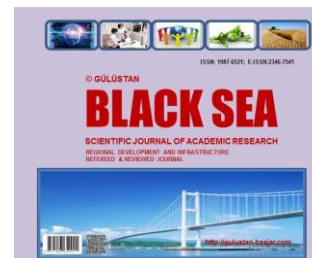

**ECONOMIC, MANAGEMENT & MARKETING SCIENCES**

Economics and Management of Enterprises  
 Economy and Management of a National Economy  
 Mathematical Methods, Models and Information Technologies in Economics  
 Accounting, Analysis and Auditing  
 Money, Finance and Credit  
 Demography, Labor Conomics  
 Management and Marketing  
 Economic Science

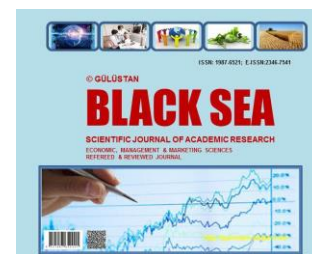

**LEGAL AND POLITICAL SCIENCE**

Theory and History of State and Law  
 International Law  
 Branches of Law  
 Judicial System and Philosophy of Law  
 Theory and History of Political Science  
 Political Institutions and Processes  
 Political Culture and Ideology  
 Political Problems of International Systems and Global Development



**CONFERENCE NEWSLETTER**



**MULTIDISCIPLINARY JOURNAL**

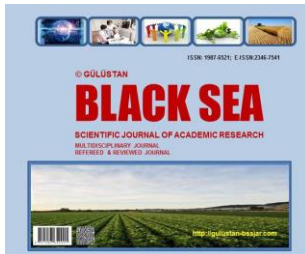

The Caucasus Economic and Social Analysis Journal has ISSN, E-ISSN and UDC numbering:  
ISSN: 2298-0946 (Print), E-ISSN: 1987-6114 (Online), DOI prefix: 10.36962, UDC: 3/K-144

**MULTIDISCIPLINARY JOURNAL**

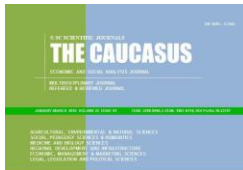

**CONFERENCE NEWSLETTER**

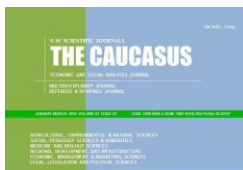

## JOURNAL INDEXING

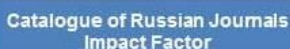

**ISSN: 1987-6521; E-ISSN:2346-7541; DOI:10.36962/GBSSJAR**

©**Publisher:** LTD International Research, Education & Training Center. (UK, London),

**Director and shareholder:** Alexandra Cuco. Lawyer. Portugal.

**Deputy and shareholder:** Namig Isazade. PhD in Business Administration.

**Direktorun müavini və Payçı:** Namig Isazade. PhD in Business Administration.

©**Editorial office:** 71-75 Shelton Street, Covent Garden, London, WC2H 9JQ, UK.

©**Typography:** LTD International Research, Education & Training Center. (UK, London).

**Registered address:** 71-75 Shelton Street, Covent Garden, London, WC2H 9JQ, UK.

**Telephones:** +994 55 241 70 12; +994 51 864 88 94

**Website:** <http://sc-media.org/>

**E-mail:** [gulustanbssjar@gmail.com](mailto:gulustanbssjar@gmail.com), [sc.mediagroup2017@gmail.com](mailto:sc.mediagroup2017@gmail.com)

©**Publisher:** NGO International Research, Education & Training Center.

**Deputy and founder of organization:** Seyfulla Isayev. Azerbaijan Marine Academy.

©**Editorial office:** Narva mnt 5, 10117 Tallinn, Estonia.

©**Typography:** NGO International Research, Education & Training Center. BS Journals.

**Registered address:** Narva mnt 5, 10117 Tallinn, Estonia.

**Telephones:** +994 55 241 70 12; +994518648894; +994 55 241 70 09

**Website:** <http://sc-media.org/>

**E-mail:** [gulustanbssjar@gmail.com](mailto:gulustanbssjar@gmail.com), [sc.mediagroup2017@gmail.com](mailto:sc.mediagroup2017@gmail.com), [caucasusblacksea@gmail.com](mailto:caucasusblacksea@gmail.com)

# BLACK SEA

SCIENTIFIC JOURNAL OF ACADEMIC RESEARCH

MULTIDISCIPLINARY JOURNAL  
REFEREED & REVIEWED JOURNAL



**AGRICULTURAL, ENVIRONMENTAL & NATURAL SCIENCES**

**SOCIAL, PEDAGOGY SCIENCES & HUMANITIES**

**MEDICINE, VETERINARY MEDICINE, PHARMACY AND BIOLOGY SCIENCES**

**TECHNICAL AND APPLIED SCIENCES**

**REGIONAL DEVELOPMENT AND INFRASTRUCTURE**

**ECONOMIC, MANAGEMENT & MARKETING SCIENCES**

**LEGAL, LEGISLATION AND POLITICAL SCIENCES**

