

Cotunnite, cumengeite, diaboleite and other lead and copper secondary minerals in the La Reixidora mine

- Monte Bedures, Meredo, Vegadeo, Asturias, Spain -

Miguel Calvo and Joan Viñals (†)

Introduction

On the slopes of Monte Bedures (or Monte Vidures), a hill located in the parish of Meredo, municipality of Vegadeo, Asturias, are the remains of a series of mine workings, some of them very old. These mines were probably worked in Roman times, for both lead and iron ores, and possibly also copper. Paillette and Bezar (1849) located two types of smelting slag in this area, one ferruginous and another plumbiferous, more precisely in El Escobal, next to Lormes creek. In the decade of the 1830s the Union Asturiana company tried to exploit it again, although with few results. In the first half of the 20th century the Empresa Fábrica de Mieres extracted a siderite iron ore, more or less transformed into goethite, which in some parts were also rich in manganese.

One of these old workings, in which iron ores are scarce, and that was probably exploited for argentiferous galena, is located on the NE hillside, in the area near the top of the mountain known locally by the name La Reixidora, or Reixidoira. The primary mineralization consists mainly of galena, with some chalcopyrite, and can be found in mica schists of

the Los Cabos series, of Middle Cambrian - Lower Ordovician age. Currently the galena appears only as disseminations or small grained masses, and the chalcopyrite as grains of millimetric size. However, the relative scarcity of carbonate and the presence of chloride in the medium have lead, despite the very simple primary mineralization, to an “exotic” paragenesis of secondary minerals, especially copper and lead chlorides with no known equivalent until now in Spanish geology. This paragenesis is found in fissures in grey or light brown mica schists, and is especially interesting since these are secondary minerals but were formed before the completion of mine workings, contrary to what happens in other locations. In addition, other secondary minerals appear in another distinct association, within cavernous quartz, associated with iron oxides. Given that the primary mineral exploited was supposedly argentiferous galena, it is noteworthy that no secondary silver-bearing minerals have been found so far, such as chlorargyrite or boleite. All the minerals described here have been identified by SEM-EDS and by X-ray diffraction.

Cotunnite. Coloform aggregates and corroded microcrystals. SEM photo J. Viñals.

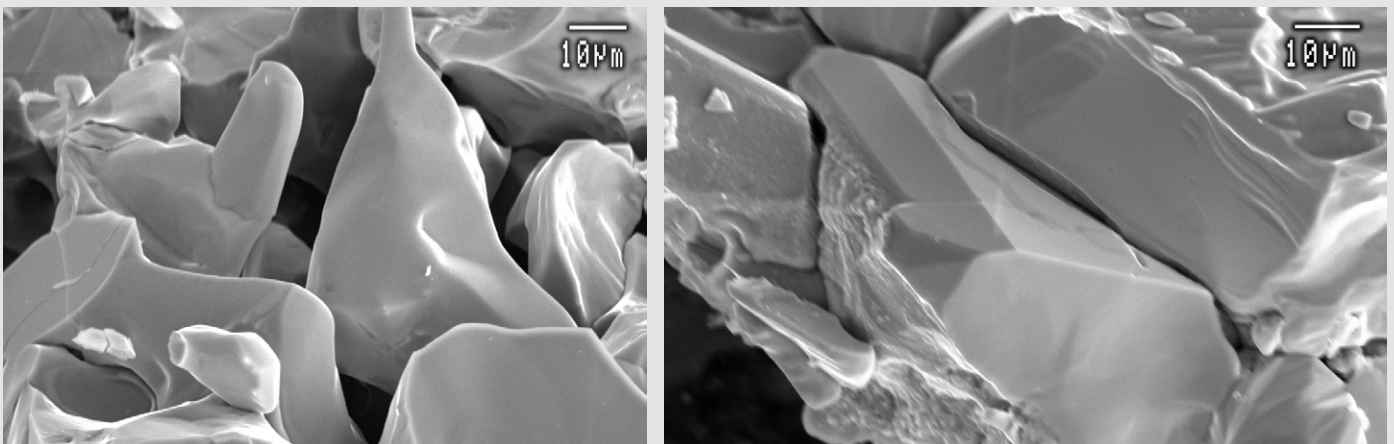

Cotunnite $PbCl_2$

Cotunnite is a relatively common mineral in one of the old galleries of this mine, appearing inside vugs in cavernous quartz, associated with oxides of iron and manganese and occasionally with anglesite, cerussite and cumengeite.

It is found forming compact crusts of white color, waxy aspect, and coloform texture, sometimes relatively thick, which can cover surfaces of several square centimeters. The coloform texture is maintained even when the mineral is examined by scanning electron microscopy.

Even using this technique, microcrystals can be observed only very occasionally, always with very rounded faces and

edges. Cotunnite is a rare mineral, which until now had been reported in Spain only in a few mines in the area of Cabo de Palos, in Cartagena, Murcia, as a product of alteration of galena in ferruginous veins (Guardiola, 1927). However, it is likely that it has gone unnoticed in other locations given its inconspicuous appearance.

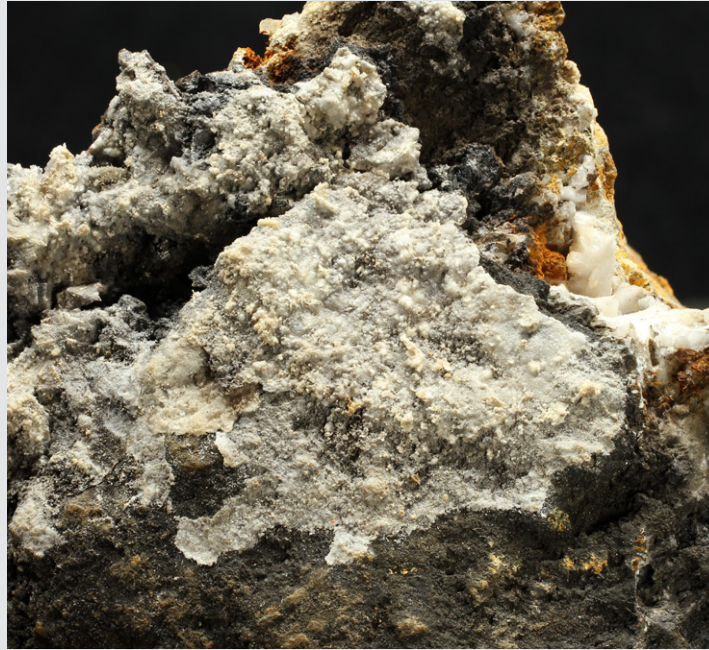

Cotunnite forming a crust on iron and manganese oxides. La Reixidora mine, Vegadeo, Asturias. FOV 5.5 cm. M. Calvo coll. Photo J. Callén.

Atacamite $Cu_2(OH)_3Cl$

Atacamite appears as small crystalline crusts of green color, associated with anglesite, cerussite, and linarite, in the schistosity planes of the mica schists.

It is easy to distinguish in this locality, since it is the only green copper mineral that appears in this association. The morphology of individual crystals, extremely small, can only be observed by scanning electron microscopy.

Diaboleite $Pb_2CuCl_2(OH)_4$

Diaboleite appears forming small dendritic growths, of millimetric length, very thin, probably due to the narrowness of the veins in which they have formed. It has an intense blue colour, and in the examined specimens it is not directly associated with any other mineral.

Considering the deposits of this mineral on a global scale, it seems that diaboleite is relatively common as a result of the alteration of old slags, but nevertheless is a rare mineral in natural deposits. This is the first deposit in which this mineral is reported in Spain, and one of the few existing natural deposits in Europe.

Atacamite microcrystals. SEM photo J. Viñals.

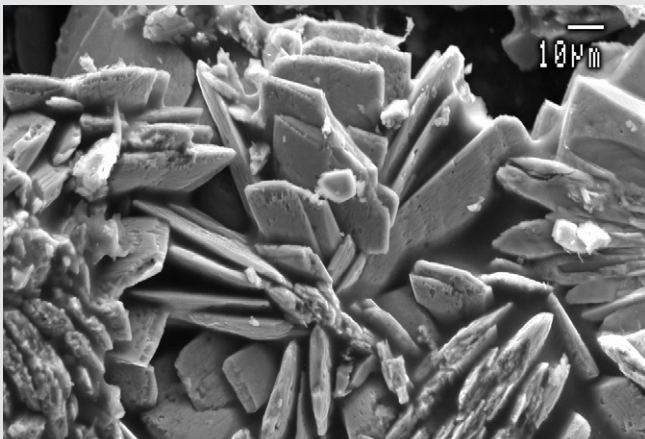

Diaboleite. Dendritic aggregates in a fracture in slate. FOV 4 mm. M. Calvo coll. Photo J. Callén.

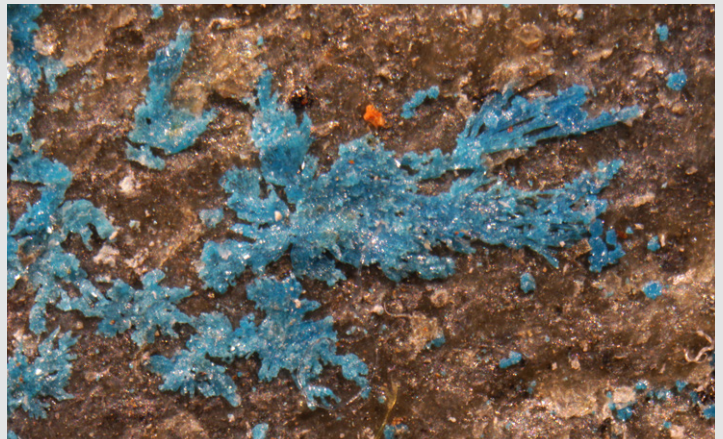

Cumengeite $\text{Pb}_{21}\text{Cu}_{20}\text{Cl}_{42}(\text{OH})_{40}\cdot 6\text{H}_2\text{O}$

Cumengeite has been found as light blue microcrystals, tetragonal bipyramidal, perfectly euhedral, with {011} as the main form, modified by {001} and {110} faces, being proportionally larger the larger the crystals are. This is the first deposit from which this mineral is reported in Spain. Cumengeite is found in two types of associations: either as microcrystals associated with anglesite and cerussite in schistose fracture planes of the slates, or associated with cotunnite in vugs in ferruginous quartz. In this second case the crystals are yet still smaller. Cotunnite and cumengeite are only formed at higher concentrations of Cl^- in the medium than the other chlorides of Pb and Cu. The joint presence of both minerals indicates that the pH of the medium was between 4 and 5, with a particularly high Cl^- content (Humpreys *et al.*, 1980).

Aragonite CaCO_3

Occasionally, aragonite has been found in the La Reixidora mine as divergent aggregates of colorless microcrystals, with the appearance of sharp wedges, forming spheres and hemispheres on the slates.

Cerussite PbCO_3

In the La Reixidora mine, cerussite is found as tabular crystals that are quite thin, colourless and transparent, or as prismatic aggregates that are strongly striated vertically, up to 1.5 centimeters in length, of white colour and a somewhat silky sheen.

They are associated with earthy iron oxides in scoriaceous quartz cavities. In some cases, cerussite crystals have disappeared, leaving a spongy mass of iron oxides with the holes where these crystals were. It is also found as somewhat shiny whitish crusts upholstering the surfaces of joints in the slates.

Phosgenite $\text{Pb}_2\text{CO}_3\text{Cl}_2$

Phosgenite appears in schistosity planes of the mica schists as whitish lamellar scabs formed by morphologically quite complex microcrystals, of an individual size of less than 100 microns, oriented in parallel. It is associated with cerussite (Calvo, 2012). It is practically impossible to distinguish from cerussite and anglesite without individually analysing the specimens.

Anglesite PbSO_4

In this mine, anglesite appears as crusts of colorless or white microcrystals, sometimes grouped in parallel, covering some schistosity planes of the slates that contain galena. It is very often associated with atacamite (Calvo, 2014).

Linarite $\text{PbCu}(\text{SO}_4)(\text{OH})_2$

The linarite appears as crusts of microcrystals of prismatic development and of the intense blue color typical of this mineral, in diaclasses of the slates, or over iron oxides in cavities in the oquerous quartz. It is associated with cerussite, anglesite and more occasionally with atacamite and caledonite (Calvo, 2014).

Cumengeite Microcrystals in a joint in the slates. SEM photo J. Viñals.

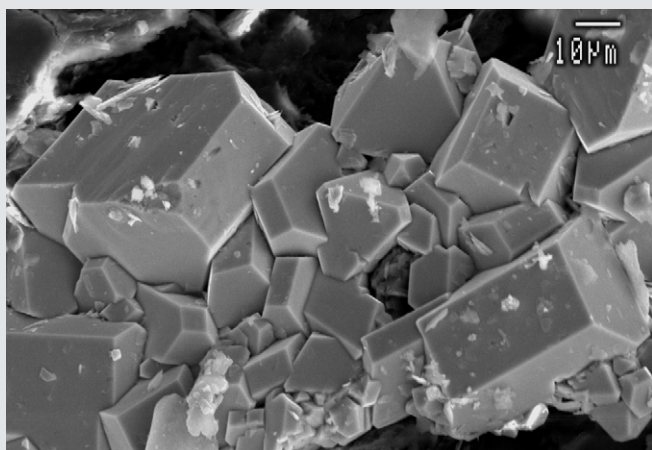

Cumengeite. Microcrystals in a joint in the slates. FOV 2 mm. M. Calvo coll. Photo J. Callén.

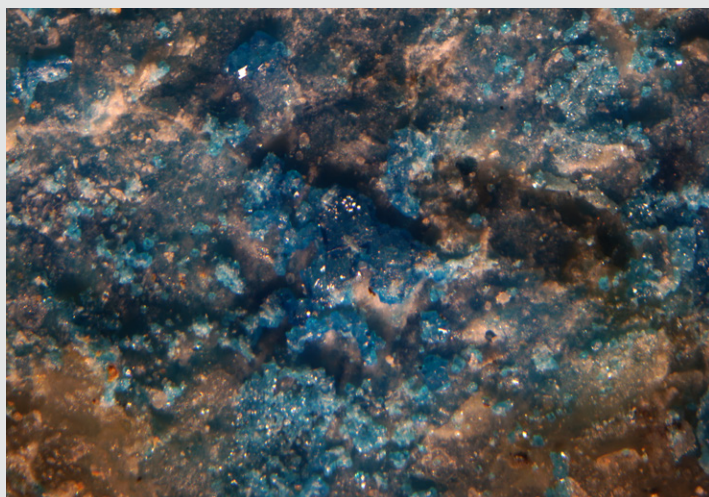

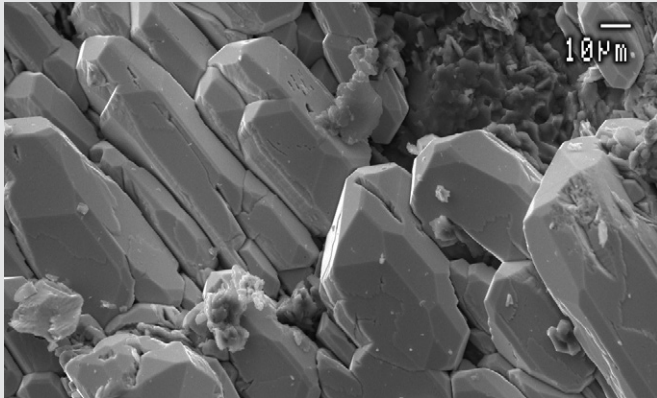

Phosgenite Microcrystals in parallel grown.
SEM photo J. Viñals.

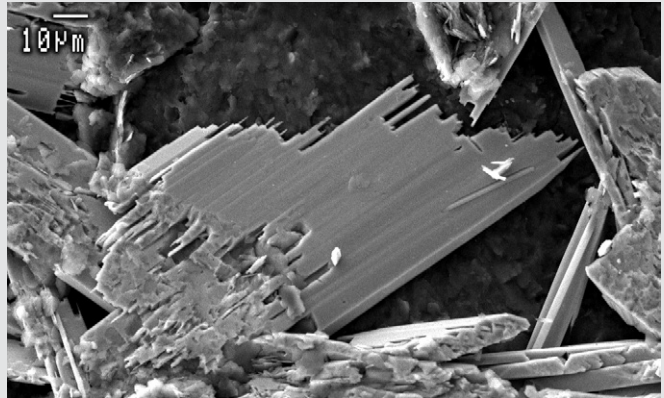

Linarite. Crystals with irregular ends.
SEM photo J. Viñals.

Caledonite (group of microcrystals on the left) and **linarite** (on the right). The color difference between the species is evident. FOV 4 mm.
M. Calvo coll. Photo J. Callén.

Caledonite $Pb_5Cu_2(SO_4)_3(CO_3)(OH)_6$

In this mine, caledonite appears as aggregates of acicular or bacillary crystals, up to 1 millimetre in length, very well defined, elongated according to [001], formed by the combination of the pinacoids {010} and {100} with the dome {101}, with modifications of small prism faces, probably {120}.



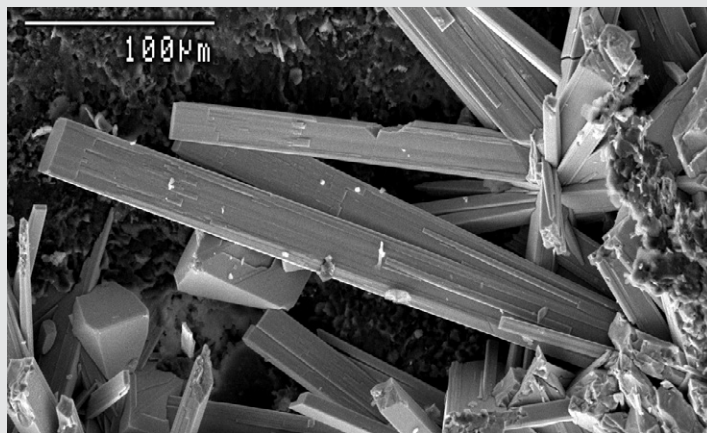

Caledonite.
Group of prismatic microcrystals associated to anglesite crystals.
M. Calvo coll.
Photo J. Callén.

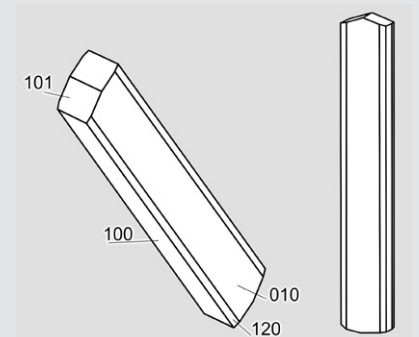

Caledonite.
SEM photo
J. Viñals.

Morphology of a caledonite crystal.

The faces of the pinacoid {100} show small parallel growths. Caledonite is pale blue, transparent or translucent, brilliant, and is associated with linarite and anglesite in fissures in the grey slates (Calvo, 2014). The difference in color with linarite makes it very easy to distinguish them in this paragenesis.

Acknowledgments

We thank José Rafael González López and Agustín Sanz Real, who have contributed some of the samples used in the analysis.

References

- Calvo, M. (2003). *Minerales y Minas de España*. Vol II, Sulfuros y Sulfosales Museo de Ciencias Naturales de Álava, Vitoria. 705 p.
- Calvo, M. (2012). *Minerales y Minas de España*. Vol. V. Carbonatos

- y Nitratos. Boratos. Escuela Técnica Superior de Ingenieros de Minas de Madrid. Fundación Gómez Pardo. 711 págs.
- Calvo, M. (2014). *Minerales y Minas de España*. Vol. VI. Sulfatos (Seleniados, Telurados), Cromatos, Molibdatos y Wolframatos. Escuela Técnica Superior de Ingenieros de Minas de Madrid. Fundación Gómez Pardo. 653 págs.
- Guardiola, R. (1927). Estudio Metalogénico de la Sierra de Cartagena. *Memorias del Instituto Geológico de España*, **33**, 564 págs.
- Humpreys, D.A., Thomas, J.N. y Williams, P.A. (1980). The chemical stability of mendipite, diaboleite, chloroxiphite, and cumengeite, and their relationships to other secondary lead(II) minerals. *Mineralogical Magazine*, **43**, 901-904.
- Paillette, A. y Bezaud, E. (1849). Coup d'oeil sur le gisement et la composition chimique de quelques minerais de fer de la province des Asturies (Espagne). *Bulletin de la Société Géologique de France*, 2^e ser., **6**, 575-599

Miguel Calvo
Zaragoza University, Spain
calvoreb@unizar.es

