



SMS Alarm System for Weather Station using Arduino and GSM

Ma May Zin Oo, Dr. Nay Win Zaw, Daw Khin San Win

Department of Electronic Engineering,
West Yangon Technological University, Yangon, Myanmar

ABSTRACT

Nowadays, the monitoring of weather is utilized to make many important decisions on a daily routine. So, by using one of the technologies, this alarm system is designed for real-time weather station using Arduino and GSM module. This real-time weather station is to send the LCD display and the alert to the user via short message sending (SMS) in the wake of a critically of an event which is predefined by the user. One of the important applications of the system is to send the alarm message to the defined mobile phone number. This system is to be convenient for monitoring the weather conditions without manual efforts.

Keywords: *Arduino Uno, GSM Module, Temperature and Humidity Sensor (DHT11), Wind Speed Sensor, LCD display.*

INTRODUCTION

Basically, SMS alarm system is the warning which sends important information of weather data. Weather is the state of the atmosphere, that it is hot or cold, wet or dry, calm or stormy, clear or cloudy. The weather conditions are closely relative to the production, the agricultural field, human life and so on. So people are trying to forecast the weather condition with many methods. This system is designed for sending the important SMS that limits wind speed and temperature value by the user.

PROPOSED SYSTEM

Arduino Uno (ATmega 328P)

In SMS alarm system, Arduino Uno board is used. Arduino is an open source device, a prototyping board consisting of ATmega 328P microcontroller providing a 5V and 3.3V output voltage option. It takes input voltage from either connecting USB to the computer

or either using a coaxial cable using a portable power supply. On the Arduino Microcontroller, sketches can be uploaded using Arduino IDE (Integrated Development Environment). It has 14 digital input/output pins (of which 6 can be used as PWM outputs), 6 analog inputs, a 16 MHz crystal oscillator, a USB connection, a power jack, an ICSP header, and a reset button. It contains everything needed to support the microcontroller; simply connect it to a computer with a USB cable or power it with a AC-to-DC adapter or battery to get started. It takes input voltage in between 7-12V.

Features:

- Microcontroller: ATmega328
- Operating Voltage: 5V
- Input Voltage (recommended): 7-12V
- Input Voltage (limits): 6-20V
- Digital I/O Pins: 14 (of which 6 provide PWM output)
- Analog Input Pins: 6
- DC Current per I/O Pin: 40 mA
- DC Current for 3.3V Pin: 50 mA
- Flash Memory: 32 KB of which 0.5 KB used by boot loader
- SRAM: 2 KB
- EEPROM: 1 KB
- Clock Speed: 16 MHz
- SRAM: 2 KB
- EEPROM: 1 KB
- Clock Speed: 16 MHz

Software Requirements:

The Arduino is open source Integrated Development Environment or Arduino Software (IDE). It contains a text editor for writing code, a message area, a text

console, a toolbar with buttons for common functions and a series of menus.

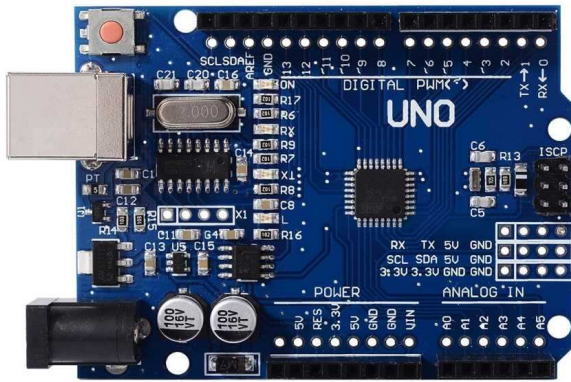

Figure1. Arduino Uno (ATmega 328P)

GSM Module (SIM 900A)

GSM/GPRS Modem-RS232 is built with Dual Band GSM/GPRS engine-SIM900A, works on frequencies 900/1800 MHz. The Modem is coming with RS232 interface, which allows for connecting PC as well as microcontroller with RS232 Chip (MAX232). The baud rate is configurable from 9600-115200 through AT command. The GSM/GPRS Modem is having internal TCP/IP stack to connect with internet via GPRS. It is suitable for SMS, Voice as well as DATA transfer application in M2M interface. The onboard regulated power supply allows the wide range unregulated power supply. Using this modem, audio calls, SMS, Read SMS (attend the incoming calls and internet etc.) is made through simple AT commands.

Features:

- Dual band GSM/GPRS 900/1800MHz.
- Configurable baud rate.
- SIM card holder.
- Built in network status LED.
- Inbuilt powerful TCP/IP protocol stacks for internet data transfer over GPRS.
- Control via AT commands.
- Low power consumption: 1.5mA (sleep mode).



Figure2. GSM module (SIM 900A)

DHT11 Sensor

The DHT11 is a temperature and humidity sensor. It is calibrated against a digital signal output. The DHT11 ensures reliability, high efficiency and stability for a long time which is present with the help of this digital-signal-acquisition exclusive technique. This temperature and humidity sensor have an NTC temperature component for measuring the temperature and a very high-performance 8-bit microcontroller connected for humidity, which is cost effective and provides an excellent quality and fast response ability with anti-interference. It consists of 4 pins from left to right Vcc, Data, NC (not connected) and GND. There are mainly three (Vcc, Data and GND) pins which are used.

Features:

- Full range temperature compensated.
- Relative measuring of humidity and temperature.
- Calibrated digital signal.
- Outstanding long-term stability.
- Extra components not needed.
- Long transmission distance.
- Low power consumption.
- 4 pins packaged and fully interchangeable.

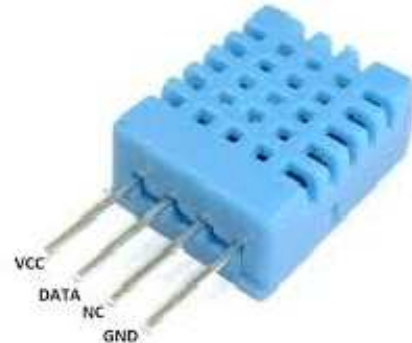

Figure3. DHT11

Wind Speed Sensor

Wind speed, or wind velocity, is a fundamental atmospheric rate. Wind speed is the rate of the movement of wind in distance per unit of time. In other word it is the rate of movement of air flow. When the air is moving from high pressure to low pressure then the wind speed is occur. It can be reported in a couple of ways: knots or nautical miles per hour, or statute miles per hour. Besides being used as part of a weather monitoring station there are many other situations where measurement and knowledge of the wind condition helps in decision-making such as pollution control, safety of tall structures, control of wind turbines, studies on the effects of wind on crops, management of ships and aircraft landing systems.

Moreover, by using anemometer we able to measure wind speed which is useful to predict when the storms will reach a certain area, what equipment might be necessary for the outdoors and how much preparation an individual might need to take to be safe within their home during inclement weather. Generally, wind speed is measured with an anemometer.



Figure4. Wind speed sensor

Features:

- DC power supply: 10~30V DC.
- Communication Interface: Pulse output.
- Measuring range: 0~60m/s.
- Dynamic response time: ≤0.5s.
- Starting wind speed: ≤0.2m/s.
- Load capacity: NPN ≥100mA.

Liquid Crystal Display (LCD)

A liquid crystal display (LCD) is a display module with liquid crystals and backlight by LEDs. A 16x2 LCD display consists of two rows of display with each row consisting of 16 characters. LCD Module has 16 pins and operates with 5V. Power pins i.e. pins 1, 2, 3, 15 and 16 are used to supply for the module as well as the backlight LEDs. The voltage to the contrast adjust pin (Pin 3 or VEE) is usually given from a potentiometer and will control the contrast of the actual display when the POT is adjusted. There are 8 data pins for transmitting 8bits of data i.e., 1 byte of data at a time. The LCD can be used in either 8bit mode or 4bit mode.

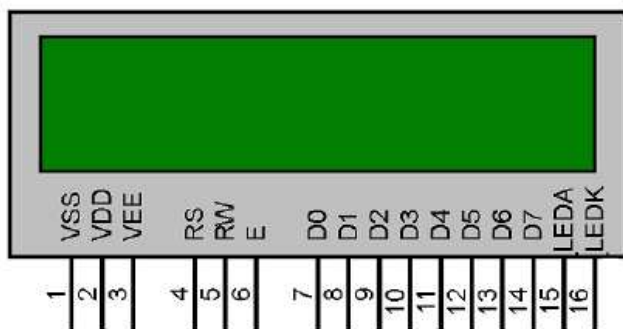

Figure5. LCD display

I²C Communication

I²C is a multi-master protocol that uses 2 signal lines. The two I²C signals are called ‘serial data’ (SDA) and ‘serial clock’ (SCL). There is no need of chip select (slave select) or arbitration logic. Virtually any number of slaves and any number of masters can be connected onto these 2 signal lines and communicate between each other using a protocol that defines:

- 7-bits slave addresses: each device connected to the bus has got such a unique address
- data divided into 8-bit bytes
- a few control bits for controlling the communication start, end, direction and for an acknowledgment mechanism.

Physically, the I²C bus consists of the 2 active wires SDA and SCL and a ground connection. The active wires are both bi-directional. The I²C protocol specification states that the IC that initiates a data transfer on the bus is considered the Bus Master. Consequently, at that time, all the other ICs are regarded to be Bus Slaves.

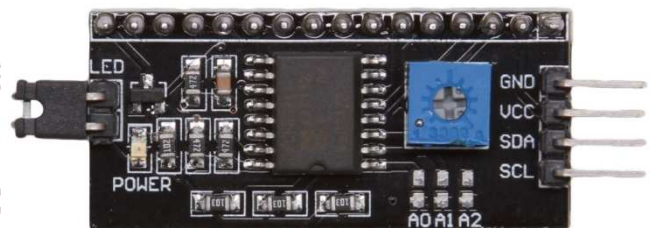

Figure6. 16x2 LCD I2C modules

DESIGN AND IMPLEMENTATION

In this system, Arduino and GSM module are used which connected to the input sensors “wind speed and temperature” and to output SMS alarm message and LCD display. Arduino is an open source hardware prototyping platform, which allows an easy implementation of sensors and interactive element. Firstly, all the components are initialized by supplying the required power of +5V. The wind speed sensor is connected to digital pin 4 of Arduino Uno board. DHT11 is a sensor to get the temperature and humidity value which is also connected to digital pin 5 of Arduino Uno board.



Figure7. Block diagram of SMS alarm system for weather station

The Arduino reads the input sensors by mean of related pins and implements the program by IDE software. It sends the alarm message to the defined mobile phone number by using GSM module when maximum temperature and wind speed are reached. The gathered data is serially fed into a computer, which uses the com port to communicate with the Arduino device and the data recorded is stored in a text file. The GSM module is used to send/receive messages and make/receive calls just like a mobile phone by using a SIM card by a network provider. The GSM shield is connected with Arduino board and then plugging in a SIM card from an operator that offer GPRS coverage. The connection of the shield makes its TX to the digital pin 2 and RX to digital pin 3 of the Arduino Uno board.

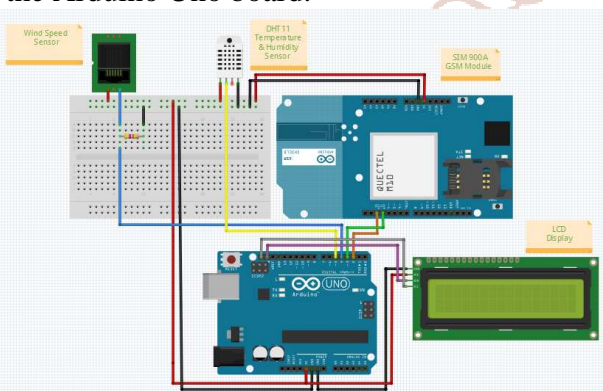

Figure8. Schematic working diagram of the system

The system is programmed to display data on LCD display continuously. It is the real time result data of the system. So the important information of the wind speed and temperature data is clearly seen on the LCD display.

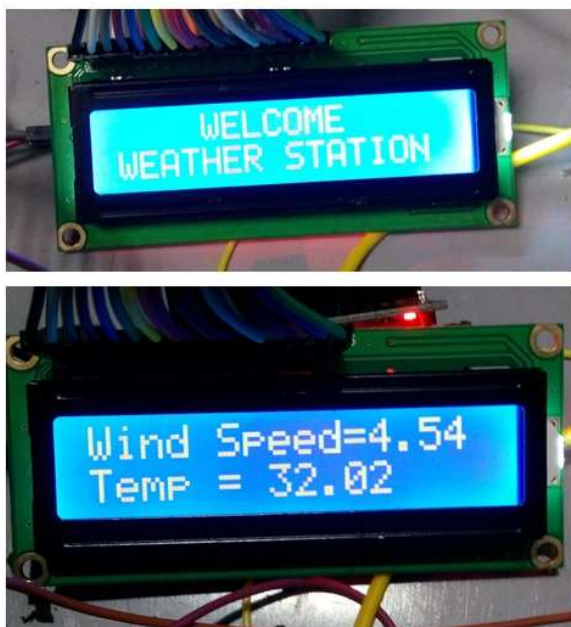

Figure9. LCD display result output

When the temperature condition is over 40°C, it sends the text “Warning! Temp SMS” to LCD display. And also when wind speed condition is reached over 40 mph, it sends the text “Warning! Wind SMS” to LCD display.

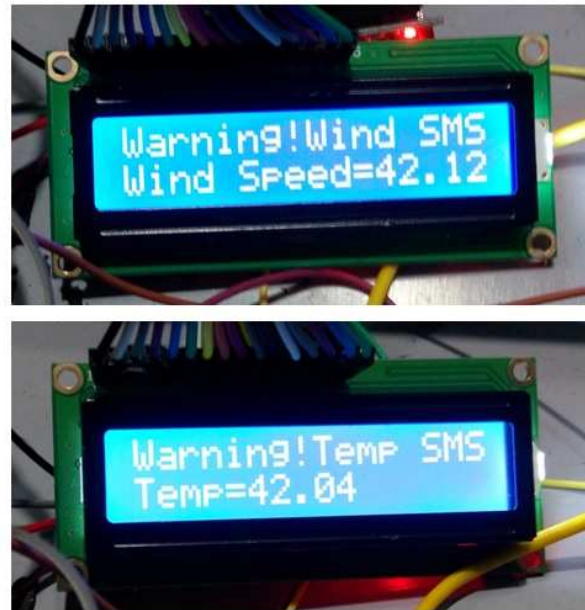

Figure10. LCD display result output over condition

Once the temperature goes above 40 °C, a SMS alert message is sent “Warning!!!, Temperature is over 40 Degree Celcius.” to the defined mobile phone number by using GSM module.

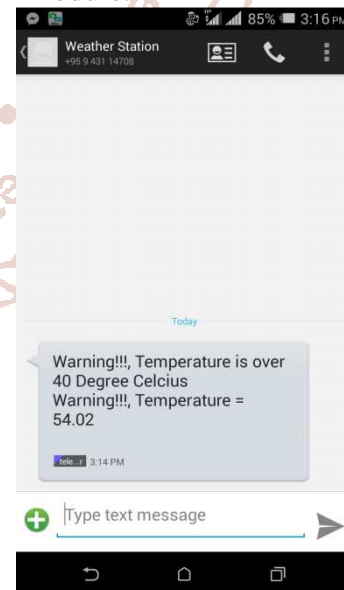

Figure11. SMS alarm message for over temperature

And also, the wind speed data goes above 40 mph, a SMS alert message is sent “Warning!!!, Wind Speed is over 40 MPH.” to the defined mobile phone number.

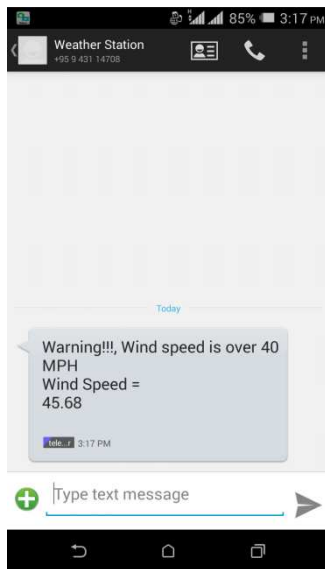

Figure12. SMS alarm message for over wind speed

CONCLUSION

The system deals with designing a simple and low cost real-time weather station using Arduino Uno, GSM module, temperature and humidity sensor (DHT11), wind speed sensor to monitor weather conditions of the desired location and send it to a defined mobile phone number at distant location through SMS. Effective integration technology has been used to ensure the sustainability of the station. Versatility in execution of data takes the pride of the effectiveness of the product in different conditions. This concludes that the present work was a success and it will provide a competent method for monitoring real time weather readings and help farmers whose livelihood depends on the weather in a country to produce better quality crops. The SMS alarm message system is often utilized to make many important decisions on a daily routine. These weather forecasts are issued to reduce property damage, reduce crop damage, save lives, and so on. Therefore, Limitations of the system are mentioned below:

- The amount of sensor is less.
- It is not web based system.
- It is needed the GSM/GPRS network for SMS messaging.

FUTURE SCOPE

In future, sensors are used as much to analyze the weather station and a web interface or service to feed the data directly to internet could also be built. The system can be improved by adding new functionalities like wind direction sensor, LDR sensor, rain fall sensor, moisture sensor and etc. Furthermore, this system can be used in the production, the agricultural field and etc.

REFERENCES

1. Brian W. Evans. Arduino Programming Notebook. San Francisco, California, USA. First Edition August 2007.
2. Ph.D Jack Purdum. Beginning C for Arduino. 233 Spring Street, 6th Floor, New York. Copyright @2012.
3. Karthik Krishnamurthi, Suraj Thapa, Lokesh Kothari, Arun Prakash. "Arduino Based Weather Monitoring System", International Journal of Engineering Research and General Science Volume 3, Issue 2, March-April, 2015.
4. P. Ramchandar Rao, S. Sanjay Kumar, Ch. Rajendra Prasad. "Garbage Monitoring System using Arduino", International Journal of Trend in Scientific Research and Development (IJTSRD), Volume 1, Issue 6, Sep – Oct, 2017.
5. Prof. P. R. Jawale, Mr. V. S. Ghayal, Mr. D. M. Shende, Ms. S. N. Ghogale, Ms. V. B. Nagare. "Prepaid Energy Meter using Arduino and GSM Module", International Journal of Research in Advent Technology (IJRAT), E-ISSN: 2321-9637, April 2017.
6. <https://arduino.cc>
7. <https://robocraft.ru>
8. <https://github.com>