

A PRECISION AGRICULTURE DSS BASED ON SENSOR THRESHOLD MANAGEMENT FOR IRRIGATION FIELD

Alessandro Massaro^{*}, Giacomo Meuli, Nicola Savino, Angelo Galiano

Dyrecta Lab, IT Research Laboratory, Via Vescovo Semplicio, 45, 70014 Conversano
(BA), Italy

ABSTRACT

In this paper is analyzed a case study of an industry project concerning irrigation decision support system (DSS) suitable for precision agriculture applications. In particular, a first prototype irrigation module has been developed by testing different components. The prototypal system concerns the irrigation management by reading field and weather values and, by enabling electrovalves through cloud control. A web panel will monitor in real time all sensors data, besides the DSS will activate or deactivate the irrigation pipelines. The irrigation decision is performed by comparing the measurements with pre-set threshold limits of sensor values and by analyzing predicted weather data. The paper describes in details the network design and implementation by discussing the sequence diagram describing the DSS data flow. Finally is proposed the DSS algorithm by discussing the DSS logic and its first implementation. The proposed DSS behaves as an engine processing simultaneously multiple parameters. The goal of the paper is to prove how potentially a microcontroller can perform a DSS which can be customized for different cultivations.

KEYWORDS

Irrigation DSS, Precision Agriculture, Irrigation Management systems, Cloud Data Transmission and Control, Cloud Sensing and Actuation .

1. INTRODUCTION

Some researchers have analyzed the fertigation process by enhancing the importance of the control of the temperature and relative humidity as management parameters [1]. This analysis suggests the use of temperature and humidity sensors as reference sensors for monitoring soil conditions and for a water support forecast. Other researchers have implemented a series of sensors and the photovoltaic panel to supply a completely independent fertigation platform [2], thus suggesting the use of solar energy to power the electrical part and the electronic system of a fixed platform. On the other hand, recent studies have highlighted the importance of the irrigation "scheduling", by discussing how for each different type of vegetables the optimal conditions should vary [3]. For this reason, a preliminary study of the type of farm to be monitored, of the relative substances it requires for growth, and of the knowledge of the type of land are of primary importance. Other studies have shown how the amount of water to be administered to the plantations can be estimated using empirical formulas [4], thus suggesting to formulate an analytical model that can support decisions. Other scientific studies have focused attention on the type of layout associated with irrigation and fertigation [5], discussing the importance of the valves for the distribution of water in the different pipes. These studies prove that an irrigation platform should be associated with a very specific type of farm. The concept of automated irrigation has been analyzed in several studies, as for tomato and cucumber plantations based on tensiometric probe analysis [6]. The automation of irrigation can be structured by a functional architecture based on two fields or sections such as [7]:

- Field Section;
- Control Section.

The field section is characterized by a microcontroller connected to the various sensors and components associated with the field monitoring facilities. The control section concerns mainly data transmission and data reception systems implemented by means of electronic boards operating in the cloud. An example of cloud connection is the Zigbee wireless protocol execution.

In [7] a decision system has been developed by controlling threshold values, where the irrigation pumps are activated for values below the threshold. In [8] the attention has been focused on General Packet Radio Service –GPRS– systems supporting irrigation decisions. In the literature there are also indications about activation procedures of the fertigation process, based on the analysis of electrical conductivity (EC) and on the pH analysis [9]. The processes that can potentially be automated in agriculture are in [10]:

- Soiling;
- Sowing;
- Fertilization;
- Irrigation.

Of particular interest is micro-irrigation or "localized irrigation" or drip irrigation [11], which is an irrigation method that slowly administers water, either by depositing the water on the field surface adjacent to the plant or directly to the root area: this occurs through a network system that includes valves, pipelines and various types of drippers. In the case in which a DSS system exists, the water may not be continuous and not of the "drop" type, since the quantity of water needed only in the case in which a certain amount of water is assessed and / or forecasted could be administered in the right time. The water balance can be analyzed by considering several factors such as historical data, climatic data, thresholds and others [12]. These factors can be adopted to formulate an efficient DSS algorithm able to define automatically the volumes to be irrigated [12]. The DSS systems in agriculture concern various functionalities, and usually are associated with the communication system [13],[14]. For a good design of an irrigation network, a first morphology analysis of the field to irrigate is essential [15]. The quantities of water to administer can be traced into a curve that identifies the conditions of deficit, optimal or water regime conditions according to the soil yield [16]. In any case, the sensors associated to a DSS system [17], and the electronics associated with the DSS [18], are important topics for irrigation management and remote sensing control and actuation [19]. Precision Agriculture (PA) represents an innovative way to manage farms by introducing the Information and Communication Technology (ICT) integrating DSS. In Hydrotech project [20]-[21] have been developed different hardware and software tools listed in the table 1:

Table 1. Tools developed in Hydrotech project [20]-[21].

Hardware tool	Function
RTU (remote terminal unit) data logger	Allow continuous acquisition of data from the soil - plant - atmosphere system thanks to the connection with appropriate sensors. The RTU field is connected to particular 'capacitive' type probes, for the detection of the volumetric content of water, soil temperature and salinity at different ground depths. The meteorological RTU behaves as a real agrometeorological station.
Coordinator board	The coordinator has the task of receiving data, storing, processing and forwarding them to the cloud. Transmission to remote servers normally takes place via a GSM/ GPRS system (hourly and daily transmission). The coordinator activate also the electrovalves by cloud.
Software tool	Function
IT system and basic DSS	The IT system was developed to operate at the 'cloud' level, and therefore data storage and information processing are carried out in remote servers, so that the application can be consulted anywhere and using different types of devices. A management software, through an interfaces, offers the user the possibility to: (i) manage the information and the parameters of all the batches configured for a certain company, (ii) view the observed and forecasted meteorological data, (iii) manage the irrigation register for each lot, (iv) display information on the results of the financial statements, the measurements of the sensors and the status of the system, (v) receive suggestions for the management of irrigation interventions sending commands for remote control of irrigation systems (valves, hydrants and pumps). The system is connected to a mobile APP.

Following the state of the art, in this work is optimized the technology proposed in [20]-[21] thus introducing an advanced DSS based on the simultaneous analysis of atmosphere parameters and field data taking into account weather prediction.

1.1 MAIN PROJECT ARCHITECTURE AND PROTOTYPE SPECIFICATIONS

According to the goal expressed in the introduction section, the work analyzes a prototype of an advanced DSS, with the aim of integrating new software and hardware technologies including sensors for continuous monitoring, and systems for remote control of the water distribution. The DSS will integrate weather forecasting and new water balance models based on the simultaneous evaluation of different sensor values. The proposed system has been designed for the water management of the fourth-range products.

The whole industry project specifications and outputs are:

Design of the "grafts" of the pipeline network for the fertilizer introduction;

- Design and implementation of DSS algorithms based on threshold control.;
- Design of the layout of the water network related to a particular type of fourth range planting;
- Analysis of the optimal conditions of water and fertilizer to be administered;
- Design and determination of data loggers that will allow continuous acquisition of data from the soil/plant/atmosphere system thanks to the connection with appropriate sensors;
- Implementation of weather data acquisition sensors (wind, temperature, etc.);
- Implementation of power supply circuitry and actuators by means of a photovoltaic panel;
- Implementation of the microcontroller and wireless data transmission system (using the ZigBee protocol);

- Implementation of sensors for the detection of soil data deemed suitable for the type of cultivation (to be defined in the design phase);
- Implementation of a server transmission system through GSM/GPRS;
- Design and implementation of the database and control platform;
- Reception of commands directly from the cloud (outputs of the DSS algorithm);
- Implementation of the control unit able to activate and to deactivate the electro valves;
- Implementation of the system for sending control and diagnostic signals to the cloud;
- Data storage and processing of information from a remote server (information that can be consulted anywhere, using smart phones and tablets);
- Implementation of software interfaces managing the prototype system and the DSS.

Figure 1 shows the general scheme of the design prototype, which includes the design specifications. The prototype results proposed in this paper will be related to the hardware of the fixed platform and to the advanced DSS algorithm of the only irrigation process.

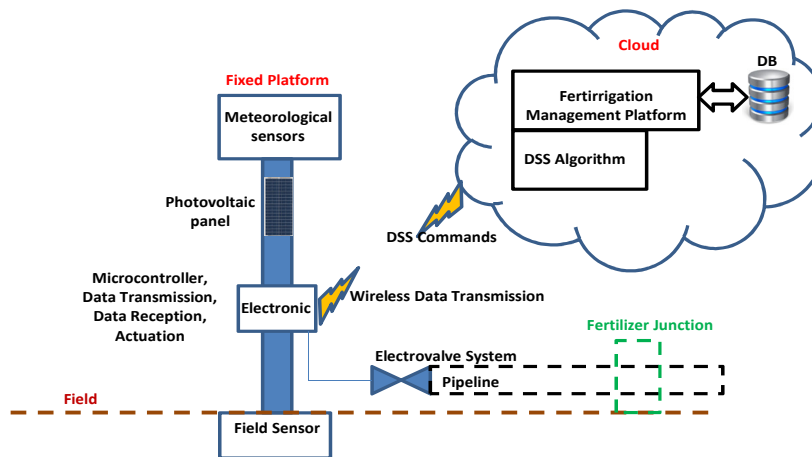

Figure 1. Architecture of the DSS of the project 'DSS Fertirrigation 4th range'.

2. PROTOTYPE SYSTEM

The architecture proposed in Fig.2 summarizes the hardware and the software facilities of the prototypal irrigation system. The devices representing the "Coordinator" communicates with each sensors by the ZigBee protocol. ZigBee is a high-level communication protocol, based on the 802.15.4 standard, which has been standardized mainly for automation and sensors, especially for solutions that provide for the creation of low-level Wireless Personal Area Network (WPAN) cost, and low energy consumption for networks having an high number of nodes. The Coordinator communicates with cloud by General Packet Radio Service (GPRS) technology.

The ZigBee devices are divided in the following three categories:

- ZigBee Coordinator. it is the device that creates and configures the network, defining the identification number of the fixed platform (PAN id). Once the network is started, it goes into Coordinator mode, allowing routing and end device communications. The Coordinator is unique for each network and is a "full function device", so it cannot stay in "sleep" mode because it must comply with its various functions, including routing.

- ZigBee Router. It allows the forwarding of messages (thus increasing the coverage distances of the network) and decides to accept or not requests of other devices. Multiple ZigBee Routers may be present in the same network.
- ZigBee End Device (sensors) with low energy consumption.

The sensor system ("Weather Station" and "Field station") is placed in fields where there is no electricity, so there is a need to use devices that absorb low energy, which can be powered through photovoltaic panels, small batteries. The low energy consumption is improved by implementing the "sleep" mode (function useful for the periods when the sensor transmission is not required). Through the ZigBee protocol, different communication topologies can be assumed such as star, tree and mesh. For the use case, the star topology has been chosen because few nodes are connected to the network, and for its simplicity of management and implementation: the "Coordinator" Wasmote (WeliMote PRO v12 of Libelium) has been set as Coordinator of the middle of the star, while others three Wasmote behaves as routers. The WeliMote PRO v12 of Libelium, has both the battery socket and the "solar socket" so it was not necessary to add a complementary circuitry for the connection of the photovoltaic panel and for the management of the battery charge. The ZigBee communication between the various Wasmote is defined as follows:

- Coordinator: the "Coordinator" receives ZigBee frames from the "Weather Station" and the "Field Station", and sends frames containing the commands for opening and closing the valves to the Wasmote "Electrovalves";
- Weather Station: the station sends frames to the "Coordinator" containing the values measured by the various weather sensors;
- Field Station: the station sends frames to the "Coordinator" containing the values detected by the ground probes;
- Electrovalves: this module receives the frames from the "Coordinator" containing the commands related to the activation/deactivation of the electrovalves.

By the cloud the Coordinator is connected to a web platform embedding the DSS algorithm. In table 1 are listed some components used for the experimentation with main specifications. In Fig. 3 is illustrated the location of the Wasmote Coordinator: the board is enclosed into a box that repairs it from atmospheric agents.

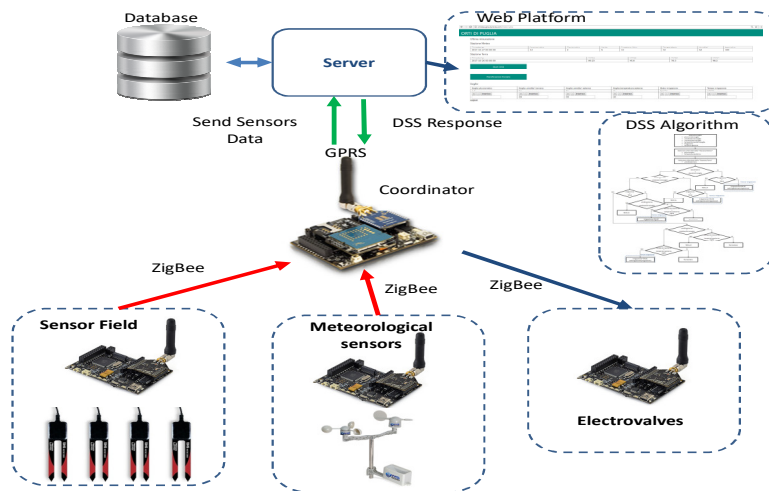
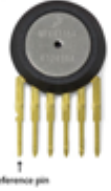





Figure 2. Architecture of the Irrigation DSS Prototypal System.

Table 1. Sensors and electronic devices of the irrigation prototype system

Photo of adopted Sensor/Device	Description																																											
 <p>Reference pin</p>	<p>MPX4115A (atmospheric pressure sensor)</p> <table border="1" data-bbox="787 317 1156 541"> <tr> <td>Measurement range</td> <td colspan="3">15 ~ 115kPa</td> </tr> <tr> <td>Output signal</td> <td colspan="3">0.2 ~ 4.8V (0 ~ 85°C)</td> </tr> <tr> <td>Sensitivity</td> <td colspan="3">48mV/kPa</td> </tr> <tr> <td>Accuracy</td> <td colspan="3">≤±1.5%V (0 ~ 85°C)</td> </tr> <tr> <td>Typical consumption</td> <td colspan="3">7mA</td> </tr> <tr> <td>Maximum consumption</td> <td colspan="3">10mA</td> </tr> <tr> <td>Supply voltage</td> <td colspan="3">4.85 ~ 5.35V</td> </tr> <tr> <td>Operation temperature</td> <td colspan="3">-40 ~ +125°C</td> </tr> <tr> <td>Storage temperature</td> <td colspan="3">-40 ~ +125°C</td> </tr> <tr> <td>Response time</td> <td colspan="3">20ms</td> </tr> </table>				Measurement range	15 ~ 115kPa			Output signal	0.2 ~ 4.8V (0 ~ 85°C)			Sensitivity	48mV/kPa			Accuracy	≤±1.5%V (0 ~ 85°C)			Typical consumption	7mA			Maximum consumption	10mA			Supply voltage	4.85 ~ 5.35V			Operation temperature	-40 ~ +125°C			Storage temperature	-40 ~ +125°C			Response time	20ms		
Measurement range	15 ~ 115kPa																																											
Output signal	0.2 ~ 4.8V (0 ~ 85°C)																																											
Sensitivity	48mV/kPa																																											
Accuracy	≤±1.5%V (0 ~ 85°C)																																											
Typical consumption	7mA																																											
Maximum consumption	10mA																																											
Supply voltage	4.85 ~ 5.35V																																											
Operation temperature	-40 ~ +125°C																																											
Storage temperature	-40 ~ +125°C																																											
Response time	20ms																																											
	<p>WS-3000 (Weather Platform)</p> <ul style="list-style-type: none"> -Wind Sensor -Rain Gauge -Anemometer 																																											
	<p>Decagon 5 TE (field temperature sensor)</p> <table border="1" data-bbox="748 829 1218 1213"> <thead> <tr> <th></th> <th>VWC</th> <th>Temperature</th> <th>Electrical conductivity</th> </tr> </thead> <tbody> <tr> <td>Accuracy</td> <td>Generic calibration equation: $\pm 0.03 \text{ m}^3/\text{m}^3$ ($\pm 3\%$ VWC) typ Medium Specific Calibration: $\pm 0.02 \text{ m}^3/\text{m}^3$ ($\pm 2\%$ VWC)</td> <td>$\pm 1^\circ\text{C}$</td> <td>$\pm 10\%$ from 0 to 7 dS/m, user calibration required from 7 to 23 dS/m</td> </tr> <tr> <td>Resolution</td> <td>0.0008 m^3/m^3 (0.08% VWC) from 0 ~ 50% VWC</td> <td>0.1°C</td> <td>0.01 dS/m from 0 to 7 dS/m, 0.05 dS/m from 7 to 23 dS/m</td> </tr> <tr> <td>Range</td> <td>0 ~ 1 m^3/m^3 (0 ~ 100% VWC)</td> <td>-40°C to +50°C</td> <td>0-23 dS/m</td> </tr> </tbody> </table>					VWC	Temperature	Electrical conductivity	Accuracy	Generic calibration equation: $\pm 0.03 \text{ m}^3/\text{m}^3$ ($\pm 3\%$ VWC) typ Medium Specific Calibration: $\pm 0.02 \text{ m}^3/\text{m}^3$ ($\pm 2\%$ VWC)	$\pm 1^\circ\text{C}$	$\pm 10\%$ from 0 to 7 dS/m, user calibration required from 7 to 23 dS/m	Resolution	0.0008 m^3/m^3 (0.08% VWC) from 0 ~ 50% VWC	0.1°C	0.01 dS/m from 0 to 7 dS/m, 0.05 dS/m from 7 to 23 dS/m	Range	0 ~ 1 m^3/m^3 (0 ~ 100% VWC)	-40°C to +50°C	0-23 dS/m																								
	VWC	Temperature	Electrical conductivity																																									
Accuracy	Generic calibration equation: $\pm 0.03 \text{ m}^3/\text{m}^3$ ($\pm 3\%$ VWC) typ Medium Specific Calibration: $\pm 0.02 \text{ m}^3/\text{m}^3$ ($\pm 2\%$ VWC)	$\pm 1^\circ\text{C}$	$\pm 10\%$ from 0 to 7 dS/m, user calibration required from 7 to 23 dS/m																																									
Resolution	0.0008 m^3/m^3 (0.08% VWC) from 0 ~ 50% VWC	0.1°C	0.01 dS/m from 0 to 7 dS/m, 0.05 dS/m from 7 to 23 dS/m																																									
Range	0 ~ 1 m^3/m^3 (0 ~ 100% VWC)	-40°C to +50°C	0-23 dS/m																																									
	<p>DS 1820 (external temperature sensor)</p> <ul style="list-style-type: none"> • Supply voltage from 3.0V to 5.5V; • $\pm 0.5^\circ\text{C}$ Accuracy from -10°C to $+85^\circ\text{C}$; • Measurable temperature range: -55 to 125°C (-67°F to $+257^\circ\text{F}$); • 9 to 12 bit of resolution; • Single digital connection cable; • Response time: less than 750ms. 																																											
	<p>Decagon 10HS (Volumetric Water Content-VWC-)</p> <table border="1" data-bbox="748 1428 1218 1766"> <tr> <td>Range</td> <td>Apparent dielectric permittivity (K_d): 1 (air) to 50 Soil volumetric water content: 0 ~ 0.57 m^3/m^3 (0 ~ 57% VWC)</td> </tr> <tr> <td>Accuracy</td> <td>Apparent Dielectric Permittivity (K_d): ± 0.5 from (K_d) of 2 to 10, ± 2.5 from (K_d) of 10 to 50 (VWC) VWC: Using standard calibration equation: $\pm 0.03 \text{ m}^3/\text{m}^3$ ($\pm 3\%$ VWC) typical in mineral soils. Using soil site specific calibration, $\pm 0.02 \text{ m}^3/\text{m}^3$ ($\pm 2\%$ VWC)</td> </tr> </table>				Range	Apparent dielectric permittivity (K_d): 1 (air) to 50 Soil volumetric water content: 0 ~ 0.57 m^3/m^3 (0 ~ 57% VWC)	Accuracy	Apparent Dielectric Permittivity (K_d): ± 0.5 from (K_d) of 2 to 10, ± 2.5 from (K_d) of 10 to 50 (VWC) VWC: Using standard calibration equation: $\pm 0.03 \text{ m}^3/\text{m}^3$ ($\pm 3\%$ VWC) typical in mineral soils. Using soil site specific calibration, $\pm 0.02 \text{ m}^3/\text{m}^3$ ($\pm 2\%$ VWC)																																				
Range	Apparent dielectric permittivity (K_d): 1 (air) to 50 Soil volumetric water content: 0 ~ 0.57 m^3/m^3 (0 ~ 57% VWC)																																											
Accuracy	Apparent Dielectric Permittivity (K_d): ± 0.5 from (K_d) of 2 to 10, ± 2.5 from (K_d) of 10 to 50 (VWC) VWC: Using standard calibration equation: $\pm 0.03 \text{ m}^3/\text{m}^3$ ($\pm 3\%$ VWC) typical in mineral soils. Using soil site specific calibration, $\pm 0.02 \text{ m}^3/\text{m}^3$ ($\pm 2\%$ VWC)																																											



	Resolution	(K_1): 0.1 from K_1 of 1 to 30, 0.2 from (K_1) of 30 to 50 VWC: 0.0008 m ³ /m ³ (0.08% VWC) in mineral soils from 0 to 0.50 m ³ /m ³ (0-50% VWC)
	Time	10ms
	Wasp mote PRO v1.2 (Microcontroller)	
	Microcontroller	ATmega 1281
	Frequency	14.7456 Mhz
	SRAM	8 KB
	EEPROM	4 KB (1KB reserved)
	FLASH	128 KB
	SD Card	2 GB
	Weight	20 g
	Dimensions	73.5 x 51 x 13 mm
	Temperature range	-10°C + 65°C
	Clock	RTC (32 KHz)
	802.15.4/ZigBee Antenna	
	Model	XBee-802.15.4-Pro
	Protocol	802.15.4
	Frequency	2.4GHz
	txPower	100mW
	Sensitivity	-100dBm
	Range	7000m
	Connector	RPSMA
	Encryption	AES 128b
	Control Signal	RSSI
	Standard	XBee-802.15.4
	SIM900 GSM/GPRS module	
	Model	SIM900(SIMCom)
	Quadband	850MHz/900MHz/1800MHz/1900MHz
	TX Power	2W (Class 4) 850MHz/900MHz, 1W (Class 1) 1800MHz/1900MHz
	Sensitivity	-109dBm
	Antenna connector	UFL
	External Antenna	0dB
	Consumption in power down mode	30µA



Figure 3. (Left) Final prototype System; (Right) Location of the Wasp mote Coordinator.

2.1 UML SEQUENCE DIAGRAM: DESIGN OF THE AUTOMATED PROCESS

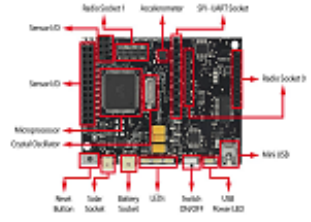
In this section is illustrated the UML (Unified Modeling Language) sequence diagram describing the automation process of the proposed DSS. This diagram is shown in Fig. 4. Below is described the system operation concerning all the data flow.

The Waspnote "Coordinator" is equipped with a GPRS module to communicate with the cloud server. This communication mainly concerns the following two activities:

- sending data received from the "Weather Station" and the "Field Station" to the server;
- reception from the server of the electrovalves opening/closing commands dictated by the evaluation of the DSS algorithm.

Following these main activities, the sequence diagram describes the main scenario related to the activation and the deactivation of the electrovalves. The data flow starts with the sending of data from the "Field Stations" and from the "Weather Station" to the "Coordinator". The "Coordinator" will send the measurements to the server, which will save them into a MySQL database where is set the arrival timestamp. The DSS algorithm will iteratively select the latest readings of the "Weather Station" and the "Field Station", by comparing the measurements with defined thresholds. The results of the DSS algorithm will enable the commands of the electrovalves. After the reading process will be saved into the database the electrovalve status (via an HTTP POST). Finally, the "Coordinator" will receive the command and forward it to the Waspnote "Electrovalves" for opening and closing actions.

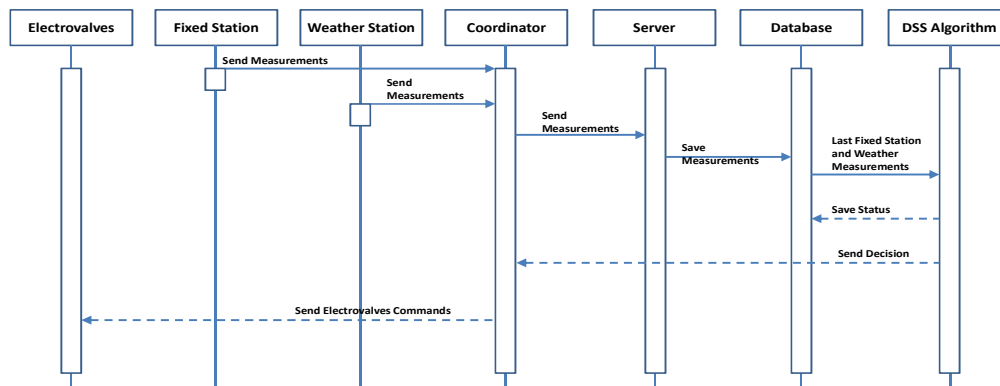

Figure 4. UML sequence diagram describing data flow automation of the DSS.

2.2 DATABASE SYSTEM

For the web platform a MySQL database has been designed having the following functionalities:

- keep track of the users enabled for the service;
- set and save the thresholds characterizing the decision algorithm;
- save the data coming from the sensors placed on the "Field Station" by means of the timestamp setting;
- save the data coming from the sensors placed on the "Field Station" by means of the timestamp setting.

Four tables have been created as follows:

1- Login: table containing the username enabled with the corresponding password. Below are described the attributes of this table:

- user_id: it is the primary key of the table that uniquely identifies a given user;
- username: represents the user's name;
- password: represents the password corresponding to the username.

2- Settings: table in which the thresholds of the decision algorithm are saved. Below are described the attributes of this table:

- id: identifier set to 0 to trace the first row of the table;
- pluviometrosoglia: it is the threshold that will be compared with the value of the pluviometer in the decision-making algorithm;
- umiditaterrenrenosoglia: is the threshold that will be compared with the value of soil moisture in the decision-making algorithm;
- umiditaesternasoglia: it is the threshold that will be compared with the value of the external humidity in the decision-making algorithm;
- external temperature threshold: it is the threshold that will be compared with the value of the external temperature in the decision algorithm;
- irrigation: indicates the irrigation status (0 is the inactive irrigation status, 1 is the active irrigation status);
- watering time: it indicates the time in milliseconds of the activation of the electrovalves.

3- Stazionemeteo: table relating data from the Waspote "Weather Station". Below are described the attributes of this table:

- idwaspote: it identifies the Waspote "Weather Station" selected for the measurement;
- timestamp: it is the time stamp variable referring to the measurement;
- anemometer: this is the value of the anemometer detected by the "Weather Station";
- rain gauge: this is the value of the rain gauge detected by the "Weather Station";
- vane: it is the value of the wind direction measured by the "Weather Station";
- pressure: it is the value of the atmospheric pressure detected by the "Weather Station";
- temperature: it is the value of the external temperature measured by the "Weather Station";
- humidity: this is the value of the external humidity measured by the "Weather Station";
- luxmeter: this is the value of the external illumination detected by the "Weather Station".

4- Stazioneterra: table relating to acquisitions from the Waspote "Field Station". Below are described the attributes of this table:

- idwaspote: identifies the Waspote "Field Station" selected for the measurement;
- timestamp: it is the time stamp variable referring to the measurement;
- vwc1, vwc2, vwc3, vwc4: represent the values of the soil moisture (Volumetric Water Content) detected by the four probes of the "Field Station";

All the attributes are summarized in Fig. 5.

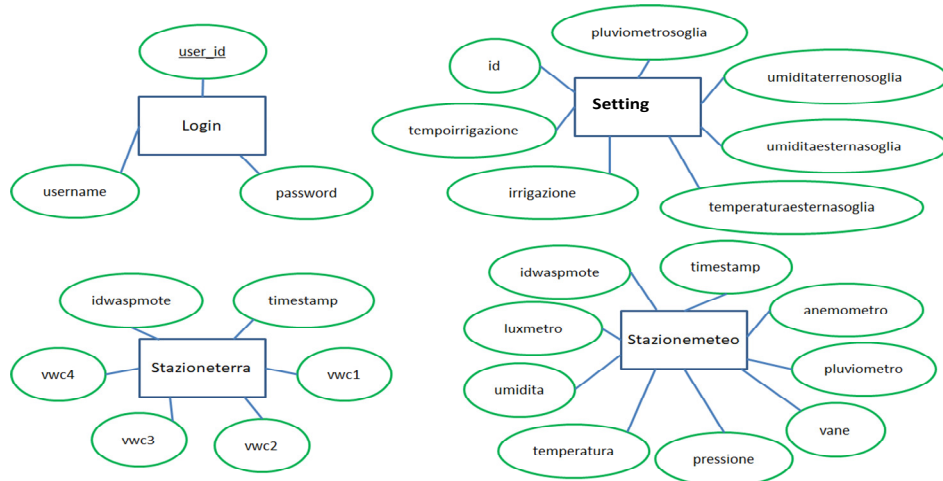

Figure 5. List of the table attributes of the MySQL database system.

2.2 DEVICE TESTING

Each devices has been individually checked before to integrate it in the whole prototype system. In this section are reported the check approaches validating the experimentation of the project. In Fig. 6 is illustrated the screenshot proving the correct operation of Decagon 10 HS sensor.

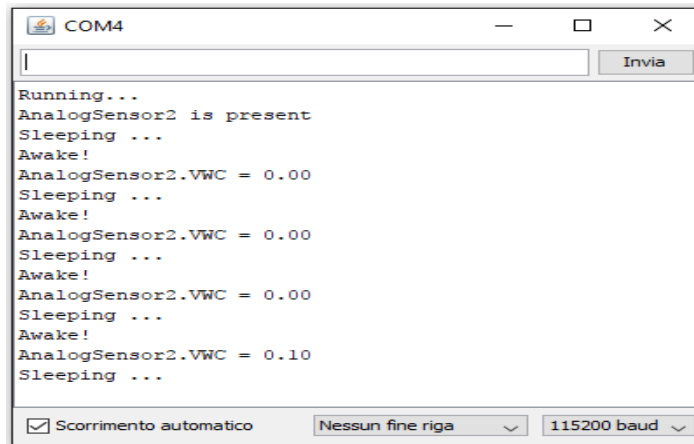

Figure 6. Screenshot output sketch Waspnote: Decagon 10HS test.

Below is listed the firmware code used for the Decagon 10HS test where are indicated all the functions (including sleep modality) and the adopted variables.

```

#include "dms.h"
#include <WaspFrame.h>
#include <WaspXBeeZB.h>
/*****
/* Analogic sensor - Decagon 10HS */
*****/
class Decagon_10HS
{
public :
    Decagon_10HS(int analogPin);

```

```

void checkPresence ();
int isPresent;
int getMeasurementData ();
char VWC[10];
private :
    int sensorIn;
};
Decagon_10HS::Decagon_10HS(int analogPin)
{
    sensorIn = analogPin;
    pinMode(sensorIn, INPUT);
}
void Decagon_10HS::checkPresence ()
{
    float mV;
    mV = 2.5 * analogRead(sensorIn);
    if(mV > 200 && mV < 1350) isPresent = 1;
    else isPresent = 0;
}
int Decagon_10HS::getMeasurementData ()
{
    float mV;
    float tmpVWC;
    mV = 2.5 * analogRead(sensorIn);
    if(mV > 200 && mV < 1350)
    {
        tmpVWC = 2.97e-9 * (mV * mV * mV) - 7.37e-6 * (mV * mV) + 6.69e-3 *
mV - 1.92;
        if(tmpVWC > 0) Utils.float2String(tmpVWC, VWC, 2);
        else Utils.float2String(0, VWC, 2);
        return 1;
    }
    else
    {
        isPresent = 0;
        return 0;
    }
}
/*****
/* Global variables */
/*****
char tmp[10];
Decagon_10HS AnalogSensor2 (ANALOG5);
/*****
/* Useful functions */
/*****
void SensorsOn ()
{
    digitalWrite(SENS_PW_5V, HIGH);
}
void SensorsOff ()
{
    digitalWrite(SENS_PW_5V, LOW);
}
/*****
/* Entry point */
/*****
char* wasp_tag= "WS1";

```

```

void setup ()
{
  USB.ON ();
  USB.printf ("Running...\n");
  //TCCR1A = 0x00;/////
  //TCCR1B = 0x05;/////
  RTC.ON ();
  RTC.setTime ("00:00:00:00:00:00");
  sbi (ADMUX, REFS0);
  sbi (ADMUX, REFS1);
  SensorsOn ();
  delay_ms (500);
  AnalogSensor2.checkPresence ();
  if (AnalogSensor2.isPresent) USB.printf ("AnalogSensor2 is present\n");
  else USB.printf ("AnalogSensor2 is not present\n");
  delay_ms (500);
  SensorsOff ();
}
void loop ()
{
  USB.printf ("Sleeping...\n");
  PWR.deepSleep ("00:00:00:05", RTC_OFFSET, RTC_ALM1_MODE1, ALL_OFF);
  //sleeping time
  USB.printf ("Awake!\n");
  if (intFlag & RTC_INT) ///// it allows the lower energy consumption
  modality (Deep Sleep modality)
  {
    intFlag &= ~RTC_INT;
    SensorsOn ();
    delay_ms (500);
    frame.createFrame (ASCII, wasp_tag);
    delay_ms (500);
    if (AnalogSensor2.isPresent)
    {
      if (AnalogSensor2.getMeasurementData ())
      {
        USB.printf ("AnalogSensor2.VWC = %s\n", AnalogSensor2.VWC);
        frame.addSensor (SENSOR_SOIL2_AN_VWC, AnalogSensor2.VWC);
      }
      else USB.printf ("AnalogSensor2 is not responding\n");
    }
    frame.createFrame (ASCII, wasp_tag);
    delay_ms (500);
  }
}
}

```

In Fig. 7 is illustrated a screenshot proving the correct working of the “Weather Station”, besides Fig. 8 and Fig. 9 illustrates the test of the electrovalves actuation and of the web platform, respectively.

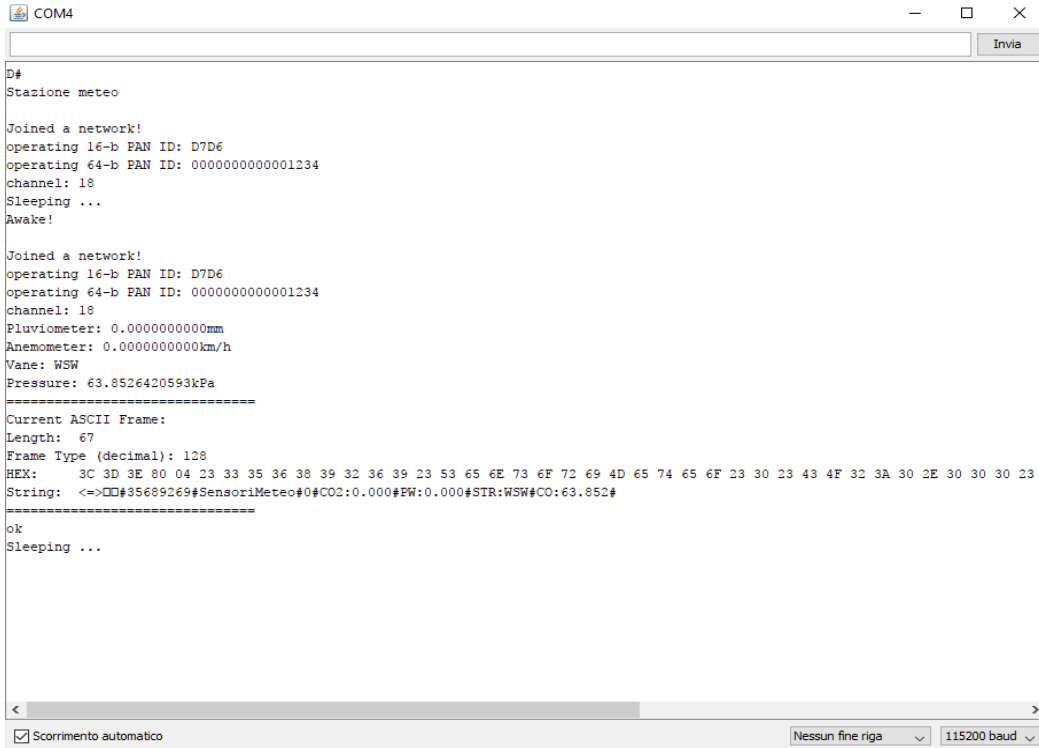

Figure 7. Screenshot output sketch of the “Weather Station” testing.

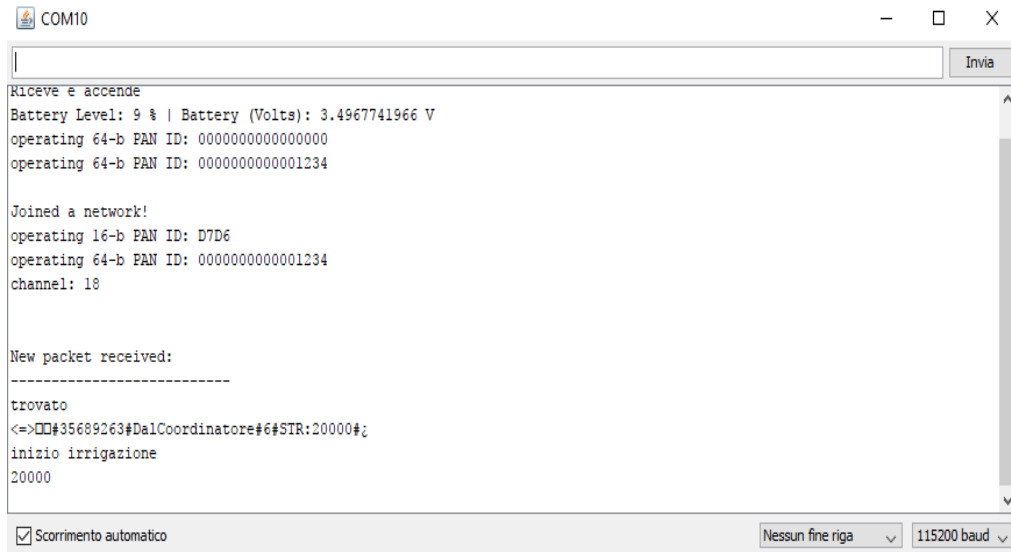

Figure 8. Screenshot of testing connectivity of electrovalves with Wasp mote system.

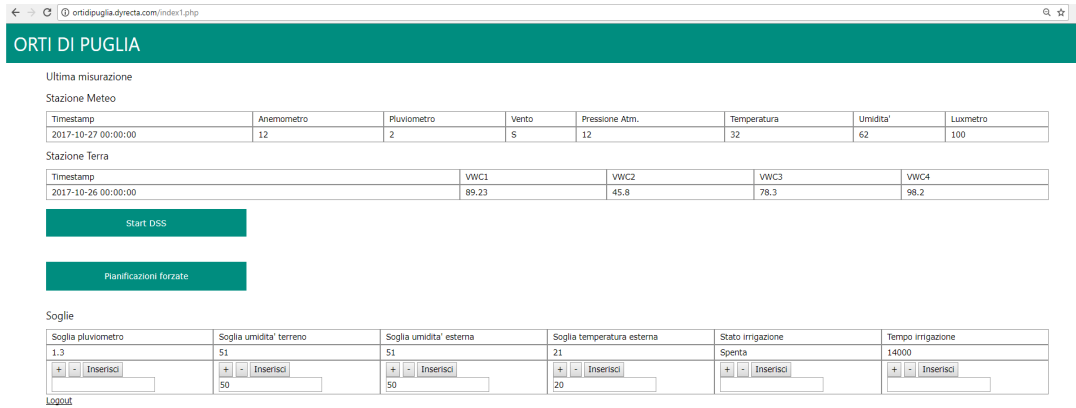

Figure 9. Web platform interface and threshold setting.

3. DSS IRRIGATION ALGORITHM

The implemented decision algorithm concerning the enabling and the disactivation of electrovalves is based on the concept that thresholds are in real time compared with the following main parameters coming from the "Weather Station" and from the "Field Station":

- rain gauge;
- soil moisture (VWC);
- external humidity;
- external temperature;

The thresholds are customized through the "Thresholds" control panel on the home of the web platform according to the plant typology.

The operation of the algorithm is described by the following flow-chart, which highlights the various "decisions" that the program can perform:

- Irrigation = FALSE: the algorithm indicates the closing of the electrovalves;
- Irrigation = TRUE: the algorithm indicates the opening of the electrovalves;
- Waiting new values: the system wait new values in order to execute again the algorithm;
- To decide: depending on the weather prediction the system decides about the irrigation process.

The algorithm starts with the threshold setting, the reading of the last measurements of the "Weather Station" and of the "Field Station" (humidity value), and the reading of the weather prediction that will condition the "To Decide" status. As a decision tree structure, the DSS will compare each measured values with the threshold parameters by following the flow chart of Fig. 10.

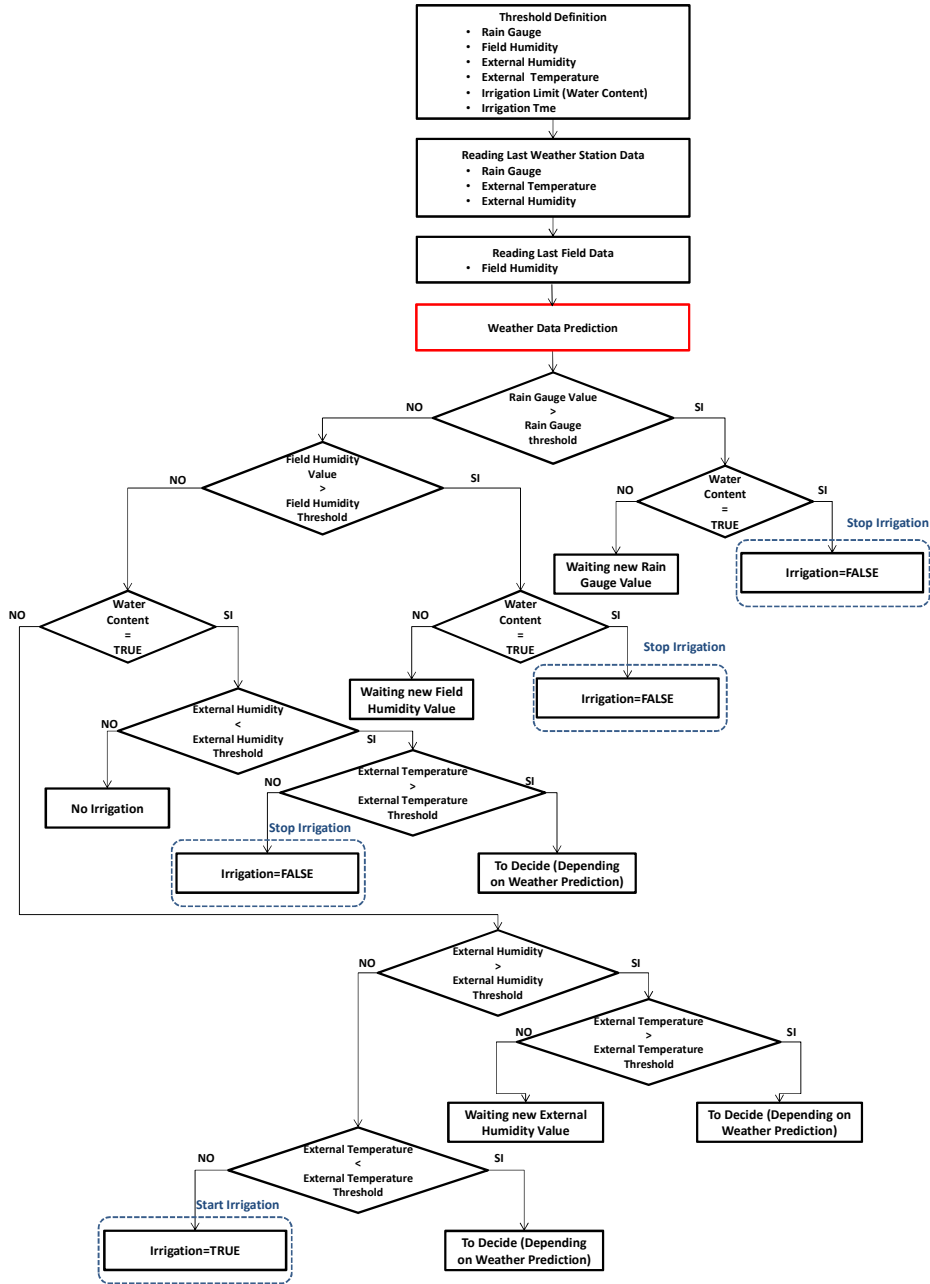

Figure 10. Proposed DSS Flowchart.

Below is reported the php pseudo-code used for the implementation of the proposed DSS:

```

<?php
function main()
{
    algoritmodecisionale();
}
function algoritmodecisionale()
{
    $servername="*****";

```

```

$username = "*****";
$password = "*****";
$dbname = "*****";
$conn = new mysqli($servername, $username, $password, $dbname);
if ($conn->connect_error) {
    die("Connection failed: " . $conn-
>connect_error);
}

$sql = "SELECT * FROM impostazioni";
$result = $conn->query($sql);

if ($result->num_rows > 0) {
    while($row = $result->fetch_assoc()) {
        $pluviometrosoglia=$row["pluviometrosoglia"];
        $umiditaterrenosoglia=$row["umiditaterrenosoglia"];
        $umiditaesternasoglia=$row["umiditaesternasoglia"];
        $temperaturaesternasoglia=$row["temperaturaesternasoglia"];
        $irrigazione=$row["irrigazione"];
        $tempoirrigazione=$row["tempoirrigazione"];
    }
} else {
    echo "ND1";
}
$conn->close();
$conn = new mysqli($servername, $username, $password, $dbname);
if ($conn->connect_error) {
    die("Connection failed: " . $conn-
>connect_error);
}

$sql = "SELECT * FROM Stazionemeteo ORDER BY timestamp DESC
LIMIT 1";
$result = $conn->query($sql);
if ($result->num_rows > 0) {
    while($row = $result->fetch_assoc()) {
        $anemometro=$row["anemometro"];
        $pluviometro=$row["pluviometro"];
        $vane=$row["vane"];
        $temperaturaesterna=$row["temperatura"];
        $umiditaesterna=$row["umidita"];
    }
} else {
    echo "ND2";
}
$conn->close();
$conn = new mysqli($servername, $username, $password, $dbname);
if ($conn->connect_error) {
    die("Connection failed: " . $conn-
>connect_error);
}

$sql = "SELECT * FROM Stazioneterra ORDER BY timestamp DESC
LIMIT 1";
$result = $conn->query($sql);
if ($result->num_rows > 0) {
    while($row = $result->fetch_assoc()) {
        $umiditaterreno=$row["vwcl"];
    }
} else {

```



```

        echo "ND3";
    }
    $conn->close();

    if ($pluviometro>$pluviometrosoglia)
    {
        if ($irrigazione)
        {
            echo "Stop irrigation 1";
            $irrigazione=FALSE;
            setIrrigazione($irrigazione);
        }
        else
        {
            echo "Waiting new values 1";
        }
    }
    else
    {
        if ($umiditaterreno>$umiditaterrenosoglia)
        {
            if ($irrigazione)
            {
                echo "Stop irrigation 2";
                $irrigazione=FALSE;
                setIrrigazione($irrigazione);
            }
            else
            {
                echo " Waiting new values 2";
            }
        }
        else
        {
            if ($irrigazione)
            {
                if ($umiditaesterna>$umiditaesternasoglia)
                {
                    if ($temperaturaesterna>$temperaturaesternasoglia)
                    {
                        echo "To decide 1";
                    }
                    else
                    {
                        echo "Stop irrigation 3";
                        $irrigazione=FALSE;
                        setIrrigazione($irrigazione);
                    }
                }
                else
                {
                    echo " Waiting new values 3";
                }
            }
            else
            {
                if ($umiditaesterna>$umiditaesternasoglia)
                {

```

```

                if ($temperaturaesterna>$temperaturaesternasoglia)
                {
                    echo "To Decide 2";
                }
            else
            {
                echo " Waiting new values 4";
            }
        }
    else
    {
        if ($temperaturaesterna<$temperaturaesternasoglia)
        {
            echo "To Decide 3";
        }
        else
        {
            $irrigazione=TRUE;
            setIrrigazione($irrigazione);
            echo $tempoirrigazione;
        }
    }
}
}
}
}
}
}
}
}

function setIrrigazione($irrigazione)
{
    $servername = "*****";
    $username = "*****";
    $password = "*****";
    $dbname = "*****";
    // Create connection
    $conn = new mysqli($servername, $username, $password, $dbname);
    // Check connection
    if ($conn->connect_error) {
        die("Connection failed: " . $conn->connect_error);
    }
    $sql = "UPDATE impostazioni SET irrigazione='$irrigazione' WHERE
id=0";
    if ($conn->query($sql) === TRUE) {
        //echo "Record updated successfully";
    } else {
        echo "Error updating record: " . $conn->error;
    }
    $conn->close();
}

main();
?>

```

3. CONCLUSION

The goal of the paper is to show results of a case of a study regarding research and development applied in industry. The proposed prototype system is an upgrade of the technology discussed in [20] and [21] by introducing an advanced DSS algorithm based on real time comparison of data measured and threshold values. Following the line guides of [22], the proposed prototype is included in Research and Development topics because “the primary objective is to make further

improvements” by improving new functionalities and new DSS algorithms. The data are measured by a fixed station connected in cloud to a web platform monitoring and activating electro valves of the irrigation network. The proposed DSS algorithm will provide information about the need to irrigate by evaluating other decision conditions conditioned by weather forecasting, and a new comparison request updating sensors values. The signal processing and transmission of sensors are performed by a microcontroller able to synchronize all inputs and outputs of the fixed station [23], and to implement the Zigbee protocol [24]. The DSS of fertirrigation process integrating the proposed DSS irrigation algorithm will be developed in a future work.

ACKNOWLEDGEMENTS

The work has been developed in the frameworks of the Italian projects: “Sistema innovativo di fertirrigazione e di Decision Supporting System orientato alla produzione di IV gamma: ‘DSS Fertirrigation 4th range’”. The authors would like to thank the following researchers and collaborators: G. Biradi, B. Boussahel, D. Carella, A. Colonna, L. D’Alessandro, G. Fanelli, A. Lombardi, G. Lonigro, A. Lorusso, S. Maggio, N. Malfettone, A. Massaro, L. Pellicani, O. Rizzo, G. Ronchi, S. Selicato, M. Solazzo, M. M. Sorbo, F. Tarulli, and V. Vitti.

REFERENCES

- [1] Afifah, A.R. , Ismail, M.R., Puteri, E.M.W., Abdullah, S.N.A., Berahim, Z., Bakhtiar, R. & Kausar, H. (2015) “Optimum Fertigation Requirement and Crop Coefficients of Chilli (*Capsicum annum*) Grown in Soilless Medium in the Tropic Climate”, *International Journal of Agriculture & Biology*, Vol.27, No.1, pp 80-88.
- [2] Mohd Salih, J. E., Adom, A. H. & Md Shaakaf, A. Y. (2012) “Solar Powered Automated Fertigation Control System for Cucumis Melo L. Cultivation in Green House”, *APCBEE Procedia*, Vol. 4, pp 79 – 87.
- [3] Malhotra, S. K. (2016) “Water Soluble Fertilizers in Horticultural Crops— An Appraisal”, *Indian Journal of Agricultural Sciences*, Vol. 86, No. 10, pp 1245–1256.
- [4] Kohire Patil V.O & Das, J. C. (2015) “Effect of Drip Irrigation and Fertilizer Management on Capsicum (*Capsicum Annum L*)”, *IOSR Journal of Agriculture and Veterinary Science (IOSR-JAVS)*, Vol. 8, No. 1, pp 10-13.
- [5] Xiukang, W. & Yingying, X. (2016) “Evaluation of the Effect of Irrigation and Fertilization by Drip Fertigation on Tomato Yield and Water Use Efficiency in Greenhouse”, *Hindawi Publishing Corporation International Journal of Agronomy*, Vol. 2016, pp 1-10.
- [6] Buttaro, D., Santamaria, P., Signore, A., Cantore, V., Boari, F., Francesco, Montesano, F. F. & Angelo Parente, A. (2015) “Irrigation Management of Greenhouse Tomato and Cucumber Using Tensiometer: Effects on Yield, Quality and Water Use”, *Agriculture and Agricultural Science Procedia*, Vol. 4, pp. 440 – 444.
- [7] Bankar, G. (2016) “Automated Irrigation and Fertigation System”, *International Journal of Electrical and Electronics Research*, Vol. 4, No. 2, pp 193-197.
- [8] Avatade, S. S. & Dhanure, S. P. (2015) “Irrigation System Using a Wireless Sensor Network and GPRS”, *International Journal of Advanced Research in Computer and Communication Engineering*, Vol. 4, No. 5, pp 521-524.
- [9] Kaur, B. & Kumar, D. (2013) “Development of Automated Nutrients Composition Control Fertigation System”, *International Journal of Computer Science, Engineering and Applications (IJCSEA)* Vol.3, No.3, pp 67-78.
- [10] Doshi, T., Joshi, J., Vyas, R. & Upadhyay, P. (2015) “Agritech Automation on Seeding and Fertigation: A Revolution in Agriculture”, *International Journal of Innovative Science, Engineering & Technology (IJSET)*, Vol. 2, No. 11, pp 82-87.

- [11] Goyal, M. R. (2015) “Sustainable Micro Irrigation Principles and Practices,” Apple Academic Press, Inc., 2015.
- [12] Elia, A. & Conversa, G. (2015) “A Decision Support System (GesCoN) for Managing Fertigation in Open Field Vegetable Crops. Part I—Methodological Approach and Description of the Software”, *Methods*, Vol. 6, No. 319, pp 1-18.
- [13] Rinaldi, M. & He, Z. (2014) “Decision Support Systems to Manage Irrigation in Agriculture,” chapter 6, *Advances in Agronomy*, Vol. 123.
- [14] Barradas, J. M. M., Matula, S., Dolezal, F. (2012) “A Decision Support System-Fertigation Simulator (DSS-FS) for Design and Optimization of Sprinkler and Drip Irrigation Systems,” *Computers and Electronics in Agriculture*, Vol. 86, pp 111–119.
- [15] Drechsel, P., Heffer, P. Magen, H., Mikkelsen, R. & Wichelns, D. (2015) “Managing Water and Fertilizer for Sustainable Agricultural Intensification”, ISBN 979-10-92366-02-0, 2015.
- [16] Chartzoulakis, K. & Bertaki, M. (2015) “Sustainable Water Management in Agriculture Under Climate Change”, *Agriculture and Agricultural Science Procedia*, Vol. 4, pp 88 – 98.
- [17] Pardossi, A., Incrocci, L. et al (2009) “Root Zone Sensors for Irrigation Management in Intensive Agriculture”, *Sensors*, Vol. 9, pp 2809-2835.
- [18] Zografos, A. (2014) “Wireless Sensor-based Agricultural Monitoring System”, Master’s Thesis, 2014.
- [19] Pinter, P. J. et al (2003) “Remote Sensing for Crop Management”, *Photogrammetric Engineering & Remote Sensing*, Vol. 69, No. 6, pp 647–664.
- [20] Riezzo, E. E., Zippitelli, M., Impedovo, D., Todorovic, M., Cantore, V. & Buono, V (2013)“Hydro-Tech - an Integrated Decision Support System for Sustainable Irrigation Management (II): Software and Hardware Architecture”, *CIGR Proceedings*, pp 443-486.
- [21] Todorovic, M., Cantore, V., Riezzo, E. E., Zippitelli, M., Galiano, A. & Buono, V. (2013) “Hydrotech: An Integrated Decision Support System for Sustainable Irrigation Management (I): Main Algorithms and Field Testing”, *CIGR Proceedings*, pp 425-41.
- [22] Frascati Manual 2015: The Measurement of Scientific, Technological and Innovation Activities Guidelines for Collecting and Reporting Data on Research and Experimental Development. OECD (2015), ISBN 978-926423901-2 (PDF).
- [23] Sweety, R. N. & Vijaya, R. (2012) “Design of a Soil Moisture Sensing Unit for Smart Irrigation Application”, *International Conference on Emerging Technology Trends on Advanced Engineering Research (ICETT’12)*, pp 1-4.
- [24] Sudharsa, D., Adinarayana, J, Tripathy, A. K., Nimomiya, S., Hirafuji, M., Kiura, T., Desai, U. B., Merchant, S. N., Reddy, D. R. & Sreenivas, G. (2012) “GeoSense: A Multimode Information and Communication System”, *International Scholarly Research Network*, Vol. 2012, pp 1-13.

CORRESPONDING AUTHOR

Alessandro Massaro: Research & Development Chief of Dyrecta Lab s.

