

Estimation of Geotechnical Parameters by Comparing Monitoring Data with Numerical Results: Case Study of Arash–Esfandiar-Niayesh Under-Passing Tunnel, Africa Tunnel, Tehran, Iran

Aliakbar Golshani, Seyyed Mehdi Poorhashemi, Mahsa Gharizadeh

Abstract—The under passing tunnels are strongly influenced by the soils around. There are some complexities in the specification of real soil behavior, owing to the fact that lots of uncertainties exist in soil properties, and additionally, inappropriate soil constitutive models. Such mentioned factors may cause incompatible settlements in numerical analysis with the obtained values in actual construction. This paper aims to report a case study on a specific tunnel constructed by NATM. The tunnel has a depth of 11.4 m, height of 12.2 m, and width of 14.4 m with 2.5 lanes. The numerical modeling was based on a 2D finite element program. The soil material behavior was modeled by hardening soil model. According to the field observations, the numerical estimated settlement at the ground surface was approximately four times more than the measured one, after the entire installation of the initial lining, indicating that some unknown factors affect the values. Consequently, the geotechnical parameters are accurately revised by a numerical back-analysis using laboratory and field test data and based on the obtained monitoring data. The obtained result confirms that typically, the soil parameters are conservatively low-estimated. And additionally, the constitutive models cannot be applied properly for all soil conditions.

Keywords—NATM tunnel, initial lining, field test data, laboratory test data, monitoring data, numerical back-analysis.

I. INTRODUCTION

UNDER passing tunnels behavior are affected by the soil behavior identified by physical and mechanical parameters. Therefore, it is necessary that soil parameters be well-estimated. The existence of uncertainties in the parameters of soil materials have long been recognized [1]. There are different ways to deal with these uncertainties, such as probabilistic or reliability-based approach [1]. In geotechnical engineering, it is common to use numerical back-analysis for best estimation of soil input parameters based on field data and observations. Accordingly, this paper aims to well estimate the soil properties through the obtained monitoring data and field test results, based on a particular under passing tunnel construction in Tehran, Iran, starting

from Modarres Highway and running to Niayesh Highway. The tunnel excavation was based on the New Austrian Tunneling Method (NATM) with a total length of 1532 m. By different considerations of traffic engineering (transportation) and variable topography at the project site, the tunnel section varied along its route [2], [3].

The particular studied tunnel crosses Africa Street, the monitoring process performed at three different stations along the tunnel axis, for which, three points (i.e. middle, right and left) of the ground surface above the tunnel were controlled. Figs. 1 and 2 show the project area and the detailed plan of the tunnel rout, respectively.

The field measurements are recorded up until the entire installation of initial lining. Finally, the soil parameters are updated such that the final ground settlements are in numerical model match with the field measurements.

II. MODEL PROPERTIES

The numerical model was developed by a 2D finite element program [4]. The mesh generation made by triangular 15-node elements, providing an accurate calculation of stresses and failure loads. The model geometry and its configuration are as shown in Fig. 3. The intended tunnel runs next to a hydraulic canal (Velenjak sewer) at a horizontal distance of nearly 2.6 m. The maximum surcharge load is as high as 2 ton/m² (i.e. the equivalent traffic loading). According to the longitudinal profile of the project route, the maximum soil overburden is approximately 11.4 m. Figs. 4 and 5 show the developed numerical model and generated mesh, respectively.

By the sequential excavation method and considering the 3D effects, it is excavated in seven stages (Fig. 6), for each of them the relaxation factors are:

Top Heading (I): 35%, Core area (II): 100%, First Left Bench (III): 20%, First Right Bench (IV): 20%, Second Left Bench (V): 20%, Second Right Bench (VI): 20%, Invert (VII): 15%.

Aliakbar Golshani (Assistant Professor) is with the Faculty of Civil and Environmental Engineering, Tarbiat Modares University, Tehran, Iran (phone: +98 21 82884368, fax: +98 21 82884368, e-mail: golshani@modares.ac.ir).

Seyyed Mehdi Poorhashemi (M.Sc) is with the Mining Engineering, Executive Manager for Underground Projects of Tehran Municipality, Tehran, Iran (e-mail: s_m_pourhashemi@yahoo.com).

Mahsa Gharizadeh (M.Sc) is with the Geotechnical Engineering, Faculty of Civil and Environmental Engineering, Tarbiat Modares University, Tehran, Iran (e-mail: mahsagharizade@gmail.com).

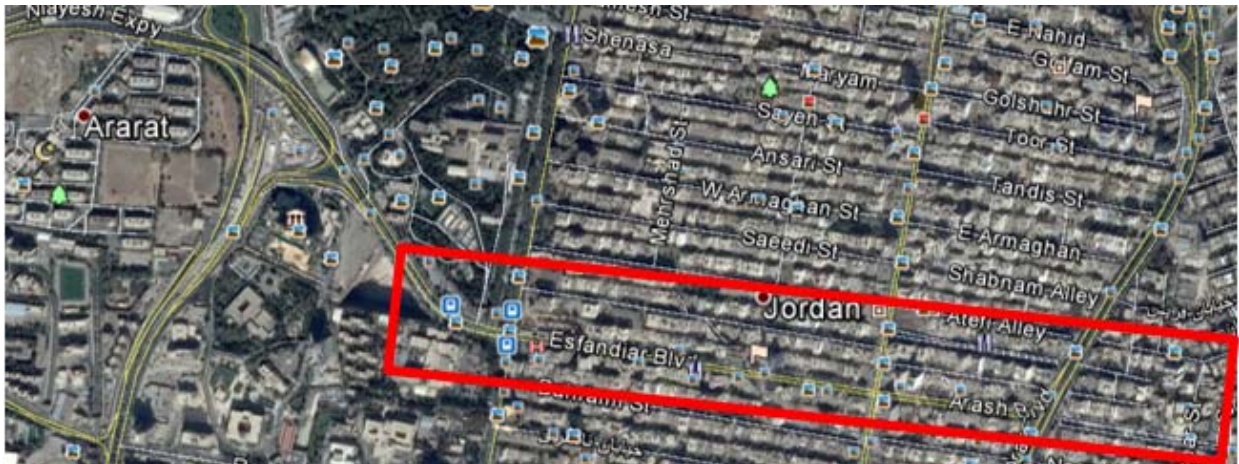

Fig. 1 The overall view of the project site (Satellite map)



Fig. 2 The general and detailed plan of the tunnel route

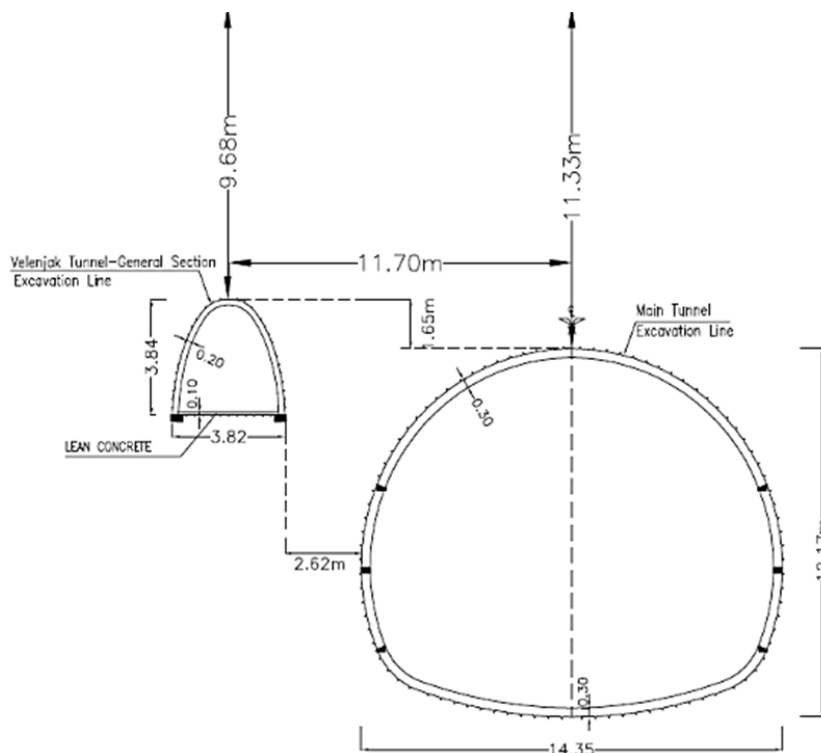

Fig. 3 The geometrical properties of the numerical model (The Africa tunnel next to Velenjak sewer)

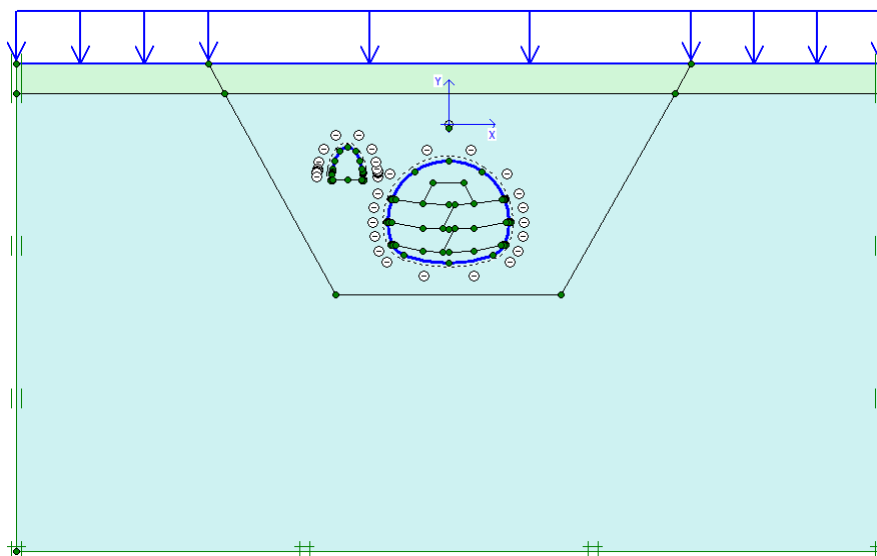

Fig. 4 The developed numerical model

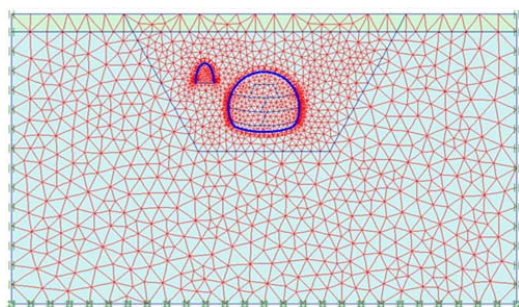

Fig. 5 The generated finite element mesh used for the analysis

A. The Soil Model

In this project, different in-situ and laboratory tests were performed on site, including Standard penetration, pressuremeter, permeability, in-situ shear box tests and other laboratory tests. The plan of the site investigation bore holes are presented in Fig. 7. As presented in this figure, three identification bore holes and four test pits are distributed along the tunnel path. Based on the performed site investigations, the preliminary soil parameters are estimated. Accordingly, the geotechnical section of the project site is illustrated in Fig. 8

schematically. Through a glance on Fig. 8, a filling layer with thickness of 2 m to 6 m is obviously observable; and, the rest of the soil layers are mainly of sandy gravel. Describing the soil characteristics, it is considered that the soil material behaves as the hardening soil model. With regards to this constitutive model, the soil properties are summarized in Table II [5]. It is an advanced hyperbolic soil model formulated in the framework of hardening plasticity. The main difference with the Mohr Coulomb model is the stiffness approach. Here, the soil is described much more accurately by using three different input stiffness: tri-axial loading stiffness E_{50} , tri-axial unloading stiffness E_{ur} and the odometer loading stiffness E_{oed} . Apart from that, it accounts for stress-dependency of the stiffness moduli, all stiffnesses increase with pressure.

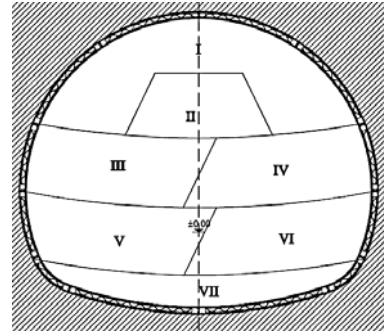

Fig. 6 The sequence of the tunnel excavation (The Africa tunnel)

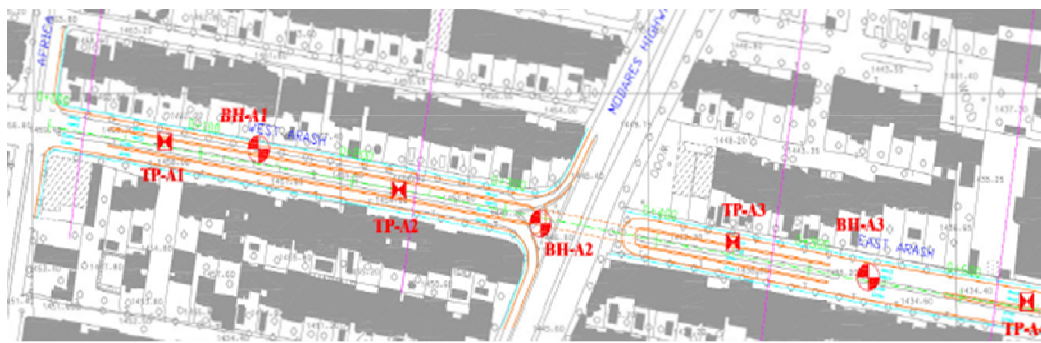

Fig. 7 The plan of bore holes and test pit location

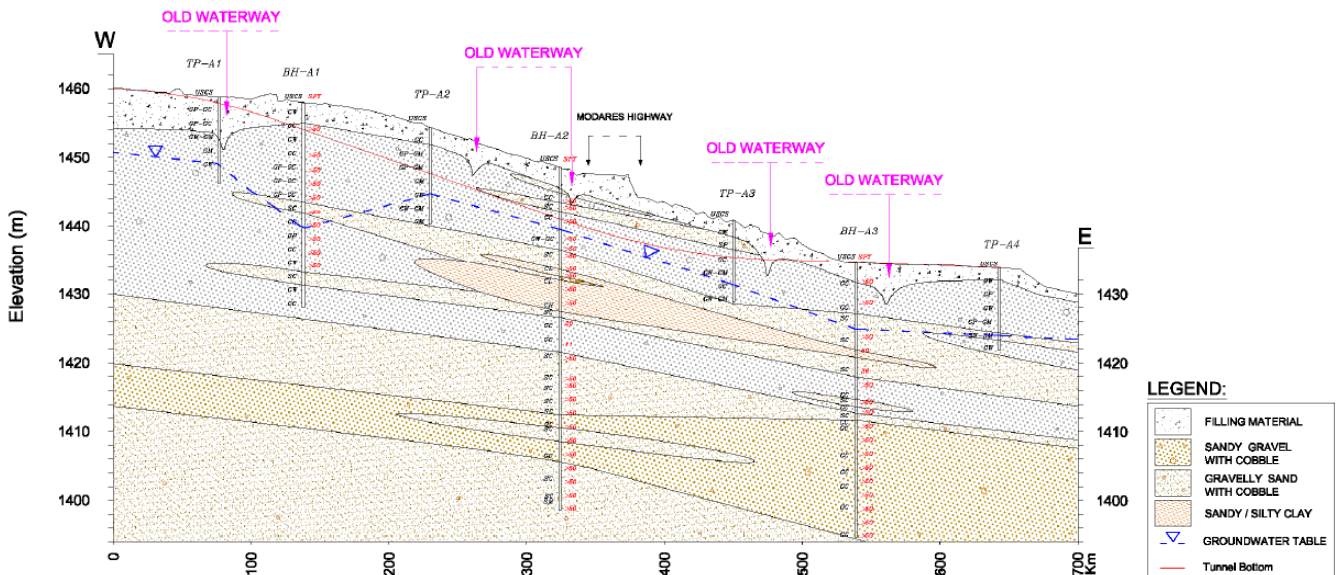

Fig. 8 Schematic geological layers of the project site

B. The Tunnel Model

The intended tunnel had a total length of 41 m, 14.5 m wide and 12.2m in height. Its initial lining had a thickness of 30 cm. The lining properties are summarized in Table II [6]. It is modeled with plate element and a linear elastic behavior was adopted for the concrete material. The used concrete shall be of class C25, and the used reinforcement in initial support

shall be of type III.

III. MONITORING PROCEDURE

Relative displacements between two points constitute typically the main variable that can be measured on the top surface of the tunnel. In this procedure, three stations along the tunnel axis were selected, in which the relative vertical

displacements for three points of the ground surface (i.e. South, North and Middle of the Africa St.) are recorded continuously, until the end of initial stabilization. The monitoring stations are presented in Fig. 9.

According to the field measurements during construction, the largest settlement occurred at stage No. 1794 as high as 15 mm, in the south direction of the tunnel section. The displacement diagrams of every three stations are presented in Fig. 10.

TABLE I
 THE PARAMETERS OF SOIL MATERIALS (PRIMARILY ESTIMATED)

Symbol	Quantity	
	First layer	
ϕ	Internal friction angle	30 (degree)
C	Cohesion	0.1 (kg/cm ²)
γ_m	Natural density	17 (gr/cm ³)
P_{ref}	Reference vertical effective stress	10 (kN/m ²)
ν_{ur}	Poisson ratio of unloading/reloading	0.2
E_{50}	Secant deformation modulus	400 (kg/cm ²)
E_{ur}	Unloading stiffness	1200 (kg/cm ²)
m	Power of stress level of stiffness	0
ψ	Dilatancy angle	0 (degree)
	Second Layer	
ϕ	Internal friction angle	37 (degree)
C	Cohesion	0.25 (kg/cm ²)
γ_m	Natural density	18 (gr/cm ³)
P_{ref}	Reference vertical effective stress	33 (kN/m ²)
ν_{ur}	Poisson ratio of unloading/reloading	0.2
E_{50}	Secant deformation modulus	700 (kg/cm ²)
E_{ur}	Unloading stiffness	2100 (kg/cm ²)
m	Power of stress level of stiffness	0.5
ψ	Dilatancy angle	7 (degree)

TABLE II
 THE PARAMETERS OF TUNNEL LINING

Symbol	Quantity	
E_c	Elastic modulus of concrete	21466221.29
	$15100\sqrt{f'_c}$ (kg/cm ²)	
EI	Bending stiffness	24149.5
	$E \times (bh^3/12) \times 0.5$ (m ² /m)	
EA	Axial stiffness ($E \times b \times h$) (kN/m)	6439866.39
w	Weight ($h \times b \times \gamma$) (kN/m/m)	7.062



Fig. 9 The locations of monitoring stations

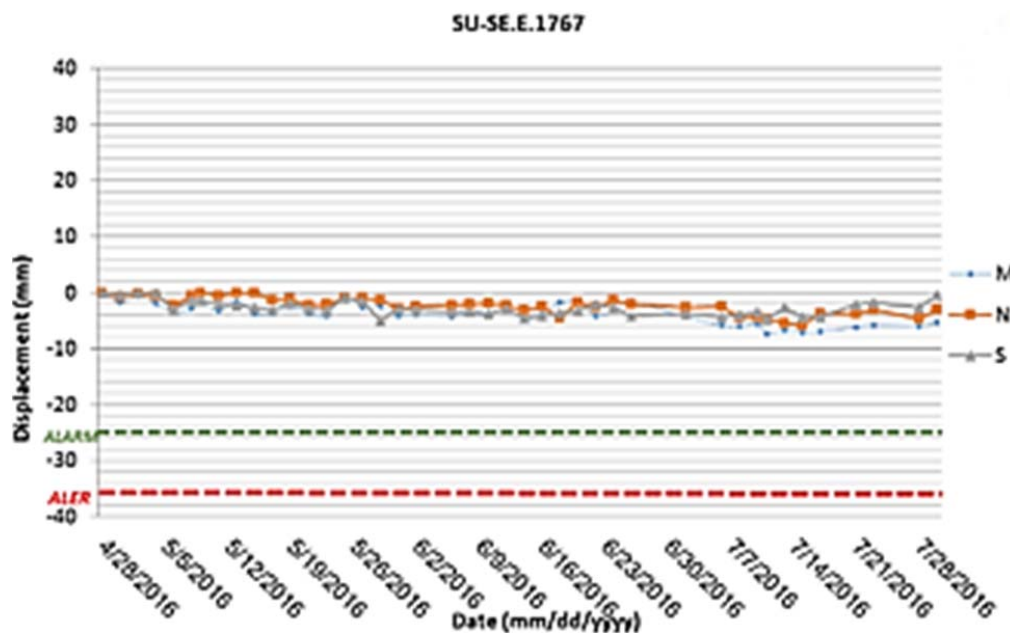

(a)

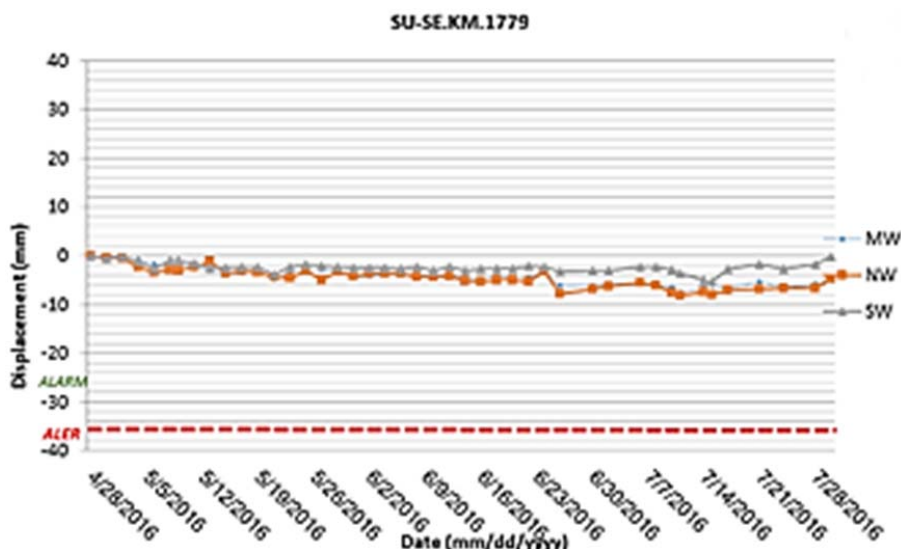

(b)

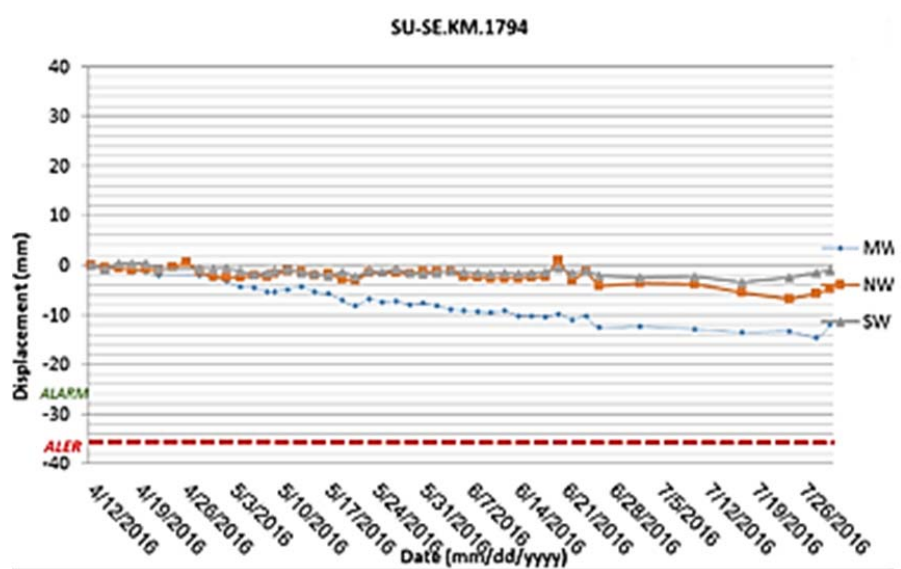

(c)

Fig. 10 The settlement readings of the top surface of the tunnel for three stages

IV. NUMERICAL BACK-ANALYSIS PROCEDURE

In order to identify exact soil properties, a numerical model relating measurements to the set of the geotechnical parameters, must be developed. Here, the field measurement sets are includes of relative vertical displacement (settlement) and geodetic data.

The developed numerical model analyzed based on the primarily estimated soil parameters. Hence, a prediction of the displacements in a section of the tunnel, applying the primitive soil input parameters in the numerical model, was first performed. By a comparison between the field displacements and the obtained numerical results, the soil properties were updated appropriately. In this case, although the excavation

was carried out in several stages, only the final displacements have been compared for both the numerical model and field data. In this way, depending on the field soil tests, the main uncertain parameters are considered to be updated and the rest are fixed. In this project, the shear strength parameters are entirely derived from laboratory tests which are not enough reliable. Moreover, due to limited numbers of field and laboratory tests around the intended tunnel, possible errors in test performance and too conservative estimations, the shear strength parameters (i.e. ϕ and c) and mechanical parameter (i.e. modulus of elastic deformation) have the most uncertainty.

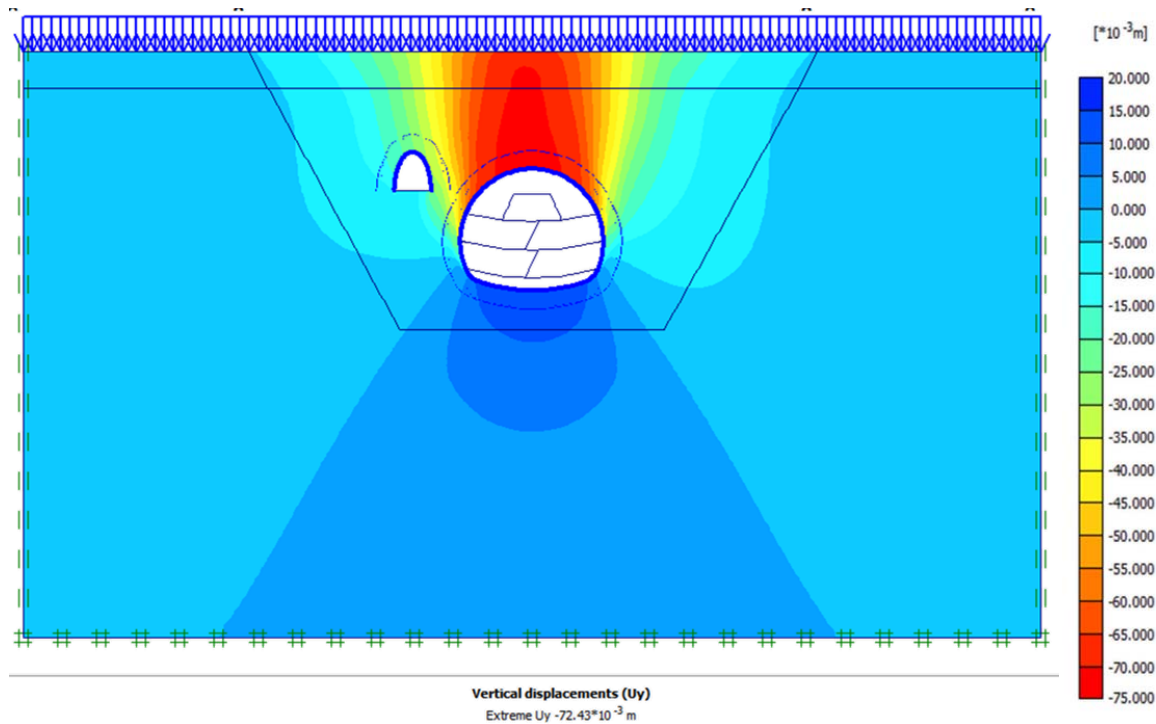

Fig. 11 The induced vertical displacement at the end of construction (based on primitive properties)

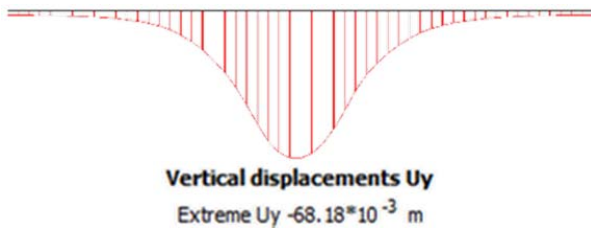
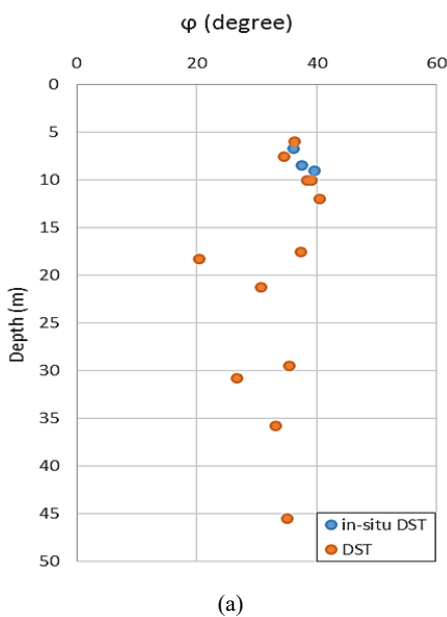
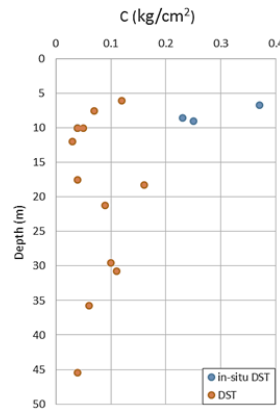

Fig. 12 The induced vertical displacement at the ground surface (based on primitive properties)



(a)



(b)

Fig. 13 The variations of shear strength parameters vs. depth of soil sample based on in-situ DST and laboratory DST; (a) internal friction angle, (b) cohesion

V. RESULTS

According to the numerical results based on the primitive soil properties, the settlement of about 6.8 cm and 7.2 cm occurred at the ground surface and top of the tunnel, respectively (Figs. 11 and 12). The total vertical displacements of the ground mass are presented in Fig. 12. As shown in this figure, a uniform distribution of settlement occurred at the top area of the tunnel. While, in accordance with the field observations and monitoring data (as shown previously in Fig. 10), non-uniform displacements recorded at three different point. It indicates that the considered soil properties are uniformly too weak rather than real geological characteristics. So, with regards to the applied constitutive model (HS model)

and considering fixed values for parameters including friction angle, P_{ref} , a sensitivity analysis performed using the rests of parameters.

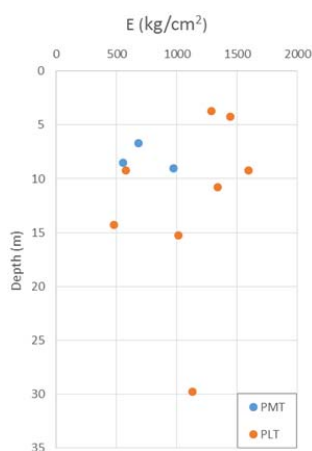

Fig. 14 The variations of modulus of elastic deformation vs. depth of soil sample based on PMT and PLT

According to Fig. 13, the primarily considered values of internal friction angle are adequately well-estimated, which are near to the top limits of the field and laboratory results. While for cohesion, the values are low-estimated. Although the cohesion values are low in laboratory tests, only the field results are reliable due to the integrity of the samples. Also, as shown in Fig. 14, the primitive considered values for the modulus of elastic deformation are conservatively low-estimated. Therefore, the values of E and C parameters are updated, as long as, the final vertical displacement matched

with field data. As discussed in the previous section, the criteria are reaching to the intended field settlement as high as 1.5 cm. Then after by making linear trends between the parameters and numerical results, it was possible to predict the required values.

The final updated parameters are summarized in Table III. As shown in Figs. 15 and 16, by the revised values of soil properties, the final vertical displacement at the ground surface reached to 2.3 cm which is close to monitoring data.

TABLE III
 THE PARAMETERS OF SOIL MATERIALS (BACK-ANALYZED PARAMETER)

Symbol	Quantity	
First layer		
ϕ	Internal friction angle	30 (degree)
C	Cohesion	0.15 (kg/cm ²)
γ_m	Natural density	17 (gr/cm ³)
ν_{ur}	Poisson ratio of unloading/reloading	0.2
E_{50}	Secant deformation modulus	500 (kg/cm ²)
E_{ur}	Unloading stiffness	1500 (kg/cm ²)
m	Power of stress level of stiffness	0.5
ψ	Dilatancy angle	0 (degree)
Second Layer		
ϕ	Internal friction angle	37 (degree)
C	Cohesion	0.35 (kg/cm ²)
γ_m	Natural density	18 (gr/cm ³)
ν_{ur}	Poisson ratio of unloading/reloading	0.2
E_{50}	Secant deformation modulus	1000 (kg/cm ²)
E_{ur}	Unloading stiffness	3000 (kg/cm ²)
m	Power of stress level of stiffness	1.0
ψ	Dilatancy angle	7 (degree)

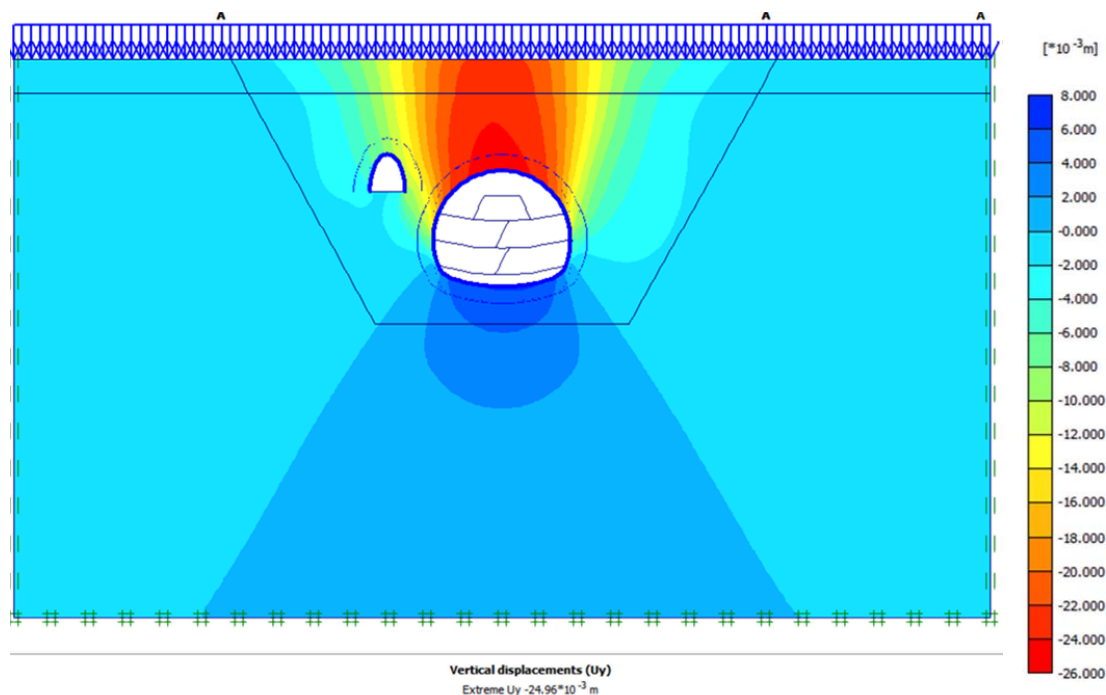

Fig. 15 The induced vertical displacement at the end of construction (based on the revised properties)

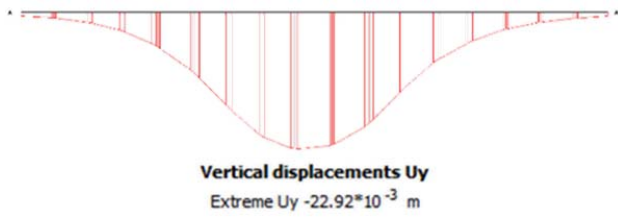

Fig. 16 The induced vertical displacement at the ground surface
(based on the revised properties)

REFERENCES

- [1] Wang, Lei, "Probabilistic Back Analysis of Geotechnical Systems" (2013). All Theses. Paper 1727.
- [2] Design and construction of road tunnels (FHWA-NHI-10-034), December 2009.
- [3] The British Tunnel Society and Institution of Civil Engineers, "Tunnel Lining Design Guide", Thomas Telford Ltd., 2004.
- [4] Brinkgreve, R. B. J., Broere, W., Waterman, D, PLAXIS 2D- Version 8.
- [5] T. Schanze, P. A. Vermeer, P. G. Bonnier, "The hardening soil model: formulation and verification", Beyond 2000 in Geotechnical Geotechnics, ten years of PLAXIS, 1999 Balkema, Rotterdam, ISBN 90 5809 040X.
- [6] ACI 318-99, Building Code Requirements for Structural Concrete and Commentary.