



FI.Energy-2012- 308765 S3C

D1.1 FINAL

WP 1: “Framing – Development of the theoretical framework”

Deliverable 1.1:

“Report on state-of-the-art and theoretical framework for end-user behaviour and market roles”

Contractual Date of Delivery to the CEC: 31 October 2013 (Month 12)

Actual Date of Delivery to the CEC: 8 November 2013

Author(s): S3C Consortium

Participant(s): VITO (task leader), ECN, RSE, INEA, BAUM

Workpackage: WP1 - Task 1.1

Estimated person months: 8.75

Security: PU = Public

Nature: R = Report

Version: FINAL

Total number of pages: 97

Abstract:

This report provides a state-of-the-art overview on engaging end-users in smart grid projects to promote smart energy behaviour. To this end, it reviews relevant theoretical models/frameworks for understanding smart energy behaviour from a psychological, economic, sociological, innovation, transitions and marketing perspective. It also reviews empirical literature describing various ways of implementing tariff structures and incentives, end-user feedback, communication and engagement strategies, privacy and security measures, and innovative market structures, including also a brief review of innovation uptake in the related sector of telecom. A synthesis integrates findings from the theoretical and empirical literature into an overview of key enablers and barriers for engaging end-users in smart energy behaviour, and a set of recommendations for end-user interaction in smart grid projects. Also, it identifies a number of key challenges for further research on end-user engagement in smart grid projects and describes what that implies for S3C research.

Keyword list: smart energy behaviour, smart grid projects, end-user engagement, segmentation, communication, tariff structures, incentives, end-user feedback, privacy, security, market structures

Disclaimer: The research, demonstration and other activities done in the project “Smart Consumer – Smart Customer – Smart Citizen (S3C)” and the establishment and maintenance of this website receive funding from the European Community’s Seventh Framework Programme, FP7-ENERGY-2012-1-2STAGE, under grant agreement n° 308765. The sole responsibility for the content of this publication lies with the authors. It does not necessarily reflect the opinion of the European Communities. The European Commission is not responsible for any use that may be made of the information contained therein.

Executive Summary

The S3C project belongs to a new, consumer-centric generation of smart grid projects giving centre stage to the energy end-users in households and small commercial/industrial entities. The project aims to provide a better understanding of the relationship between the design, implementation and use of particular technology and user interaction schemes and the promotion of 'smart' energy end-user behaviour. To this end, S3C Deliverable 1.1 describes a variety of insights on end-user engagement in smart grid projects from a theoretical and from an empirical perspective.

From the theoretical perspective, we found that various theories exist that can be used to frame and analyse end-user behaviour. One can roughly distinguish two schools of thought: the psychology oriented approaches take individual decision-making as a starting point, while the sociology oriented approaches draw attention to the influence of social structure. Following Giddens' structuration theory, some theories aim to bridge these two lines of thought, with practice theory and societal transitions theory as two key examples.

End-user energy behaviour is thus influenced by a broad range of both behavioural and situational factors. Behavioural factors include 'rational' factors (like financial gains), non-monetary motivators (like beliefs, values, habits, and routines), social influences (like norms and leadership), and personal capabilities (like knowledge, skills, and financial means). Situational factors, amongst others include institutional factors (laws, and regulations), culture, infrastructure and social networks that may equally influence energy behaviour. This implies that a nuanced view on end-user behaviour is required, taking both behavioural and situational factors into account.

Recent literature particularly highlights energy related practices as key to understanding and influencing smart energy behaviour. Practices are said to reside at the 'interface' of individual behaviours and social structure, as these behaviours are the product of, and also reinforce, social structure. According to practice theory, energy is not used consciously or rationally, but rather as the 'byproduct' of practices like cooking, washing, showering, working, commuting, watching TV, socialising, and travelling. Such practices are often driven by routines and socially shaped expectations. Smart grid programs would benefit from a thorough understanding of the energy related practices of their target groups.

End-users differ on the practices they adhere to, and on the extent to which the situational and behavioural factors mentioned above influence their energy related behaviour. Strategies for involving end-users should thus depart from a thorough understanding of the target group, for example by applying a segmentation approach. Current segmentation models can roughly be divided into models based on general values, preferences and opinions ('population segmentation models') and models that are tailored to specific (smart grid) products and programs and/or regions ('target group segmentation models'). They classify end-users generally on the basis of socio-demographic criteria (age, household, income and education level), behavioural factors (preferences, beliefs, values, norms) and more recently also on the basis of energy-related behavioural characteristics.

To actively engage with end-users, a number of further principles for communication and engagement apply. These are reflected in key (social) marketing models like the 4P's marketing mix (product, price, promotion, place), the AIDA model (attention interest, desire, action), Cialdini's principles of influence (reciprocity, commitment, social proof, liking, authority, scarcity), and Defra's 4E model (enable, encourage, engage, exemplify). A mix of solutions is generally recommended to 'serve' different user types. In addition, communications theory emphasises that an effective communication strategy needs to consider the following key components: the sender (make clear who is communicating), the target group (to whom is communications addressed?), the aim (make explicit why one is communicating), the message (content and form need to be adapted to the target group), the timing (when should the message be delivered?) and the communication channels (which ones are used by the target group?).

These findings are largely consistent with, and complementary to, the findings from empirical literature. Different types of incentive based programs are described to engage with end-users in demand response. These may be 'classical' or 'market-oriented', comprising monetary and/or non-monetary incentives, and which could be operated on a capacity and/or use oriented mode. End-user questionnaires reveal that financial benefits, reliability, comfort, and the level of control over appliances are some of the key factors taken into account when deciding to enrol in such programs.

Alternatively, dynamic pricing schemes may be used. Various tariff structures may be offered for which different levels of peak clipping and reduction of the energy bill have been reported. To better compare the different tariffs structures, we identified several key attributes, including the rationale of the scheme,

the number of time blocks used, the price update frequency, duration of peak periods, rates and rebates offered, the price spread, the price components that are made dynamic, and whether automated or manual control is applied. Further key lessons include the need for a variety of tailored interventions to address different user segments, and the need for convincing feedback mechanisms and communication and engagement strategies to make dynamic pricing ‘work’.

Feedback on energy consumption forms a key component of an end-user interaction scheme. Regarding feedback channels and devices, various options can be used. Most experience has been gained with in-home displays, but also others channels like websites, ambient displays, informative billing, and smartphone apps are equally promising and rapidly developing. Considering the influence of the feedback channel (and its design) on energy use behaviour, a suite of factors play a role. As a general finding, mixed feedback channels are considered best suited to address a heterogeneous end-user population.

Concerning feedback content, different types of information can be delivered to the end-user, including current and expected usage rates, bill predictions, historical comparison, differentiation by appliance, unusual usage alerts, social feedback (comparison with others) etc. It tends to be difficult to assess which type ‘works best’ with partially contradictory empirical results. Nonetheless, direct feedback (e.g. real-time and historic usage) tends to be somewhat more effective than indirect feedback (e.g. processed via billing), and also social feedback appears relatively effective. Other general recommendations include linking feedback directly to advice on actions and ensuring that feedback is interactive and sufficiently disaggregated.

Regarding communication and engagement, training to end-users and installers, innovative customer service and support (e.g. using social media), appropriate communication channels, face-to-face interaction and the need for continuous information are highlighted to generate long-term end-user interest and involvement.

Concerning data privacy, the literature stresses three important points: data minimization, transparency, and end-user empowerment (adequate information and permission requests). In addition, appropriate technical measures need to be taken to ensure data security.

Regarding energy markets, the literature describes new market structures and services that can be developed in an unbundled market and in a smart grid framework. Although largely uncharted territory, the concept of aggregation has emerged as a key contributor to these new energy markets. Aggregators enable small loads to participate in the market which would not be accessible for them otherwise. They typically take an intermediary role between end-users and other market players on a multi-sided platform. They commercialize the aggregated flexibility from the end-users to the other market players. This aggregated flexibility can provide a number of services to the different market players, like offering reserve capacity (for TSOs), distribution system congestion management (for DSOs), portfolio management (for BRPs and retailers), and energy usage monitoring and optimization (for end-users). Such innovative business models currently remain largely untested (partly due to uncertainties under the current regulatory framework), but they will most probably become increasingly important over the coming years. Important will be to further our understanding of end-user preferences in this context, for example, regarding what their offered flexibility is used for (e.g. balancing of the local network, balancing energy consumption and micro-generation in their own home, or balancing the general, ‘anonymous’ energy market) or regarding the actors taking up the role of the aggregator.

Recent developments in the telecommunication and mobile phone industry provide a number of additional relevant lessons learned. These include thinking about new business models (e.g. tying arrangements) and thinking serious about usability (e.g. simple, self-learning devices), design (devices that fit into every household) and marketing (e.g. emphasising lower energy costs and more comfort, and creating ‘cool’ lifestyles around products that fulfil the need for distinction). Furthermore, example projects in the field of energy monitoring and management of offices show how automated systems can be developed that reduce energy consumption, while minimizing the need for behavioural change on behalf of the end-user.

The findings from theoretical and empirical literature have in this report been integrated into an overview of reported enablers and barriers for engaging end-users in smart energy behaviour. Enablers and barriers are found to fall under the following key categories: *comfort*, *control*, *environment*, *finance*, *knowledge & information*, *security*, and *social process*. Interestingly, for most categories, both enablers and barriers can be identified.

Further, we have classified the various recommendations from literature into a set of key success factors supported both by empirical findings and established theoretical insight. In the initial phase of end-user engagement ('activation phase'), the following factors appear particularly important:

- *Provide added value:* This corresponds broadly with providing clear added value on the various categories of enablers, while relieving barriers as much as possible. This includes, for example, applying attractive financial incentives, ensure comfort gains rather than losses, providing new information services, ensuring data privacy and security, and include possibilities to overrule automatic procedures while offering new forms of end-user control.
- *Understand end-users:* Different target groups may be susceptible to very different enablers and barriers. The challenge is thus to understand which ones are of particular relevance, and to base engagement strategies on that.
- *Educate end-users:* Relieving possible knowledge & information barriers will involve some form of education as programs need to take into account consumer (non-)ability to deal with new technology.
- *Create commitment & appeal:* This involves taking full advantage of social processes as important enablers. This includes ensuring trust in the whole smart grid process, involving end-users at early project stages, involving role models, believable customer testimonials, and dealing with possible free-rider effects. Creating commitment & appeal also requires effective marketing and outreach to create a 'desire' for new products, for example by emphasising key benefits and creating new lifestyles around products.

In the following 'continuation phase', key factors to consider are:

- *Effective feed-back, pricing & communication:* A lot is known about which factors need to be considered when designing effective feedback (system communication) and pricing schemes. Regarding project communication, it is particularly important to ensure a continuous information flow to maintain high engagement levels. Moreover, it is considered promising to link dynamic pricing, convincing feedback mechanisms and communication strategies to achieve an optimal response.
- *Variety of intervention methods:* Although understanding the end-user is key, there are limitations on the extent to which 'tailor made solutions' can be offered, especially for a heterogeneous target group. Several studies therefore also stress the need for adopting a variety of intervention methods and techniques to serve different user types.
- *Ease of use:* User-friendly, intuitive designs are important to minimize effort needed for operating new devices and schemes (i.e. to minimize knowledge & information barriers perceived by end-users). Ease of use also includes adequate and pro-active support and service.
- *Social comparison:* It is generally considered stimulating to allow end-users to compare their (new) energy behaviours to peers. Besides setting individual energy-saving targets, this thus involves comparing those targets (and their fulfilment) to others.
- *Reflection & learning:* Smart grid innovations can be considered 'complex', involving many connections to other domains and scale levels and significant uncertainties on technical, social and other dimensions. Reflection and learning is therefore needed throughout the process. This may include eliciting and evaluating end-users' expectations, incorporating monitoring and evaluation cycles, letting initiatives explicitly be part of a wider programme with clear objectives, and creating arenas in which end-users, suppliers, designers and other actors collaborate and co-create knowledge in the further development of the smart grid.

Despite the wealth of current knowledge, various challenges remain for further research on end-user engagement in smart grid projects. The S3C project identifies 9 key challenges that will be addressed in its further research:

1. *Understanding the target group(s):* Which instruments or approaches contribute to achieving better understanding of the enablers and barriers of target groups and the type of end-user interaction scheme best suited to them?
2. *Products & services:* How / in what way can innovative products and services provide clear added value to end-users, while contributing to fostering smart energy behaviour?

3. *Incentives & pricing schemes*: Which (monetary or non-monetary) incentives and pricing schemes contribute to fostering smart energy behaviour?
4. *End-user feedback*: What feedback information and which feedback channels contribute to fostering smart energy behaviour?
5. *Project communication*: Which communication channels, information and marketing techniques contribute to recruitment and engagement of end-users in smart energy projects?
6. *Cooperation between stakeholders*: Does involvement of non-energy stakeholders contribute to end-user engagement and smart energy behaviour?
7. *Bottom-up support*: Which instruments or approaches contribute to facilitating end-user empowerment? (from consumer to customer and/or citizen)
8. *New market structures*: Which features of the interaction between end-users and energy market structures contribute to end user engagement and smart energy behaviour?
9. *Scalability / replicability*: Which issues hamper and/or facilitate up scaling or replication of smart energy projects?

Authors

VITO	Pieter Valkering	<u>pieter.valkering@vito.be</u>
-------------	-------------------------	---

VITO	Kris Kessels	<u>kris.kessels@vito.be</u>
-------------	---------------------	---

VITO	Erik Laes	<u>erik.laes@vito.be</u>
-------------	------------------	---

VITO	Virginia Gomez Onate	<u>virginia.gomezonate@vito.be</u>
-------------	-----------------------------	---

VITO	Enrique Rivero Puente	<u>enrique.riveropuente@vito.be</u>
-------------	------------------------------	---

ECN	Matthijs Uyterlinde	<u>j.uyterlinde@ecn.nl</u>
------------	----------------------------	---

ECN	Koen Straver	<u>straver@ecn.nl</u>
------------	---------------------	---

ECN	Jessanne Mastop	<u>mastop@ecn.nl</u>
------------	------------------------	---

BAUM	Philipp Reiß	<u>p.reiss@baumgroup.de</u>
-------------	---------------------	---

BAUM	Kerstin Kleine-Hegermann	<u>k.kleine-hegermann@baumgroup.de</u>
-------------	---------------------------------	---

INEA	Gregor Černe	<u>gregor.cerne@inea.si</u>
-------------	---------------------	---

RSE	Simone Maggiore	<u>simone.maggiore@rse-web.it</u>
------------	------------------------	---

Table of Contents

1. Introduction	16
1.1 Objective of Task 1.1	16
1.2 Scope of Task 1.1	16
1.3 Methodology	17
2. Theoretical perspective	18
2.1 What drives end-user behaviour?	18
2.1.1 Psychological theory	18
2.1.1.1 Motivational factors	18
2.1.1.2 Habitual behaviour	19
2.1.1.3 Integrated approach	20
2.1.2 Economic theory	20
2.1.3 Sociological theory	20
2.1.3.1 Practice theory	21
2.1.3.2 Sociology of technology	21
2.1.3.3 Social constructivism of technology	22
2.1.4 Innovation and transitions	23
2.1.4.1 Technological diffusion	23
2.1.4.2 Societal transitions	23
2.1.5 Conclusion	23
2.2 What types of end-users can be distinguished?	24
2.2.1 Population segmentation models	25
2.2.1.1 Values Modes (UK)	25
2.2.1.2 The perspectives typology	26
2.2.1.3 Sinus milieus (Germany)	26
2.2.1.4 Mentality model (The Netherlands)	27
2.2.2 Target group segmentation models	28
2.2.2.1 Accenture energy consumer segmentation (worldwide)	28
2.2.2.2 SGCC segmentation framework (USA)	29
2.2.2.3 Netbeheer NL: segmentation of energy consumers (The Netherlands/Switzerland)	30
2.2.2.4 eFlex project (Denmark)	32
2.2.2.5 Defra's segmentation of pro-environmental behaviour	32
2.2.2.6 Segmentation model for PV	33
2.2.3 Conclusion	34
2.3 How to actively engage end-users?	34
2.3.1 Marketing and communication	34
2.3.2 Marketing theory	34
2.3.2.1 Leading marketing models	34

2.3.2.2	The 4 P's marketing mix.....	34
2.3.2.3	The '3 C's' framework	35
2.3.2.4	AIDA model	35
2.3.2.5	Cialdini's principles of influence.....	36
2.3.2.6	Promoting efficiency investments.....	37
2.3.2.7	Social marketing	37
2.3.2.8	Defra's 4E model	38
2.3.3	Communications theory	39
3.	Empirical perspective	41
3.1	Tariff structures and incentives	41
3.1.1	Incentive-based programs	41
3.1.1.1	Types of incentives	42
3.1.1.2	Measuring actual capacity and suitability of incentives.....	42
3.1.1.3	Examples of incentives	43
3.1.1.4	End-user perception	45
3.1.2	Price-based programs and tariff structures	45
3.1.2.1	Types of tariff structures	46
3.1.2.2	Tariffs structures and demand response control.....	47
3.1.2.3	End-user response and perception.....	47
3.1.3	Concluding remarks on tariff structures and incentives	52
3.2	End-user feedback	52
3.2.1	Feedback channels and devices.....	52
3.2.1.1	Effectiveness of the different feedback devices in energy saving.....	53
3.2.1.2	Specific lessons for IHD's	54
3.2.1.3	Conclusion	54
3.2.2	Feedback information	54
3.2.2.1	Interactive and disaggregated feedback	55
3.2.2.2	Feedback with advice on appropriate actions	56
3.2.2.3	Direct & indirect feedback findings.....	56
3.2.2.4	Social feedback.....	56
3.2.2.5	Conclusions.....	56
3.3	Supporting communication and engagement.....	57
3.3.1	Training end-users and installers.....	57
3.3.2	Customer service and support	57
3.3.3	Communication channels	58
3.3.4	Active engagement through meetings and events	59
3.3.5	Continuous communication	59
3.4	Privacy and security	59
3.4.1	Privacy and data protection.....	60
3.4.2	Security	60

3.4.3	Conclusion	61
3.5	New smart grid market models.....	61
3.5.1	Context: energy market.....	61
3.5.2	Market structures for smart grids	62
3.5.2.1	Aggregator as a multi-sided platform	64
3.5.2.2	Aggregator representing distributed energy sources: Virtual Power Plants.....	65
3.5.3	Business models for smart grids.....	67
3.5.3.1	Services to the TSO	67
3.5.3.2	Services to the DSO	69
3.5.3.3	Services to the BRP	70
3.5.3.4	Services to the retailer/BRP: Portfolio Management	70
3.5.3.5	Services to the end-user	71
3.5.4	Conclusions.....	71
3.6	Key lessons from other sectors	72
3.6.1	Tariffs, business models and incentives – examples from the telecommunication sectors.....	72
3.6.2	Usability, design and marketing – What can we learn from Apple?	73
3.6.3	Examples from Green IT.....	74
3.6.4	Lessons learned	75
4.	Synthesis	76
4.1	Recapitulation.....	76
4.2	Enablers and barriers for engaging in smart energy behaviour	78
4.3	Recommendations for successful end-user interaction schemes	80
4.4	Key challenges for (research on) end-user engagement in smart grids	84
4.5	Implications for S3C research	85
4.5.1	Selection of projects.....	85
4.5.2	Scope and research questions	85
4.5.3	Towards tools and guidelines.....	86
5.	Bibliography	87
	Appendix: Do's, don'ts and don't knows of end-user engagement - brainstorm results.....	96

Index of Figures

Figure 1: Task 1.1 in relation to the other sub-tasks of WP1	16
Figure 2: Theory of planned behaviour (Ajzen, 1988)	18
Figure 3: Norm Activation Model (Schwartz, 1977).....	19
Figure 4: The Defra Sustainable Lifestyles Framework (Defra, 2011)	24
Figure 5: The six outside Values Modes, their driving unmet needs in italics, and some of their main orientations (Rose, 2010).....	25
Figure 6: The Perspectives typology (Thompson et al., 1990)	26
Figure 7: Sinus milieus.....	27
Figure 8: Mentality model.....	28
Figure 9: Accenture energy consumer segmentation (Accenture, 2010).....	29
Figure 10: Geographical representation of the six Accenture segments around the globe (Accenture, 2011)	29
Figure 11: The SGCC segmentation framework (SGCC, 2013)	30
Figure 12: Toolbox to design tailored dynamic pricing interventions (Breukers & Mourik, 2013). This example shows building blocks (blue blocks) to be chosen for segment 1 ('idealistic savers')	32
Figure 13: Defra's environmental segmentation model for pro-environmental behaviour (Defra, 2008)..	33
Figure 14: A segmentation model for PV (Vasseur, 2012)	33
Figure 15: The 3 C's from Ohmae (1991).....	35
Figure 16: The AIDA model of Lewis (1985) applied to internet marketing	36
Figure 17: Cialdini's principles of influence (Cialdini, 1984).....	37
Figure 18: Defra's 4E model applied to the behavioural goal energy efficiency in the home (Defra, 2008).	39
Figure 19: Demand Response Programs.....	41
Figure 20: Manual and Automatic Demand Response. Source: (Faruqui, 2011) with additional insights from the E-Energy projects.....	48
Figure 21: Dynamic pricing's potential for peak clipping and financial savings (Stromback et al., 2011) 48	
Figure 22: Load management options (Breukers & Mourik, 2013)	50
Figure 23: Building blocks for future Demand Side Management programmes (Lewis et al, 2012)	57
Figure 24: Number of contacts to Technical Hotline during the eFlex project (119 customers total) (Dong Energy, 2012)	58
Figure 25: Unbundling of the energy market	62
Figure 26: Traditional electricity market structure	63
Figure 27: E-DeMa project market structure.....	63
Figure 28: e-Telligence project market structure. The aggregator role will be performed via a virtual power plant or the manager of the eTelligence market place.	64
Figure 29: The ADDRESS project architecture	65
Figure 30: FENIX architecture	66
Figure 31: Real-time price distribution architecture for EcoGrid EU	67
Figure 32: EU-DEEP business model architecture for the UK test	68
Figure 33: A stylised interpretation of the process of end-user-interaction distinguishing an 'engagement' and 'reinforcement' phase.	79
Figure 34: Do's in end-user engagement – brainstorm results.....	96

Figure 35: Dont’s in end-user engagement – brainstorm results 97

Figure 36: Don’t knows in end-user engagement – brainstorm results 97

Index of Tables

Table 1: Segmentation of energy consumers applied by Netbeheer NL (Breukers & Mourik, 2013; Sütterlin et al., 2011)	31
Table 2: Components of communication (Breukers et al., 2009)	40
Table 3: Potential attributes of dynamic pricing schemes (Dütschke, 2013; Breukers & Mourik, 2013) ..	49
Table 4: Load management options linked to tariff types (adapted from Breukers & Mourik, 2013)	50
Table 5: Types of feedback information ranked in terms of perceived influence on behaviour (Lewis et al., 2012).....	55
Table 6: Possible enablers and barriers of end-user engagement in smart grid projects listed in the literature	80
Table 7: Success factors for end-user engagement described in the literature for the activation phase.	82
Table 8: Success factors for end-user engagement described in the literature for the continuation phase.	83

List of Acronyms

3C: Customer, Company, Competition

4E : Enable, Encourage, Engage, Exemplify

4P: Product, Price, Promotion, Place

AD: Active Demand

ADR: Automated Demand Response

ADRS: Automated Demand Response System

AIDA: Attention, Interest, Desire, Action

AMI: Advanced Metering Infrastructure

CCP: Critical Consumption Pricing

CDSM: Cultural Dynamics Strategy and Marketing

CPP: Critical Peak Pricing

CPR: Critical Peak Rebate

CSP: Curtailment Service Providers

CVPP: Commercial Virtual Power Plant

DER: Distributed Energy Resources

DLC: Direct Load Control

DR: Demand Response

DSM: Demand Side Management

EsCo: Energy Service Company

FoP: Family of Projects

IBP: Incentive-Based Programs

IBR: Inclining Block Rates

IHD: In-House Displays

ISO: Independent System Operator

KPI: Key Performance Indicator

LMP: Locational Marginal Price

MSP: Multi-Sided Platform

PBP: Progressive Block Pricing

PV: Photovoltaic

RES: Renewable Energy Sources

RTP: Real-Time Pricing

S3C: Smart Consumer, Customer, Citizen

STOR: Short Term Operating Reserve

SMEs: Small and Medium-sized Enterprises

SMUD: Sacramento Municipally Utility District

Telco: Telecommunications Company

TOU: Time-Of-Use

TSO: Transmission System Operator

TVPP: Technical Virtual Power Plant

VPP: Virtual Power Plant

1. Introduction

1.1 Objective of Task 1.1

WP1 aims to achieve a clear understanding of and gain insight into potentials for active end-user demand induced by novel end-user interaction schemes, including new market set-up's in which these schemes could be embedded. It thereby takes into account intelligent ways to change behaviour, differentiating between alternative end-user types and roles, and the diverging contexts the various smart grid projects may provide. This provides a basis for the further selection (WP2) and analysis (WP3) of end-user interaction schemes, and the consequent development of guidelines and a toolkit for end-user involvement (WP4&5).

To this end, task 1.1 establishes the theoretical basis for understanding:

- The drivers of 'smart' energy behaviour of individual end-users (including the chances of non-monetary incentives by applying psychological, marketing and societal means);
- The acceptance of new end-user interaction schemes (e.g. tackling the concerns about privacy);
- The positioning of final end-users in the new energy/electricity landscape as revealed in possible smart grid business models.

1.2 Scope of Task 1.1

Task 1.1 delivers a literature review covering the state-of-the-art in end-user behaviour and market roles, both from a theoretical perspective, and drawing from recent experiences with leading smart grid projects. It thereby reflects the 'common understanding' among the S3C project partners on the issue of end-user involvement in smart grid projects. Concretely, it feeds into the various other sub-tasks of WP1 as follows. Based on the literature review:

- Task 1.2 will develop a list of preliminary selection criteria used in WP2 to establish the 'Family of Projects' for further detailed investigation. The selection criteria will focus on promising approaches which deserve further empirical testing/specification and approaches which have not been sufficiently considered in literature yet;
- Task 1.3 will develop a list of in-depth research questions for the characterisation, analysis and assessment of the projects in the 'Family of Projects' (FoP), both from the design and end-user perspective;
- Task 1.4 will develop a first short list of key performance indicators (KPIs) against which the relative success or failure of active demand projects can be evaluated.
- Given the timing of the sub-tasks, they have in practice been carried out in parallel and in close interaction, see Figure 1.

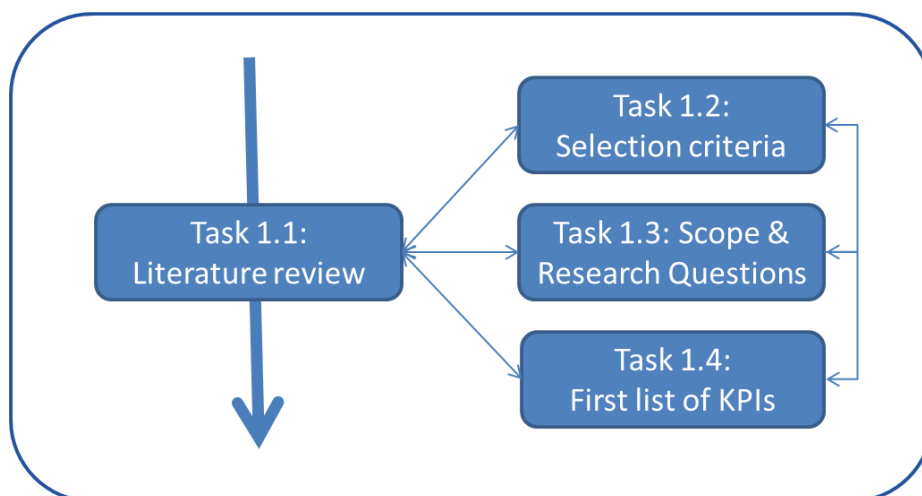

Figure 1: Task 1.1 in relation to the other sub-tasks of WP1

1.3 Methodology

This literature review draws from various strands:

Theory (Section 2):

Relevant theoretical models/frameworks for understanding smart energy behaviour from a psychological, economic, sociological, innovation, transitions and marketing perspective. From these models and frameworks, this review extracts key insights on typical drivers of end-user behaviour, the segmentation of different end-user types, and how to actively engage end-users in projects like the ones in the area of smart grid.

Empirical work (Section 3):

- Various evaluation reports and meta-reviews of experiences with smart grid projects. From this literature, this report synthesises current views on ‘what works’ in end-user engagement concerning tariff structures and incentives, feedback, communication and engagement strategies, and privacy and security issues (Sections 3.1 – 3.4).
- Literature on new smart grid market models describing innovative ways of how different market players and end-users can interact under a smart grid framework (Section 3.5).
- Reviews of experience with uptake of innovations in other related sectors like telecom (Section 3.6).

Finally, a synthesis is provided (Section 4) that integrates the findings from the theoretical and empirical literature into a consistent view on what can be considered good practice for end-user interaction in smart grid projects. Also, it identifies a number of key challenges for the research on, and actual development of, end-user engagement in smart grid projects and describes what that implies for S3C research.

2. Theoretical perspective

This chapter provides an overview of different theoretical approaches relevant for understanding smart energy behaviour, including energy saving, energy production, and flexibility of use. Since the primary focus of S3C concerns the end-user's possible role(s) in smart grids and active demand projects, we propose an interdisciplinary approach that draws upon economics, psychology, sociology, innovation and transitions, marketing and communication. Whereas each discipline examines energy issues from a partial perspective, the reality of energy use and smart energy behaviour cuts across disciplinary boundaries (Breukers et al., 2009). An integrated, socio-technical approach acknowledges the interaction between the individual and his or her social environment and the technological context.

Section 2.1 contains an overview of relevant psychological, economic, sociological and innovation and transitions theory to provide insight in what drives end-user behaviour and what contextual factors and conditions are of influence on smart energy behaviour. Section 2.2 investigates ways to map various types of end-users through segmentation approaches. Section 2.3 presents a selection of relevant theory on marketing and communication.

2.1 What drives end-user behaviour?

2.1.1 Psychological theory

Psychological theory – in particular behavioural psychology, cognitive psychology and social psychology – puts focus on individual behaviour regarding energy: which factors influence whether people behave in a pro-environmental way or not? Psychologists stress that few energy end-users are able to carefully track their own energy consumption, let alone understand fully what they could do about it (Breukers & Mourik, 2012). Most research has focused on motivational factors that influence people to engage in pro-environmental behaviour. Besides those motivational factors there are, however, also other important factors that influence people's behaviour: contextual factors and habitual behaviour (Steg and Vlek, 2009; Stern, 2000). Evidence for these lines of research will be discussed below.

2.1.1.1 Motivational factors

The most frequently used theory to predict pro-environmental behaviour is the Theory of Planned behaviour (TPB) (Ajzen, 1988). As can be seen in Figure 2, this theory assumes that behaviour is the result of behavioural intentions, which in turn are the result of attitudes a person has regarding the issue (e.g. I am positive about saving energy), subjective norms (e.g. I think that others think I should be saving energy), and perceived behavioural control (e.g. I think I am able to save energy). This theory has been successfully used to predict pro-environmental behaviour (e.g. Harland et al., 1999; Kaiser et al., 1999).

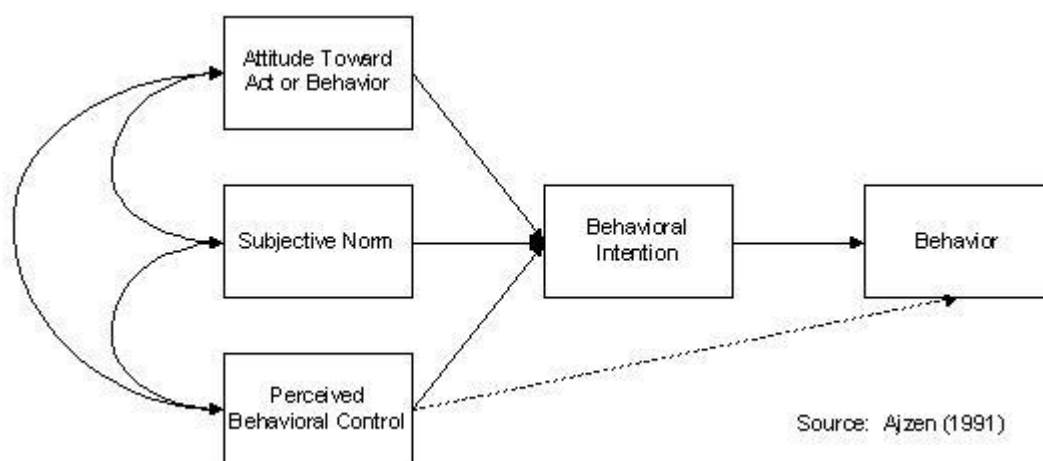

Figure 2: Theory of planned behaviour (Ajzen, 1988)

Another model widely used in research on pro-environmental behaviour is the Norm Activation Model (NAM) (Schwartz, 1977; Schwartz & Howard, 1981). The difference of this model (see Figure 3) with the theory of planned behaviour is that the NAM is developed for explaining helping behaviour and is therefore more focused on the influence of others, while the TPB assumes that people are motivated by self-interest (also subjective norms are evaluated in terms of rewards and punishment for the self). Stern

(2000) extended the NAM into the Value-Belief-Norm Theory of environmentalism (VBN-Theory). Both the NAM and VBN theory successfully explained environmental behaviour, but it seems they are mostly powerful in explaining low-cost (rather than costly or time consuming) behaviour and behavioural intentions (e.g. Nordlund & Garvill, 2003; Steg et al., 2005;).

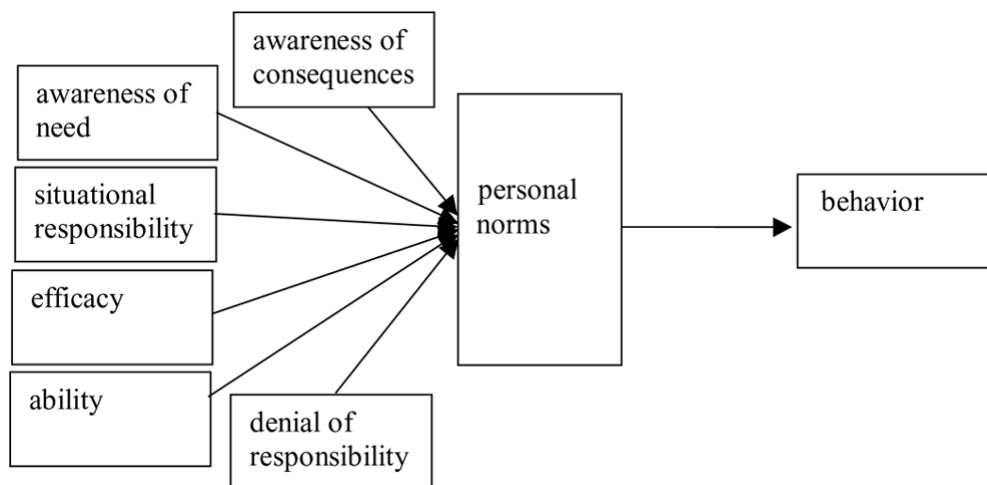

Figure 3: Norm Activation Model (Schwartz, 1977)

A theory that was successful in showing the effect of social norms as influencer of behaviour is the Theory of Normative Conduct (Cialdini et al., 1991; Cialdini et al., 1990). This theory distinguishes two types of norms, descriptive and injunctive. Descriptive norms provide information on what is commonly shown (the ‘mean’), while injunctive norms provide information on what is commonly perceived that ought to be done (the ‘best possible’). For example, a descriptive norm would state that the average households consumes 3000kWh, while an injunctive norm would state that an average household should maximally consume 1500kWh. When providing people with only a descriptive norm, they will not be motivated to perform better than average, while when this norm is combined with an injunctive norm, people stay motivated to obtain the best result possible. Furthermore, providing norms works best when it makes a relevant comparison, for example, comparing average households may be less effective than comparing with a household exactly similar to yours (e.g. a well-isolated single-family house built in 1998 without neighbours).

2.1.1.2 Habitual behaviour

It had also been argued that it is important to distinguish between different types of behaviour, such as routine habits and practices (e.g. Jaeger et al., 1993). While many theories assume that people are rational in their choices for behaviour and lifestyles, many of the behaviour they show is in fact based on automated cognitive processes. Simon (1983) already argued that people have ‘bounded rationality’; people are limited in their cognitions and emotions and external factors (such as the absence of an overview of all options) make it unlikely for people to make rational choices. Tversky and Kahneman (1974) similarly formulated several biases and heuristics in their Prospect Theory that lead people to behave in irrational ways. These biases and heuristics explain a number of frequently observed environmental behaviours. For example, the ‘status quo bias’ states that people have an irrational preference for the current state of affairs, which leads them to be resistant to changes in the way they do things. Furthermore, people are risk and loss averse which leads to slower implementation of innovations than possible, and mental accounting leads to irrational choices with regard to investments which take time to pay itself back (Kahneman & Tversky, 1984; Kahneman et al., 1991).

For environmental behaviour, a distinction of three types of behaviour can be made based on the degree to which the behaviour is conscious. First, there is habitual behaviour. This entails decisions that are made on ‘autopilot’, like showering, driving a car, or grocery shopping. A large part of our daily behaviour is habitual (Aarts et al., 1998). Second is conscious behaviour, which entails decisions that require some amount of thinking, like deciding whether to take a train or driving your car when going on a trip, or deciding whether to buy LED lamps instead of regular energy-saving lamps. Finally, one-shot behaviour entails rare decisions such as buying solar panels or a new car. This type of behaviour usually involves costly decisions, either in money, time or highly valued issues.

2.1.1.3 Integrated approach

The theories described above address that not only internal considerations play a role in determining behaviour, but also social influences such as norms have a large impact on the behaviour that is shown. There may, however, be various other factors in the environment besides norms that influence whether people show environmental behaviour. For example, in the case of smart meters, when the feedback system that is provided is too complex for people to understand, this might influence whether or not they will actually use it to change their behaviour or not.

This highlights the need for an individual and tailored approach when influencing people to show smart energy behaviour. A study of Abrahamse, Steg, Vlek, and Rottengatter (2007) showed that such a tailored approach is indeed successful in making people more energy efficient. By providing participants with tailored information, individual goals and tailored feedback (e.g. feedback in which personal achievements are compared to others), participants saved 5% energy on average. An example of an integrated approach is the Goal-Framing Theory (Lindenberg & Steg, 2007). The central idea of the Goal-Framing Theory is that “goals govern or ‘frame’ what people attend to, what knowledge and attitudes become cognitively most accessible, how people evaluate various aspects of the situation, and what alternatives are being considered.” The frame of the goal is the way in which information is processed and acted upon. People can have multiple goals at the same time, and the context of the situation they are in influences the strength of each goal. Lindenberg & Steg distinguish between three types of goal frames. The hedonic goal frame which is aimed at improving the way a person feels in a given situation (short term), the gain goal frame is aimed at improving a person’s resources (or avoiding losses). This is a more medium term goal frame. Finally, the normative goal frame is aimed at acting appropriately and is more long term.

2.1.2 Economic theory

Similar to psychological theory, economists put focus on the individual level but they also address the economic system in which individual actions take place. Economic theory is structured by markets, organizations, institutions (and/or the state) and the efficiency of these structures can be judged from a rational perspective. Within economics, a broad range of many specialized fields can be distinguished, that all agree on one thing: society is made up of individuals and these individuals act in a goal-oriented fashion, aiming to promote their own interests in one form or another (Breukers et al. 2009). The basic neoclassical proposition is that competitive markets will steer resource use to the most productive and efficient purposes. However, most economists also acknowledge a number of market failures and barriers, leading to inefficiencies (Golove and Eto, 1996).

Behavioural economics aims to better integrate the ‘human factor’ into economic theory. Recent studies in behavioural economics have examined consumers’ preferences for particular energy-related products or energy-saving measures (Burkhalter et al. 2007; Belz & Billharz, 2005). In the United Kingdom, behavioural economics have been introduced into government policy by the Behavioural Insights Team (BIT) in 2010. The BIT became quickly known as the ‘Nudge Unit’, referring to the book *Nudge: Improving Decisions about Health, Wealth, and Happiness* by Thaler & Sunstein (2008). The goal of BIT is to enrich UK policy with insights from behavioural economics, which can aid citizens with making better choices for themselves and at the same time for the collective interest. Within this ‘Nudge approach’, choice architecture is of key importance and the perspectives of end-users to identify barriers, enablers and benefits are addressed. In field experiments, new concepts are brought into practice by trials that are monitored and measured, as to explore and find out what works and why.

2.1.3 Sociological theory

As opposed to psychology and economics, sociological research draws focus on the social context in which individual behaviour is situated. Traditionally, sociology viewed social structure – the norms and institutions that govern the social order – as the key determinant of human behaviour, but nowadays, most sociologists view behaviour as being determined by both agency and structure following the structuration theory of Giddens (1979)). This means that although social structures provide limitations and opportunities for individual behaviour, actors can also change these structures through their actions. Sociological theories differ in the way these ‘structures’ are conceived of (e.g. as rules backed by power, as symbolically-mediated interactions, etc.), or in the emphasis they put on either the structural determination of action or the room left for creative agency.

2.1.3.1 Practice theory

As many studies have shown, actual end-user knowledge of energy use in buildings is often very patchy (at best), while energy use is strongly connected with different kinds of practices that are almost not influenced by knowledge of the energy use involved in these practices (Gram-Hansen, 2010; Guerra-Santin & Itard, 2010). Practice theory is precisely based on the premise that energy is ‘invisible’ in everyday life: we do not consume energy consciously, but this consumption is a side-effect of other activities and drivers such as the need for warmth, comfort, entertainment, mobility, hygiene etc. Practice theory conceptualizes these activities as ‘practices’, e.g. cooking, washing, showering, working, commuting, watching TV, socialising, travelling. In the enactment of a practice, ‘materials’ (e.g. technological devices), ‘competences’ (e.g. knowing how to operate the technical device) and ‘meanings’ (i.e. the symbolic significance of the practice) come together. Instead of targeting directly the energy consumption of households or SMEs, or targeting end-users individually as rational decision makers, practice theory proposes to target their (bundles of) practices. Much of these practices are habitual and many of the energy-use routines implicated in these practices are consolidated as social conventions or norms: for instance, socially-shaped expectations about appropriate levels of cleanliness (showering, bathing and washing), comfort (use of air-conditioning and heating) and convenience (using the car for leisure, having multiple telephones, TVs and computers per household) (Shove, 2003). These socially-shaped expectations translate into norms and rules that people mostly conform to avoid the risk of being ‘expelled’ from a social group. Hence, peers can be an important barrier to behavioural change, but they can also become a catalyst, when they are involved in changes in practices and behaviours. In addition, these norms and rules become embedded in a broader system encompassing technologies, infrastructures, social and cultural norms, policies, economy, politics and institutions.

Changing practices (and their related impact in terms of energy end-use patterns) therefore requires restructuring the existing links between the materials, competences and meanings that constitute the practice as such. In smart grid projects, the assumption is often made that the introduction of feedback mechanisms (e.g. smart meters, home energy management systems, etc.) will lead to enhanced or new competences (‘more control’) for households or SMEs over the energy-related aspects of the practices they are engaged in. The awareness-raising impact of domestic energy consumption feedback has been documented in relation to learning and behaviour change in a number of reviews and has been shown to induce some energy saving behaviour (at least in the short term) (e.g. Darby, 2006a; Faruqi et al., 2009). However, as Darby (2010) points out, these review studies say nothing about *how* such savings are realised, since they render the household as something of a black box. For our purposes, we need to understand what is going on inside the household or the SME when confronted with feedback on energy consumption. Investigating how the feedback mechanisms relate to existing energy practices is a good starting point.

2.1.3.2 Sociology of technology

Sociology of technology approaches energy consumption patterns by examining how technology and society interact in the development of wasteful or efficient practices of energy use. The configuration of cities, infrastructure, supply systems, housing designs and products in many ways limit the scope for individual choice (Wilhite et al., 2000; Shove, 2003). Even when there is a willingness to change behavioural routines, people often fail to succeed because they are confronted with factors that ‘lock-in’ unsustainable behaviour (Power & Mont, 2010). Wilhite (2007) points to new technologies as ‘change agents’ that on the one hand may increase energy efficiency, but on the other hand may create potentials for new energy intensive practices (the so-called ‘rebound effect’). Also, the installation of distributed generation (e.g. micro-CHP, photovoltaic systems) in households has been shown to influence energy-related behaviour, though the reported changes vary between studies. Bergman and Eyre (2011) point out that the possible behaviour after installation may range from misuse, disappointment/disillusionment and rebound effects, through ‘fit-and-forget’ (no change), to increased energy awareness and indirect benefits. Sociologists of technology argue that effective means to change energy related behaviour require the examination of socio-technical networks that build up around new solutions, the way in which tacit knowledge develops and the way in which the adoption of new solutions starts to make sense in a specific context (Guy & Shove, 2000).

Overall, sociological research stresses the importance of acknowledging both the social level and the physical context in order to understand individual behaviour and opportunities for behavioural change. Sociological research thus acknowledges that individual change processes are nested within – and interacting with – broader societal change processes (Breukers & Mourik, 2012). This approach therefore mostly stresses the structural determinants of individual behaviour.

2.1.3.3 Social constructivism of technology

In contrast to the classic sociology of technology, social constructivism uses a less ‘structural’ approach by focussing more on agency. The starting point of social constructivist technology studies can be traced back to the mid-’80s (see Pinch & Bijker 1984; Bijker et al. 1987). From this seminal work has flowed a body of work that is both rich and diverse: since then, dozens of books and hundreds of articles, most of them socio-historical case studies of technological innovation and technological change, have appeared. The term ‘social constructivism’ is sometimes used in a narrow sense, to refer to the ‘Social Construction of Technology’ (SCOT) approach that was outlined originally in Pinch and Bijker (1984). In a broader sense, which will be used throughout this section, the term also includes the so-called ‘social shaping’ approaches (see e.g. MacKenzie & Wajcman 1985; MacKenzie 1990), and the ‘actor-network’ approach of Bruno Latour, Michel Callon, John Law, and their followers – see e.g. the seminal works by Callon (1987) and Latour (1987). In what follows, we will try to summarise the basic concepts.

Firstly, (social) constructivism includes a conception of technological development as a contingent process, involving heterogeneous factors. Accordingly, technological change cannot be analysed as following a fixed, unidirectional path, and cannot be explained by reference to economic laws or some inner technological ‘logic’. Rather, technological change is explained by reference to a number of technological controversies, disagreements, and difficulties, that involve different actors (individuals or groups that are capable of acting) or *relevant social groups*, which are groups of actors that share a common conceptual framework and common interests concerning the technology in question. Relevant social groups should be understood broadly, as any group who has played a role in the development of the technology in question (Bijker 1995, p. 45). These actors or groups engage in strategies to win from the opposition and to shape technology according to their own plan.

Secondly, (social) constructivist approaches typically employ a principle of *methodological symmetry*, or *methodological relativism* (Pinch & Bijker, 1984; Pels, 1996). This principle, in its most common form, implies that the analyst remains impartial as to the ‘real’ properties of his/her object of analysis, e.g. technology. This implies, among other things, that the analyst does not evaluate any of the knowledge claims made by different social groups about the ‘real’ properties of the technology under study. This principle is motivated by the idea that in a sociological explanation of claims to (scientific) knowledge, it is both possible and desirable to remain agnostic about any role of ‘reality’ (in the sense encountered in a common interpretation of empirical science – i.e. ‘the objective world out there’) in settling scientific controversies. Instead, the analyst should analyse putatively true and false claims symmetrically, interpreting them by reference to similar (social) factors. As a consequence of this principle, when applied to technology, the analyst will generally avoid making claims about the true nature of technology, including claims about the (in)operational character of artefacts, technological (in)efficiency, success or failure in technical change, the (ir)rationality of technological choices and procedures, technological progress, the real function or purpose of an artefact, and/or intrinsic effects of technology (Brey 1997). Because the analyst avoids reference to real properties of a technology, moreover, such properties cannot be invoked to explain technological change. For example, no reference should be made to the actual properties of an artefact in explaining its success, or indeed its sustainability.

The outcome of the process of controversy and strategy mapping that surrounds technical change is the *stabilisation* of a technology, together with concomitant (‘co-produced’) social relations. Stabilisation of a technology implies that its contents are ‘black-boxed’, and are no longer a site for controversy. Its stabilised properties come to determine the way that the technology functions in society. Most (social) constructivists, including SCOT scholars, attribute the stabilisation of an artefact to an agreement or settlement between different social groups, which arrive at a similar interpretation of a technology, as the result of a series of controversies and negotiations. Technology is claimed by these (social) constructivists to have *interpretive flexibility*: it has no objective, fixed properties, but allows for different interpretations, not only of its functional and socio-cultural properties but also of its technical content, that is, the way it works. Technological artefacts are supposed to be sufficiently underdetermined to allow for multiple possible designs – so whatever the result of technological change, it could have been different. Facts about a technology are hence not objectively given by the technology itself, but are determined by the interpretations of relevant social groups. The rhetorical process of agreement on the true nature of a technology as the outcome of negotiation and social action is called *closure*. Technology is hence socially shaped or socially constructed: its properties are largely if not exclusively determined by the interpretive frameworks and negotiations of relevant social groups.

2.1.4 Innovation and transitions

2.1.4.1 Technological diffusion

Technological diffusion studies have traditionally investigated the spread of technological innovations within a certain social network. They typically highlight key factors that determine whether or not users will adopt a certain technology. Rogers' diffusion of innovations theory (Rogers, 2003), for example, highlights 'relative advantage', 'compatibility', 'complexity', 'trialability' and 'observability' as key factors, Davis' technology acceptance model (Davis, 1989) highlights 'perceived usefulness' and 'perceived ease', while the Unified Theory of Acceptance and Use of Technology (UTAUT) of Vankatesh, Morris et al. (2003) highlights three direct determinants of intention to use (performance expectancy, effort expectancy, and social influence) and two direct determinants of usage behaviour (intention and facilitating conditions). Technological diffusion also offers a view on user segmentation, typically distinguishing 'innovators', 'early adopters', 'early majority', 'late majority' and 'laggards' (Rogers, 2003).

2.1.4.2 Societal transitions

Finally, transition studies show how small scale innovations may form part of a broader transition process. Such a process involves interactions across multiple levels (micro-meso-macro / niche-regime-landscape) moving 'successful' transitions through multiple phases (predevelopment, take-off, acceleration, stabilization).

From this perspective, the development of smart grid technologies can be considered as a 'niche experiment' (Verbong et al., 2013). In the peripheries of incumbent systems ('regimes') in transition management parlance, 'niches' are the loci where (more or less) radical novelties are created and tested as a co-evolution of an entrepreneurial impulse in heterogeneous socio-technological networks. These novelties can be all kinds of combinations of new technologies, new rules and legislation, new concepts, new policy settings and policy attitudes, new organisations, etc. – in a setting that essentially is a potential new societal system-in-the-making, and of which the culture, structures and activities deflect to some extent from the dominant system. Often these niches are the incubators for experimentation and proofs of the concepts of (more or less) radical innovations or 'transition experiments'. Defined as "*practical experiments with a high level of risk (in terms of failure) that can make a potentially large contribution to a transition process*" (Rotmans, 2005), transition experiments are real-life developments of drastically alternative ways of working and/or thinking, fitting into envisaged new system approaches. Such experiments are characterised by (Van Buuren & Loorbach, 2009):

- their connection to a societal challenge (e.g. in the case of smart grid projects, integrating large amounts of renewable electricity generation into the energy provision system);
- illustrating a (radical) change of practices and/or culture and/or structures (e.g. in the case of smart grid projects, energy end-use practices); and
- their inherent relation to learning (as an interactive process of obtaining new knowledge, competences or norms and values).

'Niche experiments' have in the past been analysed using the 'strategic niche management' (SNM) approach (Kemp et al., 1998). SNM focusses on processes going on inside the 'niche' to understand the success or failure of particular socio-technological innovations. Three steps are to be followed when setting up niche experiments (Geels & Schot, 2010):

- selection of appropriate (i.e. promising) technologies for experimentation;
- identification of the most appropriate settings for experimentation (sometimes involving the creation of particular 'protective mechanisms');
- formulating clear goals, aims, expectations, rules of interaction, etc.

2.1.5 Conclusion

As can be concluded from the literature discussed above, it is important to take into account a large variety of factors when examining smart energy behaviour. To understand how end-users behave in smart grid and active demand projects and why an integrated approach is needed, that acknowledges the interaction between the individual and his or her social environment and the technological context of the smart grid. The notion of 'socio-technical' broadly refers to an understanding of social and technical

aspects being interwoven and mutually influencing; definitions of the technical and the social are shaped in a dynamic, historical process of co-development.

A socio-technical approach addresses both the individual and the social levels of change – in order to be able to achieve lasting change. Thus, the potential to change a behavioural pattern not only lies with individuals. If others do not learn to change too, and if the change is not accompanied by changes in culturally shared norms and values, or supported by adequate technologies, policies, regulations and infrastructures, then the individual will soon revert to his/her ‘old’ behaviour because the context is not supportive of or may even impede the ‘new’ behaviour. An approach that integrates situational and behavioural factors is the Sustainable Lifestyles Framework (Defra, 2011), see Figure 4.

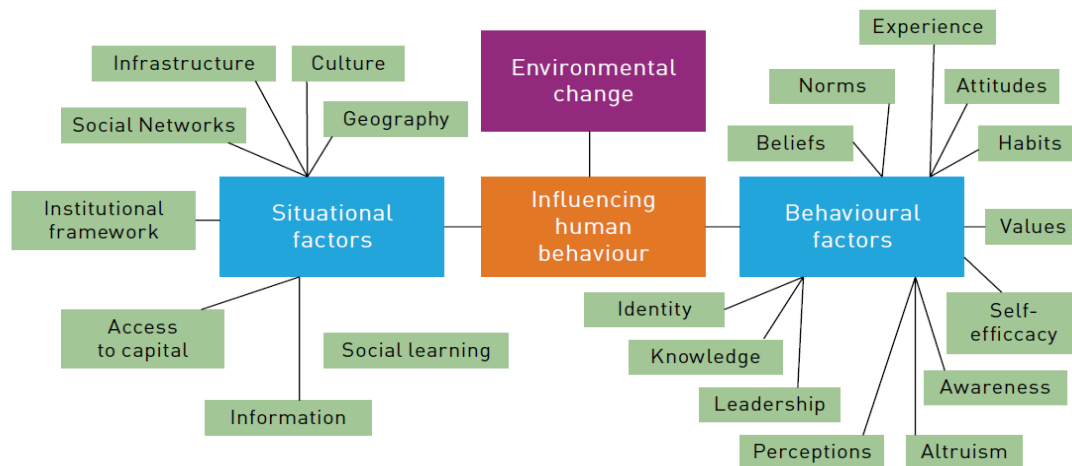

Source: Defra, Sustainable Lifestyles Framework, 2011.

Figure 4: The Defra Sustainable Lifestyles Framework (Defra, 2011)

2.2 What types of end-users can be distinguished?

The willingness of end-users to participate in active demand programs is influenced by a range of preferences that go beyond the (also relevant) socio-demographic criteria – such as age, household, income and education level – traditionally applied to energy purchasing decisions. When broadcasting a broad ‘one-size-fits-all’ message to all smart grid end-users, it is not likely to resonate with all of them. Because it is impossible to address each end-user as a unique individual, several utilities have introduced segmentation as a practical approach to enhance the performance of smart grid products. Segmentation is a marketing strategy based on a combination of psychological and sociological research, that generally involves dividing a broad market into subsets of consumers who have common goals and needs. The identified subsets can be used for designing and implementing strategies to target specific needs and desires using media channels and other touch-points that best allow to reach them. On the basis of a meta-review including 450,000 residential consumers in smart meter projects, Stromback et al. (2011) conclude that a segmentation approach can create “a win-win”. According to the authors, the importance and potential effectiveness of segmentation models requires further exploration through large-scale pilots to better understand how segmentation can contribute to better marketing and program design.

Segmentation can be placed in the sociological tradition of social stratification, aiming to classify people into groups based on shared socio-economic conditions (Macionis & Gerber, 2010). However, population segmentation entails a broader scope by incorporating psychological theory, in particular drawing upon Maslow’s humanistic psychological theory of motivational values (Maslow, 1943). It is important to note that the majority of segmentation models that are applied in practice to policy, product or project development and marketing and communications do not directly derive from independent scientific research, but rather from consultancy activities. Therefore, the theoretical and methodological basis of these models is not always transparent and in some cases this raises questions concerning validity and representativeness.

In this section we investigate the potential of segmentation approaches in smart grid projects. Based on an inventory of various segmentation models that are being applied in smart grid and active demand programs, we make a distinction between two types of segmentation models: population segmentation models and target group segmentation models.

2.2.1 Population segmentation models

Population segmentation models divide citizens into a number of social segments based on their general values, preferences and opinions. These approaches deliver generic segments or subsets, sometimes labelled as 'lifestyle milieus' or 'life worlds', which – in most cases – can be further applied to specific markets, products, lifestyles or policy objectives. The majority of population segmentation models are graphically visualized along two dimensions, for example referring to social status or traditional versus (post)modern orientation. There are also population segmentation models that are based on dimensions referring to character or personality traits, such as introverted versus outgoing. We present four population segmentation models.

2.2.1.1 Values Modes (UK)

Values Modes (Figure 5) is a segmentation system, run by UK based company CDSM (Cultural Dynamics Strategy and Marketing), that breaks down populations into three main 'motivational languages' and 12 distinct 'dialects' that can be used to design and plan communications and marketing. Each of these twelve groups represents between 7% and 12% of the population aged 15 years and over. The model is based on an on-going body of social survey research has tracked and forecasted the changing values, beliefs and motivations of the British population over the past 30 years. You can check your own values mode by completing the online questionnaire on the CDSM website.¹

The Values Modes model is rooted in Maslow's (1943) hierarchy human needs, starting with the Security Driven or Sustenance Driven mode in which basic needs are met (first air, water, food, safety, security and comfort, followed by sex, belonging, love and acceptance). This category is labelled by CDSM as 'Settlers'. The Settler Values Modes are: *Roots*, *Smooth Sailing*, *Brave New World* and *Certainty First*. The Next phase is the Outer Directed mode, in which people want to achieve esteem of others. CDSM calls people in this category 'Prospectors', consisting of *Golden Dreamers*, *Happy Followers*, *Now People* and *Tomorrow People*. The third phase, which focuses on Inner Directed needs, determined by our own thoughts rather than the need to win approval of others, is labelled as 'Pioneers'. Values Modes in this category are *Transitionals*, *Concerned Ethicals*, *Flexible Individualists* and *Transcenders*. People are not conscious of which mode they are in, although consequent differences in how people behave and perceive the world are profound.

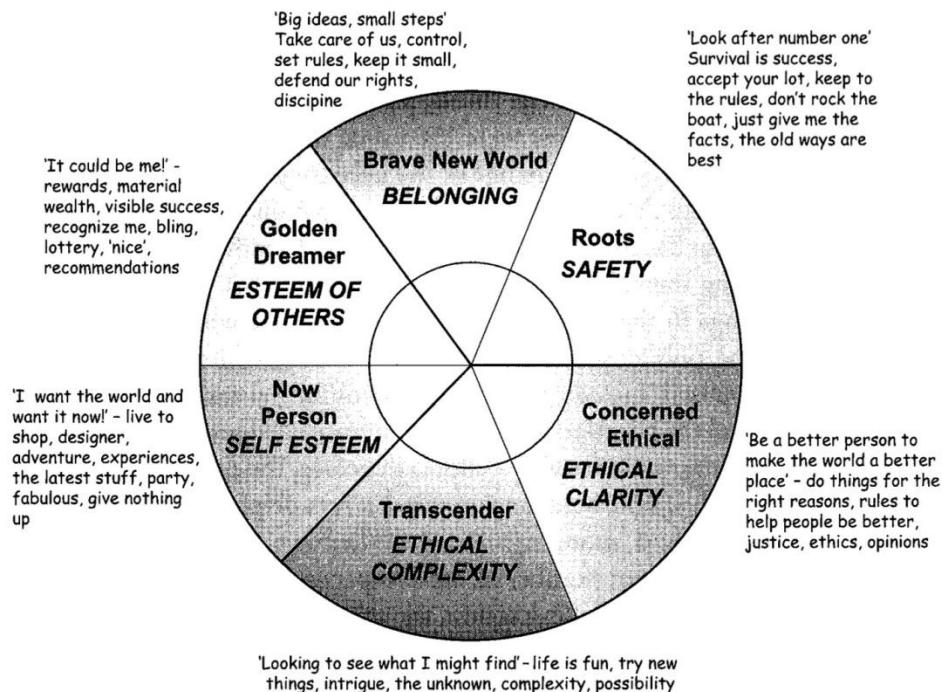

Figure 5: The six outside Values Modes, their driving unmet needs in italics, and some of their main orientations (Rose, 2010).

¹ www.cultdyn.co.uk

Since the orientations spill over into attitudes toward politics and the Values Modes are much more distinct than the major groups distinguished by Maslow, this model is particularly useful to fine-tune marketing or campaign propositions (Rose, 2010).

2.2.1.2 The perspectives typology

The perspectives typology (Figure 6) originates from cultural anthropology. It draws from the group-grid typology of Cultural Theory (Thompson et al., 1990) to delineate a number of stereotypical perspectives. Here, group refers to the level of group incorporation and grid refers to the level of constraining prescriptions. Following the group-grid dimensions, four ways of life or 'perspectives' are distinguished: Egalitarianism, Fatalism, Individualism and Hierarchy. Each stereotypical perspective constitutes a different way of how people interpret the observed world and act upon it and is based upon different interpretations of values, beliefs, and norms. The Egalitarian, for example, stresses group solidarity and environmental protection, the Hierachist government control and technocratic solutions, the Individualist market opportunity and individual freedom, and the Fatalist denying policy relevance at all, adopting a rather 'carpe-diem' philosophy (see e.g. Offermans, 2012).

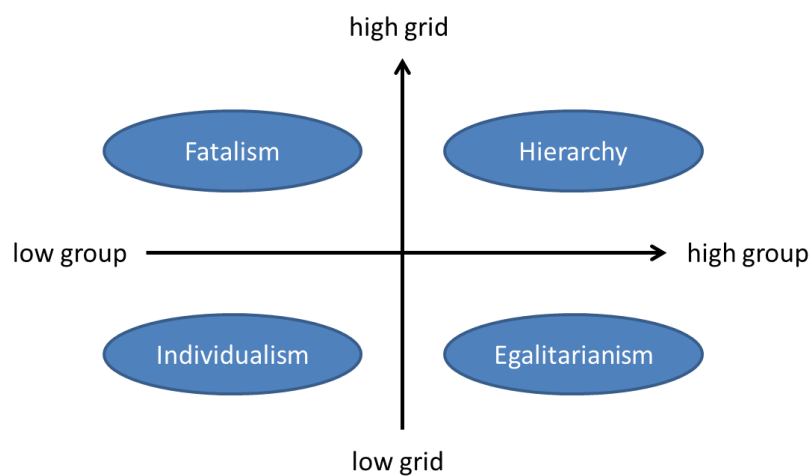

Figure 6: The Perspectives typology (Thompson et al., 1990)

2.2.1.3 Sinus milieus (Germany)

German company Sinus Sociovision GmbH has developed the Sinus Milieus model² that aims to capture changes in attitudes to leisure and consumption brought about by a structural transformation and changes to values, including the formulation of new values and lifestyles (see Figure 7). This transformation leads to new challenges when planning for strategic marketing, products and communications. Sinus milieu research aims to incorporate all the key experience areas that affect a person on a day-to-day basis (work, leisure, family, money, consumption, media, etc.). The value priorities and lifestyles that are determined from empirical analysis have been clustered into the Sinus-Milieu. Unlike traditional stratified divisions, the definition of the milieus comprises a content-based classification. Fundamental value attitudes that determine lifestyle and living strategy are as important in the analysis as everyday attitudes, desires, fears and expectations for the future. Sinus-Milieus aim to explain specific attitudes and methods of behaviour for each milieu on causal-analytical grounds. According to Sinus Sociovision, value attitudes and mental predispositions that are the result of a person's individual and social development have a major effect on behaviour.

² <http://www.sinus-institut.de/>

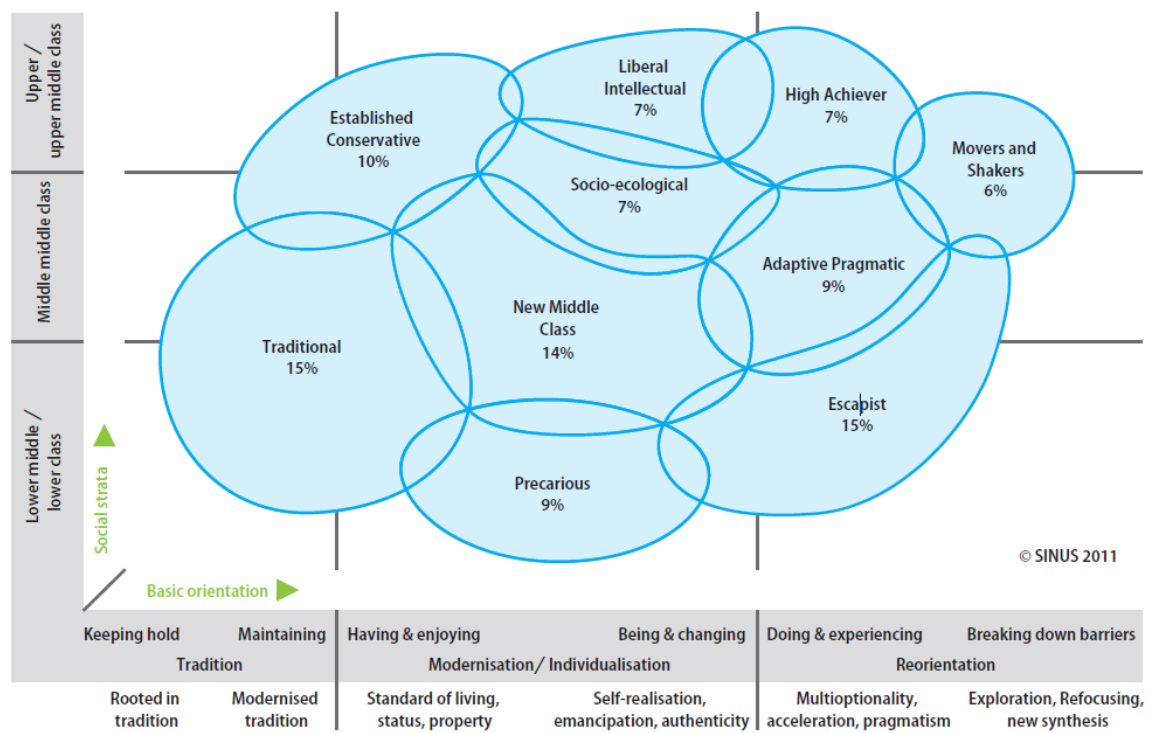

Figure 7: Sinus milieus

2.2.1.4 Mentality model (The Netherlands)

Dutch consultancy company Motivaction has developed a similar model: Mentality³. This is a lifestyle research product aiming to provide a look at target group classification and approach. The Mentality model groups people according to their attitudes towards life. Motivaction has created a database with over 23,000 respondents who are divided according to social milieu, and several thousand variables related to these milieus. Eight social milieus have been identified in the Netherlands on the basis of personal views and values that lie at the heart of people's lifestyles (see Figure 8). People from the same social milieu share values with regard to work, leisure time and politics, and demonstrate similar ambitions and aspirations. Every milieu has its own lifestyle and consumption patterns, which are expressed in behaviour.

³ <http://www.motivaction.nl/mentality>

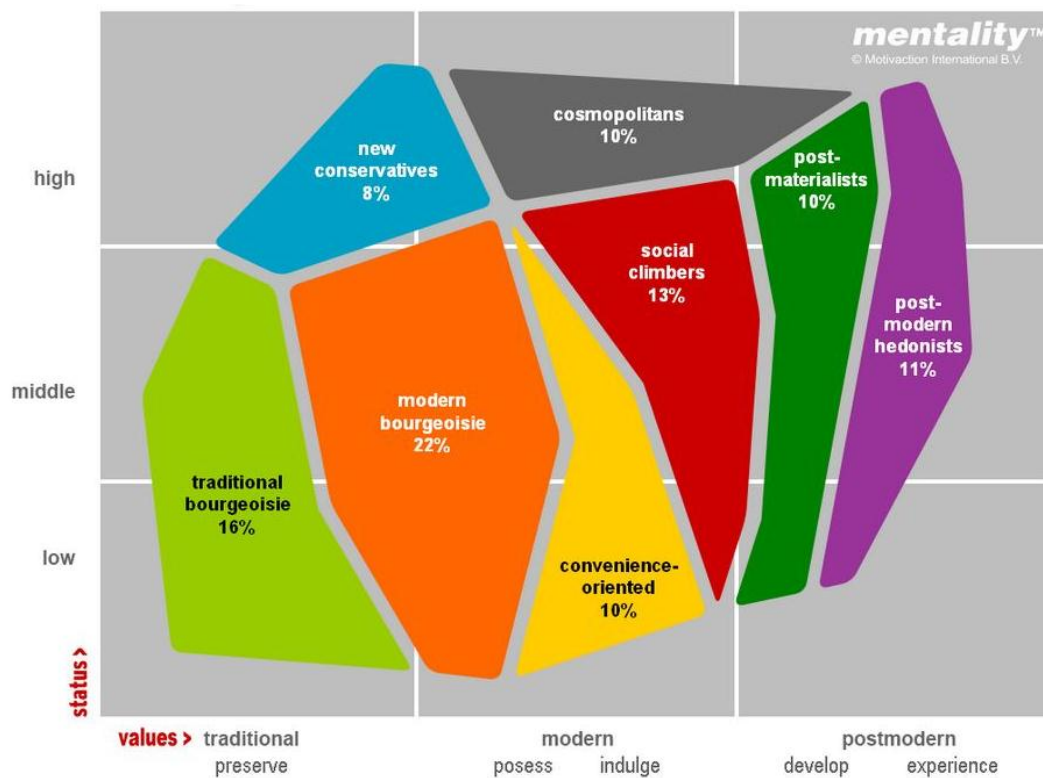

Figure 8: Mentality model

2.2.2 Target group segmentation models

The second type of segmentation models discussed here, consists of target group segmentation approaches. Contrary to the rather generic population segmentation models, target group segmentation models are tailored and deployed to specific products, programs or policy objectives. This section provides an overview of target group segmentation models specifically tailored to energy-related behaviour and smart grid projects.

2.2.2.1 Accenture energy consumer segmentation (worldwide)

In the study “Understanding Consumer Preferences in Energy Efficiency”, which was conducted in 17 countries by Accenture (2010), a range of consumer groupings are formed on the basis of factors that are incorporated into decision-making on a smart energy management system. By analysing and grouping the importance that consumers attach to the various aspects of electricity management programs, six distinct consumer segments were identified, each with its own differentiated preferences and behaviours (see Figure 9 and for a full description Accenture (2010), p. 29). The following components of electricity management programs were incorporated: impact on electricity bill, utility control, environmental impact and self-action required. Each segment reflects the attitudes toward electricity management programs, accounting for a significant slice of the global consumer population.

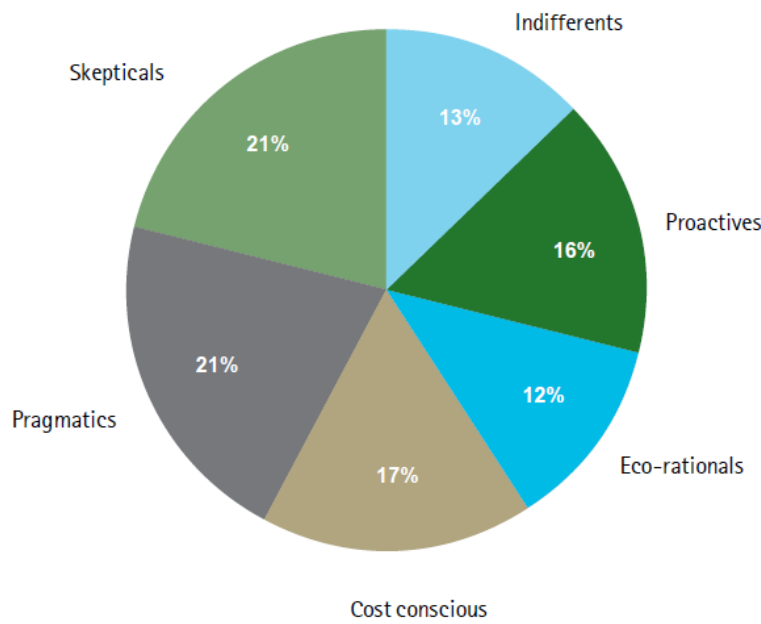

Figure 9: Accenture energy consumer segmentation (Accenture, 2010)

Based on conjoint analysis, Accenture (2011) also measured the geographical representation of the six segments around the globe (Figure 10).

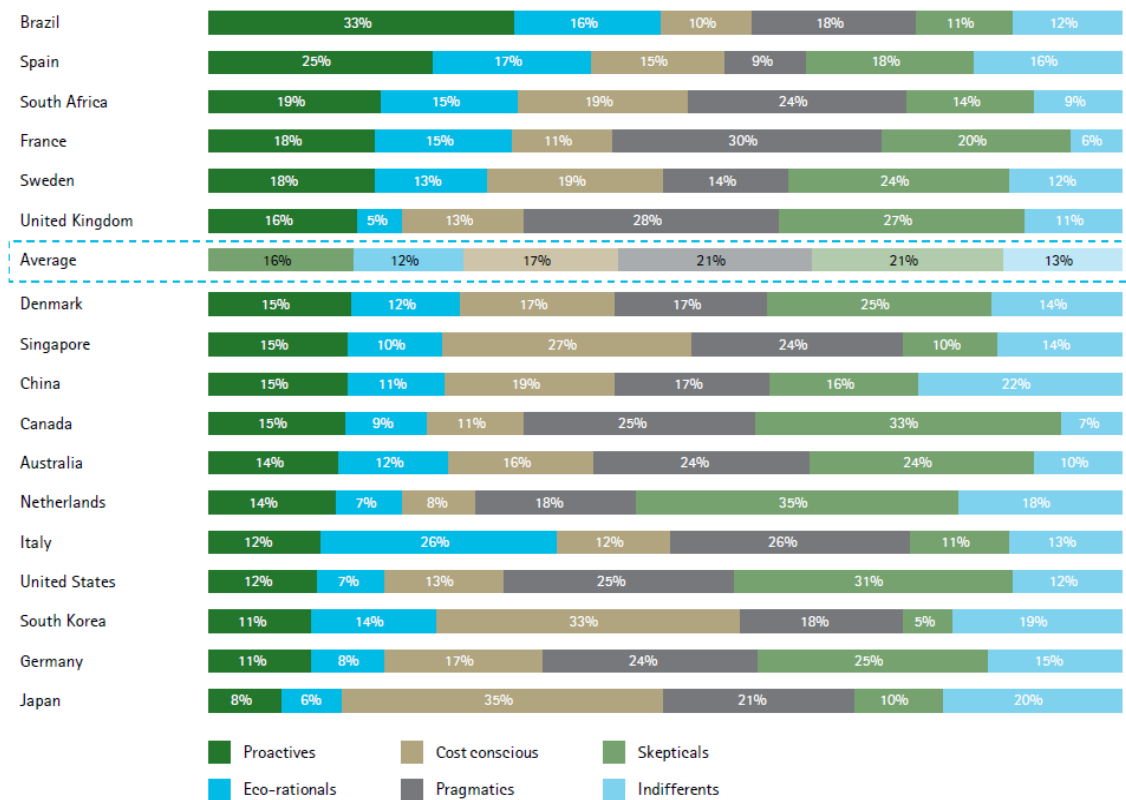

Figure 10: Geographical representation of the six Accenture segments around the globe (Accenture, 2011)

2.2.2.2 SGCC segmentation framework (USA)

As part of the Consumer Pulse and Segmentation research program, the American Smart Grid Consumer Collaborative (SGCC, 2013) built an actionable segmentation framework to provide members with an overall picture of consumers in the electricity market — the different consumer perspectives (segments)

that exist relative to Smart Grid issues, the main differences between them, and what proportion of the market segment each represents. The segmentation framework divides residential electricity customers into five distinct segments that are defined holistically in terms of attitudes, values, behaviours, motivations, lifestyles, technology adoption, etc.—as they relate to Smart Grid issues.

According to SGCC (2013), the segments react differently to Smart Grid concepts, products and services. Levels of interest in energy management range from “yes, definitely” to “no, thank you”. In addition to differentiating segments based on energy management and product preferences, the framework profiles the broader characteristics of each segment: attitudes, behaviours, shopping preferences, stance on environmental issues, acceptance or rejection of new technologies, lifestyles, values, and demographics.

Figure 11 shows the five distinct types of residential electric consumers in the United States:

The Five Segments

Concerned Greens: They comprise about 31% of the residential electricity market. They are most protective of the environment and supportive of Smart Grid initiatives. They are highly likely to participate in energy management programs.

Young America (23%) doesn't know much about smart grid, but are interested in learning about its potential for environmental benefits and cost savings.

Easy Street (20%) consumers have the highest income of any segment and are reluctant to change their personal behaviors.

DIY & Save (16%) consumers are frugal and have a do-it-yourself lifestyle. Their biggest concern is providing for their families, not global environmental issues.

Traditionals (11%) are set in their ways and don't see the need for energy reform.

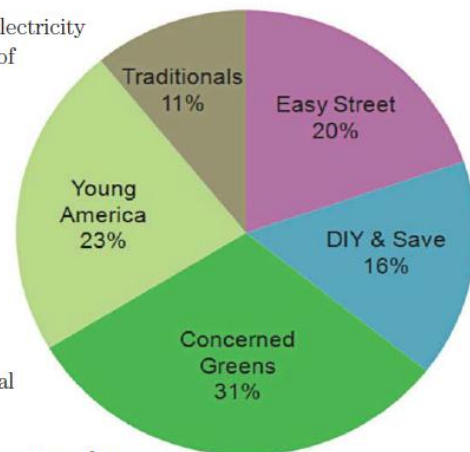

Figure 11: The SGCC segmentation framework (SGCC, 2013)

2.2.2.3 Netbeheer NL: segmentation of energy consumers (The Netherlands/Switzerland)

In a study on dynamic pricing models conducted for the Dutch cooperation of DSOs Netbeheer Nederland, Breukers & Mourik (2013) present a segmentation model of energy consumers based on energy-related behavioural characteristics. The model (see Table 1), developed by Sütterlin et al. (2011) based on a survey among 1.292 respondents, is representative for the Swiss population. Respondents were asked about their attitudes, behaviours and preferences. This model aims at identifying the energy saving potential of target groups. The resulting six segments offer end-user profiles including motivation, capabilities, consumption patterns as well as lifestyle elements (e.g. attitudes in combination with actual behaviours). The percentages mentioned are specific for the Swiss situation, but they are similar to the percentages found in Dutch pilots (Dam, 2013; Mourik, 2011).

Interestingly, Sütterlin et al. (2011) provide full insight into the survey items that were used to measure energy-saving behaviour and motives, acceptance of policy measures and psychosocial factors (beliefs and attitudes) related to energy consumption, as well as the statistical analysis of the survey data. This should enable replication (and validation) of their approach.

Table 1: Segmentation of energy consumers applied by Netbeheer NL (Breukers & Mourik, 2013; Sütterlin et al., 2011)

Segment 1: Idealistic savers (16%)
This group shows most efforts to save energy, both through routine behaviour and efficiency measures. Driven by idealism, these people are willing to make financial sacrifices and impose restrictions to themselves even if it means loss of comfort. They support policies that put a price on the energy intensity of products within a product category. They believe that they can make a difference, in a positive sense.
Segment 2: Selfless inconsistent energy savers (26%)
This group also shows significant energy-saving activities. At the same time, they are not very consistent: although they do believe that they can make a difference, they are quite inconsistent in terms of energy efficiency measures at home, because at that level they do very little.
Segment 3: Thrifty energy savers (14%)
The thrifty savers are into energy-saving as long as this does not bring them any negative financial consequences. This also applies to their acceptance of policies: these should not ask for any additional financial efforts from end-users. Their motivation is not primarily intrinsic, but relates to financial necessity and social pressure.
Segment 4: Materialistic energy consumers (25%)
The materialists do little to save energy, but are open to energy efficiency measures for the house. They are not very positive about policies if these have financial implications for them. The main motivation for energy saving behaviour is financial.
Segment 5: Comfort-oriented indifferent energy consumers (5%)
The comfort oriented are the least likely to energy saving behaviour. They do not care about the potential societal problems that the increasing energy consumption entails. They do not feel responsible and energy consciousness is nil. Their behaviour is driven by the search for personal comfort. This group of people is opposed to restrictive policies and interventions that discourage this behaviour.
Segment 6: Problem conscious welfare-oriented energy consumers (14%)
This segment is not enthusiastic about saving energy. Although they are aware of the consequences of their behaviour and also believe that energy-saving behaviour can make a difference, do not they feel called to action. This is possibly because they think that their ability to save energy is very limited. Although oriented towards comfort, they also feel a certain social pressure to do something about the energy situation.

In addition to the segmentation model, Breukers & Mourik (2013) developed a toolbox to design tailored dynamic pricing interventions, that consist of a combination of pricing mechanism, technology and feedback (see Figure 12). Each element in the toolbox is a building block that can be chosen or not. Each column represents the building blocks that can be chosen within the categories: pricing mechanism, technology and feedback. Depending on the specific segment at hand, different combinations of building blocks are chosen to create a basic design for a tailored dynamic pricing intervention.

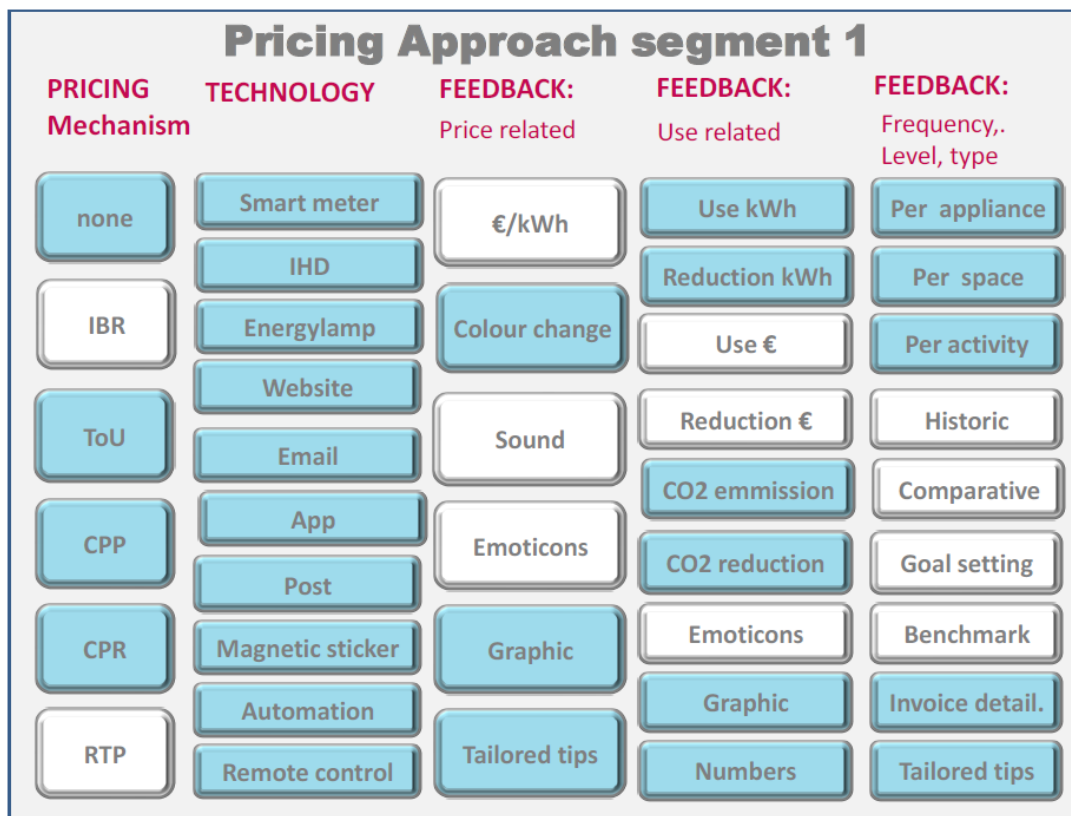

Figure 12: Toolbox to design tailored dynamic pricing interventions (Breukers & Mourik, 2013). This example shows building blocks (blue blocks) to be chosen for segment 1 ('idealistic savers').

2.2.2.4 eFlex project (Denmark)

Contrary to the segmentation models mentioned above, the Danish eFlex smart grid project took a qualitative research approach to identify end-user profiles, resulting in a segmentation model based on characteristic drivers for participation in load shedding and in the project in general (Dong Energy, 2012). Five different user profiles were identified: *The Technician*, *The Economist*, *The Curious*, *The Sympathetic* and *The Comfortable*.

Customers have been divided into five categories according to the findings from the anthropological survey, and afterwards customers were asked which category described their motivation drivers the best. The result was a very good match and the remaining customers were subsequently asked also to choose a category that they felt suited their motivation the best.

Although the customers displayed an impressive difference in behaviour and attitudes, it is possible to group them. However, the groups do not represent strong distinctions in behaviour and attitudes. There is some overlapping and many customers will point to belonging only to one specific group when asked to choose only one. Many more drivers could be found and many customers will probably think that it is not an entirely correct description of their motivation drivers. However, the eFlex approach is a promising attempt to transfer the findings into a more sociological type of comparison.

2.2.2.5 Defra's segmentation of pro-environmental behaviour

Defra's environmental segmentation model (Defra, 2008) divides the public into seven clusters each sharing a distinct set of attitudes and beliefs towards the environment, environmental issues and behaviours (see Figure 13). It is based on a three stage development process of scoping behavioural models from the literature, exploring the links between people's wider values, environmental attitudes and behaviours, and quantitative results from the 2007 Defra attitudes and behaviours survey. Amongst others, it was applied to the case of energy consumption (Brook Lyndhurst, 2007). The segments were further classified according to their willingness & ability to act, with 'positive greens' and 'stalled starters' at the high and low ends.

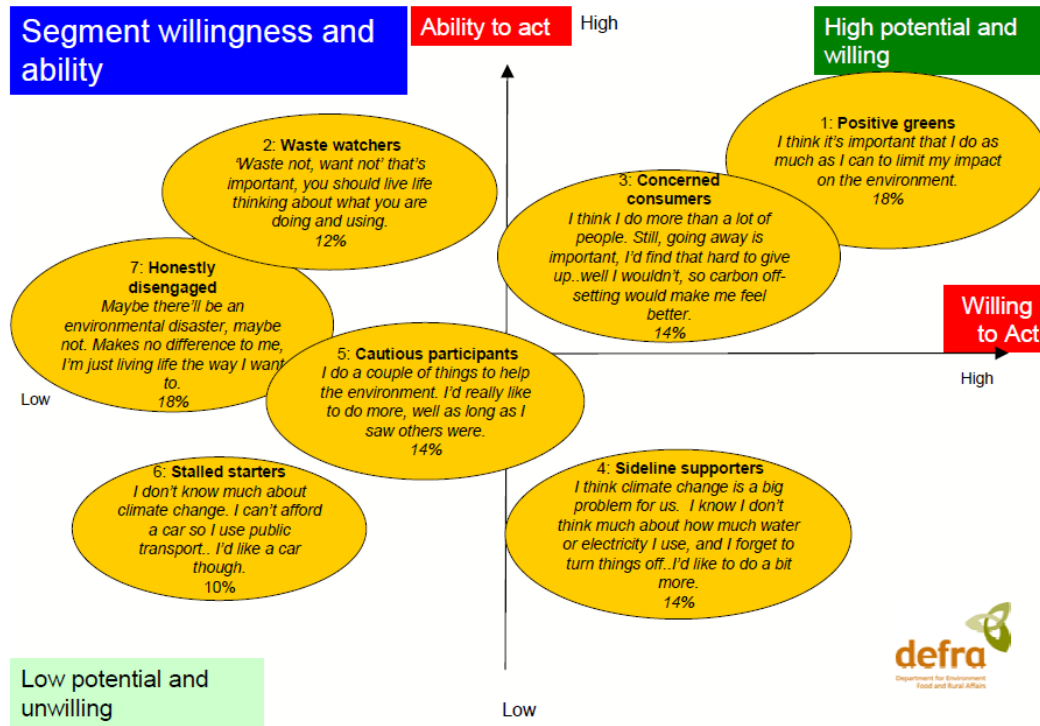

Figure 13: Defra’s environmental segmentation model for pro-environmental behaviour (Defra, 2008)

2.2.2.6 Segmentation model for PV

Vasseur (2012) introduces a segmentation model to classify households regarding the adoption of photovoltaic (PV) systems (see Figure 14). They distinguish two key dimensions; the attitude towards PV and the decision whether to adopt a PV system, which depends also on various other factors (for example income). Based on surveys among Dutch households, the four groups are further classified in terms of their demographic and geographic characteristics, cultural beliefs, values and related practices. This research thus nuances the traditional innovation diffusion classification of Rogers (2003) (innovators, early adopters, early majority, late majority, laggards).

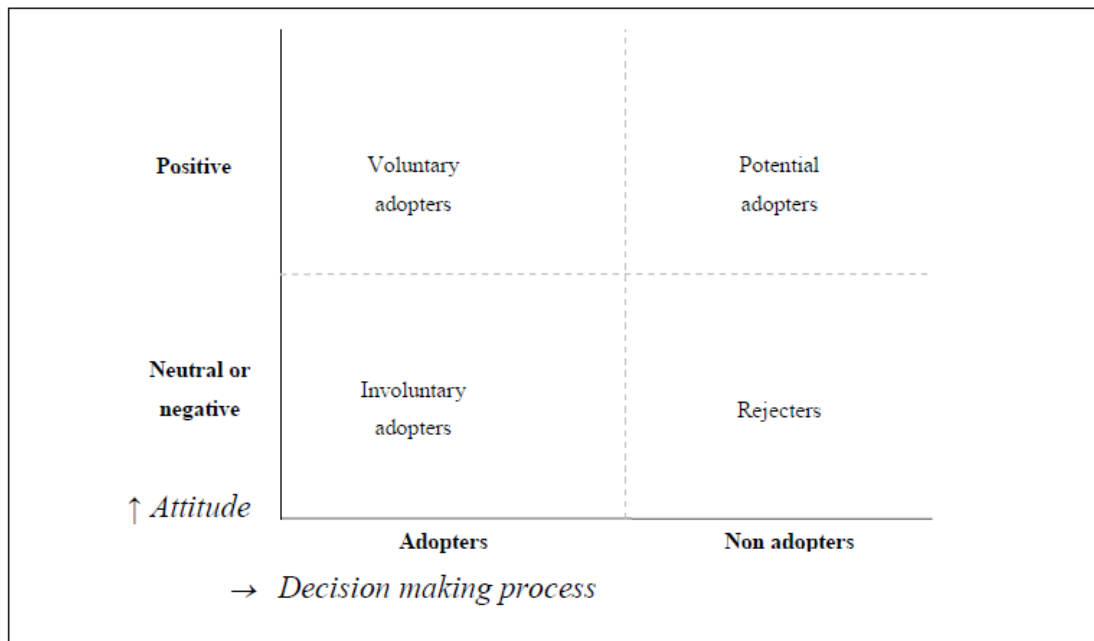

Figure 14: A segmentation model for PV (Vasseur, 2012)

2.2.3 Conclusion

The overview above makes clear that a segmentation approach can help optimize end-user engagement and motivation in smart grid and active demand projects. To this end, a target group segmentation approach seems more suitable than a generic population segmentation model that requires further specification and or translation to the world of smart grids and active demand. However, since several segmentation approaches that are currently used in practice, may lack – to some extent – methodological and statistical transparency, caution is required when adapting and implementing a segmentation approach. A further comparison of segmentation models on criteria of methodological rigour and practical applicability is needed to further assess the suitability of the different segmentation approaches for smart grid projects.

After identifying relevant end-user segments, the next step is to implement segmentation in the planning and development of the active demand scheme as well as in marketing and communications and project evaluation efforts.

2.3 How to actively engage end-users?

2.3.1 Marketing and communication

As discussed in the previous paragraph, end-users are not all alike; they differ in many important ways. If one follows this line of thought, the communications and marketing efforts towards end-users will be less effective and efficient if you approach them with a singular approach and message. So far we have looked at individual pro-environmental behaviour and possible related segments of groups of individuals. This chapter will give insights of general principles at how to communicate to different segments of the population or towards a target group. Just as segmentation is useful as a roll out strategy, so should ‘segmentation be exploited in marketing’ (Stromback et al., 2011). Examples Stromback et al. (2011) mention include advertising the same car in different ways to attract different customers, the SEAS-NVE program ‘Meter Hunt’, and the segmentation research of Danish Utility who created four different advertising campaigns for one internet site.

The integration of marketing ideas for new sustainable technologies might have a ‘pioneer-element’, but is not the first in its kind. The report on promoting electric vehicles in Europe by the EVUE; Electric Vehicles in Urban Europe (Sunnerstedt & Backman, 2012) looks at iPhone marketing models and ideas, and finds lessons learned for e-mobility. Such a line of thought can be interesting for the goals of S3C as well, and is part of the work which will be done further on in the project. Especially, given the fact that most segmentation addresses the characteristics of the house or appliances, and not the people who actually live in the house (Stromback et al., 2011).

2.3.2 Marketing theory

2.3.2.1 Leading marketing models

We do not attempt to provide a complete overview of marketing theories and models, seeing “the field is active and dynamically evolving” (Mela et al., 2013). What is discussed here is a selection of models and theories relevant for the S3C project objectives. We therefore give a short overview on well accepted frameworks in the field of marketing. Most marketing models are based on two theories/principles, namely the ‘3C’s framework’ developed by Kenichi Ohmae in 1982 and the ‘4 P’s’ marketing mix, proposed by marketer Jerome McCarthy in 1960.

2.3.2.2 The 4 P’s marketing mix

The marketing mix of Product, Price, Promotion, and Place, was introduced to marketing education by McCarthy (1960). These easy-to-remember labels rapidly became the organizing structure for virtually all introductory marketing textbooks, and the basic structure of the four P’s represents an essentially valid construct that can effectively be used to organize marketing courses well into the 21st century (Yudelson, 1999).

A short summary of the marketing mix and its central themes, the 4 P’s :

- *Product*: This is where the product or service is defined. If selling something, then define exactly what it will do. But equally important, you need to define exactly what it won’t do. What will it look like? How will it be packaged? If offering a service, then the same applies. The service needs to be really well defined. Clearly articulate what to offer and what not. If this is not clear,

then you may fall victim to ‘scope creep’ where customers will keep expanding the scope of what you had originally promised them.

- *Price*: How will products or services be priced? If selling a product, what price can the target market pay? Does the product or service have any pricing power? That is, if you’re a famous coffee house, then you may be able to sell coffee at higher prices than a local coffee shop.
- *Promotion*: How will you market your product? What advertising channels will be used? What social marketing strategies will be deployed? What is the marketing budget? What return on investment (ROI) should be achieved from the money plan to invest in marketing?
- *Place (Distribution)*: How will the product be stored and distributed? What distribution channels will be used? Will you sell through distributors or are you planning on selling directly to your customers? If a service is offered, then where will this service be offered?

2.3.2.3 The ‘3 C’s’ framework

The three C’s stand for Customer, Company and Competition (see Figure 15). As Ohmae (1991) explains his framework for strategic planning and decision making: “The matching of needs between the customer and the corporation must be not only positive, but better or stronger than that between the customer and the competitor. When the corporation’s approach to the customer is identical to that of the competition, the customer cannot differentiate between them and the result could be a price war, which may satisfy the customer’s needs but not the corporation’s. Strategy must then be defined in terms of these three key players as an endeavour by a corporation to differentiate itself positively from its competitors, using its relative corporate strengths to better satisfy customer needs.” The 3C’s framework thus highlights the importance of getting to know your customer and his needs, and the central role this plays in marketing.

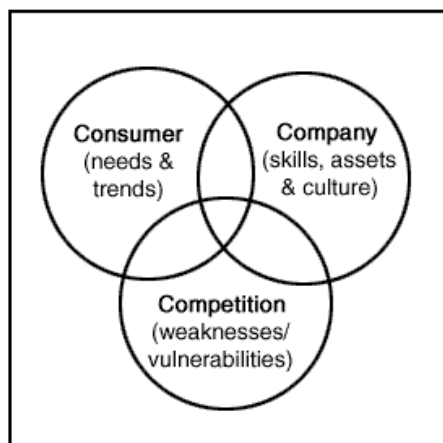

Figure 15: The 3 C’s from Ohmae (1991)

2.3.2.4 AIDA model

A model with learning potential for utilities is the AIDA model from American advertising and sales pioneer Elmo Lewis (1985). It may be particularly useful to find potential end-users for commercial projects and roll out plans. The model indicates how to engage with potential customers following four main steps (further illustrated in Figure 16):

A - Attention (Awareness): attract the attention of the customer.

I - Interest: raise customer interest by focusing on and demonstrating advantages and benefits (instead of focusing on features, as in traditional advertising).

D - Desire: convince customers that they want and desire the product or service and that it will satisfy their needs.

A - Action: lead customers towards taking action and/or purchasing



Figure 16: The AIDA model of Lewis (1985) applied to internet marketing⁴

2.3.2.5 Cialdini's principles of influence

The Six Principles of Influence were created by Robert Cialdini, Regents' Professor Emeritus of Psychology and Marketing at Arizona State University. He published them in his respected 1984 book titled 'Influence: The Psychology of Persuasion'. Cialdini (1984) identified the six principles of influence through experimental studies, and by immersing himself in the world of what he called 'compliance professionals' – sales people, fund raisers, recruiters, advertisers, marketers, and so on. The six principles are illustrated in Figure 17 and further explained below.

- *Reciprocity*: As humans, we generally aim to return favours, pay back debts, and treat others as they treat us. According to the idea of reciprocity, this can lead us to feel obliged to offer concessions or discounts to others if they have offered them to us. This is because we are uncomfortable with feeling indebted to them.
- *Commitment (and Consistency)*: Originating from Festinger's Cognitive Dissonance Theory, Cialdini says that we have a deep desire to be consistent. For this reason, once we have committed to something, we are more inclined to go through with it.
- *Social Proof*: This principle relies on people's sense of 'safety in numbers'. We are assuming that if many other people are doing something, then it must be OK. We are particularly susceptible to this principle when we are feeling uncertain, and we are even more likely to be influenced if the people we see seem to be similar to us.
- *Liking*: Cialdini says that we are more likely to be influenced by people we like. Likability comes in many forms – people might be similar or familiar to us, they might give us compliments, or we may just simply trust them. Companies that use sales agents from within the community employ this principle with huge success.
- *Authority*: We feel a sense of duty or obligation towards people in positions of authority.
- *Scarcity*: This principle says that things are more attractive when their availability is limited, or when we stand to lose the opportunity to acquire them on favourable terms.

⁴ <http://www.guerrillaonline.com/cs/Guerrilla-Marketing-Principles-54.htm>

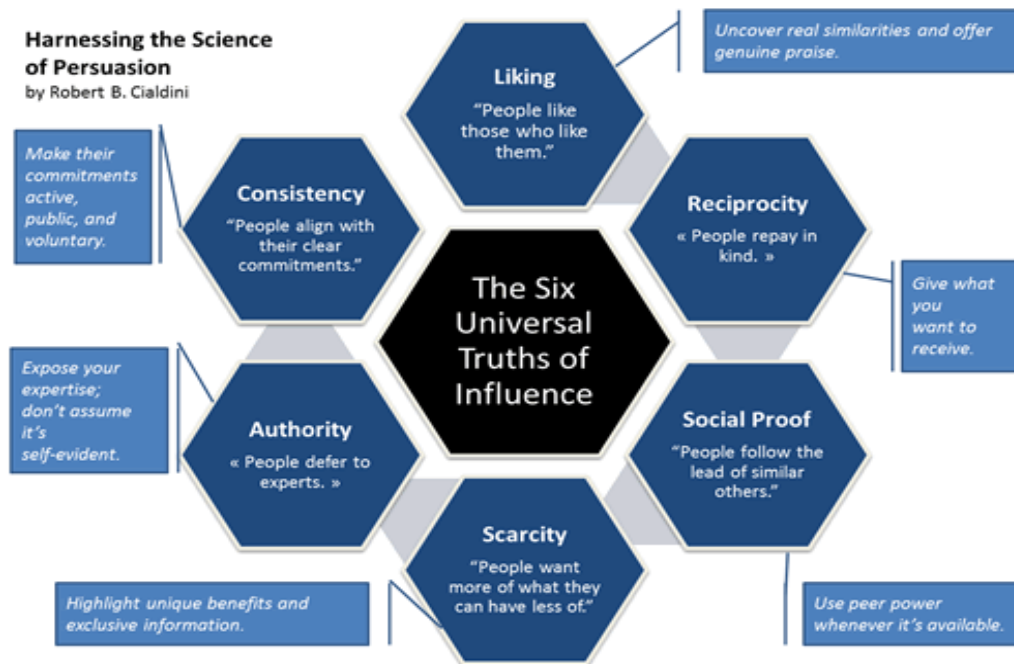

Figure 17: Cialdini's principles of influence (Cialdini, 1984)

2.3.2.6 Promoting efficiency investments

In line with marketing principles of trying to get people interested or have them purchase something, Breukers et al (2009) looked at what can help with promoting efficiency investments. They addressed five different 'tools' for change concerning energy investments:

- *Emotional appeals*: As rational appeals are an important factor for energy investment behaviour, emotional appeals play a part as true motivation for a purchase. Emotional appeals can for example attempt to make someone feel good about himself, or suggest that it is socially appealing to choose for it. There is an abundance of examples for emotional appeals of commercials, and the research of Breukers et al (2009) states that these kind of appeals are good when supported by personal advice and appropriate financial mechanisms.
- *Rational appeals*: These appeals are important for purchasing, especially if they are clearly relevant to a target group, and when there are fairly short pay-back periods (3-5 years). Personalized advice and short-term benefits are very good rational appeals.
- *Build trust and confidence*: It is important to reduce the risk of purchasing for potential buyers by e.g. offering guarantees or quality certificates, and build on real-life examples that are as similar as possible for your target group. It is also important to know whom or what people are likely to trust.
- *Provide transparent and understandable information*: As people in general know fairly little on energy use, which can make energy investments difficult and confusing. It is important to find the right balance between conveying a clear understandable message and providing transparent, unbiased information.
- *Provide support and services*: Providing a network of reliable, certified and honest service providers can be an important trigger to help people. They can be supported by market surveys, user experiences, quality labels, price quotations and customer ratings of service providers.

2.3.2.7 Social marketing

Similar principles are reflected in the concept of social marketing. NSMC (2011) defines social marketing as: "an approach used to develop activities aimed at changing or maintaining people's behaviour for the benefit of individuals and society as a whole". It is rooted in behavioural economics, and advocates understanding the target audience, evaluation, and using a mix of methods as key principles. The following benchmark criteria reflect key success factors emerging from reviewing behaviour change programmes:

- *Clear behavioural goals*: Set clear, specific, measurable and time-bound behavioural goals, and establish baselines and key indicators.
- *Customer orientation*: Fully understand their lives, attitudes and current behaviour using a mix of data sources and research methods
- *Theory*: Use behavioural theories to understand behaviour and inform the intervention
- *Insight*: Gain a deep understanding of what moves and motivates the target audience and influences the behaviour; identify emotional as well as physical barriers
- *Exchange*: Optimise the balance between (perceived) benefits and costs, considering what the target audience values, offering incentives and rewards etc.
- *Competition*: Understand what competes for the audience's time, attention, and inclination to behave in a particular way
- *Segmentation*: identify audience segments typically on the basis of demographic, geographic, behavioural and psychographic variables
- *Methods mix*: Use a combination of approaches, based on for example the 4Ps, Defra's 4Es (see below), or other model.

Finally, a 6-stage planning process is advocated:

- *Getting started*, e.g. reflecting on the issue or challenge to be addressed
- *Scope*, e.g. getting the right people together, analyse, get information.
- *Develop*, e.g. a social marketing plan with an intervention mix and SMART objectives
- *Implement*, e.g. carry out the plan and monitor the results
- *Evaluate*, e.g. reflect on results and objectives, define recommendations
- *Follow-up*, e.g. plan next steps

2.3.2.8 Defra's 4E model

Along the general social marketing approach, Defra (2008) has developed the 4E model for promoting pro-environmental behaviour through government policy. Rooted in behavioural sciences and sociology, it aims to provide an integrated model "to establish new and more sustainable ways of living, working and producing – and for these to become the new habits". As illustrated in Figure 18, it constitutes four key angles that are in principle all part of an effective behavioural change strategy:

- *Enable*: make it possible and easy for people to engage in new types of behaviour, for instance by removing barriers, giving information, education and training.
- *Encourage*: encourage people to adopt new types of behaviour, for example through taxes, subsidies, rewards schemes and / or other regulations.
- *Engage*: make people part of the overall challenge, by supporting bottom-up initiatives, community actions, and deliberative forums.
- *Exemplify*: ensure that government organisations consistently portray the sustainable behaviour they are trying to promote.

Behavioural Goal: Energy Efficiency in the Home

Measures that provide core infrastructure

- Energy Efficient Products: White Goods A-G Labelling, Energy efficiency recommended, voluntary phase-out of inefficient lighting;
- Change boiler: Boiler standards in Building regulations
- Switch tariff: Renewables obligation, disclosure on bills;
- Build / buy efficient homes: Home Information Packs/Energy Performance Certificates, Building Regulations, Code for Sustainable Homes, no Stamp Duty on new Zero-Carbon homes, Local planning requirements for new developments;
- Energy management: provision of energy displays and smart metering

ANNEX D

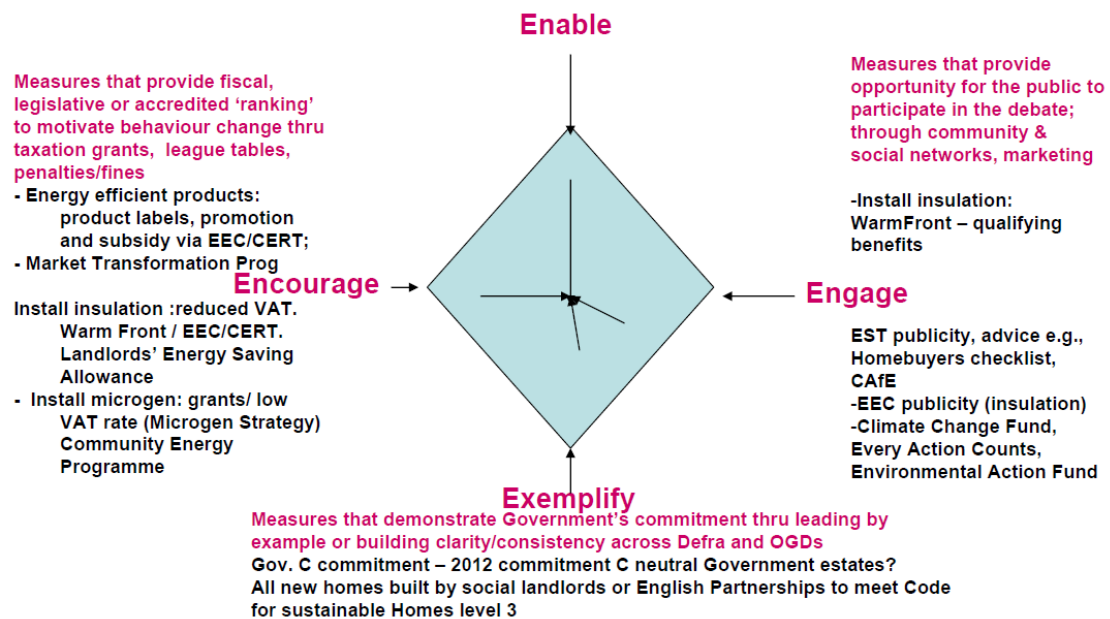

Figure 18: Defra's 4E model applied to the behavioural goal energy efficiency in the home (Defra, 2008).

2.3.3 Communications theory

This section addresses ways of 'how' to engage an end-user; what and how do you communicate? Once you have a marketing model to frame your intentions and goals, combined with tools to attract end-users, the way of how you will communicate is in order. This paragraph contains an overview of basic communication theory. The importance of communication is mentioned in the conclusions of Stromback et al. (2011):

“Successful customer communication leads to successful programs: Positive messages, timely, directed, containing the appropriate information, combinations of information (bills, feedback displays), etc. all increase customer participation.”

A clear example of basics of communication is formulated by Rose (2010). For communication he proposes at least seven key components that can be distinguished, the CAMPCAT principle; Channel, Action, Messenger, Programme, Context, Audience and Trigger. We use the content of this principle, although in a somewhat different structure, based on the report of the EU project Changing Behaviour (Breukers et al., 2009): the sender, the target group, the aim, the message, the timing, the communication channels. Table 2 provides a brief summary of all components.

What are the most efficient actions and channels of communication to reach the different goals? Each communication action makes use of at least one communication channel (e.g. website, e-mail, phone, visit). Each of these channels has its pros and cons. A website is e.g. more suitable to send general information about the project, while home visits are a better way to explain the specific use of the installation in relation to the daily life of the participant. Moreover, there is a difference between the suitability of communication channels and actions to achieve the different goals. A brochure, for example, is effective to inform people, but not to engage them. It is important to create the best set of communication channels and actions to reach all the goals throughout the project.

Table 2: Components of communication (Breukers et al., 2009)

Component	Summary
The sender	Who is communicating? It is important to identify clearly in advance who the sender of the information is and to be transparent about this to the target group.
The target group	In planning the communication activity the target group should be defined beforehand; who is the specific target group of the communication action? Each communication activity must be targeted and tailored to the right target group.
The aim of the action	Why are you communicating? What do you want your target group to know or do?
The message	The message comprises the content of the message ('What') as well as the tone of voice/form. To enhance the message being picked up by the target group, it should be adapted to the preferences of the target group
The Timing	At what moment should the message reach the target group? What is the right timing for sending the message?
The communication channels	There are many ways to communicate the message to the target group. In order to reach the target group, you must use the same media/ channels as they do.

A valuable lesson on communicating about energy behaviour comes from Breukers et al. (2009) in that it is important to engage the community in changing energy behaviour. They suggest four different tools in their research:

- *Peer to peer communications*: In close relation to the social importance of Cialdini's principles, people want to be like other people around them. Advice networks and organising local events are good examples of these communications, even though it might be difficult to monitor whether the message gets through.
- *Social support and social pressure*: Also close to Cialdini, Breukers et al. (2009) state that people are stimulated to change because of other people whose opinion they value, and may even disapprove of those who do not participate in the change process. And if enough people adopt the new behaviour, it becomes 'normal'. A good practical example is making use of role models.
- *Make sure everyone 'does their bit'*: As individual efforts have no impact on large problems like climate change, if other people don't contribute, people don't want to make useless sacrifices. That's why your target group needs to know other people are 'doing their bit' and working together to solve the problem.
- *Engage stakeholders*: Change in energy-related behaviour is part of a larger change in the social and technical organisation of everyday life. It is important to engage the relevant stakeholders such as service providers or retailers. It can be important to create a win-win situation if you want to create these cooperation's.

Another inspiring example of combining communication 'lessons' or insights, comes from Rose (2010), who combines the psychological theory of Maslow with marketing principles, in order to have the right communication channels with the right communication messages. With this approach it enables the initiator to gain insights in the values and needs of the end-user, and will have an idea on what to communicate through which channels. The role of the media should also be taken into account as Stromback et al. (2011) conclude: "*Involve the media early on: Media response to a program will decide to a certain extent customer acceptance and engagement. Therefore, involving media during piloting is wise. It can potentially improve future marketing campaigns by helping the utility to hone marketing and education messages as well as avoid some future negative publicity.*"

3. Empirical perspective

This chapter provides an overview of empirical lessons learned, drawing from various evaluation reports and meta-reviews of experiences with demand response projects. Section 3.1 first looks into the economic aspects of demand response, describing and evaluating different possible incentives and tariff structures, with a focus on the perception and response of end-users. Section 3.2 evaluates different ways of offering end-users feedback on their energy use, looking at the different channels, devices and information content. Section 3.3 describes lessons learned on communication towards end-users, as a way to generate end-user engagement within smart grid projects. Section 3.4 briefly looks into some key principles on privacy and security issues that need to be considered. Section 3.5 highlights new market structures supporting the operation of the smart-grid, and the role end-users in such new structures may take. Section 3.6, finally, reviews some experiences with the uptake of innovations in the related sectors of the mobile phone and ICT industry.

3.1 Tariff structures and incentives

Demand response (DR) can be defined as a change in the consumption pattern of electricity consumers in response to a) changes in the price of electricity over time, or b) to incentives (e.g. payments) in order to operate the electricity system in a more efficient and reliable way (Stromback et al., 2011; DOE, 2006). From this view, two groups of demand response programs can be distinguished: a) *price-based* and b) *incentive-based* demand response programs.

In this section we will describe both forms of DR, including the different options for energy-price tariff structures and incentives to induce demand shifts from end-users⁵ (see Figure 19), the advantages/disadvantages of these different options/approaches and finally end-user preferences based on a literature review of published meta-reviews of experiences with active demand. Sub-section 3.1.1 will give an overview of potential incentives – both monetary and non-monetary – given to end-users participating in incentive-based DR programs, whereas sub-section 3.1.2 will describe potential tariff schemes for price-based DR. The former programs typically apply automated control of flexibility. In the latter programs there are two options: consumers can shift their flexible consumption themselves or automated control can be applied to certain appliances in function of the tariffs. Also, a combination of both may be adopted.

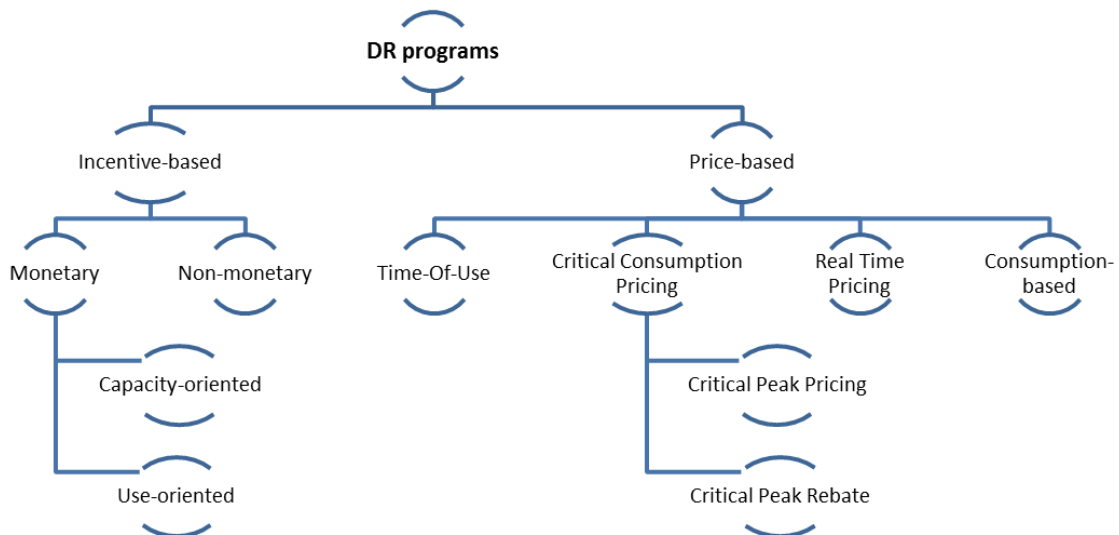

Figure 19: Demand Response Programs

3.1.1 Incentive-based programs

Incentive-based programs (IBP) can be further classified into two categories/groups: classical and market-oriented (Albadi, 2008). Customers who participate in classical IBP are often entitled to participation

⁵ Households and SMEs

payments in the form of bill credits or discount rates⁶. Participants on market-oriented IBP receives a monetary compensation on a performance basis⁷. Classical IBP include Direct Load Control (DLC)⁸, and Interruptible/Curtailable programs. Historically, the former focused on residential end-users and SMEs, while the latter focused on larger industrial customers. Market-oriented IBP include Emergency DR, Demand Bidding, Capacity market and Ancillary services market programs. For a comprehensive definition of the above mentioned programs the reader is referred to (DOE, 2006).

Among IBPs different options to compensate participants exist:

- A first distinction can be made between *monetary* and *non-monetary incentives* ('in kind').
- Within monetary incentives we can further distinguish between *capacity-oriented* and *use-oriented incentives*, which respectively compensate for demand response availability and delivery. Also other types of incentives (such as cash or bill discounts) which are not related to the flexibility offered/delivered exist.

In the next paragraph these different types of incentives are briefly described.

3.1.1.1 Types of incentives

Monetary incentives can take various forms and may consist of one or many payments distributed along the duration of the program. *Non-monetary incentives* ('in kind') refer to incentives given to program's participants that do not directly impact their bill or personal economy. Examples of 'in kind' incentives, but not limited to, are smart appliances or other project equipment given to participants for free or with a discount.

As mentioned earlier, a further distinction can be made within monetary incentives. Payments for capacity reservation (capacity-oriented incentive) are financial incentives given to resource owners for putting a certain amount of capacity for load reduction in standby. Payments concerning the use of this capacity (use-oriented incentive) reflect the actual curtailment/load reduction provided by the resource owner. Capacity- and/or use-oriented incentives are usually found in market oriented programs⁹. *Use-oriented incentives* thus take into account the actual response (volume of consumption shifted) to compensate the participants, whereas *capacity-oriented incentives* compensate for the volume/capacity of flexibility that are kept available by the participants for being used¹⁰. A combination of both options is also possible (e.g. a capacity fee for the flexibility that is kept available combined with an extra compensation for the actual response). As already mentioned these types of incentives can be found in market-oriented IBP, but also the classical Interruptible / Curtailable programs may use these types of incentives.

3.1.1.2 Measuring actual capacity and suitability of incentives

To measure participants' actual capacity freed for use (i.e. actual volume of consumption shifted) typically a consumer's baseline is established/set in DR programs. The setting of the baseline can take different methodologies. An explanation of the different methodologies can be found in (Ramos, 2013).

In the context of residential demand response, the measurement of delivered flexibility when use-oriented incentives are applied might imply unforeseen difficulties/hurdles, since this implies that you can measure or estimate the actual responses of the participants which might not be obvious to do. Moreover, it might be more important for end-users to know which appliances are put under control and in which periods of

⁶ Utilities started to implement these programs, in the early 1970s, by paying the participant an up-front amount (in \$/kW/month or a bill credit) or giving a discount (per kWh reduced). As discussed in (Cappers, 2010) these programs leaved the utility without the possibility to enforce participant's action (i.e. reduce load).

⁷ Depending on the amount of load reduction during critical conditions (e.g. shortage of reserves).

⁸ Utilities install equipment at consumers' premises that allow the utility to remotely control household appliances - e.g. light fixture, air conditioners, water heaters, pumps - during periods of system stress, e.g. shortfall of generation.

⁹ As it can be inferred, the participation payment is done before any action is performed, while the load reduction payment is done some time after the action takes place (Braithwait, 2006).

¹⁰ Braithwait (2006) argues that where liberalization and competition has been introduced classical IBP has given way to more market-oriented programs (e.g. emergency or capacity DR programs). Under these programs capacity credits are given to customers who offer load reduction at short notice.

time. In this case, capacity-oriented pricing seems justified. A capacity-oriented approach will provide an incentive to consumers to offer as much flexibility as possible. There are thus several options within a capacity-oriented pricing model, e.g. every month a fixed amount for participating to the program depending on the devices that are put under control, capacity price for each appliance where the participant can choose which appliances can be controlled during which period, etc.

Depending on the type of devices that are put under control, some incentives might be more appropriate than others. For instance for devices with a thermal buffer, like an electric boiler or heat pump, a fixed monthly amount depending on the comfort settings of the consumers could be used. For shiftable devices (like dryers, washing machines,...) the compensation should depend somehow on the flexibility offered (e.g. the number of hours of delay, the consumption cycle of the appliance, the time of day,...) to really motivate the consumers to postpone the utilization of these devices.

Most customer enrolment and response are voluntary, although some demand response programs levy penalties on customers that enrol but fail to respond or fulfil contractual commitments when events are declared (Eissa, 2011).

3.1.1.3 Examples of incentives

Overall, there appears to be a lack of examples in which detailed information concerning incentives for end-users is provided. In Prügler (2013) it is stressed that “DR in Europe is still limited”. This view is further supported by Torriti (2010) who points out that “there is a limited number of incentives and a lack of means for customers to respond to changes in prices”. Nonetheless, the examples currently documented provide relevant insights as described in this section.

In the residential context, DLC programs, among all DR programs, are the most widely deployed (Faruqui, 2008). Below some real-life examples of incentives implemented for households and SMEs are presented.

- *Monetary incentives - cash or bill discounts:* Monetary incentives such as bill discounts or cash payments come in many forms and their amount typically varies per program and even per year.

For example, participants in the California Automated Demand Response System (ADRS) pilot received a yearly payment of USD \$100 (USD \$125) in 2004 (2005) for the control of air conditioners and pool pumps (spa pumps when available). Residential participants in the PSE&G Residential Pilot in New Jersey or the California Statewide Pricing Pilot for Small Customers received a total amount of USD \$100¹¹ and USD \$175¹² respectively. The amount is fractioned in two to three payments mostly delivered at the beginning and at the end of the program (Crossley, 2008).

The LIPAedge¹³ program, as in the ADRS pilot, rewarded residential participants and small commercial customers with one payment of USD \$25 and USD \$50, respectively. By receiving this payment customers allowed the control of residential and small commercial air-conditioning thermostats. In addition, there was the possibility to receive an extra USD \$20 for customer referral (LIPAedge, 2013).

The Progress Energy Florida DLC and Standby Generation program awarded bill credits to enrolled residential consumers for the control of their space heating and air conditioning systems, water heaters and pool pumps. The payment could reach a maximum per month of USD \$11.50 (PEF, 2003).

In Australia residential customers enrolled in the ETSA utilities air conditioner DLC program were paid AUD \$100 at the time of enrolment (Crossley, 2008).

As it can be seen none of the examples mentioned above reward the actual performance (i.e. capacity put at disposal for control or their use) as is the case in capacity- and use-oriented incentive schemes.

¹¹ For the control of thermostats.

¹² USD \$500 for commercial and industrial customers. Residential customers installed load control devices (e.g. smart thermostats) on their central air conditioners, electric water heaters or pool pumps.

¹³ LIPA stands for Long Island Power Authority.

- *Monetary incentives - capacity- and use-oriented:* Programs such as the ones implemented by the New England Independent System Operator (ISO), the New York ISO or the Sacramento Municipally Utility District (SMUD) are examples of capacity- and use-oriented incentives (Crossley, 2008).

The ISO New England via an enrolling participant¹⁴ gave use-oriented ‘utilization’ payments (from a guaranteed minimum up to USD\$1000 per MWh based on the actual real-time Locational Marginal Price (LMP) at the customer’s load zone) to commercial and small industrial customers¹⁵ for the amount of demand reduced. Payments for capacity and reserve margin were also implemented. Given that curtailments are mandatory, failure to comply resulted in a fine and a de-rated curtailment capability for the customer.

The New York ISO programs addressed a wider range of market segments (from residential consumers to large industrial customers) than the ones implemented by ISO New England. Curtailment Service Providers (CSP), as defined by the NYISO, were entitled with utilization and capacity payments. The amount of the payment the CSP receives varies with the subscribed program. For example, in one program the ‘utilization’ payment was set as the maximum between USD\$500 per MWh and the wholesale electricity price in the customer’s area. In general, these programs levy penalties when customers did not comply with the load reduction call.

Residential customers enrolled in the SMUD Peak Corp program received capacity and utilization payments. These payments are given in the form of bill discounts. The amount of the capacity payment varies between USD \$10-20 per season considering the time range allowed (0-60 min per hour) for cycling the air conditioner. The utilization payment is not related to the actual load reduction but, to the frequency the air conditioner was cycled (in days/season). This bill saving fluctuates between USD \$1-3 per day the air conditioner was cycled.

- *Non-monetary incentives:* As a common practice, non-monetary incentives are given in DR programs to motivate customers to participate. ‘In-kind’ incentives such as the energy management system (e.g. in-home energy display, energy management box), their installation and maintenance costs, and smart appliances are given free of charge or at a considerable discount. This is in line with (Prügler, 2013) who observes a low willingness to pay from the customer side concerning the cost of the energy management system.

The Toronto Hydro Electric Utility Peaksaver PLUS and PowerShift programs¹⁶, for example, apply non-monetary incentives in combination with tariff information (Toronto Hydro, 2013a, Toronto Hydro, 2013b). The ‘in-kind’ incentive is given as an in-home energy display with maintenance and installation free of charge. This type of incentives are also implemented in projects like ETHOS in Wales (UK), LIPAEdege in NY (US), PEF DLC in Florida (US), SMUD Peak Corp in Sacramento (US) (Crossley, 2008; LIPAEdege, 2013; PEF; 2003).

There are also cases in which smart appliances are given to participants of a DR program as ‘in-kind’ incentives. These smart appliances cover a wide range. For example, customers enrolled in PSE&G program ‘myPower’ are given free programmable thermostats which are used to adjust the air conditioner settings (Faruqui, 2008). In the Grid Friendly project, participants were offered a dryer as their principal participation incentive (Hammerstrom, 2007b). Also in case of the ADEME project all equipment installed on the customer side of the electricity meter (i.e. an energy management system and smart appliances) was owned by the customers (ADEME, 2002).

- *Combination of different options:* The combination of monetary and non-monetary incentives is often observed in DR programs. As an example, participants to the French field trial of the ADDRESS project received payments in the form of vouchers consisting of a fixed and variable amount. The former was given to remunerate their participation, while the latter payment was

¹⁴ As defined in (Crossley, 2008) “Enrolling Participants can be a local distribution company, Demand Response Provider or a competitive supplier. Demand Response Providers are companies that provide technology and services to help customers participate in the demand response programs”.

¹⁵ Large industrial consumers are also eligible.

¹⁶ These are DLC programs that control household appliances such as the central air conditioner, electric water heater and/or pool pump.

made to compensate the actual response of consumers facing an Active Demand (AD) request. That is, each time the Energy box (EBox) adapted the consumption of at least one piece of equipment (e.g. smart washing machines, appliances connected through smart plugs or wall units, thermostats) during the AD request. The equipment were facilitated by the project to the end-user¹⁷ (Belhomme, 2013; ADDRESS, 2011b).

Moreover, incentives and dynamic tariffs can also be combined within a project. The Olympic peninsula Project offered applicants 1) the use of project equipment for the management and monitoring of their home water and space heating and 2) a total of \$150, on average, cash earnings, more or less, depending on the occupants' responses to the price signals provided to them by the project (Hammerstrom, 2007a).

3.1.1.4 End-user perception

According to (DOE, 2006), end-users take into account following factors before enrolling in a DR program:

- Incentives offered (type and level)
- Requirements and conditions of the program
- Its own assessment of risk and benefits
- Design and implementation of the program

Participants that actually adjust their consumption pattern within a DR program do so primarily because they want to obtain financial benefits (DOE, 2006; Prügler, 2013). A secondary reason may be related to reliability. The former has to do with cost savings and extra payments received from taking action, while the latter concerns system reliability (internalizing the costs of an event with greater consequences, e.g. a blackout).

Braithwait (2006) argues that historically utilities have overpaid DR programs specially the classical ones. This is because "their relationships with customers are happier when customers are overpaid rather than when customers are underpaid".

It has been observed from consumers' surveys that consumers hardly accept losses in comfort, their willingness to pay for an energy management system does not exceed 4 €/Month, and their participation is mainly driven by expected costs savings (Prügler, 2013). Results from LIPAEedge program showed that in order to motivate costumers' participation they have to be given a certain level of control concerning their appaels, for example the possibility to override curtailment events (Crossley, 2008).

Project results from Smart-A (2008) show that, on the one hand, a financial reward for each smart operation cycle is viewed positively and would also motivate consumers to use smart operation, but on the other that respondents do not have a clear idea of how high this amount should be. Findings thus suggest that information about energy and money savings should be part of the energy bill. Consumers are also open to accept a general cheaper tariff, instead of a reward for each smart cycle. Another model would be that the consumer gets a premium if they buy a smart appliance. But for these scenarios the motivation to use smart operation for each cycle will be lower.

3.1.2 Price-based programs and tariff structures

Price incentives in general aim to achieve a shift and/or a decrease in overall energy consumption. When these incentives vary according to time (e.g. hour of the day, season, critical peak periods), it is called time-dependent or dynamic pricing (Breukers & Mourik, 2013). Nowadays, the energy contracts of most households and SMEs are not related to the time of day (except for day and night tariffs) or the overall level of consumption (EEA, 2013). The current pricing schemes thus fail to stimulate behavioural change in energy consumption. The introduction of smart meters creates the opportunity to introduce dynamic pricing more widely. Dynamic pricing better reflects the underlining cost of electricity and consequently encourages customers to shift consumption away from peak consumption periods to lower consumption periods, lowering distribution and energy costs (Stromback et al., 2011). In addition to managing demand flexibility, dynamic pricing can also help to reduce the overall energy demand by making consumers more aware of their energy consumption and accompanying costs (Dütschke, 2013).

¹⁷ For example, Smart washing machines were provided by Electrolux.

3.1.2.1 Types of tariff structures

The basic idea behind dynamic pricing is that the energy price varies either by time of use and/or by the current load at household level (Dütschke, 2013). Most tariff structures can be classified in the following subcategories: Time-Of-Use pricing (TOU), Critical Consumption Pricing (CCP) which includes Critical Peak Pricing (CPP) and Critical Peak Rebate (CPR), Dynamic rate or Real-Time Pricing (RTP) and Consumption-based tariffs (e.g. Progressive Block Pricing (PBP), Inclining Block Rates (IBR)). Different definitions can be found for each of these categories, but some of the main characteristics are (Stromback et al., 2011; DOE, 2006; Dupont, 2011; EEA, 2013; DECC, 2012; Dütschke, 2013; Breukers & Mourik, 2013):

- *Time-Of-Use (TOU)* tariffs divide the day into different time blocks to which different electricity prices apply. Many different set-ups exist, but typically these prices are fixed for a specific period (e.g. a month, week) and thus reflect average cost of energy over the whole period during the specific time block. Mostly two (peak and off-peak) to three (peak, partial peak and off-peak) levels of prices are applied per day, but more complex (i.e. more level of prices) arrangements are also possible. Prices may also vary according to season.

In the ‘simple’ TOU¹⁸ the price spread is (usually) relatively low (around 0.10 €/kWh). The ‘complex’ TOU¹⁹ tends to have a higher price spread than its “simple” version. In addition, these ‘complex’ arrangements tend to be fixed for a shorter time period (rather weekly or daily than monthly). The aim of implementing these tariffs is to encourage consumers to reduce demand day-in and day-out during regular peak periods. More explicitly, the implementation of these tariffs intend to improve the base load by reducing peak load or consumption valleys. Additionally, they seek at fostering the adoption of electricity generation coming from Renewable Energy Sources (RES), e.g. cheap kWh at noon when the photovoltaic plants feed in most.

- *Critical Consumption Pricing (CCP)* tariffs are designed to reduce critical peak demand, or to stimulate electricity consumption at times when electricity is abundantly available (e.g. high solar influx, windy conditions). These tariffs include:
 - *Critical Peak Pricing (CPP)*, which adds a critical peak component to the electricity price under certain conditions, e. g. if system reliability is compromised. In many cases a lower tariff is applied to non-peak hours (compared to fixed tariffs) to compensate the consumers.
 - *Critical Peak Rebate (CPR)* pricing schemes that are inverse forms of CPP tariffs. Participants are paid for the amounts that they reduce consumption below their predicted consumption levels during critical peak hours.

CCP is usually employed as an extension to a simple TOU tariff. Within these tariffs bonus/malus events could be included. Bonus events with Critical Peak Rebates take place when there is a surplus of energy, e.g. excess energy coming from wind farms due to an increase of their resource (wind). Malus events usually happen when electricity consumption is high and generation resources are scarce so that Critical Peak Pricing is needed (Agsten, 2012). For both tariffs, CPP and CPR, the number and length of the critical events is often agreed upon in advance. However, the exact moments when critical peaks occur cannot be set in advance as these depend on market and weather conditions. Critical peak periods tend to occur during the usual peak periods on week days and notifications are typically sent the day before. Overall, CCP tariffs aim at reducing load peaks and valleys at critical times.

- *Dynamic rate or Real-time prices (RTP)* typically have a greater variability (usually fixed for a short time slot -15 to 60 min.) since prices fluctuate in response to external variables, e.g. spot prices, prognoses, excess power from RES, and grid overload. To encourage consumption reduction during high price periods and reduce risk of high bills, end-users can be informed when prices reach a certain threshold. This tariff aims at inducing flexible load shifts that can help to balance production, manage grid capacity and other variables with the consumption in near- to real-time.

¹⁸ Two to three price levels or rate phases.

¹⁹ Usually three to five price levels or rate phases.

- *Consumption-based tariffs (e.g. PBP and IBR)* aim towards energy saving and a general load reduction by offering block-wise increasing rates. In addition, it renders the forecast of consumption at certain points in the grid more accurate. The rationale behind these tariffs is that prices increase step-wise as consumption increases - so the more one consumes, the higher the price per unit. A program can include several thresholds with increasing penalties and/or the exact threshold may vary²⁰.

Several combinations or variations are also possible, e.g. TOU pricing is often combined with CPP or CPR pricing schemes. Along with tariff structures that stipulate the price at which energy is consumed (€/kWh), there may be energy contracts which are partly based on capacity/load (€/kW) - *capacity based pricing*. This is currently being considered for residential end-users and SMEs (Jargstorf, 2013).

3.1.2.2 Tariffs structures and demand response control

End-users enrolled in price-based programs and thus subject to a given tariff structure may respond to price signals in a manual or automated way. Their decision of what approach to take heavily relies on the tariff structure. Figure 20 displays the suitability of the different tariff structures for manual control with feedback, or automatic control by the energy managers. Note that as the underlying price signal updates more frequently (as a reflection of the current situation of the power system) automatic control becomes a better fit as it allows the end-user to take full advantage of the tariff structure.

In addition, Figure 20 shows the trade-off between increasing risk and benefits for end-users with respect to each tariff structure.

3.1.2.3 End-user response and perception

Most studies concentrate on analysing whether dynamic pricing is effective in shifting demand and/or look at potential savings for the end-user. Figure 21 shows the average load shifting percentage during peak priced hours and the saving potential of different tariff schemes (TOU, CPP, CPR and RTP), according to Stromback et al. (2011). A distinction is made between pilots with and without automated demand response (ADR). Overall TOU consumption reductions are the lowest, followed by RTP and CPR while CPR produces the highest reductions. It should of course be noted that TOU and RTP reduction change every day while CPP and CPR occur only during critical peak periods. According to Stromback et al. (2011), every scheme led to lower electricity bills over the duration of the pilot. Participants to RTP trials saved the most (on average 13% on their electricity bill²¹), while the other schemes led to moderate saving potentials between 3 to 6%. Yet, CPP led to the largest amount of peak clipping, from 16% (no automation) up to 31% (with automation).

The DECC demand response study (DECC, 2012) reports peak period demand reduction up to 22%²² for TOU tariffs, between 5-38% for CPP tariffs and between 6-21% for CPR tariffs.

In (Breukers & Mourik, 2013), peak reductions up to 12 % for TOU pricing pilots are mentioned; Moreover this study states that CPP is often the winner over other pricing mechanisms in terms of reduction and shifting potential, but this should be placed in perspective since CPP only is accomplishing this during the peak days (with the number of peak days varying from 1 to 18 per year) while TOU schemes are at work seven days a week. TOU in combination with CPP can achieve a load shifting up to 30% (for a limited number of days and hours per year) and supplemented with load control this percentage has in cases (outside of Europe) risen to 50% (Breukers & Mourik, 2013).

²⁰ For example, if the end-user succeeds to stay below a given threshold (e.g. 90% of their consumption) within a specified period (e.g. a month, week, day). Each kWh would cost an "x" amount (e.g. 5cts) less than if they don't succeed (i.e. stay below the threshold). This tariff requires that the "normal", pre-intervention consumption of the customers is metered individually a certain period in advance (e.g. for a couple of months) in order to define the individual threshold values for the customers.

²¹ According to Stromback et al. (2011), some of the pilots took place during periods with low wholesale prices and were compared to the historical bill of the consumers so these numbers might be artificially high.

²² Three out of 15 studies reported no reduction in peak period energy use for consumers on TOU tariffs.

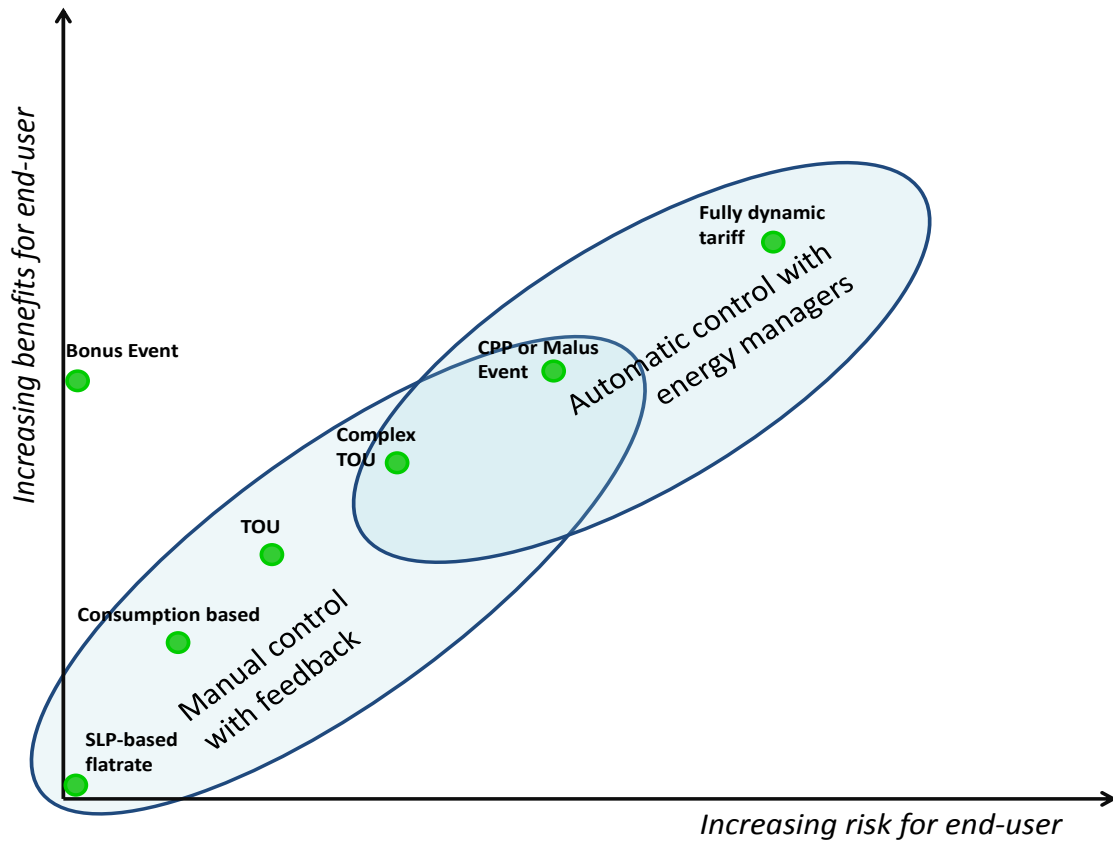

Figure 20: Manual and Automatic Demand Response. Source: (Faruqui, 2011) with additional insights from the E-Energy projects²³.

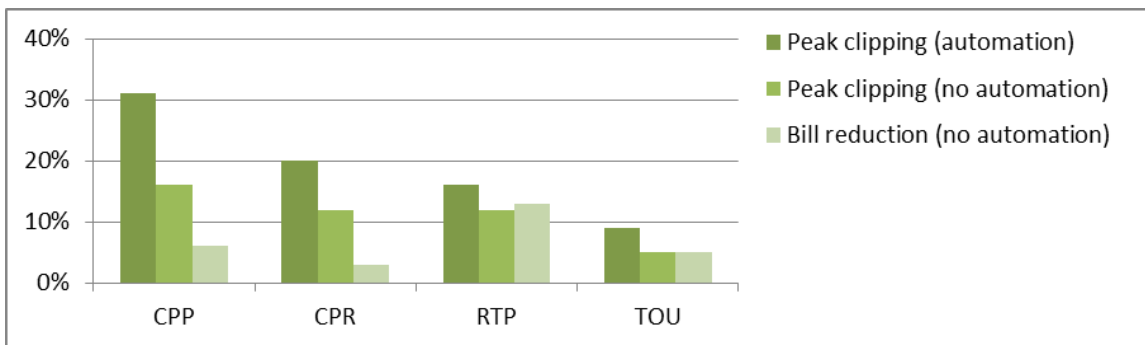

Figure 21: Dynamic pricing's potential for peak clipping and financial savings²⁴ (Stromback et al., 2011)

To better analyse end-user perceptions towards the different pricing schemes, Table 3 summarizes some of the key attributes on the basis of which dynamic pricing schemes can be characterized. For each attribute, some key lessons extracted from current experiences and available literature are presented below. These lessons can be thought of as a starting basis to compare different approaches, and to further develop tools and guidelines for designing tariffs.

²³ The 'Fully Dynamic Tariff' corresponds to the Dynamic rate or Real-time prices (RTP) in our classification of Section 3.1.2.1 "Types of tariff structures".

²⁴ Sample sizes are respectively 69 (CPP), 16 (CPR), 15 (RTP) 215 (TOU) for the peak clipping potential and 5 (CPP), 6 (CPR), 7 (RTP) 13 (TOU) for financial savings.

Table 3: Potential attributes of dynamic pricing schemes (Dütschke, 2013; Breukers & Mourik, 2013)

Attribute	Description
Load management options / rationale of scheme	Different load management options (i.e. the way in which loads can be managed) can be achieved via different tariff constructions depending on the rationale of the dynamic pricing scheme. These include peak clipping, strategic conservation, valley filling, strategic load growth, load shifting, flexible load shape (see Figure 22).
Number of time blocks	The number of predefined price zones (rate phases) per day in which the energy price can vary [Number/day].
Price update frequency	How often are prices updated [Number/unit time].
Peak periods	Duration of peak period [unit time]. Average occurrence of peak periods [number/unit time].
Rates and rebates	The rate can depend on time of use or on the load level (via block rates) or a combination of both. Moreover, a distinction can be made according to the rates applied [energy based €/kWh – capacity based €/kW/unit time – fixed component €/unit time]. Also rebates in the form of CPR pricing schemes fall within this category [€/kWh].
Price spread	Price differentials between time blocks or between peak and off-peak hours [€/kWh].
Dynamic price components	Different components can be made dynamic: the energy component for the suppliers, distribution fee for the DSO, transmission fee for the TSO, etc.
Demand response	The consumer can react manually to dynamic tariffs or automated control can be applied in function of the tariffs.

- *Load management options / rationale of scheme*: Figure 22 looks at ‘load management’ options from a supplier, DSO or TSO point of view, summarizing the ways in which load may be managed linked to the purpose (from matching renewable production to reducing peak demand) which can be achieved via dynamic tariffs. Table 4 indicates the most appropriate tariff types to achieve these load management options.
- *Number of time blocks*: According to Faruqui (2009), dynamic pricing rates should be easy for the customer to understand. If the customer does not understand how the pricing works, or is overburdened with information, then he or she will not be able to appropriately respond to the price signals and shift load. Following this simple requirement, each day should be divided into a limited number of time blocks when designing a dynamic tariff. This requirement is, however, in contrast with some of the consumer preferences discussed below, e.g. giving strong price signals. A constant weighting of the different attributes will thus be needed when designing a tariff.
- *Price update frequency*: As reported by Dütschke (2013), survey results showed that consumers were more likely to enrol in static pricing programs where prices are fixed for a longer period like TOU compared to more dynamic/fluctuating tariffs as RTP, whereas the field experiment revealed that consumers preferred the RTP instead of the TOU after being subject to different schemes during a test period. In (Breukers & Mourik, 2013) it is also stated that the responsiveness of participants increases when the change in tariff is announced timely (e.g. a day rather than an hour in advance).

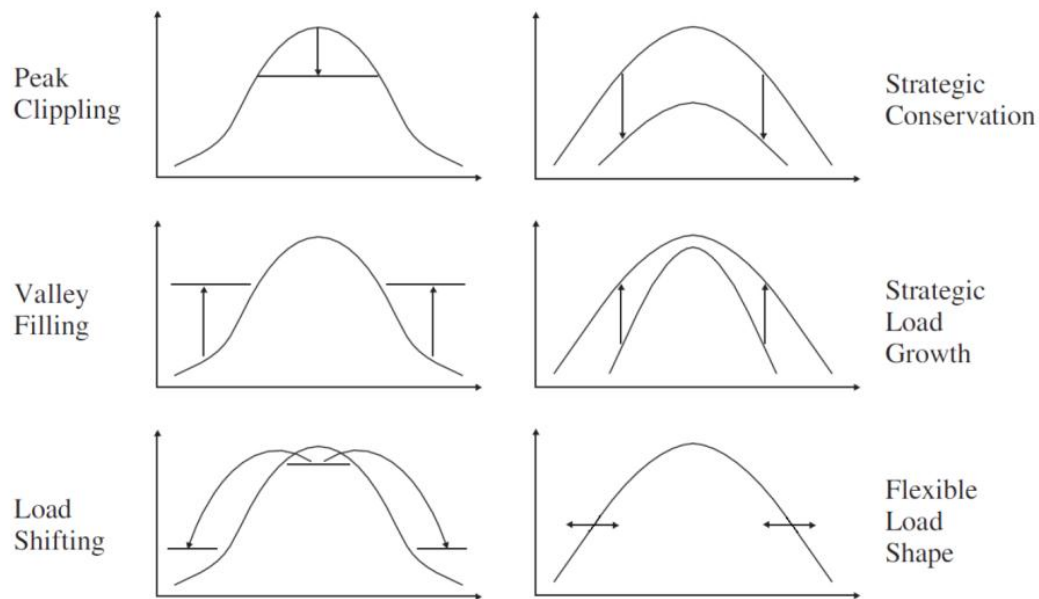

Figure 22: Load management options (Breukers & Mourik, 2013)

Table 4: Load management options linked to tariff types (adapted from Breukers & Mourik, 2013)

Management options	Appropriate pricing mechanism
Peak clipping	CPP, CPR potentially with TOU
Valley Filling	TOU, RTP, and to a lesser extent CPP, CPR
Load Shifting	TOU most effective, in combination with CPP, CPR
Strategic Conservation	In principle dynamic pricing is not the first option to achieve strategic conservation. In this case, tailored tips, tricks, installation of energy efficient appliances and changing of routine behaviour might be better suited.
Strategic Load Growth	RTP or a new version of CPP is the best option to encourage temporary load growth
Flexible Load Shape	RTP, CPP, CPR

- Peak period:* According to Dütschke (2013), uncertainty about when critical peak periods occur seems to be a hampering factor to participate in a CPP program. Participants that do decide to participate in CPP or CPR pricing schemes seem to be unwilling to delay household consumption when peak periods are too long (Stromback et al., 2011; DECC, 2012; Breukers & Mourik, 2013). Faruqi (2009) mentions that a shorter peak period makes it easier for customers to shift load to the off-peak period when demand reductions are not as critical. This also relates to the previously mentioned factor, as with longer peak periods price differentials will be smaller.
- Rates and rebates:* The load shifting and saving potential of TOU, CPP, CPR and RTP was already discussed above. Regarding IBR pricing, the field experiment from Dütschke (2013) showed no effect on individual consumption by applying block rates, but since this is the least common scheme it is difficult to make general statements. One of the main reasons that was given was the fact that participants refused to stay below the limits because they felt it would constrain their lifestyle (mainly consumption with entertainment and comfort functions).

Participants to CPR pricing schemes usually receive a payment after each critical peak period or see their electricity bills lowered by the same amount. According to Stromback et al. (2011), these programs tend to be more acceptable to the public and to regulators alike as consumers can only benefit from participation. Once enrolled in such a program, the potential for peak clipping is higher in the case of CPP compared to CPR schemes (see Figure 21). The comparison across trials from DECC (2012) also showed that load shifting was higher for CPP compared to CPR tariffs. They indicated as a potential driving factor that consumers may find rebates more difficult to understand than higher prices, since rebates are calculated relative to a consumer's reference demand which makes it difficult for consumers to estimate the savings they make from shifting demand away from the peak. Moreover consumers may be loss averse. They may care more about the additional costs that they incur with CPP tariffs than about the additional gains they may make with CPR tariffs.

- *Price spread:* In order to give a strong price signal to customers, the differential between the peak and off-peak prices should be large according to Faruqui (2009). Customers react mainly to changes in price rather than to the actual price of electricity, so larger price differentials between peak and off-peak periods tend to lead to more load being shifted away from high priced to lower priced periods (Stromback et al., 2011).

A comparison across trials in (DECC, 2012) confirms this statement, but also reveals that the size of the difference between peak and off-peak prices cannot fully explain the variation in the size of the consumer response across studies so other influencing factors should be identified. The analysis of Faruqui and Palmer (2012) also shows that an “arc of price responsiveness” emerges from their analysis, showing that the amount of demand response rises with the peak to off peak price ratio but at a decreasing rate. Moreover, they indicated that about half of the variation in demand response can be explained by variations in the price ratio.

Field test results from Dütschke (2013) also showed a preference for higher price spreads focusing more on the chance to save money as long as there was a cap on the highest price zone, but the survey results however indicate that consumers are more willing to participate in programs with smaller spreads and thus minimizing their financial risk.

These findings of course don't need to be contradictory. In general, consumers that aren't enrolled in a dynamic pricing scheme yet might be risk averse and prefer a low spread, while consumers that are subject to dynamic tariffs with larger spreads have more incentives to shift consumptions and thus exhibit stronger reactions to price signals.

- *Dynamic price components:* According to Faruqui (2009), rates should better reflect system costs, i.e. the rate should reflect the cost of providing power to the end-user. Following this rationale, not only the energy component should be made dynamic, but also the other components like the distribution fee for the DSO could change in time or based on capacity/load. To the authors' knowledge, no meta-reviews were available which made this distinction when discussing consumer perception.
- *Demand response:* Research indicates that consumers are not keen on changing daily routines. They seem to be more in favour of automated demand response (Dütschke, 2013). In (Dong Energy, 2012) it is also stated that it cannot be expected from consumers to be continually monitoring a price signal manually (or any other signal) and react accordingly thus some kind of automation is needed. There thus appears to be considerable potential for deploying enabling technologies to foster greater price response, perhaps surpassing what can be achieved by complex pricing plans (EPRI, 2007). This is also backed by the results from Figure 21 which shows that applying automated control to smart appliances that can react to outside information leads to considerably higher responses of consumers (Stromback et al., 2011) and cost savings (Dütschke, 2013). Also Faruqui and Palmer (2012) find that for a given price ratio, experiments with enabling technologies tend to produce larger peak reductions, and display more price-responsiveness.

Besides the attributes of dynamic pricing schemes described above, the response of end-users to dynamic tariffs are impacted by many other factors like cultural, regional, social and financial ones. In an evaluation of a price-based DR program²⁵, for example, it was found that lack of knowledge,

²⁵ Based on a consumer's perception survey in Sweden on demand-based time-of-use (TOU) electricity distribution tariff.

misconceptions and loss of control are some of the reasons why electricity users may be reluctant to accept changes (Bartusch, 2011). Moreover, individual and societal advantages of dynamic pricing programs are very often not obvious to consumers (Dütschke, 2013). For this reason, the introduction of dynamic pricing needs to be accompanied by convincing feedback mechanisms, complemented with communication and engagement strategies (described in the following sections), to ensure that these advantages are well perceived.

3.1.3 Concluding remarks on tariff structures and incentives

One important lesson when looking at the different tariff structures and incentives is that all consumers are different and act based on a wide variety of reasons and values (Dong Energy, 2012).

Breukers & Mourik (2013) identified several reasons why it's important to let go of the 'one-size-fits-all' approach when aiming at energy consumption reduction or shifting:

- The 'one-size-fits-all' usually starts from the premises that people are mainly economically motivated to participate. However, people are not necessarily motivated by financial gains only, but can also have other motivations that relate to environmental goals, health, comfort, etc.
- Approaches that target individual behaviour only - without addressing the social and physical environment - have not been very successful in achieving lasting behavioural changes. In the case of dynamic pricing, attention for the characteristics of the house, the appliances, as well as the social processes within a household are relevant to take account of.
- The risk of rebound during or after the pilot is larger if individuals are targeted with financial incentives only.
- Studies show that often a small percentage of the participants are responsible for the response, while it remains unclear why and how they responded and why the rest did not. On average 30% of households were responsible for 80% of the load shifting.

All these reasons indicate that a variety of tailored interventions are needed to address different user segments, which might be an important research topic for S3C. Understanding what motivates behavioural changes (both intentional and routine behaviours) and consequently the responsiveness of households to pricing signals, the potential flexibility of certain loads in households, and how such changes can be made durable is important when designing effective incentive and tariff schemes (Breukers & Mourik, 2013). Moreover, voluntary participation is also mentioned as an important factor to motivate consumers which should be considered when proposing these new schemes (Breukers & Mourik, 2013).

3.2 End-user feedback

End-user feedback comprises the information supplied to end-users concerning energy consumption – a crucial and central mechanism in the interaction between the participant and the smart meter. Feedback forms the bridge between the smart grid technology and the behaviour of end-users. In describing feedback, we distinguish two commonly used categories²⁶. The first category 'feedback channels and devices' describes the channels and devices by which the end-users are informed about their energy consumption; the second category 'feedback information' describes the content of the information supplied.

3.2.1 Feedback channels and devices

This category refers to the feedback channels and devices through which end-users receive information on consumption, such as in house display devices, online information systems and informative billing.

Feedback channels may include (see Stromback et al., 2011, which did not include the Smartphone Apps included in this overview):

- *In House Displays (IHD)* can provide a variety of feedback information. The display is usually located at a central point in a home.

²⁶ This distinction is useful as many people confuse the feedback information provided by smart meters with devices such as in-home displays (IHD's) (Krishnamurti et al., 2012). But it is imperative to see the different effects of the devices and type of information, as to be able to effectively communicate about them.

- *Ambient displays* do not provide specific consumption information but rather signal messages to the end-user about their general level of consumption and/or a change in electricity prices (e.g. light bulbs glowing in different colours to indicate actual energy consumption).
- *Informative billing* refers to informing end-users of their energy costs and consumption by paper, preferably by supplying additional information such as comparison data or visualizing graphics.
- *Online tools* providing feedback on energy use and costs. These instruments (e.g. a website containing a virtual dashboard or e-mails with infographics) are relatively easy and cheap information channels. End-users can have the possibility to adjust appliances in their home. As PC's, Smartphones and tablet's gain importance in Western society, providing online information through these channels are becoming more and more important and convenient.
- *Smartphone apps*. As technology embeds in society, so do the options of providing information on energy related topics through Smartphones. With Smartphone Apps, end-users have the possibility to adjust appliances in their home with their Smartphone, and receive feedback information on energy topics as well. As Smartphones are (becoming) an integrated part of society and are used more and more as feedback channels, we find it important to mention them separately.

Below are some findings of meta-reviews on the different feedback channels and devices:

3.2.1.1 Effectiveness of the different feedback devices in energy saving

The study of VaasaETT (Stromback et al., 2011) shows that both informative billing and IHD's are effective in reducing overall electricity consumption. They find that in comparison to the other feedback channels, IHD resulted in the highest energy savings. Webpage and informative billing produced comparable consumption reductions (in some cases they were used in combination). Whereas Vassileva et al. (2012) conclude that web-based feedback is the most effective compared to IHD's and bills. They found electricity savings of approximately 15% within households who visited the website. Faruqui et al. (2010) find in a meta-analysis of the impacts of in-home energy displays (IHD's) mean savings of 7%, with a range from 3% to 13%.

As there is a variety of savings found in different meta-reviews, Lewis et al. (2012) state that the purposes of the different feedback channels are broader than energy savings alone. For example:

- In home displays provide feedback to the entire family;
- Fully ambient displays provide less feedback information, but can be excellent ways of, for instance, gently informing (through push feedback) family members of critical peak pricing or high usage periods while minimal involvement is required on the part of family members; they can also be seen as aesthetically desirable elements of a feedback and control environment;
- Phone communication provides the opportunity to deliver advice, support and warnings to customers at any time, regardless of where they are;
- Energy usage statements and smart bills can aggregate larger amounts of information to provide consumers with excellent explanations for their bills, at the time they are most keen to receive such explanations. PowerCentsDC (EMeter Strategic Consulting, 2010), for instance, found that 42% of users in the post-pilot survey stated that they had changed their consumption significantly because of the usage reports.
- Online feedback via tablets or computers can provide a low cost alternative to in home displays for consumers wanting to know how much they are consuming and how much it is going to cost, while there is still time to do something about that cost before the next bill arrives;
- Fridge magnets can be an excellent, well used and popular quick reference guide for consumers wishing for instance to know when the next higher price period will be as part of a time of use pricing scheme. For instance, in the Irish trials of CER (2011), 75% of the respondent participants stated that fridge magnets were useful to them in practice.

3.2.1.2 Specific lessons for IHD's

The functioning of IHD's has received relatively much attention. Lewis et al. (2012), for example, conclude:

“In particular in-home displays are such an important part of the entire customer education process that they cannot be taken out of the equation. They form a germinating hub of intrigue, exploration and awareness for the customer. The importance of ambience, ease of use, real-time feedback and aesthetic appeal related to in-home displays cannot be underestimated however.”

Moreover, the study of Stromback et al. (2011) indicates that longer lasting IHD pilots seem to yield better results than pilots lasting for half a year and less. A possible explanation for this could be that the longer the pilot went on, the easier it was for participants to notice a trend in energy consumption and directly link their action to their energy usage which might motivate them to continue or increase their energy saving activities.

Persistency of the effects of interventions seems strongly correlated to the length of the duration of a trial and the amount of information available to the customer. Also, regular reminders seem to contribute to habit-formation (Henryson et al., 2000). So, IHD's (and possibly other feedback devices) can play an important role in sustaining intervention effects and habit-formation by providing such regular reminders.

Gorsira et al. (2011), finally, found interesting results on buying and actual usage of IHD's. As the study showed, people want to purchase IHD's with extended, multiple options of control mechanisms. But once in use, people do not use all the options. Moreover, it was found that with the simpler control options, more energy was saved. These findings show that - although the more simple semi- and fully automated IHD's are more functional - consumers do not prefer such IHD's when making a purchasing decision.

3.2.1.3 Conclusion

Feedback systems are effective in influencing end-user's behaviour in saving energy, even though the effectiveness of IHD's, on-line tools and informative billing might vary. The information provided by the feedback device leads to knowledge which enables the end-users to (re)act and be effective. The conclusions of meta-reviews do not contain a balanced view on the various appliances. More conclusions and recommendations can be found on IHD's than e.g. the use of a Smartphone App or for ambient displays. Also the effect of devices on load shifting and its effectiveness for demand side management has been insufficiently addressed. Knowledge about the influence of the design of the feedback devices on energy use behaviour is therefore limited, as Dam (2009) also finds in her review on Home Energy Management Systems). It is clear, however, that the potential of feedback devices may depend on a variety of factors including “aesthetics, ergonomics, clarity, ambience, coolness, intuitiveness” (Lewis et al., 2012). Another insight is that mixed feedback channels are probably best suited to address a heterogeneous end-user population. As formulated by Lewis et al (2012):

“While in home displays are typically the most effective form of feedback, leaflets done well can in some cases prove to be even more effective. Furthermore, different consumers will prefer different channels, be they paper based, electronically via a computer, phone or tablet, via a home display or some other means. Nor should it be forgotten that different feedback channels have different purposes. Empower Demand 1 (Stromback et al., 2011) researched a wide variety of types of feedback channel and content, but typically, successful programmes put many of the above forms of feedback together in one programme, in one offering to the consumer. Comprehensive simplicity is the name of the game. This breadth of coverage additionally assists in making the overall offerings more appropriate to different segments of customers.”

3.2.2 Feedback information

Feedback information comprises the translation of end-user consumption data read from the smart meter into information which enable end-users to influence and control their energy consumption patterns. Feedback information deals with *what* is presented to the end-users.

The amount and type of feedback information is extensive. One way to classify types of feedback information was proposed by Lewis et al. (2012), who rank the type of feedback information “in terms of perceived influence on behaviour” (see Table 5). So the higher the rank, the more effective the type of information is expected to influence behaviour.

Table 5: Types of feedback information ranked in terms of perceived influence on behaviour (Lewis et al., 2012)

1. Relativity to other comparable consumers or households (social comparison)
2. Energy consumption ratings
3. Relativity to other targets (e.g. own targets)
4. Hints and tips (energy efficiency, saving money)
5. Cost and consumption by appliance (including also according to different tariff options; time of use; critical peak versus off peak; etc.)
6. Bill Predictions (what will my bill be?)
7. Cost per hour (or some other period)
8. Projects with competitions and energy challenges
9. Usage predictions
10. Unusual Usage Alerts: Alerts (SMS or Email) warning of a high electricity bill along with tips for how to avoid (e.g. as applied by Opower)
11. Historical consumption (across different periods of time), including also relativity to historical averages
12. Current usage rate (kWh)
13. Unit cost of electricity (including also time of use and critical peak where appropriate)
14. Impact on the environment
15. Total consumption to-date, today, etc.
16. Additional information (including also where the consumer can find more information through other channels)

A key conclusion concerning feedback information comes from Lewis et al. (2012):

“Feedback should be personalised (requiring substantial understanding of the customer), evolving in nature, supported by tips and advice (and wherever possible also solutions), not based on kWh, available in both ambient and more direct form, and available real-time, but ultimately delivered by request, both in its timing, content, quantity and style. The research found evidence to indicate that feedback, done well, leads to year-on-year increases in savings and increased interest and participation in other programmes.”

This general conclusion is supported and further specified by several other researchers. Below, several findings are summarized.

3.2.2.1 Interactive and disaggregated feedback

According to the literature review and conclusions from Fischer (2008), the type of feedback that would generate action on behalf of the consumer would typically provide multiple options for the user to choose from, have an interactive element, are given regularly, give a detailed breakdown of power usage per appliance and comparison to previous periods or other benchmarks, such as reference groups. Also

Ehrhardt-Martinez (2010) and Darby (2006) found feedback to be more effective if detailed to the appliance level.

3.2.2.2 Feedback with advice on appropriate actions

Darby (2010) reviewed various tests in which consumers potentially had access to information, but did not know what to do with it. In House Displays, for example, might show the actual consumption and extrapolated cost, but not give any indications of what specific actions to undertake to lower consumption. Darby studied the way consumption feedback, with and without smart meters, impacted the energy consumption. She concluded that little evidence exists to uphold the claim that Advanced Metering Infrastructure (AMI) on its own brings about reductions in consumption. It is the feedback, depending on its form and context, which might change behaviour. This is backed by Ehrhardt-Martinez (2010), who also finds in her study that weekly feedback plus advice seems to generate more behavioural change and savings than continuous real time feedback through a monitor only. Darby argues that not only technology or economic incentives should be considered as drivers of consumer engagement, but also end-user perception and practices. AMI could thus be useful as a technology that facilitates home energy management and customer-utility relations. However, consumer perception and practices determine what interface, feedback, message and support will be most effective for influencing specific segments of consumers. For AMI to be effective, Darby concludes that customer interfaces should be designed that facilitate understanding, and that consumers should be guided towards appropriate action through frequent and clear instructions.

3.2.2.3 Direct & indirect feedback findings

Darby (2010) finds that direct feedback has on average a higher impact than indirect feedback. Providing direct feedback by in-home displays that gives real-time and historic usage feedback information, leads to a permanent energy reduction of 5%-15%; end-users changed their habits and invested in energy-efficiency measures. Savings from indirect feedback (information that has been processed before reaching the consumer, usually via billing) are up to 10%. Darby also concluded that comparison with own historic use seems more effective than comparison with other households or objectives. This is somewhat contradictory to research findings from Lewis et al. (2012), indicating that social comparison feedback is one of the most important feedback motivators for end-users (see Table 5).

3.2.2.4 Social feedback

Several pilots and studies show that social feedback is an effective driver for behavioural change. Staats et al. (2004) eco-teams achieved 8% reduction and British Gas' Green Streets competition achieved 25% reduction (albeit with a prize of BP 50,000 as an incentive for the winning street). Another experiment by Black et al., (2009) with eco-meters and social marketing (targeted strategies to ameliorate barriers or maximize benefits associated with reduced electricity or gas consumption) resulted in a 22% reduction in consumption. Erhart-Martinez (2010) finds that 'Motivational elements', such as goal setting, competitions and social comparisons can significantly influence behaviour and generate significant additional savings. On the other hand, a study from Ayres et al. (2009) shows that utility-based pilot programs with comparative energy use mailings or bill inserts have households' energy savings of only 2% on average, which might mean that specific comparison with certain reference groups might cause for the shift in behaviour, compared to non-specific reference groups.

3.2.2.5 Conclusions

As more and more reviews contain new insights on several aspects of the interaction between the technique of 'Smart feedback' and energy behaviour, it is starting to become clear that variety in feedback information and channels is essential to get end-users on board. In the words of Lewis et al. (2012); feedback should further be personalised, evolving in nature, supported by tips and advice, not based on kWh, available in both ambient and more direct form, and available real-time, but ultimately delivered by request, both in its timing, content, quantity and style.

Highlighting the need to combine elements, Figure 23 below gives an overview of 'building blocks' that are vital for utilities when constructing future demand response programs. These findings are of great value to the S3C project, by providing clear building blocks for appropriate end-user engagement S3C can build further upon. As the described building blocks are important for the interaction with the end-user, the communication and engagement surrounding these building blocks when a project is rolled out, can play a vital role to 'stir' the end-user as well. The consideration of using these potential 'additional building' blocks of communication and interaction, might be a new insight on how to come up with a

more extended view on how to bring active demand to the next level. The next section will show more insights about potential effects and successes of these additional building blocks.

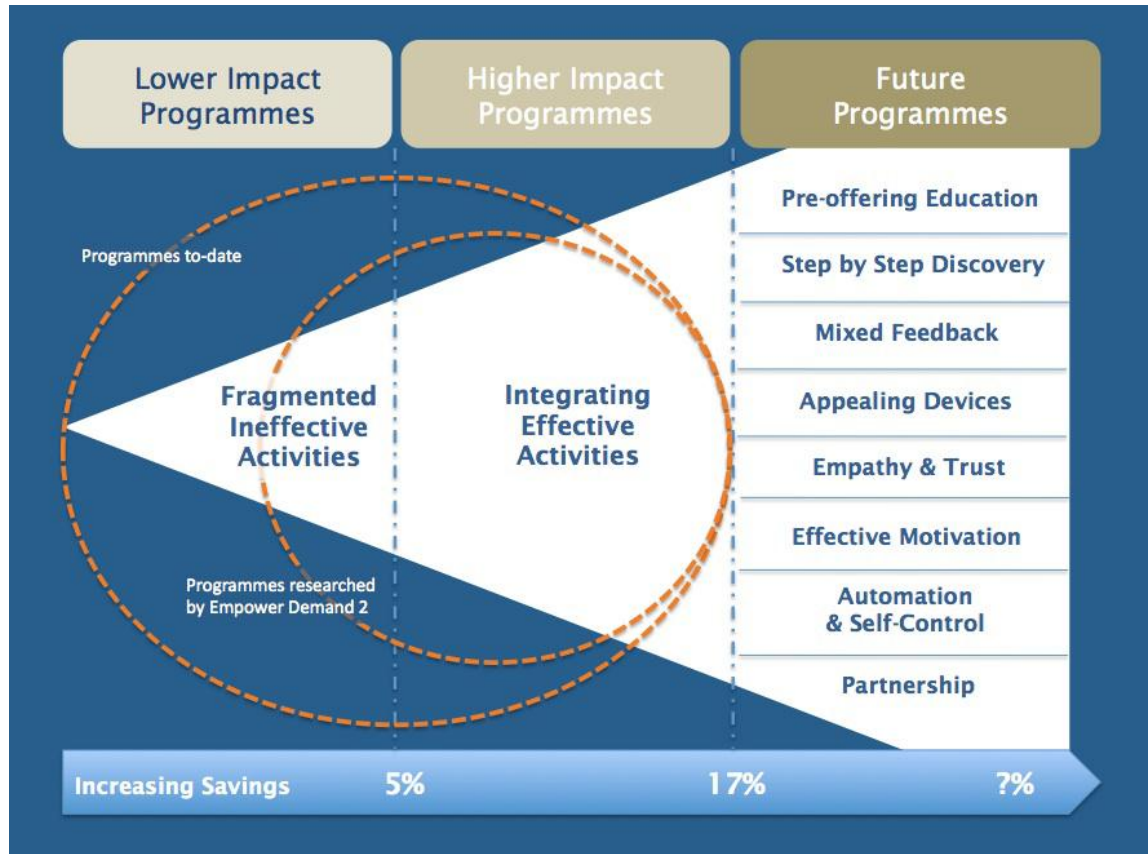

Figure 23: Building blocks for future Demand Side Management programmes (Lewis et al, 2012)

3.3 Supporting communication and engagement

Supporting communication and engagement refers to on-going communication activities of the project aiming to inform and motivate the participants and can include informing the 'outside world'. Once end-users are recruited for a project or roll out, it is vital to keep them engaged and enthusiastic if long lasting pro-environmental behaviour is to be realized. In order to generate long-term end-user interest and involvement, several communication tools and channels can be used, as described below.

3.3.1 Training end-users and installers

As discussed in several pilot reviews (Ehrhart-Martinez, 2010; Darby, 2006; Lewis et al., 2012; Dong Energy, 2012), instruction on the smart equipment will enhance the understanding of the systems and their use and will contribute to active monitoring of energy consumption by end-users and thus improving their energy efficiency. Extensive instruction may lead to a considerable reduction of demand for customer support. The amount of questions/complaints is lower when end-users received training or instructions at the time of installation. It is also a potential 'protection' against end-users inactivity, end-user complaints, and it can possibly prevent a negative attitude of end-users towards smart meters/smart grids. This approach will have many benefits compared to offering advice and guidance through websites, or on-going communication with participants throughout the project.

3.3.2 Customer service and support

Working with new instruments, feedback systems and participating in a pilot project will raise questions, complaints and general remarks from the participants. For the acceptance of new technology and the participation of the participants in the project, it is crucial to address these issues. A central point for end-users, e.g. a service centre or help desk, with the ability to listen, react and solve the issues at hand is necessary (Dong Energy, 2012). Otherwise participants will lose interest, develop a negative attitude, which leads to negative word-of-mouth of the project.

In the eFlex project (Dong Energy, 2012) such a (digital) service contact point was created on which participants discussed issues and topics together. Participants stated they valued this service very much. In fact, the findings indicate that this platform generated a feeling of community. Dong Energy also provided first line 24 hours support by a technical hotline and precisely registered all calls and complaints (see Figure 24). The utility had three project teams (total of 14 persons) with taskforces, which were all organized around customer interaction. With several communication channels in place, the preferred channel turned out to be the 'Facebook-like platform' Podio. This was used for various detailed explanations on questions concerning devices and electricity prices, and enabled extracting perceptions and user practice from the on-going debate for the report of the project. The use of this social-media channel was very insightful for the research on customers' perceptions, but maintaining interest through meaningful content and reasonable response time can be labour intensive (Dong Energy, 2012).

MONTH	2011										2012		
	MAR	APR	MAY	JUN	JUL	AUG	SEP	OCT	NOV	DEC	JAN	FEB	MAR
Phone calls	158	64	31	41	71	91	91	63	41	30	32	19	27
E-mails	16	10	10	5	2	1	13	22	9	4	8	3	0

Figure 24: Number of contacts to Technical Hotline during the eFlex project (119 customers total) (Dong Energy, 2012)

3.3.3 Communication channels

A short overview of channels which can be used for informing end-users can be found below:

Online Newsletters	For informing end-users about events, and updates on the project, preferably also based on input from participants. If input of participants is used, the likelihood of participants reading the newsletters, and getting enthusiastic might get better.
Use of internet	Online information has the potential to be completed and enhanced by interactive options for users to more thoughtfully process what they read. There's a direct connection between Web credibility and persuasion via the Web. When a site gains credibility, it also gains the power to change attitudes, and, at times, behaviours. When a website lacks credibility, it will not be effective in persuading or motivating users (Fogg et al., 2009).
Social Media	Increasing access to the Internet via PCs, laptops and mobile devices creates new channels for consumer engagement, opening up opportunities for utility companies to reach customers and interact with them in new ways about energy management, Smart Grid and Smart Grid-enabled products, and services. There are examples of utilities making use of Facebook to engage with end-users.
Telephone	Traditionally, utilities answered most customer inquiries over the phone, but the internet is getting a more important medium to get in contact with an utility (Accenture, 2010).
TV	The communication channel 'Television' is not a very much used medium in Smart Grid projects. The EcoGrid project (EcoGrid, 2013) does provide an example of this communication channel, namely showing an on-going TV show throughout the demonstration phase. Participants from the EcoGrid project will be followed when engaging with their devices and appliances, and the possible interactions with their daily lives.
Local media Newspapers	/ Keeping newspapers and local media interested is important, seeing that the participants, and their direct social surroundings might be informed and made enthusiastic or critical by this communication channel.

3.3.4 Active engagement through meetings and events

Next to the several communication channels discussed above, active engagement can be created by organizing face-to-face interaction moments. As meetings and events are much appreciated by participants, and very valuable learning moments for the project members, such active engagement moments are crucial communication moments. In the EcoGrid project (EcoGrid, 2013), for example, this communication element is taken very seriously. Besides home visits from utility installers and a training about their Smart equipment they are invited to, there will be three public events which EcoGrid organizes or is visible in, and half-year meetings with participants are organized. For the EcoGrid project, these engagement moments are expected to be valuable to learn about the specific problems and attitudes for the different topics, and might be input for adjusting certain elements of the devices or project communication strategies.

A brief overview of different ways to create active engagement can be found below:

Structural meetings	These can be used for participants to get informed about devices and the project, ask questions and meet other participants. The more informal character of these type of meetings might be especially suited for questions and discussions. Giving this opportunity in a structured manner may take away starting or growing annoyances or complaints.
Public events	Public events can be used for participants to get informed about devices and the project, ask questions and meet other participants. These events can also attract possible interested citizens who would like to keep informed about the project or perhaps even contribute to the project.
Home visits	These visits can be planned for every participant, and there should be the opportunity for questions about the devices and getting somewhat familiar with them.
Use of community based initiatives	Another example of creating engagement are the community-based programs, which engage customers through their community affiliation by creating a community-wide energy savings goal, possibly benchmarking progress against other communities (Mahone & Haley, 2011)

3.3.5 Continuous communication

To conclude, we highlight the need for continuous information. If there is no continuous information or engagement with end-users, people most likely will lose interest, and the project may not realize its full potential. Most continuous communication can create a positive social norm, and enhance the 'community' or engagement feeling of participants.

As the report from the World Economic Forum of September 2010 on 'accelerating successful smart grid pilots' states (Accenture, 2010): *"The most successful pilots encourage collective problem solving in the field, eliciting and responding to consumer feedback and ensuring the skills and flexibility are in place to successfully re-engineer improvements in technology and the business process. This is particularly important in consumer-facing pilots, where any lapse in performance has the potential for a long-term, detrimental impact on the consumer's perception of smart grid and their relationship with their energy provider."*

So the importance of continuous communication and 'openness' to collective and active problem solving from end-user feedback is relevant and successful when working on end-user pilot projects.

3.4 Privacy and security

Privacy and security basically concerns two subjects:

- *Privacy and data protection*: avoiding the exploitation of data for improper use
- *Security*: avoiding that unauthorized individuals gain access to data ('hacking')

3.4.1 Privacy and data protection

The frequency and scope of smart meter measurement, close to real time, and on the end-user level, enables the operator and / or utility a broad view of the end-user's energy behaviour. With long term collection, the patterns of the end-user's life style may be deducted. Exploitation of these data for improper use has an impact on the end-user's privacy.

The operator and/or utility therefore needs to take measures to protect the nature and contents of this data. Directions on smart meter integration that are typically followed are:

- *Data minimization – scope & length:* There might be obligations and/or recommendations about the data storage form and duration. For example, hour data are stored for 1 year, daily data are stored for 3 years and monthly data are stored for 10 years.
- *Transparency:* To whom, when and at what circumstances is access to the personal data provided? It needs to be determined to which extent the utility needs to store the data in personal form and where it can be anonymous. The utility needs to separate the storage for the end-user personal usage and (anonymous) storage for the grid operation & maintenance. Naturally, data storage purposes should not interfere with national (tax) laws.
- *Empowerment of the end-user for safeguarding the consumer rights:* The end-user needs to be informed and agree about:
 - What data is collected and stored
 - The period of storage
 - What kind of processing this data will be subject to

It is general consensus that smart meter integration should follow the privacy as a default issue and not as an optional one. That means that the end-user has the right to get a maximal privacy regarding the data protection.

3.4.2 Security

The 'Security' addresses protection against attacks on the system by hackers with the intention to overtake control, corrupt the data, etc.

The following issues may be the subjects of security requirements:

- *User and device identification & authentication:* The system is capable to authenticate the users and devices and is capable to reject them
- *Access control:* The system is capable of managing the authorized access to the particular components
- *Integrity of data exchange:* The system guaranties the integrity of the data exchanged
- *Confidentiality of data storage:* Implementation of the security mechanism for data storage including encryption keys
- *Integrity of data storage:* Implementation of the equipment for data storage integrity including firmware equipment
- *Confidentiality of data exchange:* Prevention against eavesdropping. The system has integrated corresponding encrypted mechanism
- *Anti-replay:* Implementation of the mechanisms ensuring the uniqueness of the messages
- *Secure Broadcast:* Due to its high impact on multiple components its communication must take place in the secure manner

Based on the security recommendations of the 'Open meter' project (Open meter, 2011), security may be categorized in the following levels of resistance²⁷:

- *Basic level:* Provides an adequate protection against low level attack. This level gives a partial answer to the security requirement

²⁷ All the security requirements are categorized into the resistance levels in the associated project report.

- *Intermediate level*: Provides a protection against low level attack. This level gives an adequate answer to the security requirement
- *High level*: Provides a protection against the high level of attack. This level gives an undeniable answer to the security requirement.

3.4.3 Conclusion

The general strategy regarding privacy (data minimization, data usage transparency and informing the end-user) and security should have a legal basis and the smart grid project should take both issues explicitly into account. In practice these issues are particularly relevant when the project goes into the large scale realization and data abuse or security attacks may really occur. As the projects involved in S3C may generally be characterized as ‘pilots’ they may to some extent be exempted from these strict requirements. Nonetheless, whatever the scale of the project, when dealing with end-users, an adequate strategy for privacy and security is highly recommended as it is one of the known end-user concerns.

3.5 New smart grid market models

In this section, new smart grid market structures will be described that allow end-users to take up a more active role in a smart grid context by offering flexibility. There are several stakeholders that can benefit from the flexibility offered, i.e. the TSO, the DSO, the BRP and the retailer. Therefore potential services for each of these actors will be identified and described.

3.5.1 Context: energy market

As part of the energy market liberalization process that started in the late 1990s in the EU, the third legislative package on the common electricity market of July 2007 required the different activities of the electricity value chain - production, transmission, distribution and supply - to be legally unbundled.

In the paragraphs below, the main tasks performed within those activities are enumerated for the electricity market (EG3, 2013):

The *transmission system operator (TSO)* is the actor responsible for the transmission grid, the high voltage lines. The main tasks of the TSO are to provide access to all grid users under the same conditions. He is compensated for this service by the transmission grid tariffs. Amongst its roles are to manage the system: real time management of balance and frequency control. Usually, the TSO has a natural monopoly within a country and as such is often subjected to national regulations.

The further distribution of electricity towards small industrial and residential customers is the task of the *distribution system operator (DSO)* or distribution grid operator. The DSO builds, manages and maintains the distribution network for electricity in a certain geographical region. On request, the DSO distributes the energy to the end consumer. Amongst other tasks he has to install and upgrade connections, install meters, guarantee the efficiency, safety and reliability of the distribution network and provide and maintain public lights. The number of DSOs greatly depends on the country; it may vary from one to several hundred (EC, 2006).

An important market player is the *Balancing Responsible Party (BRP)*. Their role is to safeguard the real-time balance between energy generated and consumed in their portfolio. To do that, they estimate on a daily basis generation and consumption of electricity: each BRP has the responsibility to balance its own portfolio of production and consumption. Any company wishing to participate on the wholesale market has to do it via a BRP. The requirements to become BRP vary per country.

The *retailer* or *energy supplier* is the actor who sells the energy to the end consumer. They are responsible for the billing of the customer. The energy bill bundles their price with the transmission, distribution grid tariffs and taxes.

A schematic representation of the energy market before and after the unbundling is shown in Figure 25.

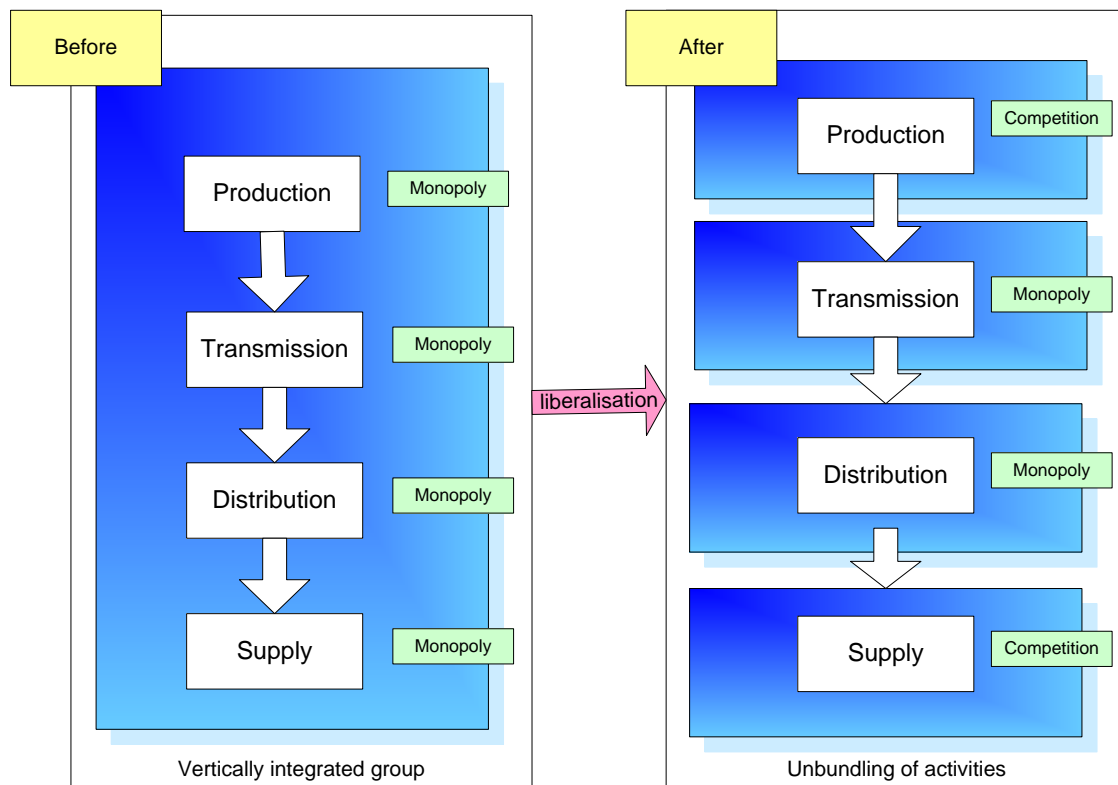

Figure 25: Unbundling of the energy market

3.5.2 Market structures for smart grids

In this context, new smart grid market structures refer to different possible modes in which the various actors (TSOs/DSOs/BRPs/retailers) can operate to serve the electricity demand of end-users in an unbundled energy market, making optimal use of the demand side management (DSM) potential offered by smart grid technology. To this end, the concept of aggregation is key. The aggregator's main role is to offer services by aggregating flexibility from different sources (consumers and generators) and to act towards the grid as one entity. It mediates interactions among different grid users like collecting demand flexibilities from end-users and selling them to parties that request flexibility (JRC, 2011). The aggregator is clearly not restricted to aggregating consumption flexibility. It can also aggregate generation flexibility from prosumers and operate larger decentralized units such as photovoltaic installations or wind-farms. The aggregator bundles these small amounts of flexible consumption and generation and thereby qualifies them to become a tradable product for different markets.²⁸

The aggregator role has been recently broadly introduced in the European market, offering various services to TSOs, DSOs, BRPs, retailers or end-users (see 3.5.3 Business models for smart grids). The role of aggregator can be taken up by an already active or new player on the market, as for example (Tant et al., 2012; E-DeMa, 2013):

- A BRP;
- A Telecommunications Company (Telco);
- An Energy Service Company (EsCo);
- An Energy Supplier/retailer;
- A DSO²⁹.

²⁸ In this context, the home energy management system can be seen as the interface between the aggregator and the consumer. It carries out the optimization and the control of the loads and local distributed energy resources at consumer's premises and thus 'represents' the consumer from an aggregator's perspective (Peeters et al, 2009).

²⁹ In the ADDRESS project, the aggregator is considered as a deregulated player on request of the European Commission: he can be a pure aggregator, an aggregator-retailer or any other type of unregulated player. Following this reasoning, the DSO wouldn't be able take up the role of an aggregator (ADDRESS, 2011a).

The market structure is defined by the specific tasks of, and relations between, the different market players. Figure 26 shows the traditional electricity market structure (arrows indicating the communication options). This is a rather linear model, with the retailer being the ‘end of the chain’ towards the end-user. More innovative market models help to integrate new relations between established traditional roles, extensions of old roles (new competencies), new roles and communication options. Figure 27 and Figure 28, for example, show the market structures of two recent projects: the E-DeMa and the e-Telligence project for the integration of the new roles. One observes a generally more complex structure with different possible modes of interaction between the responsible parties for the various tasks. The aggregator enables the participation of small loads in the market which would not be possible otherwise.

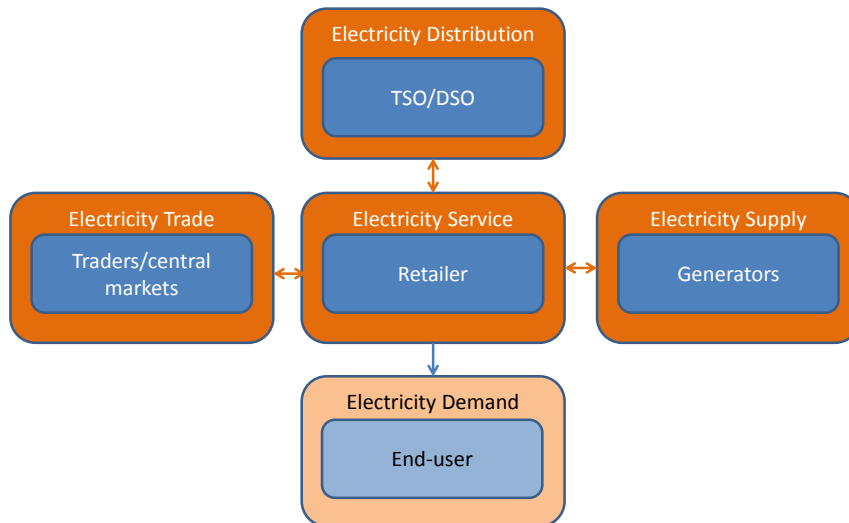

Figure 26: Traditional electricity market structure

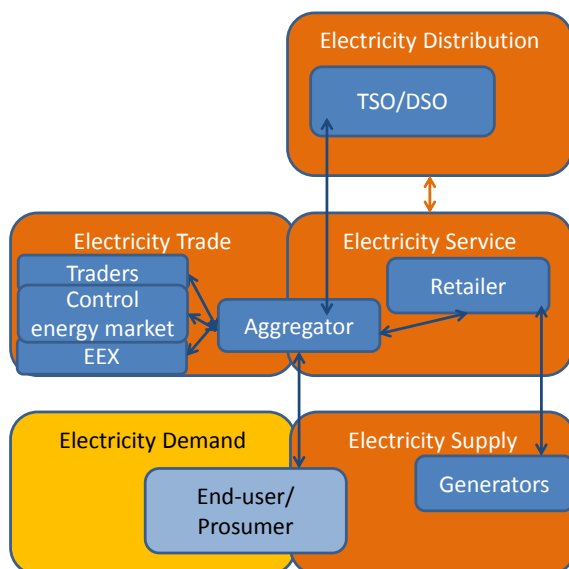

Figure 27: E-DeMa project market structure.

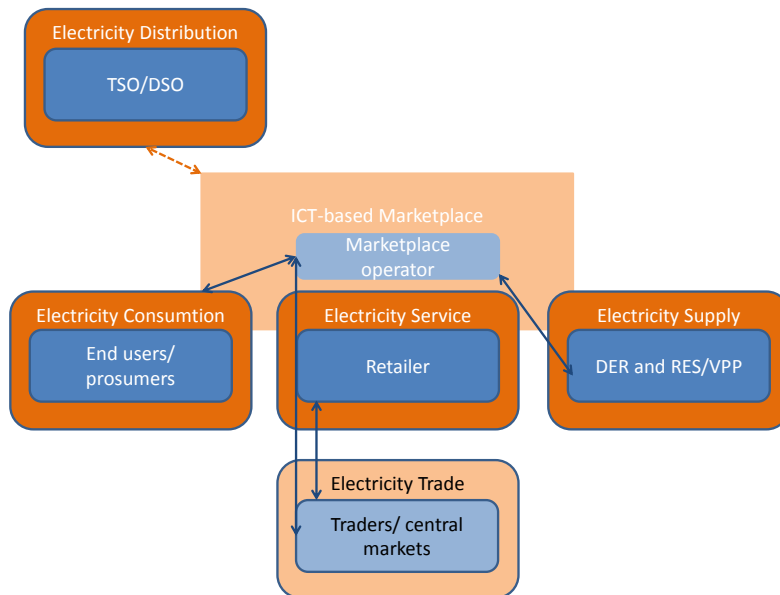

Figure 28: e-Telligence project market structure. The aggregator role will be performed via a virtual power plant or the manager of the eTelligence market place.

Of specific interest for the S3C project is the role of the end-user, who can participate in the new market structure interacting with the aggregator. There exist different ways of interaction between the aggregator (managing the flexibility) and the end-user (Gkatzikis et al., in press). On the one hand, the aggregator can take direct control (‘direct contracting’) of the end-user’s appliances always taking into account the comfort settings. In this case, the consent from the end-user is needed, as well as a clear contractual basis. On the other hand, the aggregator or energy supplier can send incentives or price information to the end-user to react (‘voluntary incentives’). In this case, there is a high probability, but not a certainty that the end-user will respond. This model is more acceptable and easier to implement from the legal point of view. In both cases, the aggregator has to deal with the implications of a massive use scenario and avoid unbalanced incentives amongst the different end-users. Both interaction schemes – direct contracting and voluntary incentives – integrate the end-user more into the energy system than the traditional scheme, and transform their formerly entirely passive role into a more active one.

3.5.2.1 Aggregator as a multi-sided platform

In a Demand Response context, aggregators mediate interactions among different grid users, like collecting demand flexibilities from consumers and selling them to retailers/BRPs and DSOs. The more members of one party join the platform (e.g. end-users), the more members of the other parties have an incentive to join (e.g. retailers, DSOs, Smart Appliance manufacturers). In related literature, these market structures are called multi-sided platforms (MSP) (JRC, 2011).

Example: the ADDRESS project

The Demand Response platform analysed in the ADDRESS project is a MSP led by an aggregator. The platform participants can interact with each other to buy and sell load flexibility (ADDRESS, 2013). The ADDRESS architecture is depicted in Figure 29. The aggregator manages its customer’s flexibility via the Energy Box and interacts with the market to commercialize it.

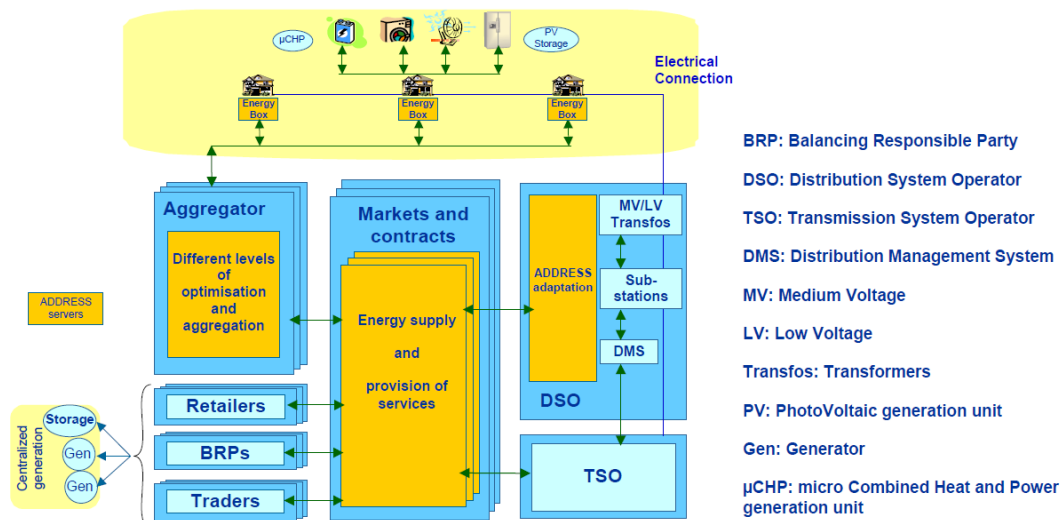

Figure 29: The ADDRESS project architecture

3.5.2.2 Aggregator representing distributed energy sources: Virtual Power Plants

A virtual power plant (VPP) is a cluster of distributed energy resources (DER) which are collectively run by a central control entity or aggregator. These groups of DERs then gain access and visibility in the energy market and maximise their revenue opportunities. Also, the system operator can benefit from optimal use of all available capacity and increases efficiency (Pudjianto et al, 2007).

Example: The FENIX project

The FENIX project was the first one to deal with aggregation. More specifically, FENIX dealt with the aggregation of DERs (and mainly Distributed Generation, energy storage systems and large industrial end-users) into VPPs (FENIX, 2009). The cluster of distributed generation installations are then collectively run by a central control entity.

The FENIX architecture is described in Figure 30. Two types of VPPs are defined, the Commercial Virtual Power Plant and the Technical Virtual Power Plant:

- The Commercial Virtual Power Plant (CVPP) builds the day-ahead schedule and sells the energy provided by the DERs to the wholesale market.
- The Technical Virtual Power Plant (TVPP) performs the technical validation of the day-ahead base schedules of the CVPPs, proposes remedial actions, and brings the DER generation visible to the TSO.

In this architecture, the end-user is only in contact with the CVPP interface. The end-user sends its load pattern for the following day. Afterwards, the CVPP communicates to the TVPP the final day ahead schedule for validation, and communicates back with the end-user.

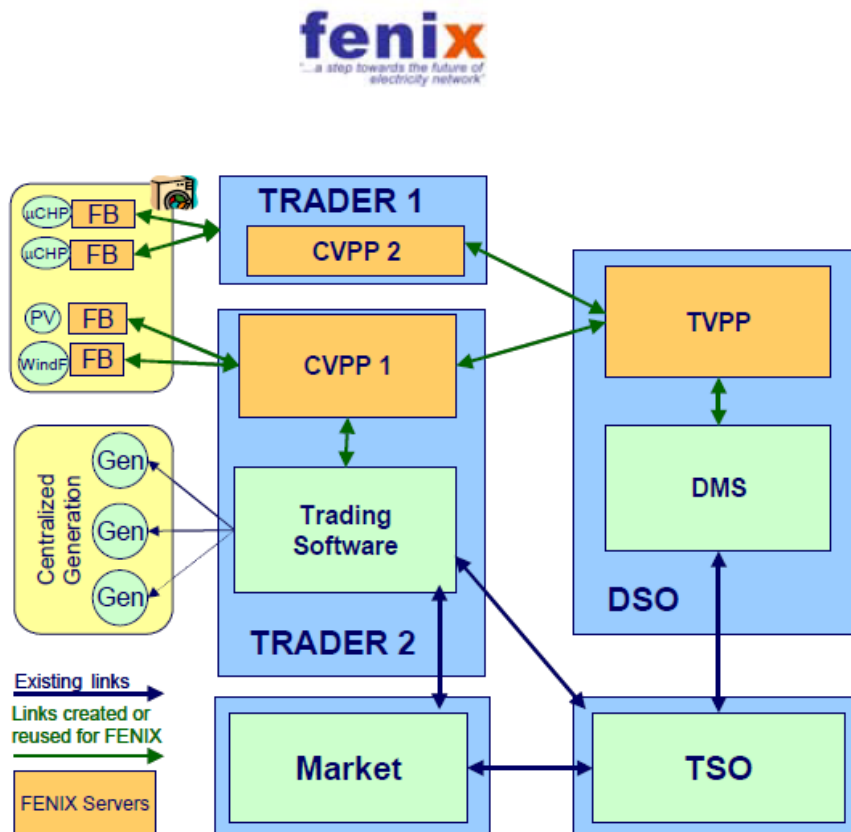

Figure 30: FENIX architecture

Example: The ECO-Grid EU project

The ECO-Grid EU project is testing a complete, integrated market platform for the exchange of electricity services through aggregation of DERs, with no restriction on power size. It includes market mechanisms for aggregation on both the supply and demand side (EcoGrid, 2013). The project develops a real-time distributed market (5 minutes update of price signals) which includes distributed generators, heat pumps and EVs (JRC, 2011).

The schematic architecture is shown in Figure 31. The figure shows the proposed ICT architecture for real-time price distribution in Ecogrid. Real-time electricity prices for both selling and buying electricity are generated at the real-time price generation module every five minutes. The price-generation module takes inputs from TSO, electricity spot market, historical metering data, and weather forecast for computing the real-time price (for both buying and selling electricity) and a real-time price forecast over the next few hours. Generated prices and price forecasts are sent to the price-distribution system. End-nodes or smart devices adjust their planned consumption according to the price information received. All households are connected to a smart electricity meter, which measures the power consumption of the device/devices every five minutes. The measured power consumption data is uploaded to the historical metering data repository once every 24 h (Gantenbein et al., 2012).

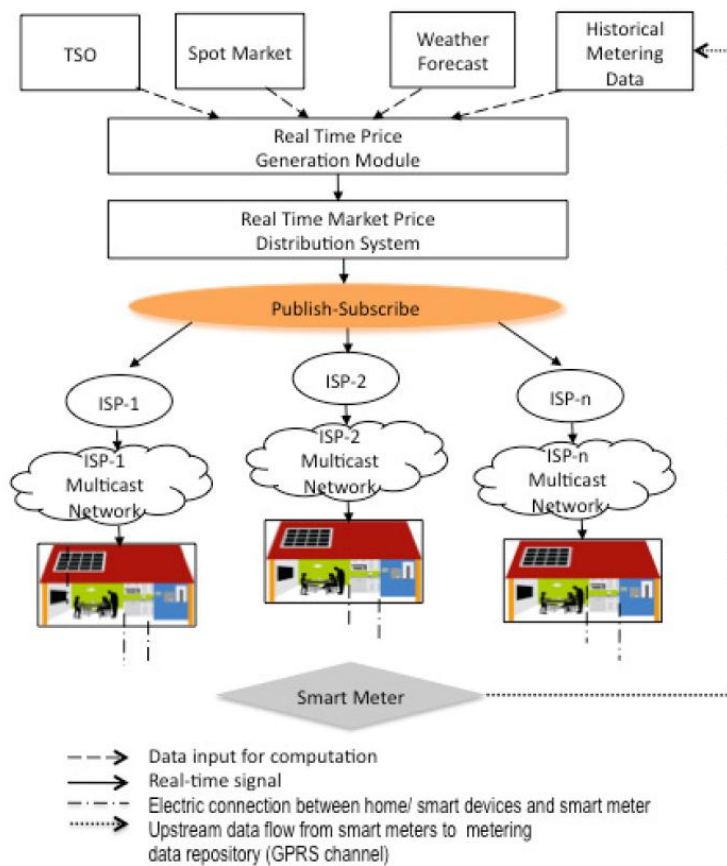

Figure 31: Real-time price distribution architecture for EcoGrid EU

3.5.3 Business models for smart grids

Smart grid development will create different benefits for different energy market participants, which can be shared amongst each other (JRC, 2011):

- A TSO can improve the balancing and congestion management and gather forecasting data.
- A DSO can shave peaks, postpone network reinforcements or reduce grid expansion costs, have extra options for system management (e.g. solve voltage band violations). Moreover they can benefit from reduced outage times through self-healing capabilities, asset optimisation and improved planning.
- A BRP can reduce the imbalance of his portfolio.
- A retailer can improve the management of his portfolio as well for a more profitable operation.
- Aggregators can make profits by offering flexibility and/or electricity services
- End-users can sell load flexibilities, optimize consumption, have access to more transparent and frequent billing information, can realize energy savings, have a better business case for purchasing DERs (e.g. electric vehicles, heat pumps, smart appliances), benefit from reduction of outages, have possibilities to turn into a supplier, etc.

The actor performing the aggregation of the load of the end-users can thus choose to commercialize it towards different players in the market. The choice of service would depend on the type and quantity of load controlled, as well as on the specific market rules.

3.5.3.1 Services to the TSO

3.5.3.1.1 Offering reserve capacity to the TSO

This business model focuses on the participation of parties, having flexible production and consumption, in ancillary markets during the settlement period. Traditionally, these real-time balancing actions are performed by contracted reserve capacity. The key idea of this business case is the utilization of real-time

flexibility of end-users (prosumers) in balancing a control zone (SmartHouse/SmartGrid, 2010). This business model is mainly meant for larger consumers rather than households.

Example: The EU-DEEP project

The project explores the aggregation of small scale DER (10 kW to 1.5 MW) to reveal the Demand Response potential (Bourgain, 2009). EU-DEEP developed some concrete business models for aggregated load management in the UK. The industrial and commercial market segments with an end-user portfolio made up of industrial and commercial sites with different flexible loads (e.g. supermarket, shops, hotel, factory, cold store, offices) were aggregated to offer services to the TSO or directly to the power market. See also Figure 32.

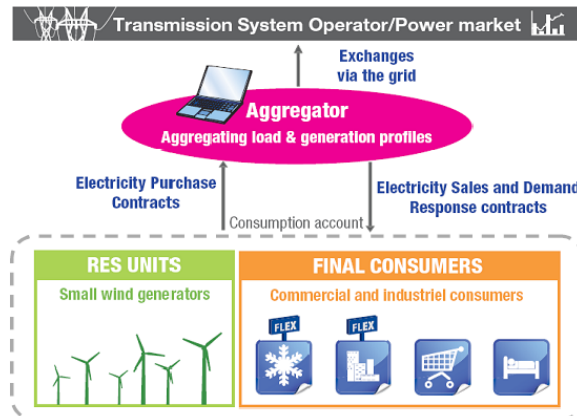

Down to which level of power is Demand Response profitable?

Figure 32: EU-DEEP business model architecture for the UK test

The minimum flexibility level for profitability was estimated for each player (hotel, shop, council offices, large offices and cold store). One notable result that emerged is that the current minimum requirement in the UK of 3 MW or more of steady demand reduction (or more generation) in order to provide Short Term Operating Reserve (STOR) to the TSO can be reduced and sites as small as 500 kW could partake in the scheme. This increases electricity market participation potential significantly.

3.5.3.1.2 Black-Start Support from Smart Houses

The key idea of this business case is to support the black start operation of the main grid. It considers that after the blackout the local grid is also out of operation and the main goal is to start up quickly in island mode and then to reconnect with the upstream network in order to provide energy to the system (SmartHouse/SmartGrid, 2010).

The scenario has four main steps: the first step is before the event that may occur, the second step is just after the event, the third step is the steady islanded operation and the final step is the reconnection to the main grid.

During the first step the system should monitor the available DG units and the end-users and forecast the consumption as well the available power and energy in the next hours. A load shedding schedule should be created according to the criticality of the end-users, as well as to the amount of money they want to pay during the island mode and the black start operation. In the first minutes or seconds after the event the TSO allows the operation according to the criticality. If there is enough power to the islanded grid no load shedding will take place. When balance and stability has been ensured the aggregator decides how to manage the energy within the network. When the system will be in safe state it will try to reconnect in order to provide power to the grid and the goal is to provide as much energy and power as possible.

3.5.3.1.3 Frequency control services

These ancillary services enable the TSO to maintain frequency and voltage at appropriate levels.

Example: The EU-DEEP project

The EU-DEEP project identified as a source of value for the aggregator the provision of Frequency Control Services after final physical notification and before start of supplying period. It is implemented via a contract. The minimum size is 3MW. The availability has to be notified one week ahead (Bourgain, 2009). Large consumers may have a direct contract with the TSO while in case of end-users participation, an aggregator is needed to reach the minimum required size.

3.5.3.2 Services to the DSO

3.5.3.2.1 Distribution system congestion management

This business model focuses on flexibility energy sources within a certain part of the distribution grid. The DSO is interested in keeping a stable load profile at the transformer station, avoiding peak loads. Therefore the load is measured at the transformer station. Whenever the load becomes critical, a signal is created that encourages the flexible energy sources to react accordingly (SmartHouse/SmartGrid, 2010).

Example: The Linear project

Within the Linear project, a number of DSO services were tested (Tant et al., 2012):

- *Load pattern control of low voltage distribution transformers:* In this business case, the DSO aims to decrease the peak load of a given distribution transformer. An aggregator can support this task by controlling flexible energy resources at residential premises in its network in real-time, to defer or decrease network investments.
- *Voltage control in low voltage lines:* Due to the boom of photovoltaic panels, voltage rises can occur, going above the upper boundary. On the other hand, the integration of electric vehicles leads to excessive voltage drops unless the charging is coordinated. One way to cope with these fluctuations is Active Demand (AD). In this business case, a DSO optimizes the voltage profile on a low voltage feeder by controlling real-time flexible energy resources at residential premises in its grid.

Example: The E-DeMa project

In the E-DeMa project, the aggregator controls white good appliances and μ CHPs to offer flexibility to third parties such as the distribution system operator. The DSO can use that flexibility to eliminate local congestions or to reduce the annual maximum load at the distribution network connection point (E-DeMa, 2013).

In this case, the end-user has to activate the smart start function of the appliances before 9 am and has to set an end-time after 6pm. The aggregator will start the provided appliances during this time frame if needed. If the aggregator does not use the appliances, the E-DeMa gateway will start the machines so that the program will be done by the end-time.

3.5.3.2.2 Distribution Grid Cell Islanding in Case of Higher-System Instability

The key idea of this business case is to allow the operation of a grid cell in island mode in case of higher system instability in a market environment. This business case considers that the islanding procedure is performed automatically. The scenario has two main steps: the first step takes place before the event that may occur and the second step is the steady islanded operation (SmartHouse/SmartGrid, 2010).

During the first step the system should monitor the available DG units and end-users, and forecast the consumption, as well as the available power and energy in the next hours. A load shedding schedule should be created according to the criticality of the end-users and the amount of money they want to pay during the island mode.

In the first minutes after the event the DSO allows the operation according to the criticality. If there is enough power to the islanded grid no load shedding will take place. When balance and stability has been ensured the aggregator decides how to manage the energy within the network.

3.5.3.3 Services to the BRP

3.5.3.3.1 Real-time Imbalance Reduction of a BRP Portfolio

As already mentioned, the TSO is the final responsible of keeping the grid balance. To help maintaining this balance, the TSO contracts a BRP at each grid access point. The BRP is responsible to balance off-take and generation in its portfolio. If a BRP is not able to control the balance due to unexpected events, the instantaneous imbalance is managed by the TSO. In return, the TSO transfers the costs involved for making use of power reserves to the BRP. This is stated as the imbalance costs. The BRP can use the flexibility within its portfolio for its real-time balancing actions during the settlement period in order to minimize its imbalance costs.

Example: The Linear project

One of the identified business cases in the Linear project is the wind balancing case. A BRP with a high share of wind power in his portfolio has a higher imbalance risk and thus on average higher imbalance costs. Within this case the BRP reduces the deviations between predicted and measured wind power generation by means of active demand (Tant et al., 2012).

Example: The EU-DEEP project

This project identified the reduction of imbalance costs after final physical notification as one of the sources of value the aggregator can deliver to the BRP (Bourgain, 2009).

3.5.3.3.2 Trading in the wholesale market

Any market participant is obliged to conclude a contract with a BRP in order to participate in the wholesale market. This condition is meant to secure the balancing between production and consumption. Enlarging its portfolio, the BRP benefits from more degrees of freedom to keep the balance.

Example: The EU-DEEP project

Obtaining the Best Price in the Market (OBPM) before Market closure, consisting of power trading until gate closure was one of the sources of value identified for the aggregator (Bourgain, 2009).

3.5.3.4 Services to the retailer/BRP: Portfolio Management

The key idea of the business case is a variable price profile given to the end-user before the time of delivery (e.g. day-ahead) by a retailer. This profile is considered as fixed after transmission to the end-user, so the end-user can rely on it. The price profile will look different for each day, however, to reflect market conditions that also vary from day to day.³⁰ These variations will likely increase with increasing generation of fluctuating sources like wind power and photovoltaics (SmartHouse/SmartGrid, 2010).

It may be part of the business model that the retailer receives feedback from the end-users after the transmission of the prices and during the day of delivery on their automatically planned/predicted load/generation profile. So the retailer/BRP can optimize his portfolio by trading on intraday electricity markets for example. It is also possible, however, to rely solely on a prediction model of end-user behaviour.

As a further option it would be possible that in exchange for an additional financial incentive end-users might be willing to accept adaptations of the price profile during the day of delivery reflecting changes in the retailer/BRP portfolio that come up during the day and also to reduce imbalance in his portfolio.

Example: The Linear project

Residential end-users help operating the power system in a more efficient way by responding to dynamic electricity prices. In the short term, energy costs are reduced by prioritizing cheaper renewable electricity generation and avoiding the ramping up of more expensive peaking plants. In the long term, utilities

³⁰ The different possibilities have been worked out in section 3.1.2.1 'Types of tariff structures'.

avoid capacity, transmission and distribution costs. Moreover, the large scale integration of renewable energy in the long term is facilitated by AD, leading to environmental benefits (Tant et al., 2012).

Example: The Customer-Led Network Revolution project

The project aims to move towards a low carbon economy. 14,000 homes and businesses are involved in the initiative in the UK (CLNR, 2013). It consists of running trials to test ways that end-users can change how and when they use electricity, via a combination of tariff incentives, efficient technologies and closer relationships with the electricity supplier and network operator.

3.5.3.5 Services to the end-user

3.5.3.5.1 Energy Usage Monitoring and Optimization Services

When detailed metering data is collected on a large scale, valuable information can be extracted from the data pool, which can help end-users to achieve the desired reduction in energy consumption. For example, through comparing one's own consumption pattern with average load profiles of comparable households, an end-end-user can become better aware of his energy usage. Or, if the place of energy consumption is made visible in a comprehensible manner, the end-user is able to find out how much energy is spent by which appliances, and can identify the greatest potential for a reduction of energy consumption. A portal or display that combines information about present and past consumption, comparisons to average consumption patterns, and precise suggestions how to further lower consumption which are tailored personally to the end-user is probably the most effective way of realizing the possible increase in households' energy efficiency (SmartHouse/SmartGrid, 2010).

The business concept of services that comprise average consumption patterns could rely on the principle of reciprocity: those end-users who contribute to the data set by allowing metering data to be read by the service provider can also access average data. This concept gives an incentive for the end-users to reveal their data, under the condition that it is not accessible by unauthorized parties. The additional value to the end-user provided by the described information services can either be remunerated through additional fees or through enhanced end-user loyalty. A combination of both is also conceivable.

3.5.3.5.2 New marketing options for prosumers

Apart from the services related to energy-monitoring and consumption optimization, the aggregator can offer to the first DER and RES plants installed new lucrative options to market their generated energy amount which are too small to be traded on their own. These plants are reaching their time limit of feed-in-tariffs guarantee. Furthermore, several European countries are discussing to lower these feed-in-tariffs or to abolish them completely, so the business case for residential DER/RES-aggregation increases in importance. In that case, even aggregator options that are not as lucrative as the subsidised feed-in options today, might become very relevant for consumers.

3.5.4 Conclusions

The energy system is increasing its complexity due to different factors such as the penetration of renewable sources, the introduction of electrical vehicles and the liberalization process. The introduction of smart grids can help to deal with this phenomenon. The full deployment of smart grids requires successful and viable new business models. These are currently hindered by the current regulatory frameworks which do not take into account the possibility to deploy ICT-hardware and software within the electricity system. Within the smart grids, the advantages that Demand Response (DR) and flexible generation offer are key.

Demand Response is one of the central themes of the European projects. Its target is to enable active participation of commercial/domestic consumers in the market through the provision of consumption flexibility services to different players in the power system. This is achieved by aggregating consumers' reduced load into larger amounts for participation in market sales (e.g. to sell to network companies, balancing responsible parties, owners of non-controllable generation, etc.) (JRC, 2011).

Aggregators are the key players to mediate between consumers and the market and create feasible products from small amounts of flexible generation and consumption. Particularly challenging is the integration of domestic consumers who, as opposed to distributed generation and large industrial consumers, are less motivated by purely economic concerns (minimal gains). Furthermore, domestic consumers are generally unable to make precise predictions on their available load flexibilities; therefore it is difficult for them to 'offer' services in the classical sense (JRC, 2011).

There exist different ways of interaction between the aggregator (managing the flexibility) and the end-user (SmartHouse/SmartGrid, 2010). On the one hand, the aggregator can take direct control of the end-user's appliances and/or generation units always taking into account the comfort settings. In this case, the consent from the end-user is needed as well as a clear contractual basis.

On the other hand, the aggregator can send incentives or price information to the end-user to react. In this case, there is a high probability but not a certainty. This model is more acceptable and easier to implement from the legal point of view. In both cases, the aggregator has to deal with the implications of a mass use scenario and avoid unbalanced incentives amongst the different end-users.

The aggregator may be an actor already active in the energy market or a new arising player. Due to the important weight of the IT component in smart grids, this market is open to new players with that precise knowledge. Identified market players are the BRP, a telecom company or an EsCo which could potentially take up the role of aggregator. However, traditional energy retailers can enhance their product portfolio installing aggregation services for their customers as well.

The business models can be classified depending on the player the flexibility is offered to. There can be services offered to the TSO, the DSO, the BRP, the retailer or the end-user. The flexibility may be used to reduce imbalance costs by the balancing responsible party such as to improve wind balancing. It can be used to offer reserve capacity to the TSO or to help the system congestion system by shifting load and generation to the benefit of the DSO. The aggregated flexibility can also be used to improve system stability and for voltage control. Flexibility can also be employed for obtaining the best price in power trading. Finally, aggregation services can also benefit the end-users that can optimize their energy use.

For prosumers, aggregation is expected to become increasingly important, given the development of feed-in tariffs in Europe. If revenues from feed-in-tariffs are minimized, or the schemes are to be abolished altogether, DER- and RES-owners will need to find new options to bring their generation to the markets. Many of them are not interested in or even qualified to market the energy they generated themselves. In this case, the aggregator could help to bridge the gap between prosumer and energy markets.

3.6 Key lessons from other sectors

In this chapter we will have a short look on experiences with innovations, adaptation and diffusion of innovations in other sectors, mainly in the mobile phone and ICT industry. These examples can show how in other sectors the roll out of new technologies was accomplished, for example by new tariff structures and incentives. Furthermore the importance of usability, design and marketing will be emphasized. The aim of the chapter is to learn for the rollout of smart grids from the experiences made in other sectors. The focus hereby is on technologies that changed the behaviour of their users and/or their willingness to use new technological devices.

3.6.1 Tariffs, business models and incentives – examples from the telecommunication sectors

In this section we will have a look at the telecommunication industry and how it dealt with innovation. The rise of the smartphone seems to be a good case study, because there are some similarities to smart grids. In both cases there are providers who are selling a service which is paid per unit (minutes – kWh) and who are willing to sell innovative new products from other companies to their customers (mobile phones, smartphones ...). Smart grids require investments and reengineering into the electricity grids (e.g. data network, smart meter), which is similar to the telecommunication industry facing new mobile cellular systems (UMTS, 3G, LTE³¹). And both industries were faced with the liberalization of their markets (electricity: 1998; telecommunication: 1996) and many new actors and companies appeared since then on the market. The key difference between those industries is that within the telecommunication industry a constant improvement and extension of services (with an added value) can be observed within the last years. In the case of electricity the commodity is still the same: It is still 'just' electricity that comes out of the wall socket. But what changed, is the possibility to become a producer of energy by oneself, which doesn't change the commodity itself, but changes the relationship between the producer and the user of energy (prosumer).

The question in the following will be: How did the mobile phone operators engaged users to change their communication behaviour, using new services and buying and extensively using new devices. One

³¹Long Term Evolution (new wireless communication standard)

explanation for this is seen in tying arrangements³², which is a usual business model in this industry. This means, that the telecommunication service provider offers a subsidized mobile phone to his customers. The advantage for the service provider is twofold. On the one hand, he enables his customers to use new services like mobile internet. On the other hand, the costs for the subsidized phone will be refunded due the cost for the tariffs. For customers these tying arrangements are a financial incentive, which enables them to have the latest device and to use new services.

But the tying arrangements may also provide an obstacle for innovation. Before Apple emerged in 2007 in this sector, service providers dictated the steps for the technological development according to the new services they wanted to sell and not necessarily according to the needs of their customers. Apple, on the contrary, developed the iPhone by itself without restrictions or guidelines from the service providers. This led to the development, that the other manufacturer did the same and started to create phones for the consumers, not the service providers.³³

Referring to smart grids, this means that it could be reasonable to make tying arrangements to bring new energy efficient and DSM-capable devices into households or SMEs. Further one can think of new tariff structures like flat-rates connected with the ability to use electronics for DSM (e.g. fridges, freezer, washing machines). A general lesson is that smart grid products should be developed for the needs of the people who use it and not for the needs of the energy suppliers.

3.6.2 Usability, design and marketing – What can we learn from Apple?

Apple entered the mobile phone market in 2007. Before Apple appeared in this sector the amount of innovation was much smaller for several reasons. As West and Mace (2010) argue, the main impact for the success of the iPhone was based on the conception bringing the real internet – not the mobile internet, with slow data rates (WAP) and extra services in a ‘walled garden’ – on mobile phones. Further a worldwide advertising campaign and a huge publicity made the new product a lifestyle gadget and status symbol. Apple created this new lifestyle and the need for purchasing a smartphone. This can be seen as well by their competitors, which imitated the style and design for their new smartphones. The usability for these new products was given by reduction of complexity and easy to use interfaces.

It seems useful to try to transfer these strategies to the case of smart grids. This would imply, for example, that energy devices should have a modern and unobtrusive design, are customizable (they must fit in every living environment), they should be easy to install and use, and have an intuitive interface. The marketing for these products should popularize a lifestyle which, on the one hand, animates to more sustainability, and on the other hand fulfils the need for distinction. And there are many added values which can be emphasized, like smart home services, information transparency and a higher living comfort.

One example of a successful, new smart energy product is the thermostat from NEST³⁴ (Simonite, 2013). It's a self-learning and adjusting controlling device, incorporating an appealing user interface, helps raising awareness and gives immediate feedback to the customer. It has been designed by former Apple employees who were involved in the design of the iPod and iPhone and seems to be quite a success in the USA³⁵. The NEST-thermostat is easy to install and is easy to use due its intuitive and clear interface. With the integrated sensors it can recognize, if the flat/house is empty or not and learns the users preferences, behaviour and routines to adapts its settings with the aim to minimize the use of the installed HVAC³⁶ devices. The thermostat can further be operated via the smartphone or a web interface. Additionally, the interface shows a green leaflet if the energy consumption is falling and thereby coaches and motivates the user to use less energy (and spend less money).

In contrast to conventional thermostats, which are commonly installed by contractors, the NEST-thermostat is sold in electronic retail stores, next to smartphones and tech gadgets. Due its clear interface

³² These tying arrangements can be seen as a nonmonetary incentive for end-users and can be found in other sectors as well (e.g. power supply contract with a free Television, Pay-TV contract with a free receiver, discounted elevators or copiers tied to a maintenance agreement).

³³ http://www.wired.com/gadgets/wireless/magazine/16-02/ff_iphone?currentPage=all accessed October 2013

³⁴ <http://www.nest.com/>

³⁵ See e.g. <http://gigaom.com/2013/01/29/exclusive-nest-has-raised-another-80m-now-shipping-40k-thermostats-a-month/> accessed October 2013

³⁶ Heating, Ventilation and Air Conditioning

and the smart design it provides much more than just being a thermostat: it's more a tech gadget which makes saving energy a lifestyle topic and thus motivates users to gain more responsibility to their energy consumption.

3.6.3 Examples from Green IT

Further lessons can be drawn from Green IT (environmentally sustainable ICT). Green IT can be classified within three classes: telecommunication-networks, data centres and cloud computing, and energy monitoring and management of offices. The most interesting connections to smart grids and end-user engagement can be seen in the latter field of energy monitoring and management of offices. For example, the energy efficiency in office buildings can be improved by different technologies which involve the employees. Sensors can manage applications and hardware in a smart way and reduce the energy consumption. Energy management tools can further make the energy consumption visible, display potentials for saving energy and help to develop energy saving measures and best-practice solutions.

The program 'IT2Green'³⁷ (2011-2014), funded by the German Federal Ministry of Economics and Technology, covers all three Green IT classes, with three projects in the field of telecommunication networks, three in the field of data centres and cloud computing, and three in the field of monitoring and management. In the following, the projects dealing with monitoring and management will exemplarily be described.

- The IT2Green project 'GreenIT Cockpit'³⁸ monitors business processes with regard to their energy consumption in large-scale enterprises, SMEs and administrations, analyses them and makes them visible and displays the specific potentials for optimization with the help of key performance indicators. The developed management cockpit was tested in three field-tests (Axel Springer AG, TimeKontor, Umweltbundesamt).
- The 'Adaptive Sense'³⁹ project aims to optimize the usage of hardware resources for efficiency improvement. The targeted efficiency gain for electric and thermal energy is 30%. For this purpose, a wide area of sensors will be developed.
- The project 'Pinta'⁴⁰ analyses user behaviour and sensor data from technical devices and offers an automatic control of the whole office infrastructure (IT workplace, IT devices, lightning, heating and cooling) with the aim of improving the energy efficiency, saving costs, and improving indoor conditions. The context aware energy management system is tested in different office environments (University, research Centre, administration building). The main focus hereby is the user identification and context surveillance with different autonomously operating sensors. So it is not the user itself who changes its behaviour, but it is rather the office environment that is optimized to the users behaviour. In light of a user-oriented strategy, a web interface and an Android app were integrated into the management system where users can define their personal needs (lighting, heating). Partly due this approach, an energy reduction of 30% has been achieved within the field tests.⁴¹

In these demonstration projects the focus is on the automation of office and IT-infrastructure with the aim of reducing the energy consumption. The office infrastructure and environment adapts to the efforts of a sustainable use of energy resources. The added value for the users is that the system minimizes energy consumption without any need to a changed behaviour.

A key lesson for smart grid projects is that changing an end-user's environment may be sufficient to achieve smarter energy behaviour, without the need for further changing end-users behaviour. An energy management system may learn about users' behaviours and accordingly adapts its setting with the aim of saving energy. Particularly in large organizations, where it might be difficult to persuade all users to change their behaviour this could be a reasonable alternative. These energy management systems are also capable to reveal energy saving potentials and can be enhanced by giving energy saving advices and hints to the user.

³⁷ <http://www.it2green.de/en/index.php>

³⁸ <http://www.greenit-cockpit.de>

³⁹ <http://www.adaptive-sense.org>

⁴⁰ <http://www.pinta-it2green.de>

⁴¹ Jelena Mitic (Project Leader of Pinta at Siemens), personal communication, 19 September, 2013.

3.6.4 Lessons learned

- Think about new business models, like for example tying arrangements.
- Develop devices for the needs of the users, not for the needs of the suppliers.
- It is important to give and emphasize the added value of the devices (e.g. lowering energy costs, information transparency, more comfort, smart home services, ...) to give an extra incentive.
- Create a cool lifestyle around these products.
- Connect energy saving to an enhancement of comfort.
- Make it simple, so that the devices can be used without a manual.
- Devices should learn from the behaviour of their users.
- Take work away from the users instead of overburden them with complexity and too many functions.
- Take care about the design, the devices should fit into every household without looking like an alien.
- Notably in large organizations it can be a reasonable alternative to create an automated, self-learning, user centred environment which saves energy without changing users behaviour.
- Energy management systems can reveal energy saving potentials and additionally give energy saving advices and hints.

4. Synthesis

This report has delivered a broad overview of both theory surrounding end-user engagement and smart energy behaviour, and practical experiences from a suite of smart grid projects. This synthesis aims to integrate those findings into a consistent view on what can be considered good practice for end-user interaction in smart grid projects, as currently known, and to sketch out the implications for further research. To this end, it starts with a recapitulation of the key findings in the report (Section 4.1). Following, it summarizes the enablers and barriers for engaging in smart energy behaviour (Section 4.2) and the recommendations or ‘success factors’ for end-user interaction (Section 0) as reported in the current literature. Finally, it identifies a number of key challenges for the research and development regarding end-user engagement in smart grid projects (Section 4.4) and describes what that implies for S3C research (Section 4.5).

4.1 Recapitulation

S3C Deliverable 1.1 describes a variety of insights on end-user involvement in smart grid projects from a general theoretical and from a specific empirical perspective.

Theoretical insights:

- Various theories exist that can be used to frame and analyse end-user behaviour (Section 2.1). One can roughly distinguish two schools of thought: the psychology oriented approaches take individual decision-making as a starting point, while the sociology oriented approaches focus more on the influence of social structure. Following Giddens’ structuration theory, some theories aim to bridge these two lines of thought, with practice theory and societal transitions theory as two key examples.
- End-user energy behaviour is thus influenced by a large diversity of both behavioural and situational factors (Defra, 2011). Behavioural factors include ‘rational’ factors like financial gains, other motivators (like beliefs, values, habits, and routines), social influences (like norms and leadership), and personal capabilities (like knowledge, skills, and financial means). Situational factors, amongst others include institutional factors (laws, and regulations), culture, infrastructure and social networks that may equally influence energy behaviour. This implies that a nuanced view on end-user behaviour is required, taking both behavioural and situational factors into account.
- Recent literature particularly highlights energy related practices as key to understanding and influencing smart energy behaviour. Practices are said to reside at the ‘interface’ of individual behaviours and social structure, as these behaviours are the product of, and also reinforce, social structure. According to practice theory, energy is not used consciously or rationally, but rather as the ‘byproduct’ of practices like cooking, washing, showering, working, commuting, watching TV, socialising, and travelling. Such practices are often driven by routines and socially shaped expectations. Smart grid programs would benefit from a thorough understanding of the energy related practices of their target groups.
- End-users will differ on the practices they adhere to, and on the extent to which the situational and behavioural factors mentioned above influence their energy related behaviour. Strategies for involving end-users should thus depart from a thorough understanding of the target group, for example by applying a segmentation approach (Section 2.2). Current segmentation models can roughly be divided into models based on general values, preferences and opinions (‘population segmentation models’) and models that are tailored to specific (smart grid) products and programs and/or regions (‘target group segmentation models’). They classify end-users generally on the basis of socio-demographic criteria (age, household, income and education level), behavioural factors (preferences, beliefs, values, norms) and more recently also on the basis of energy-related behavioural characteristics (Sütterlin, 2011).
- To actively engage with end-users, a number of further principles for communication and engagement apply (Section 2.3). These are reflected in key (social) marketing models like the 4P’s marketing mix (product, price, promotion, place), the AIDA model (attention interest, desire, action), Cialdini’s principles of influence (reciprocity, commitment, social proof, liking, authority, scarcity), and Defra’s 4E model (enable, encourage, engage, exemplify). A mix of solutions is generally recommended to ‘serve’ different user types.

- In addition, communications theory emphasises that an effective communication strategy needs to consider the following key components: the sender (make clear who is communicating), the target group (to whom is communications addressed?), the aim (make explicit why one is communicating), the message (content and form need to be adapted to the target group), the timing (when should the message be delivered?) and the communication channels (which ones are used by the target group?).

These findings are largely consistent with, and complementary to, the findings from the empirical literature:

- Different types of incentive based programs (3.1.1) can be adopted to engage with end-users in demand response. These may be ‘classical’ or ‘market-oriented’, comprising monetary and/or non-monetary incentives, and which could be operated on a capacity and/or use oriented mode. End-user questionnaires reveal that financial benefits, reliability, comfort, and the level of control over appliances are some of the key factors taken into account when deciding to enrol in such programs.
- Alternatively, dynamic pricing schemes may be used (Section 3.1.2). Various tariff structures may be offered (TOU/CPP/CPR/RTP/PBP/IBR)⁴², with different combinations possible. Evaluation reports indicate that, in general, dynamic pricing may lead to peak clipping (up to some 30% for CPP with automatic control), and reduction of the energy bill (up to 13% for RTP)⁴³. To better compare the different tariffs structures, we identified several key attributes, including the rationale of the scheme, the number of time blocks used, the price update frequency, duration of peak periods, rates and rebates offered, the price spread, the price components that are made dynamic, and whether automated or manual control is applied. Further key lessons include the need for a variety of tailored interventions to address different user segments, and the need for convincing feedback mechanisms and communication and engagement strategies to make dynamic pricing ‘work’.
- Feedback on energy consumption forms a key component of an end-user interaction scheme. Regarding feedback channels and devices (Section 3.2.1), various options can be used. Most experience has been gained with in-home displays (reported energy savings ~ 7%)⁴³, but also others channels like websites (reported energy savings ~ 15%)⁴³ ambient displays, informative billing, and smartphone apps can be used. Considering the influence of the feedback channel (and its design) on energy use behaviour, a suite of factors play a role. As a general finding, mixed feedback channels are considered best suited to address a heterogeneous end-user population.
- Concerning feedback content (Section 3.2.2), different types of information can be delivered to the end-user, including for example current and expected usage rates, bill predictions, historical comparison, differentiation by appliance, unusual usage alerts, social feedback (comparison with others) etc. It tends to be difficult to assess which type ‘works best’ with partially contradictory empirical results. Nonetheless, direct feedback (e.g. real-time and historic usage) tends to be somewhat more effective than indirect feedback (e.g. processed via billing) with reported energy reductions up to respectively 15% and 10% (43). Social feedback appears effective with reported energy reductions of 8% to 25% (43). Other general recommendations include linking feedback directly to advice on actions and ensuring that feedback is interactive and sufficiently disaggregated.
- Regarding communication and engagement (Section 3.3), training to end-users and installers, innovative customer service and support (e.g. using social media), appropriate communication channels, face-to-face interaction and the need for continuous information are highlighted to generate long-term end-user interest and involvement.
- Concerning data privacy (Section 3.4), the literature stresses three important points: data minimization, transparency, and end-users empowerment (adequate information and permission requests). In addition, appropriate technical measures need to be taken to ensure data security.

⁴² Time-Of-Use pricing (TOU), Critical Peak Pricing (CPP), Critical Peak Rebate (CPR), Real-Time Pricing (RTP), Progressive Block Pricing (PBP), Inclining Block Rates (IBR)

⁴³ Indicative numbers subject to considerable uncertainty ranges

- Regarding energy markets (Section 3.5), the literature describes new market structures and services that can be developed in an unbundled market and in a smart grid framework. Although largely uncharted territory, the concept of aggregation has emerged as a key contributor to these new energy markets. Aggregators enable small loads to participate in the market which would not be accessible for them otherwise. They typically take an intermediary role between end-users and other market players on a multi-sided platform. They commercialize the aggregated flexibility from the end-users to the other market players. This aggregated flexibility can provide a number of services to the different market players, like offering reserve capacity (for TSOs), distribution system congestion management (for DSOs), portfolio management (for BRPs and retailers), and energy usage monitoring and optimization (for end-users). Such innovative business models currently remain largely untested (partly due to uncertainties under the current regulatory framework), but they will most probably become increasingly important over the coming years. Important will be to further our understanding of end-user preferences in this context, for example, regarding what their offered flexibility is used for (e.g. balancing of the local network, balancing energy consumption and micro-generation in their own home, or balancing the general, ‘anonymous’ energy market) or regarding the actors taking up the role of the aggregator.
- Recent developments in telecommunication and GreenIT (Section 3.6) provide a number of additional relevant lessons learned. These include thinking about new business models (e.g. tying arrangements) and thinking serious about usability (e.g. simple, self-learning devices), design (devices that fit into every household) and marketing (e.g. emphasising lower energy costs and more comfort, and creating ‘cool’ lifestyles around products that fulfil the need for distinction). GreenIT, notably, shows how automated systems can be developed that reduce energy consumption, while minimizing the need for behavioural change on behalf of the end-user.

4.2 Enablers and barriers for engaging in smart energy behaviour

So what do the theoretical and empirical insights tell us about smart energy behaviour? We first note that smart energy behaviour includes behaviours at different levels of consciousness, ranging from habitual to conscious and one-shot behaviour (Aarts, Verplanken, & Van Knippenberg, 1998). Energy related practices as such - like washing, cooking, heating etc. – can typically be considered habitual. However, behaviours towards a change of practices - like deciding whether to engage in a smart grid project and / or to buy smart appliances - are rather conscious or even one-shot.

Figure 33 presents this view in a highly stylized manner. The process of end-user engagement in smart grid programs and their consequent interaction with new technologies, feedback and pricing schemes (i.e. the ‘end-user interaction scheme’) is interpreted as a process of practice change towards a higher level of ‘smartness’. At the start of the process, it is assumed that end-users carry out their energy related practices in a rather habitual manner. As end-users become engaged in a smart grid program, they are stimulated towards more conscious decision-making. This phase can be considered rather ‘disruptive’, as existing practices need to be reconsidered and redefined. In this ‘activation phase’, end-user interaction is targeted typically at achieving active end-user participation and an explicit consideration of old and new practices. As new practices are adopted, behaviour becomes again more habitual. End-user interaction is then more aimed at supporting and reinforcing the new energy practices (‘continuation phase’).

Here, we focus on reported key enablers and barriers that seem to be of importance in the ‘activation’ and ‘continuation’ phases of end-user interaction. Literature reports on a variety of factors end-users consider when deciding whether to engage in (and continue with) a smart grid program. These factors can be classified as either enablers (reasons why end-users may be tempted to engage) or barriers (reasons why they would not)⁴⁴. Table 6 presents an overview of the various possible enablers and barriers listed in the literature. They are grouped under the categories (in alphabetical order) *comfort*, *control*, *environment*, *finance*, *knowledge & information*, *security*, and *social process*. Interestingly, for most categories both enablers and barriers can be identified:

- *Comfort*: Possible loss of comfort is an often mentioned barrier (e.g. Prügler, 2013). Smart grid technology may also increase levels of comfort, also mentioned as a potential enabler as such.

⁴⁴ Although generally meaningful, this distinction needs to be interpreted with care. What can be considered an ‘enabler’ or ‘barrier’ can be context dependent, and dependent on the perspective of the end-user.

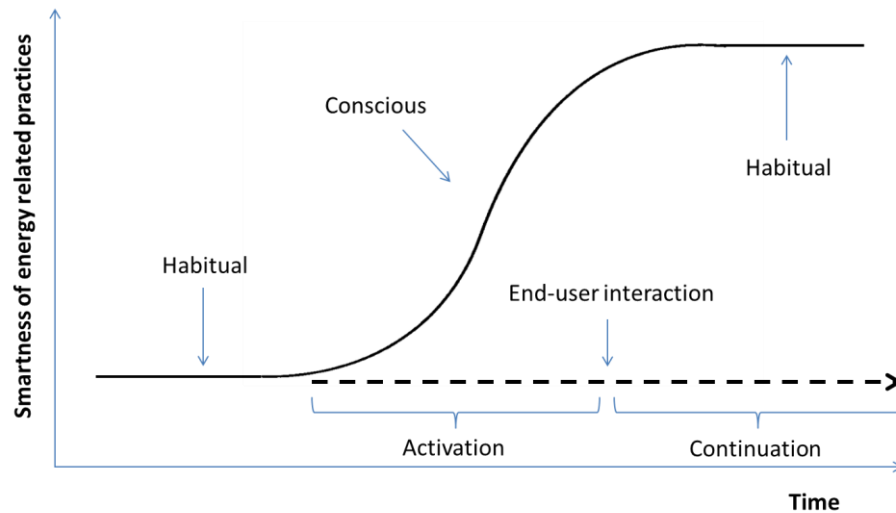

Figure 33: A stylised interpretation of the process of end-user-interaction distinguishing an 'engagement' and 'reinforcement' phase.

- *Control*: An often mentioned barrier to engagement is the perceived loss of control over appliances, as automated control algorithms 'take over' appliances⁴⁵ (Verbong, 2013; Bartusch 2011). Smart grid technology, however, may also extend the possibilities for control, for example, through more advanced possibilities for controlling appliances (e.g. using mobile devices), extended possibilities to participate in the electricity market (e.g. JRC, 2011), and possibilities for becoming more energy independent ('energy autarky').
- *Environment*: The environmental benefits of smart grid development - reducing greenhouse gas emissions by integrating renewables into the grid – is a reported key benefit end-users may strongly care about (e.g. SGCC, 2013).
- *Finance*: It is clear that financial or 'in kind' incentives and the expectation of a reduced energy bill may be clear enablers for engaging in smart grid programs (e.g. Verbong, 2013; SGCC, 2013; JRC, 2011; Prügler, 2013). On the other hand, engagement may also require investment costs for smart appliances, and may also lead a higher energy bill for end-users requiring electricity at peak times.
- *Knowledge & information*: More transparent and frequent billing information and detailed knowledge about energy use by different appliances are considered a key benefit for end-users engaging in a smart grid program (e.g. JRC, 2011). Yet, the lack of adequate knowledge and information provision about the smart grid program may act as a barrier (e.g. EEA, 2013). Additional barriers in this category are lack of competences to deal with new technologies or to negotiate with energy suppliers (e.g. EEA, 2013), a lack of awareness about the concept 'smart grid' and its potential gains (e.g. SGCC, 2013; Bartusch, 2011), and perceived risks like the (supposedly) adverse health effects of wireless signals (e.g. SGCC, 2013; Bartusch, 2011).
- *Security*: A typical security issue is improved reliability, often mentioned as an important advantage (e.g. JRC, 2011; SGCC, 2013). On the other hand, privacy and security concerns are reported as potential barriers (e.g. Verbong, 2013; SGCC, 2013).
- *Social process*: The positive stimuli social processes may provide are mostly reported as enablers of end-user engagement. This concerns, for example, the stimulating effect of role models (EEA, 2013) and customer testimonials (SGCC, 2013), and the 'community feelings' and sense of competition smart grid programs may appeal to (Verbong, 2013), basically making

⁴⁵ A basic recommendation given is to always include possibilities to interfere / overrule automatic procedures (e.g. Verbong, 2013).

participation ‘fun’⁴⁶. To some extent, social values are also reported as barriers, for example through ‘free rider effects’ (JRC, 2011) (creation of a sense of unfairness, because non-participants of the smart grid also benefit from peak shaving) or job losses (SGCC, 2013) (as meter readers will no longer be needed) end-users don’t want to be responsible for.

Table 6: Possible enablers and barriers of end-user engagement in smart grid projects listed in the literature

Category	Enablers	Barriers
Comfort	Comfort (gain)	Comfort (loss)
Control	More energy independence (‘energy autarky’) Extended possibilities to participate in the electricity market More advanced control of appliances, e.g. using mobile devices.	Loss of control over appliances
Environment	Environmental benefits	
Finance	Financial or in kind incentives Reduction of the energy bill	Investment costs Increased energy bill
Knowledge & Information	More transparent and frequent billing Detailed knowledge about electricity use	Unclear information about the smart grid program (technologies / incentives / pricing schemes) Lack of competences, e.g. to deal with new technologies or to negotiate with energy suppliers Lack of awareness about the concept ‘smart grid’ and its potential gains Perceived risks, e.g. adverse health effects
Security	Improved reliability of energy supply	Privacy and security concerns
Social process	Role models Customer testimonials Community feelings Competition Fun	Free rider effects Job losses

4.3 Recommendations for successful end-user interaction schemes

This section aims to integrate the theoretical and empirical findings further into a consistent view on what can be considered successful end-user interaction in smart grid projects. To this end, we have classified the various recommendations from literature into a set of key success factors supported both by empirical findings and established theoretical insight. We thereby distinguish success factors that are applicable mostly to the activation phase (Table 7) and ones that are mostly applicable to the continuation phase (Table 8). The column ‘empirical findings’ in these tables contains illustrative examples for the corresponding success factor drawn from the empirical section of this report. The column ‘theoretical concepts’ provides corresponding concepts from the theoretical section.

⁴⁶ As was stressed by one of the members of the S3C advisory board.

For the engagement phase, we arrive at the following key success factors:

- *Provide added value:* This corresponds broadly with providing clear added value on the various categories of enablers of Table 6, while relieving barriers as much as possible. This includes, for example, applying attractive financial incentives, ensure comfort gains rather than losses, providing new information services, ensuring data privacy and security, and include possibilities to overrule automatic procedures while offering new forms of end-user control. Corresponding theoretical notions include considering Product & Price (4P model), Exchange (Social Marketing), Encouragement (4E model) and Rational appeals (Breukers' (2009) tools for change concerning energy investments).
- *Understand end-users:* Different target groups may be susceptible to very different enablers and barriers. The challenge is thus to understand which ones are of particular relevance, and to base engagement strategies on that. Understanding the end-user is indeed strongly support in the empirical literature, for example, in the recommendations to apply segmentation (SGCC, 2013; JRC, 2011), to take into account a broad scope of behavioural determinants (EEA, 2013), to have a special focus for low income / vulnerable groups (SGCC, 2013; JRC, 2011), and to understand social practices and daily routines in a social context (Verbong, 2013). Corresponding theoretical notions include, for example, the need for 'Customer orientation', 'Theory', 'Insight', and 'Segmentation' (Social Marketing).
- *Educate end-users:* Relieving possible knowledge & information barriers will involve some form of education as programs need to take into account consumer (non-)ability to deal with new technology (EEA, 2013). Corresponding recommendations in this context include educating end-users before deployment (f.e. explaining how to shift usage to off-peak demand hours) (SGCC, 2013) and providing training to end-users and installers (Erhart-Martinez 2010; Darby, 2006; Lewis et al., 2012; Dong Energy, 2012). Theory equally stresses the importance of education, for example, to Enable end-users' to adopt new practices (4E model) and by providing transparent and understandable information & training (Breukers, 2009).
- *Create commitment & appeal:* Creating commitment & appeal involves taking full advantage of social processes as important enablers. This may include ensuring trust in the whole smart grid process (JRC, 2011), involving end-users at early project stages allowing a choice of involvement level (JRC, 2011), involving role models respected by the selected group (EEA, 2013), believable customer testimonials (SGCC, 2013), and dealing with possible free-rider effects (JRC, 2011). Creating commitment & appeal also requires effective marketing and outreach (JRC, 2011) to create a 'desire' for new products, for example by emphasising key benefits and creating new lifestyles around products. Corresponding theoretical notions can be found, for example, in the importance of the factor Engagement (4E model), Cialdini's principles (Social Proof, Liking, Authority, Reciprocity, Commitment, Scarcity), and the need for consequent attention, interest, desire and action (AIDA model).

In the reinforcement phase, the following factors appear particularly relevant:

- *Effective feed-back, pricing & communication:* A lot is known about which factors need to be considered when designing effective feedback and pricing schemes. For feedback, this involves, for example, considering direct and indirect feedback, interactive and disaggregated feedback and linking feedback directly to advice on action. For pricing this involves taking into account the various attributes (i.e. the rationale of the scheme, the number of time blocks used, etc.) described in Section 3.1.2.3. Regarding communication, it is particularly important to ensure a continuous information flow to maintain high engagement levels. Moreover, it is considered promising to link dynamic pricing, convincing feedback mechanisms and communication strategies to achieve an optimal response. Related theory includes, for example, communications theory that highlights the sender, target group, aim, message, timing and communication channels as key factors to consider in a communications strategy.
- *Variety of intervention methods:* Although understanding of the end-user is key, there are limitations on the extent to which 'tailor made solutions' can be offered, especially for a heterogeneous target group. Several studies therefore also stress the need for adopting a variety of intervention methods and techniques to serve different user types. This includes, for example, adopting a variety of feedback information and channels (Lewis et al., 2012) and adopting a variety of tailored dynamic pricing schemes to address different user segments (Breukers & Mourik, 2013).

Table 7: Success factors for end-user engagement described in the literature for the activation phase.

Success factor	Empirical findings	Theoretical concepts
Provide added value	Attractive financial incentives Comfort gains rather than losses New information services Data privacy and security Allow automatic procedure overruling	Product, Price (4P) Exchange (Social Marketing) Encourage (4E) Rational appeals (Breukers, 2009)
Understand the end-user	Apply segmentation Consider broad scope of behavioural determinants Special focus low income / vulnerable end-users Understand social practices, daily routines and social context	Customer orientation, Theory, Insight, Segmentation (Social Marketing)
Educate the end-user	Consider consumer (non-)ability to deal with new technology Educate end-users before deployment Provide training	Enable (4E) Transparent and understandable information & training (Breukers, 2009)
Create commitment & appeal	Establish trust in the whole process Early end-users involvement Role models Customer testimonials Deal with free-rider effects Effective marketing and outreach Emphasising key benefits Creating lifestyles around products	Engage (4E) Build trust and confidence, Emotional appeals (Breukers, 2009) Reciprocity, Commitment, Social Proof, Liking, Authority, Scarcity (Cialdini) Promotion (4P) Competition (Social Marketing) AIDA model

- *Ease of use*: User-friendly, intuitive designs are considered important to minimize effort needed for operating new devices and schemes (i.e. to minimize knowledge & information barriers perceived by end-users). Ease of use also includes adequate and pro-active support and service, e.g. by ‘anticipating and answer questions before customers ask them’ (SGCC, 2013). Support and service may actually benefit from user-friendly, intuitive designs, for example by using social media for support services (Dong Energy, 2012). These practical recommendations correspond to the tool ‘provide support and services’ (Breukers, 2009) and also to the factor Enable (4E model).
- *Social comparison*: It is generally considered stimulating to allow end-users to compare their (new) energy behaviours to peers. Besides setting individual energy-saving targets (EEA, 2013), this thus involves comparing those targets (and their fulfilment) to others. The case for social comparison is reflected for example in recommendations to appeal to the competitive nature of people (Verbong, 2013) and in the perceived effectiveness of social feedback for influencing behaviour (Lewis et al., 2012).
- *Reflection & learning*: Smart grid innovations can be considered ‘complex’, involving many connections to other domains and scale levels and significant uncertainties on technical, social and other dimensions. Reflection and learning is therefore needed, starting in the activation phase and continuing throughout the continuation phase. This could involve, for example, eliciting end-users’ expectations at the start of the process, and evaluating their experiences later

on, possibly fine-tuning interaction schemes when needed. On the project level, monitoring and evaluation cycles may be incorporated to further update, upscale and replicate project designs and offerings (see e.g. NSMC (2011)). Also, letting initiatives be part of a wider programme with clear objectives can be stimulating for end-users (EEA, 2013). All in all, smart grid innovation projects may function as ‘niches’ (see e.g. Rotmans, 2005) in which end-users, suppliers, designers and other actors collaborate and co-create knowledge in the further development of the smart grid.

Table 8: Success factors for end-user engagement described in the literature for the continuation phase.

Success factor	Empirical findings	Theoretical concepts
Effective feedback, pricing & communication	<p>Consider direct and indirect feedback, interactive and disaggregated feedback and linking feedback directly to advice on action.</p> <p>Consider attributes like the rationale of the scheme, the number of time blocks used, the price update frequency etc.</p> <p>Ensure a continuous information flow.</p> <p>Linking feedback, pricing and communication strategies</p>	Communications theory: take into account sender, target group, aim, message, timing and communication channels
Variety of intervention methods	<p>Variety of feedback information and channels</p> <p>Variety of tailored dynamic pricing schemes</p>	
Ease of use	<p>User-friendly, intuitive designs</p> <p>Pro-active support and service (e.g. using social media)</p>	<p>Enable (4E)</p> <p>Provide support and services (Breukers, 2009)</p>
Social comparison	<p>Individual energy saving targets</p> <p>Appeal to the competitive nature of people</p> <p>Social feedback</p>	
Reflection & learning	<p>Elicit and follow-up end-users' expectations</p> <p>Monitoring and evaluation cycles</p> <p>Position initiatives within a wider programme with clear objectives</p> <p>Co-creation of knowledge</p>	<p>Societal transitions</p> <p>Social Marketing</p>

A previous version of this classification of success factors was tested in a meeting with smart grid experts on the S3C advisory board. Participants were asked to brainstorm about what to do and what not to do when involving end-users. The results (see Appendix) indicate that understanding and educating the end-user were seen as the most crucial factors for success or (when inadequate) failure. Additional attention points included creating commitment & appeal, the co-creation of knowledge, and adequate communication and feedback.

We thus arrive at a rather extensive list of suggestions for end-user-interaction. We stress that this list is not to be interpreted as a blue print, but rather as an overview of factors that need to be considered when designing or evaluating an end-user-interaction scheme.

4.4 Key challenges for (research on) end-user engagement in smart grids

Given what is currently known, what are the key ‘unknowns’? In this section, these unknowns are formulated as key challenges that can be identified for (research on) end-user engagement in smart grid projects. Reflecting back on Figure 33, the overall question S3C addresses may be formulated as: “how to contribute to smarter energy behaviour”? In other words, how to break ‘old’ routines and practices of energy use, and support the development and new ‘smarter’ ones? Within this scope, S3C defines a number of concrete challenges it will address in its further research:

A 1st challenge relates to identifying and targeting specific end-user groups. Although the overall scope of potential enablers, barriers and success factors for end-user engagement is relatively clear (see Table 6, Table 7, and Table 8), it is as yet largely unclear how these should be related to the different type of end-users that may be targeted. End-user segmentation is one of the approaches that may be further developed in this respect. The challenge is thus to find instruments or approaches that contribute to achieving better understanding of the enablers and barriers of target groups and the type of end-user interaction scheme best suited to them.

A 2nd challenge relates to the added value of smart grid related products from the perspective of the end-user. The current energy system in Western Europe operates with few flaws. End-users are used to being able to use electricity whenever they see fit. The risk with DSM programs is being perceived as ‘demanding’ a lot from customers (in return to reduction of price), rather than a project that makes an interesting offer (for which end-users would be even willing to pay). In that sense, smart grid technology is a challenging technology to ‘sell’. The challenge is thus to find innovative products and services that provide clear added value to end-users, while contributing to fostering smart energy behaviour.

Further challenges (3-4) relate to available knowledge on the effects of end-user interaction schemes. Although some research has been done on for example the effect of feedback and dynamic pricing on energy use, peak clipping, empirical evidence on the effectiveness of the various engagement schemes remains weak. Notably, further research is needed to assess the effect of combinations of approaches and to identify critical success factors. The challenge is thus to understand both which (monetary or non-monetary) incentives and pricing schemes, as well as feedback information and feedback channels contribute to fostering smart energy behaviour.

A 5th key challenge relates to the use of communication channels, information and marketing techniques. Although a number of general recommendations on communication and information provision can be given, empirical evidence on the effect of communication and information on smart energy behaviour remains weak. Moreover, although the field of marketing has shown the added value of applying marketing techniques, actual use of such techniques in smart grid projects remains weak. The challenge is thus to better understand which communication channels, information and marketing techniques contribute to recruitment and engagement of end-users in smart energy projects.

A 6th key challenge relates to the cooperation between stakeholders. Current smart grid projects may include various actors other than the traditional energy players. It is as yet unclear how this involvement of non-energy players may influence end-user engagement. The challenge is thus to understand to what extent involvement of non-energy stakeholders contributes to end-user engagement and smart energy behaviour.

A 7th key challenge relates to the end-users as initiators of projects. Whereas the literature describes a variety of results on end-user involvement, relatively little is reported on ‘bottom-up’ projects in which end-users are initiators and ‘owners’ of the project. In S3C terms, most projects place end-users in a Consumer or Customer role and were initiated by other stakeholders than citizens usually incentivized by a European/national/regional funding opportunity. Yet, very few projects are reported on that place end-users in a Citizen role. Here, combining smart grid research with research on smart cities seems promising, as the latter does tend to place the end-user in a more central role. The challenge is thus to find instruments or approaches that contribute to facilitating end-user empowerment (from consumer to customer and/or citizen).

An 8th key challenge relates to the new market structures and the role of end-users in those structures. Although a number of projects have addressed this issue, further testing is needed. A specific issue is how to ensure legislation and regulation supports, rather than hamper, smart grid development. Another issue is to develop new interpretations of the role of customers, as well as the market entry of completely new actors and roles that lead to new interactions and innovative value chains in the energy system. In particular, a tailored approach to different end-user segments will require that the end-users provide a lot of information of a potential ‘sensitive’ nature (e.g. regarding lifestyles, values, preferences, etc.). The

issue of trust is thus of particular importance when designing new market structures. All in all, the challenge is thus to understand which features of the interaction between end-users and energy market structures contribute to end user engagement and smart energy behaviour.

A 9th key challenge relates to up-scaling and replicating pilot projects involving a diverse end-user group. Although significant experience exists with pilot projects, little experience has been gained in larger scale roll-outs. Findings from pilot projects - often targeting specific end-user groups (e.g. ‘early adopters’) - can not a priori be transferred to the case of larger scale roll-outs dealing with a much more diverse audience. In particular when engaging with the typical ‘indifferent’, ‘vulnerable’ or ‘stalled starters’, specific criteria will apply, such as making the technology highly accessible, and working with very easy to understand messages. The challenge is thus to understand which issues hamper and/or facilitate up-scaling or replication of smart energy projects.

Key challenges:

1. Understanding the target group(s): Which instruments or approaches contribute to achieving better understanding of the enablers and barriers of target groups and the type of end-user interaction scheme best suited to them?
2. Products & services: How / in what way can innovative products and services provide clear added value to end-users, while contributing to fostering smart energy behaviour?
3. Incentives & pricing schemes: Which (monetary or non-monetary) incentives and pricing schemes contribute to fostering smart energy behaviour?
4. End-user feedback (system communication): What feedback information and which feedback channels contribute to fostering smart energy behaviour?
5. Project communication: Which communication channels, information and marketing techniques contribute to recruitment and engagement of end-users in smart energy projects?
6. Cooperation between stakeholders: Does involvement of non-energy stakeholders contribute to end-user engagement and smart energy behaviour?
7. Bottom-up support: Which instruments or approaches contribute to facilitating end-user empowerment? (from consumer to customer and/or citizen)
8. New market structures: Which features of the interaction between end-users and energy market structures contribute to end user engagement and smart energy behaviour?
9. Scalability / replicability: Which issues hamper and/or facilitate up scaling or replication of smart energy projects?

Comparing these challenges to the ‘don’t knows’ of the brainstorm with S3C advisory board members (see Appendix), one observes that questions of how to change routine behaviour and how to understand and target specific target groups receive most attention.

4.5 Implications for S3C research

This section sketches how findings of this report have fed into the other research tasks undertaken in the S3C project.

4.5.1 Selection of projects

The findings in this report suggest key lessons can be learned from those projects that address one or more of the key challenges identified above. The challenges thus notably underpin the selection criteria (Task 1.2) of being innovative. That, together with a number of other criteria, forms the basis on which project selection takes place. As such, the key challenges may equally form a framework for finding innovative and not yet tested interaction schemes (Task 3.3) by reflecting for each key challenge on what innovative examples can be found.

4.5.2 Scope and research questions

The report has contributed to developing the ‘common approach’ described in the S3C report “Final list of research questions and action plan for WP3-5” (D1.2). In particular, it has delivered a number of

‘sensitising concepts’ of societal transitions, social practices, affordances and learning. It equally contributed to designing concrete research questions from the end-user and design perspective. From the end-user perspective, it highlighted research questions on drivers and barriers, expectations, evaluation and learning. From a design perspective, it pointed to relevant research questions on the adopted engagement principles, the evaluation of those principles and the match between design and end-user perspectives. The identified key challenges may be further used in the interviews, to address specific lessons that can be extracted from the investigated projects for one or more of these challenges. Finally, the overview of end-user interaction schemes reported on in the literature fed into the classification structure that together with the interviews will form the basis for the assessment of projects (WP3).

4.5.3 Towards tools and guidelines

Finally, the descriptions of tools and best practices given in this report – together with the findings of the analyses of projects to be undertaken - provides a basis for the development of guidelines and a toolkit for practitioners (WP4). In particular, the overview of success factors in end-user engagement (Table 7 and Table 8) may provide a first structure for such a toolkit, by highlighting factors that need to be considered when designing an end-user engagement strategy. One particular challenge S3C will address is to link such practices to different types of end-users and end-user roles – e.g. consumers, customers and citizens - to be able to target different end-user types in the most effective way.

5. Bibliography

Section 2

- Aarts, H., Verplanken, B., & Van Knippenberg, A. (1998). Predicting behaviour from actions in the past: repeated decision making or a matter of habit? *Journal of Applied Social Psychology*, 28, 1355–1374.
- Abrahamse, W., L. Steg, C. Vlek, T. Rothengatter (2007). The effect of tailored information, goal setting, and tailored feedback on household energy use, energy-related behaviours and behavioural antecedents. *J. Environ. Psychol.* 27, 265–276.
- Accenture (2010). Understanding Consumer Preferences in Energy Efficiency. Accenture end-consumer observatory on electricity management 2010. www.accenture.com
- Accenture (2011). Revealing the Values of the New Energy Consumer. Accenture end-consumer observatory on electricity management 2011. www.accenture.com
- Ajzen, I. (1988). Attitudes, Personality and Behavior. Open University Press. Berkshire, UK.
- Belz, F.-M. and M. Bilharz (Hrsg.) (2005): Nachhaltigkeits-Marketing in Theorie und Praxis, Wiesbaden 2005.
- Bergman, N., Eyre, N. (2011). What role for microgeneration in a shift to a low carbon domestic energy sector in the UK? *Energy Efficiency*, 1-19.
- Bijker, W.E. (1995). *Of Bicycles, Bakelites and Bulbs*. Cambridge, MA: MIT Press.
- Bijker, W. E., Hughes, T. P., & Trevor, J. (1987). Pinch, eds. 1987. *The social construction of technological systems: New directions in the sociology and history of technology*.
- Breukers, S. and R.M. Mourik (2012). Changing Energy Demand Behaviour: The Potential of Demand-Side Management. In: *Handbook of Sustainable Engineering*, 48. Springer Science+Business Media B.V.
- Breukers, S., and R.M. Mourik (2013). The end-users as starting point for designing dynamic pricing approaches to change household energy consumption behaviours. Report for Netbeheer Nederland, Projectgroep Smart Grids (Pg SG). DuneWorks, March 2013.
- Breukers, S., E. Heiskanen, R.M.Mourik, D. Bauknecht, M. Hodson, Y. Barabanova, B. Brohmann, V. Bürger, C.F.J. Feenstra, M. Jalas, M. Johnson, P. Maier, S. Marvin, H. Meinel, J. Pariag, M. Rask, S. Rinne, S. Robinson, S. Saastamoinen, J. Salminen, I. Valuntiene, E. Vadovics, (2009). Interaction schemes for successful energy demand side management. Building blocks for a practicable and conceptual framework. Deliverable 5 of the CHANGING BEHAVIOUR project. www.energychange.info
- Brey, P. (1997). New Media and the Quality of Life, Technè, *Society for Philosophy and Technology Quarterly*, 3, 1-23.
- Brook Lyndhurst (2007). Public Understanding of Sustainable Energy Consumption in the Home Department for Environment Food and Rural Affairs (DEFRA).
- Burkhalter, A., J. Kaenzig and R. Wüstenhagen (2007). *Kundenpräferenzen für Stromprodukte – Ergebnisse einer Choice-Based Conjoint-Analyse*, Beitrag zur Tagung „Umweltwirtschaft“, Wirtschaftsuniversität Wien 2007.
- Callon, M. (1987). Society in the making: the study of technology as a tool for sociological analysis. *The social construction of technological systems*, 550, 83-103.
- Cialdini, R. B. (1984). Influence - The Psychology of Persuasion. New York: William Morrow and Company, 302 pages.
- Cialdini, R. B., Kallgren, C. A., & Reno, R. R. (1991). A focus theory of normative conduct: a theoretical refinement and reevaluation of the role of norms in human behavior. *Advances in Experimental Social Psychology*, 24, 201–234.

- Cialdini, R. B., Reno, R. R., & Kallgren, C. A. (1990). A focus theory of normative conduct: recycling the concept of norms to reduce littering in public places. *Journal of Personality and Social Psychology*, 58, 1015–1026.
- Dam, S. van, Kobus, C.B.A. (2013 forthcoming) Understanding Archetypical Users, Their Utilization of Home Energy Management Systems, and the Practices That Emerge. Working paper.
- Darby, S. (2006). The effectiveness of feedback on energy consumption. A review for DEFRA of the literature on metering, billing and direct displays. Environmental Change Institute, University of Oxford, Oxford.
- Darby, S. (2010). Smart metering: what potential for householder engagement? *Building Research & Information* 38(5): 442-457.
- Davis, F.D. (1989). Perceived Usefulness, Perceived Ease of Use, and User Acceptance of Information Technology, *MIS Quarterly* (13:3), pp. 319-339.
- Defra (2008). A Framework for Pro-Environmental Behaviours London, UK: Department for Environment, Food and Rural Affairs (DEFRA).
- Defra (2011). Framework for Sustainable Lifestyles. Centre of Expertise on Influencing behaviours. <http://archive.defra.gov.uk/environment/economy/documents/sustainable-life-framework.pdf>
- Dong Energy (2012). The eFlex Project. Dong Energy, November 2012. <http://www.dongenergy-distribution.dk/SiteCollectionDocuments/eFlex/The%20eFlex%20Project-low.pdf>
- Faruqui, A., Sergici, S., Sharif, A. (2009). The impact of information feedback on energy consumption – a survey of the experimental evidence. *Energy* 35: 1598-1608.
- Geels, F., Schot, J. (2010). Managing sustainable innovation journeys. In: Grin, J., Rotmans, J., Schot, J. (Eds.), *Transitions to sustainable development. New directions in the study of long term transformative change*, New York: Routledge: 80-92.
- Giddens, A. (1979). *Central Problems in Social Theory. Action, Structure and Contradiction in Social Analysis*. Berkeley: University of California Press.
- Golove, W.H., J.H. Eto (1996). Market barriers to energy efficiency: a critical reappraisal of the rationale for public policies to promote energy efficiency, Lawrence Berkeley National Laboratory, LBL-38059, University of California, Berkeley.
- Gram-Hansen, K. (2010). Residential heat comfort practices: Understanding users. *Building Research & Information* 38(2): 175-186.
- Guerra-Santin, O. and Itard, L. (2010). Occupants' behaviour: Determinants and effects on residential heating consumption. *Building Research & Information* 38(3): 318-338.
- Guy, S. and E. Shove (2000). *The Sociology of Energy, Buildings and the Environment: Constructing Knowledge, Designing Practice*. Taylor & Francis Ltd.
- Harland, P., Staats, H., & Wilke, H. A. (1999). Explaining proenvironmental intention and behavior by personal norms and the theory of planned behavior¹. *Journal of Applied Social Psychology*, 29, 2505-2528.
- Jaeger, C., Dürrenberger, G., Kastenholz, H. and Truffer, B. (1993). Determinants of Environmental Action with Regard to Climate Change. *Climatic Change*, 23:193–211.
- Kahneman, D. and Tversky, A. (1984). Choices, Values, and Frames. *American Psychologist*, 39, 341–350.
- Kahneman, D.; Knetsch, J. L., Thaler, R. H. (1991). Anomalies: The Endowment Effect, Loss Aversion, and Status Quo Bias. *Journal of Economic Perspectives* 5, 193–206.
- Kaiser, F. G., Wolfing, S., & Fuhrer, U. (1999). Environmental attitude and ecological behaviour. *Journal of Environmental Psychology*, 19, 1–19.
- Kemp, R., J. Schot, and R. Hoogma (1998). Regime shifts to sustainability through processes of niche formation: the approach of strategic niche management. *Technology Analysis and Strategic Management* 10, no. 2: 175–96.
- Latour, B. (1987). *Science in action: How to follow scientists and engineers through society*. Harvard University Press.

- Lewis, E. St. E. (1985). "Financial Advertising (AIDA Model)". Lewey Bros., Reprinted by Garland Publishing Inc., New York & London, pp.77.
- Lindenberg, S., & Steg, L. (2007). Normative, gain and hedonic goal frames guiding environmental behavior. *Journal of Social issues*, 63, 117-137.
- Macionis, J. & Gerber, L. (2010). *Sociology*, 7th Canadian Ed. Toronto, Ontario: Pearson Canada Inc.
- MacKenzie, D. and Wajcman (eds.) (1985). *The Social Shaping of Technology*, Open, University Press, Milton Keynes Macwell W., *The Pursuit of Power : Technology, Armed Forces and Society Since A.D. 1000*, U. of Chicago Press.
- MacKenzie, D. (1990). *Inventing Accuracy*. Cambridge, MA: MIT Press.
- Maslow, A.H. (1943). A Theory of Human Motivation, *Psychological Review* 50(4): 370-96.
- McCarthy, E. J. (1960). *Basic marketing: a managerial approach*. Homewood, Illinois: Richard D. Irwin inc.
- Mela, C.F., Roos, J. & Deng, Y. (2013). A Keyword History of Marketing Science. *Marketing Science*, Vol. 32, 1, pp. 8–18
- Mourik, R.M. (2011). *Een segmentering voor de slimme meter uitrol*. AgentschapNL. July 2011.
- Nordlund, A. M., & Garvill, J. (2003). Effects of values, problem awareness, and personal norm on willingness to reduce personal car use. *Journal of Environmental Psychology*, 23, 339–347
- NSMC (2011). *Big Pocket Guide to using social marketing for behaviour change* London, UK: The NSMC.
- Offermans, A. (2012). *The Perspectives Method: Towards socially robust river management*. PhD thesis, Maastricht University, The Netherlands.
- Ohmae, K. (1991). *The Mind Of The Strategist: The Art of Japanese Business*, McGraw-Hill.
- Pels, D. (1996). The Politics of Symmetry. *Social Studies of Science*, 26(2).
- Pinch, T. J., & Bijker, W. E. (1984). The social construction of facts and artefacts: Or how the sociology of science and the sociology of technology might benefit each other. *Social studies of science*, 399-441.
- Power, K. and O. Mont (2012). *Analysis of latest outcomes of academic work on sustainable consumption 2010-2012*. Copenhagen, European Topic Centre on Sustainable Consumption and Production: 15.
- Rogers, E.M. (2003). *Diffusion of innovations* (5th Edition). New York: The Free Press.
- Rose, C. (2010). *How to Win Campaigns. Communications for Change. Second Edition*. London: Earthscan.
- Rotmans, J. (2005). *Societal Innovation: between dream and reality lies complexity*. Inaugural Adress, Erasmus University Rotterdam.
- Schwartz, S. H. (1977). Normative influences on altruism. In L. Berkowitz (Ed.), *Advances in experimental social psychology*, Vol. 10 (pp. 221–279). New York: Academic Press.
- Schwartz, S. H. & Howard, J. A. (1981). A normative decision-making model of altruism. In J. P. Rushton (Ed.), *Altruism and helping behaviour: Social, personality and developmental perspectives* (pp. 189–211). Hillsdale, NJ: Erlbaum.
- Shove, E. (2003). Converging Conventions of Comfort, Cleanliness and Convenience. *Journal of Consumer Policy*, 26, 395-418.
- Simon, H. A. (1983). Alternative visions of rationality. In: Moser, P.K. (Ed.) *Rationality in action: Contemporary approaches*. Cambridge University Press, pp. 189–204.
- Smart Grid Consumer Collaborative (SGCC) (2013). 2013 State of the Consumer Report. SGCC, available at <http://smartgridcc.org/>
- Steg, L., Dreijerink, L., & Abrahamse, W. (2005). Factors influencing the acceptability of energy policies: testing VBN theory. *Journal of Environmental Psychology*, 25, 415–425.

- Steg, L., and C. Vlek (2009). Encouraging pro-environmental behaviour: An integrative review and research agenda. *Journal of Environmental Psychology*, 29, 309–317.
- Stern (2000). Towards a coherent theory of environmental significant behaviour.
- Stern, P. C., Dietz, T., Abel, T., Guagnano, G. A., & Kalof, L. (1999). A value-belief-norm theory of support for social movements: the case of environmentalism. *Human Ecology Review*, 6, 81–97.
- Stromback, J., Dromacque, C., Yassin, M. H. (2011). Empower Demand. The potential of smart meter enabled programs to increase energy and systems efficiency: a mass pilot comparison. VaasaETT Global Energy Think Tank, Helsinki, Finland.
<http://www.esmig.eu/press/filestor/empower-demand-report.pdf>
- Sunnerstedt, E. & Backman, H. (2012). EVUE – Joint procurement of electric vehicles.
http://urbact.eu/fileadmin/Projects/EVUE/documents_media/EVUE_report_280912_FINAL.pdf
- Sütterlin, B., Brunner, T., Siegrist, M. (2011). Who puts the most energy into energy conservation? A segmentation of energy consumers based on energy-related behavioural characteristics. *Energy Policy* 39: 8137–8152.
- Thaler, R.H. & C.R Sunstein (2008). *Nudge. Improving Decisions About Health, Wealth And Happiness*. Yale University Press.
- Thompson, M., Ellis, R., and Wildavsky, A. B. (1990). *Cultural Theory*. Westview Press. Boulder, Colorado, USA.
- Tversky, A., Kahneman, D. (1974). Judgment under uncertainty: heuristics and biases. *Science*, 185, 1124–1131.
- Van Buuren, A., Loorbach, D. (2009). Policy innovation in isolation? Conditions for policy renewal by transition arenas and pilot projects. *Public Management Review* 11(3): 375-392.
- Vasseur, V. (2012). Innovation adopters: a new segmentation model – The cases of photovoltaic in The Netherlands. In: World Sustainability Forum 2012, online conference.
- Venkatesh, V.; Morris, M. G.; Davis, G. B.; Davis, F. D. (2003), User acceptance of information technology: Toward a unified view, *MIS Quarterly*, 27(3): 425–478.
- Verbong, G., Beemsterboer, S., Sengers, F. (2013). Smart grids or smart users? Involving users in developing a low carbon electricity economy. *Energy Policy* 52: 117-125.
- Wilhite, H. (2007). *Will efficient technologies save the world? A call for new thinking on the ways that enduse technologies affect energy using practises*, ECEEE 2007 Summer Study, La Colle sur Loup.
- Wilhite, H., E. Shove, L. Lutzenhiser and W. Kempton (2000). The Legacy of Twenty Years of Energy Demand Management: we know more about Individual Behaviour but next to Nothing about Demand. pp. 109-126 in E. Jochem et al. (Eds.) *Society, Behaviour, and Climate Change Mitigation*. Dordrecht: Kluwer Academic Publishers.
- Yudelson, J. (1999). Adapting Mccarthy’s Four P’s for the Twenty-First Century. *Journal of Marketing Education* April 1999 21: 60-67.

Section 3

- Accenture (2010). Accelerating successful smart grid pilots. World Economic Forum in partnership with Accenture. www.accenture.com
- ADDRESS (2011a). ADDRESS Deliverable 5.1- Description of market mechanisms (regulations, economic incentives and contract structures) which enable active demand participation in the power system, May 31, 2011. Available online: <http://www.addressfp7.org/config/files/ADD-WP5-ContractsMarketsandRegulation.pdf>
- ADDRESS (2011b). ADDRESS Deliverable 6.1 - Description of Test Location and Detailed Test Program for (limited) Prototype Field Test, Simulations and Hybrid Tests, July 31, 2011.

- Available online: <http://www.addressfp7.org/config/files/ADD-WP6-T6.1-D6.1-EDF-Description%20of%20test%20location%20and%20detailed%20test%20program.pdf>.
- ADDRESS (2013). Active Distribution Networks with full integration of Demand and distributed energy resources. <http://www.addressfp7.org/> accessed October 2013.
- ADEME (2002). “Des Solutions Alternatives au Renforcement des Réseaux en Zone Rurale: Témoignages et Enseignements sur une Opération de Démonstration en Maine-et-Loire”, ADEME, 2002. Available at: <http://paysdelaloire.ademe.fr/>
- Agsten, Michael et al. (2012). “eTelligence – New energy sources require a new approach”. eTelligence Project. Final Report, 2012. Available online: <http://www.e-energy.de/en/89.php>
- Albadi, M.H., and E.F. El-Saadany (2008). “A Summary of Demand Response in Electricity Markets.” *Electric Power Systems Research* 78, no. 11 (November 2008): 1989–1996. doi:10.1016/j.epsr.2008.04.002.
- Ayres, I., S. Raseman, & A. Shih (2009). Evidence from Two Large Field Experiments that Peer Comparison Feedback can Reduce Residential Energy Usage. 5th Annual Conference on Empirical Legal Studies Paper, Social Science Research Network Working Paper Series.
- Bartusch, Cajsa, Fredrik Wallin, Monica Odlare, Iana Vassileva, and Lars Wester (2011). “Introducing a Demand-based Electricity Distribution Tariff in the Residential Sector: Demand Response and Customer Perception.” *Energy Policy* 39, no. 9: 5008–5025. doi:10.1016/j.enpol.2011.06.013.
- Belhomme, R. (2013). “ADDRESS field tests in France“, presentation at the ADDRESS final workshop, EDF SA, Rome, May 23th, 2013. Available online: http://www.addressfp7.org/ws2013/morning/06-ADDRESS%20in%20field_France.pdf.
- Black, R., P. Davidson, & K. Retra (2009) Facilitating energy saving behaviours among university student residents. Institute for Land Water and Society, Report No. 53.
- Bourgain, G. (2009). ‘EU-DEEP tests’, September 2009. http://ec.europa.eu/research/conferences/2009/smart_networks/pdf/deep.pdf.
- Braithwait, S.D., D.G. Hansen, and L.D. Kirsch (2006). “Incentives and Rate Designs for Efficiency and Demand Response.” 2006. <http://drrc.lbl.gov/publications/incentives-and-rate-designs-efficiency-and-demand-response-0>.
- Breukers, S., and R.M. Mourik (2013). *The end-users as starting point for designing dynamic pricing approaches to change household energy consumption behaviours*. Report for Netbeheer Nederland, Projectgroep Smart Grids (Pg SG). DuneWorks, March 2013.
- Cappers, Peter, Charles Goldman, and David Kathan (2010). “Demand Response in U.S. Electricity Markets: Empirical Evidence.” *Energy* 35, no. 4 (April 2010): 1526–1535. doi:10.1016/j.energy.2009.06.029.
- CER (2011). Electricity Smart Metering Customer Behaviour Trials (CBT) Findings Report. Commission for Energy Regulation, Dublin, Ireland.
- CLNR (2013). Customer-Led Network Revolution. <http://www.networkrevolution.co.uk/default.aspx> accessed October 2013.
- Crossley, D. (2008). Worldwide Survey of Network-driven Demand-side Management Projects. Research Report. Task XV of the International Energy Agency Demand Side Management Programme. Australia: ENERGY FUTURES AUSTRALIA, 2008.
- Dam van, S.S. (2009). Smart and usable home energy management systems. Presented at: Proceedings of 6th International Symposium on Environmentally Conscious Design and Inverse Manufacturing, 2009.
- Darby, S. (2006). The effectiveness of feedback on energy consumption. A review for DEFRA of the literature on metering, billing and direct displays. Environmental Change Institute, University of Oxford, Oxford.
- Darby, S. (2010). Smart metering: what potential for householder engagement? *Building Research & Information* 38(5): 442-457.
- DECC (2012). “Demand Side Response in the domestic sector- a literature review of major trials”, Department of Energy & Climate Change, UK, August 2012.

- DOE (2006). “Benefits of Demand Response and Recommendations”, a Report to the United States Congress Pursuant to Section 1252 of the Energy Policy Act of 2005, Department of Energy, February 2006.
- Dong Energy (2012). The eFlex Project. Dong Energy, November 2012. <http://www.dongenergy-distribution.dk/SiteCollectionDocuments/eFlex/The%20eFlex%20Project-low.pdf>
- Dupont, B., C. De Jonghe, K. Kessels, R. Belmans (2011). “Short-term Consumer Benefits of Dynamic Pricing”, EEM conference, Zagreb, May, 2011.
- Dütschke, E., Paetz, A.-G. (2013). “Dynamic electricity pricing—Which programs do consumers prefer?”, Energy Policy, 2013. Available at: <http://dx.doi.org/10.1016/j.enpol.2013.03.025i>
- EC (2006). “Study on unbundling of electricity and gas transmission and distribution system operators, Annexes, Country Overview”. European Commission, 2006.
- EcoGrid (2013). EcoGrid EU. <http://www.eu-ecogrid.net> accessed October 2013.
- E-DeMa (2013). E-DeMa – development and demonstration of locally networked energy systems to the E-Energy marketplace of the future. <http://www.e-dema.de/en/> accessed October 2013.
- EEA (2013). Achieving energy efficiency through behaviour change: what does it take? (Rep. No. 5/2013). Copenhagen, Denmark: European Environment Agency.
- EG3 (2013). Expert Group 3 – Regulatory Recommendations for Smart Grid Deployment, First year Report “Options on handling smart grids data”, January 2013.
- Ehrhardt-Martinez, K., (2010). Advanced Metering Initiatives and Residential Feedback Programs: a meta-review for household electricity savings opportunities, ACEEE.
- Eissa, M.M. (2011). “Demand Side Management Program Evaluation Based on Industrial and Commercial Field Data.” Energy Policy 39, no. 10 (October 2011): 5961–5969. doi:10.1016/j.enpol.2011.06.057.
- EMeter Strategic Consulting (2010). PowerCents DC Program Final Report. Prepared for the Smart Meter Pilot Program, Inc.
- EPRI (2007). “Price Elasticity of Demand for Electricity: A Primer and Synthesis”, EPRI, Palo Alto, CA: 2007, 1016264.
- Faruqui, A., and Sergici, S. (2011). “Dynamic Pricing: Past, Present, and Future.” presented by The Brattle Group to the Canadian Association of Members of Public Utility Tribunals, Queen’s University, Kingston, Ontario, 2011. Available at http://brattle.com/_documents/UploadLibrary/Upload956.pdf.
- Faruqui, A., Hledik, R. and Sergici, S. (2009). “Piloting the Smart Grid”, The Electricity Journal, Vol. 22, Issue 7, Aug./Sept. 2009.
- Faruqui, Ahmad, and Jenny Palmer (2013). “The Discovery of Price Responsiveness—A Survey of Experiments Involving Dynamic Pricing of Electricity.” Available at SSRN 2020587 (2012). http://papers.ssrn.com/sol3/papers.cfm?abstract_id=2020587.
- Faruqui, Ahmad, and Sanem Sergici (2008). “The Power Of Experimentation New Evidence on Residential Demand Response.” The Brattle group.
- Faruqui, A. & Sergici, S. (2010). Household response to dynamic pricing of electricity: a survey of 15 experiments. Journal of Regulatory Economics, October 2010, Volume 38, Issue 2, pp 193-225.
- FENIX (2009). Flexible Electricity Network to Integrate the expected energy evolution. Results. <http://www.fenix-project.org/>.
- Fischer, C. (2008). Feedback on household electricity consumption: a tool for saving energy? Energy Efficiency 1:79–104.
- Fogg B., Cuellar G., Danielson D. (2009). “Motivating, Influencing, and Persuading Users: An Introduction to Captology.” In: Sears A., Jacko J. A., editors. The Human-Computer Interaction Handbook: Fundamentals, Evolving Technologies and Emerging Applications. New York: Taylor & Francis; 2009. pp. 133–46.

- Gantenbein, D., C. Binding, B. Jansen, A. Mishra, O. Sundström (2012). 'EcoGrid EU: An Efficient ICT Approach for a Sustainable Power System'. Sustainable Internet and ICT for Sustainability (SustainIT), 2012. Available at: <http://www.eu-ecogrid.net/>
- Gkatzikis, L., I. Koutsopoulos, T. Salonidis (in press). 'The Role of Aggregators in Smart Grid Demand Response Markets', to appear in IEEE JSAC- Special series on Smart Grid Communications.
- Gorsira, M., Steg, E.M., Bolderdijk, J.W., Keizer, K.E., & van der Werff, E. (2011). Hoe meer controle hoe beter? De rol van instellingsmogelijkheden bij aanschaf en gebruik van apparaten. Groningen: Rijksuniversiteit Groningen, Vakgroep Psychologie.
- Hammerstrom, D.J. (2007a). "Pacific Northwest GridsWise™ Testbed Demonstration Projects – Part I ,Olympic Peninsula Project.", October 2007.
- Hammerstrom, D.J. (2007b). "Pacific Northwest GridsWise™ Testbed Demonstration Projects – Part II. Grid Friendly™ Appliance Project", October 2007.
- Henryson J, Hakansson T and Pyrko J (2000). Energy efficiency in buildings through information – Swedish perspective. *Energy Policy* 28, 169-180.
- Jargstorf, J., Kessels, K., Belmans, R., (2013). "Capacity Based Grid Fees for Residential Customers", EEM conference, Stockholm, May, 2013.
- JRC (2011). Smart Grid projects in Europe: lessons learned and current developments Petten, The Netherlands: Joint Research Centre, Institute for Energy.
- Krishnamurti, Schwartz, Davis, Fischhoff, de Bruin, Lave & Wang (2012). Preparing for smart grid technologies: A behavioural decision research approach to understanding consumer expectations about smart meters. *Energy Policy* 41(2012)790–797.
- Lewis, P.E., Dromacque, C., Brennan, S., Stromback, J., Kennedy, D. (2012). Empower Demand 2: Energy Efficiency through Information and Communication Technology: Best Practice Examples and Guidance. VaasaETT Global Energy Think Tank. <http://www.esmig.eu/press/publications-new/empower-demand-report.pdf/view>
- LIPAedge (2013). "LIPAedge Direct Load Control Program", project website. Available at: <http://www.lipaedge.com/index.asp>
- Mahone, A. & Haley, B. (2011). Overview of Residential Energy Feedback and Behavior-based Energy Efficiency. Energy and Environmental Economics inc.
- Open meter (2011). Open meter project Deliverable 3.2: Specification of Open Meter OSI layers and Multimetering Networking Interfaces. <http://www.openmeter.com/>
- PEF (2003). Progress Energy Florida. "Petition of Progress Energy Florida for Approval of Modifications to Its Residential New Construction and Residential Energy Management DSM Programs." www.psc.state.fl.us/library/FILINGS/03/10458-03/10458-03.pdf.
- Peeters, E., R. Belhomme, C. Battle, F. Bouffard, S. Karkkaunen, D. Six. and M. Hommelberg (2009). "Address: Scenarios and Architecture for Active Demand development in the Smart Grids of the future", Proceedings CIRED 2009, Prague.
- Prügler, Natalie (2013). "Economic Potential of Demand Response at Household level—Are Central-European Market Conditions Sufficient?" *Energy Policy* (May 2013). doi:10.1016/j.enpol.2013.04.044.
- Pudjianto, D., C. Ramsay and G. Strbac (2007). 'Virtual power plant and system integration of distributed energy resources', *Renewable Power Generation, IET Volume: 1 , Issue: 1, 2007.*
- Ramos, A., Cedric De Jonghe, Daan Six, Ronnie Belmans (2013). "Demand Response Design Within Wholesale Electricity Markets," Proceedings 13th European IAEE Conference 2013, Dusseldorf.
- Simonite, Tom (2013). "Two men created the iPod and iPhone founded Nest and injected new technology into the humble thermostat. Now they have their sights on the rest of your house". In: MIT Technology Review, Vol. 116, no 2., pp. 28-31.
- Smart-A (2008). "Consumer acceptance of smart appliances", D 5.5 of Smart-A project, December 2008.

- SmartHouse/SmartGrid (2010). Smart Houses Interacting with Smart Grids to achieve next-generation energy efficiency and sustainability. Deliverable D1.1: High-Level System Requirements. Available at: <http://www.smarthouse-smartgrid.eu/>
- Staats H, Harland P, Wilke H, (2004). "Effecting Durable Change: A Team Approach to Improve Environmental Behavior in the Household" *Environment and Behavior* 36 341-367.
- Stromback, J., Dromacque, C., Yassin, M. H., (2011). Empower Demand. The potential of smart meter enabled programs to increase energy and systems efficiency: a mass pilot comparison. VaasaETT Global Energy Think Tank, Helsinki, Finland. <http://www.esmig.eu/press/filestor/empower-demand-report.pdf>
- Tant, P., B. Dupont, K. Vanthournout, T. De Rybel, E. Peeters, R. Belmans (2012). 'LINEAR Breakthrough project: Large-Scale Implementation of Smart Grid Technologies in Distribution Grids', IEEE PES ISGT Europe, Berlin, 2012.
- Toronto Hydro (2013a). "Peaksaver PLUS | Toronto Hydro Electric System." Accessed June 21, 2013. <http://www.torontohydro.com/sites/electricsystem/electricityconservation/residentialconservation/Pages/peaksaver.aspx>.
- Toronto Hydro (2013b). "PowerShift | Toronto Hydro Electric System." Accessed June 21, 2013. <http://www.torontohydro.com/sites/electricsystem/electricityconservation/residentialconservation/Pages/PowerShift.aspx>.
- Torriti, Jacopo, Mohamed G. Hassan, and Matthew Leach (2010). "Demand Response Experience in Europe: Policies, Programmes and Implementation." *Energy* 35, no. 4 (April 2010): 1575–1583. doi:10.1016/j.energy.2009.05.021.
- Vassileva ,I., Odlare, M., Wallin, F., Dahlquist, E. (2012). The impact of consumers' feedback preferences on domestic electricity consumption. *Applied Energy*, 93, (2012), 575–582.
- West, J. & Mace, M. (2010). "Browsing as the killer app: Explaining the rapid success of Apples' iPhone." *Telecommunications Policy* 34, pp. 270-286. doi: 10.1016/j.telepol.2009.12.002

Section 4

- Aarts, H., Verplanken, B., & Van Knippenberg, A. (1998). Predicting behaviour from actions in the past: repeated decision making or a matter of habit? *Journal of Applied Social Psychology*, 28, 1355–1374.
- Bartusch, Cajsa, Fredrik Wallin, Monica Odlare, Iana Vassileva, and Lars Wester (2011). "Introducing a Demand-based Electricity Distribution Tariff in the Residential Sector: Demand Response and Customer Perception." *Energy Policy* 39, no. 9: 5008–5025. doi:10.1016/j.enpol.2011.06.013
- Breukers, S., E. Heiskanen, R.M.Mourik, D. Bauknecht, M. Hodson, Y. Barabanova, B. Brohmann, V. Bürger, C.F.J. Feenstra, M. Jalas, M. Johnson, P. Maier, S. Marvin, H. Meinel, J. Pariag, M. Rask, S. Rinne, S. Robinson, S. Saastamoinen, J. Salminen, I. Valuntiene, E. Vadovics, (2009). Interaction schemes for successful energy demand side management. Building blocks for a practicable and conceptual framework. Deliverable 5 of the CHANGING BEHAVIOUR project. www.energychange.info
- Breukers, S., and R.M. Mourik (2013). *The end-users as starting point for designing dynamic pricing approaches to change household energy consumption behaviours*. Report for Netbeheer Nederland, Projectgroep Smart Grids (Pg SG). DuneWorks, March 2013.
- Darby, S., (2006). The effectiveness of feedback on energy consumption. A review for DEFRA of the literature on metering, billing and direct displays. Environmental Change Institute, University of Oxford, Oxford.
- Defra (2011). Framework for Sustainable Lifestyles. Centre of Expertise on Influencing behaviours. <http://archive.defra.gov.uk/environment/economy/documents/sustainable-life-framework.pdf>
- Dong Energy (2012). The eFlex Project, Dong Energy, November 2012. www.dongenergy.com.
- EEA (2013). Achieving energy efficiency through behaviour change: what does it take? (Rep. No. 5/2013). Copenhagen, Denmark: European Environment Agency.

-
- Ehrhardt-Martinez, K., (2010). Advanced Metering Initiatives and Residential Feedback Programs: a meta-review for household electricity savings opportunities, ACEEE.
- JRC (2011). Smart Grid projects in Europe: lessons learned and current developments Petten, The Netherlands: Joint Research Centre, Institute for Energy.
- Lewis, P.E., Dromacque, C., Brennan, S., Stromback, J., Kennedy, D. (2012). Empower Demand 2: Energy Efficiency through Information and Communication Technology: Best Practice Examples and Guidance. 2012 VaasaETT <http://www.esmig.eu/press/publications-new/empower-demand-report.pdf/view>
- NSMC (2011). Big Pocket Guide to using social marketing for behaviour change London, UK: The NSMC.
- Prügler, Natalie (2013). “Economic Potential of Demand Response at Household level—Are Central-European Market Conditions Sufficient?” *Energy Policy* (May 2013). doi:10.1016/j.enpol.2013.04.044.
- Rotmans, J. (2005). Societal Innovation: between dream and reality lies complexity. Inaugural Address, Erasmus University Rotterdam.
- Smart Grid Consumer Collaborative (SGCC) (2013). 2013 State of the Consumer Report. SGCC, available at <http://smartgridcc.org/>
- Sütterlin, B., Brunner, T. , Siegrist, M. (2011). Who puts the most energy into energy conservation? A segmentation of energy consumers based on energy-related behavioural characteristics. *Energy Policy* 39: 8137–8152.
- Verbong, G., Beemsterboer, S., Sengers, F. (2013). Smart grids or smart users? Involving users in developing a low carbon electricity economy. *Energy Policy* 52: 117-125.

Appendix: Do's, dont's and don't knows of end-user engagement - brainstorm results.

During the 1st S3C advisory board meeting (Brussels, September 12th 2013), participants were asked to brainstorm about what to do and what not to do when engaging end-users. Also, they were asked what they 'didn't know' or saw as unsure aspects in end-user engagement. Figure 34 and Figure 35 provide a clustering of the do's and dont's mentioned, on the basis of a previous version of the key success factors described in Section 4.3. Figure 36 defines a number of topical clusters to categorize the don't knows. The bullets in figures give examples of issues mentioned. The font size of the headings indicates the number of issues mentioned under that category.

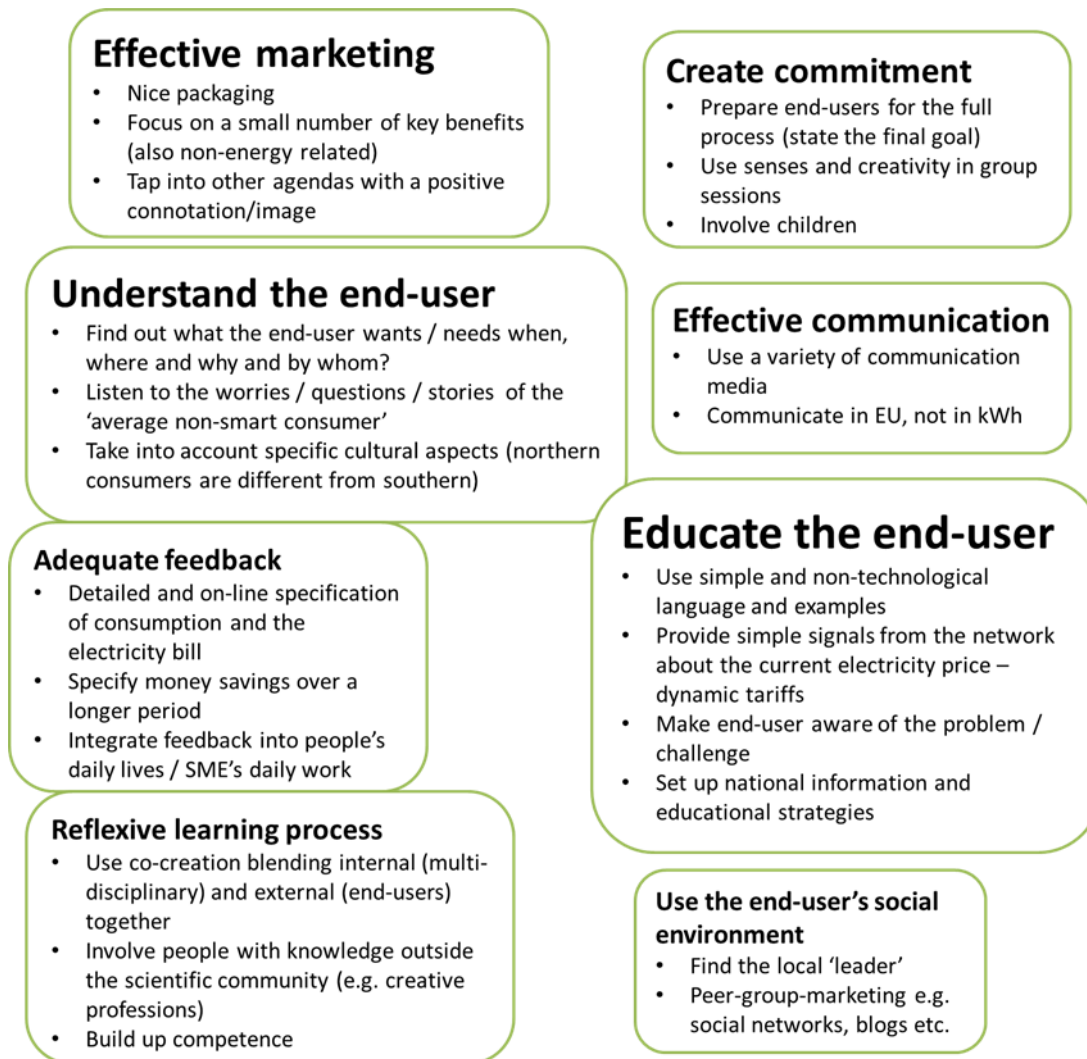

Figure 34: Do's in end-user engagement – brainstorm results

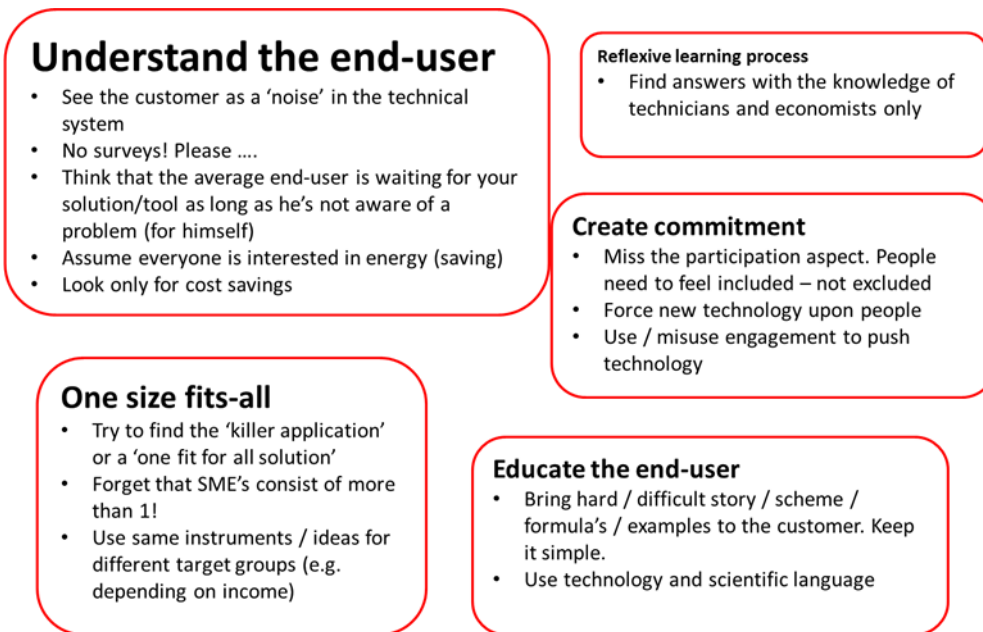

Figure 35: Don'ts in end-user engagement – brainstorm results

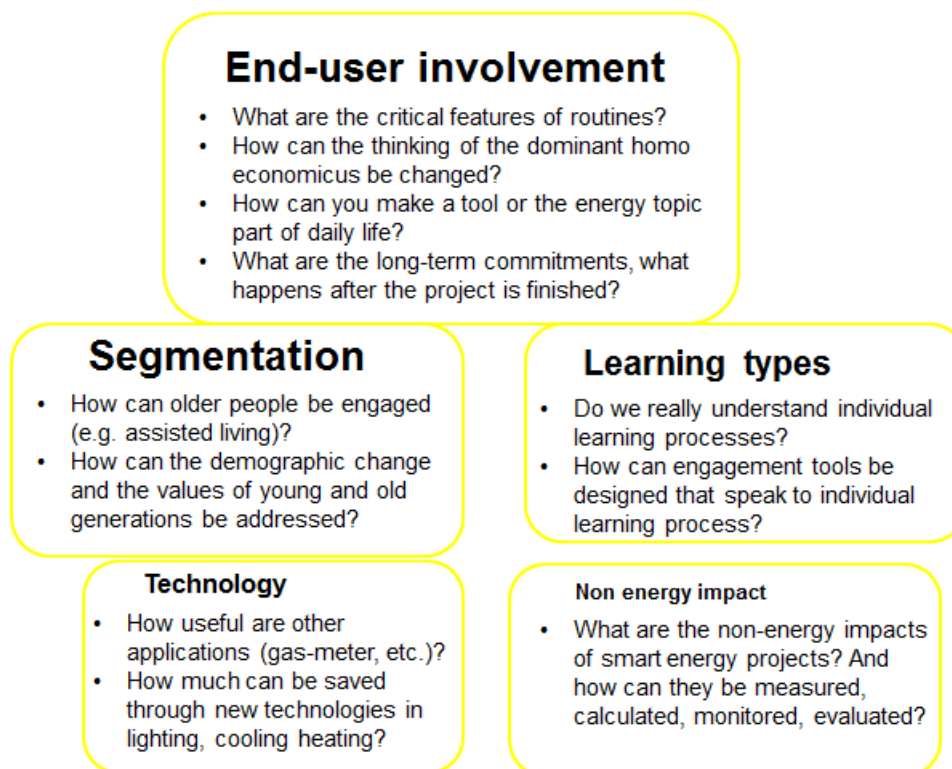

Figure 36: Don't knows in end-user engagement – brainstorm results