

## Features of an Energy Efficient Building

**M. V. Molykutty**

Professor

Department of Civil Engineering

Sri Sairam Engineering College, Chennai, Tamil Nadu, India

Email: Molykutty.civil@sairam.edu.in

### Abstract

*In this paper, a detailed discussion about energy, its types, forms, importance and need for its conservation are given. Energy use of a building, how is a building responsible for pollution and the needs for energy conservation are explained. The passive design components of energy efficient building are discussed. A detailed account on various innovative building materials and methods is given. "Building materials and methods" is a continuously improving research area. Building sector uses energy to a great extent but the silver line is that a large amount of energy can be saved in this sector. By adopting suitable materials and methods, a conventional building can be transformed to an energy efficient one. If all buildings adopt energy efficient strategies, building sector can positively contribute towards control of global warming and to its effects in a large extent.*

**Keywords:** Energy, Energy Efficient Building, Passive design components, Passive Heating and Cooling, Innovative building materials and methods, Insulation, Good housekeeping measures

### INTRODUCTION

Today's buzz word is energy conservation. Why have we to concentrate more on energy conservation in buildings?

We know that energy is the capacity of a physical system to do work. The total energy of a system remains constant and energy can be transformed from one form to the other. Energy is measured in joules

Energy is a critical component, in the entire process of evolution, growth and survival of all living beings and it plays a vital role in the socio-economic development and human welfare of a country.

Two basic types of energy are:

1. Potential energy: It is the energy possessed due to nature, position or state of the matter. Ex. Water stored in a dam possess potential energy

2. Kinetic energy: Energy associated with

motion Ex. Running train possess energy There are different forms of energy like light energy, chemical energy, sound energy, heat energy, electrical energy, solar energy, nuclear energy etc.

Following are the various classifications of energy sources:

1. Primary energy sources – These are the resources in their raw form that need to be processed for utilization.  
Ex: coal, crude oil, uranium ore etc.
2. Secondary energy sources - These are transformed primary energy sources in a form of final fuels or energy supply by means of many technological processes  
Ex: sized coal, refined crude oil products like gasoline, petrol, electricity etc.
3. Alternative energy sources –These are the sources which can be used as alternate sources with contemporary technologies. They can be renewable or non renewable sources and they can

be used beneficially.

Ex: wood - to substitute fossil sources and natural gas instead of crude oil products

4. Renewable energy resources – These are the energy resources that cannot be depleted in a very long time horizon and they seem to renew their capacity to infinite levels

Ex: solar energy, wind energy, ocean thermal energy etc.

5. Waste energy resources – These are the sources that can be reused economically in the same manner as materials are reused.

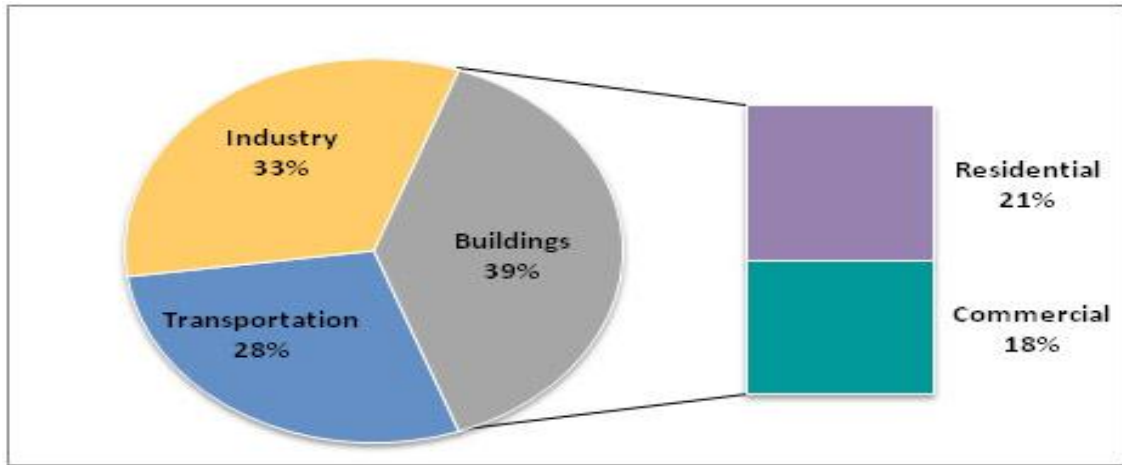
Ex: Heat energy from furnaces, ovens, and engine exhausts, turbine exhausts etc. can be recovered and reused for low heat process requirements. Most of our energy supply depends on coal, oil and natural gas but these fossil fuels are finite resources which get depleted with use and that means they are not renewable.

Fossil fuels cause air, water and soil pollution, and produce greenhouse gases like carbon dioxide, water vapour, methane, etc. which are the main contributors of global warming and subsequent global threats.

The various significant global environmental issues that we face today are Ozone layer depletion, Global warming and Loss of biodiversity. The main reason for all these undesirable phenomena are the emission of green house gases into the atmosphere. CO<sub>2</sub>, the main component of Green House Gases (GHG) is mainly emitted from thermal power production units which make use of fossil fuels. These green house gases form as a blanket around the earth and act like glass which will allow passage of the incoming shortwave solar radiation from the sun but not the reflected out going long wave solar radiation from the earth. So the heat gets trapped and this process increases the temperature above the earth's

surface. Consequently the global atmospheric temperature increases resulting in global warming. Urbanization and resulting impervious surfaces, further reflect more solar radiation and add to the increase in temperature. This increase in temperature causes more evaporation from water bodies, drought, melting of ice and sea level rise. The greenhouse gas also reacts with the UV protective ozone layer and reduces its thickness and some places produce ozone holes (a region of exceptionally depleted ozone in the stratosphere) which allow the entry of harmful ultraviolet rays from sun on to the earth. So we can see that the major culprit of environmental pollution is the excessive energy use. When we consume more energy, more energy is to be produced which increases pollution and its further effects. Hence, it is a dire need to find out ways and means to reduce these emissions and protect our environment from degradation and thereby securing the life of our own as well as our future generations which is called sustainable development. What is the way out? We must reduce our energy usage and switch over to renewable sources of energy for energy production and use, such as wind, solar and hydropower. They cause neither pollution nor produce greenhouse gases, and they will never get depleted. So the use of renewable source is the first step towards protection of environment from further degradation. We also know that the demand for energy is rising many folds as we look towards future.

If we consider, the total energy consumption in different service sectors, from fig (1), we can see that building sector consumes about 40% of our total energy consumption. This is true for India as well. But, there are lots of scopes for reducing the use of energy in the building sector. So if we take steps to reduce or conserve energy use in buildings, it can contribute a sizable amount towards energy conservation.



*Figure 1: Energy consumption in different service sectors (Source: U.S. Department of Energy (DOE)).*

### Energy use of a building

Broadly, the energy use of a building can be classified into two: embodied and operating energy. Embodied energy is the energy consumed by all processes like production of a building, from the processing of natural resources to manufacturing, transport and delivery of the final output. For example, in the case of a brickwall, embodied energy includes, the energy required to manufacture the bricks, transport them to site, lay them, plaster, paint and replaster over the life of the wall [1, 2]. Embodied energy is of two types: Initial embodied energy and recurring embodied energy.

The initial embodied energy in buildings represents the non-renewable energy consumed in getting the raw materials, their processing, manufacturing, transportation to site, and consequent construction process. This initial embodied energy has two components, direct energy and indirect energy.

Direct energy, the energy used for transportation of building materials to the site, and then to actually construct the building; indirect energy, the energy used to get, process, and manufacture the building materials, including energy spent for transportation connected to these activities.

The recurring embodied energy in buildings represents the energy consumed to maintain, repair, restore, renew or replace materials, components or systems during the life of the building.

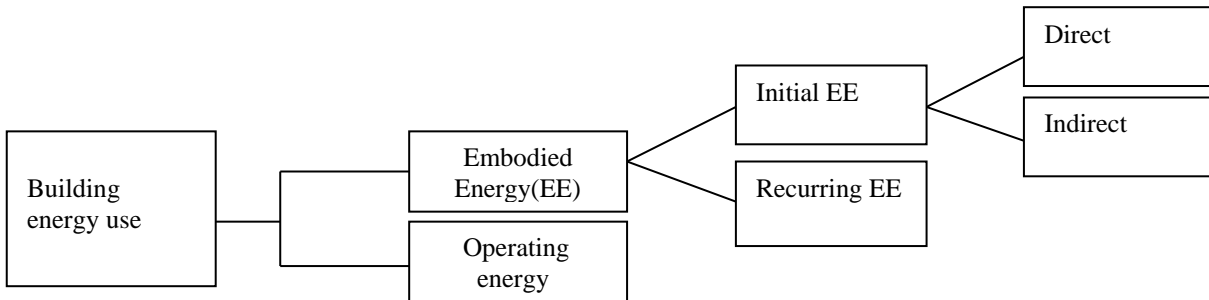
The operating energy of a building is “the amount of energy that is consumed by a building to satisfy the demand for heating, cooling, ventilation, lighting, equipment, and appliances”. Figure (2) shows the above energy classification.

Most of the above processes, energy is used in the form of electricity which is mainly produced from thermal power plants using fossil fuels. So wherever we use electricity, we indirectly cause pollution. The embodied energy consumption can be reduced by choosing locally available low energy intensive materials, which improve the comfort inside the building.

Operating energy is required during the entire lifetime of the building. The reduction in the usage of this energy depends on the meticulous planning of the building and the degree of energy consciousness of the people who use the building. We have to plan the building in such a way that the external energy required for our comfort conditions are minimum. To maintain better comfort, we

spend energy for heating, lighting, ventilation and air-conditioning. So we should plan the building in such a way that we get the maximum comfort by taking advantage of sun's energy. Sometimes

the building itself or some element of it can be made to take advantage of natural energy characteristics. This way of planning and designing the building comes under passive design.



**Figure 2:** Energy Use of a building.

**Passive design components**

Any measure taken to reduce or prevent the usage of non- renewable energy for a building's energy needs come under passive design. The various measures are dealt briefly in the following paragraphs.

**Orientation**

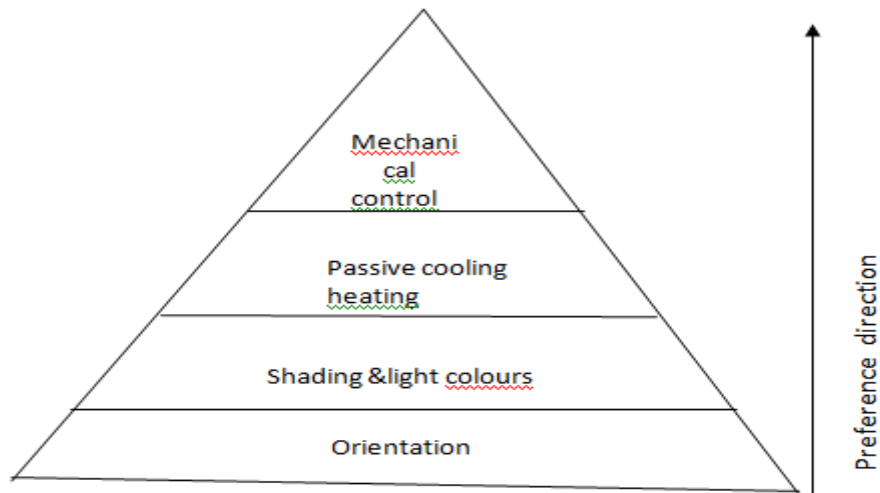
Building orientation refers to the way a building and its components are situated on a site to take advantage of natural energy sources. The best orientation is the one which receives maximum solar radiation during winter and minimum solar radiation during summer. Solar radiation per unit area is known for different latitudes on different days. So solar heat gained by the building surfaces at different directions due to different orientations can be found out. The values can be found out and compared for one representative coldest and hottest day in each orientation. The orientation which gives maximum heat during coldest day and minimum heat during hottest day is chosen as the best orientation. Sometimes if the same orientation does not satisfy both

conditions, then the orientation for the most preferred condition is to be selected, for example in a cold country, the orientation which gives max heat during winter should be selected. In a hot and humid region, the orientation which gives minimum solar heat during summer is to be selected.

But there are restrictions due to the plot availability and its shape. In such cases maximum suitable orientation is to be adopted and other higher level passive features like shading are to be adopted. Simulation software like Ecotect, DOE, REVIT, e-Quest Energy plus, ESP-r, TRNSYS etc. can be used to get the best orientation

**Shading**

Shading is a strategy to achieve comfort during summer. Maximum benefit is obtained when it is provided for windows. The four tier approach to be adopted for summer comfort in a building is depicted in Fig.3.

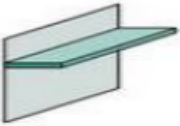
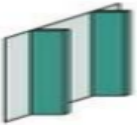
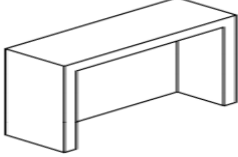

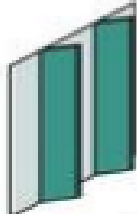
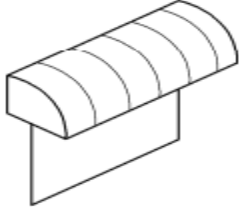
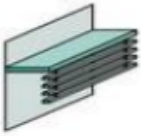







**Figure 3:** Four tier approach.

Different types of shading are available. Shades can be provided either exterior or interior. Interior shading consists of

curtains, blinds etc. Types of exterior shadings given in table 1

**Table 1:** Types of exterior shadings

Types		
Horizontal pannel	Vertical fins	Horizontal pannel with vertical fins
		
Horizontal louvers in horizontal plane	Slanting fins ( with and without adjustable type)	Awning
		
Horizontal pannel with louvers in vertical plane	Egg crate (vertical fins)	Tree shading during summer
		
Vertical pannel	Egg crate -slanting fins ( with and without adjustable type)	Tree shading during winter
		

Interior shading can be in the form of curtains or venetian blinds. Light colors will not absorb as much light as dark colors.

**Passive heating and cooling**

Passive heating and cooling design refers to the approaches that focus on heat gain and loss control and heat dissipation in a building which improve thermal comfort with low or no energy consumption.

Passive heating techniques include harvesting solar radiation when it is available and make use of it to heat space where it is required. Direct gain, indirect gain like Trombe wall, water wall, trans wall etc. and roof top collectors come under this.

Passive cooling includes ventilative cooling, cross ventilation, wind tower, induced ventilation, nocturnal cooling, evaporative cooling, passive downdraft evaporative cooling, roof surface evaporative cooling, roof pond, earth air pipe system etc. [3].

If any discomfort remains even after application of the lower three tiers, mechanical controls like heaters, air conditioning are resorted to.



**Innovative building materials and methods**

For a single storied building, the roof transmits more heat to inside than the walls do. For a multistoried building, walls transmit more heat and for uppermost floor, roof also contributes. Lot of research is going on to find a suitable wall and roof section to transmit less heat. The use of following materials will help to reduce embodied energy use of a building.





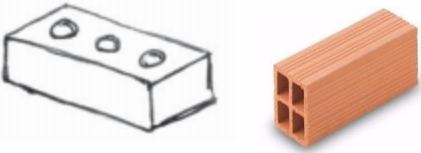
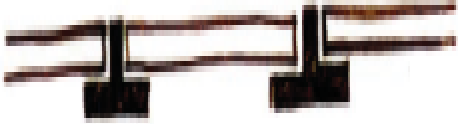
Autoclaved aerated concrete (AAC), fly ash, compressed earth blocks, clay red mud burnt bricks, lato blocks, precast hollow concrete blocks, bamboo/timber mat based walls, coconut fibre and wooden chips roofing sheets, cement bonded fibre roofing sheets, and micro concrete roofing tiles

The methods tried out are rat trap bonding, sand stone roofing, eco wall, perforated brick masonry, composite Ferro cement system, coconut fibre and wooden chips roofing sheets, stone Patti roofing, precast brick arch panel system, filler slabs, particle boards etc. The details of each materials and method are available in the notes prepared by MNRE [3] the pictorial view of above materials and methods are given in table (2)

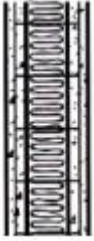

*Table 2: Innovative materials and methods*

Image	Description
	<p><b>Autoclaved aerated concrete</b> AAC blocks are made from a mixture of Portland cement, lime, silica sand or fly ash, water and aluminium powder or paste. It is a stable, non-polluting, fire resisting, thermally and acoustically insulating, and durable material.</p>
	<p><b>FAL-G bricks</b> Fly ash bricks can replace burnt clay bricks, which require use of fertile agricultural soil. The name FaL-G stands for fly ash (Fa), Lime (L) and Gypsum (G) which are its ingredients.</p>

	<p><b>Compressed earth blocks</b></p> <p>The soil for compressed earth blocks consists of a mixture of pebbles (1.5 parts), sand (5 parts), silt (1.5 parts) and clay (2parts). About 5 % cement is used to stabilise the earth blocks.</p>
	<p><b>Precast hollow concrete blocks</b></p> <p>Precast hollow concrete blocks are manufactured using lean cement-concrete mixes and moulded in block making machines of the egg laying or static types. The cavities in the blocks provide better thermal protection. These can be used as walling blocks or as roofing blocks along with inverted precast tee beams.</p>
	<p><b>Bamboo/timber mat based walls</b></p> <p>These walls are made up of bamboo mat placed between horizontal and vertical timber/bamboo frames. The plastering is done using mud or cement mortar on either side. These are not loading bearing and need supporting structure.</p>
	<p><b>Ferro cement panel</b></p> <p>The system is simple to construct and is made of Ferro cement which is a rich mortar reinforced with chicken mesh and welded wire mesh. These reduce the wall thickness and allow a larger carpet area. Precast Ferro cement units in trough shape are integrated with RCC columns. Since its wall thickness is less its thermal properties are to be studied in detail.</p>
	<p><b>Micro concrete roofing tiles</b></p> <p>Micro concrete roofing tiles are made of graded cement mortar layer and formed over sloping mould. They are used in pitched roofing systems and are less expensive than ACC/CGI sheets. These tiles are appropriate where fired clay tiles are not available. Thermal properties of these layers are to be studied.</p>
	<p><b>Stone Patti roofing:</b></p> <p>Stone Patti roofing is a flat roofing system with sand stone slabs (patties) resting over steel or slender RCC section beams. The slabs are overlaid with terracing for insulation. This type of roofing is appropriate where (sand) stone slabs are available, and is more economical than RCC slab. The thermal properties are to be studied in detail.</p>

	<p style="text-align: center;"><b>Filler slabs</b></p> <p>Filler slabs are normal RCC slabs in which bottom half or tensile concrete portions are replaced with filler materials like bricks, tiles, cellular concrete blocks, etc. Since for a simply supported slab the upper part is subjected to compressive stress which is borne by concrete and lower part is subjected to tensile stress which is taken care of by the steel reinforcement, the bottom concrete has not much function to perform. Filler materials are placed in such a way that it will not affect the structural strength of the slab; they replace unwanted or non-functional tension concrete, to save economy. Different types of filler materials are tried like tiles, coconut shells, earthen pots, plastic balls etc. Clay products are found to give reduced inside temperature.</p>
	<p style="text-align: center;"><b>Earthen pots as filler slab</b></p> <p>Here earthen pot is placed as filler slab which is a good thermal insulator</p>
	<p style="text-align: center;"><b>Tile filler slab</b></p> <p>Tiles which are also clay product and good thermal insulator is used as filler material</p>
	<p style="text-align: center;"><b>Rat trap bond</b></p> <p>The rat trap bond is an economical alternative brick bonding system for English and Flemish bond. Here the bricks are placed vertical. It is economical, strong and aesthetically appealing. The rat trap bond is simple to build and has better insulation properties. In this construction, due to cavity formed at center, 30% material (brick and mortar) is saved and thus overall construction cost is reduced. Cavity provides effective thermal and sound insulation. This makes rat trap bond energy and cost efficient building technology.</p>
	<p style="text-align: center;"><b>Perforated brick masonry</b></p> <p>These are made of high strength hollow bricks with 50-60 percent perforations.</p>
	<p style="text-align: center;"><b>Sand stone roofing</b></p> <p>This consists of 25mm thick stone slabs on pre-cast RCC beams or iron sections</p>



	<p style="text-align: center;"><b>ECO wall</b></p> <p>This wall assembly consists of a 100mm Expanded polystyrene panel finished with 50mm shotcrete on both sides, reinforced by wire mesh. The 200mm thick. Panel saves space and provides excellent insulation. This may be used both for walling &amp; roofing.</p>
	<p style="text-align: center;"><b>Geopolymers</b></p> <p>Geopolymers are a class of synthetic aluminosilicate materials with potential use essentially as a replacement for Portland cement. They are also available as panels. Geopolymer concrete is made by making use of waste materials such as fly ash and ground granulated blast furnace slag. Fly ash based geopolymer concrete has superior strength and mortar / plaster made from it does not require curing</p>





Ref: [3] & [4]

### INSULATION

Bulk insulation resists or slows down the transfer of heat by conduction and convection. The material traps air, slowing down or lowering the flow of heat or heat transfer. Bulk insulation includes

materials such as glass fiber, slag wool, rock fiber, cellulose fiber, polyester fiber, polystyrene, polyurethane and polyisocyanurate, a pictorial view of which is shown in table (3).

*Table 3: Types of bulk insulation*

Image	Description
	<p style="text-align: center;"><b>Glass Fiber</b></p> <p>(Glasswool) manufactured from molten glass spun and formed into mats, Rolls and blankets of fine fibers coated with a binding resin.</p>
	<p style="text-align: center;"><b>Mineral Wool</b></p> <p>(Slag/Rock Wool/Stonewool) manufactured from molten industrial slag, Which is fiberized, treated with oil and binders to suppress dust, and maintain shape.</p> <p>R-Value (represents thermal resistance of a material) per unit thickness is higher than glass fibers</p>
	<p style="text-align: center;"><b>Polyester Fiber</b></p> <p>is made from polyester fibers spun into a flexible mat.</p>
	<p style="text-align: center;"><b>Polyester Fiber batts</b></p> <p>or ceiling panels are produced using a mix of virgin and recycled polyester fiber, or Kenaf, a Renewable plant fiber which is thermally bonded.</p>

	<p><b>Cellulose Fiber insulation</b> is made from finely shredded recycled paper which is milled into a light fibrous matrix, This is chemically treated to resist fire and fungal growth.</p>
	<p><b>Vermiculite</b> is a mineral closely related to mica, which when heated expands to form a Light weight exfoliated material with insulating properties.</p>
	<p><b>Expanded Polystyrene</b> (EPS) is a lightweight, plastic foam insulation produced by trapping small amounts of pentane gas into solid beads of polystyrene</p>
	<p><b>Extruded Polystyrene (XPS)</b> is a closed cell polystyrene foam board, Which retains gas but not water</p>
	<p><b>Polyurethane and Polyisocyanurate</b> insulations are manufactured by chemical reactions between poly-alcohols and isocyanurates Creating or forming tiny air cells. The cells Contain refrigerant gases (fluorocarbons) instead of air.</p>
	<p>Phenolic Foam is manufactured from phenol formaldehyde Resin. It is available either as an open or closed Cell product. The boards usually come With a foil facing on one or both sides.</p>
	<p><b>Polyurethane Foam</b> is closed cell foam, which is usually pale yellow in color, and can be used for A variety of spray applications.</p>
	<p><b>Reflective Foil Insulation materials:</b> They are often Aluminium Foil laminates with reinforcement strands or low density polyethylene bubble encapsulated with air Laminated to foil supplied in rolls.</p>

*Ref: source [5]*

**Energy efficient Building wall and roof sections**

Generally insulation will be added to the existing brick wall either internally or

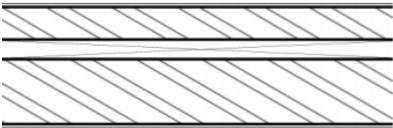
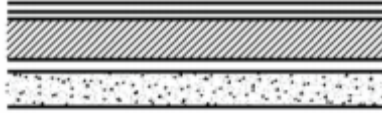
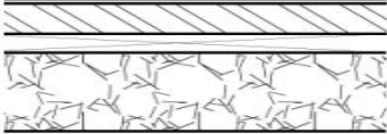
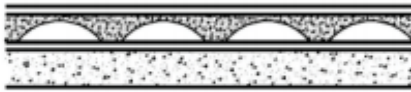
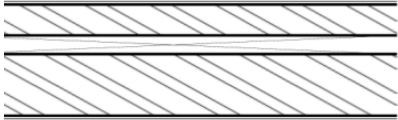
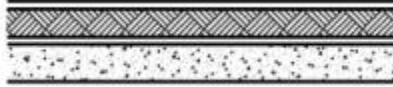

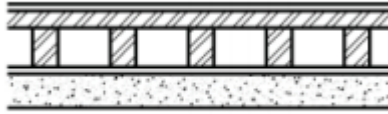

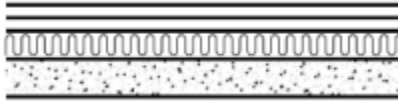
externally as there is no cavity provided within. Framed walls can have cavity, which can be insulated. Insulation is added internally by drilling small holes through

the inside wall finish and the insulation is blown or injected directly into the wall. The holes must then be completely plugged and sealed.

Most types of exterior siding can be drilled, lifted or removed to access the stud

wall behind. For new constructions, insulation can be provided along with brick construction. Air gap can also be provided to make it more thermally resistant. Some of the insulated wall and roof cross sections are given in table (4).

**Table 4: Wall and roof assembly**

WALL ASSEMBLY	ROOF ASSEMBLY
 <p>230mm brick wall + 70mm air cavity + 115mm brick Wall + 12mm plaster both sides</p>	 <p>RCC slab + 50mm (avg. thickness) brickbat coba + 20mm cement mortar finish</p>
 <p>300mm stone wall + 70mm air cavity + 115mm brick Wall + 12mm plaster one side</p>	 <p>RCC slab + 75mm Inverted earthen pot in lime concrete + 20mm cement mortar finish</p>
 <p>230mm FAL G + 70mm air cavity + 115mm FAL G + 12mm plaster</p>	 <p>RCC slab + 75mm mud phuska + 20mm cement mortar finish</p>
 <p>20mm stone cladding + 300mm AAC + 12mm plaster</p>	 <p>RCC slab + 75mm brick laid at intervals of 230mm c/c + brick tile covering + 20mm cement mortar finish</p>
 <p>230mm bk. wall + 50mm XPS + 115mm bk. Wall + 12mm plaster both sides</p>	 <p>RCC slab + 100mm PUF + waterproofing + Marble crazy</p>

Source: [4]

Other aspects like rain water harvesting, gray water treatment and use of treated water for irrigation, use of low flow fixtures, adopting renewable energy sources for electricity production and usage should be implemented

Give least preference to mechanically operated comfort control devices like HVAC systems.

### **Good housekeeping measures**

The following are some of the good housekeeping measures in the energy conservation point of view.

- Unplug electrical appliances when not in use
- Don't unnecessarily waste water while using
- Close all doors and windows when ac is switched on
- Unless it is very urgently needed don't use ac and manage with fan
- Open the doors and windows when fresh air is available

### **CONCLUSIONS**

About 40% of electricity usage of our country goes to buildings. But there is lot of scope for reduction of energy usage in buildings by implementing the above energy efficient materials and methods. Every one of us should be aware of the consequences of energy usage and the importance of energy conservation. If all of us do our might to reduce energy usage, surely we can save a sizable amount and subsequently can save our planet and pave

the way for sustainable development.

### **REFERENCES**

1. Richard, Haynes, Embodied Energy Calculations within Life Cycle Analysis of Residential Buildings. <https://www.etooglobal.com/wp.../10/Embodied-Energy-Paper> Richard-Haynes. PDF, pp. 1-16, 2010.
2. Manish K. Dixit et. al., Embodied Energy in Buildings: Need for a Measurement Protocol, pp. nil, [http://faculty.arch.tamu.edu/media/cms\\_page\\_media/3141/Manish\\_Solis%20Measurement%20Protocol%20Need%20202.pdf](http://faculty.arch.tamu.edu/media/cms_page_media/3141/Manish_Solis%20Measurement%20Protocol%20Need%20202.pdf)
3. Principles of energy conscious design by MNRE, Chapter 3, pp. 1-109.
4. <https://www.scribd.com/document/331167498/4-Principles-of-Energy-Conscious-Design>.
5. Integrated green design, Central Public Works Department for Urban & Rural Buildings in Hot-Dry Climate Zone, Central Public Works Department 101 A, Nirman Bhavan, New Delhi-11001, pp. 1-36, <http://cpwd.gov.in/Publication/IGDBooklet.PDF>, 2013
6. The guide to energy efficient thermal insulation, AAAMSA group, pp 3-57, August 2010.
7. <https://www.aaamsa.co.za/images/Technical%20Publications/TIASA/TIASA%20GUIDE%202010%20Low%20Res.pdf>.