

**IAC-18.B3.7. x 47710**

*HUMAN SPACEFLIGHT SYMPOSIUM (B3)*

*Advanced Systems, Technologies, and Innovations for Human Space Flight (7)*

**EDEN ISS – A SIMULATION TESTBED TO AN ADVANCED EXPLORATION DESIGN  
CONCEPT FOR A GREENHOUSE FOR MOON AND MARS**

**Barbara Imhof<sup>a\*</sup>, Irene Lia Schlacht<sup>c</sup>, René Waclavicek<sup>a</sup>, Daniel Schubert<sup>b</sup>, Conrad Zeidler<sup>b</sup>, Vincent Vrakking<sup>b</sup>, Waltraut Hoheneder<sup>a</sup>, Molly Hogle<sup>a</sup>**

<sup>a</sup> LIQUIFER Systems Group, Obere Donaustraße 97-99/1/62, 1020 Vienna, Austria;  
barbara.imhof@liquifer.com, rene.waclavicek@liquifer.com, waltraut.hoheneder@liquifer.com,  
molly.hogle@liquifer.com

<sup>b</sup> German Aerospace Center, Robert-Hooke-Strasse 1, Bremen, Germany, daniel.schubert@dlr.de,  
conrad.zeidler@dlr.de, vincent.vrakking@dlr.de

<sup>c</sup> Extreme-Design.eu research group, Irene.Schlacht@mail.polimi.it

\* Corresponding Author

**Abstract**

This paper takes the EDEN ISS project as example to demonstrate how findings from greenhouse tests and a 12-month mission simulation in Antarctica can inform the design for a future lunar or Martian exploration greenhouse and presents design solutions. EDEN ISS, a four-year EU-H2020 project coordinated by the German Aerospace Center Bremen, is a Ground Demonstration of Plant Cultivation Technologies for Safe Food Production in Space. EDEN ISS project partners developed an advanced nutrient delivery system, a high-performance LED lighting system, a bio-detection and decontamination system and food quality and safety procedures and technologies. A mobile two-container-sized greenhouse test facility was built to demonstrate and validate different key technologies and procedures necessary for safe food production within a (semi-)closed system. EDEN ISS is currently installed next to the German Neumayer Station III in Antarctica and serves as an over-winter-test-bed for providing fresh vegetables to the crew's diet. Intermediate outcomes from the Antarctic test include engineering, technology and crew experience facts and will inform the extra-terrestrial greenhouse design.

The paper outlines the current research and expedition status and references design concepts for exploration greenhouses which are relevant to the further development of EDEN ISS into a concept for future mission exploration on the moon and on Mars. The reference examples will serve as input to the concurrent design study planned for January 2019 where the team around DLR, Thales Alenia Space and LIQUIFER Systems Group will convene to finalise the EDEN ISS project from a future perspective point of view. They will look at integrating lessons learnt for architectural aspects, system performance, crop yield, crew acceptance and contamination. Concurrent engineering, used as methodology, will support the synthesis of the findings and at the same time will ensure the reflection of this information in the design proposals.

**Keywords:** greenhouses, life-support systems, vegetables, extreme environments, food independence, future exploration

**Acronyms/Abbreviations**

Command and Data Handling System (CDHS)  
Heating, Ventilation, Air Conditioning (HVAC)  
International Standard Payload Rack (ISPR)  
In-Situ Resource Utilisation (ISRU)  
International Space Station (ISS)  
Low-Density Polyethylene (LDPE)  
Mars-Lunar Greenhouse (MLGH)  
Nutrient Delivery System (NDS)  
Power Control and Distribution System (PCDS).  
Pre- and Post-Processing System (PPPS)  
Self-Deployable Habitat for Extreme Environments (SHEE)  
Thermal Control System (TCS)

**1. Introduction**

The EDEN ISS (Evolution and Design of Environmentally-closed Nutrition-sources) is the first bio-regenerative greenhouse made in Europe and tested in Antarctica for Earth and space applications. In this paper the unique features of this project are described in comparison with other selected case studies with a similar size or use with similar grow systems such as hydroponics or aeroponics. This paper displays possible field references and recommendations from a first investigation into selected case studies.

## 2. EDEN ISS

The aim of the EDEN ISS project is to advance controlled environment agriculture technologies beyond the state-of-the-art. It focuses on the demonstration of plant cultivation technologies and their applications on earth and in space. EDEN ISS project partner develop safe food production for on-board the International Space Station (ISS), for future human space exploration vehicles and planetary outposts and for terrestrial applications in dense cities or remote areas.

In long-duration human exploration, it is critical to supply edible food for crewmembers. Therefore, cultivating food in closed-loop systems becomes integral to future missions.

There are 14 partners collaborating to achieve the goals of the EDEN ISS project:

- DLR German Aerospace Center, Germany
- LIQUIFER Systems Group, Austria
- National Research Council, Italy
- University of Guelph, Canada
- Alfred Wegener Institute for Polar and Marine Research, Germany
- Enginsoft S.p.A., Italy
- Airbus Defence and Space, Germany
- Thales Alenia Space Italia S.p.A., Italy
- Arescosmo S.p.A., Italy
- Wageningen University and Research, the Netherlands
- Heliospectra AB, Sweden
- Limerick Institute of Technology, Ireland
- Telespazio S.p.A., Italy
- University of Florida, USA

The plant cultivation technologies were first tested in a laboratory setting at the sites of the consortium partners. All systems were integrated at DLR in Bremen, followed by an extensive test period. In October 2017, the complete facility was shipped to the German Neumayer III station in Antarctica. The station is operated by the Alfred-Wegener-Institute and has unique capabilities and infrastructure for testing plant cultivation under extreme environmental and logistical conditions.

Since February 2018, the container-sized greenhouse of the EDEN ISS project provides fresh vegetables for the Neumayer Station III crew in the overwintering period of 2018. The container is located 400 metres South of the main station and can be reached per foot along a secured trail with a railing so one can also find the way during white-out periods and the completely dark winter. It went into operation in January 2018 and after more than half a year of operation in Antarctica, the self-sufficient greenhouse

concept appears to be effective in producing a high-yield of fresh vegetables, and is currently providing self-grown food to the 10-member overwintering crew in the Neumayer Station III.

A closed greenhouse makes it possible to produce crops independently of the weather, the sun and the season, while enabling lower water consumption, as well as the abandonment of pesticides and insecticides. This can be key in solving global food production, which is one of the key societal challenges of the 21st century. A rising world population and simultaneous upheavals caused by climate change require new ways of cultivating crops, even in regions with unfavourable climatic conditions [REF 1. EDEN ISS consortium].



Figure 1: EDEN ISS greenhouse in Antarctica 400m South of the Neumayer Station III, credit: EDEN ISS consortium, photo: DLR, 2018.

### 2.1 Components of EDEN ISS

There are three main built components in EDEN ISS; the greenhouse, where the plants are grown, the service section where the harvest is processed so it can be taken to the Neumayer Station and the cold porch which is an intermediary zone, translating from the outside temperatures of approximately -30 to -40 Degrees Celsius to the inside temperature of +20 degrees Celsius.

- Cold Porch: houses a wardrobe for changing clothes and serves as entrance zone.
- Service Section: is a laboratory equipped with most of the systems, the nutrient delivery system for the aeroponic instalments in the greenhouse, the air management system, the control systems including a display. Further there is a window towards the Neumayer Station III and in front of it a desk and a sink to investigate the harvest and prepare it for taking it to the main facility.
- Greenhouse: is equipped with a aeroponic cultivation area of approximately 13 m<sup>2</sup> in shelves and trays, the roots in the trays and fed by a nutrition solution every 10 minutes. Further, above the trays, a high-performance LED lighting system is installed and overall a bio-detection and

decontamination system to ensure food quality and safety.

Figure 2: displays a bird's eye visualisation of the two-container EDEN ISS facility. Figure 3 shows a recent photo take form inside the greenhouse. Figure 4 shows the inside of the Service Section as installed in Bremen for testing 2017.



Figure 2: EDEN ISS greenhouse facility, credit: EDEN ISS consortium, visualization: LIQUIFER Systems Group



Figure 3: Inside the EDEN ISS greenhouse in Antarctica, credit: EDEN ISS consortium, photo: DRL, 2018



Figure 4: EDEN ISS Service Section, credit: EDEN ISS consortium, photo: Bruno Stubenrauch, 2017

## 2.2 Methodology used

The methodology used for this project where microbiology scientists, space engineers, programmers, technologists and architects came together is concurrent engineering. The facility was collaboratively designed in two one week concurrent design workshops. The Antarctic test period yields the research findings which were carefully set-up in the years prior to the expedition. Measurable outcomes are the quantities of vegetable, further data on microbiological investigations for food quality and safety, feed-back on an operational level and psychological findings through questionnaires.

## 2.3 Description of current research status

The latest results from Antarctica revealed that the following crops have been grown and harvested: 77 kilograms of fresh lettuce, 51 kilograms of cucumbers, 29 kilograms of tomatoes, 12 kilograms of kohlrabi, 5 kilograms of radishes and 9 kilograms of herbs. That makes approximately 7kg-8kg of vegetables per week. Especially, lettuce, tomatoes, cucumbers and herbs thrive especially well under the conditions of 21 degrees Celsius, and 65 percent relative humidity in the greenhouse.



However, artificial pollination is difficult to achieve inside the greenhouse, which has affected the success of red pepper and strawberry growth. The flowering of the plants is successful, however only a small percentage of these turn into edible mass.

Maintaining greenhouse technology under the harsh Antarctic conditions poses special challenges, and immediate repair is critical. Paul Zabel, the EDEN ISS engineer for DLR mans the greenhouse outpost which is essential because every now and then small repairs and glitches need to be taken care of. He manages 40 experiments and validation tests that are currently running. Further he is extensively analysing the cultivation of the vegetables including their yield and quality, collecting microbiological samples, and periodically checking all systems, including light, temperature regulation, and the nutrient- and carbon dioxide-enriched air supply.

In addition, Zabel is documenting how fresh food is affecting the health of the overwintering team members.

The Control Centre is stationed at DLR Bremen and the engineers monitor the greenhouse when severe Antarctic storms prevent Zabel from making the 400-metre outdoor trip from the Neumayer Station III to the greenhouse. The control centre receives daily images of individual plant trays, accessed through 32 cameras. All EDEN ISS researchers have access to these images, and can advise Zabel of any changes that need to be made.



Figure 5: Paul Zabel in the greenhouse in Antarctica, credit: EDEN ISS consortium, photo: DLR, 2018



Figure 6: Radish in the greenhouse, credit: EDEN ISS consortium, photo: DLR, 2018

## 2.4 Greenhouse designs for exploration

EDEN ISS demonstrated successfully that plants can grow in a semi-closed and semi-autonomous system under extreme conditions in Antarctica. In addition, the EDEN ISS container has already a nearly fully functional ISS experiment on-board fitting into an ISPR – see Figure 7. Tomatoes and lettuce are currently being grown in this extra experiment in the Antarctic test phase.



Figure 7: EDEN ISS rack demonstrator, credit: EDEN ISS consortium, photo: Bruno Stubenrauch, 2017

Part of the project development – still underway – is the next logical step: anticipating a future on an extra-terrestrial surface. This could be for the Martian human missions and closer in time for a lunar base. In January 2019, a final concurrent design exercise addressing a future scenario and conceiving a feasible option for a greenhouse on the moon and on Mars will be conducted.

## 3. Case Studies

In this Section, four case studies which are similar in approach will be looked at to draw recommendations for a future exploration greenhouse.

### 3.1 Case Study 1 - MarsPort 2002

MarsPort 2002 is an evolutionary deployer greenhouse for extreme environment related to the concept of a highly engineered hydroponic and aeroponic systems [Ref 2 - Munson, 2002]. The 3m long octagonal prism comprises multi-tray-levels and a

fully automated harvest robot (see Figure 10). It houses plants and subsystems such as water and nutrient delivery, plant growth structures, harvesting, crop processing, environmental controls, waste management, crop delivery, computing and communication and power.

The growth area of the combination of hydroponics and aeroponics systems is estimated as 6m<sup>2</sup> with LED and natural light. EDEN ISS has double the growth area so two of the MarsPort2002 would be equivalent to the greenhouse studied in this paper. The actual processes in the greenhouse will begin 130 days before the astronauts arrive. Additional structures are needed for a larger settlement, deployable structures are not foreseen, and neither an option is displayed that shows how this concept could function at a larger scale. For landing on Mars the structure will need to be tipped to be able to stand longitudinal on its own feet. The greenhouse is designed to be positioned on Mars within ±15° of the equator.

Figure 8 displays the ISRU concept: how the Martian atmosphere can be used for the Life Support System supporting the greenhouse and Figure 9 takes a look at the water cycle for the hydroponic system. The water is anticipated to come from Mars.

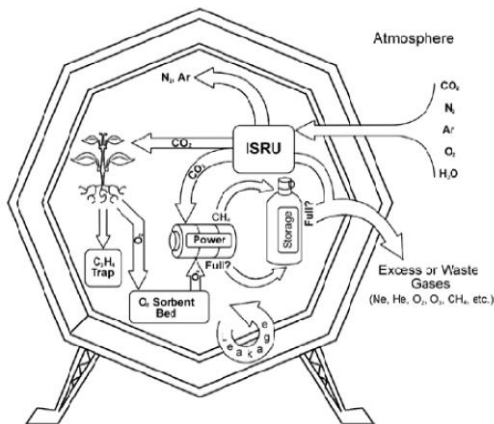

Figure 8: Diagramme explaining the loop of the life support system, credit: S. T. Munson

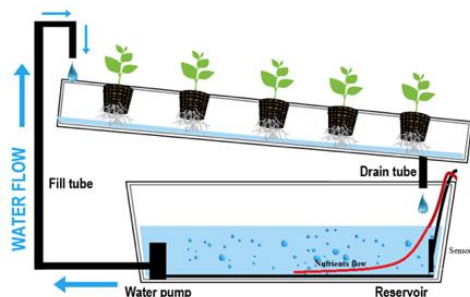

Figure 9: Diagram explaining the loop of the hydroponic system, credit: S. T. Munson

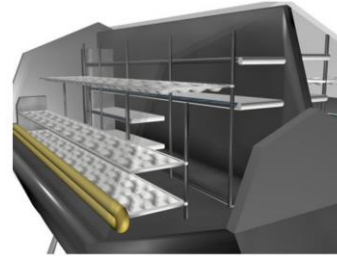

Figure 10: Sketches of the overall geometry, credit: S. T. Munson

### 3.2 Case Study 2 – Greenhouse in SHEE

The SHEE (Self-deployable Habitat for Extreme Environments) habitat was developed, built and tested as part of a European Framework Programme call with 7 partners. It is made to be used as experimental platform and habitat on earth in moon or Mars simulations (see Figure 11) [Ref. 3 – Osborne, 2016].

SHEE is a rigid segment deployable habitat test-bed designed for use in space analogous environments. The objective of the SHEE project was to develop a self-deployable habitat test-bed that will support a crew of two for a period of up to two weeks in duration. During this time the habitat will provide for all of the environmental, hygiene, dietary, logistical, professional, and psychological needs of the crew. For habitat simulation purposes and for other research, SHEE can be moved to various terrestrial analogue sites by standard commercial, thus cost effective, transportation. Testing of the habitat included subsystems performance, interior operations, and effectiveness of the SHEE habitat as a self-deployable and foldable autonomous system. [Ref. 4 – Imhof, 2016]

SHEE has a diameter of 6 m and a height of approximately 3 m with a surface area of 28 m<sup>2</sup> and a volume of 50m<sup>3</sup>. Its shape and the stowed configuration is designed such it could be transported in a rocket shroud to the moon or Mars so the scale, dimensions and shape presents mission realistic proportions. Therefore, the design study to see whether a greenhouse such as EDEN ISS could be incorporated into the



habitat envelope is a valid approach. Only 0.5 m<sup>3</sup> less could be incorporated into SHEE than into the EDEN ISS Future Exploration Greenhouse.



Figure 11: SHEE simulation habitat as part of project MOONWALK during a Mars simulation I Rio Tinto, Spain, 2016, credit: MOONWALK consortium, photo: Bruno Stubenrauch

Foreseen are shelves and trays for smaller plants up to 24 cm of height (lettuce, chives etc.) middle range plants with up to 76 cm of height (Swiss chard or kohlrabi) and taller plants such as cucumbers with a height of up to 155 cm. Lights would be placed on top of the trays. The air management, nutrition delivery system, control computers could be installed in the core of the space (including double floor and ceiling area – see Figures 12 - 15) while the shelves and trays would be deployable and would be prepared once the habitat is fully deployed.

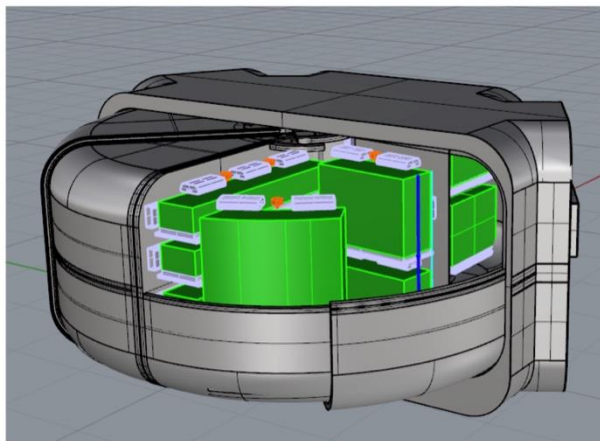

Figure 12: EDEN ISS systems in the SHEE habitat, credit: LIQUIFER Systems Group, 2016

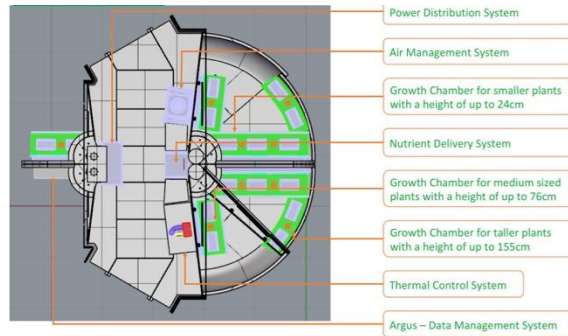

Figure 13: EDEN ISS systems in the SHEE habitat top view, credit: LIQUIFER Systems Group, 2016

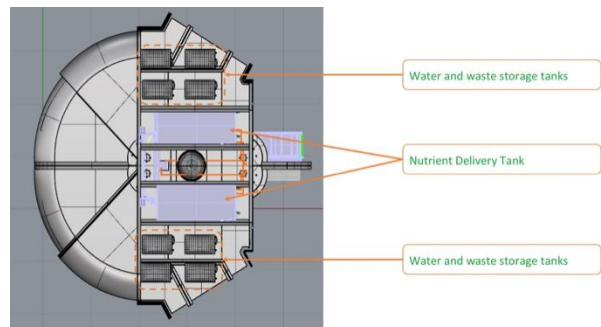

Figure 14: EDEN ISS systems in the SHEE habitat bottom view, credit: LIQUIFER Systems Group, 2016

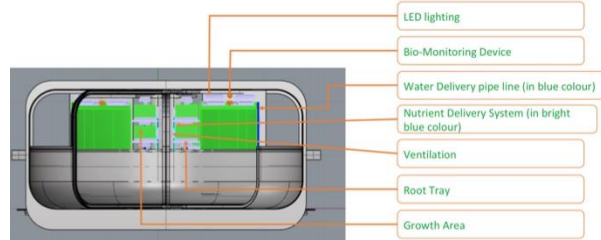

Figure 15: EDEN ISS systems in the SHEE habitat, side view, credit: LIQUIFER Systems Group, 2016

The SHEE habitat is modular and can be connected either to another SHEE or to a different module so that the greenhouse could be either doubled or connected to another functional facility (see Figure 16).



Figure 16: SHEE habitat modular village, credit: SHEE consortium, visualisation: LIQUIFER Systems Group, 2016

### 3.3 Case Study 3 - Mars-Lunar Greenhouse (MLGH) Prototype for Bioregenerative Life Support Systems

This NASA funded demonstrator by Sadler et. al [Ref. 5 – Sadler, 2014, Ref. 6 – Furfaro, 2017] comprises a deployable cylinder from transparent material in a concept proof installation. The dimensions are 2.10 m in diameter and 5.5 m in length with a total internal volume of 21 m<sup>3</sup> (see Figures 18 and 19). The concept is foreseen for either moon or Mars and is an inflatable semi-closed system membrane module. To protect the facility from radiation, it is foreseen that it is buried under regolith whereas the membrane module provides counter forces to the module's interior stress by interior pressure pushing outward. The overall configuration suggests four inflatable hydroponic cylindrical units interconnected by a hallway (see Figure 19). A cropping system is intended to maximize the possible canopy area by enabling filling the chamber both horizontally and vertically so that tall plants would grow on the perimeter walls and shorter plants on the inner rows. The greenhouse would embrace a hydroponic system in a grow area of 11 m<sup>2</sup> (very similar to EDEN ISS) with a lighting system by Phillips GreenPower LED toplights. Integrated is also a heating, ventilation, and air conditioning (HVAC) system.

Other possible options for shielding and in combination with regolith are Low-Density Polyethylene (LDPE), boron fibres, hydrogen impregnated carbon nano-tube structures or the incorporation of electromagnetic fields into composite materials. Another option is Martian water. Energy for the MLGH is anticipated to be provided through photovoltaic (Solar Concentrating Power Systems) and nuclear power reactors.



Figure 17: Mars-Lunar Greenhouse (MLGH) prototype, credit: University of Arizona, 2014



Figure 18: Mars-Lunar Greenhouse (MLGH) interior, credit: University of Arizona, 2014

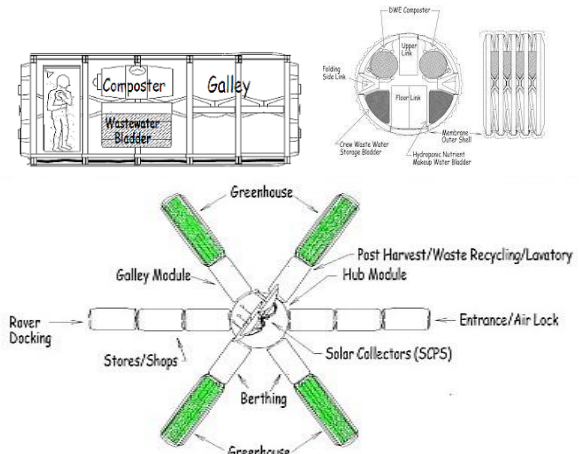

Figure 19: Mars-Lunar Greenhouse (MLGH) in an exploration mission, credit: photo: Sadler et al

### 3.4 Case Study 4 - A Lunar Greenhouse Design

This concept is a larger configuration encompassing the MELISSA framework, a closed-loop bioregenerative life support system with a micro-organism and higher plant based ecosystem. The concept is located on the moon is calculated for a crew of 6 and comprises a four-petal layout. The petals are connected to the core via airlocks, to provide compartmentalized growth areas with environmental conditions optimized for a given crop. The petals are independent from each other and function as growth chambers. They are connected to the various controlled environment agriculture (CEA) subsystems within the central rigid core. Each petal of the design is dedicated to a single cultivation environment, suitable for one or two crop types, throughout the mission duration [Ref. 7 – Zeidler 2017].

The overall size of this architectural design is approximately 20 – 30 m in length, 9 m width and a medium height of 10 m.



The engineering description of the greenhouse systems is detailed and can be summarized in the following: four independent Air Management Systems (AMS); each AMS is connected to one growth petal via ducting which allows for air recirculation in the petals, or air exchange with the habitat. Further, Pre- and Post-Processing System (PPPS) for the crops, Command and Data Handling System (CDHS), Nutrient Delivery System (NDS) is part of the concept. The NDS exhibits control of water and nutrient solution temperature and quality at the chemical and microbial level. The NDS is designed such that a dedicated nutrient recipe can be provided to each of the four petals. Then there is a Thermal Control System (TCS), Power Control and Distribution System (PCDS). All systems seem to be similar to the EDEN ISS systems, but adapted to the bigger space.

A fixed-shelf plant cultivation system is envisioned with LED panels. The design and the layout also foresee sufficient space to accommodate the shoot zone sizes of the various plants. Regolith should act as radiation protection in the lunar environment.

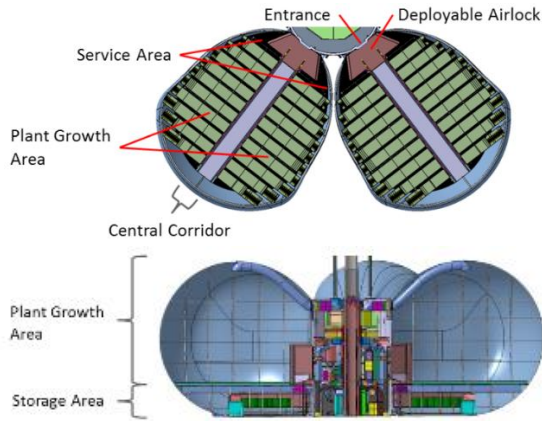

Figure 20: Lunar Greenhouse Design, visualisation: DLR

#### 4. Human Factors and well-being of the crew through integrating a greenhouse

In isolation, far away from the natural human conditions and Nature itself, people may suffer from asthenia and depression. This effect has emerged in many isolation conditions, being experienced by astronauts in space, military personnel in submarines, as well as scientists at Antarctic stations, but also in more common conditions such as by elderly people nursing homes [Ref. 8 –Kanas & Manzey, 2008].

The interaction with plants appears to have a positive effect on motivation and performance; however, further research is needed to demonstrate the relationship with performance in long-duration isolation [Ref. 9- Bates & Marquit, 2010, 10- Ulrich et al, 1991, 11-Bates et al, 2007].

#### 4.1 Extreme and isolated environments

“Any environment to which humans are not naturally suited, and which demands complex processes of physiological and psychological adaptation, can be considered as an “extreme” environment” [Ref. 8-Kanas & Manzey, 2008 p.15]. Therefore, both Antarctica and space can be considered as extreme environments.

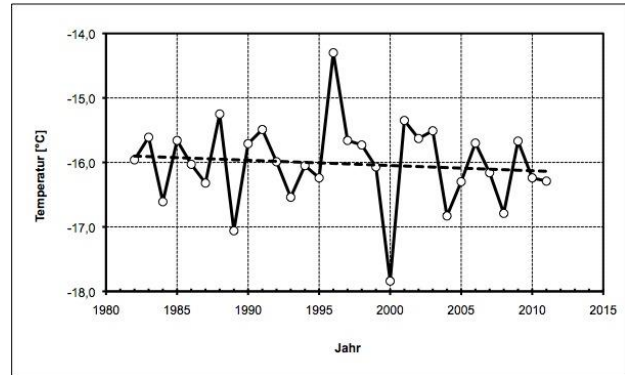

Figure 21: Mean annual temperature at the Neumayer III Station (Alfred Wegener Institut, 2012)

Specifically, Antarctica is considered to be the coldest, windiest, and driest continent on Earth; it is probably for this reason that it never had any indigenous population. The mean annual temperature (Figure 21), air pressure, and relative amount of sunshine are particularly extreme at the Neumayer III station in Antarctica. There are about six months of darkness followed by six months of daylight due to its location on the planet. If we include the degree of isolation found in Antarctica, this environment provides a setting very similar to the conditions of isolation and stress that astronauts are likely faced with in long-duration space missions [Ref. 12- Brief, 2015]. For this reason, Antarctica is used as a platform for testing technologies and human factors for space missions.



Figure 22: Neumayer III Station. © Alfred-Wegener-Institut, Thomas Steuer 2011

#### 4.2 Human Factors and Psychological Impact

Human performance is defined by Colman as the quality with “which tasks or purposeful activities are carried out or accomplished by people” [Ref. 13-



Colman, 2009, p.351; 14- Wickens et al., 2016] discuss the quality of human performance and state that it can be measured by the speed and accuracy with which the task was completed, and the attentional demand the task required.

In extreme environments, such as space and Antarctica, psychological effects have a strong impact on performance. Research on people working in extreme and isolated environments revealed that they go through different stages of adaptation, showing changes in mood, performance, and interpersonal interactions [Ref. 8-Kanas & Manzey, 2008]. The issues with extreme environments and the reasons for the general low level of habitability these environments offer, are the mood changes and stress levels they cause [Ref. 15-Schlacht, 2012; 16-Schlacht, 2017]. “Experience has shown that sustained confinement of workers in remote, isolated, high-risk environments analogous to space produces undesirable symptoms, non-adaptive behaviors, and performance decrements associated with stress” [Ref. 17- Mohanty et al., 2006, p. 7].

### 4.3 Stress Levels and Performance

Stress can emerge when a person’s well-being is threatened by environmental, biological, and/or cognitive events. Stress can induce high levels of arousal (Figure 5), [Ref.18- Hobfoll, 199] that are excessive and cause a drop in performance [Ref. 19-Tiwari, 2011, p.42]. These considerations regarding stress levels are important when it comes to thinking about the potential effect of plants in long-duration isolation in extreme environments [Ref. 20 Bernini, 2016].

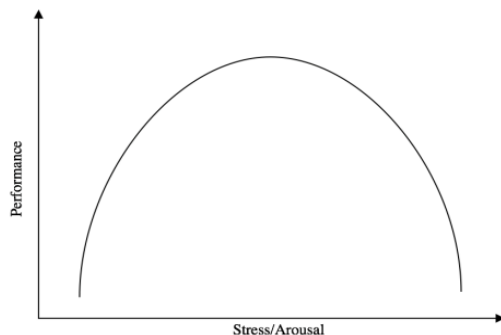

Figure 23: Yerkes-Dodson (1908) inverted U law showing the relation between stress/arousal and performance

### 4.4 Beneficial Aspects of Plants on Human Performance

According to several studies, it has been shown that plants can have psychological and physical benefits, such as [Ref. 21- Kaplan, 2009].

- Lower blood pressure
- Improve reaction times

- Increase attentiveness
- Improve attendance (at work and school)
- Raise productivity (at work)
- Improve well-being
- Improve perception of space
- Lower levels of anxiety during recovery from surgery
- Raise job satisfaction

According to the definition of quality of human performance by Wickens et al. [Ref. 14- in 2016], the improved reaction time and increased attentiveness caused by plants will increase performance, as the person will perform the task faster and more attentively. In conclusion, stress levels and arousal are crucial aspects in human performance. When they are excessive, they can lead to reduced performance [Ref. 19- Tiwari, 2011]. Plants can help mitigate high levels of stress.

To analyze the impact of plants in terms of fresh food production and consumption on performance and well-being, different instruments have been planned to be used by the Neumayer station III 2017-2018 crew during the year of isolation connected with the test of EDEN-ISS:

- a) The “Human Factors debriefing”
- b) A dedicated questionnaire based on previous research (Mauerer et al., 2016<sup>1</sup>)
- c) The “Profile of Mood States” (POMS)
- d) Record of quantity of time spent on the green house by the crew
- e) Final interviews after the mission end.

These methods are understood as a prolongation of the initial study of Mauerer et al. [Ref. 22, in 2016]. The aim of these questionnaires is to assess the effect of the interaction with plants during long-term missions on the mood of the crew members, on their performance, and generally on crew cohesion from a psychological and human factors perspective [Ref. 23- Schubert, et al., 2018].



Figure 24: EDEN-ISS First lettuce harvest, credit: EDEN ISS consortium, photo: DLR, 2018

## 5. Conclusive Discussion

A greenhouse in space will be the only place within an extra-terrestrial base which will be a physically manifested reminder of our home planet earth. The greenhouse will have an extraordinarily high sojourn quality within the spaceship especially when we consider that direct windows to the outside environment will not be present due to the harsh radiation environment outside. In a greenhouse, we can see plants grow, a changing environment in interaction with humans vital in a surrounding which otherwise is stale and inanimate. Integrating a greenhouse into a space station or planetary base is not purely adding the survival of humans through food supply but also offering a greenhouse in the living space. On a psychological level, a greenhouse has many positive impacts as described in Section 4; such as improvement of attentiveness, well-being, perception of space and the raise of productivity.



Figure 25: Living room greenhouse, credit: *The future of the greenhouse, youtube*

However, a greenhouse is a technologized space connected to the overall Life Support Systems and provides a vital supplement to the human survival in space.

From project EDEN ISS and the described four Case Studies we can learn that future greenhouses will:

- incorporate hydroponic and/or aeroponic using a minimum of material (no soil) and water
- be equipped compact and/or deployable with multi-tray levels (growing process ideally to start before crew arrives)
- include automation systems in harvesting
- be integral to life support systems
- have to be protected from the outside radiation environment through regolith, or Low-Density Polyethylene (LDPE), boron fibres, hydrogen impregnated carbon nano-tube structures, incorporation of electromagnetic fields into composite materials or any other effective means

- need to utilise ISRU (regolith, water as radiation protection)
- need a viable power source

With greenhouse spin-offs for terrestrial applications, this particular topic is prone to be advanced and developed further so that challenges such as robust systems integral to a closed loop life support system can someday sustain human food requirements in any environment needed for reasonable costs.

## 6. Conclusions

In this paper, specific cases studies have been presented:

- EDEN ISS
- MarsPort 2002
- Greenhouse of the SHEE Habitat
- Mars-Lunar Greenhouse
- Greenhouse Module for Space System: A Lunar Greenhouse Design

Specifically design, technical, psychological and human factors aspects of the projects have been discussed. The EDEN ISS project offers new insights into semi-closed loop greenhouse innovation and incorporates a diversity of research themes:

- Space application
- Spin-off application on earth and Antarctica
- Test in extreme environment
- Psychological and Human Factors investigation
- Physiological benefit and quantity of food eaten by the crew
- Design
- Test of new technologies within one integrated successfully working system that yields up to 8kg of fresh vegetables per week.

The EDEN ISS team expects a multitude of novel data by the mid of 2019 when all the research experiments connected to the project are terminated and the findings evaluated.

## Acknowledgements

The EDEN ISS project has received funding from the European Horizon 2020 Programme within the topic of 'Space exploration / Life support under the grant agreement number 636501.

## Paper Citation

Barbara Imhof B., Schlacht I.L., Waclavicek R., Schubert D., Zeidler C., Vrakking V., Hoheneder W., Hogle M.(2018). EDEN ISS – A SIMULATION TESTBED TO AN ADVANCED EXPLORATION DESIGN CONCEPT FOR A GREENHOUSE FOR MOON AND MARS. IAC-18.B3.7. International Astronautical Conference, Bremen 1-5.10.2018.

## References

- [1] EDEN ISS consortium, [www.eden-iss.net](http://www.eden-iss.net), as viewed 12.9.2018
- [2] Munson, S.T. (2002). MarsPort 2002 : An Evolutionary Deployable Greenhouse for Mars.
- [3] Osborne, B., Hoheneder W., Hogle M., A Self-Deployable Habitat for Extreme Environments (SHEE), Issue #4(6) 2015 Astronautics, <https://room.eu.com/article/a-self-deployable-habitat-for-extreme-environments-shee>, as viewed 17. September 2018
- [4] Imhof B., Nelson, J., Madakashira, H. K., Aabloo, A., Weiss, P., Ševčík, D., SHEE – Self-Deployable Habitat for Extreme Environments, 46th International Conference on Environmental Systems. ICES-2016-252. 10-14 July 2016, Vienna, Austria.
- [5] P.D. Sadler, R. Fufaro, R.L. Patterson, Prototype BLSS Lunar-Mars Habitat Design, 44th Int. Conf. Environ. Syst. (2014) 1–11.
- [6] R. Furfaro, S. Gellenbeck, G. Giacomelli, P. Sadler, Mars-Lunar Greenhouse (MLGH) Prototype for Bioregenerative Life Support Systems: Current Status and Future Efforts, (2017). [https://ttu-ir.tdl.org/ttu-ir/bitstream/handle/2346/73105/ICES\\_2017\\_347.pdf?sequence=1](https://ttu-ir.tdl.org/ttu-ir/bitstream/handle/2346/73105/ICES_2017_347.pdf?sequence=1).
- [7] C. Zeidler, V. Vrakking, M. Bamsey, L. Poulet, P. Zabel, D. Schubert, C. Paille, E. Mazzoleni, N. Domurath, Greenhouse module for space system: A lunar greenhouse design, *Open Agric.* 2 (2017) 116–132. doi:10.1515/opag-2017-0011.
- [8] Kanas, N., Manzey D. (2008). *Space Psychology and Psychiatry*. Springer.
- [9] Bates, S.C., Marquit, J.D. (2010). *Space psychology: natural elements in habitation design*. Personal and Ubiquitous Computing. Springer.
- [10] Ulrich, R.S., Simons, R.F., Losito, B.D., Fiorito, E., Miles, M. A., Zelson M. (1991). Stress recovery during exposure to natural and urban environments. *J Environ Psychol* 11:201–230
- [11] Bates, S.C., Gushin, V.I., Marquit, J.D., Bingham, G., Sychev, V.V. (2007). Plants as countermeasures in long-duration Space missions: a review of the literature and research strategy. Presented at the European Space Agency Workshop: Tools for Psychological Support.
- [12] Brief, J. (2015, June 10). Antarctica Analog Studies. Retrieved June 6, 2016, from NASA: <https://www.nasa.gov/hrp/research/analog/antarctica>
- [13] Colman, A. (2009). *A Dictionary of Psychology*. New York: Oxford University Press.
- [14] Wickens, C., Hollands, J., Banbury, S., & Raja, P. (2016). *Engineering Psychology and Human Performance*. New York: Routledge.
- [15] Schlacht, I. (2012) Schlacht, I. L. (2012). *SPACE HABITABILITY: Integrating Human Factors into the Design Process to Enhance Habitability in Long Duration Mission*. Doctoral Dissertation, Technische Universität Berlin, Germany. [https://depositonce.tu-berlin.de/bitstream/11303/3390/1/Dokument\\_11.pdf](https://depositonce.tu-berlin.de/bitstream/11303/3390/1/Dokument_11.pdf)
- [16] Schlacht, I.L. (2017). Habitability and habitat design. In B. Kanki, J-F. Clervoy & G. Sandal (Eds.), *Space Safety and Human Performance* (pp. 653-719). Oxford, UK: Butterworth-Heinemann.
- [17] Mohanty, S., Jørgensen, J., & Nyström, M. (2006). *Psychological Factors Associated with Habitat Design for Planetary Mission Simulators*. San Jose, California: American Institute of Aeronautics and Astronautics.
- [18] Hobfoll, S. (1991). Traumatic stress: A theory based on rapid loss of resources. *Anxiety Research*, 187-197.
- [19] Tiwari, G. G. (2011). Stress and human performance. *Indo-Indian Journal of Social Science Researches*, 40-49.
- [20] Bernini, J. (2016). *Human Factors Analysis and Optimisation of a Greenhouse Module for Outer Space and Antarctica*. Karlsruhe University of Technology Thesis IS 16001 supervised by Deml B. & Schlacht I.L.
- [21] Kaplan, J. S. (2009, March 11). Plants Make You Feel Better. Retrieved May 21, 2016, from *Psychology Today*: <https://www.psychologytoday.com/blog/urban-mindfulness/200903/plants-make-you-feel-better>
- [22] Mauerer, M., Schubert, D., Zabel, P., et al. (2016). Initial survey on fresh fruit and vegetable preferences of Neumayer Station crew members: Input to crop selection and psychological benefits of space-based plant production systems. *Open Agriculture*, 1(1), pp. -. Retrieved 9 Sep. 2018, from doi:10.1515/opag-2016-0023
- [23] Schubert, D. et al. (2018). The EDEN ISS Antarctic Greenhouse project: 9 month mission status after deployment in Antarctica. IAC-18.A1.IP.4. International Astronautical Conference, Bremen 1-5.10.2018



