

The Science of Manifestations by God and Divinity leading to Inspiration and Persistence as Holy Books or Holy Sites or Evolved/Systematic Holy Ways of Life – A consequence of the Evolution of the Mind and the Heart inspired by Consciousness fields as explained in the New Consciousness model which scientifically converges Science and Spirituality with converged scientific and spiritual insights into the aspects of God, Soul, Karma, Birth and Re-birth, Machine Consciousness and Awareness, Plants, Animals, All Life, Natural and non-Natural forms and Convergence of Religious Teachings

Neela Iyer¹, Prabhu Britto Albert², Sant Maa Ananta Devi³, Sant Maa Aparna Devi⁴, C.N. Rakkiappan⁵, M. Mohanan⁶, Dhyanyogi Omdasji Maharaj⁷

1, 3, 4, 7 Shri Madhusudan Dhyanyoga Niketan Ashram, Ahmedabad, INDIA (Ph: +91 79 22886045)

neela.iyer.16@gmail.com

2 Dean (R&D) and Professor of Electronics & Communication Engineering and BioMedical Engineering, VMKV Eng. College, VM University, Salem, INDIA

6 Botanist (Retd.), Botanical Survey of INDIA, Coimbatore, INDIA

5 Astrologer, Sri Sangamam Jothida Maiyam, 24/200 Sundaram Street, Coimbatore 641001, INDIA (Ph: +91 850 883 1000)

ABSTRACT:

This research work is part of a sustained attempt to scientifically interpret the Meditative Guidance of the Divine Omdasji Sound Meditation (SR0000398348 dated 2006-09-13, United States Copyright Office) renowned to bring peace and calm to the meditating human subject. Recent scientific findings on a seemingly unrelated area of research work evoked interest as a convergence was realized. A Comparison started yielding more insight into hitherto unexplored areas. This research work attempts to analyze and assimilate the research of the Divine Omdasji Sound Meditation Research and further findings.

Keywords: Divine Omdasji Sound Meditation, Meditation, Meditative Guidance, Dual Consciousness state, Awareness, Cure, Mental Depression, Sleep Disorders, Anxiety, Drug addiction and loss of immunity, Psychological Acceptance, Neutrino, Scientific Temperament, Spiritual Consciousness, Science, Spirituality, Dual nature of Science and Spirituality, God, Soul, Karma, Birth, Re-birth, Human Machine Interactions, Awareness, Machine Consciousness, Plants, Animals, All Life, Natural and non-Natural forms, Convergence of Religious Teachings, Human Perspective, Animal Perspective, Plant Perspective, Environment, Green Solution for All Environmental Problems, Self-Organizing Consciousness Fields, Food Assurance, Ecosystems, Global Food Security, Mankind, Nature, Co-existence of Species, Disaster Management, Raw Material, Manufacture, Assembly, Efficient Machine Operation, Efficient User Operation, Reduction in Fuel and Energy Demand, Identification and Exploit of more natural or artificial sources of fuel and energy, Human Consciousness Fields Interaction, Health, Education, Knowledge, Societal Life, Evolution, Mind, Heart, Divine Manifestation, Holy Books, Holy Sites, Holy Ways of Life

INTRODUCTION

Meditation is characterized by the attainment of a restful yet fully alert physical and mental state practiced by many as a self-regulatory approach to emotion management [1]. It is a mental activity associated with attaining a deeply restful yet fully alert state [2] and is labeled as “A wakeful Hypo metabolic Physiologic State” [3]. Physiological alterations in the human subjects led to the attention of many researchers and journals to concentrate on Meditation, and its effect on the human subject was assessed in various ways. The idea of a body–mind connection is not a new one. In fact, it is only in the recent past that the two ideas have been seen as separate [4]. A series of research articles have been published on Meditation [5-9]. The Divine Omdasji Sound Meditation (SR0000398348 dated 2006-09-13, United States Copyright Office) is used for Meditation by human

subjects and is renowned to cause a lot of beneficial physiological effects to the meditating human subject. The following discussion introduces Meditation and provides the bridge knowledge between Meditation and Science, further elaborating on the scientific investigations carried out in this research work and the interpretation of the results thus obtained.

MEDITATION, CONSCIOUSNESS AND MUSIC

Meditation is an ancient spiritual practice that has recently been studied due to its potential health promoting effects, and its status as a special form of consciousness. The recent decades have witnessed a marked change in the perspective of viewing Meditation as a solely mystic process of spiritual quest to a complementary effective method in several health situations [10]. In a survey of EEG characteristics of persons practicing Meditation, theta bursts were

preceded and followed by alpha rhythm. Subject reports elicited during theta bursts indicated pleasant states with intact situational orientation and no subjective experiences related to sleep. It is hypothesized that theta burst may be the manifestation of a state adjustment mechanism which comes into play during prolonged low-arousal states, and which may be related to EEG patterns of relaxation in certain behavioral conditions [11].

Consciousness is a subtle phenomenon, which has so far resisted all attempts to understand it, in spite of the present 'race for consciousness' [12]. It has been debated in many areas, including brain sciences [13]. Changes in EEG coherence patterns were used to test a field model that posits a common field of "pure consciousness" linking all individuals. The experimental data support a field model of consciousness [14]. While a considerable number of studies have been carried out with EEG, only few studies have used PET and fMRI [9, 15].

Consciousness

Exploration and reflection on the interfacing of religion and the neurosciences in the last twenty-five years provide a unique point of convergence on the relationship between science and religion. By the 1990s, meaning-making and integrating consciousness emerged as shaping the agenda between religion and cognitive neuroscience. The emerging methodology combines analogical continuities among levels of complexity and metaphorical leaps of inferential patterning [16].

Also, Global brain imaging techniques (PET and fMRI) indicate that a different brain network is involved in moving the focus of attention from that involved in the initial processing of an attended input [17, 18].

Recent neuroscientific works on the problem have surprisingly neglected attention as a guide to consciousness [19]. Without attention to an input there is no awareness of it. Yet several recent papers on consciousness [20-23] have surprisingly neglected attention as a guide to understanding consciousness. The following paragraphs concentrate on Music as an attention input.

Music

Meditation is defined as an exercise [24], which usually involves training the individual to focus the attention or consciousness in a single object, sound, concept or experience. Apart from Meditation, relaxation could also be induced through chemical means (muscle relaxant drugs, such as Valium) or through biofeedback techniques in which the subject's EMG activity is monitored and revealed to the subject

via light or tone signals. Such biofeedback techniques allow persons to develop voluntary control over internal systems (such as heart rate, blood pressure, EEG activity) previously thought to be beyond such control [25]. The human being is thought of as a musical instrument. By changing the patterns and rhythms of sound and breath, it is possible to link all the systems of the body that regulate excitement, relaxation, action, reaction and intelligence. In basic meditation, only a small area of the brain was engaged while the addition of selected sounds in Medical Meditation produced more pronounced levels of activation [26]. This research work concentrates on the Divine Omdasji Sound Meditation which uses Music as attentive input and the scientific interpretations arising out of the analysis done on the Divine Omdasji Sound Meditation.

SCIENTIFIC INVESTIGATIONS ON THE SOURCE OF MEDITATIVE EXPERIENCE

Modern psychology has the tools to explain the nature of the experience, and this leads one to believe that it can explain the source of the experience [27].

The Divine Omdasji Sound Meditation is renowned to be a source of Meditative Experience and hence it was chosen for scientific experimentation. The Divine Omdasji Sound Meditation is a series of Sanskrit vowels, consonants and words sung by Dhyanyogi Omdasji. An electronic drone is used to provide a monophonic effect or accompaniment to the chant of the Divine Omdasji Sound Meditation. While chanting the Divine Omdasji Sound Meditation, a series of words and notes issues forth from Dhyanyogi Omdasji. His singing is renowned to have a physiological effect on the listeners, often attributed to his lifelong intense yogic practices.

The physiological effects are known to manifest as calmness of the mind, easy entry into meditative states (characterized by low frequency EEG waves) accompanied with or without meditative experiences, cure for insomnia, quitting smoking habits, healing & emotional stability. Another view that is attributed by people to the Divine Omdasji Sound Meditation is that the Divine Omdasji Sound Meditation yield peace to the client, and could also purify the thought processes leading to possibly reduced crime rate in society. The Divine Omdasji Sound Meditation is also renowned to awaken the Kundalini Power which is the goal of many spiritual practices.

The aim of this and further research is to investigate the source of the experience so that more scientific interpretation can be given. To avoid disturbances due to ambient noise or other sources of sound, a professional studio recording was preferred. Therefore, a professional studio recording of the

Divine Omdasji Sound Meditation chant was obtained and used for further scientific investigations.

MATERIALS AND METHODS

The configuration of the computer used for analysis was a Pentium IV 2.66 GHz with 512 MB RAM running on Microsoft Windows XP Media Center Edition Version 2002 with Service Pack 2. The software used for analysis was MATLAB 7.0.0 (R14). After analysis of the computational resources available and assuming that analysis of audio range up to 4 KHz was sufficient for human voice analysis, the Nyquist criteria yielded 8 KHz sampling rate. Since the professional studio recording was a stereo recording, it was modified as an 8 KHz 16 bit stereo audio file for duration spells of ten minutes each. The odd labeled files recorded the first ten minutes of each quarter of the hour, and the even labeled files recorded the last ten minutes of each quarter of the hour, yielding 8 unique ten-minute recordings at 8 KHz 16 bit stereo for the entire Divine Omdasji Sound Meditation Chant approximating an hour. In the stereo recordings, the first channel data was obtained using MATLAB software and used for further analysis. The latter part of the research work reported in this manuscript was done using a DELL INSPIRON 1545 with 4GB RAM and MATLAB 2009b. In this research work, ten-minute recordings have been scientifically analyzed. Since the audio data was recorded at 8 KHz sampling rate, a 600 second recording yielded 4.8×10^6 data points. Figure 1 displays the original audio recording

of the first 600 seconds of the Divine Omdasji Sound Meditation chant as an amplitude-time graph. The amplitude for each second was obtained by taking the mean of the 8000 sample points for each second. The X- axis denotes the time in seconds and Y-axis denotes the mean amplitude in Volts or better expressed as milliVolts. It is found that a majority of data points lie in the 14 mV to 16mV range. To perform a detailed study of the graph, Figure 1 was zoomed. Figure 2 shows a zoomed portion that contains majority of the graph points of Figure 1. Thus the Divine Omdasji Sound Meditation chant was obtained in a form that could be scientifically investigated. Then, attention was focused on the methodology to be chosen for investigating the Divine Omdasji Sound Meditation chant data. One of the major effect that is known to be caused by the Divine Omdasji Sound Meditation is the alteration of EEG waves towards low frequency rhythms. The reason may be attributed to changes of electrical activity of the brain produced by auditory stimuli [28]. Perhaps, the alteration of brain waves to low frequency rhythms and hence transition among the rhythms could be attributed to the phenomena of phase-locking. Phase-locking plays a dominant role in the neural encoding of the spectrum of speech sounds [29]. This suggests that all these phenomena experienced by the subject could have been transferred from the Divine Omdasji Sound Meditation. Hence, spectral analysis of the Divine Omdasji Sound Meditation was carried out.

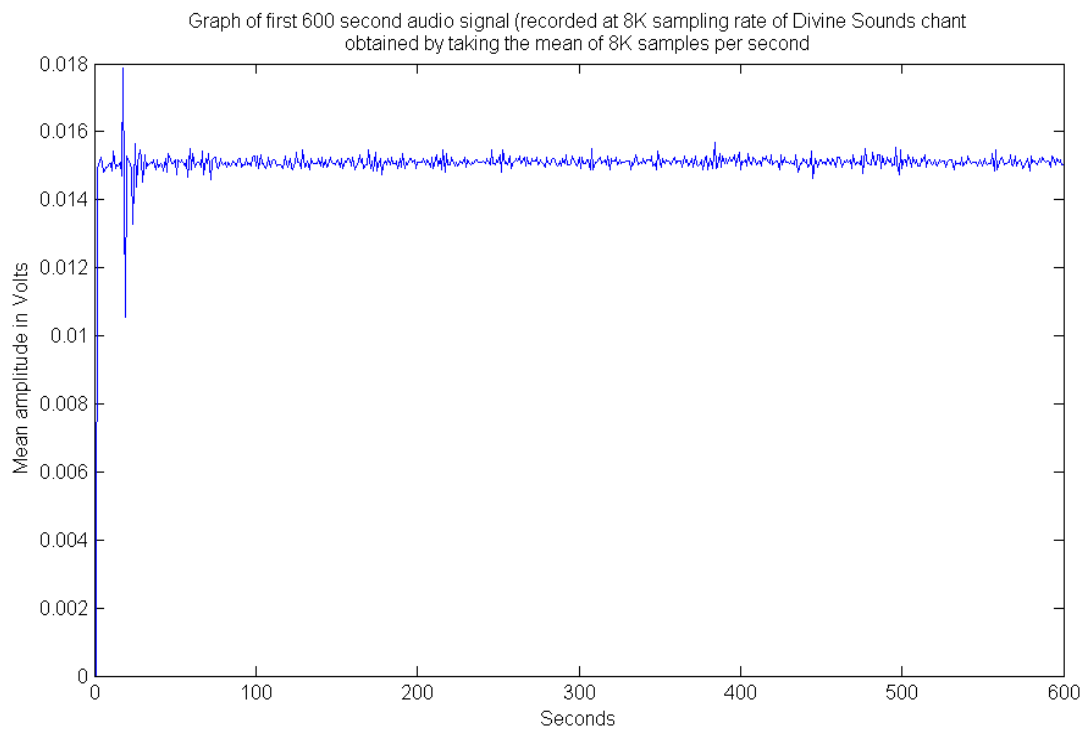

Fig.1 Graph of original audio recording of the first 600 seconds of Channel 1 of the Divine Omdasji Sound Meditation chant

Figure 1 shows the graph of the original audio recording of the first 600 seconds (ten minutes) of Channel 1 of the Divine Omdasji Sound Meditation chant. The audio recording had been performed on MATLAB software at 8 KHz 16 bit stereo, and the digital samples were obtained. This implies that 8000 data points (indicating

amplitude) would represent every second of the Divine Omdasji Sound Meditation Chant. To construct the graph of the original audio signal, each 8000 data points was averaged for every second and the mean amplitudes were indicated against time, to obtain a time domain graph of the original audio recording.

Graph of first 600 second audio signal (recorded at 8K sampling rate) of the Divine Sounds chant obtained by taking the mean of 8K samples per second

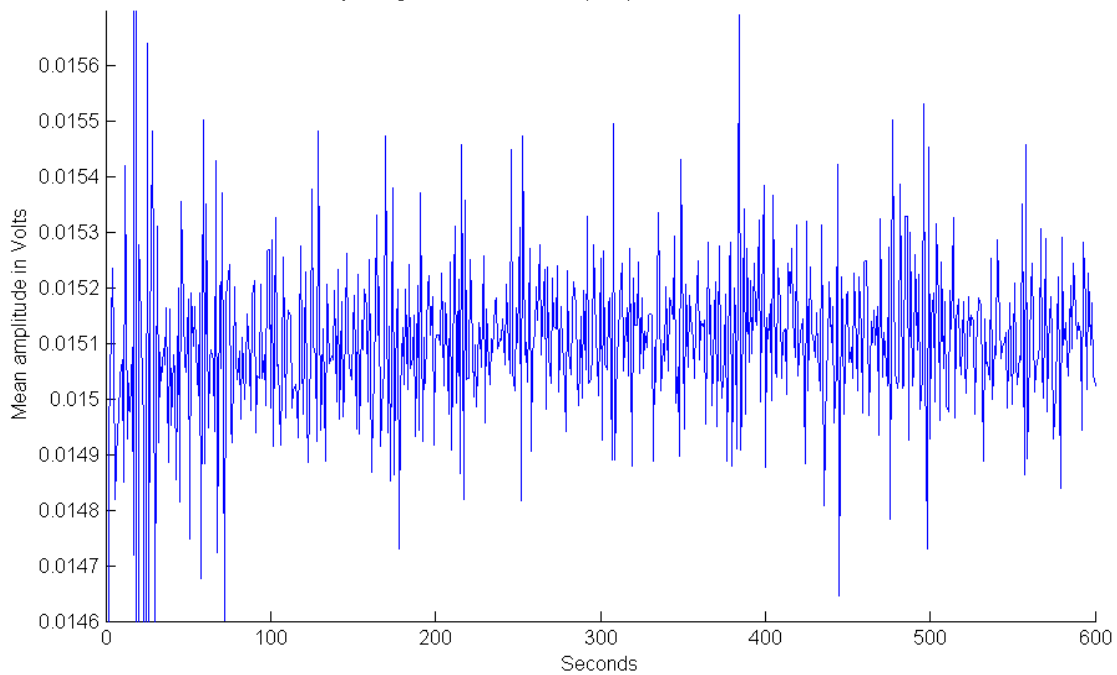

Fig.2 Zoomed Graph of original audio recording of the first 600 seconds of Channel 1 of the Divine Omdasji Sound Meditation chant

Figure 2 shows a Zoomed Graph of Figure 1. This has been done by viewing the graph between Y axis limits of 14.6 mV to 15.6mV using MATLAB software. Figure 2 thus yields a better view of the original audio signal of the Divine Omdasji Sound Meditation chant corresponding to Channel 1 of the first 600 seconds.

RESULTS OF SPECTRAL ESTIMATION

The goal of spectral estimation is to describe the distribution (over frequency) of the power contained in a signal, based on a finite set of data. Estimation of power spectra is useful in a variety of applications, including the detection of signals buried in wide-band noise (MATLAB Signal Processing Toolbox Helpdesk available at www.mathworks.com). Spectral Analysis of the Divine Omdasji Sound Meditation was carried out using MATLAB 7.0.0 (R14) software on a Pentium IV 2.66 GHz computer with 512 MB RAM running on Microsoft Windows XP Media Center Edition Version 2002 with Service Pack 2. Periodogram of the first ten minute recording of Divine Omdasji Sound Meditation was computed using Matlab and shown in Fig. 3. The periodogram plot showed frequencies in the range up to 4 KHz (maximum range set for this investigation). Of particular interest were the frequencies corresponding to the various EEG bands, especially the delta and theta EEG bands (for reasons discussed in the forthcoming paragraphs). The EEG bands were chosen to be the following ranges.

Delta: Greater than or equal to 0.1 Hz to less than 4 Hz

Theta: Greater than or equal to 4 Hz to less than 8 Hz

Alpha: Greater than or equal to 8 Hz to less than 14 Hz

Beta: Greater than or equal to 14 Hz to less than 30 Hz

The recorded Divine Omdasji Sound Meditation audio was investigated for the presence of frequencies corresponding to the various frequency bands in the EEG rhythms. At the conventional range of -40 db from the maximum signal power, a few frequencies were observed in the alpha & beta ranges and the frequencies were plotted against power (in db) shown in Figures 4 & 5. All negative db level references henceforth will mean negative db level thresholds calculated from the maximum signal power. It is known that the actual signal power reduces drastically with decrease in db levels. Since the Divine Omdasji Sound Meditation audio signal is investigated for frequencies equivalent to very low frequency EEG rhythms less than 8 Hz (equivalent audio range falls in inaudible ranges), the authors investigated for frequencies corresponding to power levels which are very much less than the conventional -40 db range, hoping to find more information. The power of the audio signal was not a strict constraint when investigating inaudible frequency ranges. The low power of the inaudible signal is not a major factor of merit as the signal is already inaudible. Therefore, the inaudible frequency ranges (corresponding to equivalent very low frequency EEG rhythms) from the Periodogram of the first ten minute recording of the Divine Omdasji Sound Meditation audio signal were investigated at very low power ranges of -60 db, -80 db

and -100 db (from the maximum signal power). Spectral analysis of the Divine Omdasji Sound Meditation yielded Figures 4 to 73 showing stem plot of the frequencies that are observed in the respective threshold region (from maximum signal power) in the Divine Omdasji Sound Meditation recording of the first ten minutes. The Graph is plotted with frequency on the X-axis and Power in db on the Y-axis. The cyan stem indicates the presence of the particular frequency ranges and the red crosses indicate the power (in db) present in that frequency in the Divine Omdasji Sound Meditation Recording of the first ten minutes.

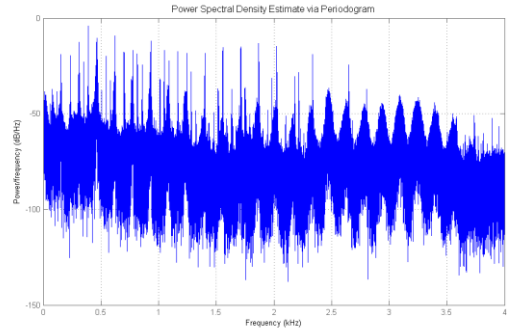

Fig. 3 Periodogram of first ten minute recording of Divine Omdasji Sound Meditation

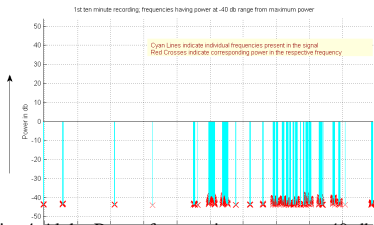

Fig. 4 Alpha Range frequencies present at -40 db threshold in the Divine Omdasji Sound Meditation recording of the first ten minutes

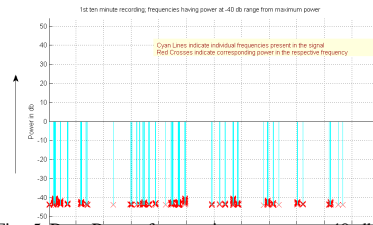

Fig. 5 Beta Range frequencies present at -40 db threshold in the Divine Omdasji Sound Meditation recording of the first ten minutes

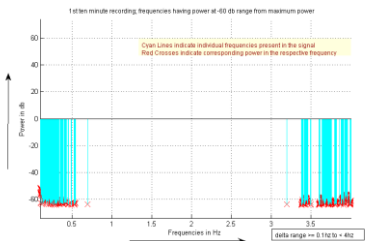

Fig. 6 Delta Range frequencies present at -60 db threshold in the Divine Omdasji Sound Meditation recording of the first ten minutes

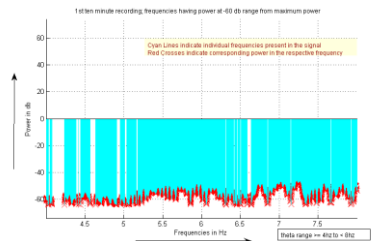

Fig. 7 Theta Range frequencies present at -60 db threshold in the Divine Omdasji Sound Meditation recording of the first ten minutes

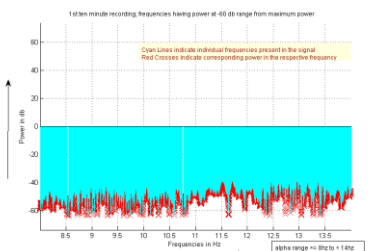

Fig. 8 Alpha Range frequencies present at -60 db threshold in the Divine Omdasji Sound Meditation recording of the first ten minutes

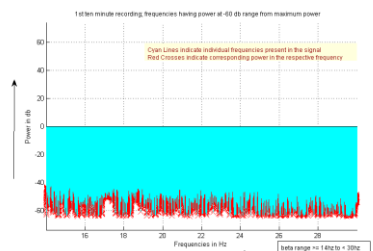

Fig. 9 Beta Range frequencies present at -60 db threshold in the Divine Omdasji Sound Meditation recording of the first ten minutes

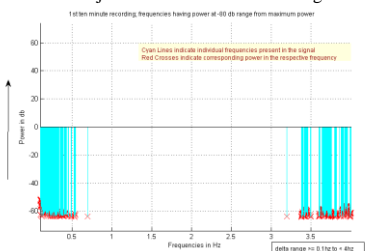

Fig. 10 Delta Range frequencies present at -80 db threshold in the Divine Omdasji Sound Meditation recording of the first ten minutes

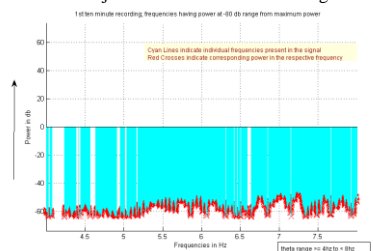

Fig. 11 Theta Range frequencies present at -80 db threshold in the Divine Omdasji Sound Meditation recording of the first ten minutes

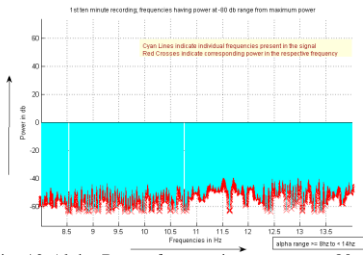

Fig. 12 Alpha Range frequencies present at -80 db threshold in the Divine Omdasji Sound Meditation recording of the first ten minutes

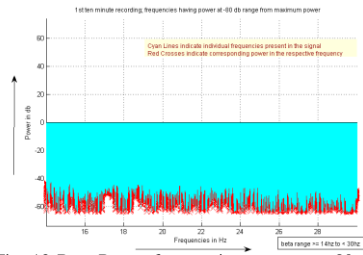

Fig. 13 Beta Range frequencies present at -80 db threshold in the Divine Omdasji Sound Meditation recording of the first ten minutes

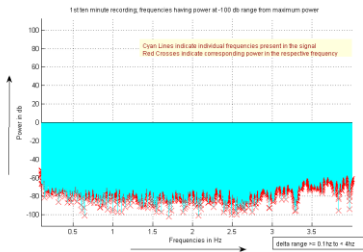

Fig. 14 Delta Range frequencies present at -100 db threshold in the Divine Omdasji Sound Meditation recording of the first ten minutes

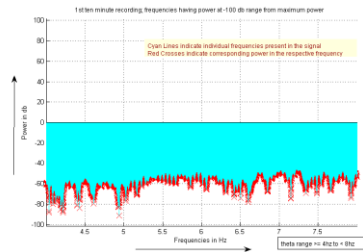

Fig. 15 Theta Range frequencies present at -100 db threshold in the Divine Omdasji Sound Meditation recording of the first ten minutes

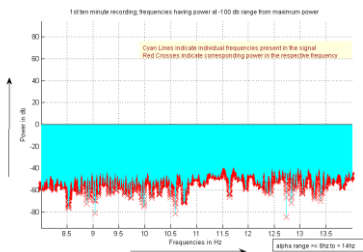

Fig. 16 Alpha Range frequencies present at -100 db threshold in the Divine Omdasji Sound Meditation recording of the first ten minutes

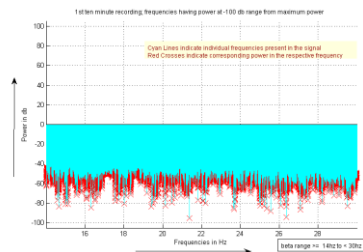

Fig. 17 Beta Range frequencies present at -100 db threshold in the Divine Omdasji Sound Meditation recording of the first ten minutes

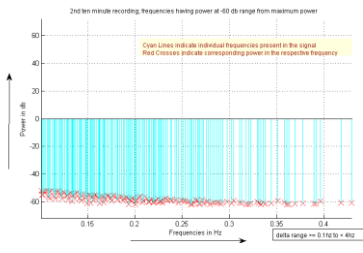

Fig. 18 Delta Range frequencies present at -60 db threshold in the Divine Omdasji Sound Meditation recording of the second ten minutes

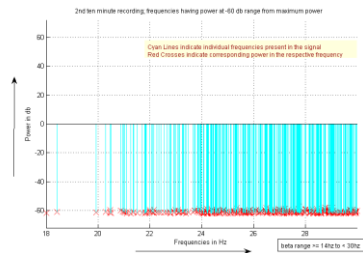

Fig. 19 Beta Range frequencies present at -60 db threshold in the Divine Omdasji Sound Meditation recording of the second ten minutes



Fig. 20 Delta Range frequencies present at -80 db threshold in the Divine Omdasji Sound Meditation recording of the second ten minutes

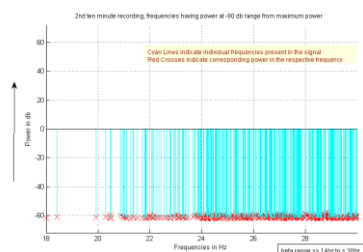

Fig. 21 Beta Range frequencies present at -80 db threshold in the Divine Omdasji Sound Meditation recording of the second ten minutes

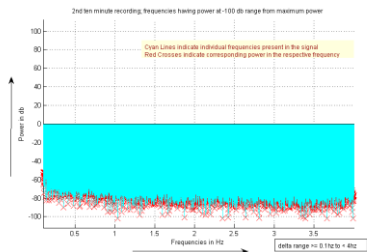

Fig. 22 Delta Range frequencies present at -100 db threshold in the Divine Omdasji Sound Meditation recording of the second ten minutes

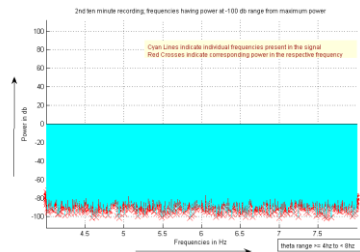

Fig. 23 Theta Range frequencies present at -100 db threshold in the Divine Omdasji Sound Meditation recording of the second ten minutes

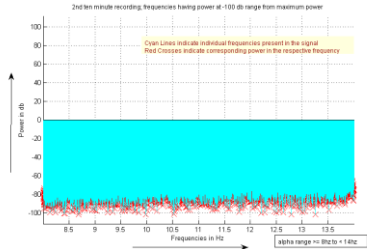

Fig. 24 Alpha Range frequencies present at -100 db threshold in the Divine Omdasji Sound Meditation recording of the second ten minutes

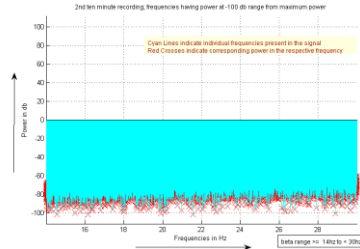

Fig. 25 Beta Range frequencies present at -100 db threshold in the Divine Omdasji Sound Meditation recording of the second ten minutes

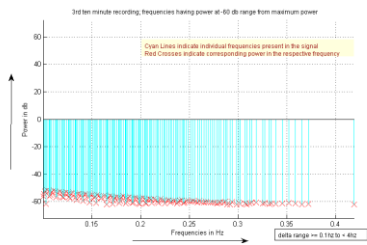

Fig. 26 Delta Range frequencies present at -60 db threshold in the Divine Omdasji Sound Meditation recording of the third ten minutes

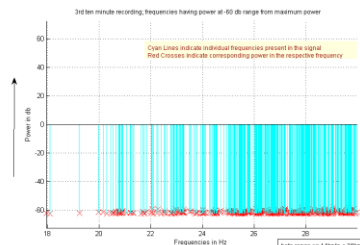

Fig. 27 Beta Range frequencies present at -60 db threshold in the Divine Omdasji Sound Meditation recording of the third ten minutes

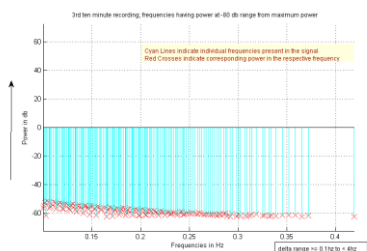

Fig. 28 Delta Range frequencies present at -80 db threshold in the Divine Omdasji Sound Meditation recording of the third ten minutes

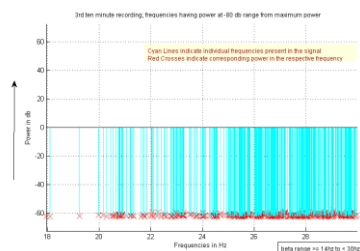

Fig. 29 Beta Range frequencies present at -80 db threshold in the Divine Omdasji Sound Meditation recording of the third ten minutes

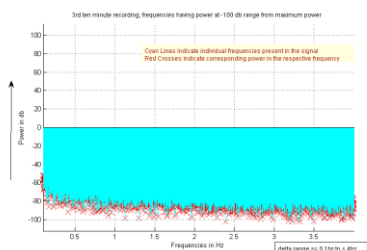

Fig. 30 Delta Range frequencies present at -100 db threshold in the Divine Omdasji Sound Meditation recording of the third ten minutes

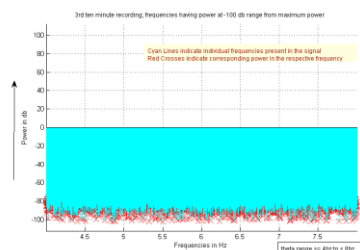

Fig. 31 Theta Range frequencies present at -100 db threshold in the Divine Omdasji Sound Meditation recording of the third ten minutes

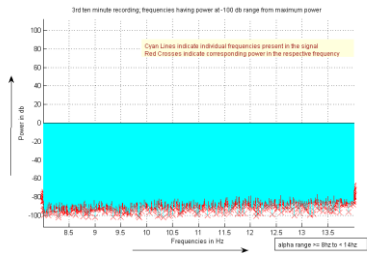

Fig. 32 Alpha Range frequencies present at -100 db threshold in the Divine Omdasji Sound Meditation recording of the third ten minutes

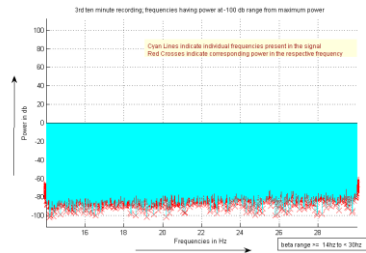

Fig. 33 Beta Range frequencies present at -100 db threshold in the Divine Omdasji Sound Meditation recording of the third ten minutes

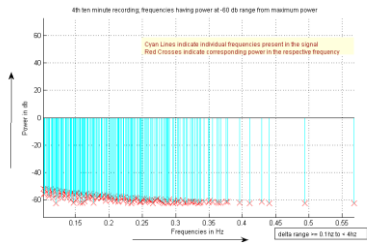

Fig. 34 Delta Range frequencies present at -60 db threshold in the Divine Omdasji Sound Meditation recording of the fourth ten minutes

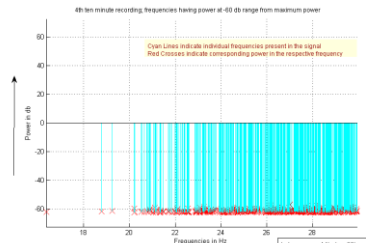

Fig. 35 Beta Range frequencies present at -60 db threshold in the Divine Omdasji Sound Meditation recording of the fourth ten minutes

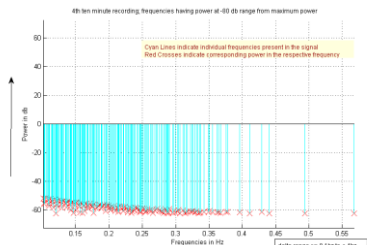

Fig. 36 Delta Range frequencies present at -80 db threshold in the Divine Omdasji Sound Meditation recording of the fourth ten minutes

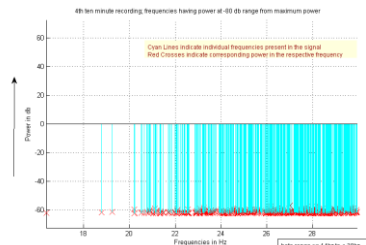

Fig. 37 Beta Range frequencies present at -80 db threshold in the Divine Omdasji Sound Meditation recording of the fourth ten minutes

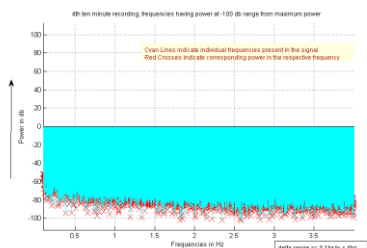

Fig. 38 Delta Range frequencies present at -100 db threshold in the Divine Omdasji Sound Meditation recording of the fourth ten minutes

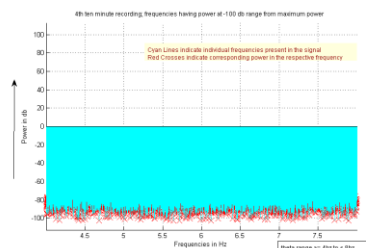

Fig. 39 Theta Range frequencies present at -100 db threshold in the Divine Omdasji Sound Meditation recording of the fourth ten minutes

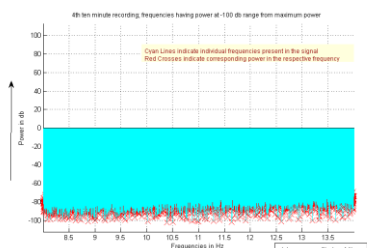

Fig. 40 Alpha Range frequencies present at -100 db threshold in the Divine Omdasji Sound Meditation recording of the fourth ten minutes

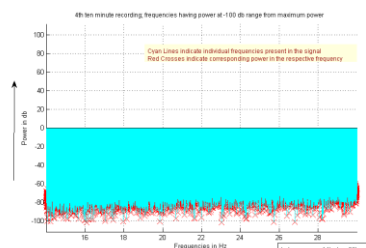

Fig. 41 Beta Range frequencies present at -100 db threshold in the Divine Omdasji Sound Meditation recording of the fourth ten minutes

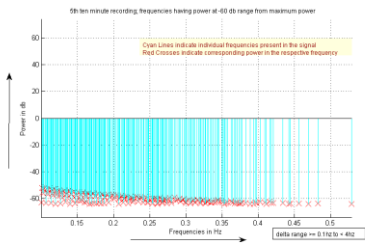

Fig. 42 Delta Range frequencies present at -60 db threshold in the Divine Omdasji Sound Meditation recording of the fifth ten minutes

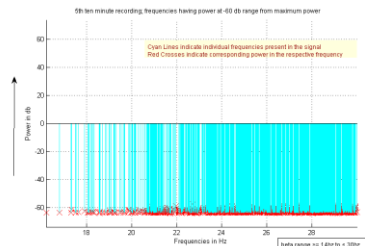

Fig. 43 Beta Range frequencies present at -60 db threshold in the Divine Omdasji Sound Meditation recording of the fifth ten minutes

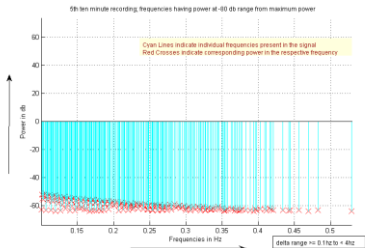

Fig. 44 Delta Range frequencies present at -80 db threshold in the Divine Omdasji Sound Meditation recording of the fifth ten minutes

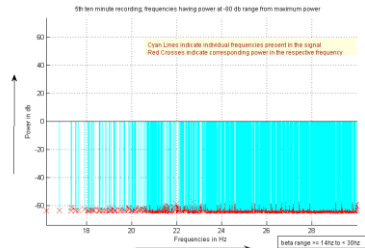

Fig. 45 Beta Range frequencies present at -80 db threshold in the Divine Omdasji Sound Meditation recording of the fifth ten minutes

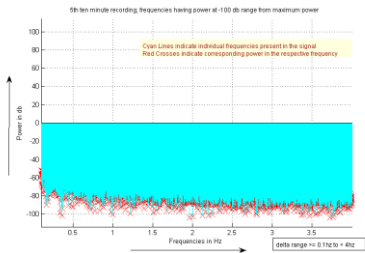

Fig. 46 Delta Range frequencies present at -100 db threshold in the Divine Omdasji Sound Meditation recording of the fifth ten minutes

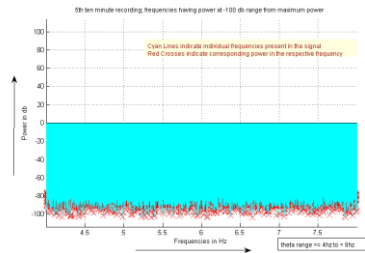

Fig. 47 Theta Range frequencies present at -100 db threshold in the Divine Omdasji Sound Meditation recording of the fifth ten minutes

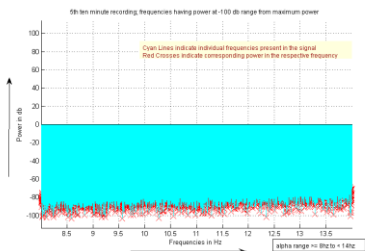

Fig. 48 Alpha Range frequencies present at -100 db threshold in the Divine Omdasji Sound Meditation recording of the fifth ten minutes

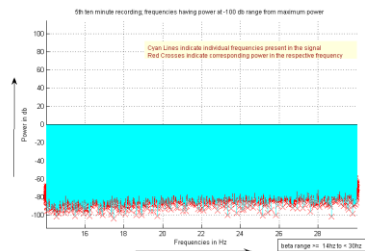

Fig. 49 Beta Range frequencies present at -100 db threshold in the Divine Omdasji Sound Meditation recording of the fifth ten minutes

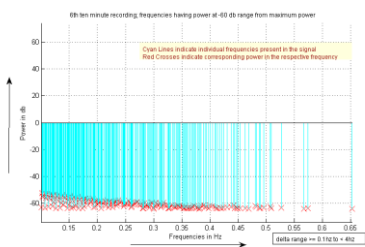

Fig. 50 Delta Range frequencies present at -60 db threshold in the Divine Omdasji Sound Meditation recording of the sixth ten minutes



Fig. 51 Beta Range frequencies present at -60 db threshold in the Divine Omdasji Sound Meditation recording of the sixth ten minutes

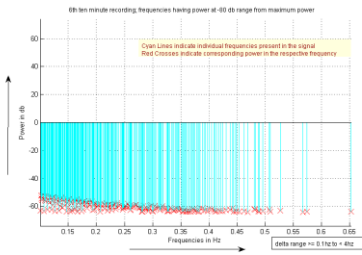

Fig. 52 Delta Range frequencies present at -80 db threshold in the Divine Omdasji Sound Meditation recording of the sixth ten minutes

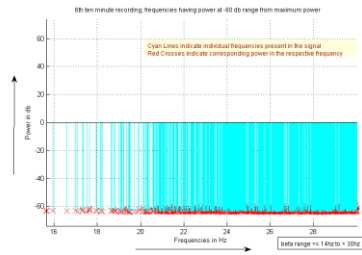

Fig. 53 Beta Range frequencies present at -80 db threshold in the Divine Omdasji Sound Meditation recording of the sixth ten minutes

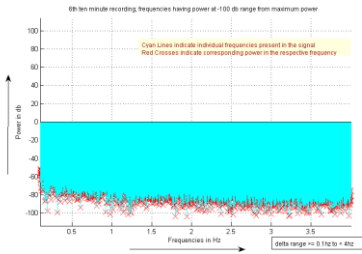

Fig. 54 Delta Range frequencies present at -100 db threshold in the Divine Omdasji Sound Meditation recording of the sixth ten minutes

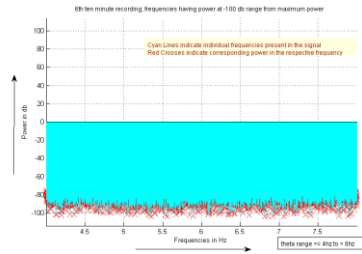

Fig. 55 Theta Range frequencies present at -100 db threshold in the Divine Omdasji Sound Meditation recording of the sixth ten minutes

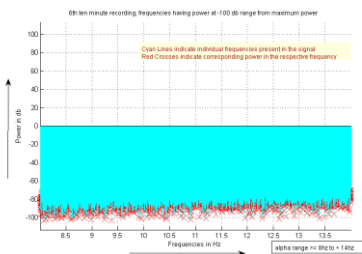

Fig. 56 Alpha Range frequencies present at -100 db threshold in the Divine Omdasji Sound Meditation recording of the sixth ten minutes

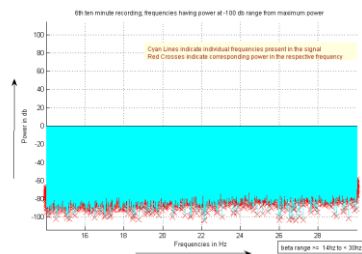

Fig. 57 Beta Range frequencies present at -100 db threshold in the Divine Omdasji Sound Meditation recording of the sixth ten minutes

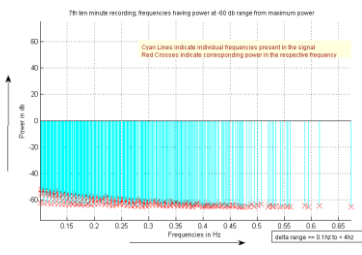

Fig. 58 Delta Range frequencies present at -60 db threshold in the Divine Omdasji Sound Meditation recording of the seventh ten minutes

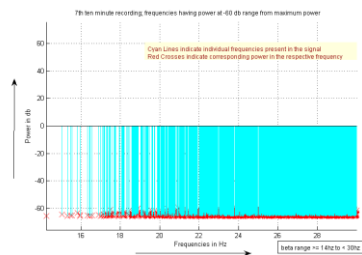

Fig. 59 Beta Range frequencies present at -60 db threshold in the Divine Omdasji Sound Meditation recording of the seventh ten minutes

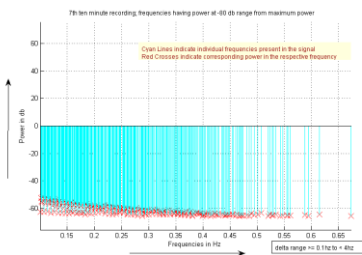

Fig. 60 Delta Range frequencies present at -80 db threshold in the Divine Omdasji Sound Meditation recording of the seventh ten minutes

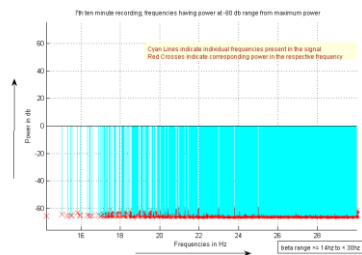

Fig. 61 Beta Range frequencies present at -80 db threshold in the Divine Omdasji Sound Meditation recording of the seventh ten minutes

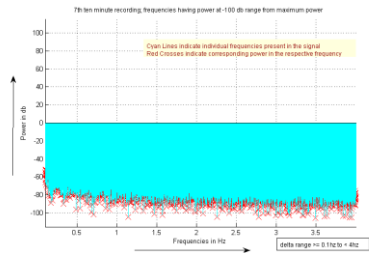

Fig. 62 Delta Range frequencies present at -100 db threshold in the Divine Omdasji Sound Meditation recording of the seventh ten minutes

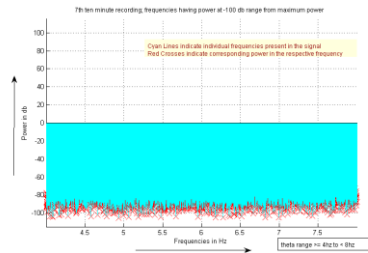

Fig. 63 Theta Range frequencies present at -100 db threshold in the Divine Omdasji Sound Meditation recording of the seventh ten minutes

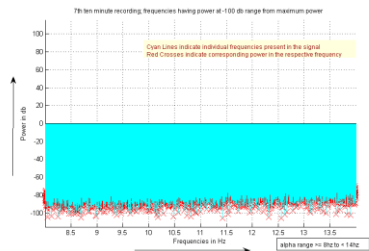

Fig. 64 Alpha Range frequencies present at -100 db threshold in the Divine Omdasji Sound Meditation recording of the seventh ten minutes

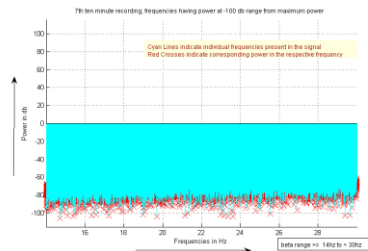

Fig. 65 Beta Range frequencies present at -100 db threshold in the Divine Omdasji Sound Meditation recording of the seventh ten minutes

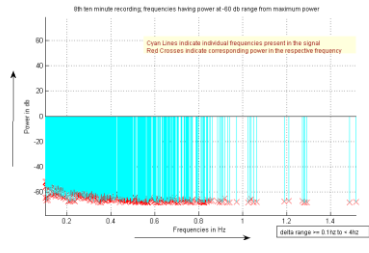

Fig. 66 Delta Range frequencies present at -60 db threshold in the Divine Omdasji Sound Meditation recording of the eighth ten minutes

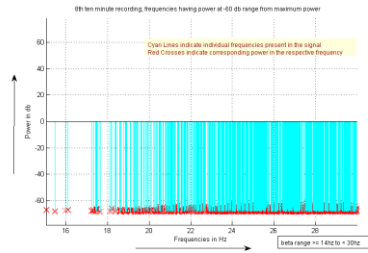

Fig. 67 Beta Range frequencies present at -60 db threshold in the Divine Omdasji Sound Meditation recording of the eighth ten minutes

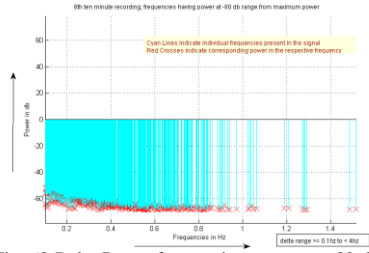

Fig. 68 Delta Range frequencies present at -80 db threshold in the Divine Omdasji Sound Meditation recording of the eighth ten minutes

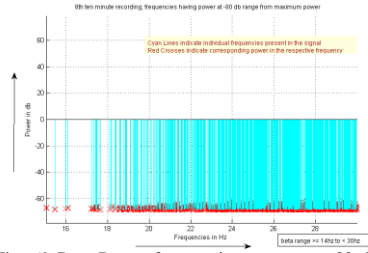

Fig. 69 Beta Range frequencies present at -80 db threshold in the Divine Omdasji Sound Meditation recording of the eighth ten minutes

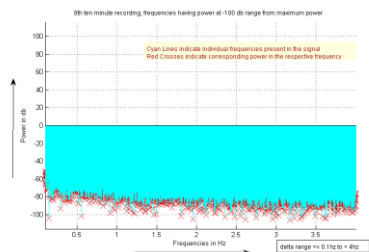

Fig. 70 Delta Range frequencies present at -100 db threshold in the Divine Omdasji Sound Meditation recording of the eighth ten minutes

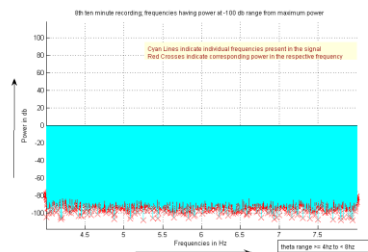

Fig. 71 Theta Range frequencies present at -100 db threshold in the Divine Omdasji Sound Meditation recording of the eighth ten minutes

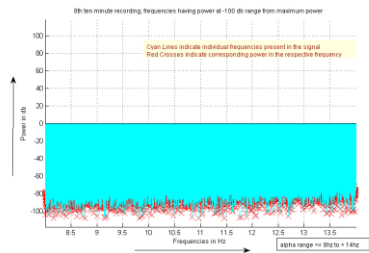

Fig. 72 Alpha Range frequencies present at -100 db threshold in the Divine Omdasji Sound Meditation recording of the eighth ten minutes

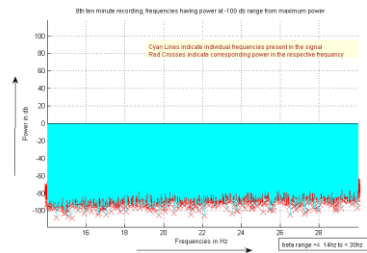

Fig. 73 Beta Range frequencies present at -100 db threshold in the Divine Omdasji Sound Meditation recording of the eighth ten minutes

INFERENCES FROM SPECTRAL ANALYSIS

Figures 4 to 17 show the frequencies present in the Divine Omdasji Sound Meditation first ten minute recording. Figures 18 to 73 represent the frequencies present in the other recordings (from 2nd to 8th ten minute recording) of the Divine Omdasji Sound Meditation. Careful observation of Figures 4 to 17 conveyed the following information.

Delta: Greater than or equal to 0.1 Hz to less than 4 Hz

1. Absent in the -40 db level threshold
2. Present in the -60 db, -80 db & -100 db level thresholds
3. Clusters of frequency components observed below 1Hz and above 3Hz in the Delta Range at -60 db and -80 db level thresholds
4. The entire Delta range of frequencies seem to be present in the -100 db level threshold indicating presence of the complete band of Delta range of frequencies.

Theta: Greater than or equal to 4 Hz to less than 8 Hz

1. Absent in the -40 db level threshold
2. Present in the -60 db, -80 db & -100 db level thresholds
3. Clusters of frequencies observed with non-periodic absence of frequencies within the theta range in both the -60 db and -80 db level thresholds
4. The entire Theta range of frequencies seem to be present in the -100 db level threshold indicating presence of the complete band of Alpha range of frequencies.

Alpha: Greater than or equal to 8 Hz to less than 14 Hz

1. Present in the -40 db, -60 db, -80 db and -100 db thresholds
2. In the -40 db level, frequencies are sparsely present with predominant non-periodic absence of frequencies manifested.

3. Majority of frequencies are present in -60 db & -80 db thresholds, with occasional non-periodic absence of some frequencies.
4. The entire Alpha range of frequencies seem to be present in the -100 db level threshold indicating presence of the complete band of Alpha range of frequencies.

Beta: Greater than or equal to 14 Hz to less than 30 Hz

1. Present in the -40 db, -60 db, -80 db and -100 db thresholds
2. In the -40 db level, minority presence of frequencies is observed with major gaps caused by absence of frequencies.
3. The entire Beta range of frequencies seem to be present in the -60 db, -80 db and -100 db level thresholds indicating presence of the complete band of Beta range of frequencies.

DISCUSSION ON EXPERIMENTAL FINDINGS ON SPECTRAL ANALYSIS

1. Presence of audio frequencies corresponding to EEG rhythms.

The observations (discussed in the previous paragraphs) have thus established the presence of audio frequencies corresponding to the various EEG rhythms.

2. Interpretation of the relationship between the presence of audio frequencies corresponding to EEG rhythms and the human subjects' alteration in their EEG brain waves.

It is conventionally known that human subjects experience alteration in various biophysical responses including EEG rhythms on listening to the Divine Omdasji Sound Meditation. The scope of this research work is related to EEG rhythms and hence the discussion restricts to EEG rhythms only. It is a renowned fact that the EEG rhythms of inexperienced meditators can shift between alpha and beta states, while those of the experienced meditators can shift between any of the four states of delta, theta, alpha & beta.

In the observations of the Divine Omdasji Sound Meditation, it is found that frequencies are present in the alpha and beta ranges at a comparatively higher power level of -40 db (from maximum power level), whereas at lower power levels of -60 db and -80 db the frequencies are present as majority accompanied with absence of some frequencies. The -100 db level is characterized by the presence of frequencies over the entire band completely. This agrees with the conventional wisdom that inexperienced meditators will be able to resonate to meditative guidances at alpha and beta EEG states, while the more experienced meditators will be able to absorb and resonate to the more subtle (lower power) delta and theta EEG states in addition to the alpha and beta EEG states. This absorption of meditative guidance and resonance of the human subjects to the Divine Omdasji Sound Meditation could be explained as phenomena similar to auditory evoked potentials or auditory steady state responses (though the phenomena are not exactly the same).

3. **Interpretation Hypothesis of the phenomena of the guidance exhibited by the Divine Omdasji Sound Meditation to the human subjects' EEG brain waves alterations.**

The discussions under the previous two subheadings have explained the presence of audio frequencies in the Divine Omdasji Sound Meditation corresponding to human EEG brain waves and the relationship between the Divine Omdasji Sound Meditation and alteration in the human subjects' EEG brain waves.

It is found that except some portions of the beta range, the other ranges of delta, theta and alpha fall in the inaudible range of audio frequencies and the Divine Omdasji Sound Meditation is an auditory meditative guidance phenomena.

The medium of guidance or resonance can be explained using the concept of biophotons and their communication [30]. A summary of the above discussion sheds light on the fact that the Divine Omdasji Sound Meditation exhibit a meditative guidance leading the human subjects' EEG brain waves into low and very low frequency rhythms possibly through the concept of biophoton communication, similar to auditory evoked potentials or auditory steady state responses; the only difference being that the frequency ranges of interest fall in the inaudible levels for human beings, called Infrasound.

4. **Safe Infrasound Power levels in the Divine Omdasji Sound Meditation**

The earlier discussions establish the presence of infrasound in the Divine Omdasji Sound Meditation. But there has been widespread

apprehensions and anxiety about infrasound. Infrasound is acoustic energy with frequencies up to 20 Hertz (Hz), having wavelengths of 17 m or more [31].

The American Conference of Governmental Industrial Hygienists (ACGIH) recommends that except for impulsive sound with durations of less than 2 seconds, one-third octave levels for frequencies between 1 and 80 Hz should not exceed a SPL ceiling limit of 145 dB, and the overall unweighted SPL should not exceed a SPL ceiling limit of 150 dB; no time limits are specified for these recommended levels [32].

It was concluded that short periods of continuous exposures to infrasound below 150 dB are safe and that continuous exposures up to 24 hours are safe if the levels are below 118 dB [33].

It is found that the maximum db power of the Divine Omdasji Sound Meditation signal is only -3.9807 db and hence continuous 24 hour exposure to Divine Omdasji Sound Meditation would perfectly be safe, judging by the standards set [33]. Also dense spectra of infrasound is found in the -100db level (from maximum signal power) and gradually decreases until it becomes a sparse spectra in the -40 db level (from maximum signal power) accompanied with total absence of certain frequency ranges (shown in figures 6 – 17; also indicated in Table 1).

The number of frequency components in each range is given in Table 1. The maximum signal power -3.9807 db lies very much within the safe margin for human exposure compared with the levels given [33]. It is hence established that the Divine Omdasji Sound Meditation should be safe for human physiological systems and continuous 24 hour exposure to Divine Omdasji Sound Meditation as a meditative source may not affect the physiological systems because the maximum db power of the Divine Omdasji Sound Meditation signal is only -3.9807 db.

It should be noted that this discussion concerns strictly with the Divine Omdasji Sound Meditation signals below 30 Hz and the standards set for the infrasound [33]. The signal power of the audible Divine Omdasji Sound Meditation signals above 30 Hz has not been investigated here as it does not fall within the scope of this research work.

MEDITATIVE GUIDANCE VIA LOW DECIBEL POWER INFRASOUND IN DIVINE OMDASJI SOUND MEDITATION

The presence of infrasound in the Divine Omdasji Sound Meditation, accompanied with very low power and similarity in the -60db and -80db ranges (as shown in Table 1) was intriguing and sparked interest for further investigation.

Hence, the number of frequency components falling in the respective regions was tabulated for all 8 recordings of the Divine Omdasji Sound Meditation.

The odd numbered recordings correspond to 10 minute recordings from the first second of the Divine Omdasji Sound Meditation, with 5 minute interval between

successive odd numbered recordings. The even numbered recordings are similar to the odd numbered recordings but start immediately after the 5th minute of the Divine Omdasji Sound Meditation and have 5 minute intervals between successive 10 minutes even numbered recordings.

Table 1. Number of Frequency Components in each frequency range in the first ten minutes

	Delta ≥ 0.1 to < 4 Hz	Theta ≥ 4 to < 8 Hz	Alpha ≥ 8 to < 14 Hz	Beta ≥ 14 to < 30 Hz
-40db	0	0	726	660
-60db	530	3618	6168	16140
-80db	530	3618	6168	16140
-100db	4088	4194	6292	16777

Table 1 shows the number of frequency components in each range. The sampling rate is 8K and duration of recording is 600 seconds. The db levels indicate the range between the maximum signal power and the indicated value (in db). The values in the table indicate the number of frequency components present in the signal within the given frequency ranges (in Hz) and the power levels (in db). Though infrasounds lie below 20Hz, this table also indicates the beta range (14 to 30 Hz) since it is essential with regard to meditative perspectives relating to EEG frequency ranges.

Table 2. Number of Frequency Components in each frequency range in the second ten minutes

	Delta ≥ 0.1 to < 4 Hz	Theta ≥ 4 to < 8 Hz	Alpha ≥ 8 to < 14 Hz	Beta ≥ 14 to < 30 Hz
-40db	0	0	0	0
-60db	151	0	0	390
-80db	151	0	0	390
-100db	4079	4168	6269	16771

Table 3. Number of Frequency Components in each frequency range in the third ten minutes

	Delta ≥ 0.1 to < 4 Hz	Theta ≥ 4 to < 8 Hz	Alpha ≥ 8 to < 14 Hz	Beta ≥ 14 to < 30 Hz
-40db	0	0	0	0
-60db	146	0	0	437
-80db	146	0	0	437
-100db	4078	4151	6269	16769

Table 4. Number of Frequency Components in each frequency range in the fourth ten minutes

	Delta ≥ 0.1 to < 4 Hz	Theta ≥ 4 to < 8 Hz	Alpha ≥ 8 to < 14 Hz	Beta ≥ 14 to < 30 Hz
-40db	0	0	0	0
-60db	161	0	0	544
-80db	161	0	0	544
-100db	4078	4167	6269	16764

Table 5. Number of Frequency Components in each frequency range in the fifth ten minutes

	Delta ≥ 0.1 to < 4 Hz	Theta ≥ 4 to < 8 Hz	Alpha ≥ 8 to < 14 Hz	Beta ≥ 14 to < 30 Hz
-40db	0	0	0	0
-60db	211	0	0	1262
-80db	211	0	0	1262
-100db	4080	4166	6274	16773

Table 6. Number of Frequency Components in each frequency range in the sixth ten minutes

	Delta ≥ 0.1 to < 4 Hz	Theta ≥ 4 to < 8 Hz	Alpha ≥ 8 to < 14 Hz	Beta ≥ 14 to < 30 Hz
-40db	0	0	0	0
-60db	221	0	0	1271
-80db	221	0	0	1271
-100db	4079	4166	6274	16773

Table 7. Number of Frequency Components in each frequency range in the seventh ten minutes

	Delta ≥ 0.1 to < 4 hz	Theta ≥ 4 to < 8 hz	Alpha ≥ 8 to < 14 hz	Beta ≥ 14 to < 30 hz
-40db	0	0	0	0
-60db	272	0	0	2219
-80db	272	0	0	2219
-100db	4081	4174	6282	16770

Table 8. Number of Frequency Components in each frequency range in the eighth ten minutes

	Delta ≥ 0.1 to < 4 hz	Theta ≥ 4 to < 8 hz	Alpha ≥ 8 to < 14 hz	Beta ≥ 14 to < 30 hz
-40db	0	0	0	0
-60db	458	0	0	1953
-80db	458	0	0	1953
-100db	4086	4181	6280	16775

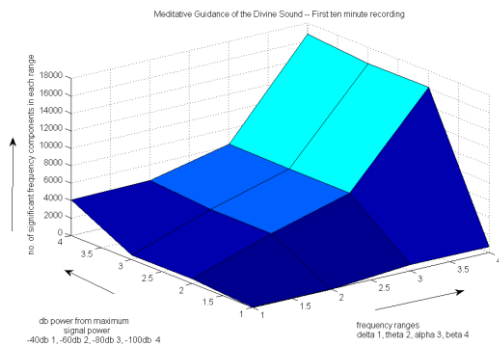

Fig. 74 Plot of the Frequency components in the meditative frequency ranges at various power levels in the first ten minute recording

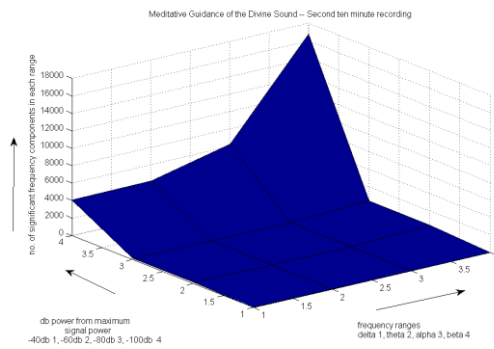

Fig. 75 Plot of the Frequency components in the meditative frequency ranges at various power levels in the second ten minute recording

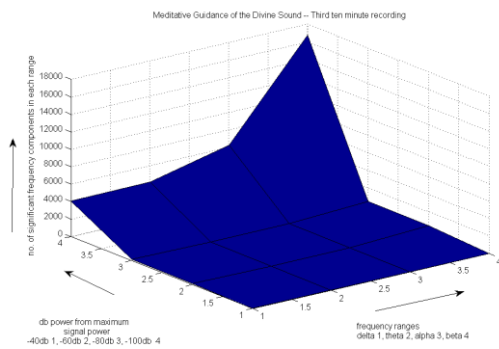

Fig. 76 Plot of the Frequency components in the meditative frequency ranges at various power levels in the third ten minute recording

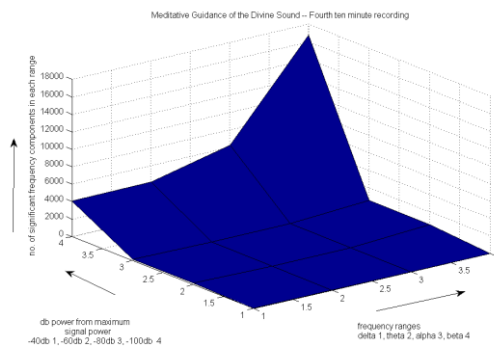

Fig. 77 Plot of the Frequency components in the meditative frequency ranges at various power levels in the fourth ten minute recording

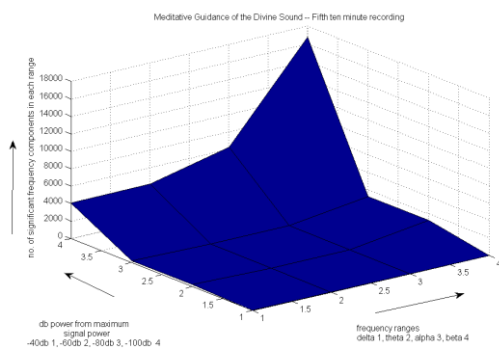

Fig. 78 Plot of the Frequency components in the meditative frequency ranges at various power levels in the fifth ten minute recording

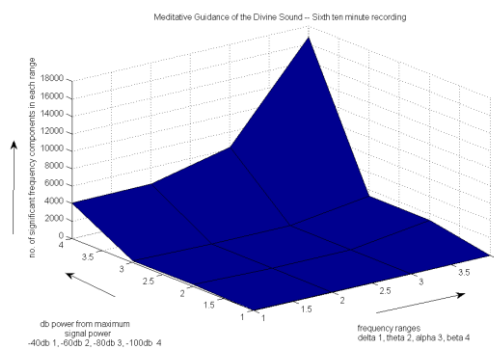

Fig. 79 Plot of the Frequency components in the meditative frequency ranges at various power levels in the sixth ten minute recording

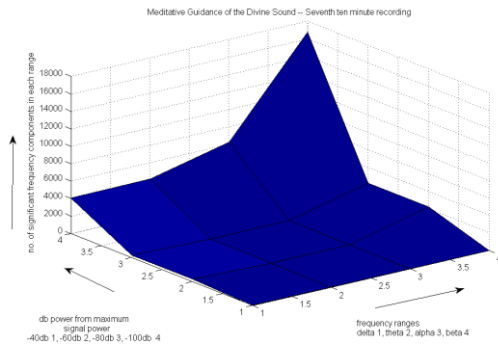

Fig. 80 Plot of the Frequency components in the meditative frequency ranges at various power levels in the seventh ten minute recording

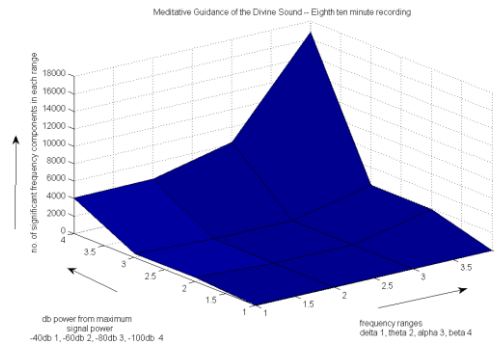

Fig. 81 Plot of the Frequency components in the meditative frequency ranges at various power levels in the eighth ten minute recording

Any meditative guidance should be able to pick up a client from some stage of mental activity and guide them to stable meditative states. Evaluation of the 8 plots (Figs. 74-81) would help to arrive at a generalized inference. The most desired frequency range for deepest meditative state is the delta range, where there is total peace and calm. The surface of the plot (Fig. 74) slopes from high ranges of EEG meditative spectrum (beta) to the lower ranges. If it is assumed that the slope of the plot denotes the meditative guidance, then this hypothesis has to be checked with all the plots. The plot of the first ten minute recording (Fig. 74) up to the first ten minutes is considered. The plot slopes from -100 db of the beta range and gradually goes down to the delta range. It can be assumed that the DS meditative guidance initiates meditation from even clients who are even at high EEG meditative ranges of beta. The high concentration of DS samples at the -100db level beta range might imply that the DS meditative guidance acts so subtly that it picks up the meditative client at beta and initiates meditation so subtly (-100 db of maximum signal power) that even the client may not be aware of it.

Then, the slope of the plot gradually slopes towards the lower frequency ranges. The slope up to the theta level is very gradual and suddenly slopes towards delta. Perhaps, this might explain better the meditative guidance of the Divine Omdasji Sound Meditation. The Divine Omdasji Sound Meditation may be picking up the client at beta levels, so subtly without the awareness of the client and then slowly brings the client to theta levels and then tries to bring about a rapid change to delta levels. This could be the reason for clients rapidly going into very deep meditative states on the Divine Omdasji Sound Meditation meditative guidance. These inferences can be accepted if the other plots also corroborate the same inferences.

The plot of the second ten minute recording (Fig. 75) is considered. It is found that similar to the first plot, the clients may be able to be picked up from higher levels of

beta, at very subtle levels of -100 db. But a different characteristic is observed here. The slope of the plot is very rapid and settles down at the lower EEG meditative levels rapidly. This corroborates the inference of the first plot that the DS meditative guidance brings the clients to very low EEG states in the first few minutes itself as the second plot is actually an overlap of the first plot as the first plot is the recording from 0 to 10 minutes and the second plot is the recording from 5 to 15 minutes. Judged in conjunction, it is inferred that the Divine Omdasji Sound Meditation meditative guidance settles the client at very low meditative states in the first 15 minutes itself.

The Divine Omdasji Sound Meditation meditative guidance might start slowly; leading the client into lower EEG states and then rapidly lead the client into very low EEG meditative states that are symbolic of very good meditation. It is found that the inferences from the first two plots corroborate and also support each other.

The plot of the third ten minute recording (Fig. 76), 15 to 25 minutes of the Divine Omdasji Sound Meditation is considered. The plot of the third ten minute recording also resembles the second plot. The only possible inference could be that the meditative guidance leads the client into very low EEG meditative states. When the client has already reached very low EEG meditative states in the first two plots itself, then the third plot seems to be redundant meditative guidance.

This can be explained as follows: The Divine Omdasji Sound Meditation meditative guidance leads the client to very low EEG meditative states but the client may have experience internal or external disturbance to meditation or may even oscillate between meditative states. However may be the case, the meditative guidance exhibited by third plot ensures that the client is led into very low EEG meditative states, by being able to pick them up from higher states (in case if they

have wandered into higher states due to internal or external reasons).

Similar effects are observed in all plots henceforth and the same inference seems to hold. In summary, the Divine Omdasji Sound Meditation meditative guidance may be able to pick up a client from higher EEG states (even beta), in a subtle lead (-100 db power levels from maximum signal power) and guide them to very low EEG meditative states in about 15 minutes.

Also, it is found that the Divine Omdasji Sound Meditation meditative guidance may be able to maintain the very low EEG meditative states of the client, by being able to lead them again back to very low meditative EEG states (in the event of oscillation or drifting about meditative states) as inferred from the plots from the DS recordings of the second, third and fourth quarters of the hour.

The very low number of frequency components in theta and alpha ranges in many of the tables (Tables 2-8) would indicate that the DS meditative guidance permits clients to settle down in the theta and alpha levels. Yet, the presence of frequency components in the delta levels in many of the tables would indicate that the DS meditative guidance does offer leads in the delta levels as the delta meditative state is difficult to achieve and a client who goes into delta meditative states would need guidance to persist in the delta meditative states. Hence, the DS meditative guidance offers guidance at delta meditative states for a very long time.

BIOPHOTONIC CONSCIOUSNESS COMMUNICATION

The research on bio-informational aspects of biophotons in the IR to UV range can be traced back to Alexander G. Gurwitsch more than seventy years ago. Despite serious experimental difficulties it is now clear to every scientist working in this field that photon emission could be detected from nearly all living cells. Bio-photons are characterized by their quantum character and are supposed to escape from a coherent field [30].

Biophotons

Biophotons have frequencies in the range 200-800 nm. They are coherent weak radiation, almost 20 orders of magnitude weaker than common fluorescence of photophosphorence. Biophoton emission is a signature of living matter (www.helsinki.fi/~matpitka/articles/biophotons.pdf as on March 1, 2007). According to the biophoton theory developed on the base of these discoveries the biophoton light is stored in the cells of the organism - more precisely, in the DNA molecules of their nuclei - and a dynamic web of light constantly released and absorbed by the DNA may connect cell organelles,

cells, tissues, and organs within the body and serve as the organism's main communication network and as the principal regulating instance for all life processes. The processes of morphogenesis, growth, differentiation and regeneration are also explained by the structuring and regulating activity of the coherent biophoton field. The holographic biophoton field of the brain and the nervous system, and maybe even that of the whole organism, may also be basis of memory and other phenomena of consciousness, as postulated by neurophysiologist Karl Pribram and others. The consciousness-like coherence properties of the biophoton field are closely related to its base in the properties of the physical vacuum and indicate its possible role as an interface to the non-physical realms of mind, psyche and consciousness (http://www.transpersonal.de/mbischof/englisch/webb_oookeng.htm as on March 1, 2007). Biophoton emission is a general phenomenon of living systems. It concerns low luminescence from a few up to some hundred photons-per-second per square-centimeter surface area. At least within the spectral region from 200 to 800nm. The experimental results indicate that biophotons originate from a coherent (or/and squeezed) photon field within the living organism, its function being intra- and inter-cellular regulation and communication [34].

Biophoton Communication

Biological Systems are governed by the special interaction of a coherent electromagnetic field (biophotons) and biological matter. There is a permanent feedback coupling between field and matter in a way that the field directs the location and activity of matter, while matter provides the boundary conditions of the field. Since the field is almost fully coherent, the interference patterns of the field contain the necessary information about the regulatory function. The interference structures are not stable, but vary in concordance with the rather complex spatio-temporal interactions between field and matter (http://www.lifescientists.de/ib0203e_1.htm as on March 2, 2007).

BIOPHOTON COMMUNICATION AMONG MEDITATIVE CONSCIOUSNESS FIELDS

An understanding of the earlier paragraphs on Meditative Consciousness fields suggests that the human source of the meditative music input and the human meditative subject would be generating a meditative consciousness field. Inferring in conjunction with the discussion on Biophoton Communication given above, the authors suggest a model of *Biophotonic Consciousness Communication* where the Meditative Consciousness Field of the human source would interact with the Meditative Consciousness Field of the human subject through biophotonic communication, where the alterations in

consciousness states of the human subject caused due to Meditative Music Input would actually be guided by the alterations in consciousness states of the human source of meditative music input through biophotonic communication. Rephrased in a simple way, the human source would guide the human subject in alterations of consciousness states through biophotonic communication.

ANALYSIS OF MULTIPLE PHASE LOCKED LOOP MEDITATIVE GUIDANCE USING BIOPHOTONIC COMMUNICATION AND BIOACOUSTIC FIELDS

Referring to earlier paragraphs, it can be understood that the Divine Omdasji Sound Meditation guides meditating human subjects into deep meditation using Low Decibel Power Infrasound present in the chant. Also, we understand that the meditative consciousness fields of the human source and the human subject interact via biophoton communication. Discussions in previous sections of the paper indicate that the Divine Omdasji Sound Meditation guides the meditating human subject into very deep meditative states characterized by very low frequency brainwaves and continues the guidance holding them in very deep meditative states using the low frequency infrasound present in the Divine Omdasji Sound Meditation chant.

Analytical examination yields the insight that there are actually two processes that perform meditative guidance in the Divine Omdasji Sound Meditation, viz., a biophotonic communication among the consciousness fields between those of the meditating lead/source and the meditating subject (that alters the consciousness states leading the subject to deep meditation) and a bioacoustic field between the meditating lead/source and the meditating subject manifested as low frequency infrasound present in the Divine Omdasji Sound Meditation chant (that guides

the brain waves of the subject into states characteristic of deep meditation).

A logical inference is that the presence of two meditative guiding processes in Divine Omdasji Sound Meditation could be the reason for the much renowned and conventionally accepted fact in society that the Divine Omdasji Sound Meditation guides meditating human subjects into very deep meditative states effortlessly in a very short time and also continues to hold them in very deep meditative states.

However, these inferences are valid only when there is one meditating lead/guru and one meditating subject/client. In cases where multiple meditating subjects/clients are guided in meditation simultaneously, certain concepts related to phase locked loops need to be suitably used to offer better explanation of meditative guidance as given below.

Phase Locked Loop

The Phase Locked Loop (PLL) is a conventional circuit used to lock to the input frequency when the frequency is within the PLL’s bandwidth.

The PLL is basically a feedback control system that controls the phase of the Voltage Controlled Oscillator (VCO). The input signal is applied to one input of a phase detector. The other input is taken from the output of a Divide by 1 Counter. The output of the Phase Detector will be a difference of the phases of the two inputs, and is applied to the Loop Filter. The Loop Filter determines the dynamic characteristics of the PLL and controls the VCO. The output frequency is N times the input, governed by the Divide by N counter. In a specific case of N = 1, the Divide by N counter becomes a Divide by 1 Counter, and the output frequency is exactly the same as the input frequency.

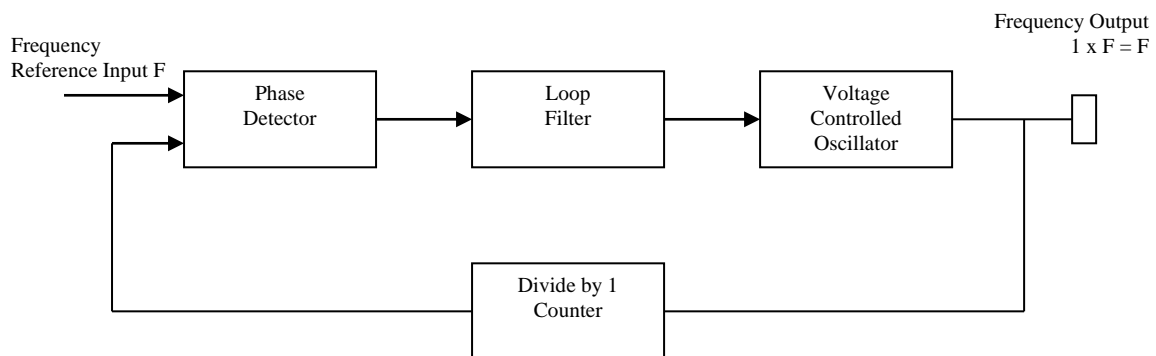

Fig 82. Block Diagram of a Phase Locked Loop (Courtesy: www.cardinalxtal.com/docs/notes/cardinal_phase_lock_loop_basics.pdf, as on Feb 28, 2007)

Figure 82 shows a Phase Locked Loop frequency multiplier. Since n = 1, the Voltage Controlled Oscillator gives an Output that is 1 times F, that is, F itself.

The design of the Loop Filter is decided by the proposed application of the PLL. If the PLL expects a single input frequency, then the bandwidth of the Loop Filter can be narrow. If the PLL is required to acquire and track a signal, then the bandwidth of the Loop Filter will be suitably larger [35].

Extending the PLL as a multiple phase locked loop and applying inferences derived from earlier paragraphs in conjunction with earlier findings [36], it can be understood that the Divine Omdasji Sound Meditation leads multiple meditating subjects into deep meditative states on the strengths of the relationship between the meditating lead/guru and the meditating subjects/clients brought about by biophotonic communication and bioacoustic fields in multiple phase locked loop manner.

Earlier Analysis

An analysis was attempted of the expected instantaneous results of the Multiple Phase Locked Loop Meditative Guidance using BioPhotonic Communication and BioAcoustic Fields (herein after referred to as the Process) on multiple simultaneously meditating subjects/clients [37]. Personal state of mind or acceptance of the process could be a positive catalyst, where the process is able to work without hurdles caused by non-synchronism of the meditating lead/guru and the meditating subjects/clients.

Higher level activities in the brain during the process could induce wastage of the mental resources of the meditating clients, consequently affecting synchronism of the lead and the clients. Force of the intent of the client and strength of the consciousness field brought by faith in the process and surrender of the self could possibly increase efficiency of the process. However, absence of faith in the process cannot be taken as a constraint, as it violates the primary analytical inference that the process should be able to calm and soothen the mind. Absence of faith in the process could possibly create an agitated consciousness field in the client which could easily be calmed down by the process, and the process should work, the end result being the same except for the time taken to soothen the agitated consciousness field and achieve synchronism between the lead and the client. Judging from the analytical inferences arrived at, it can be understood the process should also have some limitations. These limitations to efficient working of the process could possibly arise due to the influence of alcohol, or heavy medication or drugs, where the biological systems of the body nor the consciousness fields of the referred client is unable to synchronize with that of the meditating lead/guru.

It can be understood that loss of sensitivity of the biological and mental systems of the client could

possibly be the reason, in which case the power levels of the Divine Omdasji Sound Meditation may suitably increased to overcome the loss of sensitivity of the referred client. However, if required, such clients may be treated by the process isolated from normal clients, as normal clients may not need higher power levels.

One advantage of the process from the perspective of the client could be that apriori knowledge of the process may not be required, as conventional observations of the process in the past has noted that the process is effective on clients who are not aware of the actual mechanism of the process. Hence, these scientific analyses done so far, have only corroborated with conventional observations, though explaining in scientific ways the actual process involved. Future research work is expected to concentrate on providing scientific explanations to effects of the process already observed conventionally. Further, it is expected that some subtle effects conventionally unnoticed may also be unraveled.

Retro-Analysis

In retrospect, there arise a few queries. The above analysis may be valid when the distance between the meditating lead/guru and the meditating subjects/clients is very small. However, when the distance between the lead and the clients is very large compared to the speed at which sound travels, then the distance factor assumes prominence. In such a case, the bioacoustic field effect in the process decreases, while the biophotonic communication and the consciousness fields factor are not affected. In order to achieve the same efficiency of the process as obtained earlier, to the case where the effect of the bioacoustic field decreases, then there can be a suitable modification in the weightage given to the three factors, *viz.*, bioacoustic field, biophotonic communication and consciousness fields. When weightage given to the consciousness fields is increased, then communication between the consciousness fields of the meditating lead/guru and the meditating subjects/clients can be accomplished using the universal consciousness field [38]. Using the same field, biophotonic communication can be established at a relatively shorter time. The bioacoustic field, can be generated as an acoustic field, with the same embedded acoustic guidance for meditation, which when linked by the clients to the Universal Consciousness Field, finds the meditative guidance embedded in it which helps to replicate the bioacoustic field meditative guidance. The above inferences yield insight that with suitable modifications, the meditative guidance offered by the Divine Omdasji Sound Meditation can be effectively utilized by simultaneously meditating clients even at very far distances from the meditating lead/guru with suitable modifications in the generation of the bioacoustic field

and the consciousness field linkages and consciousness communications.

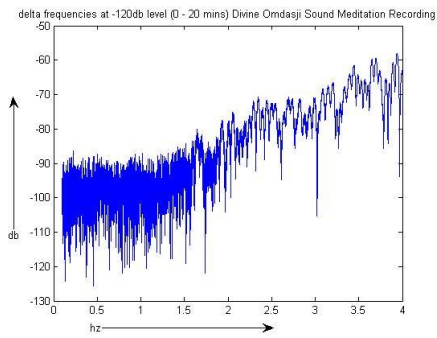

Fig 83. Delta frequencies at -120db level (0-20 minutes)

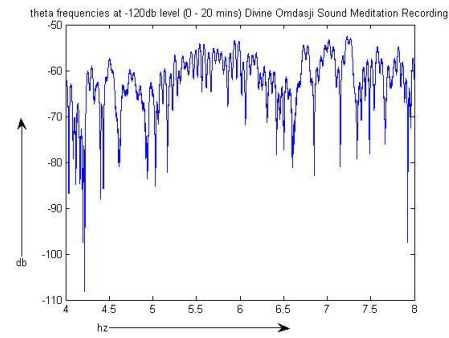

Fig 84. Theta frequencies at -120db level (0-20 minutes)

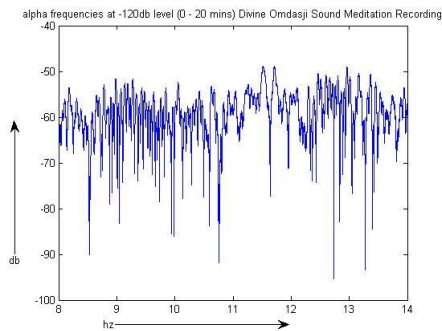

Fig 85. Alpha frequencies at -120db level (0-20 minutes)

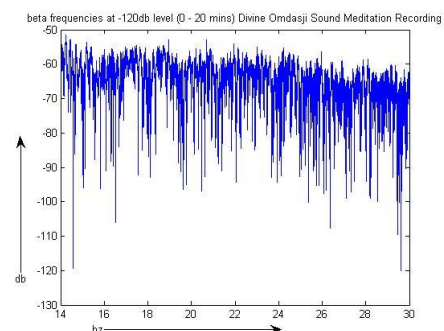

Fig 86. Beta frequencies at -120db level (0-20 minutes)

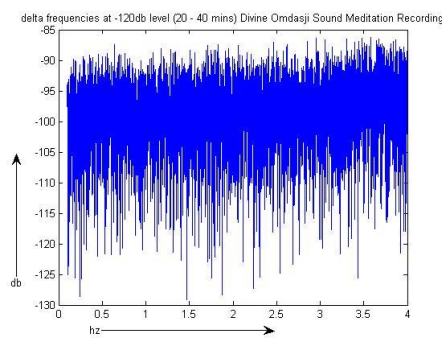

Fig 87. Delta frequencies at -120db level (20-40 mins)

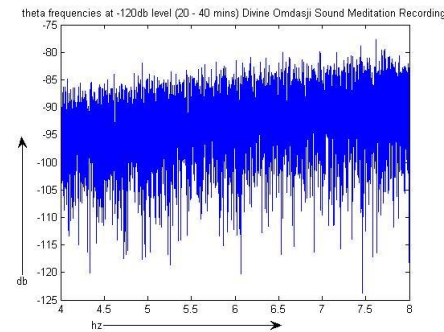

Fig 88. Theta frequencies at -120db level (20-40 mins)

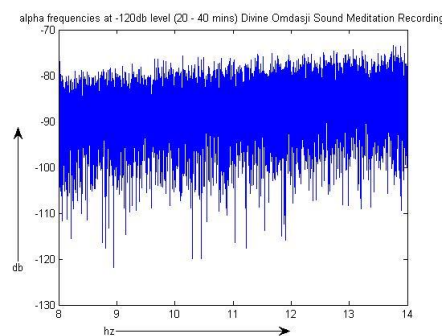

Fig 89. Alpha frequencies at -120db level (20-40 mins)

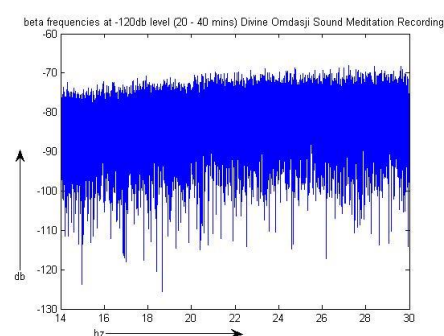

Fig 90. Beta frequencies at -120db level (20-40 mins)

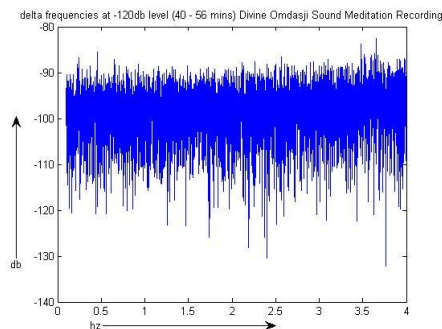

Fig 91. Delta frequencies at -120db level (40-56 minutes)

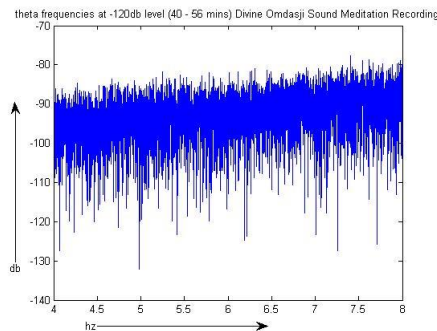

Fig 92. Theta frequencies at -120db level (40-56 minutes)

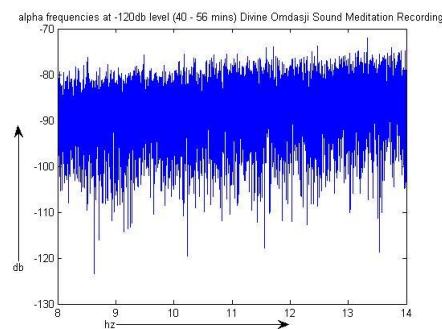

Fig 93. Alpha frequencies at -120db level (40-56 minutes)

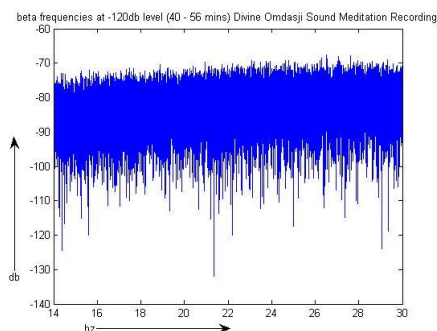

Fig 94. Beta frequencies at -120db level (40-56 minutes)

AWARENESS OF CONSCIOUSNESS STATES

When a subject is guided into meditation, the subject is aware of the change in the consciousness state and is able to sense the entry and prevalence in deep meditative states.

Conventional knowledge of meditation and its states indicates that a meditating subject is sometimes able to sense the meditative state as well as the fully conscious state simultaneously, which is very intriguing as a human being can be aware of

- either the conscious state aware of the ambience and the surroundings or
- the meditative state,

but awareness of both consciousness states simultaneously is a special phenomenon which has eluded comprehension. With reference to the strengths of the Divine Omdasji Sound Meditation indicated in the previous paragraphs, there has been a keen interest kindled to investigate whether the Divine Omdasji Sound Meditation can shed light on Dual Consciousness State Awareness. Therefore, investigations on the Divine Omdasji Sound Meditation were carried out at a lower db level, including more span of time. Earlier experimentation has been done upto -100db with 10 minute signal. Hence it was proposed to investigate the Divine Omdasji Sound Meditation chant at -120db level for spans of 20 minutes each. Hence, the Divine Omdasji Sound Meditation chant was split up into 3 signals of 20 minute duration each, while the last signal alone

was of 16 minute duration and the experiments were carried out at the level of -120db. The graphs shown in figures 83-94 were then obtained. Analysis of the frequency spectra shown in figures 83-94 indicate that, barring the first 20 minute spectra (figures 83-86), the rest of the spectra (figures 87-94) are densely populated with frequency components at the -120db level at delta, theta, alpha and beta ranges. However, the first 20 minute spectra at -120db level shown in figures 83-86 indicate a unique pattern, indicate varying degrees of sparseness and density of spectra. Interpreting this pattern in conjunction with the earlier finding reported in previous paragraphs that the Divine Omdasji Sound Meditation meditative guidance settles the client at very low meditative states in the first 15 minutes itself indicates that the pattern shown in figures 83-86 needs to be studied in depth. This meditative guidance as inferred in previous paragraphs guides the subject(s) into deep meditative states. However, the triggering medium used here for guiding the subject(s) into deep meditative states is the Divine Omdasji Sound Meditation chant. Hence, the first 15 minutes of the Divine Omdasji Sound Meditation chant should hold information regarding guidance of the meditating subject(s) into deep meditative states. Critical Examination of figures 83-86 indicates that the dense spectra of delta frequency components might hold the key to guiding the meditative subject(s) into deep meditative states in conjunction with the inferences defended earlier. Therefore, the meditating

subject(s) is guided into deep meditative states in the first 15 minutes itself and is aware of the deep meditative state and the dense spectra of figure 83 also supports it. Sparse spectra in figures 84 and 85 indicate that much leads are not given in surface meditative states and the strength of the leads to less deeper meditative states is weak compared to the dense spectra indicated in figure 83. But figure 86 also indicates dense spectra of frequency components though not as dense as indicated in figure 83. Inferred in conjunction with earlier discussions, defense and inferences, the meditating subject(s) is also aware of the ambience and the surroundings as in a normal state of awareness, though not so intense as the deep meditative state.

However, awareness of two states *viz.*, (1) the deep meditative state and (2) the normal state, is sensed by the meditating subject and the meditating subject is aware of dual consciousness states. Hence it is understood that that the Divine Omdasji Sound Meditation, apart from all of its strengths inferred from the previous paragraphs also possesses the unique phenomenon of guiding meditating subject(s) into dual consciousness states or helps the meditating subject(s) to be uniquely aware of dual consciousness states *viz.*, the deep meditative state characterized by delta waves and the awareness state characterized by beta waves.

ANALYSIS OF AWARENESS OF DUAL CONSCIOUSNESS STATES

Apart from the awareness of Dual Consciousness States guided by the Divine Omdasji Sound Meditation, further analysis of figures 83-94 indicates that the frequency spectra of figures 87-94 are distinctly different from the frequency spectra of figures 83-86 with specific reference to the dense spectra observed in the delta, theta, alpha and beta ranges, which indicates that there is a guided awareness of a single meditative consciousness state. Extending the findings from the previous paragraphs, it can be understood that the Divine Omdasji Sound Meditation guided awareness of dual consciousness states (indicated by graphs of the 0-20 minute duration) merges into a single meditative state (indicated by graphs of the 20-40 minutes and 40-56 minutes), *ie.*, the Divine Omdasji Sound Meditation guides the meditating human subject to be aware of the deep meditative consciousness state and the awake consciousness state and later guides into an awareness of a single meditative consciousness state characterized by disappearance of the awake consciousness state into the meditative state. In short, the awareness of the awake state is erased/deleted/submerged into the awareness of the meditative state. This is an intriguing phenomenon. Hence, further literature survey was done on the beta

state, which indicated that the beta state was characteristic of mental depressive disorders, anxiety symptoms, stress-related intrusive thoughts, loss of sleep, loss of immunity, drug intake (abuse) [39-42]. When the awareness of beta state is deleted/erased/submerged into a deep meditative state characterized by delta state, then it implies that the beta state of the meditating subject is deleted/erased/submerged into the delta state and the cause of such deletion/erasure/submerge of the beta into the delta state is a cure for mental depressive disorders, anxiety symptoms, stress-related intrusive thoughts, loss of sleep, loss of immunity and drug intake (abuse), *ie.*, the Divine Omdasji Sound Meditation is a cure for mental depressive disorders, anxiety, stress-related intrusive thoughts, loss of sleep, loss of immunity and drug intake (abuse).

It is a widely known fact that reduction/loss of immunity accounts for a vast majority of human diseases, encompassing acute, chronic and other types of loss of immunity. The rest of diseases affecting human beings are a small minority. Analyzing this in relation to the Divine Omdasji Sound Meditation being a cure for mental depressive disorders, anxiety symptoms, stress-related intrusive thoughts, loss of sleep, loss of immunity and drug intake (abuse) implies that the Divine Omdasji Sound Meditation cures a vast majority of human diseases arising due to reduction/loss of immunity, including a portion of diseases that do not fall under this category like stress related disorders or anxiety. Therefore, the Divine Omdasji Sound Meditation is a Universal Cure for Human Diseases.

PSYCHOLOGICAL ACCEPTANCE OF THE DIVINE OMDASJI SOUND MEDITATION AS A UNIVERSAL CURE FOR HUMAN DISEASES

Some of the ancient scientific doctrines handed down from Ancient Greece and the Middle Ages had to undergo a paradigm change during the Scientific Revolution which laid the foundations of Modern Science [43]. One of the first pioneering works that heralded in the Scientific Revolution was the Nicolaus Copernicus's *De revolutionibus orbium coelestium* (On the Revolutions of the Heavenly Spheres) leading to the understanding of the fact that the Earth was not the Center of the Universe, which was not accepted then by the people. Though the Foundations of Modern Science are well established now, still history reveals that almost all of the new revolutionary scientific concepts/techniques/treatises were never accepted in the beginning and it took considerable time to be accepted by contemporary scientists and experts and a longer time for acceptance by society.

Any new Scientific Concept encounters various phases in its acceptance. Three phases on the road to acceptance according to Bruce G. Charlton [44] are:

1. The theory is not true;
2. The theory is true, but it is unimportant;
3. The theory is true, and it is important – and it was known all the time

The above facts read together with the scientific findings obtained by scientific investigations on the Divine Omdasji Sound Meditation yields significant knowledge on the acceptance of the Divine Omdasji Sound Meditation as a Universal Cure for Human Diseases. The Divine Omdasji Sound Meditation was used as a cure for some of the Human Diseases for quite a few decades (even before the start of this series of scientific investigations on the Divine Omdasji Sound Meditation). However, scientific documentation methods were not followed and hence, evidence for use of the Divine Omdasji Sound Meditation for treatment of some of the Human Diseases cannot be presented now. A direct consequence manifests in reduction and modification in the stages to acceptance to the Divine Omdasji Sound Meditation as a Universal Cure for Human Diseases. Hence the road to universal acceptance of the Divine Omdasji Sound Meditation as a Universal Cure for Human Diseases inspite of exhaustive investigation and scientific publication can be summarized as under modified stages (2) and (3) with deleted stage (1) of the proposition of Bruce G. Charlton [44] as

- a. The Divine Omdasji Sound Meditation as a Cure for Human Diseases is true, but it is unimportant (perhaps due to convincing publicity given by other methods)
- b. The Divine Omdasji Sound Meditation as a Cure for Human Diseases is true, and it is important – and it was known all the time

Hence, it can be summarized that universal psychological acceptance of the Divine Omdasji Sound Meditation as a Cure for Human Diseases will happen only after the above two stages (a) and (b) are fulfilled in time.

CERN NEUTRINO EXPERIMENTS, SCIENTIFIC TEMPERAMENTS AND SPIRITUAL TREATISES

The speed of light is a Scientific Constant (denoted by c) [45] having a value of 186,282 miles per second [46] or 2.99 lakh kilometers per second (approximately). This paves the foundations for the Einstein's theory of relativity and special relativity [47] which later was applied by Albert Einstein in 1917 to model the structure of the Universe [48]. The world has come a long way in various scientific theories, postulates, inventions and applications since

1917 based on the Einstein's model of the Universe. One of the first significant challenges to the Einstein's model of the Universe was the result of the CERN Neutrino Experiments done in September and November 2011 which indicated that Neutrinos travel faster than light [49]. This was accompanied by varied reactions from the Scientific Community, some arguing in favor of the CERN Neutrino Experiments while many others chose to argue against the CERN Neutrino Experiments, including one scientist who, so confidently announced that he will eat his boxer shorts on Live Television [50] while the first results of the CERN Neutrino Experiments were published in September 2011, who later attempted an escapist's route stating that he was not yet ready to get out his knife and fork [51] when the second CERN Neutrino Experiments in November 2011 agreed with the findings of the first experiments done in September 2011, whose clever ploy to make people think that he was so confident (against the possibility of the correctness of the CERN Neutrino experimental results) was brushed aside [52]. The CERN Scientists who had done the experiments have declared that they have included some modifications in the second experiment that had the capability to remove some of the potential errors that could have happened in the first set of experiments [53]. Judging by the world-wide reactions to the CERN Neutrino Experiments, there are widespread varied reactions ranging from extensions of support to the findings, expressions of skepticism, critical maligning comments inclusive of an amusing challenge to eat boxer shorts on live television have been witnessed. There might be more experiments carried out all over the world in future, for or against the CERN Neutrino experimental results, and the most convincing argument might stay for future generations forcing the world to prepare for many changes in principles, postulates, technology & applications however the case may be, for or against the CERN Neutrino experimental results. This might possibly include changes in policies of various governments around the world, their plans for the future, modifications/revisions in budgetary outlays, changes in Technology and its Application. This shakeup in a century old Einstein's treatise is thoroughly causing worry to the World, its people, the scientists and the common man. Scientific temperament though armed and safeguarded with systematic research methods still remains elusive, where the knowledge of the yesteryears get changed today, with no certainty whether the knowledge would remain the same or forced to be modified or revised or improved.

However, the Spiritual Treatises have been building up from time immemorial adding to the previously existing domain of knowledge. Extending the principle of meditative guidance explained in previous

paragraphs, the additions in the knowledge domain to previously existing spiritual knowledge can be attributed to consciousness based guidance resulting in enlightenment of existing spiritual knowledge hitherto unknown, due to a consistent cohesive structural evolution of the Spiritual Consciousness.

At the same time, there is a minor offshoot from the CERN Neutrino Experimental Results, viz, the relationship between velocity of light and time dilation [54]. The time dilation factor approaches infinity as the velocity of a particle approaches the velocity of light. The Einstein's model of the Universe is modeled assuming that nothing moves faster than light [48, 55]. This results in a finite size and span for the Universe. When Neutrinos are discovered now with speed greater than that of light, it starts shrinking the Universe from its earlier size, as all astronomical distances have been calculated in light years (a light year being the distance that light would travel in one year) which would now be smaller distances when calculated using Neutrino years (if one Neutrino year is taken as the distance that a Neutrino would travel in one year). An extreme case of the time dilation factor in conjunction with the Universe become smaller (when calculated using Neutrino years), could even enable one to cross the entire Universe, which coincides with conventional Spiritual knowledge that travel across the Universe is possible. However, absence/weakness in scientific principles among teachers of Spirituality prevented them from explaining this sufficiently. Yet, after so many thousands of years since such Spiritual knowledge has been in existence, it is able to be explained now scientifically that travel across the Universe is possible if explained using Neutrino years and an extreme case of the time dilation factor. With the bubble bursting on scientific treatises even as respected as Einstein's theories, it is now time to garner the strengths of the elusive scientific temperament, pool in knowledge from various domains and experts into the collective consciousness of spirituality helping to understand phenomena that have been hitherto unable to be explained for the sake of various difficulties in scientific understanding (as had been witnessed during publication of the results of the CERN Neutrino Experiments). If this is able to be accomplished, then the good that has been extended to mankind by scientific interpretation of the Divine Omdasji Sound Meditation can be done for all Spiritual Treatises yielding more good and benefit for the human race instead of standing divided in the event of new scientific revolutionary results, refusing to accept them and sometimes offering challenges to eat boxer shorts on live Television, which is not worthy of the nobility and respect extended to scientists by the world. Scientific Temperament needs to evolve out of its elusiveness and use collective consciousness to achieve consistency. At the limit of the elusiveness of

the Scientific Temperaments, the consistent spiritual treatises stand strong over thousands of years, with collective consciousness based scientific investigations yielding more insight into spiritual phenomena hitherto unexplained earlier.

CONSCIOUSNESS ENLIGHTENMENT VIA SCIENTIFIC REASONING SUPPORTED BY SPIRITUAL TREATISES

When a client sits in Meditation anywhere in the world and receives Meditative Guidance (as has been experienced by many), then the only possibility is that the Meditative Guidance has reached the client immediately through consciousness fields.

Since the consciousness field is also an electromagnetic field arising out of the interactions of various ions in the human body, then the consciousness field can also approximate the velocity of light (in other words, electromagnetic radiation).

The neutrino was observed to pass through matter (though the exact time of travel by the neutrino was later disputed and experiments repeated, whose results are awaited at the time of writing this article in fall 2012). Whether the neutrino travelled faster than light (speed of light is a Scientific Constant [45] having a value of 186,282 miles per second [46] or 2.99 lakh kilometers per second approximately, which paved the foundations for the Einstein's theory of relativity and special relativity [47] which later was applied by Albert Einstein in 1917 to model the structure of the Universe [48]) or slower than light by a few fractions of a second, it still emphasizes that the neutrino though being a particle was able to travel at the speed of light (lesser or greater by a scientifically disputed margin), then, the other observation/inference which has not been discussed widely is that the particle neutrino when travelling at/near/lesser/greater than the speed of light, would require to imbibe the properties of light to be able to travel at that speed, else such speed would not be physically possible.

This implies that the particle neutrino, with very small mass [51] would become similar to light (which is electromagnetic radiation), when it travels at/near the speed of light and consequently would be able to exhibit other properties of light, apart from speed viz., the dual nature of light [57] as particle and wave. Stretching this property to the neutrino that has very small mass (at the time of exhibiting at/near light speed) would also behave like a wave. Consequent to this inference and understanding, then the consciousness field of the meditative guiding force which is an electromagnetic force (as it is triggered by the action of various ions in the body) should also be able to exhibit particle nature.

A human being is alive when the consciousness field is present in the body. In dead people, the consciousness field is absent. Consequently, the presence of consciousness can be taken to be as a sign of life. If that is the case, then the mysterious soul that has eluded scientific definition for so long, would actually be the Consciousness field.

When life is present in the body, the various functions in the body are performed automatically. When life has left the body, the body remains but the various functions in the body stop and the body starts decomposing or rotting with emanation of foul smell.

Therefore, the various functions in the body can be taken as the particle nature of the consciousness field, while meditation aspects can be taken as wave nature of the consciousness field.

There seems to be a convergence here between Science and Spirituality. According to basic principles of Spirituality, the human body (or human birth) is a cloak that the soul (which implies consciousness field here) takes on its journey with signature patterns of various karmas (or deeds) done by the soul in various previous births.

Translating this into scientific understanding with support from discussions in the previous paragraphs, the following inferences are evident

- The soul is the Consciousness field
- The body is the cloak that the Consciousness field dons – the body is alive when the consciousness field is there and the body dies when the consciousness field departs
- The Consciousness field is the wave nature and the body functions is the particle nature

Functional abnormality in a human body is called as disease. Scientific knowledge dictates that the various genetic susceptibilities of various diseases are related to the chromosomes.

From discussions and inferences in previous paragraphs, the Consciousness field (wave nature) and the human body functions (particle nature) are functions of the same electromagnetic force.

According to spiritual treatises, if the results of actions (good or bad) in previous lives called karma is borne by the soul (consciousness field) when it takes up a human body (otherwise called as life), then it should reflect in the abnormalities/normalities/improvements in body function, which can easily be brought about through action templates (chromosomes).

Therefore, when the electromagnetic force in wave form (as consciousness field) makes its manifestation

in particle form (with life in a body), then wave properties imbibed in it due to past actions in previous particle form manifestations (previous births), when translated into current particle form manifestation (current birth) would be reflected in body functions by imprinting them onto the chromosomes. This agrees with the scientific understanding that diseases can be caused by chromosomal abnormalities, and various methods of scientific clinical treatment can be given to treat chromosome abnormality and thereby heal diseases.

If scientific clinical treatment can be used to treat diseases through chromosomes in the particle nature (body functions), then there can also be procedures to heal diseases in the wave nature (consciousness field).

If Meditation is a procedure that is governed by consciousness field (and guided consciousness fields) that heals diseases, meditative procedure (wave nature) can also be used modify chromosomes (whose abnormality also causes diseases).

Life occurs when the particle nature (body functions) of the consciousness field enters a body and death occurs when the particle nature (body functions) leave a body. Discussions in previous paragraphs yield the insight that karma (in wave nature of consciousness field) manifests as chromosomes (in particle nature). Improvement of karma (past or present) leads to good health in particle nature and evolution of the soul (consciousness field) in wave nature.

Using Science to understand Spirituality, modification of chromosomes using Meditation towards better health or improved body functions in particle nature, would be a modification of the karma in wave nature, which agrees with the accepted concept that good Spiritual Practices help to have better karma while washing away the effects of previous bad karma.

Conventional Spiritual knowledge dictates that when the karma is made very pure over multiple births, mukthi is achieved by merging with God (the best form of karma). Translating scientifically, an improving/deteriorating form of the consciousness field in wave form merging with God with the purest karma actually implies merger with the purest form of the consciousness field. Therefore God is the purest Consciousness field.

Rephrasing in concise form, the soul is the consciousness field (as wave nature), which gives life to a body through the body functions (as particle nature). Conventional Spiritual knowledge indicates that Human life undergoes various births, purifying the soul until it merges with God, which are inferred from the previous paragraphs as the particle manifestation of

the consciousness field as human life, undergoing various cycles of life (initiation of particle nature activity of consciousness field) and death (cessation of particle nature activity of consciousness field) to merge with the purest form of consciousness field, ie., God.

However, the presence of various cycles of birth and death is still mysterious. Consider the objects in the article, titled Introduction to the fourth dimension [58]. The examples cited for each dimension (a point – 0th dimension, a line – 1st dimension, a square – 2nd dimension, a cube – 3rd dimension) is able to be comprehended until the third dimension as they are commonplace examples, while there is difficulty in understanding the fourth dimension as it is yet to be seen or understood. The objects of the 0th, 1st, 2nd and 3rd dimension are seen as a point, line, square and cube as we see it as a human body in the 3rd dimension.

Assuming that the objects are to be seen from the perspective of the other objects, the following would be the observation

0th Dimension:

A point appears as a point
 A line appears only as a cross-sectional view of a collection of points
 Further higher dimensional objects also appear as a collection of points

1st Dimension

A Point appears as a point
 A line appears as a line
 A square appears as a cross-sectional view of a collection of lines
 Further higher dimensional objects also appear as a collection of lines

2nd Dimension

A point appears as a point
 A Line appears as a line
 A square appears as a square
 A cube appears as a cross section of various squares
 Extending previous inference here, then higher dimensional objects should also appear as collection of various squares

3rd Dimension

A point appears as a point
 A line appears as a line
 A square appears as a square
 A cube appears as a cube
 Extending previous inference here, then further higher dimensional objects should also appear as collection of various cubes

Consider the following action: A higher dimension object moving towards a lower dimension object as observed by the lower dimension object

When a line moves towards a point, the point observes the line as a set of points and the movement of the line towards the point will be understood as increasing size of the set of points while the movement of the line away from the point will be understood as decreasing size of the set of points. Similar understanding can be achieved for the other objects considered as example too.

Fitting the consciousness field as an object in various dimensions, the same consciousness field from a lower dimension will see the consciousness field from a higher dimension increase or decrease in size, while the same consciousness field from a higher dimension will perceive a consciousness field from a lower dimension without change in size. The consciousness field remains the same, but the perception of it differs from the dimension from which it is perceived.

Due to the dual nature of the consciousness field in wave and particle form, the variation in size of the consciousness field in wave form will alter as variation in the body functions in the particle form. The wave form has no limits in spatial or time extensibility, but the particle form cannot undergo large changes in body functions due to limitations in particulate matter. Consequently the object (body) wherein the particle form (body functions) manifests is discarded and a new higher or lower object (body) is chosen suiting the changed (improved or deteriorated) body functions. The Scientific and Spiritual Doctrines are found to agree here in this perspective.

Rephrasing, the consciousness field (in wave form) evolves itself either improving or deteriorating, which is reflected in its karma, carried into the body functions, every time the consciousness field (in wave form) translates into particle form (body functions). Whenever limitations arise due to change (for better or worse), the object (body) used for the body functions is discarded and a new one is chosen, which explains the concept of birth, death, rebirth and karma.

The offshoots of this understanding can be summarized in the following manner. The purest form of the Consciousness field (wherein individual consciousness fields later merge upon improvement) is understood to be God.

As particulate form, God should be an enormous function unable to be comprehended from the third dimension (as human understanding observes from the third dimension only).

In the wave form, if the consciousness field (soul) upon achieving total purity merges with the universal consciousness field (God), then the converse should also be valid; implying that that all consciousness fields (souls) emanated from the universal pure consciousness field (God) and return back to the universal pure consciousness field. In particle form, this indicates that all body functions (particle form) came from the Universal particle form of God (not able to be defined so far, due to limitations from observing higher dimensional God from the 3rd dimension, similar to limitations discussed in previous paragraphs) and returns to the Universal particle form of God.

This agrees with the conventional spiritual knowledge that the being (human) came from God and goes back to God over multiple rebirths. The only limitation with spiritual knowledge is that, the object (body) is defined as a cloak donned by the soul (consciousness field), while the body function is not related characteristically, but ambiguously related as a person or being which if carefully analyzed indicates that a person or being is what he/she thinks and acts (in other words body function). With these inferences, it is observed that Science and Spirituality agree. Science would be the particle form while Spirituality would be the wave form.

Consequent corroborations would include meditative guidance in spirituality (wave form) to clinical treatment in Science (particle form). That means, clinical treatment can be used to improve body functions in particle form, while meditative guidance can be used to improve the consciousness field in wave form, which indicates that processes in one form can also influence processes in the dual form. The only inference is that, meditative guidance in wave form can improve body functions in particle form and vice versa, which has been conventionally witnessed as health/body function improvement via meditation (treatment from wave form to particle form) and ability to achieve meditative states/altered consciousness states/hallucinations using clinical drugs (treatment from particle form to wave form).

Further understanding can be derived by considering the fact that good clinical drugs can improve the health while bad clinical drugs can deteriorate the health. Extending this into the wave form, good meditative practices can improve the purity of the consciousness field while bad meditative practices can decrease the purity of the consciousness field. If this is so, then it implies that as much as health can be made to deteriorate by administering bad clinical drugs, the purity of the consciousness field can also be made to become impure by administering impure consciousness fields. On a relative scale, as much as there is a cost involved to procure and administer a bad clinical drug,

so much would there be a cost involved to obtain and administer an impure consciousness field, which has to be borne by the administrator.

In summary, as much as the human body function (in particle form inside the object of the human body) is taken care with the goodness that is present in the Universe, the consciousness field (in wave form) also needs to be take care with the goodness that is present in the Universal Consciousness.

Scientific arguments to this and other analyses, discussions and inferences presented in this manuscript could possibly be there, yet it can be understood that there would be limitations in the particle form (Science) which make the particle form to keep on changing objects (body and rebirth), while the wave form (Spirituality) does not have limitations. Therefore Science is always characterized by arguments while Spirituality is always characterized by understanding.

EXTENSION OF CONSCIOUSNESS FIELD MODEL TO FUNCTIONAL ENTITIES AND MACHINES

Conventional scientific knowledge indicates that all human physiological processes are a property of the ions and their interaction processes resulting in good health to the human being. Abnormalities, sickness and diseases occur due to various reasons, yet good health is obtained by restoring ions and their interaction processes via spiritual processes as in meditation or scientific processes as in medicine, which exhibit duality. Rephrased, this implies that the consciousness field interacts with the human body through the ions and their interaction process.

It has also been evidenced that the consciousness field is able to interact with an automobile (Human-Machine interactions) and is able to provide very good performance under varying conditions [59]. The automobile can also be expressed as a machine which has multiple functional processes in it, the consolidated output of which enables movement on surfaces.

The human being acquires equilibrium conditions of ions and their interactions (giving good health) due to consciousness and the automobile acquires equilibrium conditions of ions and their interactions (giving efficient output). When the ions and their interaction processes of the human being do NOT directly interact with the ions and their interaction processes of the automobile but yet influence the ions and their interaction processes of the automobile achieving greater efficiency, then the link between the ions and their interaction processes of human beings and those of the automobile can only be the consciousness field.

It is evidenced that human beings have consciousness field. If the human machine interactions are achieved via consciousness fields, then it implies that the machine should also have a consciousness field, the only difference being that the human consciousness field has got awareness, while the machine (being built by human beings) has got only consciousness without awareness, both being a property of the ions and their interaction processes.

Rephrased, it implies that all machines have got consciousness but do NOT have awareness and this awareness is provided to the machine by human beings or any other natural or artificial process, including but not restricted to artificial intelligence.

A collateral benefit achieved here is an additional understanding of the link between birth and re-birth whose consciousness model has been proposed in the previous paragraphs. If consciousness field can exist in a machine and if it can interact with the consciousness field in a human being, then these consciousness fields should have properties similar to each other, else they will not be able to interact. Consequently, if the consciousness field in a machine can exist without awareness, then the consciousness field in human being also can exist without awareness. However, the consciousness field in human beings is found to exist with awareness.

Then there should be some part of human life where the consciousness field exists without awareness. Referring to the consciousness model proposed in the previous paragraphs for the soul, birth and re-birth, consciousness and awareness exist together, except that in birth and re-birth current awareness alone is accessible for the consciousness while the past awareness or future awareness is not accessible.

As the automobile/machine works with its consciousness field with external awareness provided by the human being, then it is also possible for the consciousness field of the human being to obtain awareness of the past or future in birth and re-birth from another consciousness, perhaps from the consciousness and awareness of God which is universal. Again we find a convergence with spirituality where possibility of awareness across birth and re-birth is accepted and exhibited, though in ways that was not able to be understood prior to this research work. Hence, a better understanding of Human-Machine Interactions, consciousness field and awareness of machines or any other functional process (based on ions and their interactions), awareness in the consciousness field of the human being across birth and re-birth of the soul with awareness input from the consciousness field of God is modeled and defended.

EXTENSION OF CONSCIOUSNESS FIELD MODEL TO PLANTS, ANIMALS, ALL LIFE, NATURAL AND NON-NATURAL FORMS

Plants are found to exhibit the following characteristics

- Sensory Network, Unique Response to Different Stimuli, Perception of Mechanical Signals regardless of their taxonomic classification or life habit [60, 61, 62]
- Gene response to music [61]
- Increase in growth, yield and nutritive value [63]

Further similarities between plants and animals are demonstrated by enhancing the milk yield of cows and increased fermentation rate in probiotic yoghurt using music with ambient natural sounds that previously demonstrated enhanced metabolism, growth and yield in plants [63]

Also, music is found to be stressful to insects, decreasing the lifespan of male *Drosophila* [63]

Considering that

- plants and animals exhibit characteristics of responding to stimuli, especially music;
- human being is classified as an animal
- ions and their interaction processes are also fundamental in plants

then, the only possibility is that plants also have consciousness fields, because all other constraints remain the same in human beings and plants.

Further, since human being is classified as an animal, consciousness fields should be present in all animals also. Consequently, consciousness fields should be there in all Life forms based on ions and their interaction processes, as they are found in human beings, plants and animals.

However, differences between plants and animals are found in the structure of the internal sensing network and in the response of the organism to stimulus [60], which is not significant from the perspective of the consciousness field model.

In summary, natural forms based on ions and their interaction processes have consciousness fields with awareness, while non-natural forms based on ions and their interaction processes have consciousness fields but require external awareness inputs. Therefore, the proposed, defended and extended Consciousness Field model which scientifically converges Science and Spirituality provides a converged scientific and spiritual insight into the aspects of God, Soul, Karma, Birth, Re-birth, Machine Consciousness and Awareness, Plants, Animals, All Life and Natural Forms; some of which have consciousness fields with awareness while the rest have consciousness fields with awareness provided externally.

ANALYSIS OF THE NEW CONSCIOUSNESS MODEL

An analysis of the new consciousness model, proposed, explained and defended here indicates a convergence in

- Science and Spirituality
- Human, Plant, Animal and all Life
- Machines
- Natural and non-Natural forms

with the consciousness field playing a pivotal role in the convergence, with natural or inherited awareness extending up to external awareness input.

Since a convergence has been achieved on multiple hitherto unrelated areas based on the new consciousness field model, an analysis is done whether the same consciousness field model is able to converge religious teachings through the consciousness field model.

The scope of this research work does not venture into intricate analysis of religious teachings but analyses at acceptable levels.

Christianity indicates a cycle of creation starting from light and matter and fulfilling in human beings through plant and animal life forms.

Creation is a process and if such a wide variety of light, matter, plant, animal and human forms are created in a cycle, then there needs to be a link between all of these.

Further Christian understanding indicates that man came from dust and returns to dust. Again, if man came from dust and returns to dust, there needs to be a link between man and dust.

The consciousness field model has been found to fit all of nature, life, machines including non-natural forms, as proposed, discussed and defended in the previous paragraphs.

Considering the consciousness field model as the link in creation, then all creations are similar with reference to the consciousness field model. When man and dust is examined for a link, the consciousness field model fits both. The only difference is the presence of awareness as natural, inherited or as external input. If such is the case, then the entire process of creation as taught by Christianity is scientifically valid when the Consciousness field model is applied.

In the teachings of Hinduism, a remarkable teaching is regarding the part played by karma, leading the soul through refinement via multiple lakhs of births from lower order creations to cyclic births as human beings to achieve God, ascending or descending the evolution

cycle based on karma. The previous paragraphs have indicated that when the consciousness model is used as a link, then the whole of creation is similar to each other. When there is a similarity, the ascent or descent in the evolution process is quite possible scientifically as all creation is similar when the consciousness model is used to fit creation, the difference being only in the function of the created being and awareness of the being.

To rephrase, the above analysis indicates that religious teachings converge when the consciousness field model is applied.

Therefore, the Consciousness field model is able to converge Science and Spirituality, and offers converged scientific and spiritual insights into the aspects of God, Soul, Karma, Birth and Re-birth, Machine Consciousness and Awareness including Plants, Animals, All Life, Natural and non-Natural forms further resulting in a convergence of Religious Teachings.

THE HUMAN PERSPECTIVE RESULTING FROM ANALYSIS OF THE NEW CONSCIOUSNESS MODEL

The analysis of the New Consciousness model, when summarized from the Human Perspective yields the following major understandings

- Consciousness fields are present in all entities, from dust and nature including all the components of the evolution hierarchy
- As the Universal Consciousness, also called as “God” interacts with that of the Human Consciousness, the Human Consciousness can also interact with all other types of Consciousness
- All entities in Nature have awareness, though the linking awareness across births/cycles is not able to be achieved by all
- Improvement or Refinement in the Consciousness fields results in better efficiency of the entities, for instance, good health in the case of human beings
 - Consequently a deterioration in the quality of the Consciousness field would result in decreased efficiency of the entities, implying reduction in good health (otherwise called as abnormality or sickness or disease)
- It needs to be noted that this research work actually started to investigate the Divine Omdasji Sound Meditation and explain its characteristics and other hitherto unexplained phenomena arising out of experience with the Divine Omdasji Sound Meditation.
 - However, this research has progressed, from understanding the various characteristics of the Divine Omdasji

Sound Meditation charting its own paths through multiple interdisciplinary & multidisciplinary areas giving scientific explanations to a whole lot of hitherto scientifically unexplained phenomena. If this needs to be explained using the concept of Consciousness fields, then the Consciousness fields involved in this research have been putting up their own self-organizing Networks, interacting with other Consciousness fields, reinforcing themselves and the others, to reach this stage. In short, the Consciousness fields have explained themselves using various scientific concepts and networking wherever necessary. An offshoot of this understanding is that when reinforcement of the Consciousness field is possible, then degradation of the Consciousness field is also possible.

Consequently, further understanding can be derived regarding the Consciousness fields, their evolution and their interactions.

It does take a definite time since birth for every human to even faintly realize the Consciousness field. In the duration between birth and a faint realization of the Consciousness field the progress of which may even be accompanied without a realization of the Consciousness field. A direct result of this process could possibly result in degradation of the Consciousness field due to inherent practices of the human being and external reactions. This can be explained as follows.

It has been understood that all entities have consciousness fields. Considering food as a basic example, human being eat a variety of food substances, raw, cooked or prepared in various ways. Every component of the food is take from an entity in Nature. As an example, consider the growth of a fruit tree. The tree grows from a seed and starts bearing fruit. Once the fruit is ripe, the tree does not hold on to the fruit but casts off the ripened fruit, and starts making more fruits. A simple understanding derived is that, a plant basically grows to provide food and it doesn't matter at which stage of the growth of the plant, it is used as food. This implies that the consciousness field of the plant is not disturbed when a part or whole of it is taken as food. The plant gives itself to become food and the goodness of the consciousness field of the plant will be conveyed to the human being who eats it, as the remnants of ions and their interactions of the plant will still be there in parts of the plant taken as food. This will reinforce the Consciousness field of the human being.

On the other hand, consider an animal. An animal is not created as food. Human beings eat animal as cooked food for various reasons, the scope of which is beyond this research work. Human beings have reasoning capacity and consequently, there would be a lot of reasons given to justify eating animals as food. Consider animals eating other animals. Animals are known to eat other animals as food, yet animals are also found to co-exist peacefully with each other [64-67], sometimes the prey and the predator living happily together. This fizzles out the argument that animals eat other animals characteristically. The only possible argument is that animals learn to eat other animals by observing other animals eating animals. If animals are reared in a non-animal eating environment, then it is also possible that animals can peacefully co-exist without eating other animals [64-67]. Hence, it can be understood that there is no compulsion to eat animals, whether it be an animal or a human being.

Consider the situation when the animal prey is about to be killed or eaten by the predator animal. The consciousness field of the preyed animal gets disturbed, as it is forced to perceive the pain of the preyed animal until it is dead/killed and the consciousness field leaves the dead prey. Since the consciousness field manifests through the ions and their interactions, the perception of pain by the consciousness field of the preyed animal would be present in the flesh of the preyed animal, and will degrade the consciousness field of the predator animal, as ions and their interaction properties of the predator animal and that of the preyed animal would interact, consequently degrading the consciousness field of the predator animal. Extending this understanding to human beings, the consciousness field of human beings do get degraded whenever any animal is consumed as food.

Similarly, due to various other activities done without realization, the consciousness field of the human being gets degraded. Whenever the consciousness field of the human being gets degraded, it reduces the efficiency of the human systems, resulting in chronic or sudden illness.

Further, the Divine Omdasji Sound Meditation is already evidenced to provide good health, then by the converse of previous understanding, an improvement in the Consciousness field can be obtained using the Divine Omdasji Sound Meditation.

It can be understood from the previous paragraphs that improvement in the Consciousness fields results in improvement in

- health of the human being.

- Consciousness field of the human being, due to positive reinforcements and self-organizing evolving nature of the consciousness field

In summary, due to improvement in Consciousness fields, human beings can have

- Good health
- Peaceful co-existence in all aspects of life
- Enlightenment in Scientific pursuits and other personal or official pursuits
- And all other benefits arising out of improvements in Consciousness fields, not necessarily limited to the awareness of this birth alone

resulting in a contented and happy life with good health for the self and others by virtue of positive self-organization, networking and evolution among consciousness fields.

EXTENSION OF THE HUMAN PERSPECTIVE TO ANIMALS AS THE ANIMAL PERSPECTIVE

Any new Scientific concept, however true will always require considerable time for acceptance even by contemporary Scientists and a still longer time for acceptance by Society [68]. It would be an enormous waste of energy, time and resources to wait for acceptance and then pursue further analysis/extensions of the new Scientific concept.

Consequently, the Human Perspective resulting from Analysis of the New Consciousness model is examined for extension. The immediate fallout of the Human Perspective resulting from Analysis of the New Consciousness model is that it can be directly extended to Animals, for the simple reason that Human Beings are at a higher level of evolution compared to the Animals. Therefore, the only difficulty that would be experienced is the difference in the learning curve of human beings and animals, with the animal learning curve requiring assistance from human beings, as animals have inherent difficulties in thinking, analyzing and learning processes and need to be trained. Once the animals are trained by human beings so that they are able to fit into the confines of the Human Perspective resulting from Analysis of the New Consciousness model, then the same benefits that human beings derive from the New Consciousness model can also be derived by the animals. This would have far reaching effects on the good health of the animals which will only serve to further the good interests of human beings, as animals are a part of human life, participating from levels of pets at home, to trained animals in defence services upto trained animals in rescue and emergency services. When the consciousness field of the animals is improved resulting in good health of the animals, it only serves mankind, and hence, in the best interests of mankind,

animals can be trained so that they can also have the benefits arising out of the new consciousness model.

EXTENSION OF THE HUMAN AND ANIMAL PERSPECTIVE OF THE NEW CONSCIOUSNESS MODEL TO PLANTS

Similar to the Extension of the Human Perspective of the New Consciousness Model to a lower level in the Evolution Hierarchy which yielded the Animal Perspective of the New Consciousness Model; the Animal Perspective of the New Consciousness Model is further extended to a lower level in the Evolution Hierarchy, namely, the Plants. An Animal can be trained to improve its Consciousness field, resulting in Good Health and Performance for the Animal giving the end result as benefits to Mankind. This training can be made adaptive depending on the animal responses to training. However, in Plants, training response is more subtle than obtained in Animals. Consequently, adaptive changes in attempts to improve the Consciousness Field of Plants may not be able to have a sharp exponential curve, but instead will be a slowly growing curve.

It has always been noticed in nature, whenever there is a handicap in any natural capability, there is always an additional development or improvement or enhancement of another natural capability that can partially or fully or even better augment the handicap in the other capability.

Consequent examination of the other capabilities of the New Consciousness field model, includes the capability of development of own self-organizing Networks, interacting with other Consciousness fields, reinforcing themselves and the others. Therefore, when there is an insufficiency in the ability to be trained, the abilities in development of own self-organizing Consciousness Field Networks, interacting with other Consciousness Fields resulting in reinforcing themselves and the others should be more enhanced. This would result in an avalanche effect spreading out to every neighboring plant. The Net Result obtained would be an improved Consciousness Field in the Neighboring or Global or Universal Environment comprising of Plants based on the extensive self-organizing network developed by the Plant Consciousness Fields. In line with the previous understandings, the resulting efficient working of the plant systems would bring about

- a good yield or produce
- increase in plant cover resulting from the good yield or produce
- a good quality plant growth in the neighboring or global or universal environment

The Net result would be a Neighboring or Global or Universal efficiently working Plant cover, which will

consequently provide a better Natural Green Solution to All Environmental Problems plaguing the World today.

THE PLANT PERSPECTIVE BASED FOOD ASSURANCE FOR ALL ECOSYSTEMS

Apart from the Natural Green Solution to All Environmental Problems plaguing the World today by virtue of a Neighboring or Global or Universal Plant Cover, the efficient plant systems consequently arising out of improved Consciousness Fields in Plants would also result in highly efficient productivity from the same plants. Consequently, the Ecological Food Chain gets better food input from these Plants with improved Consciousness Fields. This implies that All Species will certainly get food, indicating a Food Assurance for all Ecosystems arising out of the Plant Perspective of the New Consciousness Model. Further benefits would also include growth and proliferation of Species in their Natural Habitats and also reduce the Man-Animal Conflict.

THE PLANT PERSPECTIVE BASED GLOBAL FOOD SECURITY FOR MANKIND

With the Advent of Industrialization a few Centuries ago, there has been a marked change in demographic patterns and population dynamics. Accompanied with population explosion, the demand for food has increased rapidly. Various Scientific Studies undertaken in these areas are striving hard to find a suitable solution to meet the food demands of all people in current global scenario. The demand for food also alters the political landscape across the world, nurturing or spoiling International Relationships.

Though the plant consciousness fields present a challenge in the form of studying the training responses, yet the capability of the Consciousness field in self-organizing Networks, interacting with other Consciousness fields, reinforcing themselves and the others can be utilized through methods of Organized Farming or Agriculture, to improve Consciousness Fields of the plants cultivated, thereby resulting in obtaining efficient plant systems that consequently produce maximum yield. When this is done on a massive scale, global food security for all mankind can be achieved.

THE NATURE PERSPECTIVE

Human Beings, Animals and Plants interact with Nature at multiple levels. When the consciousness fields of Human Beings, Animals and Plants are improved, then due to the interactions with Nature and its components, the Consciousness fields of Nature and its components also get refined and improved. Consequently, the Systems of Nature and its Components would be working at improved efficiency

levels providing a better environment for all species to co-exist.

The various systems and interactions between Nature and its Components would be working at increased efficiency levels. A collateral benefit out of the improvement or refinement in the Consciousness Fields of Nature and its Components would result in decreased number and strength of Natural Disasters or Calamities. Consequently, improvement or refinement of the systems of Nature and its Components can also be attempted directly as a long term goal in Disaster Management, considering the enormous benefit to mankind and other species instead of indirect improvement or refinement of the Consciousness fields of Nature and its components through interactions with the Consciousness fields of Human Beings, Animals and Plants.

THE MACHINE PERSPECTIVE

Discussions in previous paragraphs would have helped to understand the improved efficiency of Machine Systems as a result of improvement in the Consciousness Fields of Machines. Examining together, the Machine Perspective and the Nature Perspective of the New Consciousness Model, it indicates that the basic components of any Machine would also have a consciousness field as all basic components of any Machine are directly or indirectly obtained only from Nature and its components. Though improvement of the Machine Consciousness Fields would provide Machine Systems that operate at very good efficiency, a better result can be obtained if the improvement of the Consciousness field is attempted at the basic component level of the systems of the Machine. This implies that improvement of Consciousness Fields needs to be done right from the stage of obtaining raw material from Nature and its components to the complete manufacture of the systems of the Machine and their assembly, further extending to user operation of the Machine for best efficiency of Machine Systems. This would also result in a reduction in the demand for more fuel or energy brought about by less efficient working of Machines. Consequently, the stress for identifying and exploit of more and more natural or artificial sources of energy and fuel would also be reduced.

THE PEACEFUL HARMONIOUS COEXISTENCE OF MANKIND WITH ITSELF, NATURE AND OTHER SPECIES

When All of Nature, the various Species and Human Beings, including Machines exhibit efficient performance due to improvement in their Consciousness fields with reduced difficulties in their systems, the output of each entity will be better than that obtained now. Due to various changes in interdependence of Mankind, the various Species,

Machines and Nature that will occur due to efficient performance brought about by improvement in Consciousness fields, the quantum of resource will grow greater than demand. Whenever resource grows greater than demand, the competition for resource among Human Beings themselves and with other Species and Nature will consequently reduce. Lesser competition for resource accompanied by surplus resource will pave way for more peaceful and healthy relationships among Human Beings themselves and with other Species and Nature. Consequently, there will arise a Peaceful Harmonious Coexistence of Mankind with itself, Nature and other Species due to improvement in Consciousness fields in accordance with the New Consciousness Model.

INTERACTION OF HUMAN CONSCIOUSNESS FIELDS

The consciousness fields have been found to have the capability of interaction and the ability to produce good results due to their characteristic feature of efficient processing of the task.

Consciousness field interactions in human beings is evidenced to be accomplished by

- direct interactions of human consciousness fields through self-organizing networks of consciousness fields, as in improvement of knowledge base or in meditative guidance or in improvement of health via improvement of consciousness fields (as outlined in previous paragraphs)
- indirect interactions of human consciousness fields through another consciousness field such as plant consciousness fields, as in resultant improvement of human consciousness fields through improvement of health brought about by intake of medicinal plants whose good effects are caused by the preserved state of the plants irrespective of change in form of the plants implanted by the plant consciousness fields into the plant

The benefits of such interactions among human consciousness fields range from improvement in health, education, knowledge, societal life and planetary or universal inhabitation, and all aspects of human life with further improvement of the consciousness field.

Extreme cases of direct human consciousness field interaction are linking of human consciousness fields and the merger of one consciousness field into another. However, linking of human consciousness fields and merger of one consciousness field into another can be established only when one or both of the consciousness fields is sufficiently refined and strengthened to be capable of establishing the link, while merger of one

consciousness field into another can be established even when one of the consciousness field is not sufficiently refined or strengthened and the other consciousness field is the Universal Consciousness field (God) or a highly refined and strengthened human consciousness field. In such cases, the benefits arising out of human consciousness field interactions are maximum.

EVOLUTION OF THE MIND AND THE HEART INSPIRED BY CONSCIOUSNESS FIELDS

A direct consequence of enhanced consciousness field is the lowering of activity states of the brain to lower frequency rhythms. At this stage, the cognitive thought processes are streamlined and do not run haywire, helping the human being to think, plan and act in an organized manner reflecting as an evolution of the mind. An extreme case of such streamlining of cognitive thought processes is the high throughput achieved effortlessly in human activity.

When cognitive processes are streamlined and organized accompanied by lower brain rhythms, the mind is at peace. Consequently, the heart rate stabilizes at normal pace and the subject does not feel excited or agitated. These effects when present simultaneously pave way for presence of these effects for a longer duration. The net effect is that the subject is peaceful without agitation/excitement with streamlined organized thought processes leading to good health and happy states of mind, which will further radiate to all who interact with the subject, causing good effects to them also. Such processes are automatic without any need for training and are an inherent property and the evolution of the mind and the heart to such states is inspired by the consciousness fields. Since the consciousness field is present in all entities, such effects can be witnessed in all entities.

A case of a few dolphins trying to form a raft to save another dolphin from sinking to death [69] can be cited as an example. To the common thought process, it may appear as a strange behavior by dolphins, but the same behavior of the dolphins when examined as a case of inspiration by consciousness fields does not appear as a strange behavior but appears as expected behavior that can result from evolution of the mind and the heart inspired by consciousness fields.

The act of the dolphins in attempting to form a “life raft” for the dying dolphin may not have succeeded, but would have helped the dying dolphin to die peacefully realizing that it is in the company and safety of other dolphins while the other dolphins may or may not have realized the actual significance of their act of forming a “life raft” for the dying dolphin. Similarly, when the mind and the heart are evolved inspired by the consciousness field, a lot of good

happens to the subject and to others who are in the vicinity of activity of the subject. Since the consciousness field is present in all entities, such effects manifest in similar ways in all entities and in the vicinity of their activities.

DIVINE MANIFESTATIONS AND THEIR INSPIRATION AS HOLY BOOKS OR HOLY SITES OR EVOLVED/SYSTEMATIC HOLY WAYS OF LIFE

When the mind and the heart are evolved, inspired by consciousness fields, the quality of the consciousness field of the human being is enhanced. At such conditions of enhanced quality of the consciousness field of the human being, the interaction between the consciousness field of the human being and the universal consciousness field of God improves.

In any communication, a part of the self is transmitted and a part of the other is received, for instance, audio/video in conversations aided by devices and the self itself as in a personal visit. Similarly, at the level of consciousness field interactions, a part of the consciousness field of the self is transmitted and a part of the other is received.

Since the relative quality of the universal consciousness field of God is always better than that of the universal consciousness field of the human being, it is relatively easy for the universal consciousness field of God to transmit to the seeking human being than that of the consciousness field of the seeking human being to attempt to transmit to the universal consciousness field of God; due to various factors that might introduce attenuation/difficulty in human consciousness communication, ranging from bad karma to unrightfully committed deeds, knowingly or unknowingly.

Consequently, for effective communication under such limitations of the human consciousness field, the universal consciousness field transmits to the human being. The basic factor of quality in any communication process is not the efficiency of Transmission but the efficiency of Reception. Since the human consciousness field might have limitations caused due to factors discussed above or other factors; to achieve effective communication, the universal consciousness field of God transmits in ways that can be received by the consciousness field of the human being as a Divine Manifestation.

If the quality of the consciousness field of the human being is good, the consciousness field communications from the universal consciousness field of God directly interacts with the consciousness field of the human being, which happens in realized human beings

resulting in inspirations that get scripted by the realized human beings as Holy Books.

If the quality of the consciousness field of the human being is weak, the consciousness field communications from the universal consciousness field of God interacts with the consciousness field of the human being through the five senses/sense organs of the human being, resulting in inspiration that spreads out by word-of-mouth initially, evolving later as information which recognizes the physical site of presence of the human being at the time of consciousness communication from the universal consciousness field of God as a Holy Site which later evolves into a Pilgrimage Center.

If the quality of the consciousness field of the human being is so weak that it is unable to recognize the consciousness communication from the universal consciousness of God neither through the human consciousness field nor through the human senses/sense organs, then the universal consciousness field of God transmits in the form of multiple fields (otherwise called as Divinity) to interact with human consciousness fields over an extended period of time, attempting to make understood that the multiple fields are also human beings. Prolonged interaction of the consciousness field of the human being with the multiple consciousness fields of Divinity with the understanding that they are also human beings, results in consciousness communication to be established over a period of time. Consequently, the human being/human beings who received the consciousness communication either live or inspire others to live in ways as understood by their consciousness fields, which later transforms into a Holy Way of Life. When the human beings can govern themselves in these Holy ways of Life, it becomes an Evolved Holy Way of Life. When the human beings require governance in these Holy Ways of Life, it becomes a Systematic Holy Way of Life, also accompanied with voluntary contribution from other human beings to form the systematic structures in various physical and practical aspects that oversee such Systematic Holy Ways of Life.

PERSISTENCE OF DIVINE MANIFESTATIONS AS HOLY BOOKS OR HOLY SITES OR HOLY WAYS OF LIFE

Referring to previous paragraphs, it can be understood that time is a variable while space is a constant in the third dimension wherein human beings live. Lower dimensions exist and possibility of higher dimensions also exist. Translating this into concepts of consciousness communications would indicate that the particle nature of the human consciousness field exists in the third dimension while the particle nature of the universal consciousness field would exist in the highest dimension. As time is a constant in the first and

second dimensions and is variable in the third dimension, the same variations can also apply for space too, which is a constant in the third dimension but could be a variable in a higher dimension. Whenever any parameter is a variable, the possibility of freezing/fixing its parametric value exists; indicating that time and space can be freed/fixed.

Extending understanding of freezing/fixing of time and space to consciousness communications from the universal consciousness field of God to the human beings for all cases discussed above, indicates that time and space gets freed/fixed to the time and space when the consciousness communications from the universal consciousness of God is perceived by the consciousness of the human being(s). This is illustrated by repetitions of the consciousness communication in all cases discussed above on further/late interaction with the outcome/inspirations of the universal consciousness communication, for eg., inspiration when a Holy Book is read or inspiration when a visit is performed to a Holy Site or inspiration when a Practice is repeated in a Holy Way of Life (both evolved and systematic), the inspirations being any or both of consciousness/physical levels.

ACKNOWLEDGEMENT

The first author thanks her parents and Shri.V.S.Mani for orienting her towards the path of education and spirituality. The second author acknowledges his parents G.B. Albert & Annie Nazareth dedicates this research work unto his mother Annie Nazareth who is his guide (though not physically alive) and all other good souls. The last author acknowledges his Guru, Dhyanyogi Madhusudandasji Maharaj.

The authors thank the Chancellor of Vinayaka Missions University Dr.A.Shanmugasundaram, Dr.S.Sharavanan and Dr.A.S.Ganesan, Mr.J.S.Satish Kumar and Mr.N.V.Chandrasekhar, the Vice Chancellor, the Registrar and University/College Authorities/Officials and Colleagues for their patronage.

REFERENCES

[1] Takahashi T., Murata T., Hamada T., Omori M., Kosaka H., Kikuchi M., Yoshida H., Wada Y. (2005) Changes in EEG and autonomic nervous activity during meditation and their association with personality traits, *Int J Psychophysiol.* 55(2):199-207.

[2] Mason L.I., Alexander C.N., Travis F.T., et al. (1997) Electrophysiological correlates of higher states of consciousness during sleep in long-term practitioners of the Transcendental Meditation Program. *Sleep* 20, 102-110.

[3] Wallace R.K., H. Benson, A.F. Wilson (1971) A wakeful hypometabolic physiologic state, *Am. J. Physiol.* 221:795-799.

[4] Monk-Turner E. (2003) The benefits of meditation: experimental findings. *The Social Science Journal* 40:465-470

[5] Benson H., J.F. Beary, M.P. Carol (1974) The relaxation response, *Psychiatry* 37: 37- 46.

[6] Domar A.D., M.M. Seibel, H. Benson (1990) The Mind/Body Program for Infertility: a new behavioral therapy approach for women with infertility, *Fertil. Steril.* 53: 246- 249.

[7] Goodale I.L., A.D. Domar, H. Benson (1990) Alleviation of premenstrual syndrome symptoms with the relaxation response, *Obstet. Gynecol.* 75: 649-655.

[8] Jacobs G.D., H. Benson, R. Friedman (1996) Topographic EEG mapping of the relaxation response, *Biofeedback Self-Regul.* 21: 121- 129.

[9] Lazar S.W. , G. Bush, R.L. Gollub, G.L. Fricchione, G. Khalsa, H. Benson (2000) Functional brain mapping of the relaxation response and meditation, *NeuroReport* 11: 1581- 1585.

[10] Cardoso R, Eduardo de Souzaa, Camanoa L., Leite J.R. (2004) Meditation in health: an operational definition, *Brain Research Protocols* 14: 58- 60

[11] Hebert R., Lehmann D. (1977) Theta bursts: an EEG pattern in normal subjects practising the transcendental meditation technique, *Electroencephalogr Clin Neurophysiol.* 42(3):397-405.

[12] Taylor, J.G. (1999) *The Race for Consciousness*, MIT Press

[13] Markowitsch H.J. (1995) Cerebral basis of consciousness: a historical view. *Neuropsychol.* 33(9):1181-92

[14] Travis F.T., Orme-Johnson D.W. (1989) Field model of consciousness: EEG coherence changes as indicators of field effects, *Int J Neurosci.* 49(3-4):203-11.

[15] Austin, J. H. (1998) *Zen and the Brain*. MIT

[16] Asbbrook J.B. (1996) *Interfacing Religion and the Neurosciences: A Review of Twenty-Five years of Exploration and Reflection.* *Zygon*, vol. 31, no. 4.

[17] Hopfinger J.B. et al. (2000) The neural mechanisms of top-down attentional control. *Nat. Neurosci.* 3: 284-291

[18] Kastner S., Ungerleider L. G. (2000) Mechanisms of visual attention in the human cortex. *Annu. Rev. Neurosci.* 23:315-341

[19] Taylor J.G. (2002) Paying attention to consciousness. *Trends in Cognitive Sciences* 6(5):206-210

[20] Cotterill R. M. J. (2001) Cooperation of basal ganglia, cerebellum, sensory cerebrum and hippocampus: possible implications for cognition, consciousness, intelligence and creativity. *Prog. Neurobiol.* 64: 1-33

[21] Gallagher S. (2000) Philosophical conceptions of the self: implications for cognitive science. *Trends Cogn. Sci.* 4: 14-21

- [22] Frith C. (1992) The Cognitive Neuropsychology of Schizophrenia, Erlbaum
- [23] Tassi P, Muzet A. (2001) Defining the states of consciousness. *Neuroscience and Biobehavioural Reviews* 25:175-191
- [24] West M. (1979) Meditation, *Br. J. Psychiatry* 135: 457–467.
- [25] Braud W. G. (1975) Psi- Conducive States. *Journal of Communication* 25 (1): 142-152
- [26] Khalsa D.S. (2000) Medical Meditations. *Total Health* Vol. 22 No. 4 pp. 59 – 61
- [27] Kaplan S. (1978) An Appraisal of a Psychological Approach to Meditation. *Zygon* Vol. 13 No. 1 pp. 83-101
- [28] Plourde G. (2006) Auditory evoked potentials. *Best Practice & Research Clinical Anaesthesiology* Vol. 20, No. 1, pp. 129-139
- [29] Krishnan A. (2002) Human frequency-following responses: representation of steady-state synthetic vowels. *Hearing Research*. 166:192-201
- [30] VanWijk R. (2001), Bio-photons and Bio-communication, *Journal of Scientific Exploration*, Vol. 15, No. 2, pp. 183-197
- [31] Infrasound. Brief Review of Toxicological Literature (2001). 51 pages. ntp.niehs.nih.gov/ntp/htdocs/Chem_Background/ExSumPdf/Infrasound.pdf (last accessed March 6, 2007)
- [32] ACGIH (2001). Infrasound and Low-Frequency Sound. In: *Documentation of the Threshold Limit Values for Physical Agents*. ACGIH Worldwide. Cincinnati, OH. pp 1-15.
- [33] Johnson D.L. (1982). Hearing hazards associated with infrasound. In: *New Perspectives on Noise-induced Hearing Loss*, Hamernik, R.P., D. Henderson, and R. Salvi (eds). New York: Raven Press. pp. 407-421.
- [34] Fritz-Albert Popp (1999) About the Coherence of Biophotons. Published in: "Macroscopic Quantum Coherence", *Proceedings of an International Conference on the Boston University*, edited by Boston University and MIT, World Scientific
- [35] www.cardinalxtal.com/docs/notes/cardinal_phase_lock_loop_basics.pdf (as on Feb 28, 2007)
- [36] Neela Iyer, A.Prabhu Britto, Vladimir Petrov Velikov, Justin Chernow, Elizabeth Maier, Dr. A. Nagappan, Dr.M.Rangasamy, Dr. N. Malmurugan and Dhyanyogi Omdasji Maharaj (2008) Multiple Phase Locked Loop Guidance in Meditation: A New Scientific Explanation. *The Journal of Yoga*, Vol. 7, Number 2, Spring/Summer 2008 <http://www.journalofyoga.org/>.
- [37] Neela Iyer, A.Prabhu Britto, K. Sridhar, Justin Chernow, Elizabeth Maier, Sant Maa Vaishnavi Devi, Sant Maa Ananta Devi, Sant Maa Aparna Devi, Dhyanyogi Omdasji Maharaj (2009) Multiple Phase Locked Loop Meditative Guidance using BioPhotonic Communication and BioAcoustic Fields -- An Analysis. *International Journal of Life Sciences and Technology IJLST* (2009), 2(1):1-24.
- [38] <http://www.shareguide.com/Hagelin.html> as on March 17, 2009
- [39] Grin-Yatsenko, Vera A.; Baas, Ineke; Ponomarev, Valery A.; Kropotov, Yuri D. (2009) EEG Power Spectra at Early Stages of Depressive Disorders. *Journal of Clinical Neurophysiology*: (December 2009). Volume 26. Issue 6. pp 401-406.
- [40] Martica Hall, Daniel J. Buysse, Peter D. Nowell, Eric A. Nofzinger, Patricia Houck, Charles F. Reynolds III, and David J. Kupfer (2000) Symptoms of Stress and Depression as Correlates of Sleep in Primary Insomnia. *Psychosomatic Medicine* 62:227-230.
- [41] Luca Imeri and Mark R. Opp (2009) How (and why) the immune system makes us sleep. *Nature Reviews Neuroscience* (March 2009)10:199-210
- [42] Kenneth R. Alper (1999) The EEG and Cocaine Sensitization - A Hypothesis. *J Neuropsychiatry Clin Neurosci* (May 1999) 11:209-221.
- [43] "Scientific Revolution" (2007). Encarta.
- [44] Bruce G. Charlton (2008) False, trivial, obvious: Why new and revolutionary theories are typically disrespected. *Medical Hypotheses*. 71(1):1-3
- [45] http://en.wikipedia.org/wiki/Speed_of_light (last accessed November 20, 2011)
- [46] http://findarticles.com/p/articles/mi_m1134/is_1_114/ai_n15888020/ (last accessed November 20, 2011)
- [47] http://en.wikipedia.org/wiki/Theory_of_relativity (last accessed November 20, 2011)
- [48] http://en.wikipedia.org/wiki/Albert_Einstein (last accessed November 20, 2011)
- [49] http://abcnews.go.com/Technology/wireStory/clarificati-on-breaking-light-speed-story-14989402#.Tsim0_JnWzk (last accessed November 20, 2011)
- [50] <http://www.dailymail.co.uk/sciencetech/article-2040735/Speed-light-experiments-baffling-result-Cern-Did-Einstein-wrong.html> (last accessed November 20, 2011)
- [51] <http://www.dailymail.co.uk/sciencetech/article-2063163/Einstein-speed-light-2nd-set-scientists-particles-CAN-travel-faster-light.html> (last accessed November 20, 2011)
- [52] <http://www.brelson.com/2011/11/eating-your-boxer-shorts-on-live-tv/> (last accessed November 20, 2011)
- [53] <http://www.reuters.com/article/2011/11/18/science-neutrinos-light-idUSL5E7MI2D120111118> (last accessed November 20, 2011)
- [54] http://theory.uwinnipeg.ca/mod_tech/node135.html (last accessed November 20, 2011)
- [55] <http://www.lifeslittlemysteries.com/faster-than-light-neutrino-einstein-2083/> (last accessed November 20, 2011)
- [56] <http://www.techpowerup.com/forums/showthread.php?t=153302> (last accessed November 20, 2011)
- [57] http://www.nobelprize.org/nobel_prizes/physics/articles/ekspong/ (last accessed September 28, 2012)
- [58] <http://teamikaria.com/hddb/classic/introduction.htm> (last accessed September 28, 2012)

- [59] Neela Iyer, A. Prabhu Britto, N. Srimath, I.K. Sathyasundari, Sant Maa Vaishnavi Devi, Sant Maa Ananta Devi, Sant Maa Aparna Devi, Dhyanyogi Omdasji Maharaj (2011) Human-Machine Interactions based on Psychological Acceptance of the Divine Omdasji Sound Meditation as a Universal Cure for Human Diseases. IJBNS (2011), 1(1):1-31
- [60] <http://www.amjbot.org/content/93/10/1466.full> (last accessed Nov. 30, 2012)
- [61] <http://www.dailymail.co.uk/news/article-478558/So-Charles-right--talk-plants-scientists-discover.html> (last accessed Nov. 30, 2012)
- [62] http://www.dovesong.com/positive_music/plant_experiments.asp (last accessed Nov. 30, 2012)
- [63] http://cabiblog.typepad.com/hand_picked/2011/11/music-enhances-plant-growth-and-keeps-pests-at-bay.html (last accessed Nov. 30, 2012)
- [64] <http://amazing-creature.blogspot.in/2012/08/a-baby-rhesus-monkey-made-friends-with.html> (last accessed Dec. 15, 2012)
- [65] <http://amazing-creature.blogspot.in/2012/04/dog-and-tiger-cub-20-pics.html> (last accessed Dec. 15, 2012)
- [66] <http://www.pbs.org/wnet/nature/episodes/animal-odd-couples/meet-the-odd-couples/8025/> (last accessed Dec. 15, 2012)
- [67] <http://blog.chaukhat.com/2011/09/cheetahs-impala-deer-michel-denis-huot.html> (last accessed Dec. 15, 2012)
- [68] Neela Iyer, A.Prabhu Britto, K.Selvaraj, I.K.Sathyasundari, Justin Chernow, Elizabeth Maier, Sant Maa Vaishnavi Devi, Sant Maa Ananta Devi, Sant Maa Aparna Devi, Dhyanyogi Omdasji Maharaj (2010) Psychological Acceptance of the Divine Omdasji Sound Meditation as a Universal Cure for Human Diseases. IJBST (2010), 2(2):6-29
- [69] <http://www.thestar.com/news/world/article/1320982--dolphins-form-life-raft-in-attempt-to-save-dying-female-dolphin> (last accessed Jan. 29, 2013)