



# Symbiosis of smart objects across IoT environments

688156 - symbloTe - H2020-ICT-2015

## Report on Open Source Community Building

### The symbloTe Consortium

Intracom SA Telecom Solutions, ICOM, Greece  
Sveučiliste u Zagrebu Fakultet elektrotehnike i računarstva, UNIZG-FER, Croatia  
AIT Austrian Institute of Technology GmbH, AIT, Austria  
Nextworks Srl, NXW, Italy  
Consorzio Nazionale Interuniversitario per le Telecomunicazioni, CNIT, Italy  
ATOS Spain SA, ATOS, Spain  
University of Vienna, Faculty of Computer Science, UNIVIE, Austria  
Unidata S.p.A., UNIDATA, Italy  
Sensing & Control System S.L., S&C, Spain  
Fraunhofer IOSB, IOSB, Germany  
Ubiwhere, Lda, UW, Portugal  
VIPnet, d.o.o, VIP, Croatia  
Instytut Chemii Bioorganicznej Polskiej Akademii Nauk, PSNC, Poland  
NA.VI.GO. SCARL, NAVIGO, Italy  
Universität Zürich, UZH, Switzerland

© Copyright 2018, the Members of the symbloTe Consortium

For more information on this document or the symbloTe project, please contact:  
Sergios Soursos, INTRACOM TELECOM, [souse@intracom-telecom.com](mailto:souse@intracom-telecom.com)

## Document Control

**Title:** Report on Open Source Community Building  
**Type:** Public  
**Editor(s):** Reinhard Herzog  
**E-mail:** Reinhard.herzog@iosb.fraunhofer.de  
**Author(s):** Reinhard Herzog, Szymon Mueller  
**Doc ID:** D7.6-Community Building 1.1.doc

## Amendment History

Version	Date	Author	Description/Comments
V0.1	14.11.2018	Reinhard Herzog	Initial draft extracted from confluence documentation pages
	06.12.2018	Reinhard Herzog	Adding FER perspective on post-project support
			Community building best practices and roadmap
	07.12.2018	Reinhard Herzog	Developer Community Support
	10.12.2018	Reinhard Herzog	Relationship to eclipse
			Standards developing organisations
V0.2	12.12.2018	Szymon Mueller	Extend Developer Community Support
V0.3	17.12.2018	Szymon Mueller	Extending FIWARE analysis
V0.4	18.12.2018	Reinhard Herzog	Update Open Call, IoT-EPI, Executive summary descriptions, document structure overview
V0.5	18.12.2018	Szymon Mueller	Update of the document structure, editorial work
	19.12.2018	Ilia Pietri, Mario Kušek	Internal review
V0.6	20.12.2018	Reinhard Herzog	Update after internal review
V1.0	20.12.2018	Szymon Mueller	Final version
V1.1	27.12.2018	Szymon Mueller	Extending OC section

### Legal Notices

The information in this document is subject to change without notice.

The Members of the symbloTe Consortium make no warranty of any kind with regard to this document, including, but not limited to, the implied warranties of merchantability and fitness for a particular purpose. The Members of the symbloTe Consortium shall not be held liable for errors contained herein or direct, indirect, special, incidental or consequential damages in connection with the furnishing, performance, or use of this material.

## Table of Contents

<b>1</b>	<b>Executive Summary</b>	<b>5</b>
<b>2</b>	<b>Introduction</b>	<b>6</b>
2.1	Purpose of this document	6
2.2	Relation to other deliverables	6
2.3	Document structure	6
<b>3</b>	<b>Roadmap to Community Building</b>	<b>7</b>
3.1	Community Building Approach	7
3.2	IoT Open Source Landscape	7
3.3	The symbloTe-Vision	8
3.4	The symbloTe Mission	8
3.5	Best Practices on Open Source Community Building	9
3.6	Roadmap	10
<b>4</b>	<b>Developer Community Support</b>	<b>13</b>
4.1	Software Documentation	13
4.2	Jira Issue Management	14
4.3	Slack Channel Support	14
<b>5</b>	<b>Outreach Activities</b>	<b>16</b>
5.1	IoT-EPI	16
5.2	Hackathon	16
5.3	Open Calls Community	17
<b>6</b>	<b>Relationship to Open Source Developing Communities</b>	<b>19</b>
6.1	Eclipse	19
6.1.1	<i>Relevance to symbloTe</i>	19
6.1.2	<i>Architecture Alignment</i>	20
6.1.3	<i>Recommendations to Cooperate</i>	21
6.2	FIWARE	24
6.2.1	<i>Relevance to symbloTe</i>	24
6.2.2	<i>Architecture alignment</i>	25
6.2.3	<i>Syntactic and semantic interoperability approach</i>	27
6.2.4	<i>Cooperation opportunities</i>	28
<b>7</b>	<b>Standards Developing Organizations</b>	<b>29</b>
<b>8</b>	<b>Consortium Perspective on Post-Project Support</b>	<b>30</b>
8.1	General questions	30
8.2	Actions to be performed	30
8.3	Roles	31
8.4	Associated costs	32
8.5	Conclusion on Consortium Perspectives	32
<b>9</b>	<b>Outlook</b>	<b>33</b>
<b>10</b>	<b>References</b>	<b>34</b>
<b>11</b>	<b>Abbreviations</b>	<b>35</b>

## ***List of Figures***

Figure 1: IoT Open Source Landscape.....	7
Figure 2: Community Neighbourhood .....	10
Figure 3: Driving Building Blocks for the symbloTe Community .....	11
Figure 4: Active Slack users per week.....	14
Figure 5: Eclipse IoT WG Members (7. Nov 2017).....	19
Figure 6: Eclipse IoT Stack.....	20
Figure 7: Eclipse/symbloTe Standards Alignment .....	21
Figure 8 FIWARE IoT Services Enablement. ....	25
Figure 9 symbloTe architecture .....	26
Figure 10 Solution spectrum of possible approaches to semantic interoperability	27
Figure 11: symbloTe Relationship with SDOs .....	29

## ***List of Tables***

Table 1: Eclipse Discussion.....	22
----------------------------------	----

# 1 Executive Summary

As the vision of the symbloTe project is to integrate different Internet of Things (IoT) platforms and bridge diverse application domains, the challenge is not only technical, but also social. Our solution must be attractive to many application domains and must be supported not only by the SymbloTe team as the core developers, but also by external developers adopting IoT platforms and providing domain-specific enablers. Thus, a community that shares a common vision and agrees on common solutions is needed. This deliverable is dedicated to support the community building approach of symbloTe.

Community building is not a single task but is embedded in almost all aspects of the project. This deliverable will report on activities done by task T7.2 “Open Source Community Building” but will also refer to community building activities done in other work packages to give an overview on the general approach.

Also, we considered the most relevant partner organisations for open source developments in the IoT domain are the Eclipse Foundation<sup>1</sup> and the FIWARE<sup>2</sup> framework. For that reason, we analysed their conceptual approaches and discussed options to connect symbloTe to these communities. Some of these options have been implemented while others are subject for future consideration.

As an outlook for the community after the funding phase of symbloTe, the consortium positions on future engagements have been collected and show a broad willingness to keep up the symbloTe concepts and solutions. Thus, it is planned to establish a symbloTe alliance to give that community a framework for future cooperation.

---

<sup>1</sup> <https://www.eclipse.org/org/foundation/>

<sup>2</sup> <https://www.fiware.org/>

## 2 Introduction

### 2.1 Purpose of this document

This deliverable is the outcome of task T7.2, dedicated to targeted actions for disseminating the project in the open source community and accordingly encourage users and developers to use and contribute to the symbloTe open source software. It involves tracking of the open issues with regard to the code, organisation of promotional events (workshops with hands-on experience, hackathons) and participation in open source events.

This community building task supplemented the ongoing code development by responding to issues raised by the symbloTe developers as well as early adopters, like the extended consortium partners from the open calls. The symbloTe framework is designed to support complex scenarios and therefore has an inherent complexity. This task was responsible for coordinating the setup of easy adoptable testing examples, in order to simplify the first steps for external users. The software releases were quality tested before release, in order to convince early adopters of the quality of the software and the innovative potential and benefits of using symbloTe solutions.

Early adopters have been supported in their experimentations and developments with the symbloTe software. Provided feedback and contributions have been analysed and resulted in improving the code and documentation quality.

### 2.2 Relation to other deliverables

This deliverable has relations to D6.3 “Contest Text and Supporting Documentation”, D7.4 “Initial Exploitation Plans”, D7.5 “Report on Second External Liaisons Workshop”, and will complement the deliverables D7.7 “Final Dissemination and Exploitation Plans” and D7.8 “Final Report on Standardization Analysis and Recommendations”: D7.4 and D7.8 because community building requires long-term support perspectives, and D7.5 because it reports on the main group of symbloTe early adopters and partners. In D7.8 the relationships with Standards developing organisations are reported, which represent communities that are related to the symbloTe community.

### 2.3 Document structure

In Section 3, this document describes the general as well as the symbloTe vision and roadmap on how to reach out to create community around the symbloTe software. Section 4 describes actions done to provide proper technical support and documentation for symbloTe community. Section 5 provides information about outreach activities to broaden the community. Our relationship with two important partner communities for open source software in the IoT domain is analysed in Section 6, while Section 7 summarizes our links to the standard developing communities. For the long-term support of the symbloTe community, we collected the consortium positions for the post project phase and present them in Section 8. The document concludes with an outlook on the future and symbloTe community plans.

## 3 Roadmap to Community Building

### 3.1 Community Building Approach

The building of a community is probably one of the most difficult tasks, especially when it comes to Open Source Software (OSS). That is specifically true for a domain like the Internet of Things where so many products, frameworks, standards and alliances are being active. Each stakeholder has its own (hidden) agenda, disruptive solutions are emerging, promising concepts are disappearing. Power balance between alliances is constantly tipping and strategic roadmaps are turned upside down.

Nevertheless, there are a lot of good examples on successful OOS community building to learn from, and there are also some negative experiences to be avoided (see subsection Best Practices on Open Source Community Building).

An important point to start with is the vision. People need to see a purpose behind their doing and this purpose must be clearly visible to everybody. There must be no hidden purpose or some kind of inner circle steering the project behind the scenes. "The symbloTe-Vision" described in Section 3.3 is a first draft of a unique symbloTe-Vision to differentiate us from "just another platform".

After the overarching vision, the next step is the problem statement. As stated in [11], developers want to contribute to a cause not provide free labour.

### 3.2 IoT Open Source Landscape

The IoT European Platforms Initiative (EPI) created an overview on existing OSS projects within the IoT domain.



Figure 1: IoT Open Source Landscape

As can be seen, a large number of platforms are dedicated to the IoT domain. While it will be impossible to analyse all of them, we believe it is important to establish links to as many as possible. We have managed to connect OpenIoT<sup>3</sup>, OM2M<sup>4</sup>, openHAB<sup>5</sup>, Node-RED<sup>6</sup> directly to symbloTe and we have analysed Eclipse and FIWARE on the architectural level and identified opportunities to integrate (Figure 1).

### **3.3 The symbloTe Vision**

The driving idea behind the Internet of Things is the ubiquitous presence of smart objects, all connected and available, and creating a meaningful context for all kind of powerful applications. This vision is so attractive that the number of IoT platforms are currently growing at an impressive speed, each one claiming to be the fastest, the most flexible, the smartest, the best at least for their domain. As a result of this very innovative development, we have a broad spectrum of IoT-platforms, separating the IoT-world into information silos.

All IoT-platforms are considered to be open and willing to open their silos. But in practice, each platform plays by its own rules. They are providing APIs, data models and policies, and as long as clients play along these rules, the platform is open. Situation that all platforms follow the strategy of hoping that people will decide for them results in a deadlock.

This is where symbloTe steps in. First of all, symbloTe is not an IoT-platform, but a platform middleware. SymbloTe does not break into existing IoT-ecosystems by changing anything within their domain. There are probably good reasons why an IoT-ecosystem has chosen a specific API or a particular data model and there is no reason to change this. This is also true for any other IoT-ecosystem from which data shall be used across IoT-ecosystem boundaries. SymbloTe will support this, by providing a framework to bridge ecosystems. This will include data model mapping, like query rewriting and data translation, as well as security management in federated middleware scenarios.

SymbloTe will not store any data by its own, but it will provide an architecture and tools to federate IoT-middleware solutions to merge IoT-ecosystems.

### **3.4 The symbloTe Mission**

The symbloTe vision is big and cannot be achieved only by the involved symbloTe consortium, however a good starting point and a plan is an important step towards it.

Our mission for the given project time is to work out the architectural blueprint for our vision as best as possible and convince the IoT community to adopt and maybe improve our solution.

The partners envisioned to be engaged and involved in our mission are the following:

---

<sup>3</sup> <http://www.openiot.eu/>

<sup>4</sup> <https://www.eclipse.org/om2m/>

<sup>5</sup> <https://www.openhab.org/>

<sup>6</sup> <https://nodered.org/>



- Our open call partners: They will look at our offerings first of all from a technical point of view, which helps us improve our technology, but will also evaluate them from a business perspective, which will help understand the relevant requirements and find the potential to evolve.
- Partners within standards developing organizations: Some of the consortium members are involved in working groups dedicated to develop standards for the IoT domain. These groups are representing communities working on API specifications, integration concepts or interoperability approaches. In all cases there are potentials to harmonize activities and solutions, in order to join forces and create even stronger communities.
- Existing Open Source Developing Communities: Open source software is playing a major role in modern ICT solutions. With that development, several open source communities have been established in order to provide guidelines, tools, and platforms to support the open source communities. It is important to understand their approaches, offerings and goals in order to decide if a cooperation can be beneficial.

### **3.5 Best Practices on Open Source Community Building**

When building an Open Source community there are pitfalls to be avoided and lessons to learn from. Below there is a small collection of Best Practices on that issue:

Six ways to build a solid community by Rebecca Fernandez, Red Hat<sup>7</sup>:

- Be purpose-driven.
- Keep your focus on your purpose and your members.
- Be deliberate in your decisions about a community and its culture.
- Find tools and strategies that support communities.
- Involve your members.
- Empower your members.

Five best practices in open source: internal collaboration, by Ben Balter, Government Evangelist at GitHub<sup>8</sup>:

- The technology is the easy part.
- Start small, go through the motions.
- Minimize information imbalance.
- Embrace the constraints of open source.
- Open source problems, not solutions.

Five best practices in open source: external engagement, also by Ben Balter, Government Evangelist at GitHub<sup>9</sup>:

---

<sup>7</sup> <https://opensource.com/business/11/1/six-ways-build-solid-community>

<sup>8</sup> <http://ben.balter.com/2015/03/08/open-source-best-practices-internal-collaboration/>

<sup>9</sup> <http://ben.balter.com/2015/03/17/open-source-best-practices-external-engagement/>

- Expand your definition of stakeholders.
- Be the hub, encourage spokes.
- Minimize friction.
- Decentralize governance.
- Encourage contributors.

### 3.6 Roadmap

As a first step on a roadmap towards a symbloTe community, it is important to know where to start from. In Figure 2, the neighbourhood community for the symbloTe consortium is shown.

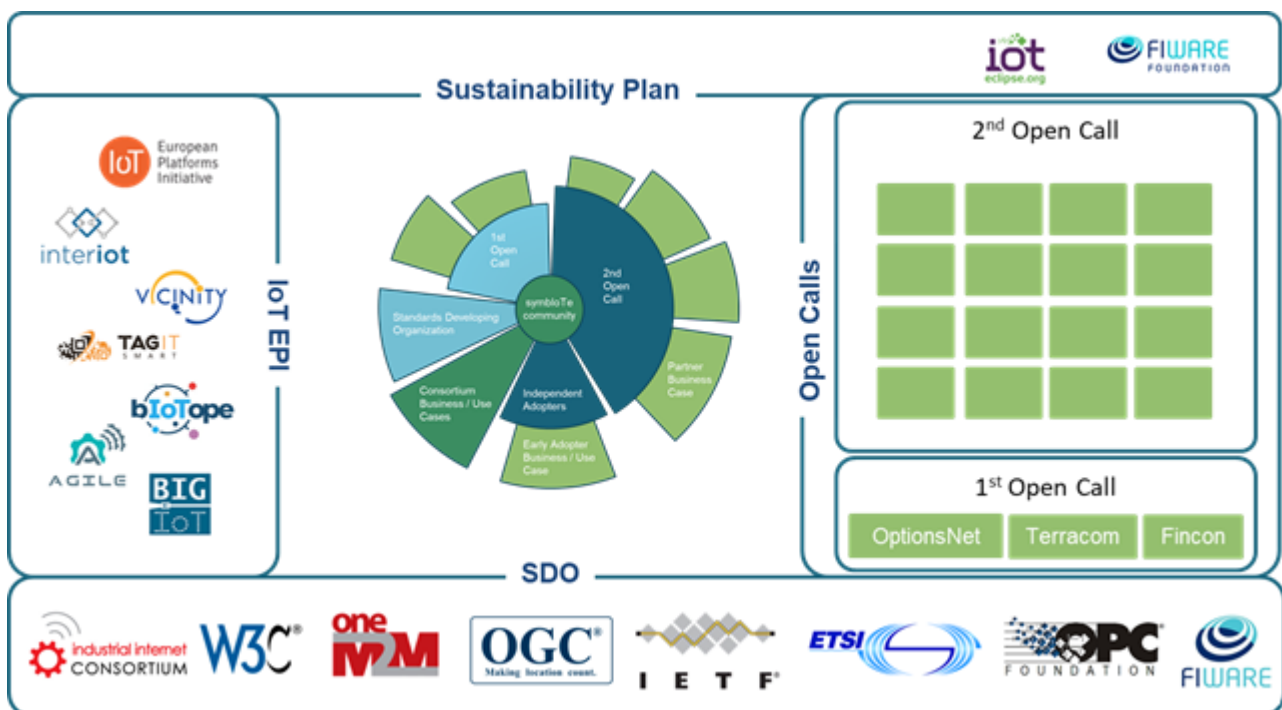

Figure 2: Community Neighbourhood

A common ground for our community neighbourhood is provided by the standard developing organisations (SDOs). Fortunately, some members of the symbloTe consortium are active members of SDOs that are working in the IoT domain. That gives us insights into developing strategies and technology roadmaps that are relevant for future IoT standards landscape. It gives us also the opportunity to feed symbloTe concepts, ideas and solutions as input into SDO working groups.

Companions on the way to building a community are our partner IoT projects, organized within the IoT European Platform Initiative, with whom we are already representing a significant part of the European IoT community.

Also, important community neighbourhoods are the open source communities, like Eclipse for FIWARE. Together with them we can share software and knowledge and we can try to align our architectures.

Finally, we have our open call partners. They have been provided with resources to adopt symbloTe into their own products and business solutions. The developments derived from these projects are the most concrete assets on our roadmap.

Figure 3 shows the roadmap used within the project time, which also shows our expectation for the future.

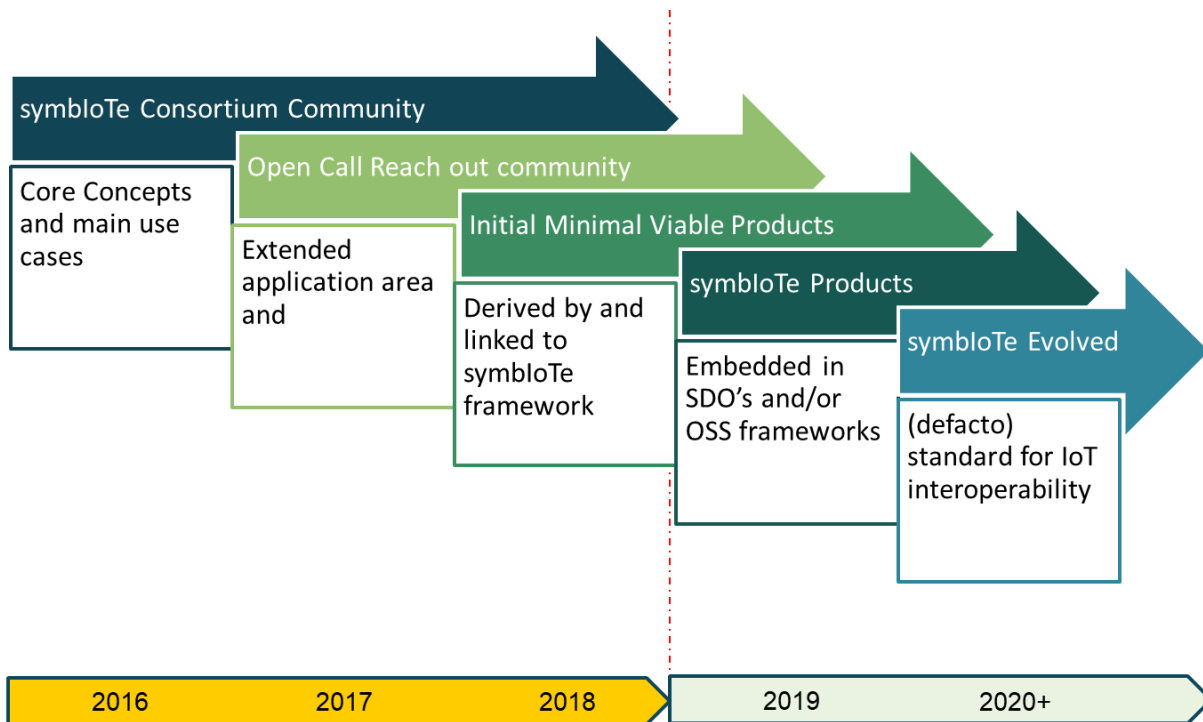

Figure 3: Driving Building Blocks for the symbloTe Community

During the financing phase of the symbloTe project (2016-2018), the core concepts and the main use cases have been developed within the consortium community. This helped to bond consortium members into partnerships dedicated to support software components and use-case applications. That leads ongoing partnerships, most likely beyond the project phase.

The Open Call (OC) community was established within the project time, but in many cases the OC partners indicated an interest to continue the usage of the symbloTe components and the cooperation with symbloTe partners. This is the first outreach activity that goes beyond the project end time. The second outreach activity is the definition of Minimal Viable Products (MVPs). This is a subset of the symbloTe framework, that is also usable outside the framework either as stand-alone solutions or integrated into other frameworks. Even in cases where MVPs are being used as individual software, it is most desirable to maintain a synchronization link to the symbloTe framework. Improvements within MVPs will then also be available to symbloTe.

After the project phase, the consortium partners will continue their work within SDOs and will exploit symbloTe assets whenever it is useful, which will also widen the impact of symbloTe. This is also true for the cooperation with other open source software frameworks.

An ultimate goal for symbloTe for the more distant future is to set standards either by itself or, as described earlier, by cooperation with partners.

## 4 Developer Community Support

During the project development the internal and external users of symbloTe have been supported on multiple channels. The approach followed was to be as transparent as possible. For that reason, all discussions and issues have been done openly in the community and only some topic specific filtering has been used to avoid communication traffic overload within the channels.

### 4.1 Software Documentation

The symbloTe software has been written in Java and is publicly available as a GitHub project:

- <https://github.com/symbiote-h2020/>

It consists of 72 repositories in total with 4 main spaces: symbloTe Core, symbloTe Cloud, symbloTe Enabler and symbloTe Smart Space. Individual components follow the Javadoc template to provide detailed and informative description of the classes and methods. Moreover, a detailed description of the integration process with the symbloTe middleware has been provided in the form of GitHub wiki pages:

- symbloTe Core:
  - <https://github.com/symbiote-h2020/SymbioteCore/wiki>
- symbloTe Cloud:
  - <https://github.com/symbiote-h2020/SymbioteCloud/wiki>
- symbloTe Enabler:
  - <https://github.com/symbiote-h2020/SymbioteEnabler/wiki>
- symbloTe Smart Space:
  - <https://github.com/symbiote-h2020/SymbioteSmartSpace/wiki>

The wiki pages provide information about the server requirements and prerequisite tools, and describe the integration process with the existing codebase of the project. The documentation also includes multiple examples about how to properly use the software, how to use information models provided by symbloTe as well as use platform-specific extensions of the models to describe existing entities and platforms. To alleviate deployment process of each symbloTe layer, three options have been made available:

- downloading and compiling source code from the GitHub, with manual configuration,
- using pre-built executable jars, available from JitPack<sup>10</sup> repository,
- using Docker<sup>11</sup> containers.

---

<sup>10</sup> <https://jitpack.io>

<sup>11</sup> <https://www.docker.com/>

To enhance visibility of the symbloTe middleware to an open source community a dedicated webpage has been created presenting the software releases and collecting in a central place links to various sections of documentation. The website is available at:

- <https://middleware.symbiote-h2020.eu/>

## 4.2 Jira Issue Management

Jira<sup>12</sup> is a project management tool which is commonly used in projects to track the development progress, report bugs and propose improvements or new features. This service is open for all users. In the symbloTe we used this tool internally to plan release features to be implemented by the symbloTe development team and externally for various communities, such as Open Call winners, hackathon and other developers to report issues with the software. The project's Jira is available at:

- <https://symbiote-h2020.eu/jira>

As of the end of the project Jira has been used to create over 100 epics, 320 stories, 400 tasks and subtasks as well as report over 50 bugs.

## 4.3 Slack Channel Support

To allow users, component developers and service administrators communicate in a more direct way we also provide access to slack channel, The slack channel has been mainly used to guide symbloTe trials participants, as well as Open Call members during the integration process. Our slack channel is available at:

- <https://symbiote-h2020.slack.com>

It has been divided into channels to focus the discussion on specific topics, such as the general channel where announcements of servers downtimes were announced, the integration channel to answer and help users with integration issues, generic and use case specific enabler channels and separate channels dedicated to support hackathon participants, OC1 and OC2 participants.

Figure 4 shows the number of active users per week within the symbiote-h2020 slack channel. It shows that during the lifetime of the channel, an increasing number of people have been using it, most visible during periods of inviting OC1 partners (Jun-Nov 2017), OC2 partners (May-Oct 2018), and during running of the trials (throughout 2018).

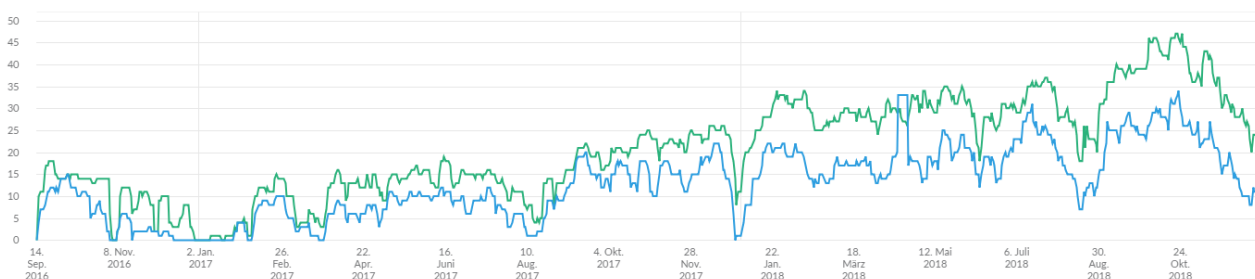

Figure 4: Active Slack users per week

<sup>12</sup> <https://www.atlassian.com/software/jira>

The experiences of this community have been used to improve the documentation of the symbloTe software as well as the description of the integration process and examples used to accommodate various platform configurations and setups.

## 5 Outreach Activities

As the developer community support, described in the previous chapter, was directed to already established community, the outreach activities in this chapter are directed to external communities. The intention is to connect with stakeholders as potentially interested parties, to communicate our offerings, align common requirements, and to discover opportunities to extend our community.

### 5.1 IoT-EPI

A very important outreach activity to the European community for IoT developments was the IoT-European Platform Initiative (EPI) organized by the European Commission. The initiative was organized on six different task forces and one group dedicated to common communication activities:

- TF01: Innovation
- TF02: Platform Interoperability
- TF03: IoT Accelerators
- TF04: IoT Business Models
- TF05: Educational Platforms
- TF06: International Cooperation
- Communication Working Group

SymbloTe contributed to each task force group. It helped give the ongoing IoT-EPI projects a common voice and assisted the projects to align conceptual architectures, find new innovation and business opportunities, coordinate international cooperation's and provide common instruments for educational purposes.

The most valuable results of the IoT-EPI task force groups are the common white paper on platform interoperability [10], created by members from TF02. Also, common activities, like the InterOSS-IoT workshops or the Global IoT Summit, have been very helpful to attract a large number of interested subject matter experts.

A specifically close project partnership has been evolved between symbloTe and BIG-IoT. Common activities have created a good common technical understanding and outreach strategies, like the semantic things descriptions within the W3C web of things working group.

### 5.2 Hackathon

A very popular type of event for open source developers is a so-called hackathon. A hackathon (also known as a hack day, hackfest or codefest) is a design sprint-like event in which computer programmers and others involved in software development, including graphic designers, interface designers, project managers, and others, often including subject-matter-experts, collaborate intensively on software projects.



Together with our partner project BIG-IoT, the symbloTe team organized hackathon during the IoT World Congress in Barcelona on October 17-18, 2018. To point out the special relation to smart cities, it has been called it HackaTown: the IoT Interoperability Hackathon. The main goal for participants was to co-create virtual interoperable IoT smart city solutions, and was dedicated to:

- mobile/web app developers to create symbloTe-powered application,
- cloud-based service owners to use the symbloTe libraries to create cross-domain added-value offerings.

Various communities have been contacted and informed about the event, including IoT communities (IoT meetup in Zagreb, Greek IoT community), co-working places (Barcelona's Talent Garden, BCN575, Valkiria), research institutes and universities (CCTC, Universitat Politècnica de València). The coordination of the hackathon was done by the WP6 team. More details can be found in [2].

### **5.3 Open Calls Community**

The symbloTe project has implemented the new H2020 instrument for community building, called the Open Calls. The main concept is that part of the project budget is dedicated to temporarily open the consortium for other partners. The idea is to extend the scope of the applications, discover new business cases, and to support early adopters of the software. This is an excellent instrument to extend the user community, as it attracts many potential external users to consider the symbloTe solutions and enables early developments without financial risks for the elected Open Call partners.

The Open Calls have taken place within the scope of WP6 and the details have been reported in [2]. The first Open Call was dedicated to IoT platform and service owners to join a growing symbloTe ecosystem, expand its potential offerings and validate symbloTe's approach and technical solutions. The second Open Call was extended to also include cross-domain smart applications, smart space solutions (e.g. IoT gateways, IP-native smart devices) and also IoT platforms wishing to federate with existing symbloTe platforms. It was also open to organizations, municipalities and companies to be involved in symbloTe trials in the "Smart Mobility and Ecological Urban Routing" use case.

We received a broad interest for our calls. For the first open call there were 34 eligible proposals, including 21 commercial platforms and offering 13 pilot/pab prototype developments. For the second open call we received 51 eligible proposals. These figures indicate the broad outreach, as all of the proposals have been studying the symbloTe solutions and considering the adaptation of their own platform or application. The winners were expanding communities organised within Smart Marinas, Smart Supply Chain, Smart Building, Smart Residence/Office, Smart City, Smart Mobility, Smart Logistics, Smart Campus and Smart Stadium domains.

The applicants joining symbloTe were not only one of the first adopters of symbloTe software but also joined symbloTe community: most of the partners were using developer support tools described in section 4, moreover a special dedicated space in the project confluence webpage<sup>13</sup> have been created to collect in one place all the information

---

<sup>13</sup> <https://colab.intracom-telecom.com/>

required for the OC winners, including administrative materials, technical details, meeting notes, webinars and space for questions and discussion. Open Call participants were also taking part in various community events organized by symbloTe where they met with symbloTe consortium, other symbloTe adopters and discuss potential opportunities concentrated around symbloTe:

- Meeting with Third Parties in Poznan, 06.07.2017 – including technical session with OC1 winners and Living Lab on future IoT scenarios,
- Meeting with Third Parties in Viareggio, 11.05.2018 – first face-to-face meeting with OC2 partners, organised along Versilia Yachting Rendez-vous Boat Show,
- Closing OC2 meeting in Madrid, 15.11.2018 – presentations and demos of OC2 winners, business workshops focusing on different compliance levels of symbloTe: L1 (including applications), L2 and L3/4.

After the successful implementation of the Open Calls a set of inquiries have been made to collect the assessments of the OC participants. Most partners have indicated their interest in using the symbloTe solutions in the future, pointing out opportunities of new services, customers and revenue sources. In some cases the Open Call partners are also supporting the symbloTe outreach to standard developing organisations. Our partner Sensinov from the second Open Call, provided an oneM2M integration, and proposed the symbloTe API as an alternative way to achieve interoperability for the oneM2M standard. They have concluded that it may have some advantages over the oneM2M solution for interoperability, because the oneM2M MCC' interface might be heavyweight for some cases. SymbloTe can be considered as a lightweight solution with restricted scope.

## 6 Relationship to Open Source Developing Communities

### 6.1 Eclipse

#### 6.1.1 Relevance to symbloTe

The Eclipse IoT Working Group<sup>14</sup> describes itself as a collaboration between organizations and individuals who share the goal of creating an open IoT. The collaboration focuses on the development, promotion and adoption of open source IoT technology. Their members provide a wide range of projects and services built on top of Eclipse IoT technology.

The current members of the working group are representing companies from very different application areas.



Figure 5: Eclipse IoT WG Members (7. Nov 2017)

The current focus of the group seems to be oriented into the industrial automation areas. This can be seen in the two Eclipse IoT Open Testbeds:

<sup>14</sup> <https://iot.eclipse.org/working-group/>

- Asset Tracking,
- Production Performance Management.

Both testbeds are designed to use IoT concepts to enhance classical industrial automation application. However, even if this is the current centre of activity, the group is not limited by design to the automation domain. Other areas like smart home seems to be in an incubation phase; for example, the SmartHome API project is planning to publish its first stable release.

### 6.1.2 Architecture Alignment

The Eclipse IoT Working Group released a white paper [1] defining their understanding on an IoT architecture. This architecture covers three stacks for constrained devices, gateways and smart devices, and IoT cloud platforms (see Figure 6). For the alignment with the symbloTe architecture the gateways and smart devices stack, as well as the IoT cloud platform stack, are relevant.

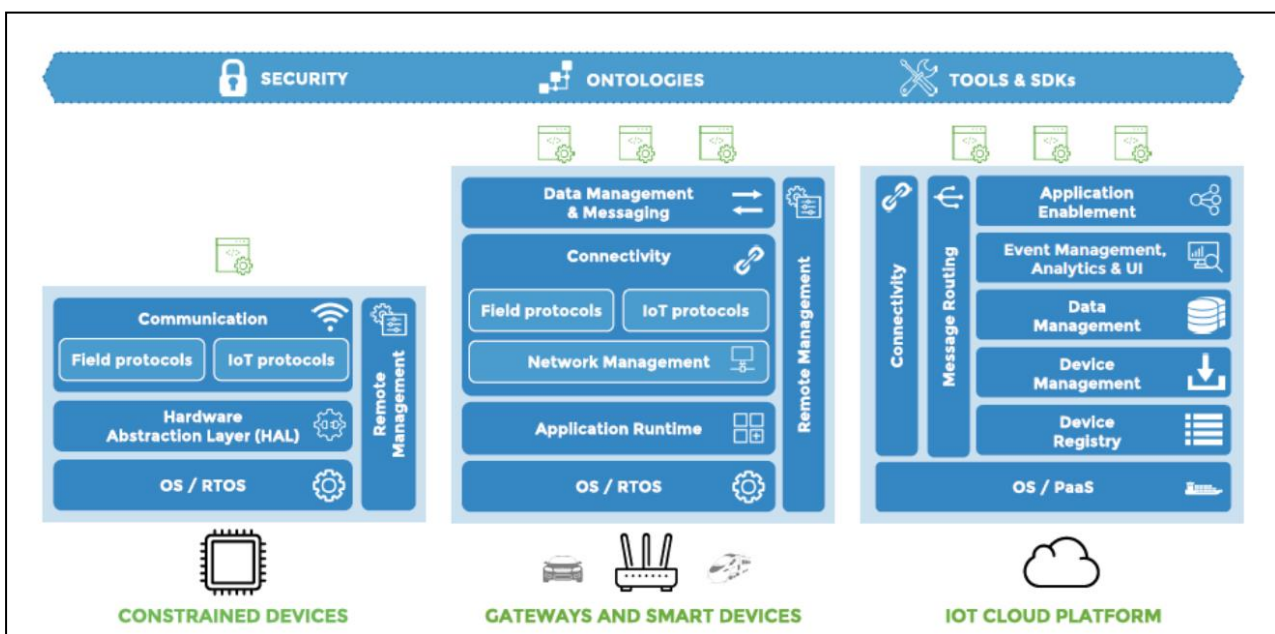

Figure 6: Eclipse IoT Stack

While the stacks are not equal to the symbloTe architecture, there are similarities that can provide a common ground for synchronizing the symbloTe approach with the Eclipse concepts.

Another way to align symbloTe and Eclipse is to use the same standards. Figure 7 shows the standards used within the Eclipse IoT working groups and the ones used within symbloTe.

Unfortunately, there are not so many common standards. The CoAP protocol is mentioned in Eclipse, and this is also used in symbloTe. SymbloTe is using a OData approach on top of CoAP, but OData are not explicitly mentioned in Eclipse. With the authorisation and authentication services, symbloTe is using the OAuth standard. Within Eclipse there is no such standard mentioned. The same is true for OWL, RDF and SPARQL. For publish/subscribe based applications, symbloTe is using WebSockets, while Eclipse relies

on MQTT. The only standard referred in both parts is the OGC SensorThings API standard. SymbloTe has adopted this standard into its data model and used it as an example for its API design. Eclipse has a project in a very early phase, and it not so clear if it will be integral part of the Eclipse architecture.

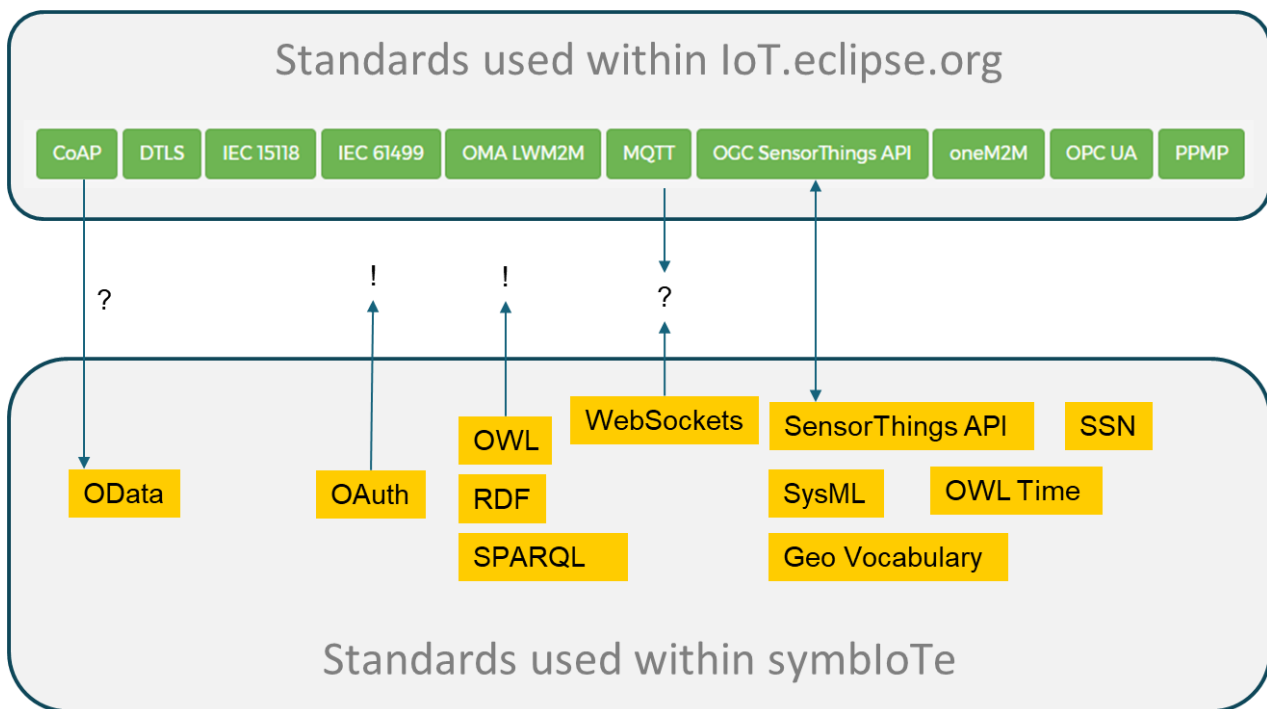

Figure 7: Eclipse/symbloTe Standards Alignment

The best option for alignment provides the semantic modelling area. The OGC SensorThings API standards is used by the Eclipse project Whiskers, and it is also included in the symbloTe Core Information Model. Semantic descriptions are also part of the SmartHome project, as an API definition of a semantic layer to access smart home devices. Also Eclipse Vorto, and Kapua are using semantic descriptions to describe their resources. For these projects, symbloTe has the potential to contribute.

On a more basic level, standards like CoAP, OData and MQTT are also candidates for architectural alignments.

### 6.1.3 Recommendations to Cooperate

There are several possible ways to cooperate with the Eclipse open source community:

- to make symbloTe an Eclipse project,
- to use Eclipse projects within symbloTe,
- to design symbloTe components as Eclipse projects,
- not to contribute at all.

There have been many arguments for all directions, some preferences for one solution over the other, and also many uncertainties, as explained below. Table 1 summarizes the main arguments for the first option.

Table 1: Eclipse Discussion

Topic	Pro	Contra
<p><b>Are we ready to accept the eclipse <a href="#">rules of engagement</a>?</b></p> <p>Open - Eclipse is open to all; Eclipse provides the same opportunity to all. Everyone participates with the same rules; there are no rules to exclude any potential contributors which include, of course, direct competitors in the marketplace.</p> <p>Transparent - Project discussions, minutes, deliberations, project plans, plans for new features, and other artifacts are open, public, and easily accessible.</p> <p>Meritocracy - Eclipse is a meritocracy. The more you contribute the more responsibility you will earn. Leadership roles in Eclipse are also merit-based and earned by peer acclaim.</p>	<p>These are our rules anyway.</p>	<p>The transparent rule requires to make our discussions public, even at a stage where we are not so sure about our options. This conflicts with our current confluence based discussions.</p>
<p><b>Are we ready to give up our symbloTe <a href="#">trademark to Eclipse</a>?</b></p> <p>All Eclipse projects and corresponding software products are trademarks of the Eclipse Foundation. As a legal entity, the Eclipse Foundation owns all Eclipse project and corresponding product trademarks on behalf of the Eclipse community. This prevents companies from misusing or misrepresenting their products as being the projects. The EMO will initiate a trademark review as part of the project creation or renaming process. Existing project name trademarks must be transferred to the Eclipse Foundation (please see the <a href="#">Trademark Transfer Agreement</a>).</p>	<p>We could, because at the end of our project, the symbloTe consortium will not exist anymore and our trademark ownership will be unresolved.</p>	<p>That is a difficult decision and has significant legal consequences.</p>
<p><b>Do we want to accept the project <a href="#">structure and organization</a> requested by Eclipse?</b></p>	<p>The changes are probably not very big,</p>	<p>That would require changes in our already</p>

<p>Open source projects at the Eclipse Foundation are required to make use of certain Eclipse Foundation services:</p> <ul style="list-style-type: none"> <li>All project issues must be tracked in a the issue tracker assigned to the project;</li> <li>Source code must be maintained in source code repositories assigned to the project (e.g. an Eclipse <a href="#">Git</a> or <a href="#">Gerrit</a> instance, or the <a href="#">Eclipse Organization</a> on GitHub);</li> <li>All third-party libraries used by the project must be tracked and approved for use by the Eclipse IP Team;</li> <li>Downloads must be distributed via a forge-specific downloads server;</li> <li>Developer (committer) communication must occur in the <i>dev</i> list provided to the project by the Eclipse Foundation; and</li> <li>Projects must keep their <a href="#">Project Metadata</a> up-to-date.</li> </ul>	<p>because we are mostly in-line with the requires structure.</p>	<p>established structure. That causes management risks which are difficult to assess.</p>
<p><b>Are we ready to accept the Eclipse <a href="#">release review rules</a>?</b></p> <p>Releases are formal for Eclipse projects. They start with planning, and end with a community review. You can capture as many future releases as you'd like. It's common practice to specify releases three or six months into the future.</p> <p>A <i>release review</i> is a formal announcement of your release to the community and a request for feedback. In practical terms, experience has shown that those individuals and organizations who are interested in your project follow development throughout the release cycle and so are have likely already provided feedback during the development cycle (i.e. they are unlikely to provide feedback during the review period). With this in mind, the review generally serves as a means for a project to engage in a retrospective of the progress made during the release, discover areas of potential improvement, demonstrate that the project is operating in an open and transparent manner, and ensure that the development process and intellectual due diligence</p>	<p>They make sense for released project. While in incubation phase easier rules are accepted.</p>	<p>That overrides our own authority to make decisions and it might contradict with our release policies.</p>

processes have been followed.		
<b>Do we benefit from making symbloTe a Eclipse project?</b>	There might be a benefit after the end of the symbloTe funding phase. To make symbloTe sustainable, we need to decouple it from the H2020-funded support to a contributor-based support.	Moving to Eclipse would require work and maybe modification in our development process, which are critical from a project management point in time.

At the end of the discussion, the symbloTe consortium did not decide to bring symbloTe into the Eclipse foundation. The second option to make use of Eclipse projects within symbloTe has been considered, but no suitable projects have been found. This is mainly due to the current focus of the Eclipse working groups to the automation sector and also due to the fact, that many projects are still in their incubation phase.

No cooperation with Eclipse was also not considered a good option, as the foundation represents an important open source community that cannot be ignored.

It has been decided, that the best option is to design symbloTe components in a way that they can be integrated into other frameworks, like Kapua, Hono, SmartHome and others. The symbloTe approach for that support are the MVPs (see [3] for their definitions).

The symbloTe approaches to the air quality crowd sensing can be a very good option to propose a testbed for the Eclipse IoT Working Groups and contribute with our ecosystems.

## 6.2 FIWARE

### 6.2.1 Relevance to symbloTe

FIWARE<sup>15</sup> is a curated framework of open source platform components used to accelerate the development of Smart Solutions. It focuses on gathering, managing, processing and exchanging the context information being provided by different actors involved in the ecosystem. Its building blocks comprise mandatory FIWARE Orion Context Broker Generic Enabler and a number of Generic Enablers (GE) providing various functionalities. The community efforts of FIWARE focus on expanding the global reach of FIWARE, creating innovation hubs and organizing entities contributing to achieving FIWARE mission.

One of the parts of FIWARE's Reference Architecture is Internet of Things Services Enablement chapter, for which deployment is following distributed architecture on different layers: Device, Gateway and Backend. The cornerstone of all FIWARE solutions is usage

---

<sup>15</sup> <https://www.fiware.org/>



of FIWARE NGSI API<sup>16</sup> (based on OMA NGSI Context Management specification, see [6]) to exchange information between the components through NGSI9/10 interfaces. The NGSI model and FIWARE solutions have been compared with the approach taken by symbloTe and possibilities of cooperation and contribution to the community have been discussed.

## 6.2.2 Architecture alignment

FIWARE IoT Services Enablement provides Generic Enablers that allow IoT resources (called *things*) to be made available, searchable and accessible. This is done by representing them as NGSI Context Entities and allowing users of FIWARE apps interact with them through Data ContextBroker, whether they are sensors or actuators. Figure 8 represents the architecture of this solution.

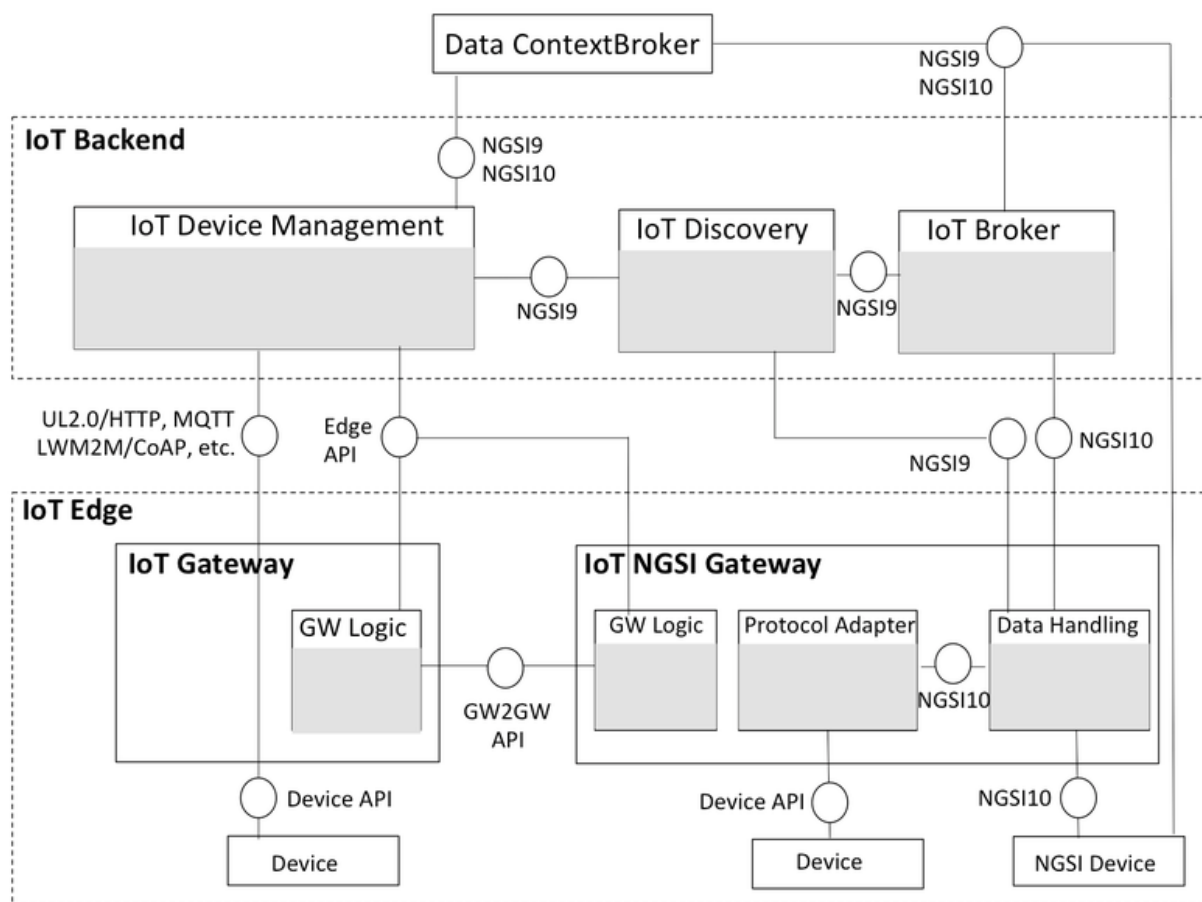

Figure 8 FIWARE IoT Services Enablement.

Integrating IoT device so that it is accessible from Context Broker can be done in several ways. One of the possibilities is to use Backend IoT Device Management, which is responsible for translating either Device or Gateway specific protocols into NGSI model. FIWARE provides the IDAS component<sup>17</sup>, which is the implementation of the Backend

<sup>16</sup> <http://fiware.github.io/specifications/ngsiv2/stable/>

<sup>17</sup> <https://catalogue-server.fiware.org/enablers/backend-device-management-idas>

Device Management, consisting of IoT Adapters for various IoT protocols (such as LoRaWAN or JSON/UltraLight2.0 over HTTP/MQTT).

Another integration option for NGSI-powered devices is to either use them directly from the Context Broker or push them to Edge NGSI Gateway Data Handling to perform events classification and/or composition. On the Backend level this information can be used to provide discovery facilities for both atomic devices and virtual devices created by processing or composing data of connected device(s). This is done by functions offered by IoT Broker and IoT Discovery components.

FIWARE architecture can be related to the symbloTe architecture shown in Figure 9.

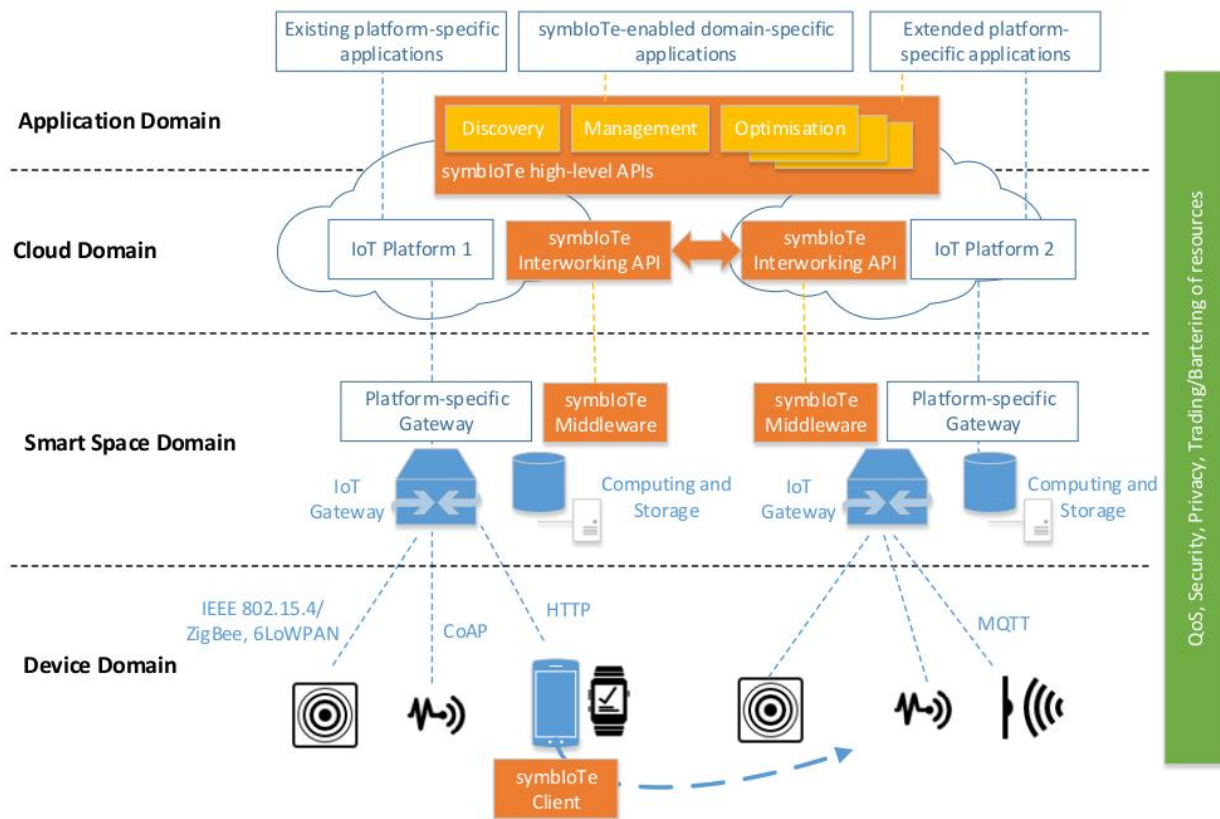

Figure 9 symbloTe architecture

We can see a similar layered approach, with physical devices being connected to Edge/Smart Space elements, such as IoT gateways, by using various connection protocols. The Backend/Cloud Domain components are responsible for maintaining a virtual representation of the devices and accessing them from the Context Broker/Application layer. The difference is on how the data is transmitted to/from the devices to the application layer. In symbloTe, we use the Core components, offering discovery and management capabilities of the meta-information of the entities from Cloud, Smart Space and Device domains, but no actual data from e.g. devices is stored in the Core. Applications can query Core for relevant resources by using symbloTe high-level APIs (including semantic search functionalities), but to access the data itself they need to contact each platform (or smart space) directly, by using the access point obtained from the Core.

Handling of meta-information and data in the case of the FIWARE solution is different. The core principle of FIWARE Context Broker is to manage context information about entities being shared with it. In IoT case this means handling both description of the available resources as well as the actual parameters of the devices, e.g. current temperature or speed. This is then propagated and updated on the Context Broker side, and available to the applications directly. This approach allows context subscription not only on devices of a certain type but also on parameters and their values, and also supports filtering options (when value of a parameters meets certain criteria). On the other hand, subscriptions in symbloTe, similar to resource access, are done by platform side, not by the central Core part. Both solutions have their merits, but pose a serious difficulty in aligning both approaches and making them compatible and complementary.

### 6.2.3 Syntactic and semantic interoperability approach

The problem of how to achieve syntactic and semantic interoperability in IoT world has been heavily discussed within symbloTe project (see deliverables [8], [9]) and in open forums (see [7], [10]). Projects considering this topic follow one of the solutions presented in Figure 10.

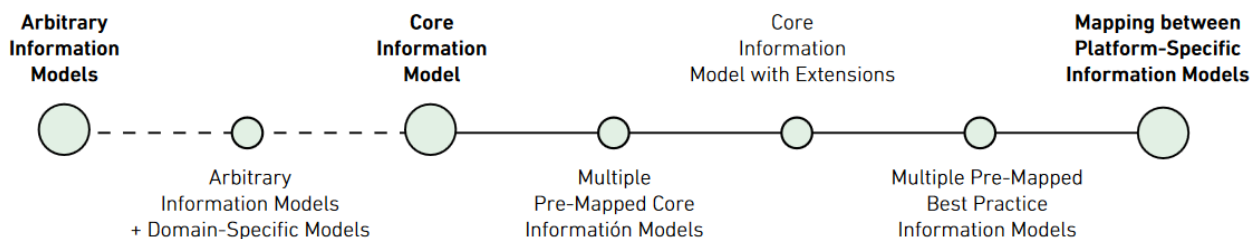

Figure 10 Solution spectrum of possible approaches to semantic interoperability

symbloTe is using Core Information Model with Extension solution, offering two basic models: Core and Meta Information Models (CIM and MIM, respectively) with possibility of defining so-called Platform-Specific Information Models (PIM). Within the project a set of use-case-specific PIMs have been created, called Best Practice Information Models (BIM). This allows a platform to retain their platform specific ontologies by just aligning them with the CIM and to offer higher level of interoperability between platforms using different models by the usage of *semantic mappings*, handled on both Core and Cloud layers.

On the other hand, FIWARE approach follows Arbitrary Information Models solution, by specifying OMA NGSI meta-model allowing definition and exchanging of the context information with semantic interoperability solution depending on the involved components – if they are able to understand the information being passed to them. This shift of responsibility of handling interoperability issues compared to symbloTe semantic solutions makes aligning both frameworks difficult. Work in the area of extending FIWARE data models with semantic Linked Data has been started in ETSI NGSI-LD specification<sup>18</sup>, which could allow integration between FIWARE Context Broker and symbloTe Search and Resource Access Proxy components, but this effort started too late in the symbloTe project lifetime to be considered for development contribution to FIWARE GE.

<sup>18</sup> [https://docbox.etsi.org/ISG/CIM/Open/ISG\\_CIM\\_NGSI-LD\\_API\\_Draft\\_for\\_public\\_review.pdf](https://docbox.etsi.org/ISG/CIM/Open/ISG_CIM_NGSI-LD_API_Draft_for_public_review.pdf)

#### 6.2.4 Cooperation opportunities

Several options of cooperation have been presented and discussed within symbloTe consortium:

- Integrating selected SymbloTe functionality/components with existing FIWARE offers,
- Add selected SymbloTe functionality/components as Generic Enabler.

One of the platforms used in symbloTe's Smart Mobility and Ecological Routing use case is Ubiwhere's Mobility Backend as a Service – MoBaaS, which provides an efficient routing service, as well as traffic and parking data. This platform is deployed using FIWARE components and offer its data through Orion Context Broker. This endpoint has been integrated with symbloTe Cloud domain as MoBaaS IoT Platform and offered as a virtual resource to be searchable and accessible from the application layer. This shows how easy it is for FIWARE-enabled platform to be integrated into symbloTe stack and operate on NGSI model used by MoBaaS by using BIM definition for smart mobility use case<sup>19</sup>.

FIWARE allows external entities to contribute by implementing Generic Enabler solving particular problem or extending FIWARE's technological reach. Various possibilities of what could be proposed as GE has been examined:

- querying and search capability of symbloTe Core
- symbloTe generic or domain-specific enabler solution

The problem with offering a Generic Enabler for symbloTe Core functionalities is architectural: symbloTe Core is storing only meta-information about the objects (platforms, resources), while access to the resources to read the sensor data, invoke service or perform actuation is available only by directly contacting symbloTe Cloud components (Resource Access Proxy, Authentication and Authorization Manager). A similar problem has been identified when analysing symbloTe enabler architecture, which relies on the registration of virtual resources and services in the Core, providing added, domain-specific value by composing or processing data obtained from resources of involved platforms. But the access to these virtual resources and services is achieved by reusing symbloTe Cloud components, resulting in the same problem described above.

---

<sup>19</sup> <https://github.com/symbiote-h2020/Ontologies/wiki/BIM-Smart-Mobility>

## 7 Standards Developing Organizations

The today's IoT landscape is dominated by a huge number of IoT platforms, competing against each other for the best market shares. The standards developing organisations have started to develop and propose standards to consolidate that situation and to support an open and well defined IoT architecture landscape (see [4]).

The future IoT standards will be important starting points for IoT communities. In order to prevent vendor lock-ins, customers will favour standards to be independent from specific solutions and products. Products will be created to support standards, and applications will be oriented towards standards.

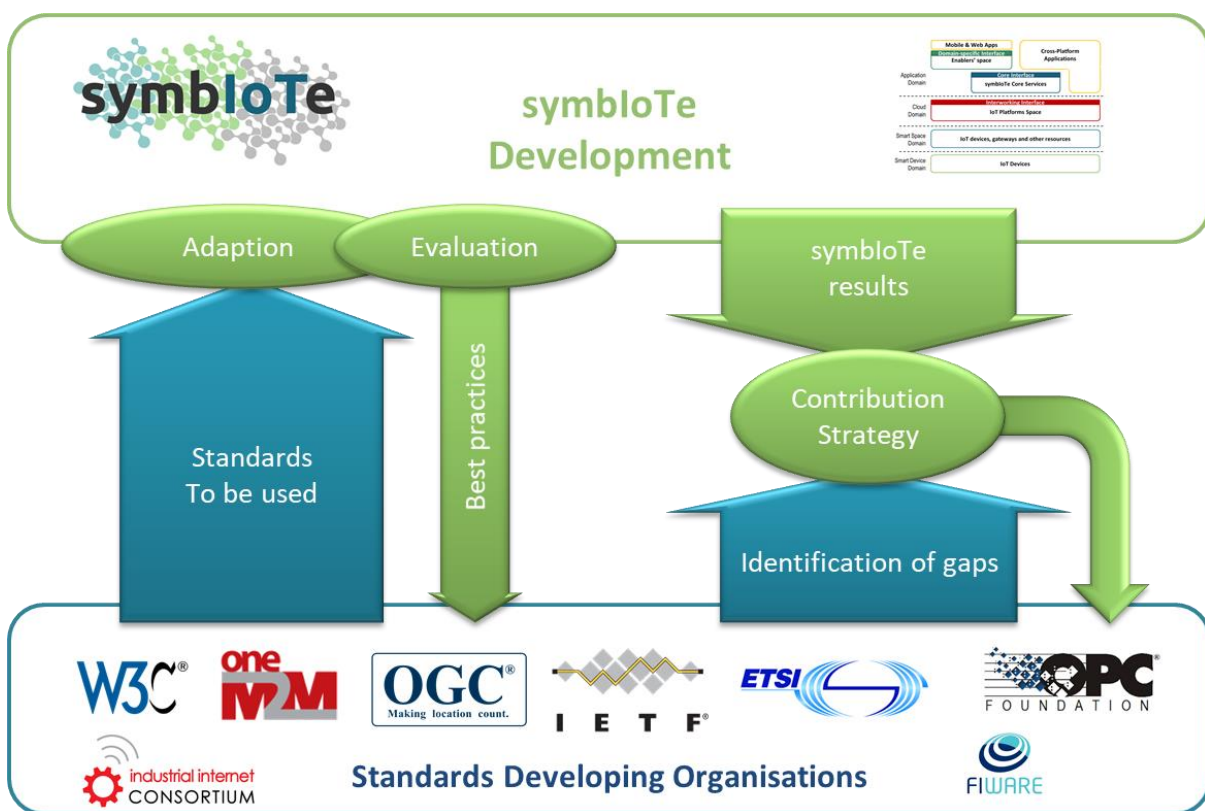

Figure 11: symbloTe Relationship with SDOs

For these reasons it is crucial for any community building strategy, to be well connected to the standard developing organisations, which are forming the future IoT landscapes. This task is done by those symbloTe consortium members, which are already active in such organisations. Their recommendations are reported in D7.8 [5].

## 8 Consortium Perspective on Post-Project Support

In order to get a clear picture on the consortium perspective on the future plans, a questionnaire has been issued among the consortium partners. The intention of this questionnaire was to collect inputs from all partners regarding their plans at the end of the project for the sustainability of the results.

The path for the joint exploitation is designed according to the answers.

### 8.1 General questions

The general questions are asking for the overall willingness to support symbloTe in the future.

	AIT	ATOS	CNIT	FER	ICOM	IOSB	NAVIGO	NXW	S&C	UNIDAT	UNIVIE	UW	VIP
Are you willing to maintain the results of the project when it is over?	Yes*	Yes	Yes*	Yes	Yes	Yes	-	Yes	Yes	-	-	Yes	-
Are you willing to dedicate resources to its maintenance?	Yes*	Yes	Yes	Yes	Yes	Yes	-	Yes	Yes	-	-	Yes	-
Are you willing to dedicate resources to its maintenance?	<i>P,I</i>	<i>P</i>	<i>P</i>	Yes*	<i>P,M</i>	<i>P,I</i>	-	No	<i>I</i>	-	-	No	-
What kind or resources do you want to use?	<i>P,I</i>	<i>F,P,I</i>	<i>P</i>	<i>S,I</i>		<i>P</i>	-	<i>I</i>	<i>S</i>	-	-	<i>S</i>	-

(\*) if financial support can be acquired

(P) Personal resources

(I) Infrastructure resources

(M) financial resources

(S) symbloTe software components

(F) free public domain resources, like GitHub

### 8.2 Actions to be performed

For future support to the community, there are several actions required. The partners have been asked which actions they are willing to perform.

	AIT	ATOS	CNIT	FER	ICOM	IOSB	NAVIG	NXW	S&C	UNIDAT	UNIVIE	UW	VIP
--	-----	------	------	-----	------	------	-------	-----	-----	--------	--------	----	-----

Will you evolve the component?	Yes	yes	Yes*	Yes	Yes	Yes	-	No	Yes	-	-	No	-
Will you be part of the support team?	Yes	Yes	Yes	Yes	Yes	Yes	-	Yes	No	-	-	Yes	-
Being part of a mailing list to answer specific questions		x	X	X	X	X	-	X		-	-	X	-
Write and update documentation		X	X	X	X	X	-	X		-	-	X	-
Develop periodic software updates	X	X		X	X	X	-			-	-		-
Training and seminars	X		X	X	(x)	X	-			-	-	X	-
Attendance to workshops, conferences and events	X	x	X	X	X	X	-		X	-	-	X	-
Update of the dissemination materials (poster, flyer, etc.)		X		X			-			-	-	X	-
Maintenance of the website		X		(x)	X		-			-	-		-
Press releases and any other publication	x	x	X	X	X	X	-		X	-	-	X	-

X = willing to perform this action

(x) = perform action if funding are available

### 8.3 Roles

The consortium partners have been asked, which role/s they assume to play after the end of the project.

	AIT	ATOS	CNIT	FER	ICOM	IOSB	NAVIGO	NXW	S&C	UNIDAT	UNIVIE	UW	VIP
Development team leader				X	X		-			-	-		-
Software developer	X	X		X	X	X	-			-	-	X	-
Leader of training actions				(x)			-			-	-		-
Training actions participant				(x)		X	-			-	-		-
Support team leader				(x)			-			-	-		-
Support team member		X	X	(x)	X	X	-	X		-	-	X	-
Dissemination leader							-			-	-		-
Dissemination participant	X	X	X		X	X	-		X	-	-	X	-
CFO							-			-	-		-
Coordinator					(x)		-			-	-		-
Other							-			-	-		-

X = willing to act in this role

(x) = presumably willing to act in this role

## 8.4 Associated costs

Future support also means costs to be covered. The following questions are addressing different types of costs to be considered.

What costs do you consider affordable?	AIT	ATOS	CNIT	FER	ICOM	IOSB	NAVIGO	NXW	S&C	UNIDAT	UNIVIE	UW	VIP
<i>Maintenance (hosting, domain, etc.)</i>				(x)	X		-			-	-		-
<i>Updates</i>		X			X		-		X	-	-		-
<i>Travelling (assistance to conferences or events)</i>		X		X	X		-			-	-		-
<i>Dissemination material</i>		X		X			-			-	-	X	-
<i>Fees for conferences or publications</i>	X	X	X	X	X	X	-			-	-		-
<i>Personnel costs</i>	X			(x)		X	-		X	-	-		-
<i>Training material</i>							-		X	-	-		-
<i>Licenses</i>					X		-		X	-	-		-
<i>Site maintenance</i>		X			X		-	X	X	-	-	X	-
<i>Others</i>							-			-	-		-

X = willing to cover these costs

(x) = willing to cover these costs if funding is available

## 8.5 Conclusion on Consortium Perspectives

From the answers given by the consortium partners, it is obvious that there is a broad interest in keeping up the contributions and providing support for the software as well as for the services. This of course depends on future financial opportunities.

In the survey the partners pointed out, that a clear position on IPR-, governance- and update-management is required. Also, the organization of the future decision-making process, like a steering board or the procedure on adding new partners, need to be defined. From that point, the project management has taken the initiative to formulate a proposal for a symbloTe Alliance.



## 9 Outlook

After the funding period there will be no legally binding project board and a regulation for a community based on good will, common intentions and contributions is needed. This philosophy is called 'Meritocracy'<sup>20</sup>, and is often used as a guideline for open source communities.

A continuation of something like our current project management board will be needed to maintain a common architectural vision, as well as a consistent and stable software baseline. The main difference will be that our current management board was restricted to our consortium while the follow-on will need to be open. A proposal is that the current symbloTe consortium members will become "committers". Initially in the Post-symbiote phase, each consortium member will start as a committer and later on, external contributors who have the trust of the project committers, can be elected or promoted by the committers, to become committers. There should also be project leaders. Similar to a committer election, a project lead election starts with a statement of merit. Rather than focusing on specific code contributions, the merit statement should instead focus on the leadership qualities expressed by the individual.

A proposal for a symbloTe Alliance has been formulated by the project coordinator and the consortium members are requested to state their plans for participation. Details on the alliance plan are reported in [3].

---

<sup>20</sup> <https://en.wikipedia.org/wiki/Meritocracy>

## 10References

- [1] Eclipse IoT Working Group: “The Tree Software Stacks Required for IoT Architectures”, September 2019; <https://iot.eclipse.org/white-paper-iot-architectures>
- [2] D6.4 - Report on Open Call and Contest Impact
- [3] D7.7 - Final Dissemination and Exploitation Plans
- [4] D7.3 - Initial Report on Standardization Analysis and Recommendations
- [5] D7.8 - Final Report on Standardization Analysis and Recommendations
- [6] Open Mobile Alliance, NGSI Context Management specification v1.0, 2012; [http://openmobilealliance.org/release/NGSI/V1\\_0-20120529-A/OMA-TS-NGSI\\_Context\\_Management-V1\\_0-20120529-A.pdf](http://openmobilealliance.org/release/NGSI/V1_0-20120529-A/OMA-TS-NGSI_Context_Management-V1_0-20120529-A.pdf)
- [7] M. Jacoby, A. Antonic, K. Kreiner, R. Lapacz and J. Pielorz, "Semantic Interoperability as Key to IoT Platform Federation," Interoperability and Open-Source Solutions for the Internet of Things, Forthcoming 2017.
- [8] D2.1 - Semantics for IoT and Cloud resources
- [9] D2.4 - Revised Semantics for IoT and Cloud resources
- [10] IoT EPI, “Advancing IoT Platforms Interoperability”, June 2018; [https://www.riverpublishers.com/pdf/ebook/RP\\_E9788770220057.pdf](https://www.riverpublishers.com/pdf/ebook/RP_E9788770220057.pdf)
- [11] Ben Balter, <http://ben.balter.com/2015/03/08/open-source-best-practices-internal-collaboration/>

## 11 Abbreviations

API	Application Programming Interface
BIM	Best Practice Information Model
CIM	Core Information Model
CoAP	Constrained Application Protocol
EPI	European Platforms Initiative
ETSI	European Telecommunications Standards Institute
ICT	Information and Communications Technology
IoT	Internet of Things
IoT-EPI	IoT European Platforms Initiative
NGSI	Next Generation Services Interface
OC	Open Call
OC1/2	Open Call 1/2
OGC	Open Geospatial Consortium
OSS	Open Source Software
SDO	Standards Developing Organizations
W3C	World Wide Web Consortium