

XXXVII.—*On the Theory of Isomeric Compounds.*

By Dr. A. CRUM BROWN.

IN the following remarks I intend to confine myself to the consideration of those compounds which have not only the same composition per cent., and the same molecular weight, but also the same constitutional formula. Such compounds may be termed absolutely isomeric. As the constitutional formula of few substances is fully known, this class is of course a small one, or rather there are few substances of which we can certainly say that they belong to this class.

The following are the principal pairs of substances which are or have been supposed to be absolutely isomeric. I shall first enumerate them, and then proceed to discuss the nature of their isomerism.

1. The hydrides of the alcohol-radicals, and the so-called alcohol-radicals, as hydride of ethyl and methyl gas; hydride of propyl and methyl-ethyl.

2. Chloride of ethyl and the product of the action of chlorine on hydride of ethyl. Also the chlorides of other alcohol-radicals and the mono-chlorinated derivatives from the corresponding hydrides.

3. Chloride of vinyl and chloracetene.

4. Fumaric and maleic acids.

5. Two of the three acids citraconic, itaconic, and mesaconic.

6. Bromo-maleic and isobromo-maleic acids.
7. Bibromo-succinic and isobibromo-succinic acids.
8. Active and inactive malic acid.
9. Active and inactive aspartic acid.
10. Two of the varieties of tartaric acid.
11. The two series of bodies known as the compounds of ethylene and of ethylidene.
12. Lactic and paralactic acids.
13. The two series of alcohols derived, the one by fermentation from sugar, and the other by the addition of water to the olefines, as Berthelot's and Friedel's propylic alcohol, Wurtz's hydrate of amylene, Erlenmeyer and Wanklyn's  $\beta$  hexylic alcohol.

To the same class belong of course the ethers derived from these alcohols.

14. The isomeric acids and alcohols having the general formula  $C_nH_{2(n-3)}O$ , as kressylic acid, and benzoic alcohol.

I now proceed to inquire whether these pairs of substances are absolutely isomeric or not.

In order to do so, we must determine whether they are really different, whether they are not perhaps identical; and secondly, whether they are or are not metameric; in other words, whether the theory of atomicity is insufficient alone to explain their difference.

1. Are there two isomeric series having the common formula  $C_nH_{2(n+1)}$ ? Or are these bodies identical? Till lately, most chemists would have replied unhesitatingly that these substances were different. According to the observations of Frankland, hydride of ethyl and methyl gas, otherwise so like one another, show a very different reaction when treated with chlorine in diffused day-light. Were this observation confirmed, it would be quite sufficient to prove that the two bodies were not identical. Several chemists (Carius, Schorlemmer) have, however, lately expressed doubts as to the correctness of Frankland's observation, and it would certainly be satisfactory that it should be repeated with special precautions.

That these bodies are not metameric, that is, that the theory of atomicity is incapable of explaining the difference between them (assuming, as we may do, till Frankland's observation be found incorrect, that there is a difference), is evident. For there is on that theory only one possible constitutional formula for a substance

having the composition and molecular weight expressed by the empirical formula  $C_2H_6$ , viz. :—

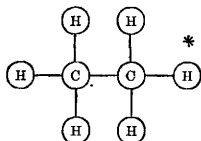

The same reasoning is sufficient to show that the other pairs in this series, as methyl-ethyl and hydride of propyl, ethyl and hydride of butyl, &c., are not metameric. The question of the *identity* of these bodies must, however, be still regarded as an open one.

2. There can be little doubt that chloride of ethyl and the substance produced by the reaction of chlorine on hydride of ethyl are essentially different. The former boils at  $+11^\circ C.$ , the latter is a gas not condensable by a cold of  $-18^\circ C.$  There is also a great difference between them as to solubility in water. They cannot be metameric, as there are not two possible constitutional formulæ for  $C_2H_5Cl$ . They are therefore absolutely isomeric. The same argument does not hold in the case of any of the homologues of chloride of ethyl except chloride of methyl. For there may be two formulæ for the molecule  $C_3H_7Cl$ , two for  $C_4H_9Cl$ ,

\* I may here shortly explain the graphic notation which I employ to express constitutional formulæ, and by which, it is scarcely necessary to remark, I do not mean to indicate the physical, but merely the chemical position of the atoms. An atom is represented by its usual symbol, surrounded by a circle with as many lines proceeding from it as the atom contains equivalents, thus an uniequivalent atom is represented by  $(A)$ —, a bivalent atom by  $-(B)-$  or  $(B)-$ , and so on of the others. When equivalents mutually saturate one another, the two lines representing the equivalents are made continuations of one another, thus water is  $(H)-(O)-(H)$ . Formic acid

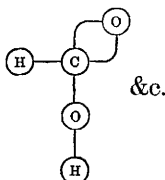

This method seems to me to present advantages over the methods used by Professors Kekulé and Erlenmeyer; and while it is no doubt liable, when not explained, to be mistaken for a representation of the physical position of the atoms, this misunderstanding can easily be prevented.

three for  $C_5H_{11}Cl$ , &c., without varying the mode of arrangement of the carbon atoms *inter se*.

3. Chloride of vinyl and chloracetene are undoubtedly different. They resemble one another in nothing but composition and molecular weight. If we exclude the possibility of the existence of diatomic carbon\* in such a molecule, there is only one constitutional formula to represent them both,

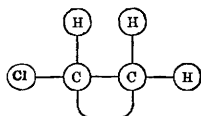

4. The constitutional formula of succinic acid is

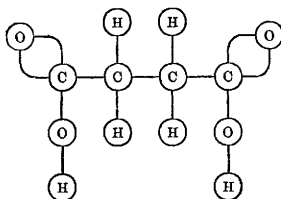

Maleic and fumaric acids, each form succinic acid by the addition of two atoms of hydrogen. And as both are dibasic, these two atoms of hydrogen cannot be contained in either of the groups HO in succinic acid. They must, therefore, be two of the hydrogen atoms directly combined with carbon. Now, there are two conceivable constitutional formulæ by which they could be represented—

\* I do not intend to deny the possibility of this, but all we know of such "non-saturated" substances leads to the belief that the atomicity of the carbon radical  $C_n$  is reduced, not by one or more of the carbon atoms becoming diatomic, but by the union of the carbon atoms taking place in the way represented by the following graphic formulæ :

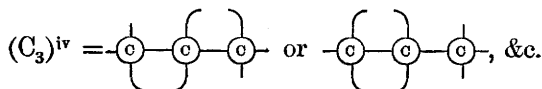
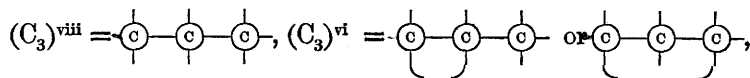

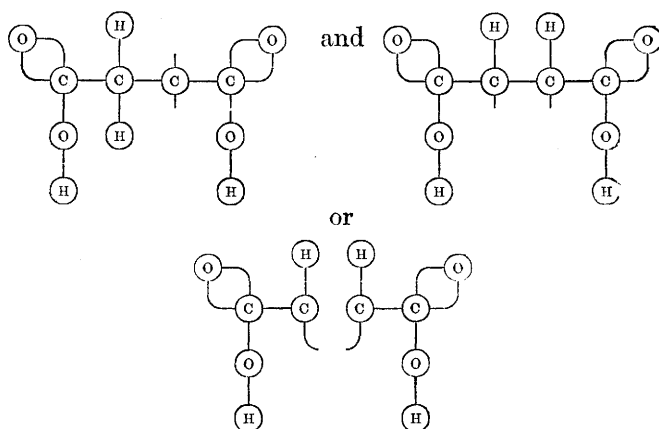

Of these the latter only is admissible, for the theory of atomicity taken strictly does not admit of free affinities in a molecule. This formula then must be common to the two acids.

5. In the abstract of this paper, published in the Society's "Proceedings," the dehydrogenates and the bibromo derivatives of pyrotartaric acid were inadvertently included in the list of bodies probably absolutely isomeric. From the relation of pyrotartaric acid to propylene, and of the latter substance to Friedel's alcohol, we may deduce the following formula for pyrotartaric acid :—

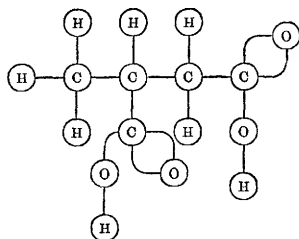

If this formula be correct, it is obvious that there *may* be three metameric dehydrogenates and bibromo derivatives.

6. As the two atoms of hydrogen in the radical of maleic acid are, on the theory of atomicity, in precisely similar positions, it is obvious that there cannot be two metameric bromo-maleic acids. And as Kekulé has shown that there are two acids, bromo-maleic and isobromo-maleic, these must be absolutely isomeric.

7. Two perfectly admissible formulæ can be constructed to represent bibromo-succinic acid :—

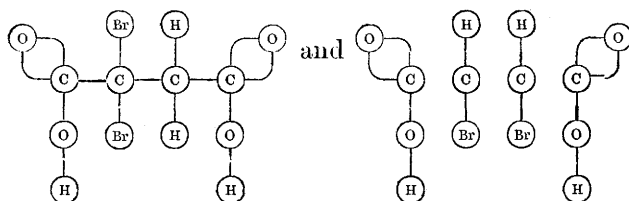

But that these formulæ do not correspond to bibromo-succinic and isobibromo-succinic acids is plain from the following considerations. These acids are formed by the direct addition of bromine to maleic and fumaric acids. The bromine must, therefore, be combined with the two carbon equivalents, which in maleic and fumaric acids are combined together, so that the latter of the two formulæ given above must be that of both brominated acids.

8. As the constitutional formula for succinic acid shows no difference as to "chemical position" among the four atoms of hydrogen in the radical, there can be only one formula for the substance produced, by replacing one of these atoms by the water residue; but we have two varieties of malic acid, active and inactive; these must therefore be absolutely isomeric.

9. The same argument applies to the case of active and inactive aspartic acids; aspartic acid being succinic acid in which one atom of radical hydrogen has been replaced by the ammonia residue  $\text{NH}_2$ .

10. As there are two possible formulæ for bibromo-succinic acid, there are also two for tartaric, or dioxy-succinic acid. We have not the same reason for excluding either of these in this case as in that of the bibrominated acids;\* but as we have three undoubtedly different varieties of tartaric acid (excluding racemic acid), two of these at least must have one of these formulæ in common.

So far we have been concerned with pairs of substances which seem to be really absolutely isomeric. The remaining substances in our list are more probably metameric.

11. If we consider the various reactions of the ethylene compounds, particularly the formation of glycollic acid from glycol, we are forced to the conclusion that the two unsaturated equivalents of the radical ethylene belong to two different carbon atoms. This conclusion may also be arrived at in another less satisfactory way.

\* It would be interesting to compare the properties of the tartaric acid formed from isobibromo-succinic acid with that from bibromo-succinic, and with the varieties obtained from the grape.

As chloride of ethylene is formed by the direct union of chlorine and ethylene, the chlorine must be combined with those carbon equivalents which in ethylene gas are combined with one another; but equivalents of the same atom cannot be combined with one another, therefore in chloride of ethylene the two atoms of chlorine must be combined with different carbon-atoms. The constitutional formula of chloride of ethylene is therefore—

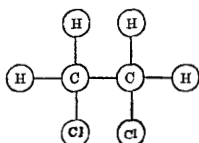

and that of oxide of ethylene

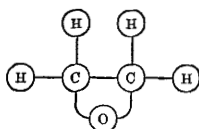

Again, the reactions of aldehyde, the oxide of ethylidene, lead to the view of its constitution first proposed by Kolbe, and now almost universally adopted,  $\left. \begin{array}{l} \text{CH}_3 \\ \text{H} \end{array} \right\} \text{CO}$ , in which both oxygen equivalents are combined with the *same* carbon atom. The constitutional formula of chloride of ethylidene is therefore

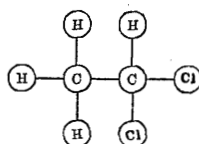

and that of aldehyde

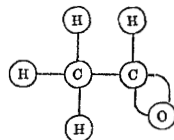

These two series of substances are therefore metameric.

12. The researches of Wislicenus (Ann. Ch. Pharm. cxxviii. 1), and Lipmann (Ann. Ch. Pharm. cxxix. 81), prove that lactic acid and paralactic acid stand to one another in a relation similar

to that of chloride of ethylidene and chloride of ethylene; that, in fact, the former is a compound of ethylidene, with the water-residue and the group  $\left( \text{H}'\text{O} \right) \text{C}''\text{O}$  and the latter of ethylene with the same radicals. They have therefore the following constitutional formula and are metameric :—

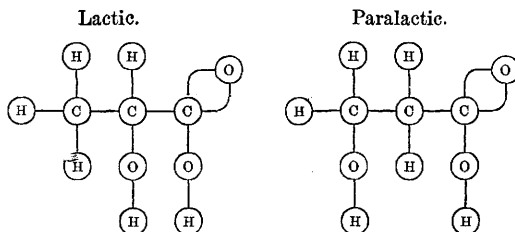

13. With regard to the two series of alcohols—the alcohols proper and the hydrates of the olefines—we know, at least, that Friedel's alcohol is not absolutely isomeric with propylic alcohol, but, as suggested by Kolbe, only metameric. If we consider the relation of these alcohols to their aldehydes—propionic aldehyde, and acetone, the aldehyde of Friedel's alcohol—we easily see that the formula of propylic alcohol is

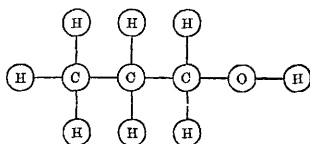

while that of Friedel's alcohol is

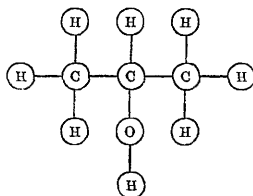

As Friedel's alcohol is identical with that obtained by Berthelot from propylene, it is highly probable that the same difference exists in the case of all the other members of the two series. In the same way the iodide of propyl is—



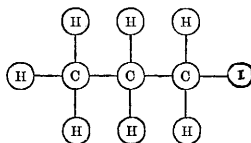

and the hydriodate of propylene

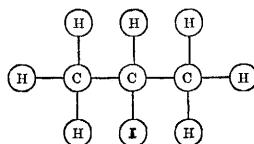

14. As to the aromatic alcohols and the isomeric acids, we know too little of their constitution to speak definitely with regard to their relation. They may, as suggested by Erlenmeyer (*Zeitschrift*, vii. 12), be absolutely isomeric, or, on the other hand, they may be related to one another as the two series of alcohols last mentioned are.

Having enumerated the bodies which may without hesitation be called absolutely isomeric, I shall now consider the bearing which the existence of such substances has upon the theory of atomicity.

If we examine the fundamental definitions of that theory, we shall see that there is a point of importance left undecided. We define a multivalent atom as an atom having two or more equivalents, by means of which it may unite with the equivalents of other atoms, but it is not decided whether these equivalents are similar to one another or not. On the former supposition, there can be only one substance corresponding to each constitutional formula, and absolutely isomeric compounds are impossible. It must, therefore, be rejected, as such compounds exist. We must then assume that some of the equivalents of at least some multivalent atoms are different from other equivalents of the same atoms.

This assumption may take one of two forms—1. We may suppose that the difference is an essential and unchangeable one; that, for instance, the two equivalents of a diatomic atom differ from one another as chlorine does from bromine; and that the one can no more be changed into the other, than an atom of chlorine can be changed into an atom of bromine; or, 2. We may suppose that such a change is possible.

Our knowledge of facts is not as yet sufficiently extensive to enable us to decide definitely between these two hypotheses, but it may be of some use to examine their consequences.

The second is, as yet, obviously too vague and indefinite to admit of this, I shall therefore confine my remarks to the first. The principal advocate of this hypothesis is Professor Erlenmeyer of Heidelberg. Professor Butlerow, of Kasan, has also published some speculations in the same direction; and in his paper on Organic Acids in the supplementary volumes of Liebig's "Annalen," Professor Kekulé, of Ghent, treats shortly on the same subject. The only attempts, however, to apply this hypothesis in a definite way to the explanation of particular cases of absolute isomerism are, as far as I am aware, 1. That of Professor Kolbe, who applies a form of this hypothesis to the case of the isomerism of oxide of ethylene and aldehyde. I have already given my reasons for believing that these substances are metameric, and shall therefore not discuss the point further here. 2. That of Butlerow (*Zeitschrift*, v. 301), who endeavours by means of it to explain the isomerism of hydride of ethyl and methyl gas; and 3. That of Kekulé (*Ann. Ch. Pharm.*, Suppl. ii. 111), in his explanation of the isomerism of maleic and fumaric acids, and of citraconic, itaconic, and mesaconic acids.\*

I shall examine the 2nd and 3rd of these examples in detail, and think I shall be able to show a certain degree of inconsequence in both. Professor Butlerow argues, that in methyl gas the two atoms of carbon are combined by two affinities of the same kind (secondary affinities), each being the affinity which in iodide of methyl is combined with iodine. In hydride of ethyl, the two carbon atoms are combined in the same way as in the other members of the ethylic series, therefore, probably in the same way as in the members of the acetic series, one of which is acetonitrile, which is cyanide of methyl; the one is, therefore, the free affinity of methyl (secondary), the other the free affinity of cyanogen. These must be different, because hydride of ethyl is not identical with methyl gas. Butlerow indicates this, by calling the free affinity of cyanogen primary. We have thus in methyl gas two secondary affinities united together, and in hydride of ethyl a primary united to a secondary.

\* I do not here notice the remarks of Professor Kolbe (*Zeitschrift*, vi. 13) on the same subject, as his object is rather to prove the metamerism than to explain the isomerism of these bodies.

In this reasoning we have three assumptions—1. That the nature of the carbon affinities is unchangeable; 2. That the carbon atoms continue united together by the same affinities through a series of chemical reactions, such as the transition from acetonitrile to hydride of ethyl; and, 3. That hydride of ethyl is not identical with methyl gas.

By carrying this argument a little further, and making use of no additional assumption, we arrive at an absurdity;—thus, the carbon-radical of the acetic series is the same as that of oxyacetic (glycollic) acid, that again is the same as that of oxalic acid, therefore as that of oxalic nitrile or cyanogen gas; but in cyanogen gas we have the two carbon atoms united by two *primary* affinities; but we have before proved, that in the acetic series they are united by a *primary* affinity of the one, and a *secondary* affinity of the other. It is obvious, then, that at least one of our assumptions is false. And when we closely examine the two general assumptions (1. and 2.), we shall see reason to believe, that neither of them is rigidly true.

It is well known that the replacement of one equivalent in a compound by another, while it leaves the “chemical structure,” or “chemical position” of the other atoms unchanged, exerts an influence on the *intensity* of the chemical attraction, not only of the equivalents directly concerned in the replacement, but of all the equivalents in the molecule.\* To see this we have only to compare the nature of the force uniting H to O in acetic acid, and in glycoll, and in glycoll,

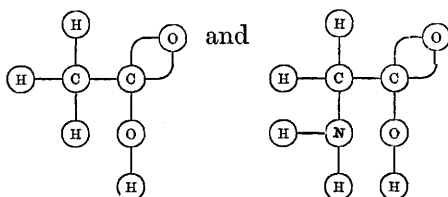

We here see the hydrogen and the ammonia residue  $\text{NH}_2$  exerting a “disturbing” influence on the relation of oxygen to hydrogen through two carbon-atoms. Many other examples will at once

\* Butlerow notices this disturbing influence (*Zeitschrift*, vi. 516) as opposing an obstacle, which he seems to regard as for the present insuperable, in the way of determining whether a difference exists or not among the equivalents of a multi-valent atom.

occur to every chemist. The nature of the equivalents, that is, of the force they exert, is thus seen to be variable; but the facts of absolute isomerism force us to admit, that this variation in the character and intensity of the chemical force exerted by the different equivalents of one atom depends upon something else, as well as upon the nature of the other equivalents with which that atom is united.

We find, then, that although the nature of one equivalent of an atom does change, as the other equivalents are united with different substances, there must be some original difference between them, which renders absolute isomerism possible. In what this original difference consists, whether it is essential or merely accidental (using the word in its strictly logical sense), we cannot as yet say.

We may thus divide the force uniting any two equivalents, into two components, one depending on the structure of the molecule, and the position of the equivalents in question in it, and the other independent of these. For convenience we may call the first the molecular, and the second the atomic component.\*

From all that we know of the disturbing effect of an equivalent on the relations of the other equivalents in the molecule, we may safely assume that the *molecular* component of the force uniting the two carbon-atoms to form the hexatomic carbon radical  $(C_2)^{vi}$ , is not the same in any two compounds. And if there be more than one body having the formula  $C_2H_6$ , we are forced to the conclusion, that in these cases at least, the atomic component is different also.

The question in reference to the second assumption mentioned above may now be stated thus—Does the atomic component of the force uniting the two carbon atoms remain the same through such a series of transformations as that connecting acetonitrile and hydride of ethyl? There is every reason to suppose that it does, if it is always the same for the same pair of equivalents; for there is nothing in any of these transformations which would lead us to suppose that one carbon equivalent has changed places with another. We are then brought to the dilemma, either methyl

\* The term component is, of course, not used here in its strictly dynamical sense, what is meant is, that the total force uniting a pair of equivalents, is a function of two quantities, the one depending on the structure of the molecule, and the position in it of the two equivalents, and the other on the chemical nature of the two equivalents.

gas and hydride of ethyl are identical, or a change takes place in the atomic component of the force uniting the two carbon-atoms in some of the transformations connecting cyanogen gas and hydride of ethyl.

In connection with this, it may be proper to examine shortly the relations between the view of the chemical nature of carbon provisionally adopted by Butlerow, in the paper referred to above, and that of Kolbe, as explained in his "Lehrbuch der Organischen Chemie," and in several valuable papers in Liebig's "Annalen," and in Erlenmeyer's "Zeitschrift."

Professor Kolbe considers carbon (carbonyl =  $(C_2)$ ,  $C = 6$ ) as a tetratomic element (as indeed it is now admitted by every one to be), and holds that in a large number of organic compounds, the four equivalents united to the carbonyl atom may be divided into two groups—the intra-radical and the extra-radical—so far his view resembles that of Butlerow; but it differs from it in the following respects:—Butlerow assumes that it is an essential property of the carbon atom to combine in this way, that carbon *always* combines with two equivalents in one way, and with two others in another way. Kolbe only admits this in the case of bodies derived from dibasic carbonic acid. In methylic compounds, for instance, he regards the three atoms of hydrogen as precisely similar. When we examine the theories more closely, we see another reason to doubt their identity. If we try to compare them, we find it difficult to decide whether Butlerow's primary affinities correspond to the intra-radical or extra-radical

affinities\* of Kolbe; for instance, in formic acid,—C  $\begin{cases} H \\ O'' \\ OH \end{cases}$  or  $C_2 \begin{cases} O_2 \\ H \\ O \cdot H O \end{cases}$ , the H and the OH (or  $O \cdot H O$ ) are united to the extra-

radical affinities; but by carrying out Butlerow's reasoning, we are led to the conclusion, that the H is united to a primary, and the OH to a secondary affinity, unless we suppose that the free affinity of methyl is different from that of formyl.

It is not impossible that such a difference may exist, but till this point is settled, and till we know whether the two free affinities of  $(CO)''$  are similar or not, it is impossible satisfactorily to compare the two theories.

\* I use the terms intra- and extra- radical affinities, as abbreviations for the carbon affinities with which the intra- and extra- radical oxygen atoms are combined.

The other attempt mentioned above to explain cases of absolute isomerism, in harmony with the theory of atomicity, is that of Professor Kekulé.\* After shortly recounting the principal facts, more minutely described in his admirable researches on organic acids, he says—"All these facts find, in my opinion, to a certain extent, their explanation in the following considerations:—According to the views on the atomicity of the elements which I communicated some time since, succinic acid and its homologue pyrotartaric acid may be regarded as closed molecules, that is, all the affinities of the atoms composing the molecule are saturated by other atoms. Both acids contain two atoms of hydrogen replaceable by radicals, because two atoms of hydrogen are united to the carbon group by means of oxygen. These two replaceable (typical) atoms of hydrogen may be easily exchanged for metals, because, besides the two atoms of typical oxygen (*i.e.*, oxygen united by only one affinity to carbon), there are other two atoms of oxygen united to carbon by both affinities, which, therefore, in the language of the typical theory, belong to the radical. If these two atoms of hydrogen are represented apart from the rest, as is done by means of the typical formulæ—



or still more clearly by the graphic representations which I have made use of more than once in another place,† it will be readily seen that in succinic acid there are four, and in pyrotartaric acid six, other atoms of hydrogen present. This hydrogen is con-

\* *Loc. cit.*

† In order to elucidate this passage as much as possible, I append the graphic representations referred to:—

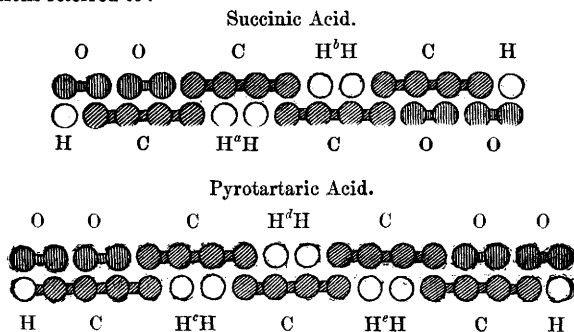

sidered, according to the typical theory, to belong to the radical, according to the theory of atomicity, to be directly united to the carbon, and in such a way that there are always two atoms of hydrogen united to the same carbon atom. If we now suppose that in the one or the other of these two normal acids two such hydrogen atoms are wanting, we have, on the one hand, the composition of fumaric and maleic acids, on the other, the formula of citraconic itaconic, and mesaconic acids. Now, as there are in succinic acid *two* pairs of hydrogen united in this way to carbon, we easily see the possibility of the existence of two dehydrogenated acids, as the one or the other of these pairs of hydrogen atoms is absent.

"Similarly, in the case of pyrotartaric acid, the existence of three isomeric dehydrogenated acids is intelligible, in each of which another of the three pairs of hydrogen atoms directly united to carbon is absent. At that place in the molecule where the two hydrogen atoms are wanting, there are two carbon affinities unsaturated, there is at that place, so to speak, a blank."\*

There is some difficulty in understanding this last statement. For what can be meant by two affinities of the same carbon atom uniting together? unless the definition of either "atoms" or "combination" be completely changed. Or if we take the natural meaning of the sentence last quoted, and suppose two carbon-atoms pushed together, so that two affinities of each previously united to hydrogen come to be united together, the two wanting hydrogen atoms do not come from the same, but from two different carbon-atoms.†

But leaving this preliminary difficulty out of consideration, and also granting the existence in such a molecule of diatomic carbon, a glance at the diagrams is sufficient to show that this view does not give us two but only one formula for fumaric and maleic acids, unless a difference be admitted among the affinities of carbon. The pairs of hydrogen-atoms, which I have marked *a* and *b*, have perfectly similar positions, the one being related to one end of the diagram, exactly as the other is to the other end. In the same way the graphic representation of pyrotartaric acid suggests only two formulæ for citraconic, itaconic, and mesaconic

\* "It may of course equally well be assumed, that the carbon-atoms are, as it were, pushed together (*zusammengeschoben*), so that two carbon atoms are united by two affinities of each. This is only another form of the same idea."

† See Erlenmeyer, *Zeitschrift*, vi. 21.

acids, there being no apparent difference between the position of the pairs *c* and *e*.\* This explanation is insufficient, not to say unintelligible, unless we suppose a functional difference between the two carbon-atoms, with which the pairs of atoms of hydrogen are united; and if we make this assumption, it follows as a necessary consequence that there is a difference between the two groups of HO. It is no doubt possible that such a difference may exist; but it seems very unlikely that such a property of a substance so well known as succinic acid should not have been observed.

We thus see, that the attempts to apply to the explanation of particular cases the principle of a difference between the equivalents of multivalent atoms have failed, not, however, as far as can at present be seen, from any absurdity in the principle itself, but rather from a want of well-observed facts to guide us in its application. These we may expect before long, from the labours of Buttlorow, Schorlemmer, and others, and we shall then be in a position to form a definite opinion as to the form which this hypothesis should assume.

---