

THE MOVEMENTS AND INNERVATION OF THE
SMALL INTESTINE. BY W. M. BAYLISS AND E. H.
STARLING. (Thirty Figures in Text.)

(Physiological Laboratory, Guy's Hospital.)

ON no subject in physiology do we meet with so many discrepancies of fact and opinion as in that of the physiology of the intestinal movements. Among factors contributing to such divergences must doubtless be included the varying behaviour of the gut in different animals, the varying conditions of the animal with regard to feeding or conditions of experiment, such as exposure and cooling of the intestines. One of the most important, however, as we shall show in the following pages, is the fact that the muscular coat of the intestines is subject to inhibitory and augmentor impulses dependent, in the first place, on the condition of neighbouring parts of the gut, through the intermediation of the local nervous system (Auerbach's and Meissner's plexus), and secondly, on impulses ascending to the central nervous system from the intestine, abdominal wall, or other parts of the body, and affecting the intestines reflexly. The motor mechanism of the intestinal wall is moreover extremely sensitive to changes in the blood-flow through the vessels of the gut, or to the presence of drugs or other chemical substances in the blood or within the gut itself.

Our investigations have been wholly confined to the small intestine of the dog. Although in many cases we have been able to explain the results obtained by previous observers by reference to one or other of the disturbing conditions mentioned above, we must confess that in some instances we have been absolutely unable to reproduce effects described by physiologists of repute, however we might vary our method of experiment; and we have had to come to the unsatisfactory conclusion that these results were due to fallacy of observation or experimental methods.

Methods of Experiment. The great majority of the researches on the subject of the intestinal movements have been made by mere

inspection of the exposed intestines, although graphic methods have been employed by Openchowski, Mislowski, Bunch, Courtade and Guyon and other French authors. Although many of the observations recorded in the following pages might have been obtained from a mere inspection of the exposed intestines, a fuller analysis of the factors involved in their causation would have been impossible without recourse to the graphic method; and there is no doubt that some of the discrepancies on record have been due to the neglect of such methods.

Contraction of the circular coat of the intestine will diminish the lumen, and in certain conditions of the gut may increase it in length. Contraction of the longitudinal coat will shorten the gut and might theoretically cause a slight increase in its transverse diameter. This increase is however negligible. The most convenient way of recording the contractions of the circular coat is to introduce into the lumen a capsule of fine rubber, which is tied on to the end of a small metallic tube about 5 inches in length. This may be inserted either through the cut end of a loop of intestine, which is then ligatured tightly round the tube, or better through a small longitudinal incision in the unattached margin of the intestine. After the insertion of the tube the incision is closed by two stitches of fine thread, one of which is taken round the tube. The capsule is distended with air under a pressure of about 10 cm. of water, the capsule being connected through a small water manometer to a piston recorder which records the movements of the water-column and so the contractions of the circular coat at the level of the capsule. In many cases it is useful to be able to register the contractions of the muscular wall without the introduction of any foreign material into the gut. For this purpose we made use of an instrument which we may call an enterograph, by means of which one may record the contractions of either the longitudinal or circular coat, or of both coats simultaneously. The construction of the enterograph will be evident from the diagram. (Fig. 1.)

The following general precautions were observed in all the experiments. The day before the experiment the dog received no solid food, and in all the later experiments was given a small dose of castor oil in order to clear out any faecal masses. On the day of the experiment the animal received an injection of 5—20 centigrams morphia, and A.C.E. mixture was administered continuously throughout the preliminary operative measures, and when necessary during the sub-

sequent observations. The effect of morphia on the intestinal movements is so slight that it is better to give a larger dose of morphia

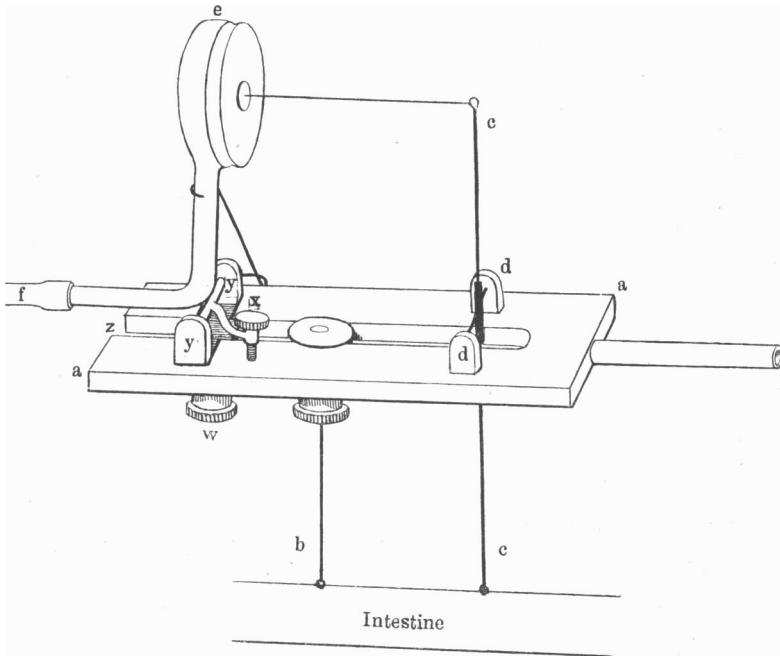

Fig. 1. In a brass plate *aa*, two steel needles *b* and *c* are fixed in a slot. *b* is fixed, but can be shifted nearer to or further from *c* by loosening its fixing screw. *c* is prolonged through the slot and revolves round the axis *dd*. The upper end of *c* is fastened by a thread to the disk on the rubber of the tambour *e*, which communicates by a tube *f* with a piston recorder. The lower ends of *b* and *c* are pierced with holes. Through these holes pass fine threads, which are carried by a needle through the outer layers of the intestinal wall and fastened. The muscle fibres running from *b* to *c* can only contract by pulling *c* towards *b*. This causes a movement of the upper end of *c* in the opposite direction, and a consequent pull on the membrane of the tambour, which is registered by the piston recorder. The distance of *e* from *c*, and the tension on the muscle-fibres between *b* and *c*, can be regulated by means of the screw *x*, or roughly by moving the tambour in the slot *z*.

than to trust for the maintenance of complete anæsthesia to the continued administration of the A.C.E. mixture; since this latter affects seriously the blood-pressure and probably indirectly the intestinal movements. In a few experiments the abdominal wall was sewn up after the introduction of the capsule. We found it much better however to immerse the whole animal with the exception of the head in a bath of warm normal saline solution, as was done by van Braam

Houckgeest, and to allow the coils of intestine under observation to lie outside the abdominal cavity.

MOVEMENTS OF THE ENERVATED INTESTINE.

In discussing the physiology of the intestinal movements, it will be simpler to consider in the first place the behaviour of the gut, which has been freed from all nervous connexions with the central nervous system. This may be effected in various ways. In two experiments we divided both vagus nerves, cut through the cord just below the medulla, and then excised the spinal cord from the seventh cervical to about the fourth lumbar nerve. In two other experiments we excised the whole of the ganglionic mass surrounding the cœliac axis and the superior mesenteric artery, clearing these vessels of all nerve-filaments; divided the mesentery; extirpated the abdominal sympathetic chain on each side, and cut both splanchnics and both vagi. Although these experiments are the only ones in which one can be absolutely certain of having destroyed all nervous connexions between intestine and central nervous system, we find that the results obtained differ very slightly if at all from those obtained after simple section of both splanchnic nerves alone or of both splanchnics and both vagi.

On opening the abdomen in the warm saline bath, it will be seen that the intestines are in a state of active movement. Two kinds of movement may generally be distinguished. The first of these are the so-called pendulum movements ("Pendelbewegungen"), all the coils being affected by a gentle swaying motion, which has been generally ascribed to contractions of a longitudinal coat. On close observation these swaying movements are seen to be accompanied by very slight waves of constriction, which pass rapidly down the intestine. These waves may apparently originate at any part of the gut, but so far as we have been able to ascertain, pass almost exclusively from above downwards¹. The small extent of the movement and the varying origin of the waves make it difficult to estimate accurately their rate of transmission, which apparently varies from 2 to 5 cm. per second. Besides these slight contractions, one will generally notice portions of the gut which are the seat of a strong contraction of the circular coat. This contraction obliterates the lumen both of the gut and of the

¹ Now and then one of these rapid waves appears to travel upwards for a short distance, but such an ascending wave can rarely be traced over more than 2 or 3 inches, and rapidly gives way to descending waves.

blood vessels, so that the affected portion becomes blanched. This ring of constriction travels slowly down the gut, and corresponds exactly to the accepted idea of a peristaltic contraction. The rate of propagation of the wave decreases as the contraction increases in force, and may take as much as 10 seconds to traverse 1 cm. On close observation, it will be seen that this wave is preceded by a wave of inhibition, the portion of the gut immediately below the constricted area being relaxed and motionless. In some cases, two or three waves of constriction may be seen immediately following one another, each wave being separated from the adjoining one by a small length of reddened relaxed gut. In no case do these waves move upwards; that is to say, there is no antiperistalsis. They may traverse the whole length of the small intestine, and be transmitted to the colon, or they may gradually diminish in force and die out in their course. If absent, they may be easily excited by electrical or better mechanical stimulation of any portion of the intestine. In order to study the causation of these movements we must employ graphic methods, and we may deal with each kind of movement separately.

I. *Pendulum Movements of the Intestine.*

On inserting the rubber capsule already described into the gut, and connecting it with a piston recorder, it will be seen that the intestinal wall is the seat of continuous rhythmic contractions, which cause a diminution of the lumen and are synchronous with the pendulum movements as observed by the eye. Each contraction and relaxation lasts from 5 to 6 seconds, so that they are repeated at the rate of 10 or 12 per minute. In many cases the intestine beats with the regularity of the heart; in others the contractions are more or less irregular, varying in size or ceasing altogether for one or two beats. The contractions can be seen to sweep over the balloon and down the intestine, and we therefore attempted to measure the rate of propagation of the wave by inserting another balloon in the gut at some distance from the first. In a few

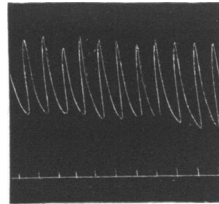

Fig. 2. Rhythmic Contractions of Intestinal coat, as recorded by a balloon introduced into gut and communicating with piston recorder¹. (Time marking = 6 seconds.)

¹ In all the curves recorded by the balloon method, contraction causes an *upward* movement of the lever. In the curves obtained by means of the enterograph, contraction is signified by a *downward* movement.

cases the contractions at both points of the intestine were isorhythmical, and apparently occurred at regular intervals. It is from such a case that we obtained the curve given in Fig. 3. In this the lower balloon was situated 10 cm. below the upper. The time marking denotes intervals of 6 seconds.

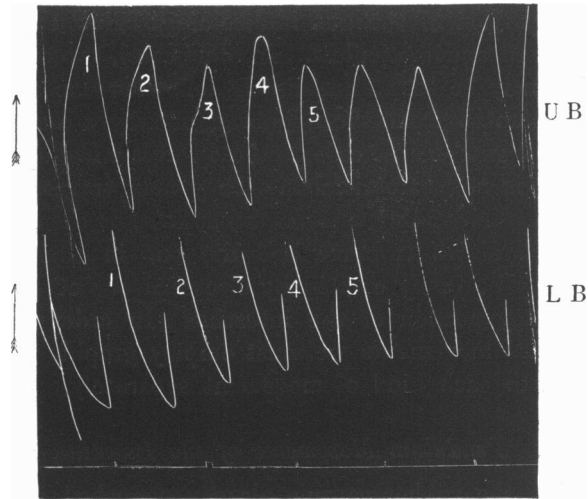

Fig. 3. Propagated contractions. Two balloons 10 cm. apart in a loop of intestine, ligatured at both ends. *UB* = upper and *LB* = lower balloon. Time marking = 6 sec. intervals. Rate of propagation = 5 cm. per second¹.

In this tracing the rate of propagation works out at about 5 cm. per second. We must confess however that we look upon these results with considerable suspicion. In the majority of cases, an apparently regular interval between the contractions at two points may gradually undergo modification, until the two points are contracting at the same time; or we may observe irregularities of the contractions at the two points, which are plainly due to a species of interference occurring between waves starting from different points.

A closer observation of the region of the capsules will at once explain these irregularities. Each capsule does not merely record the wave of contraction sweeping down the gut, but serves itself as an excitant of contraction. Immediately above each balloon a slight ring of constriction will be seen, and it is from this ring that the waves of contraction originate. Each balloon therefore excites its own con-

¹ All curves are to be read from left to right.

tractions. These will be in most cases isorhythmic, since the conditions at the two points of the gut are the same. But one cannot as a rule judge from the interval between the contractions at two points of the rate of propagation down the intestine. In a few cases the lower excitation seems merely to reinforce the wave as it arrives from the upper balloon, and it is from such cases that we have chosen the curve given above.

The extent and force of the contractions, as might be expected from our knowledge of unstriated muscle generally, vary with the tension of the intestinal wall. They are increased within limits by greater distension of the balloon or, if previously absent, they may be induced in the same way. Increased distension however does not alter the *rhythm* of contraction.

It has hitherto been a moot point whether the two coats of the intestine contract simultaneously or alternately. By registering the contractions of the two coats by means of two enterographs at right angles to one another, it may be shown that the two coats, if they contract at all, always contract at the same time (Fig. 4). The contraction of the longitudinal coat is thus not to aim at the dilatation of the intestine, but rather to protect the underlying circular coat, very much in the same way as skeletal muscles protect the joint which they or their tendons surround¹.

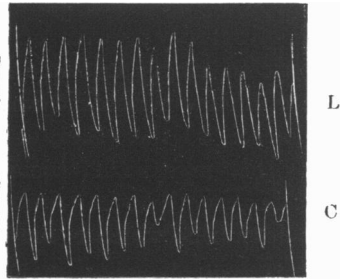

Fig. 4. Tracing of contractions of longitudinal (*L*) and circular muscle-fibres (*C*) at same spot, to show synchronous activity of two coats.

II. Peristaltic Contractions.

Peristaltic contractions may occur spontaneously in the (nervously) isolated small intestine, or if absent may be evoked by local stimulation. For this purpose a mechanical stimulus, such as a pinch, is more

¹ In one case, with very slight tension on the longitudinal enterograph, we observed apparent contractions of this coat alternating with those of the circular. The shape of the curve however showed that the active contraction was synchronous with the contraction of the circular coat, and that we were in fact merely recording the changes in the transverse diameter of the circular fibres. On increasing the tension in the longitudinal enterograph, the longitudinal fibres were put on the stretch and could record their contractions, which were now found to be synchronous with those of the circular coat.

effective than electrical stimulation, even when this latter is applied to the inner surface of the intestine by means of specially formed electrodes. Extremely powerful peristalsis may be excited by injecting strong solutions of sodium chloride into the lumen of the gut by means of a hypodermic syringe. The most certain and the best, because the most physiological, method of exciting a peristaltic wave is to insert a bolus, which may be made of cotton wool-covered with vaseline, into the intestine. On isolating about a foot of intestine and inserting the bolus about one inch from the upper end, it will be seen that shortly after putting in the bolus the contractions of the segment of intestine immediately above the bolus undergo increasing augmentation, until the intestine at this point enters into a strong tonic contraction. This presses the bolus onwards, and as the bolus moves the ring of constriction follows it up, until it has expelled the bolus through the lower opening of the coil. As the bolus passes down the intestine, it will be noticed that the whole part of the gut above the bolus is in a state of activity; waves of constriction passing down it as far as the constricted ring. In some cases, after the bolus has been expelled, a second slow peristaltic wave of contraction may pass from one end of the coil to the other, as if to expel any detached portions of the bolus that may be left behind. This progression occurs only in one direction, from above downwards. This rule is so invariable that one may determine which is the upper end of an isolated two inches of gut, by seeing in which direction a bolus is expelled. If the bolus be inserted from below and pushed up the gut, it will be returned by the way it has entered. If however the intestine is in good condition, this latter experiment becomes impossible. As we attempt to push up the lump of cotton-wool, the intestinal wall contracts strongly above it and resists the upward passage of the bolus to such an extent that we may tear the intestinal wall before we can push the bolus any further.

The conditions in the intestine which determine the movement of a bolus from above downwards will be better seen if we record the contractions of the longitudinal and transverse coats at a point about the middle of a coil of intestine, through which a peristaltic wave of contraction is excited by the insertion of a bolus.

In the experiment from which the curves Fig. 5 were obtained, two enterographs were placed at right angles to one another at a point 130 cm. from the pylorus. The position of the levers is shown in Fig. 5 *a*, *a* and *b* being the levers of the longitudinal enterograph (*a* being the *moveable* lever), *c* and *d* the levers of the enterograph

recording the contractions of the circular muscle. At the beginning of the observation the intestinal wall was contracting rhythmically, the

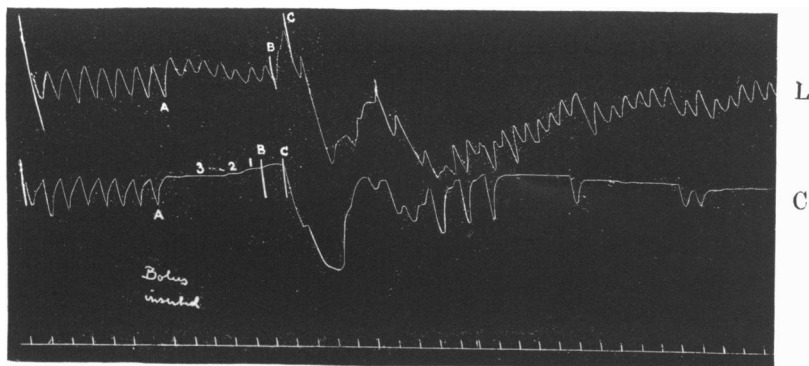

Fig. 5. Passage of a bolus down the intestine, as recorded by two enterographs at right angles. Longitudinal (L) and circular (C) coats.

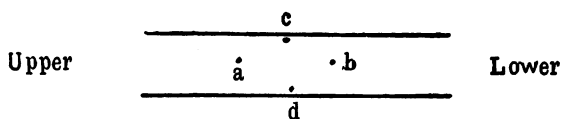

Fig. 5a.

contractions affecting both coats, and being synchronous in both. At A a bolus made of cotton-wool coated with vaseline was inserted by an opening into the intestine $4\frac{1}{2}$ inches above the enterographs. It will be seen that the contractions of the circular coat cease instantly, and this inhibition is accompanied by a gradually increasing relaxation. There is some relaxation of the longitudinal coat, but the rhythmic contractions do not altogether cease. On inspecting the intestine it was seen that the introduction of the bolus caused the appearance of a strong constriction above it. This constriction passed downwards, driving the bolus in front of it. The numbers above the tracing of the circular fibres indicate the distance of the bolus in inches from the uppermost enterograph lever. At B the bolus had arrived at the upper longitudinal lever and at C had passed this and was directly under the transverse enterograph, or a little below it. At this point a strong tonic contraction of both coats occurs, expelling the bolus beyond the levers. This strong contraction passes off to be succeeded by another, which like the first is moving down the intestine. In this second tonic wave

the rhythmic contractions are evident, superposed on the curve. After the passage of the bolus there is shortening of the gut (increased tone of longitudinal fibres).

In Figs. 6 and 7 we have tracings of the circular and longitudinal coats taken separately. In each case the approach of the bolus to the recorded point is signalled by inhibition in both coats, more marked in

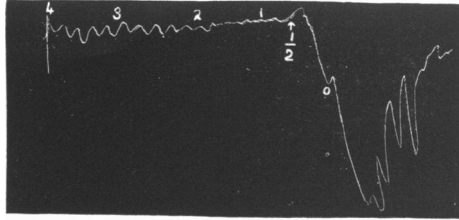

Fig. 6. Passage of bolus. Contractions of circular coat (enterograph).

the circular. Then as the bolus comes up to the levers there is a strong tonic contraction which pushes the bolus down past the levers, and on its decline is attended by rhythmic contractions in each coat.

If this experiment be repeated a number of times on the same piece of gut, the peristaltic mechanism becomes fatigued. This is shown by the fact that although a ring of constriction appears above the bolus, it is not maintained, but represents simply an exaggeration of the normal

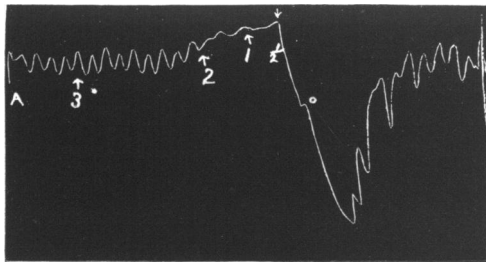

Fig. 7. Passage of bolus. Contractions of longitudinal coat (enterograph).

rhythmic contractions. To the eye the most evident fact is the absence or slowness of progression of the bolus. On a tracing of the contractions of the intestinal wall below the bolus, the most striking difference from the tracings already described is the *absence of inhibition* below the bolus. From the constricted ring above the bolus, waves of contraction pass down the intestine, *over the bolus*, and are recorded at some point

below. In such cases the onward movement of the bolus may be assisted by pinching it gently between the fingers. The extra stimulus applied to the wall of the gut reinforces the impulses started by the bolus itself, so strengthening the contraction *above*, and causing inhibition *below*. A tracing of the circular coat from an intestine in which this condition was present (though not pronounced) is given in Fig. 8. The

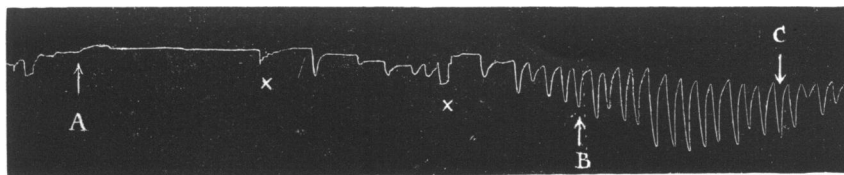

Fig. 8. Passage of bolus through fatigued intestine. Circular coat. Enterograph. At *A* bolus inserted 1 inch above enterograph. At *B* bolus immediately under enterograph, and at *C* bolus expelled from lower end of intestinal loop, 1 inch below recorder. At *X, X* intestine pinched outside bolus (both splanchnics cut).

bolus was here inserted only one inch above the recorder. It will be seen that the inhibition at first produced passes off before the bolus reaches the recorder. At the two points marked with a cross *X* the bolus was gently pinched, and in each case there was a transitory inhibition of the contractions below. The passage past the recorder instead of being effected by a single prolonged tonic contraction, is carried out simply by a series of strong rhythmic contractions, accompanied with very slight increase of tone.

We have already mentioned that it is often impossible to insert a bolus from below upwards. In an intestine which is tired, or inactive, this however is possible. In the experiment from which the tracing (Fig. 9) was taken, a bolus was pushed up the intestine, till it lay immediately between the recording levers of the enterographs. Here it will be seen that there was no trace of inhibition. The rhythmic contractions of both coats are immediately augmented, and the contractions increase in force, in two groups of beats, until the bolus is expelled from the lower end of the loop of gut, about two inches below the enterographs.

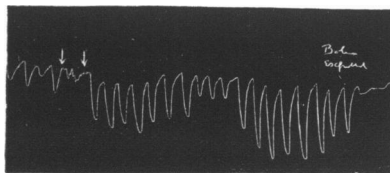

Fig. 9. Between the arrows $\downarrow \downarrow$ a bolus was inserted between the levers from below. (Enterograph tracing circular coat.)

From a study of these results we must conclude that the mechanism of a peristaltic wave of contraction which drives food or a bolus along the intestine is quite different from, and much more complicated than, that of the rhythmic pendular movements described above. For the onward progress of the bolus two factors are equally necessary, namely a condition of excitation and increased contraction above the bolus, and a condition of inhibition and relaxation of the intestine below. If either of these factors are absent the onward movement of the bolus becomes impossible. Since the whole act is evoked by the presence of the bolus within the gut, we must say that the irritation of the mucous membrane and the stretching of the walls of the gut at any point set up impulses which are transmitted both up and down the intestine, and cause excitation above, inhibition below. One can indeed state this conclusion more generally, namely that, if cerebro-spinal reflexes be excluded, excitation at any point of the gut excites contraction above, inhibition below. This is the law of the intestine.

We can show this double effect of local excitation very well by recording the contractions of the muscular wall at any point by means of a balloon connected with a piston recorder, and then stimulating the intestine above or below the balloon by gently pinching it between the fingers.

A tracing obtained in this manner is shown in Fig. 10. At the beginning of the observation the intestine was contracting perfectly

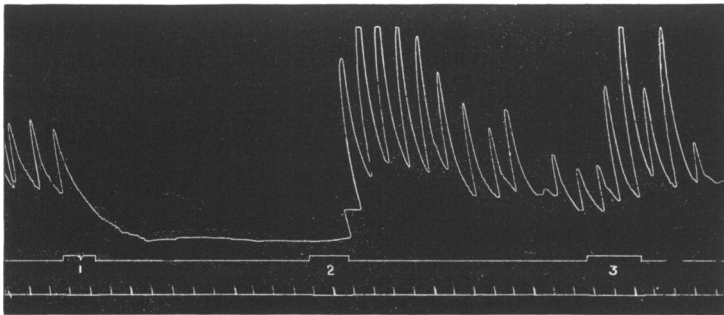

Fig. 10. Intestinal contractions (balloon method). In this dog all the abdominal ganglia had been excised, and both vagi cut. Showing propagated effects of mechanical stimulation above and below the balloon. (1) pinch above, (2) pinch below, (3) pinch below.

rhythmically. Towards the end of the third beat the intestine was pinched gently, one inch *above* the balloon. *At once* the rhythmic

contractions ceased, and the intestinal wall relaxed considerably. This complete inhibition lasted for 84 seconds. While the intestine was still perfectly quiescent, it was pinched gently half an inch *below* the balloon. For six seconds nothing happened; then the intestine suddenly recovered in tone, and this recovery was followed by a series of strong rhythmic contractions, accompanied by increased diastolic tone. The contractions were strong enough to completely compress the balloon. When the effect of this pinch had subsided, the intestine was again pinched one inch below the balloon. This was followed by a second augmentation of contractions, less marked however than on the previous occasion.

The same effects will be observed whatever method one may choose to record the intestinal movements, though the effects both of inhibition and excitation are more marked on the circular than on the longitudinal coat. The results of local stimulation on the contractions of the circular coat as recorded by the enterograph are shown in Fig. 11.

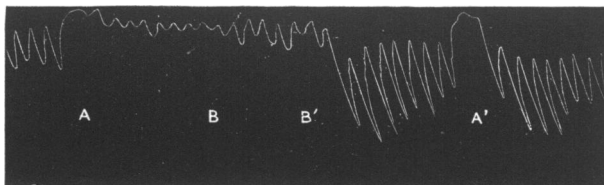

Fig. 11. Intestinal contractions, circular coat, recorded by enterograph. Showing propagated effects of mechanical stimulation of intestine (both splanchnics and vagi cut). Pinch just above=*A*; pinch 1 inch below=*B*; pinch $\frac{1}{2}$ in. below=*B'*; pinch $\frac{1}{2}$ in. above=*A'*.

These two effects do not run absolutely parallel to one another, in that in some experiments the inhibitory effects from above, in others the augmentor effects from below may be better marked. As a rule, however, when one reaction is prompt, the other reaction will likewise be well marked. There are however marked differences between the two kinds of reaction in their time-relations and extension along the intestine. We may therefore deal with each kind separately.

(a) *Motor effect.* As we have already mentioned, the excitatory effect of a local mechanical stimulation is first apparent at a point about 1 cm. above the point of stimulation. From here it gradually spreads up the intestine, and this spreading may have the appearance

of a short antiperistaltic wave. But if the excitation is pronounced, the rhythmic variations of activity in the region above the stimulus pass as waves *from above* downwards. The excitatory effect is therefore best marked close above the stimulated point, and rapidly diminishes in strength as it spreads up the intestine. In most cases although a pinch at 1 or even 2.5 cm. below the balloon causes augmentation of the excursions, a pinch 5 cm. below the balloon is ineffective. In very irritable intestines, however, a well-marked effect may be produced by pinching 6 cm. below the balloon, and we have on one occasion observed distinct augmentation of the contractions of the first part of the duodenum as a result of pinching the intestine 30 or 40 centimeters below. This latter effect may however have been a mere coincidence, since on no other occasion have we found the excitatory effects spread to nearly so great an extent.

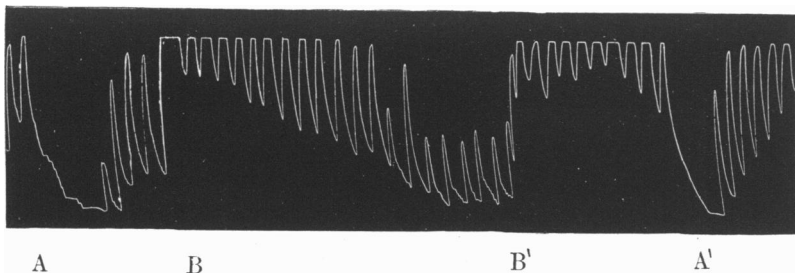

Fig. 12. Contractions of small intestine (balloon method), showing well-marked propagated effects of local stimulation above and below the balloon. A, pinch 15 cm. above. B, 1.5 cm. below. B', 6 cm. below. A', 5 cm. above.

Another feature of this upward excitation is the varying and often long latent period which elapses between the application of the stimulus and the motor response. On pinching the intestine one inch below the recorded point, the augmentation of contractions may come on at any time between 3 and 30 seconds after the application of the stimulus. The excitation seems to spread from point to point of the intestine, and thus the effect comes on later, the greater the distance between the point where the stimulus is applied and that at which the muscular contractions are being recorded.

(b) *Inhibitory effect.* The inhibitory effect below the stimulated point differs from the excitatory effect just described in the rapidity of its production and propagation and the distance along which it extends down the intestine. A certain excitatory effect can often only be

produced by pinching from $\frac{1}{2}$ to 1 inch below the recorded point. For the production of inhibition it seems to be a matter of indifference whether we excite one inch or four inches above the balloon, and the inhibitory influence of local excitation can often be traced two or three feet down the intestine. To the eye, the production of inhibition is apparently instantaneous, a pinch applied towards the end of one contraction inhibiting the next one. In one case, where the intestine was not beating, stimulation at a point 30 cm. above the recorded spot caused a simple relaxation of tone of the intestine at this spot. Here then it was easy to measure the rate of propagation of the inhibitory influence, which we found to amount to 10 cm. per second. This, however, can only be a minimal figure, since it depends on the assumption that the inhibiting stimulus—a pinch—was effective at the beginning of its application.

The wide extent of these inhibitory influences may serve to explain many of the conflicting results obtained by different observers in their experiments on the intestinal movements and their innervation. We have on more than one occasion noticed that irregularities of contraction and response to stimuli of a loop of ileum were apparently due to a distension of the duodenum with gas, and were got rid of by opening the duodenum and so relieving the distension. A sudden cessation of the rhythmic contractions of a loop of intestine may often be seen to be due to a peristaltic wave of contraction which is slowly advancing along the upper portions of the gut. For the same reason it is advisable where possible to avoid methods of registering the intestinal movements which involve the complete ligation of the gut at one or more places. These two conditions, excitation above and inhibition below, we regard as the normal reaction of the isolated intestine to a local stimulus. In many cases, however, our results have not been quite so clear. Although stimulation above the balloon produced inhibition, stimulation below produced also inhibition or preliminary inhibition followed by contraction. We cannot therefore absolutely exclude the possibility that inhibitory impulses may ascend as well as descend the intestine. We should be inclined to ascribe the irregular occurrence of ascending inhibition to a true spinal reflex carried out through small splanchnic fibres, which have not been divided with the great splanchnics, were it not that in one of the four cases when we believed we had extirpated the abdominal ganglia, we obtained this ascending inhibition several times at the beginning of the experiment. The ascending inhibition is never produced as a

result of stimulation by a bolus. We shall see later, that a general inhibition of the intestines can be produced reflexly through the

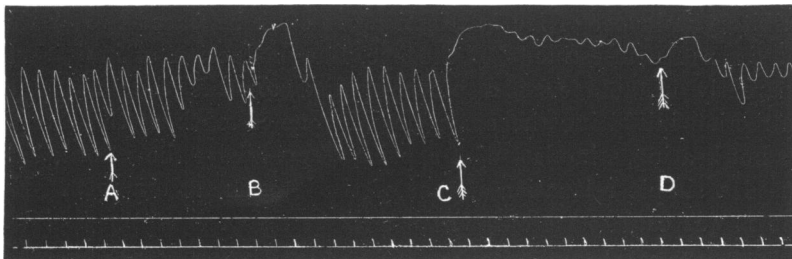

Fig. 13. Contractions of circular coat (enterograph), to show the abnormal *ascending* inhibition (both splanchnics cut).

A = gentle pinch 1 inch below enterograph.

B = hard pinch 1 inch below.

C = hard pinch 4 inches above.

D = hard pinch 4 inches below.

splanchnics by stimulation of the intestines and probably of any sensory surface.

It is evidently impossible to explain this complicated reaction of the isolated gut to local stimulation on any hypothesis which does not take into account the occurrence of a complicated system of nerve-fibres and ganglion-cells in the wall of the intestine. We cannot imagine any muscle-fibre or collection of muscle-fibres which would relax on one side and contract on the other side of an excited point. Nothnagel¹ showed that the application of a crystal of a sodium salt to the wall of the gut in cats and rabbits produced a ring of constriction about 1 cm. higher up, whereas with potassium salts the constricted ring was at the point of application. He concluded that potassium salts excite the muscle-fibres directly, while the action of sodium salts is chiefly on Auerbach's plexus. Apart from this observation, although many physiologists have invoked the aid of Auerbach's plexus to explain the propagation of the peristaltic wave, no proof has been furnished against Engelmann's contention that the whole process has its origin in and is carried out through the muscle-fibres. The tendency of physiologists during the last 30 years has been to deny to peripheral ganglia or collections of ganglia any reflex functions at all comparable to those possessed by the brain and spinal cord—functions, that is to say, which include coordination as well as mere reflexion of impulses. The facts we have brought forward however show beyond doubt that

¹ *Physiologie u. Pathologie des Darms.* Berlin, 1884.

the local nervous structures in the gut have this power of coordination, of directing one kind of influence along one path, and another kind of influence along another path, the result being a 'purposive' response directed to the propulsion of the food down along the alimentary canal. Auerbach's plexus is in fact a local nervous system with two reflexes, inhibition and augmentation, and one function, propulsion of food. The different time-relations of the two reflexes would lead one to guess that the system is composed of long paths which conduct inhibitory impulses downwards, and short paths which carry augmentor impulses from one cell-station to another in an upward direction. A histological testing of this hypothesis presents however considerable difficulties.

It becomes now important to inquire how the motor functions of the intestine will be modified if we abolish or paralyse the action of its local nervous system. A temporary paralysis of this system lasting from 10 to 40 minutes or more may be produced in various ways. One method we have adopted is to paint the surface of an exposed coil of intestine with a 2½% solution of cocaine in normal saline. The same effect can be produced by the injection of nicotine (2 to 3 c.c. of a 1% solution in a dog of 7 kilos.) or by the injection of large doses of muscarin (3 c.c. of a 0.1% solution). An intestine, the nervous system of which has been paralysed by one of these methods, at first sight presents very little difference from the normal. It appears, if anything, rather more active. The rhythmic contractions, which before may have been irregular, now become perfectly regular and often more powerful. They run as waves of constriction over the gut, but the waves pass as often in one direction as in the other. The following table represents a series of observations of rates of propagation of such waves.

	Length of intestine	Time of propagation	Rate per sec.
(1) ascending wave	8 cm.	3.5 secs.	2.3 cm.
(2) ascending wave	15 „	6.0 „	2.5 „
(3) descending wave	7 „	3.25 „	2.2 „

It will be seen that the rate is somewhat slower than that of the similar waves in the normal intestine.

In the paralysed gut it is impossible however by stimulating above or below the recorded spot to cause any alteration at all either of inhibition or augmentation in the strength of the contractions. A slight pinch has no effect on the intestine. A very strong pinch causes

a band of constriction in consequence of the direct stimulation of the muscle-fibres. This constriction passes off gradually without being propagated in either direction. A bolus may be placed anywhere within such an intestine without causing any change. The bolus remains in the spot where it was inserted.

These results show that we were justified in our distinction of two kinds of movements in the intestines. In the first place, we have the rhythmic pendular movements produced by simultaneous contractions of circular and longitudinal coats, and entirely myogenic in origin. They are propagated from muscle-fibre to muscle-fibre, and travel in either direction along the intestine at a rate of 2 to 3 cm. a second. The preponderance of the descending contractions in the normal animal may be due to the higher excitability of the fibres at the duodenal end of the gut, and to the constant presence of ascending augmentor stimuli. They are independent of the intestinal nervous system for their production or propagation, although they can be altered in the direction of inhibition or augmentation through the intermediation of this system.

The peristaltic contraction, on the other hand, is a true coordinated reflex excited by the distension of the gut at some point, or perhaps, when once established, by the advancing line of constriction itself. It is attended by and dependent on the simultaneous presence of two opposed conditions—excitation above and inhibition below the excited spot. It is possible that the slow progress of the wave may be due to the struggle between these two conditions in the region of the excited spot.

Every point then of the intestine is in a state of activity which can be played upon and modified by impulses arriving at it from all portions of the gut above and below, and its activity at any given time will be a resultant of these three factors, two of which are opposed to one another.

STIMULATION OF THE INTESTINE.

The most effective method of stimulating the intestine is the mechanical method, the best of all being the physiological one of distension of the gut by means of a bolus. Chemical stimulation is not so convenient because not so easily localised. Injection of a few drops of concentrated NaCl solution into the lumen of the gut evokes extremely powerful peristaltic contractions, as was pointed out by Nothnagel. We have not however been able to obtain on the dog's

intestine the results recorded by this observer with regard to the action of sodium and potassium salts, both salts causing in this animal a local patch of contraction.

Electrical excitation by means of induced currents generally produces a ring of constriction limited to the segment of the intestine excited. This contraction comes on slowly after the application of the stimulus, and may last 20 or 30 seconds. Now and then we may observe propagated effects up and down the intestines, as with mechanical stimulation, and the ring of contraction which is brought about may move slowly down the intestine as a peristaltic wave. Application of induced currents to the inner surface of the intestine is equally unsatisfactory, the propagated (reflex) effects being masked by the spread of current and consequent direct excitation of the muscle-fibres themselves.

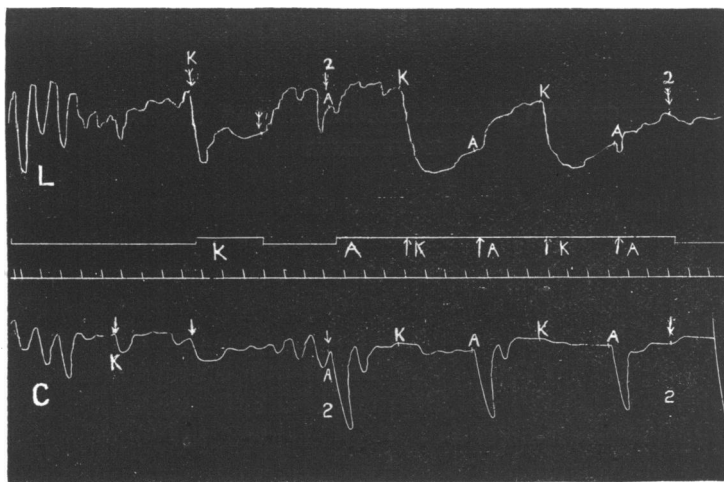

Fig. 14. Tracing of contractions of longitudinal (upper curve, *L*) and circular coats (lowest curve, *C*) to show effects of constant current.

The letters *K* (kathode) and *A* (anode) represent the sign of the electrode in contact with the gut. The passage of the current is shown by the second line. During the second excitation the current was reversed four times (as shown by arrows).

Intestinal contractions recorded by two enterographs placed at right angles to one another. One non-polarisable electrode in contact with intestinal wall between enterograph levers, the other electrode dipping in warm saline bath.

Between \downarrow_1 and \downarrow_1 current (8 Leclanché cells) closed so that intestinal electrode was kathode.

Between \downarrow_2 and \downarrow_2 current closed, and reversed repeatedly. The letters *A* and *K* represent the condition of the intestinal electrode.

Biedermann and Simchowitz¹ stated that when a constant current was applied to the intestines there was at make of the current a contraction of the longitudinal muscle at the kathode and of the circular muscle at the anode. During the passage of the current the contracted ring at the anode was the source of origin of peristaltic contractions. At the break of the current the reverse effects took place, viz., contraction of the longitudinal muscles at the anode, and of the circular at the kathode. In one experiment which we made on this point we obtained results very similar to those recorded by Biedermann.

Although there was a contraction of both sets of muscles on closure at the anode, this was more marked in the circular than in the longitudinal, whereas the reverse was the case at the kathode. We have not attempted to investigate this question any further, since it is better attacked in invertebrata than under the complicated conditions necessary for experimenting on the intestines of warm-blooded animals.

INFLUENCE OF VASCULAR CONDITIONS ON THE INTESTINAL MOVEMENTS.

There has been very considerable divergence of opinion as to the influence of ischæmia or asphyxia on the intestinal movements. According to Schiff², local anæmia induced by obstruction of the aorta evokes or strengthens intestinal contractions. Nasse³, and Mayer and von Basch⁴ state that obstruction of the aorta arrests the movements for a time, but that they return afterwards with increased vigour. Most observers (Betz⁵, van Braam Houckgeest⁶, Mall⁷), however, agree that anæmia inhibits all the movements of the intestine—a view which we can confirm. If the rhythmical contractions of the small intestine be recorded by the insertion of a small balloon, communicating with a piston recorder, obstruction of the aorta in the chest causes an almost immediate cessation of the movements, which lasts as long as the obstruction is continued (up to 15 minutes). During this time the

¹ *Pflüger's Archiv*, XLV. S. 369. See also Fürst, *Ibid.* XLVI. S. 367.

² *Lehrb. d. Physiol.* p. 105. 1858.

³ *Phys. d. Darmbewegungen.* Leipzig. 1866.

⁴ *Wien. Sitzungsber.* LXII. p. 811. 1870.

⁵ *Zeitschr. f. rat. Med.* R. II. 1.

⁶ *Pflüger's Archiv*, VI. S. 292. 1872, and VIII. S. 163. 1874.

⁷ *John Hopkins Hospital Reports*, I. p. 37. 1896.

lever sinks slowly, *i.e.* there is a gradual diminution of intestinal tonus. If now the obstruction be relieved, the intestines contract immediately

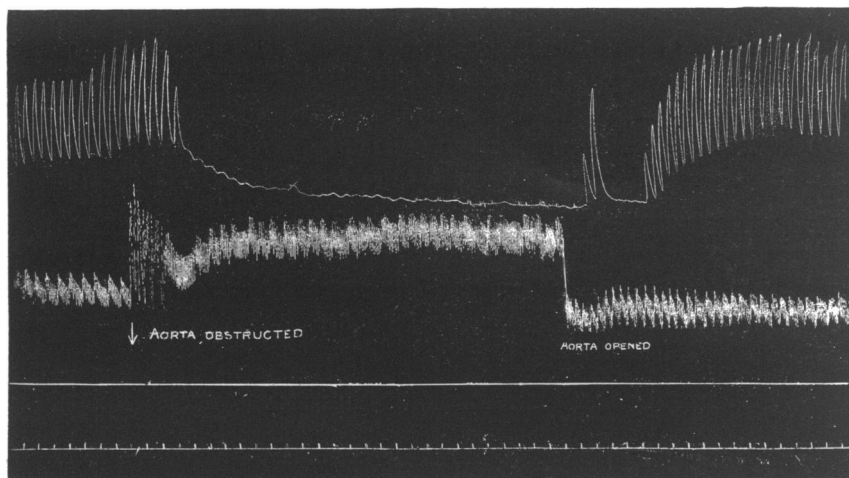

Fig. 15. Effect of aortic obstruction. (Balloon in intestine returned to abdominal cavity.)

once or twice, then pause and then recommence their rhythmic movements, the contractions increasing in force for a couple of minutes. This recommencement is associated with a considerable diminution in the diastolic volume of the intestine, *i.e.* increased tonus.

It is probable that the discrepant statements on this subject depend firstly on the frequent occurrence of anæmia and local asphyxia, and secondly on the varying behaviour of different animals. It is a familiar experience to everyone that on opening the abdomen of a recently killed rabbit, the intestines will be found in a state of active movement. In the case of the rabbit the excitatory effect of the circulation of venous blood through the intestines has been frequently pointed out (Engelmann¹, von Basch, etc.). In the dog the influence of venous blood is not nearly so marked, and indeed tends to check the movements rather than to augment them. If a dog be killed by any means and the abdomen then opened, the intestines will probably be found to be absolutely quiescent, or any slight contractions which may be present speedily die away. In the dog this cessation of intestinal movements is brought about, whatever means we may adopt of

¹ *Pflüger's Archiv*, II. p. 243. 1869, and IV. p. 33. 1871.

producing the local anæmia. Thus the result is the same, so far as the intestines are concerned, whether we stop the circulation through them by obstruction of the aorta, by stimulation of the vagus, by bleeding, or by cutting into the heart. Only in the case of the first part of the duodenum have we observed the special motor effect of the vagus accompanying the cardiac inhibition. Any drugs which cause a fall of blood-pressure tend to diminish in the same degree the intestinal movements, which again recover as the blood-pressure approaches normal. The exaggeration of the contractions observed in letting the blood into the intestines after a prolonged anæmia seems to be due to the great vascular dilatation and consequent increased blood-flow in the intestines, which results from the previous obstruction.

THE EXTRINSIC INNERVATION OF THE SMALL INTESTINE.

A short account by Miss Naylor of the nerve supply to the small intestine in the dog is given at the end of this paper. From that description it will be seen that the small intestine receives fibres from two sources, from the right vagus in the thorax, and therefore possibly from both vagi in the neck, and from the spinal cord through the sympathetic system. Since the greater part of the fibres of the latter class run in the large splanchnic nerves, we shall speak of them collectively as the splanchnics, especially as most of our experiments on the effects of their section or excitation have been confined to those two main trunks.

The influence of the splanchnic nerves.

Historical. Pflüger¹ was the first to show that stimulation of these nerves inhibited the intestinal movements. This observation has been confirmed by almost every subsequent worker, though there has been considerable discussion as to the exact mode in which the inhibitory action is brought about. S. Mayer and von Basch² ascribed the inhibitory action of the splanchnics to their vaso-constrictor influence on the intestines. According to van Braam Houckgeest³ this view is negatived by the following experiment. The intestines of a rabbit are

¹ *Ueb. d. Hemmungsnervensystem f. d. peristalt. Beweg. d. Därme.* Berlin, 1857.

² *Loc. cit.*

³ *Loc. cit.*

exposed to the air until they become reddened by vaso-motor paralysis. Stimulation of the splanchnics now has no effect on the blood vessels, although the movements of the intestines are inhibited as in a normal animal. Jacobi¹ states that the intestinal inhibitory fibres of the splanchnics take a different course from the vaso-motor fibres, and that section of the nerves running from the suprarenals to the solar plexus annuls the inhibitory action of the splanchnics without interfering with their vaso-constrictor effect.

Besides these inhibitory results, various physiologists have recorded a motor effect on stimulating the splanchnics (Schiff², Ludwig and Kupfer³, Bechterew and Mislawsky⁴, Bunch⁵). The last-named observer has given graphic records of intestinal movements in which stimulation of the splanchnics caused in some animals augmentation, in others inhibition of intestinal tone, and in some cases preliminary augmentation. He concludes that nerve-fibres of opposed functions run in the splanchnics, and that the result obtained is due to the preponderating influence of one or other kind in the particular animal employed.

According to Ehrmann⁶, the intestines conform to v. Basch's idea of crossed innervation, the splanchnics being motor for the longitudinal and inhibitory for the circular coat. Courtade and Guyon⁷ on the other hand state that in an animal under normal conditions the splanchnics produce contraction of the circular and inhibition of the longitudinal coat; though they have obtained Ehrmann's results when the intestines were in an abnormal state. They conclude therefore that the splanchnics contain motor and inhibitory fibres for both layers of muscle.

Bechterew and Mislawsky and Bunch have investigated the spinal nerve-roots which contribute fibres through the sympathetic to the intestines. According to Bunch, nerve-fibres pass to the splanchnics from the anterior roots of the 6th thoracic to the 2nd 3rd, 4th or 5th lumbar nerves, and have one cell-station on their course, in the ganglia of the solar plexus.

¹ *Archiv f. exp. Path. u. Pharm.* xxix. p. 171. 1892.

² *Moleschott's Untersuch. z. Naturlehre*, vi. p. 201. 1860.

³ *Zeitschr. f. rat. Med.* III. R. II. p. 357. 1857.

⁴ *Du Bois' Archiv*, Suppl. p. 243. 1889.

⁵ *This Journal*, xxii. p. 357. 1898.

⁶ *Wien. med. Jahresh.* 1885.

⁷ *Archives de Physiol.* 1897.

In the preceding sections we have only described the appearance of the intestines after section of both splanchnic nerves or destruction of the spinal cord or abdominal ganglia. Quite a different state of things is found in a dog in whom these nerves are intact. On opening the abdomen in the warm saline bath, the intestines are seen to be collapsed and absolutely motionless. Local irritation, electrical or mechanical, either provokes no response at all, or if strong enough causes a local contraction limited to the stimulated spot. On inserting a rubber capsule distended with air under pressure and connected with a piston recorder, the lever of the recorder often remains permanently motionless. If contractions are present they are slight in extent and irregular in rhythm. Stimulation either above or below the capsule produces merely inhibition.

If both splanchnic nerves be now divided, there is no immediate change, but in the course of $\frac{1}{4}$ to $\frac{1}{2}$ hour the intestines gradually become more active; the previously motionless intestine commences to beat rhythmically, and any contractions which were previously present become stronger and more regular. The intestine at the same time becomes somewhat redder than before, owing to the vascular dilatation produced by section of the splanchnics.

These facts suggest that in the intact animal, at any rate under the conditions of our experiment, tonic or reflex influences are continually descending the splanchnic nerves, inhibiting the activity of the intestines. This conclusion is strengthened by the result of stimulating

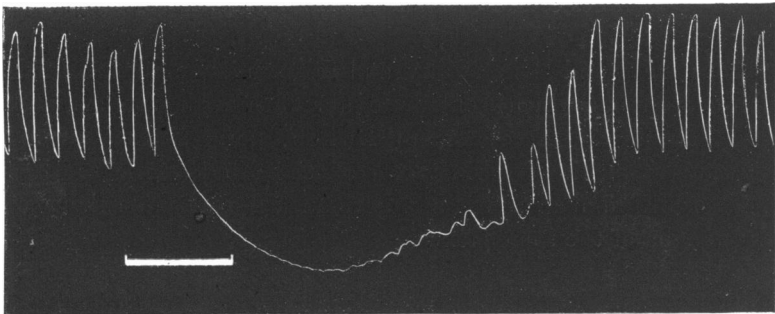

Fig. 16. Excitation of both splanchnic nerves. Balloon method.
Intestine returned to abdomen.

these nerves. On exciting the peripheral end of the cut splanchnic immediately below the diaphragm, the intestinal contractions being

recorded by the balloon method, there is at once a complete cessation of the contractions accompanied often by a diminution of the diastolic tone of the intestinal wall. This inhibition may outlast a short stimulation of the splanchnic. If the stimulation be however prolonged, the intestines after a time 'escape,' and recommence their contractions. The inhibitory effect generally becomes less with each succeeding stimulation, pointing to a tiring of the inhibitory fibres (Fig. 17).

This inhibition is of course accompanied by a large rise of blood-pressure, caused by a constriction of, amongst others, the intestinal vessels, as shown by the pallor of the intestines. The similarity

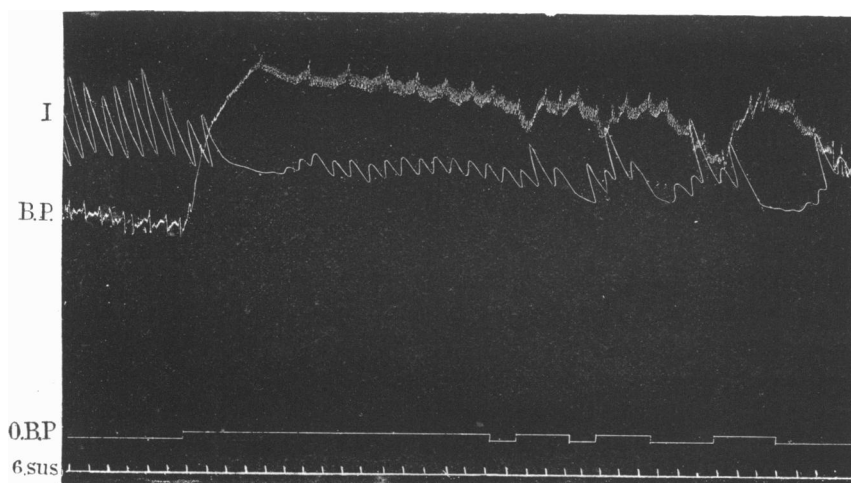

Fig. 17. Prolonged excitation of right splanchnic nerve, coil 13, showing 'escape.' Intestines in warm saline bath. Balloon method.

between the curve of intestinal inhibition produced by stimulation of the splanchnics, and that obtained by blocking of the aorta (*vide* Fig. 15) at once suggests the possibility that the two conditions are produced in the same way, and that the splanchnic inhibition is merely an indirect effect of the vascular constriction and consequent intestinal ischaemia, which is the result of stimulating the splanchnics. The experiments of van Braam Houckgeest cannot, in the absence of plethysmographic evidence, be regarded as a direct proof to the contrary. We believe however that the conclusions of this observer were correct, and that the inhibitory effect of stimulating the splanchnics

is quite independent of the vascular effect. Thus there is absence of parallelism between the two phenomena. In some cases the rise of blood-pressure may be well-marked, with very little inhibition of the intestines, while in other cases we may observe prolonged inhibition with only slight alteration of blood-pressure. If the peripheral end of the divided splanchnic on one side be stimulated repeatedly with induced currents, the changes in the blood-pressure curve are remarkably constant with each stimulation. The inhibition of the intestinal movements is however best marked at the first stimulation, and becomes less and less marked with each succeeding one (Fig. 17). If the intestines are active, they may continue to contract for a few minutes after circulation has been abolished by cutting out the heart. Under these conditions, stimulation of the splanchnics still produces inhibition, although it can in no way alter the state of the circulation (Fig. 18). If the stimulation be continued for a considerable time, the intestines begin to beat, and may resume their normal rhythm, while the nerve is still being excited and the blood vessels are strongly constricted. These inhibitory effects are produced simultaneously over the whole of the small intestine and follow almost immediately the commencement of excitation. The latent period is certainly not greater than two seconds, and is probably less. It can be observed as well in a few inches of gut ligatured at the two ends as in the uninjured intestine.

The same inhibitory effect is produced by stimulating the filaments of the mesenteric nerves, which run in close connection along the branches of the mesenteric artery.

We have also investigated the action of the splanchnic nerves on the two muscular coats of the intestine as recorded by means of the enterograph. In the case of the circular coat, the results and curves are exactly similar to those obtained by the introduction of a balloon. But with regard to the longitudinal muscles, our experiments lend no confirmation to the theory of crossed innervation, either in the form put forward by Ehrmann, or in that adopted by Courtade and Guyon. In every case stimulation of the splanchnics caused relaxation of both coats simultaneously. We would conclude then that the splanchnic

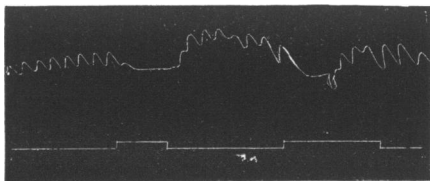

Fig. 18. Intestinal contractions two minutes after heart has been excised. Excitation of splanchnics (coil 12) still causes inhibition although circulation has ceased. (Same exp. as Fig. 17.)

nerves are inhibitory for both longitudinal and circular muscles of the small intestine.

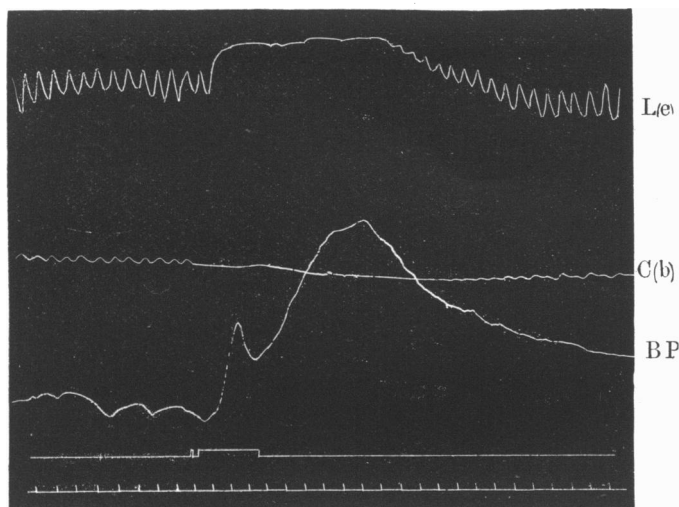

Fig. 19. To show inhibitory effect of splanchnics on *longitudinal* coat. Enterograph tracing, *L(e)*. Coil 11. Saline bath. Circular coat by balloon, *C(b)*. Base line *BP* has been raised 6 cm.

It will be observed that in the foregoing account we have made no mention of any motor effects of splanchnic stimulation, although such effects have been described by other observers. We have however on various occasions obtained apparent motor effects, which can be divided into two categories.

1. In a number of cases the rapid fall of the lever caused by the primary inhibition at the beginning of the excitation is succeeded by a slow rise and then a fall, so that one might describe as a result of the stimulation, inhibition of the rhythmic movements accompanied by a slow tonic contraction. This result is illustrated in the curves Fig. 20. In these curves it will be noticed that the line traced by the intestinal lever is exactly parallel to the blood-pressure curve. Such tracings are more often obtained when the blood-pressure is very low at the commencement of the observation in consequence of relaxation of the arterioles. It seems to us most probable that this slow tonic change is really due directly to the contraction of the blood vessels, and not to any changes in the intestinal muscle-fibres proper.

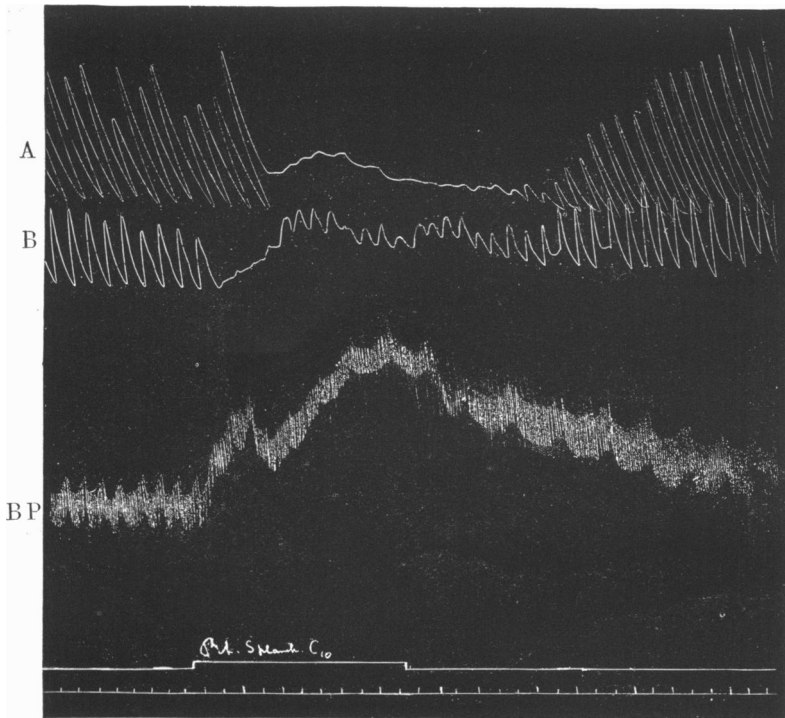

Fig. 20. Two balloons in gut, returned to abdominal cavity. To show 'pseudomotor' effect of splanchnics.

A, Balloon in second part of duodenum.

B, Balloon in small intestine 25 cm. from third part of duodenum. The line above the time-tracing marks the zero of blood-pressure.

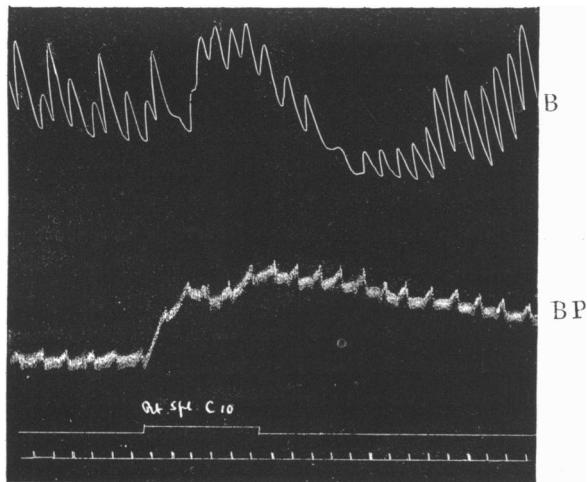

Fig. 21. 'Motor' effect of splanchnic, due to visible contraction of abdominal muscles. (Intestines returned to abdomen, and abdominal wound closed.) Line of marker is zero of blood-pressure.

2. The apparent motor effect just described may be obtained with the recorded loop of intestine inside the abdominal cavity or floating freely in the warm saline bath. In Figs. 21 and 22 we give curves obtained by stimulating the splanchnics in which the motor effect is much more marked and comparable to that observed and recorded by Bunch. Both these curves were however obtained from animals in which the balloon was inserted in a loop of intestine which had been returned to the abdominal cavity. In the experiment from which Fig. 21 was obtained, we could see that stimulation of the peripheral end of the splanchnic caused reflexly or by escape of current contractions of the muscles of the abdominal wall. In the dog from which Fig. 22 was taken, we could detect no apparent

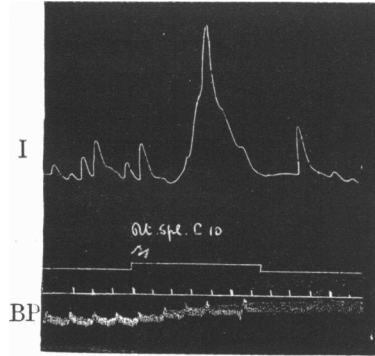

Fig. 22. 'Motor' effect of splanchnics. Blood-pressure extremely low (the bottom of the figure is the zero) in consequence of a large sudden injection of a mixture of morphia and atropin. Intestines returned to abdominal cavity. (Causation probably as in Fig. 21.)

cause for the rise of the intestinal lever, and we thought at first that we had here a genuine motor effect of splanchnic excitation. On repeating the experiments however with the intestine outside the abdominal cavity, we have been absolutely unable to obtain a similar result, although we have tried the effect of varying conditions, of stimulation, narcosis, &c. We are therefore inclined to regard all such motor effects, in the dog at any rate, as due to accidental contractions of the skeletal muscles, and believe that in this animal the splanchnic is a purely inhibitory nerve for the intestinal muscle.

The experiments of Jacobi and ourselves tend to show that the splanchnics are the bearers of tonic inhibitory impulses to the intestines. There is no doubt that under the conditions of our experiments these tonic impulses are reinforced by reflex inhibitory influences dependent on stimulation of sensory nerves. If one splanchnic be intact, inhibition of intestinal movements can be produced by stimulation of the central end of a sensory nerve, or of the central end of the other splanchnic. The most striking method of producing reflex inhibition is stimulation of the intestine itself. If one or both splanchnics be intact, the slightest stimulus applied to the intestine, even a gentle handling of the gut, suffices to produce a reflex inhibition of the whole length of

the intestine. If now both splanchnic nerves be divided and the intestine again stimulated the inhibition will in most cases be limited to the parts of the intestine below the stimulated spot. If however the splanchnics be intact, the inhibition is as well marked in a loop of intestine, isolated by ligatures or section from the rest of the gut, as under normal conditions (Fig. 23). This shows that the effect is not propagated along the intestinal wall, but is a true reflex carried out through the mesenteric nerves.

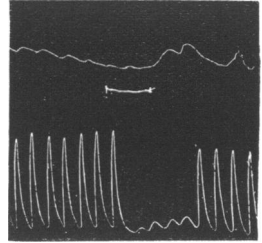

Fig. 23. Reflex inhibition of contractions in loop cut away from rest of intestine. (One splanchnic nerve intact.)

Every part of the intestine appears to receive fibres indiscriminately from the splanchnics of both sides. If a short loop of gut be isolated and its contractions recorded in any way, no difference can be observed between the effects obtained on stimulating the splanchnics on either side.

ACTION OF THE VAGUS NERVES ON THE SMALL INTESTINE.

Historical. A number of authors have described the vagus as the motor nerve of the intestines (Budge¹, Ludwig and Kupfer, Engelmann, &c.). According to van Braam Houckgeest, the vagus has no direct action on the intestines, the contractions being simply propagated from the stomach. Mayer states however that he has observed movements of the small and large intestine on stimulation of the vagus, even after ligature of the duodenum. There is no doubt that under certain conditions stimulation of the vagus has no apparent effect on the intestines. Bunch only observed an effect (inhibition) once out of a large number of experiments, and was therefore inclined to deny that the vagus possessed any motor functions². Jacobi states that in the rabbit, after a few days' starvation, stimulation of the vagus is without effect unless the splanchnics, or the fibres which run from the suprarenals to the solar plexus be divided, and hence regards these fibres and the vagi as mutually antagonistic. He states that in rabbits the intestinal fibres are conveyed chiefly in one vagus, either right or left, while the other vagus sends fibres chiefly to the stomach.

¹ Wagner's *Handw. d. Physiol.* III. p. 422. 1846.

² This observer has since obtained motor effects on repeated stimulation. *v. this Journal*, xxiv. 1899.

These discordant results are probably due to a failure to take into account the various disturbing influences which may affect the intestines and their response to vagal stimulation. Among the conditions which may cooperate in preventing the motor effects of the vagus, considerable importance must be ascribed to anæsthetics and narcotics, and the exposure and handling of the intestines with the circulatory changes thereby induced. More important than these factors are however the inhibitory influences to which, as we have seen, all parts of the intestine are subject—influences which are partly reflex in origin and are started by stimulation of any sentient surface or the intestine itself, and transmitted through the splanchnic nerves, and influences which, originating in the intestine itself, tend through the local nervous mechanism to inhibit the activity of all the lower segments of the gut. In investigating the action of the vagus, then, we must avoid, so far as possible, these disturbing factors by dividing both splanchnics, by maintaining a quiet anæsthesia without excessive A.C.E. intoxication, and by dispensing so far as possible with any irritating lesion of the gut above the segment, the activity of which we wish to investigate.

Division of the Vagi. In our experiments we have been unable to obtain any evidence of the existence of tonic influences passing to the intestines along the vagus nerves. In most cases section of one or both vagi is without result either immediate or remote on the intestinal movements. In one experiment in which the intestinal movements had been extremely active, we observed a cessation of the movements on dividing both vagi. This diminution in the activity of the gut lasted only two or three minutes, and one cannot from this isolated result deduce any tonic activity of the vagi.

Stimulation of the Vagi. In all experiments on the influence of the vagus on the intestines it is well to adopt the precaution recommended by Jacobi, viz., the division of both splanchnic nerves, in order to remove the tonic inhibitory impulses which pass along these nerves to the intestines. Unless otherwise mentioned, this procedure was adopted in all the experiments described in this section.

If the peripheral end of the divided vagus be stimulated in the neck, the anæmia of the intestines caused by inhibition of the heart has its usual effect, viz., a temporary diminution or cessation of the intestinal contractions. There is however as a rule no change in the intestines which can be regarded as a direct consequence of the vagal stimulation.

This cardiac inhibition may be prevented by intravenous injection

of 0.4 c.c. of a 1% solution of atropin. If the cardio-inhibitory fibres be paralyzed in this way, and the peripheral end of either vagus be stimulated again, in nearly all cases no effect is produced. In our earlier experiments we were therefore inclined to agree with those authors who have denied the existence of intestino-motor fibres in the vagus, so far at any rate as the dog is concerned. If however the stimulation be repeated five or six times, an effect on the intestines begins to be apparent, and becomes more marked with each succeeding stimulation. The effect is twofold. The only change which is seen in

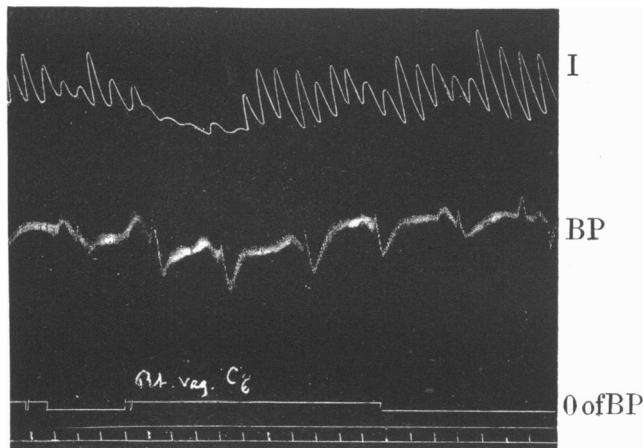

Fig. 24. Fourth stimulation of right vagus in neck, after atropin.

the first *effective* stimulation is a temporary inhibition of the intestinal contractions, causing a dropping of one or two beats. In the succeeding stimulations, this primary inhibitory effect is followed after a latent period varying from 10 seconds to 2 minutes by an augmentor effect; the beats increase in amplitude and rhythm, and the relaxation between each beat is incomplete, so that there is a great increase of diastolic tone. In many cases the excitation is so pronounced that the lumen of the gut and the balloon are obliterated altogether by a strong tonic contraction.

There seems to be no relationship between the extent of the inhibition and the amount of subsequent augmentation observed. In nearly all cases both effects are observed, one initial and the other secondary. But in many of our experiments there was evidence of an inhibitory influence lasting throughout the period of excitation. Owing

to the difference in the latencies of the two effects, the augmentation outlasts the stimulation by a length of time corresponding to its latent

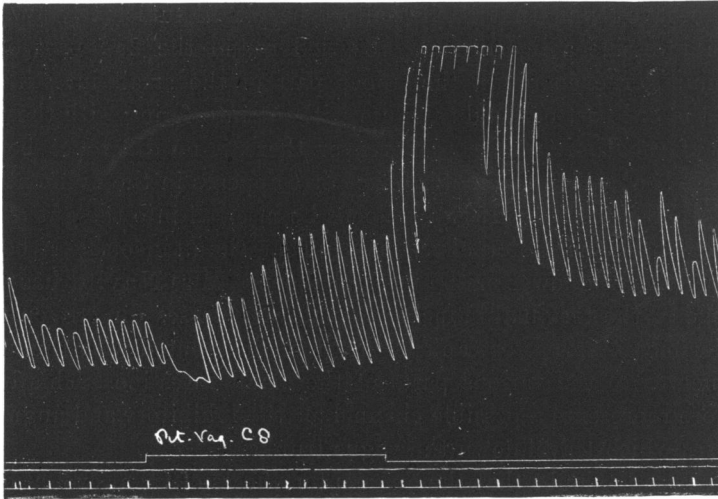

Fig. 25. (Same exp. as Fig. 24.) *Ninth* stimulation of right vagus.

period. In such cases therefore a typical result of stimulating the vagus is:

1. Inhibition (one or two beats).
2. Gradual increase of beats to an extent somewhat above normal (summated effect of inhibitory and augmentor stimuli).
3. After cessation of stimulus, an immediate and considerable augmentation of the individual beats (Fig. 25).

The increase of intestinal tone which is caused by stimulating the vagus nerves is not due to an advancing peristaltic wave; that is to say, the motor effect is not simply a propagated contraction originating in the stomach or duodenum. On inspecting the intestines it will be seen that the point of greatest activity is that which is already stimulated by the presence of the balloon; although there is evidently an increased motor activity of all parts of the small intestine.

In no case have we obtained the augmentor effect of vagal stimulation on recording with a balloon placed in a small loop of intestine ligatured at both ends. In fact the mere application of a ligature round the small intestine some way above the recorded spot suffices in most cases to abolish the motor effect, although the primary inhibi-

tion is still obtained on exciting the vagus. On this account we stated in our preliminary notice in the *Proc. Physiological Society* that the augmentor vagus fibres do not travel in the mesenteric nerves. Since then we have found that if the balloon be placed sufficiently low down in the intestine a ligature may be tied round the 2nd part of the duodenum, or even round the upper part of the small intestine just below the 3rd part of the duodenum without interfering with the motor effects of vagal stimulation. Moreover there is no difference between the periods at which the motor effect first appears in the different parts of the small intestine. If two balloons be inserted into the gut at some distance apart, the motor effect may appear simultaneously in both, or first in either the lower or the upper balloon. Miss Naylor has shown that one of the terminal branches of the vagi passes directly on to the superior mesenteric artery and is therefore distributed with the mesenteric nerves to the various parts of the small intestine. This branch therefore represents a possible channel for the inhibitory and augmentor impulses which travel down the vagus trunks.

There is no doubt that the augmentor effects of vagal excitation are extremely susceptible to the influence of inhibitory stimuli. It is very difficult and in most cases impossible to evoke the augmentation unless the splanchnic nerves have been previously divided. On several occasions when recording with the balloon in the lower part of the ileum we have found that an absence of effect, even on repeated stimulation, was associated with a distended condition of the duodenum or upper part of the small intestine. On relieving the distension by means of a small incision in the unattached border of the gut and then stimulating the vagus again, a motor effect was immediately produced. It seems probable therefore that the absence of the augmentor effect in a loop of intestine which has been ligatured above or at both ends, is due not so much to the cutting off of the normal nerve channels as to the continued inhibition excited by the upper ligature. We are inclined therefore to believe that the vagus as well as the splanchnic impulses reach the gut by way of the mesenteric nerves.

Action of the vagus on the first part of the duodenum.

We have shown that the action of the vagus on the small intestine is direct, and not an effect propagated along the wall of the gut from the stomach or duodenum. No difference can be observed between the behaviour of the 2nd and 3rd parts of the duodenum and the rest of the

small intestine. The 1st part of the duodenum however seems to be more immediately and intimately under the control of the vagi. Here we may often obtain motor effects with the 1st or 2nd stimulation of these nerves, and the question arises whether the delay in the appearance of motor effects in the lower segments of the gut may not be determined by the active constriction of the 1st part of the duodenum and the consequent inhibitory impulses which descend the walls of the gut. We may here mention two effects which we have obtained from stimulating the vagi, while recording the contractions of the 1st part of the duodenum by means of a balloon connected with a piston recorder.

On two occasions, on stimulating the peripheral end of the right vagus before the administration of atropin, the usual complete cardiac inhibition was produced, but instead of getting the temporary intestinal inhibition due to anæmia, as one does when recording the contractions of the lower part of the small intestine, we obtained a typical vagus tracing, viz., a dropping of two beats followed by a powerful augmentation. A peristaltic wave was in fact set up which travelled a short distance along the duodenum. This result resembles closely that described by Engelmann as the normal effect of stimulating the peripheral end of the vagus in the rabbit.

Another curious result is shown in the tracing (Fig. 26) obtained from one of the same animals after the injection of 0.4 c.c. of 1%

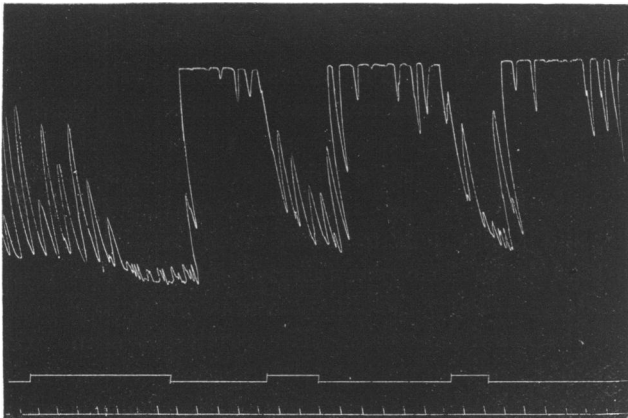

Fig. 26. Tracing of contractions of first part of duodenum (balloon method) showing inhibitory effect of vagus (coil 12) lasting during whole of period of stimulation, and followed by a very pronounced motor after-effect.

atropin solution, and is an exaggerated example of the result which we have already described in the small intestine, viz., inhibition lasting during the whole period of stimulation, followed by augmentation when the stimulus is discontinued. This condition was so marked in the animal from which Fig. 26 was obtained that the 2nd and 3rd stimulations of the vagus appeared to cause simply inhibition of a strong tonic contraction of the wall of the gut. As a matter of fact of course, the after-effect of each stimulation was to maintain the contracted condition which had been inhibited during the period of stimulation.

According to Jacobi, the intestino-motor effects of the vagus in the rabbit are limited to one side. In the dog we have found no such difference between the two vagi. As a rule when the typical inhibitory motor effect has been obtained by stimulating the vagus on one side, an identical effect may be obtained immediately afterwards on exciting the other vagus. Now and then one may find slight differences in the action of the vagi on the two sides, the inhibitory or motor effects being more pronounced on one side or the other. This occasional difference suggests that these two effects are carried out by two different sets of fibres, and are not merely the initial and secondary effects of stimulating a single nerve.

Can the effects of the vagus on the intestines be accounted for by any coincident vascular change?

This question naturally arose in seeking for some possible explanation of the twofold effect of stimulating the vagus. We thought especially that the very constant initial inhibition might be due to some vascular changes in the intestines excited by the stimulation of the vagus. In order to decide this point about 3 ft. of the small intestine was enclosed in the intestinal plethysmograph devised by Edmunds¹, and kindly lent to us by Prof. Halliburton. At the same time a rubber-balloon was inserted into the upper part of the small intestine just below the duodenum, in order to record the contractions of the muscular coats. The results of stimulation of the vagus on the intestinal contractions and volume are shown in Fig. 27. It will be seen that there is no change in the volume which can be ascribed to an active vaso-constriction or vaso-dilatation of the intestinal

¹ This *Journal*, xxii. p. 380. 1898.

arterioles. The small rise which occurs in the plethysmographic lever at the commencement of the excitation is synchronous with the

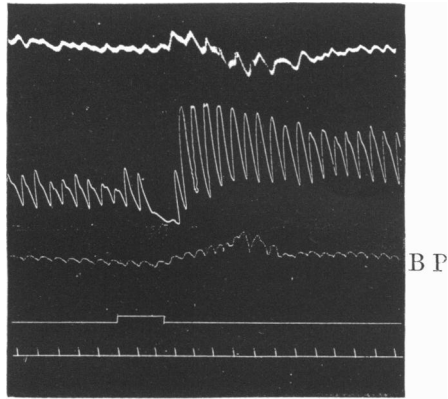

Fig. 27. Simultaneous record of intestinal contractions, and intestinal volume, during stimulation of peripheral end of vagus in neck (atropin). Uppermost tracing, intestinal oncometer; next tracing, intestinal contractions. Line of marker is 3 cm. above zero of *BP*.

inhibitory relaxation of the muscular coats. Since the intestine was ligatured at both ends and contained a certain amount of air, any relaxation of the muscular coat would diminish the pressure on the contained air, and so allow of a slight increase in volume of the whole intestine. We must conclude therefore that the vagus does not produce any vascular constriction which would account for the initial inhibition, nor any vaso-dilatation which might cause the subsequent augmentation of contractions. The hypothesis that the inhibitory effect of the vagi is due simply to a spread of the excitation to splanchnic fibres, either by an electrotonic spread of the strong currents employed or by a pseudo-reflex through the cells of the semilunar ganglia, is negated by the fact that the initial vagus inhibition is unaltered by repeated stimulation of the splanchnics until these latter are fatigued. If the splanchnics be stimulated several times in succession, their inhibitory effect on the intestines diminishes and finally almost disappears. On stimulating the vagus, however, the inhibitory effect is as well marked as before the splanchnic stimulation.

Moreover one would imagine that the conditions for spread of excitation from vagus to splanchnics would be identical on both sides; whereas in several experiments we have observed an inhibitory effect predominating with excitation of one vagus, while excitation of the

other vagus produced chiefly or wholly an augmentation of contractions. These results confirm a conclusion arrived at earlier, viz., that the vagus contains two sets of nerve-fibres to the muscular coats of the gut, one of them inhibitory in function with a short latent period, and the other set motor or augmentor with a long latent period.

These fibres act directly on the muscles or more probably on the nervous mechanisms throughout the whole length of the intestine. Their action is practically unaffected by atropin. We have obtained a well-marked vagus augmentation after the intravenous injection of 30 mg. atropin, which is six times as much as the dose necessary to paralyse the cardio-inhibitory fibres. They are not paralysed by a moderate dose of curare, sufficient to abolish voluntary movement, provided that the injection of this drug does not cause too great a fall of blood-pressure. All effects of the vagus on the intestines are completely, and, in our experiments, permanently abolished by minimal doses of nicotin, e.g. 0.3 c.c. of 1% solution.

Action of vagus on longitudinal fibres. So far as the circular coat is concerned, the curves obtained on stimulating the peripheral ends of the vagi present the same features whether we record their contractions by the balloon method or by means of the enterograph. It is much more difficult to make certain of a similar effect of the vagus on the longitudinal fibres. The initial inhibition or relaxation is nearly always present though generally not so well marked as in the case of the circular fibres. In very few cases however have we observed a subsequent augmentation of the longitudinal contractions, and where such has been present it has been only slight (Fig. 28). One might be tempted to ascribe this absence of result to the exposed situation of the

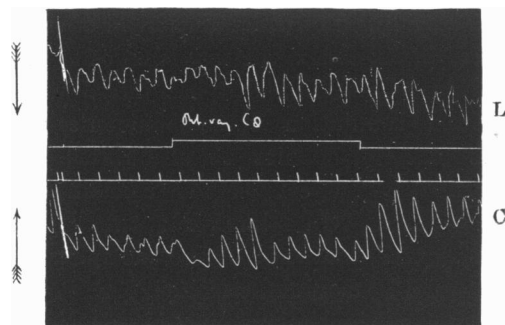

Fig. 28. Tracing of longitudinal and circular contractions of intestine to show effect of vagus.

thin longitudinal coat and its consequent slight injury from handling or from inhibition of the normal saline fluid, were it not that in the same experiments the inhibitory effects of the splanchnic nerves were as well marked on the longitudinal coat as on the circular.

Reflex vagus effects. With the exception of the one experiment mentioned at the beginning of this section, we have obtained no evidence of any tonic or reflex action of this nerve on the muscular coats of the intestine. Stimulation of the central end of the vagus with the other vagus and splanchnics intact caused simply an intestinal inhibition accompanying the ordinary pressor effect which is the normal result of stimulating this nerve. On dividing both splanchnics leaving only one vagus intact, stimulation of the central end of the other vagus had no effect at all on the movements of the gut.

ACTION OF DRUGS ON THE INTESTINE.

Our experiments on this subject are somewhat fragmentary, since they were directed to the elucidation of the physiology of the intestinal wall rather than to the pharmacology of the drugs themselves. We will therefore mention shortly the main points we have observed with regard to the various drugs made use of in the experiments recorded in this paper.

Morphia. This drug, which is so largely used in practice to diminish the activity of the intestines, would seem to have a somewhat different effect in the dog, since a well-known result of its injection into this animal is the production of vomiting and evacuation of fæces. In the animals which were the subjects of one experiment and had received in all cases a moderate dose of morphia (6 to 12 centgrs.), the further injection of morphia had little or no effect on the intestinal movements, and the same conclusion is suggested by the conflicting statements of various authors as to the action of morphia on the dog's intestine. The effects observed were in fact so slight that they might be regarded as due to accidental variations in the conditions of the experiment.

Muscarin. According to Schmiedeberg, the injection of small doses of muscarin evokes strong peristaltic contractions extending over the whole of the gut due to stimulation of Auerbach's plexus. If atropin be injected, these movements at once cease owing to paralysis of the local nervous mechanism. Subsequent injection of physostigmin causes localised rings of constriction in consequence of direct stimulation

of the muscular fibres. The picture drawn by Schmiedeberg of the action of muscarin we can confirm. Injection of 0.3 c.c. of a 0.1 % solution causes a fall of blood-pressure with slowing of the heart and a strong constriction of practically the whole of the intestine, which becomes quite pale. This excited condition passes off after a time, but may be reinduced by another similar dose of the drug. If however a dose of 1.2 c.c. be given in the first instance, a second and third injection after the effects of the first have passed off has quite a different result. There is a slight rise of blood-pressure, and the intestinal contractions are apparently unaffected. With excessive doses, one may get an actual paralysis of Auerbach's plexus, but the local reflexes of the intestine persist after the excitatory effect of the muscarin has disappeared.

Atropin. The strong intestinal contraction produced by muscarin can be at once abolished by the injection of atropin. This however seems to be due rather to physiological antagonism between the two drugs than to a paralysis of any local nervous mechanisms, as was imagined by Schmiedeberg, since, as we have already mentioned, the local reflexes as well as the action of the splanchnics and the vagi on the intestines can be obtained after the administration of as much as 30 mg. atropin. We have not observed any very definite effect of this drug on the power or rhythm of the intestinal muscle.

Physostigmin. Injection of 25 mg. physostigmin, after the previous administration of muscarin and atropin, produced in the dog a slight transitory rise of blood-pressure but had no influence of any kind on the intestines.

Cocaine. This drug when directly applied to the intestine paralyses the local nervous mechanism, and so abolishes the local reflexes and the power of the intestine to move along a bolus. The intestinal contractions are increased, probably from a direct influence of the drug on the unstriated muscle fibres. There is at the same time a great and persistent rise of blood-pressure due to the absorption of the cocaine by the blood vessels of the gut. The paralyzing effect is transitory and passes off within 20—30 minutes after the coil of intestine has been returned to the warm saline bath.

Nicotin. If 0.3 c.c. of 1 % solution nicotin be injected into the jugular vein, after section of both splanchnics and vagi, there is the well-known enormous rise of blood-pressure accompanied by a complete inhibition of the rhythmic intestinal contractions. As the blood-pressure falls, the contractions recommence, only to cease again when another injection of

1.2 c.c. is given. With succeeding large doses of nicotin, the rise of blood-pressure at each injection becomes less, and the period of intestinal inhibition shorter, until finally the contractions are unaltered by another injection of nicotin. After giving 2 c.c. of 1% solution the contractions are somewhat increased in amplitude and extremely regular. As we have already mentioned however the local nervous mechanism is completely paralysed. This paralysis lasts from 20—30 minutes. At the end of this time feeble local reflexes of augmentation and inhibition may be obtained as well as the inhibitory effect of splanchnic stimulation. We have never observed any return of the vagus effect even after the injection of only 0.3 c.c. of the above solution. The inhibition produced by the injection of nicotin is due to an intense stimulation of the

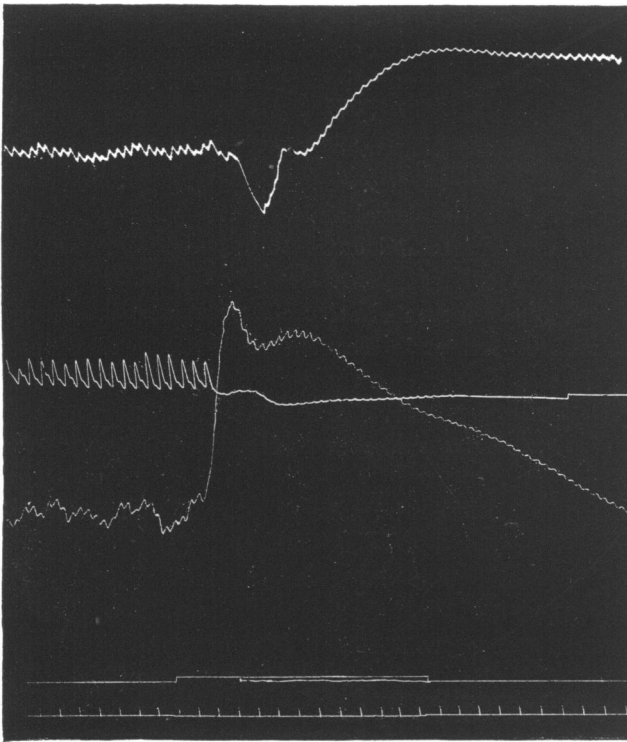

Fig. 29. Intestinal contractions and volume. To show that the inhibition produced by nicotin is associated with hyperæmia of the intestines, and is not therefore an effect of vascular constriction. From above downwards the tracings are: intestinal volume, intestinal contraction (balloon method), blood-pressure, marking showing period of injection. Time marking (6 secs.).

splanchnic fibres or of their last cell-stations, and not to the effect of the drug on the blood vessels. The intestinal inhibition persists for a considerable time during the condition of hyperæmia which follows primary contraction, though the hyperæmia would in itself tend to augment the intestinal movements.

NOTE ON THE DISTRIBUTION OF THE VAGUS IN THE ABDOMEN.

For the following description and drawing of the branches of the vagus in the dog we are indebted to Miss M. H. Naylor. The statements are based on the dissection of three dogs.

The two vagi after leaving the inferior cervical ganglia—though the left vagus arises above the corresponding ganglion—proceed backwards, crossing dorsal to the lung root, and reaching the œsophagus the right nerve takes its position on the dorsal, the left on the ventral surface of that viscus. A strong connecting branch between the two nerves passes obliquely behind the œsophagus on a level with the heart, besides the connection which takes place between them in the plexus gulæ.

In this manner, on the dorsal and ventral surfaces of the œsophagus, they pierce the diaphragm and enter the abdomen, where their courses are very different.

Left vagus. Almost immediately after piercing the diaphragm this nerve divides into numerous branches which are distributed to the ventral surface and lesser curvature of the stomach.

One considerable branch is given to the liver; running between the layers of the gastro-hepatic omentum it enters the transverse fissure of that organ.

The recurrent coronary branches to the œsophagus, described in human anatomy, are not always present.

Right vagus. After entering the abdomen this nerve runs backwards on the dorsal wall of that cavity behind the peritoneum and joins the solar plexus, while behind the stomach it gives several branches to the dorsal surface and great curvature of that organ, and a little way before it enters the plexus it sends two or three branches to the pancreas.

Before entering the plexus it divides; one part separates into numerous branches, all of which join the left semilunar ganglion; the other part does not end in the ganglion but crosses it, though more or less attached to it, at the same time dividing into branches which

for the most part run on the branches of the anterior (= superior) mesenteric artery, where they form long meshed plexuses with offsets of the solar plexus, which proceed to the intestine.

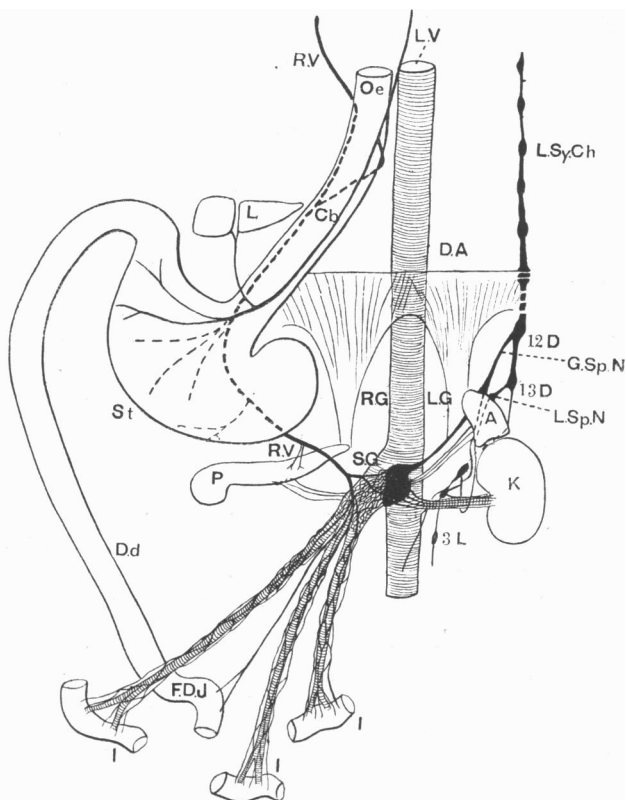

Fig. 30. DISTRIBUTION OF THE VAGUS IN THE ABDOMEN (M. H. Naylor).

RV, LV, right and left vagi. The right vagus runs behind the œsophagus (*Oe*) and stomach (*St*), and in those places is represented by a discontinuous line. *C.b.*, connecting branch between right and left vagi. *P*, pancreas. *Dd*, duodenum. *F. D. J.* flexura duodeno-jejunalis. *I, I, I*, intestine. *L*, liver. *K*, kidney. *A*, suprarenal capsule. *R. G.*, *L. G.*, right and left crura of diaphragm. *L. Sy. Ch.*, left sympathetic chain. *12 D*, *13 D*, twelfth and thirteenth dorsal ganglia. *3 L*, third lumbar ganglion. *G. Sp. N.*, *L. Sp. N.*, great and small splanchnic nerves. *S. G.*, left semilunar ganglion. *D. A.*, dorsal aorta.

One branch, after crossing the ganglion, proceeds alone, between the layers of the mesentery, not forming a plexus or running on an artery, and enters the wall of the intestine in the neighbourhood of the flexura duodeno-jejunalis.

CONCLUSIONS.

1. Two kinds of movements are to be distinguished in the small intestine, viz. the rhythmic pendulum movements, and the true peristaltic contraction.

2. The pendulum movements are due to rhythmic contractions affecting longitudinal and circular coats simultaneously. They recur about 10 or 12 times in the minute, and travel along the intestine at a rate of 2 to 5 cm. per second. They are myogenic in origin, and are probably propagated by means of the muscle fibres.

3. The peristaltic contractions are true coordinated reflexes, started by mechanical stimulation of the intestine, and carried out by the local nervous mechanism (Auerbach's plexus). They are independent of the connections of the gut with the central nervous system. They travel only in one direction, from above downwards, and are abolished on paralysing the local nervous apparatus by means of nicotin or cocaine.

4. The production of the true peristaltic wave is dependent on the unvarying response of the intestinal nervous mechanism to local stimulation, the *law of the intestine*. This law is as follows:—Local stimulation of the gut produces excitation above and inhibition below the excited spot. These effects are dependent on the activity of the local nervous mechanism.

5. Every point of the intestine is therefore subject to opposing influences transmitted to it along its wall, viz. inhibitory impulses from above, and augmentor or excitatory influences from below. The activity of the intestinal muscles at any time will depend on the relative influence of these two sets of impulses.

6. Besides these local influences, every point of the intestine is under the control of the central nervous system through the intermediation of the splanchnic and the vagus nerves.

7. The splanchnic nerves exercise a tonic inhibitory influence on the intestinal movements. Excitation of these nerves causes inhibition of the intestine affecting both longitudinal and circular coats. This inhibition is independent of the vaso-constrictor action of the splanchnics. We can obtain no satisfactory evidence that these nerves ever possess a motor function.

8. The vagus nerves contain two sets of fibres, inhibitory and augmentor. The inhibitory fibres have a short latent period, the augmentor fibres a long latent period. The action of the vagus on the

intestines is therefore twofold—an initial inhibition followed by augmentation which outlasts the excitation of the nerve. The action of the vagus on the intestines is unaltered by atropin, but is permanently abolished by a small dose of nicotin. It is very susceptible to the action of other inhibitory stimuli, and is rarely obtained unless these have been excluded by section of both splanchnics. The vagi have no tonic action on the small intestine.

March 17th, 1899.

[The greater part of the expenses of this research were defrayed by a grant from the Government Grant Committee of the Royal Society.]