

has been investigated through the same pressure range at seventeen temperature points between -20° and 200° .

Through a limited pressure range the degree of adsorption of gas is in fair agreement with the logarithmic isotherm equation of Freundlich, as has already been shown by previous investigators. At higher pressures (above 60 cm.), the adsorption rapidly decreases, indicating that at each temperature a maximum is reached which cannot be increased by increase of pressure.

No evidence was gained of the formation of a chemical compound, such as that obtained by Rhead and Wheeler in the adsorption of oxygen by charcoal, by the reverse reaction of carbon dioxide upon charcoal at relatively high pressures.

The adsorption of carbon dioxide at low temperatures is attended by certain phenomena which give rise to the possibility that a small quantity of the gas is absorbed in the charcoal structure, in accordance with the theory of McBain.

In conclusion, the writer wishes to express his thanks to the authorities of Cornell University for their kindness in placing at his disposal the facilities of the chemical laboratory of that institution for the purposes of this investigation.

ITHACA, N. Y.

[CONTRIBUTION FROM THE RESEARCH LABORATORY OF THE GENERAL ELECTRIC COMPANY, SCHENECTADY, N. Y.]

THE CONSTITUTION AND FUNDAMENTAL PROPERTIES OF SOLIDS AND LIQUIDS. II. LIQUIDS.¹

BY IRVING LANGMUIR.

Received May 23, 1917.

In Part I,² reasons have been given for believing that all the forces acting between atoms (or group molecules) in solid bodies are fundamentally similar in character and are of the nature of so-called chemical forces. Thus, evaporation, condensation, solution, crystallization, adsorption, surface tension, etc., should all be regarded as typical chemical phenomena.

¹ The fundamental idea of the orientation of group molecules in the surfaces and in the interior of liquids as a factor of vital importance in surface tension and related phenomena, occurred to me in nearly its present form in June and July, 1916. During August surface-tension data for over 250 substances were tabulated and studied. Work on oil films began in June. As a result of this extensive work, clear ideas were obtained as to the orientation of molecules in the surfaces of liquids and the relation between the total energy $\gamma_0 = \gamma - T d\gamma/dT$ and the chemical constitution of such substances as benzene and its disubstitution products.

An account of this work was given in some detail in a paper read at the New York meeting of the American Chemical Society in September, 1916, and a short abstract was published in *Met. Chem. Eng.*, 15, 468 (1916). In this abstract only the more

important conclusions were outlined, while the large amount of experimental data upon which these conclusions were based, were, unfortunately, not given.

On Oct. 27th, at the Cleveland meeting of the American Physical Society, I described the mechanism of surface-tension phenomena, and presented the data for γ_0 for about 100 typical substances, and pointed out in detail the arrangements of molecules of benzene substitution products, especially indicating the effects characteristic of the ortho, meta and para positions of a number of active and inactive groups. The bearing of this work on the hypothesis of the association of liquids was also pointed out.

Since this time I have found that Prof. W. D. Harkins has been developing an essentially similar theory of surface-tension phenomena. He has recently published two papers on this subject in *THIS JOURNAL*, 39, 354 and 541 (1917).

Nearly all the data in the second of these papers (except of course the new experimental data presented), had been worked over by me during the summer of 1916 and it was my intention to publish them together with the material now given in the present paper. Dr. Harkness, however, kindly sent me advance manuscript of his papers, and I have therefore been able to avoid duplication of his work. Harkins had expected that his two articles would appear simultaneously, and, as an unfortunate result he failed in his first article to mention my prior publication. In his second paper he refers to my work, but, by an oversight, fails to refer to the publication of my general results in *Met. Chem. Eng.*, although in the latter part of his paper (page 584) he refers to this abstract in a footnote in which he points out that his conclusions regarding the orientation of the benzene molecules in the surface are the same as mine.

Under these circumstances it is desirable to quote a part of the abstract in *Met. Chem. Eng.*, 15, 469 (1916), as follows:

"A theory of surface tension is now proposed in which the structure of the *surface layer of atoms* is regarded as the principal factor in determining the surface tension (or rather surface energy) of liquids. This theory is supported in the most remarkable way by all available published data on the surface tension of organic liquids.

"According to this theory, the group molecules of organic liquids arrange themselves in the surface layer in such a way that their active portions are drawn inwards, leaving the least active portion of the molecule to form the surface layer. By 'active portion' of a molecule is meant a portion which is characterized by a strong stray field (residual valence). Chemical action may be assumed to be due to the presence of electromagnetic fields surrounding atoms. Surface tension (or surface energy) is thus a measure of the potential energy of the electromagnetic stray field which extends out from the surface layer of atoms. The molecules in the surface layer of the liquid arrange themselves so that this stray field is a minimum.

"The surface energy of a liquid is thus not a property of the group molecules, but depends only on the *least active portions of the molecules* and on the manner in which these are able to arrange themselves in the surface layer.

"In liquid hydrocarbons of the paraffin series the molecules arrange themselves so that the methyl groups (CH_3) at the ends of the hydrocarbon chains form the surface layer. The surface layer is thus the same, no matter how long the hydrocarbon chain may be. As a matter of fact, the surface energy of all these many different substances from hexane to molten paraffin, have substantially the same surface energy, namely, 46 to 48 ergs per sq. cm., although the molecular weights differ very greatly.

"If, now, we consider the alcohols such as CH_3OH , $\text{C}_2\text{H}_5\text{OH}$, etc., we find that their *surface energies* are *practically identical with those of the hydrocarbons*. The reason for this is that the surface layer in both cases consists of CH_3 groups.

"With such substances as CH_3NO_2 , CH_3I , we find that the surface energy is much

greater than that of the hydrocarbons. This is due to the fact that the volume of the I or the NO_2 is so great that the surface cannot be completely covered by the CH_3 radicals. The forcing apart of these groups increases the surface energy.

"Particularly interesting relations are found with benzene derivatives.

"In benzene itself, the group molecules arrange themselves so that the benzene rings lie flat on the surface, since the flat sides of these rings are the least active portions of the molecules. The surface energy of benzene is about 65 ergs per square cm.

"If, now, an active group, such as OH, is substituted for one of the hydrogens in the benzene (forming phenol or carboic acid) this group is drawn into the body of the liquid *tilting the benzene ring up on edge* and raising the surface energy to about 75 ergs per sq. cm., which corresponds to the activity of the perimeter of the benzene ring. Thus *any active group* strong enough to tilt the ring up on edge raises the surface energy to about 75. Two active groups side by side (ortho position) have no greater effect than one. But two active groups opposite one another (para position) cannot both go wholly below the surface, so that the surface energy then becomes abnormally large (about 85 in case of *p*-nitrophenol). The substitution of methyl or ethyl groups in the benzene ring lowers the surface energy except where an active group in an adjacent position draws these groups below the surface.

"Some of the best evidence in support of the new theory is derived from experiments on thin films of oil on water or mercury. Oleic acid on water forms a film one molecule deep, in which the hydrocarbon chains stand vertically on the water surface with the COOH groups in contact with the water.

"Acetic acid is readily soluble in water because the COOH group has a strong secondary valence by which it combines with water. Oleic acid is not soluble because the affinity of the hydrocarbon chains for water is less than their affinity for each other. When oleic acid is placed on water the acid spreads upon the water because by so doing *the COOH can dissolve in the water* without separating the hydrocarbon chains from each other.

"When the surface on which the acid spreads is sufficiently large the double bond in the hydrocarbon chain is also drawn down on to the water surface, so that the area occupied is much greater than in the case of the saturated fatty acids.

"Oils which do not contain active groups, as for example pure paraffin oil, do not spread upon the surface of water."

² THIS JOURNAL, 38, 2221 (1916). On page 2230 of Part I the relationship between Werner's theory and the work on crystal structure was pointed out. The writer regrets that at that time he was not aware that P. Pfeiffer (*Z. anorg. Chem.*, 92, 376 (1915)) has previously published a short paper discussing crystal structure from the viewpoint of Werner's theory. This has since been called to the writer's attention by Dr. G. McP. Smith. Even before the publication of Pfeiffer's paper, however, the writer had pointed out the application of Werner's theory to crystal structure in a paper read before the American Physical Society at Washington, D. C., on April 24, 1915, and an abstract of this paper was published (*Phys. Rev.*, 6, 79 (1915)) a couple of weeks before Pfeiffer's article. The abstract contains the following reference to this subject: "Bragg has shown that the atoms of crystals are arranged according to a space lattice, the identity of the molecules being lost. The forces acting between the atoms are thus chemical forces. In the case of diamond, the tetravalent character of carbon is manifest from the structure, but in most cases the valency appears to be *divided* between several atoms. Thus, in sodium chloride the single valency of the sodium atom is divided between six chlorine atoms. There is a close connection between this theory and Werner's theory of valence."

R. B. Sosman, in a paper (*J. Ind. Eng. Chem.*, 8, 985 (1916)) which appeared

Before proceeding with the application of this viewpoint to a consideration of the structure of liquids it will be profitable to examine more closely than heretofore the distinctions between this theory and the more usually accepted theory, according to which the above listed phenomena are manifestations of physical forces.

“Physical” versus “Chemical” Forces.

When considering the action of forces between discreet particles in space, the physicist usually makes the simplifying assumption that each particle attracts or repels each other particle with a force which varies according to a function of the distance between the particles. Newton's inverse square law for gravitational attraction and Coulomb's law for the attraction or repulsion between electric charges, are familiar examples of such relations. Maxwell calculated the effect of temperature on the viscosity of gases on the assumption that molecules attract one another inversely as the square and repel inversely as the fifth power of their distance. Sutherland found that a formula in better agreement with the facts could be derived by assuming the molecules to be rigid spheres attracting one another with a force inversely as the n^{th} power of the distance.

Van der Waals' equation of state for gases is based on the assumption that molecules attract one another according to some function involving only the distance between them. This method of derivation tacitly assumes that the forces do not depend on the orientation of the molecules, and further assumes that the force acting between any two molecules is not influenced by the proximity of other molecules.

J. E. Mills, in a series of papers on the subject of “Molecular Attraction,”¹ has advanced the theory that the only force acting between molecules in gases and liquids is an attractive force which varies inversely as the square of the distance between molecules.

Bakker² has developed a theory of surface tension based on the assumption that the molecules of liquids attract one another according to an inverse exponential function of the distance. A somewhat similar theory of adsorption has been developed by Eucken.³

These are only a few examples of the cases in which the forces between the molecules have been considered to be radial forces which vary solely as a function of the distance between molecules. In all the cases cited above the investigator has considered the phenomena to be physical in nature.

nearly simultaneously with Part I of the present paper, has discussed the structure of silicates and other crystalline compounds from a viewpoint almost identical with that developed by the present writer.

¹ A dozen or more papers on this subject have appeared in the *J. Phys. Chem.*

² *Z. physik. Chem.*, **89**, 1 (1915).

³ *Verh. deut. physik. Ges.*, **16**, 345 (1914).

The chemist, on the other hand, in studying the properties of matter, usually employs totally different methods. He is often most interested in the qualitative aspects of a problem, and the quantitative relationships sought are usually limited to those deducible from the law of multiple combining proportions, the law of mass action or the principles of thermodynamics. When the chemist does consider the forces acting between atoms or molecules, he does not look upon these as forces of attraction between the centers of the molecules, but he thinks rather of the specific nature of the atoms forming the molecules and the manner in which these atoms are already combined with each other. He thinks of molecules as complex structures, the different portions of which can act entirely differently towards any given reagent. Furthermore, he considers that the forces involved in chemical changes have a range of action which is usually much less than the diameter of a molecule and perhaps even less than that of an atom.

Gurvich¹ distinguishes physical and chemical forces as follows:

"I. *Physical Force of Attraction:*

- (a) is not specific;
- (b) has unlimited range of action;
- (c) its action on a given mass is independent of the presence of other masses;
- (d) it does not act atomistically; that is, it acts on masses as a whole and not along definite directions.

"II. *Chemical Force of Attraction (Affinity):*

- (a) is specific;
- (b) its range of action is limited, probably to *atomic* distances;
- (c) its action upon a given mass depends upon whether or not the force is already practically 'saturated' by other masses;
- (d) it acts atomistically; that is, discontinuously in a few single rays or directions."

Gurvich considers that the forces involved in adsorption phenomena are not to be classed in either of these groups, but should rather be regarded as physico-chemical forces, as follows:

"III. *Physico-chemical Force of Attraction:*

- (a) is specific;
- (b) its range of action is limited to molecular distances;
- (c) its action upon a given mass is dependent on the presence of other masses;
- (d) it is not atomistic, but acts as a whole without division into separate rays or directions."

The point of view developed in the present paper leads us to the following conclusions:

A. Forces of the type which Gurvich has called Physical Forces do not play any important part in the structure of matter. The best examples of the physical forces are gravitation and the forces between electrically charged bodies. Gravitation is much too small a force to be of influence

¹ *Z. physik. Chem.*, **87**, 323 (1914).

in holding atoms and molecules together. In all ordinary matter the negative and positive electricity are so uniformly distributed throughout the mass that the effective range of these electric forces is only of atomic dimensions.

B. *All* the interatomic and intermolecular forces involved in the structure of matter are chemical forces; that is, they are of the same nature as the forces that the chemist has been studying in the past. In general, these forces are of two kinds: those represented by primary and those represented by secondary valence. Adopting a scheme similar to that proposed by Gurvich, the characteristics of these forces are:

IV. *Chemical Force (Primary Valence):*

- (a) is very specific;
- (b) its range of action is limited to distances comparable to the diameters of atoms;

When several atoms are combined together by primary valence, however, certain effects may be transmitted from atom to atom over distances several times the diameter of atoms;

- (c) its action depends entirely upon the degree of saturation of the atoms;
- (d) it acts atomistically, in definite directions;

V. *Chemical Force (Secondary Valence):*

- (a) is moderately specific;
- (b) its range of action is limited to atomic distances except where transmitted from atom to atom. The ranges of primary and secondary valences do not seem markedly different;
- (c) its action depends on the presence of neighboring atoms (Werner's co-ordination number), but not in such a definite way as in the case of primary valence;
- (d) it acts only between adjacent atoms, but usually not in directions radiating out from single atoms.

In the great majority of cases, as has been shown by Werner, the distinctions between primary and secondary valence are well defined. Many cases of transition occur between the two, however, so that hard and fast rules should not be adopted.

The theory of valence recently advanced by G. N. Lewis¹ seems to offer by far the most satisfactory picture of the mechanism of chemical combination that has yet been suggested. According to this theory the electrons in the outer shells of atoms tend to arrange themselves in groups of eight. There is also a very marked tendency for the electrons to group in pairs around positive charges. Thus, the stability of the hydrogen molecule and the helium atom is due to the existence of a stable pair of electrons. The neon atom contains an inner pair of electrons, with a stable group of eight electrons in the outer shell.

A carbon atom has four electrons in the outer shell. In the formation of methane the four electrons from four hydrogen atoms complete the group

¹ THIS JOURNAL, 38, 762 (1916).

of eight. These eight electrons gather into four pairs, each of which holds one of the hydrogen nuclei in about the same way as the two nuclei are held together in a hydrogen molecule. In the molecule thus formed we cannot say that positively charged hydrogen ions are held electrostatically by a carbon atom with four negative charges. The eight electrons belong as much to the hydrogen nuclei as to the carbon atom. The chemical union is brought about by the electrons *held in common* by all the atoms. Thus, methane is a non-polar substance.

Similarly, the structure of carbon tetrachloride is accounted for and it is readily seen why it too, does not have a polar character.

When sodium and chlorine combine, the single outer electron of the sodium atom, together with the seven electrons in the outer shell of the chlorine atom form the stable group of eight. In this case we have more reason to look upon the resulting compound as consisting of a negatively charged chlorine ion held by electrostatic forces to a positively charged sodium ion. Since the chlorine ion and the chlorine atom have radically different structures, however, it is not a useful conception to regard a chlorine ion as a charged chlorine atom.

This viewpoint leads us to a much clearer conception of the nature of primary and secondary valences.

Primary valence is the result of the tendency of the electrons to form groups of two or eight.¹ In the strongly polar compounds, electrons are transferred from the outer shells of the electropositive atoms to the outer shells of the negative atoms, in order to complete the stable groups of electrons. The primary valence relationships are dependent on the number of electrons that can be so transferred. In non-polar compounds, such as typical organic substances, a pair of electrons, held in common by two adjacent atoms, constitutes what we have usually represented by the single bond (primary valence).

When two or more atoms are thus combined by pairs of electrons held in common, there are still stray fields of force due to the electrons forming the outer shells of the atoms. Secondary valence is the result of these stray fields. The coördination number represents the number of groups which can arrange themselves in space around a given group. As was shown in Part I, a solid or liquid body (as, for example, a metal), may be built up of atoms held together exclusively by secondary valence.

From this viewpoint both primary and secondary valences are active in the formation of a crystal of sodium chloride. The transfer of the electron from the shell of the sodium atom to that of the chlorine atom involves

For the elements after the first two short periods it is evident that the electrons in the outer shell tend to arrange themselves in other ways than in groups of eight. We may expect, however, that Lewis' theory will soon be extended to cover these elements. Kossel's theory has made some progress in this direction.

primary valence. The two charged groups of electrons are then held together by their electrostatic fields to form the crystal (secondary valence). We thus see how, in a crystal, the arrangement of the atoms in no wise suggests the primary valence of the atoms, yet the chemical composition is in full accord with the ordinary rules of valence.

Not only Lewis's theory, but other recent theories of chemical valence, such as those of Stark, J. J. Thomson, and Kossel,¹ enable us to draw similar distinctions between primary and secondary valence.

Nothing definite is known regarding the forces acting on electrons inside of atoms. There seems to be increasing evidence that the electrons in atoms are not revolving in orbits around the positive nuclei, but should rather be regarded as stationary except when disturbed from their equilibrium positions by external forces. It may be, however, that a magnetic field (Parson's theory) is to be associated even with stationary electrons in the atom. If this viewpoint is correct, we can no longer fall back on the convenient centrifugal force to explain why the electrons do not fall into the positive nucleus.

The writer believes with G. N. Lewis that Coulomb's law fails at short distances. From the internal structure of atoms we may, however, draw certain conclusions as to the nature of this failure. Since the electrons remain apart from the nucleus, it is evident that positive and negative charges repel one another when brought sufficiently near. The tendency of electrons to form stable pairs in atoms seems to indicate that two negative electrons (at least under the influence of neighboring positive charges) attract one another when close together. Furthermore, it seems to be a reasonable hypothesis that an alpha particle consists of *two* hydrogen nuclei (positive electrons) which nearly coincide and therefore, according to the electromagnetic theory, possess nearly four times the mass of a single hydrogen nucleus. In this case we would also conclude that two positive electrons, when brought sufficiently close together, attract one another and form the very stable alpha particle.

From the viewpoint of these hypotheses, chemical combination by primary valence is the result of those as yet mysterious forces which cause electrons in atoms to be attracted together into pairs, or groups of eight.

The resulting molecules, or group molecules, have electrons arranged in definite ways in their outer shells. Thus, their surfaces should be looked upon as containing a large number of electric doublets and probably also magnetic doublets. When two molecules are brought close together, the doublets of one attract the doublets of the other and result in the attraction between the two molecules associated with the secondary valence.

It is evident, however, if we are to regard these secondary valence forces

¹ *Ann. Phys.*, [4] 49, 229 (1916).

as being due to doublets, that we should not expect the force between the molecules to vary simply as a function of the distance or to show other characteristics of the Physical Forces (I). For example, let us consider the case of simple doublets such as bar magnets. One magnet attracts another with a force that depends primarily on the relative orientation of the two magnets. If two magnets come close together so that the north pole of one comes close to the south pole of the other the action of these magnets on a third has in general been greatly reduced. On the other hand, if the two magnets are placed end to end the attraction for a third may be greatly increased. These relationships are more nearly of the kind that we expect among chemical forces between atoms, rather than among physical forces such as those described by Gurbich. Thus from purely theoretical grounds, if inter-atomic forces are due to the presence of doublets, we conclude that all forces involved in cohesion, surface tension, etc., should come under the division of "Chemical Forces."

Nevertheless, the assumptions that have been made by van der Waals, Eucken, Mills, Bakker, etc., in their studies of the so-called physical properties of matter are not wholly unjustifiable. When molecules are separated by distances large compared to their diameters, under conditions such that all possible orientations occur with nearly equal probability, then it is evident that the *average force* between molecules will, for practical purposes, be a function solely of the distance between them. When, however, the molecules approach so closely that they exert a marked orienting effect upon each other, then it is no longer justifiable, any more than it was in the case of the bar magnets, to consider that the forces vary as a function merely of the distance.

The errors resulting from the assumption that the force varies solely with the distance become less important when we are dealing with atoms in which there are many doublets on the surfaces, and these doublets are uniformly distributed over the surface and are of small intensity.

In the case of the so-called permanent gases these conditions are fairly well fulfilled; also in so-called non-associated liquids there is a rough approximation to these conditions, so that certain useful results may be obtained by means of the simplifying assumption that the force varies as a function of the distance. However, such results should only be expected to hold in the case of molecules having *symmetrical* force fields and only when the distances between molecules is sufficiently great.

In the majority of cases, such simplifying assumptions are not justifiable and for this reason the formulas derived often fail completely when applied to certain substances or over too wide a range of conditions. It will be shown in the present paper (Part III) that the so-called associated liquids are merely substances which conform particularly badly with the customary simplifying assumptions. From the viewpoint developed in these

pages such substances are in no wise to be regarded as abnormal. In other words, if we regard all the "physical properties" as resulting from chemical forces we are able to derive relationships which apply equally well to "normal" and to "associated" liquids.

The point that I wish to emphasize especially in the present paper is that such phenomena as cohesion, evaporation, crystallization, adsorption, surface tension, viscosity, etc., apparently do not involve any inter-atomic or "inter-molecular" forces other than the two kinds of force (IV and V) already familiar to the chemist.

The Relations between Solids and Liquids.

The differences between the properties of solids and liquids are much smaller than those between liquids and gases. The change in density in passing from the solid to the liquid state is insignificant in comparison with the change that occurs in passing from the liquid state to that of the gaseous (at ordinary pressures). Similarly, the compressibilities, coefficients of expansion, specific heats, refractive indices and other optical properties, dielectric constants, and thermal conductivities of solids and liquids do not differ very materially in comparison with those of gases. For example, the similarity of solid and liquid mercury is in marked contrast to the great differences between liquid and gaseous mercury. In the gaseous state the mercury is colorless, transparent and is a non-conductor of electricity, but the optical and electrical properties of solid and liquid mercury differ only slightly.

In fact, the only essential differences between liquids and solids seem to lie in the mobility of liquids and in those properties which are directly dependent on mobility. As a result of this mobility, the definite lattice arrangement of the atoms of solids gives way to the irregular arrangements characteristic of liquids. The viscosity and the shearing elasticity of liquids are of course totally different from those of solids.

Surface tension is a property which we usually associate only with liquids. There is no doubt but that solids possess surface energy and that the only reason that this does not manifest itself more clearly as a surface tension is that the solids do not possess sufficient mobility.

When a liquid shows electrolytic conductivity then the conductivity of the corresponding solid is usually much smaller because of the decreased mobility of the ions. But where the conductivity is metallic there is ordinarily no great difference between the conductivities in the two states.

From these considerations, it is evident that the forces involved in the structures of liquids are not essentially different from those of solids. We may also reach this conclusion (as was done in Part I), by arguing that amorphous and crystalline solids differ only as regards the regularity of the arrangement of their atoms, and by then considering that liquids

may be obtained by a continuous process from amorphous solids, if we merely increase the mobility by raising the temperature.

If the forces holding solid bodies together are chemical forces represented by primary and secondary valence, then there is every reason for believing that chemical forces are also responsible for holding the atoms and group molecules of liquids together. Conversely, all the experimental evidence we find regarding the chemical nature of the forces within liquids may be considered as additional evidence in favor of a similar theory for solids.

The mobility of a liquid is thus due to a shifting of the relative positions of atoms which are all chemically combined with each other.

This mobility of atoms within the chemical molecule is nothing more than the familiar phenomenon of tautomerism. In the field of organic chemistry, this phenomenon has attracted considerable attention because it seems to form such a marked exception to the behavior of most organic compounds. As Lewis has pointed, however, tautomerism is an almost universal characteristic of inorganic substances (in the liquid state).

It seems probable that tautomerism occurs much more frequently in secondary valence unions than in those involving primary valency. It therefore occurs at the boundaries of the group molecules of organic substances rather than within these groups. The only solid body which seems to be held together exclusively by primary valence is the diamond (and presumably other forms of carbon), and this substance has never been obtained in the liquid state.

According to this viewpoint the viscosity of liquids depends upon the frequency with which tautomeric changes occur between the atoms or at the boundaries of the group molecules. This aspect of the theory will be considered again under the heading, "Viscosity."

Oil Films on Water.

When a very small quantity of an oil, such as olive oil, is placed upon a large clean surface of water, the oil spreads rapidly upon the water surface until a definite area has been covered and then the oil shows little or no tendency to spread further. The writer's attention was first called to this remarkable phenomenon by reading an article by A. Marcellin¹ on the "Minimum Thickness of Oil Films on Water."

Miss A. Pockels² showed that very small amounts of oil on the surface of water have no appreciable effect on the surface tension, but that the surface tension begins to *decrease suddenly* when the amount of oil per unit area is increased beyond a certain sharp limit.

Lord Rayleigh³ repeated these experiments and clearly pointed out the

¹ *Ann. Phys.*, 1, 19 (1914).

² *Nature*, 43, 437 (1891).

³ *Phil. Mag.*, 48, 331 (1899).

importance of the phenomena, in the explanation of the mechanism of surface tension. In Miss Pockel's and in Rayleigh's experiments a very small amount of oil is placed on water contained in a long narrow trough. The oil is prevented from spreading over the whole surface by barriers consisting of strips of glass placed across the tray and resting on the edges. By sliding these barriers along the tray the area of water, on which the given quantity of oil may spread, can be varied at will. Rayleigh measured the surface tension of the contaminated water between the barriers by Wilhelm's method; that is, a thin blade was mounted in a balance, its plane being vertical and its lower horizontal edge dipping under the surface of the water. As the "thickness" of the oil film was varied by shifting the position of one of the barriers, the surface tension changed in the manner shown in Fig. 1,¹ which represents a curve obtained with a film of castor-oil.

Thus castor-oil only begins to have an appreciable effect on the surface tension of water when it is present in sufficient quantity to form a layer 1.3×10^{-7} cm. thick. When however, the thickness of the film is increased beyond this point (S in Fig. 1), then the surface tension rapidly falls as is shown by the portion of the

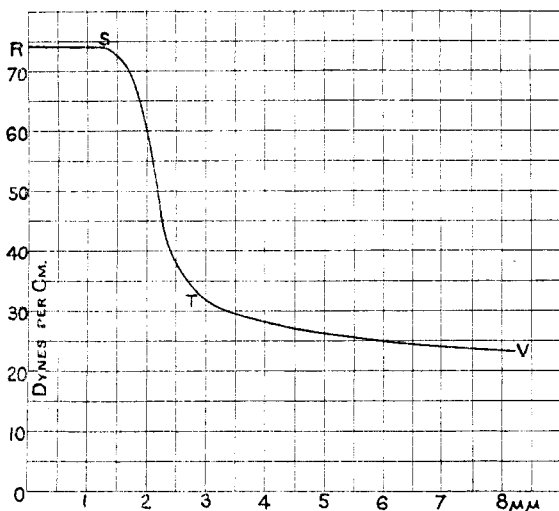

Fig. 1

Curve ST. From this point on, the surface tension changes only slowly (Curve TV). Rayleigh attributes the slight decrease between T and TV to a "want of homogeneity" in the oil, that is, to the presence of impurities. He says: "It would seem as if the surface still retained an affinity for some minor ingredient capable of being extracted, though satiated as regards the principal ingredient."

With olive oil Rayleigh found the thickness at which the tension begins to fall is 1.0×10^{-7} cm.

"Now this is only a moderate multiple of the supposed diameter of a gaseous molecule, and perhaps scarcely exceeds at all the diameter to be attributed to a molecule of oil. It is obvious therefore that the present phenomena lie entirely outside

¹ This curve is obtained from the data of Rayleigh as recalculated to absolute units by Freundlich, "Kapillarchemie," p. 279 (1909).

the scope of a theory such as Laplace's in which matter is regarded as continuous, and that an explanation requires a direct consideration of molecules.

"If we begin by supposing the number of molecules of oil upon a water surface to be small enough, not only will every molecule be able to approach the water as closely as it desires, but any repulsion between molecules will have exhausted itself. Under these conditions there is nothing to oppose the contraction of the surface—the tension is the same as that of pure water."

If the molecules "behave like smooth rigid spheres of gaseous theory, no forces will be called into play until they are closely packed. According to this view the tension would remain constant up to the point where a double layer commences to form. It would then suddenly change, to remain constant at the new value until the second layer is complete. The actual course of the curve of tension deviates somewhat widely from the above description, but perhaps not more than could be explained by heterogeneity of the oil whereby some molecules would mount more easily than others, or by reference to the molecular motions which cannot be entirely ignored. If we accept this view as substantially true, we conclude that the first drop in tension corresponds to a complete layer one molecule thick, and that the diameter of a molecule of oil is about 1.0×10^{-7} cm."

Rayleigh thus believes that the point S (Fig. 1) corresponds to a layer one molecule deep and implies that the point T corresponds to a double layer of molecules.

Henri Devaux¹ has extended this work and has developed experimental methods for the study of oil films which are beautiful in their simplicity and remarkable in the clearness with which they demonstrate the existence of monomolecular oil films.

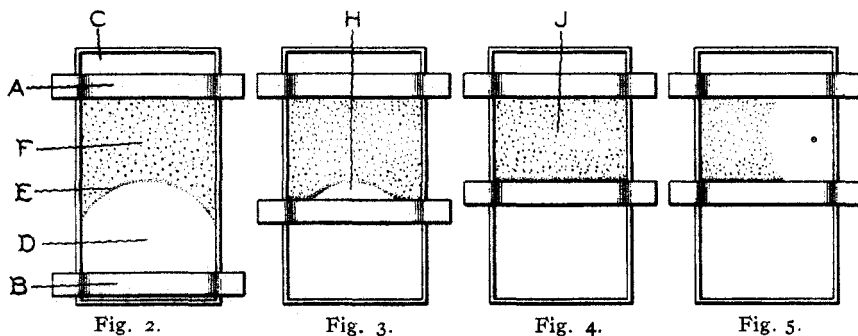

A photographic tray (Fig. 2) is half filled with water and a little clean powdered talc is dusted (through a piece of cloth) onto the surface. By blowing gently upon the surface, the talc, together with all accidental contamination, is blown to the further end of the tray. A strip of paper A, is then placed upon the surface of the water and held by the thumbs against opposite sides of the tray. By pushing along this barrier all the

¹ Devaux has published a large number of papers between 1903 and 1914. A review of his work up to 1913 was published in the annual report of the Smithsonian Inst., 1913, p. 261. Subsequent papers are *Soc. franc. phys.*, 55, 3 (1914), and *Ibid.*, 57, 3 (1914).

oily contamination is forced into the position C (Fig. 2), while the surface below A is a perfectly clean surface of water.

This clean surface is now lightly dusted with talc. A fine wire is dipped in the oil and any visible drop hanging to it is removed. The end of the wire is then touched to the center of the talc-covered water surface. Immediately the talc is pushed back from wire, forming a circular area of apparently clean water. If only a small amount of oil is applied this circle grows only to a limited size. If oil is similarly applied to another part of the talced surface another circle will be formed without causing distortion of the first, unless the two circles come in contact. This proves that the surface tension of the oil covered water within the circles is the same as that of the clean talc covered surface.

Another experiment is still more instructive. Let us clean the surface as before and then sprinkle talc upon it. By blowing gently upon the water *all* the talc is readily pushed up against the barrier A. Now apply a very small amount of oil and then dust the oil contaminated surface with talc. By then blowing upon the water at the point D (Fig. 2) the talc moves back to the position E, but no further. The clear area about D is evidently clean water, while the talc-covered area F is covered by an oil film. The oil film thus covers a perfectly definite area without having any effect on the surface tension. To measure this area accurately it is only necessary to straighten the lower edge of the area F by means of the paper strip B. To accomplish this, blow continuously upon the surface (at D) while the strip B is advanced to the position shown in Fig. 3. Upon moving the barrier further the clear area H suddenly disappears as shown in Fig. 4. If the strip is moved still further the oil film behaves like an elastic stretched membrane and can be compressed or expanded at will. But if the lower barrier is pulled back below the position shown in Fig. 4 then the oil-covered surface ceases to expand and no longer follows the motion of the barrier.

This whole behavior is very similar to what we should expect if we had a tray with the bottom half covered by shot. By a movable partition all the shot can be pushed to one end or the other, but in any case they cover a definite area on the bottom of the tray. If we imagine the shot to be somewhat compressible and the tray to be subjected to vibrations of small amplitude (thermal agitation of molecules), so that some of the shot can more easily mount up on the others, then we seem to have a complete analogy to the phenomena described above.

Devaux has determined the areas covered by monomolecular films from weighed amounts of oils. To do this he prepares a dilute solution (1:1000) of the oil in pure benzene and places one or two drops of this solution upon the surface of the water. The benzene evaporates and leaves the oil. Knowing the volume of the oil added in this manner and the area covered

by it, the thickness of the film is readily calculated. Devaux considers that this thickness represents the diameter of the molecule. In the case of triolein, he finds this thickness to be 1.1×10^{-7} cm. From Perrin's value for the Avogadro's constant and from the molecular weight and density of triolein, he calculates that the theoretical value for the diameter of a molecule of triolein should be 1.13×10^{-7} cm.

This result, considered together with whole behavior of the thin films, affords very conclusive proof that these films are really one molecule deep.

Devaux has studied films of solid substances by dissolving these in benzene. He finds that these also form monomolecular films and even in this condition, exhibit the properties of solids. That is, the films possess a transverse rigidity which disappears as soon as the amount of substance per unit area is less than that corresponding to the monomolecular film. From this fact Devaux derives "This general conclusion: the characteristic mechanical properties corresponding to certain states of a body, the surface tension of a liquid or the rigidity of a solid, persist almost intact down to molecular thicknesses, disappearing abruptly the minute we go further."

The work of Rayleigh and Devaux has not attracted the attention which it deserves. The above conclusion of Devaux's, so well supported, in some cases, at least, by experimental facts, is not at all in accord with the commonly accepted theories of surface tension, but it is exactly in line with the theories of adsorption, catalytic action, etc., which have been outlined in Part I of this paper.

Marcelin¹ describes some interesting experiments with films of oleic acid. A monomolecular film made visible by talc was produced in the manner indicated by Figs. 2, 3 and 4. Then a drop of oleic acid of considerable size was placed on one side of the oil-covered surface (Fig. 4). Immediately the drop of acid spread out, pushing back the talced surface, as indicated in Fig. 5, to about one-half its original area. Marcelin reasoned that the monomolecular film had been changed to one two molecules thick. He generalized this conclusion and claimed that with all oils, a layer one molecule thick had no effect on the surface tension of water, while a layer two molecules thick could remain in equilibrium with a large globule of oil. This conclusion was also in accord with the observations of Rayleigh.

Devaux, in replying to Marcelin's paper, claimed that the ratio between the two areas (Fig. 5) was never as great as 1 : 2. For oleic acid he found 1 : 1.8, and for other oils, values of about 1 : 1.3. He therefore concluded that these thicker films were not two molecules thick, but were monomolecular films with closer packing of the molecules.

¹ *Loc. cit.*

Labrouste¹ obtained monomolecular films of palmitic and stearic acids, and of myristin, laurin, stearin, palmitin, benzoin, cetyl alcohol, etc. Sulfur and triphenylmethane could not be made to form monomolecular layers.

Cause of the Spreading of Oils on Water.

To make further progress in the study of oil films, it is important to know what is the cause of the spreading of the oil upon the water. The problem is very greatly simplified by the knowledge that the films formed are one molecule thick.

It is natural to assume that the force which causes the spreading is due to an attraction between the group molecules of the oil and those of the water. From the chemical viewpoint developed in Part I of this paper, we should not regard this attraction as emanating from the molecule as a whole, but rather from certain atoms in the molecule. This would follow directly from our conclusion that the range of forces between atoms or molecules is of the order of 0.6×10^{-8} cm. Furthermore, it is evident that any attraction of the water for oil molecules *as a whole* would manifest itself as a solubility of the oil in the water. If, on the other hand, we can assume that a *portion* of the oil molecule is attracted to the water, while the remainder is more attracted to other oil molecules than to the water, then we have a ready explanation of the spreading on the water.

Let us consider oleic acid as an example. There is no doubt but that the carboxyl group has a marked affinity for water. The solubility of the organic acids in water, as compared with the insolubility of the corresponding hydrocarbons, is a clear indication of this fact. This affinity is due to the strong secondary valence characteristic of oxygen compounds. On the other hand, hydrocarbons have a greater affinity for each other than for water, since they are usually miscible with each other in nearly all proportions, although they are insoluble in water.

Therefore, when oleic acid is placed on water, it is probable that the carboxyl groups *do actually dissolve* in water; that is, they combine with the water chemically (by secondary valence). The long hydrocarbon chains have too much attraction for each other, however, and too little for water, to be drawn into solution merely because of the affinity of the carboxyl for the water.

As a matter of fact, by the spreading of the oil on the surface as a monomolecular layer, the carboxyl group can combine with all the water it requires, without causing the hydrocarbon chains to separate from one another.

The spreading of an oil upon water is thus due to the presence of an "active group" in the molecule; that is, some group which has a marked affinity (secondary valence) for water. This leads directly to the pre-

¹ *Compt. rend.*, 158, 627 (1914).

diction that an oil without active groups, such as pure paraffin oil, should not spread at all. Experiment shows that this is actually the case. Hardy¹ has studied the spreading of many oils upon water and found that pure saturated hydrocarbons do not spread; neither do such substances as benzene, cymene, etc. In attempting to explain this fact, Hardy says, "The great chemical stability of the paraffins makes chemical interaction with water impossible. Some degree of chemical action would seem to be necessary to make one fluid spread as a film between two others (air and water)." He does not, however, go further than this in explaining the mechanism of the spreading. Hardy believes that the oil films are usually many molecules thick.

According to our theory of the spreading of oil films, the group molecules of oleic acid arrange themselves upon the surface, so that each carboxyl group is in contact with and is combined with water, while the hydrocarbon tails are packed in side by side and vertically placed above the carboxyl layer. The upper surface of the oil film thus consists of CH_3 groups. It is therefore evident that there should be no particular tendency for another layer of oil molecules to spread out on top of the first to form a second layer. In fact, since this upper surface consists exclusively of CH_3 (or C_2H_5) groups, while in a globule of oleic acid, carboxyl groups are distributed through the mass, it is natural that the oil should prefer to remain as globules, rather than spread out as a layer two molecules deep. In the mass of liquid the carboxyl groups probably tend to gather into clusters, because of the greater affinity of these groups for each other than for the hydrocarbon chains. This tendency to form minute clusters explains many of the phenomena observed by Devaux in connection with his study of films thicker than monomolecular.

Now Marcelin claims that oil films in equilibrium with globules of oil consist of double layers of molecules—a result inconsistent with the above theory. The best example that Marcelin finds in support of his theory is oleic acid. The molecule of this substance contains, besides the hydrocarbon chain, two distinguishing factors: the carboxyl group and the double bond. The marked difference between the freezing points and other properties of oleic and stearic acids, suggests that the double bond may play an important role in the spreading of oils on water.

In general, from the data available, it seems that the presence of a double bond increases the solubility of a compound in water. Thus ethylene and propylene are several times more soluble in water than ethane and propane. Crotonyl alcohol, $\text{C}_4\text{H}_7\text{OH}$, is soluble in about 6 parts of water, while butyl alcohol, $\text{C}_4\text{H}_9\text{OH}$, requires 12. Hexanyl alcohol is given as "very soluble," while hexyl alcohol is "slightly soluble."

This suggests that the double bond as well as the carboxyl groups,

¹ *Proc. Roy. Soc.*, **86A**, 610 (1912).

may be drawn down onto the surface of the water, if there is only a limited amount of oil on a large surface of water. When a globule of oil is placed on a limited surface, however, the carboxyl groups displace the double bonds. Thus the film is one molecule deep, but in the first case the molecules are partly reclining on the surface, while in the second they are packed tightly side by side and are more or less erect upon the surface.

Fortunately, the experiments with oil films furnish means for testing this theory. Rayleigh, Devaux, and Marcelin determined the thickness of oil films and assumed this to be the same as the diameter of the molecule of oil. From the present theory we are led to believe that molecules of oil on water are oriented and packed in the surface layer so that they cannot, even approximately, be regarded as spherical. We can, however calculate the area covered by each molecule as easily as we can calculate the thickness of the film. This area is equivalent to the average cross-section of the molecule in a plane parallel to the surface of the water. The thickness of the film is equivalent to the length of the molecule in a direction perpendicular to the surface.

If the square root of this cross-section differs materially from the thickness of the film, we have direct evidence that the molecules are not spherical.

Determinations of the Shapes of Group Molecules.

In order to determine the cross-sections and lengths of molecules in oil films, experiments similar to those of Marcelin were undertaken. The oil, or solid fat, was dissolved in freshly distilled benzene (usually 50 mg. in 100 cc.), and, by means of a calibrated dropping pipet, one or two drops of the solutions were placed upon a clean water surface in photographic tray. The maximum area covered by the film was measured by the method indicated in Figs. 2, 3 and 4.

TABLE I.
Preliminary Measurements of Cross-Sections and Lengths of Molecules.

Substance	Formula	I.	II.	III.	IV.
		Cross-section. Sq. cm.	$\sqrt{\text{Cross. sec.}}$ Cm.	Length. Cm.	Length per carbon atom.
Palmitic acid	$C_{16}H_{31}COOH$	21×10^{-16}	4.6×10^{-8}	24.0×10^{-8}	1.5×10^{-8}
Stearic acid	$C_{17}H_{35}COOH$	22×10^{-16}	4.7×10^{-8}	25.0×10^{-8}	1.39×10^{-8}
Cerotic acid	$C_{25}H_{51}COOH$	25×10^{-16}	5.0×10^{-8}	31.0×10^{-8}	1.20×10^{-8}
Tristearin	$(C_{18}H_{35}O_2)_3C_3H_5$	66×10^{-16}	8.1×10^{-8}	25.0×10^{-8}	1.32×10^{-8}
Oleic acid	$C_{17}H_{33}COOH$	46×10^{-16}	6.8×10^{-8}	11.2×10^{-8}	0.62×10^{-8}
Triolein	$(C_{18}H_{33}O_2)_3C_3H_5$	126×10^{-16}	11.2×10^{-8}	13.0×10^{-8}	0.69×10^{-8}
Trielaidin	$(C_{18}H_{33}O_2)_3C_3H_5$	120×10^{-16}	11.0×10^{-8}	13.6×10^{-8}	0.72×10^{-8}
Cetyl palmitate	$C_{15}H_{31}COOC_{16}H_{33}$	23×10^{-16}	4.8×10^{-8}	41.0×10^{-8}	2.56×10^{-8}
Myricyl alcohol	$C_{30}H_{61}OH$	27×10^{-16}	5.2×10^{-8}	41.0×10^{-8}	1.37×10^{-8}

Dividing this area by the number of molecules of oil on the surface, the area of water covered by each molecule is readily obtained. This must also equal the cross-section of the molecules. The results are given

in the first column of Table I. The number of molecules of oil on the surface was found by first calculating the number of gram-molecules of substance in the one or two drops of benzene solution added, and then multiplying this by N , the number of molecules per gram molecule, which, according to Millikan, is equal to 6.062×10^{23} .

An examination of these results shows that the cross-sections of the molecules vary over quite a wide range—from 21 to 126×10^{-16} sq. cm. The three saturated acids, palmitic, stearic, and cerotic, all occupy nearly the same areas ($21-25 \times 10^{-16}$ sq. cm.), notwithstanding the fact that the number of carbon atoms in the molecules increase from 16 to 26. Each tristearin molecule covers a space of 66×10^{-16} , which is exactly three times that of a stearic acid molecule. Furthermore, the molecule of cetyl-palmitate takes up an area of 23×10^{-16} sq. cm., which is again about the same as that of stearic acid.

Thus we see that each $\text{—}\overset{\text{O}}{\parallel}{\text{C}}\text{—}$ group occupies an area of about 23×10^{-16} sq. cm., no matter whether it occurs in an acid or in an ester. This area is substantially independent of the length of the hydrocarbon chain to which the active group is attached.

These measurements afford striking proof of the theory outlined in the preceding pages, according to which the spreading of an oil on water is caused by the presence of certain active groups in the molecule.

We may also calculate the length of the molecules in a direction perpendicular to the surface. The volume of each molecule is found by dividing the "molecular volume" of the oil (M/ρ) by the Avogadro constant N . By dividing this volume by the cross-section of each molecule, the length of the molecule in a direction perpendicular to the surface can be obtained. The results are given in the third column of Table I.

It is interesting to compare these lengths with the cross-sections. As a rough approximation we may assume that the dimensions of the molecule in directions parallel to the surface can be found by taking the square root of cross-section. This is equivalent to assuming that each molecule in the surface film occupies a volume represented by a square prism with its axis vertical. The length of the square side, which we shall refer to as the average diameter, is given in the second column of Table I, while the height of the prism (or the length of the molecule) is given in the third column.

It is seen at once that the molecules are very much elongated. Thus the length of the palmitic acid molecule is about 5.2 times the average diameter. The results prove that the molecules arrange themselves on the surface with their long dimension vertical as is required by the theory.

The molecule of tristearin has the same length (perpendicular to the surface) as the stearic acid molecule, but three times the cross-section.

Thus each of the three active groups has been drawn down on to the surface of the water while the hydrocarbon chains are packed in side by side and are erect upon the surface.

The case of cetyl palmitate is interesting. Here the length of the molecule is 41×10^{-8} cm., or nearly twice that of the palmitic acid molecule, while the average diameter is only 4.8×10^{-8} cm., or about the same as the palmitic acid molecule. The molecule contains two long hydrocarbon chains connected by a carboxyl group. In palmitic acid the length of such a group is 24×10^{-8} cm. If the length of this group were nearly a constant quantity then we should have to assume that in the cetyl palmitate film the two chains in each molecule are arranged one above the other with the carboxyl in the middle. On this assumption, however, the only part of the molecule in contact with the water would be the CH_3 on the end of one of the hydrocarbon chains, so that there should be no tendency for this substance to form a monomolecular film on water. Solid paraffin for example dissolved in benzene and placed on water does not give a monomolecular film but gives a thick film (10-40 molecules thick), of variable thickness depending on the rate at which the benzene is allowed to evaporate.

The present theory therefore compels us to conclude that the carboxyl group of the cetyl palmitate is on the surface of the water and that both hydrocarbon chains are packed in side by side above the carboxyl group. The area of water covered by the carboxyl is the same as in the palmitic acid so that the two hydrocarbon chains side by side do not have any greater cross-section than the one in the palmitic acid. But each chain is extended to nearly twice the length in the first case that it is in the second.

This result indicates that the hydrocarbon chain does not have any definite shape or arrangement of its atoms in space, but rather that the chain should be regarded as extremely flexible. Thus in the palmitic acid film the arrangement of the atoms in the chain is probably somewhat as follows:

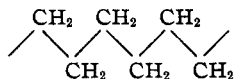

while in the cetyl palmitate the chains are packed more closely so that the arrangement becomes more nearly that represented by the typical formula:

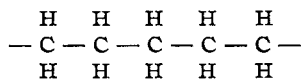

In a diamond the distance between adjacent carbon atoms is 1.54×10^{-8} cm. and this probably represents the minimum distance within which carbon atoms can approach. In the hydrocarbon molecule we should expect that they would be considerably further apart than this.

Dividing the length of the molecule (Table I) by the number of carbon atoms in the chain we obtain the average *vertical distance* between adjacent carbon atoms in the chain. The results are given in the fourth column of Table I. In all cases except that of cetyl palmitate the distance is less than the distance between atoms in the diamond. This is a clear indication that the atoms cannot be arranged linearly but rather must be arranged along a zig-zag or curved line. The observed cross-section (23×10^{-16} sq. cm.) is ample to allow the carbon atoms to be arranged in some such manner and still be separated from each other by distances greater than 1.54×10^{-8} cm.

The results obtained with the substances containing unsaturated hydrocarbon chains afford striking confirmation of the theory already proposed, according to which the double bond is to be regarded as an active group. Each oleic acid molecule covers a surface of 46×10^{-16} sq. cm. whereas the saturated acids only cover about half as great a surface. This same difference is manifest in triolein and trielaidin when compared with tristearin. The data given in the fourth column shows this effect even more clearly. Whereas with all the saturated molecules the average vertical distance between carbon atoms is greater than 1.2×10^{-8} , it lies between 0.62 and 0.72×10^{-8} for the unsaturated molecules.

We thus have a proof that the film in equilibrium with a globule of oleic acid on water, which Rayleigh and Marcelin supposed to be two molecules thick, is in reality only one molecule thick. Marcelin found that the film in equilibrium with the globule was about twice as thick as that obtained with the maximum extension. Since the latter is clearly one molecule thick Marcelin concluded that the former must be two molecules thick.

From the data of Table I, however, we see that an oleic acid film, in maximum extension, is only half as thick as that of stearic acid, so that, when doubled in thickness by placing a globule of oleic acid on the surface, the film becomes of the same thickness as that of stearic acid and the cross-sections of the molecules are also the same. There is thus no reason for assuming the existence of a layer two molecules deep.

These preliminary experiments furnish very convincing evidence of the correctness of the theory developed in the present paper.

To make further progress it became desirable to measure the forces involved in the spreading of oils, in other words to measure the changes in surface tension produced by oil or fat films. Rayleigh and Hardy had used Wilhelm's method, but this method cannot be employed for measuring the forces exerted by solid films and even for liquid films great difficulty is caused by the glass or mica plates becoming greasy so that the angle of contact no longer remains zero.

In carrying out measurements of the areas covered by oil films by

Devaux's method one is struck by the magnitude of the forces acting on the paper strips. If the strips are not very firmly attached to the edges of the tray, they may be pushed out of position when a drop of oleic acid is placed on the water. It occurred to the writer that a very satisfactory method of measuring the forces could be developed by a horizontal balance arranged to weigh the force acting on one of these paper strips.

This new method not only avoids the difficulties in connection with contact angles and solid films, but has the marked advantage that it affords a highly sensitive and accurate *differential* method of measuring slight changes in the surface tension of water.

A diagrammatic representation of the apparatus used for this purpose is given in Fig. 6. The water is placed in an enamelled tray, T, which is

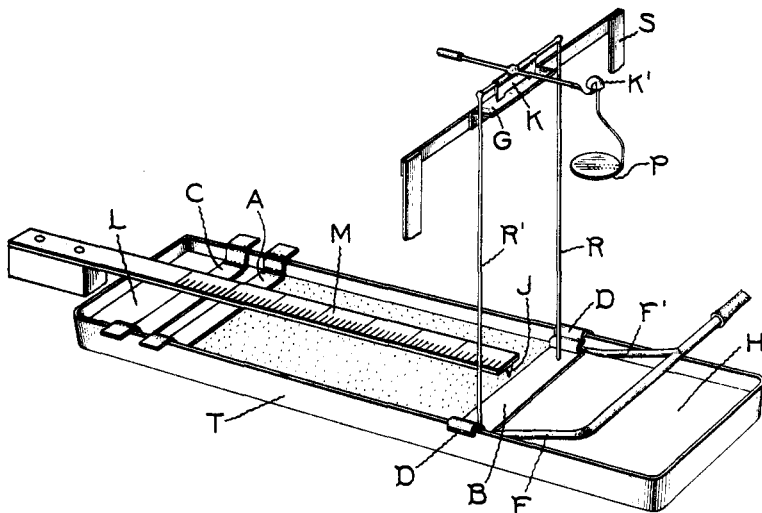

Fig. 6.

about 60 cm. long and 15 cm. wide. Above the tray is arranged a small balance with knife edge K resting on a glass plate, G, fastened to a support, S. One end of the beam of the balance has a counter-weight while the other has a small knife edge, K', from which hangs a small pan, P. Two glass rods R and R', cemented to the knife edge, extend downwards and pass through two small holes in a strip of paper, B, which floats upon the surface of the water in the tray. To prevent the paper from being softened by the water it may be prepared by dipping in a solution of paraffin in benzene.

The length of the paper strip B is about five mm. less than the width of the tray, so that it can move freely without touching the sides of the tray.

The surface of the water between the strips A and B is covered by an oil

film by placing one or two drops of a benzene solution of the oil on the water.

As the strip A is moved forward the oil film is pushed ahead of it until it begins to exert a force on the paper strip B. This force also tends to make the oil film flow around the ends of the strip B into the space H behind the strip. To prevent this, two air jets are directed by the tubes FF' against the surface of the water between the ends of the strip B and the sides of the tray. The air blast is regulated and maintained constant by allowing a portion of the air to escape from a tube dipped to a given depth in water. Two pieces of sheet metal D and D' are attached to the edges of the tray confining the air blast as much as possible to the surface of the water at the ends of the strip B.

Before beginning an experiment the air blast is started, impurities on the surface H are blown to the other side of B, and this surface of the water is cleaned by scraping with a strip of paper, C. All contaminating films are thus forced into the space I, from which they may be removed on to small pieces of paper dipped into the water. The air pressure or the balance is so adjusted that the center of the edge of the strip B is directly below the point J, which is fastened to the end of the meter stick M.

A weight of 50 mg. is placed on the pan of the balance. This causes the rods R with the strip B to move (to the left in the diagram) until they strike a stop, which is not shown in the figure. The strip A is placed on the surface and is moved along until it is close to the strip B, to see if there is any residual contamination of the surface. Usually when A is brought within 5-10 mm. of B the latter is caused to move along with A because of residual contamination. When the edge of the strip is under the point J, the force exerted by the oil film must be equal to the weight in the pan P, multiplied by the ratio of the lever arms of the balance (about 1 : 3). The distance between the strips A and B is then read off on the meter stick M, avoiding paralox by observing the reflection in the water surface. In this way the amount of residual contamination is determined. Owing to oil contained in dust in the air which settles on the surface, and to oil which adheres to the sides of the tray from previous experiments it is difficult to entirely avoid this contamination. However, by scraping the surface a few times after each experiment the amount of this contamination can be reduced to less than 1 cm. with 50 mg. on the pan, or one or two mm. with 500 mg. This amount is practically negligible.

After thus making sure that the surfaces are clean one or two drops of the benzene solution are placed on the water between A and B and a 50 mg. weight is placed on the pan. Strip A is then moved along until the oil film produces sufficient pressure against B to bring it under the equilibrium point J. A reading on the meter stick is taken. Then another 50 mg. weight is applied and the strip A is again moved until equilibrium

is reached. Weights of 50, 100 or 250 mg. are thus added successively until the oil film has been compressed into a space of a few millimeters.

As a result of these measurements the force acting on the strip A may be plotted as a function of the area included between the strips A and B. A typical curve is that shown in Fig. 7.

The weights applied to the pan are plotted as ordinates while the distances in cm. between A and B are plotted as abscissas.

When the area is greater than a certain rather definite limit, Q, there is practically no force acting on the balance but as the area is decreased the force rapidly increases until it reaches a limiting value at the point H.

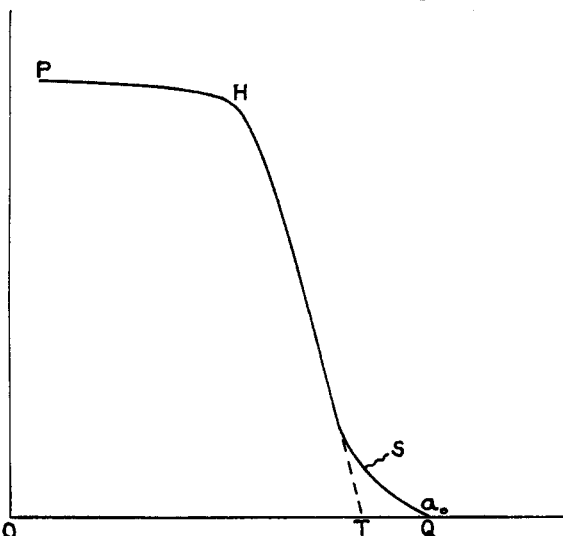

Fig. 7.

Both solid and liquid films were studied. With such a substance as palmitic acid, the surface of the water (as evidenced by dust particles) remains mobile only until the point S, Fig. 7, is reached. The whole surface then becomes rigid, that is, all dust particles on the surface become fixed in their relative positions. As the film is compressed beyond this point the whole surface moves as an elastic membrane. The film itself however, remains entirely invisible until a point beyond H is reached, when the solid surface begins to crumple and a peculiar appearance (strain lines) is often observed on the surface.

On the other hand, liquid films such as those produced by cetyl alcohol, or oleic acid, preserve their mobility even when compressed up to very small fractions of their original areas.

After a solid film has been crumpled up beyond the point H it will not expand again upon removing the pressure. The liquid films will spread out, but with marked hysteresis effects. To avoid these, all the measurements were made in regular sequence increasing the weights by regular increments. However, the curves obtained by adding 50 mg. at a time were usually not materially different from those formed with 250 mg. increments.

Experimental Results on the Forces Required to Compress Surface Films.

A large number of fatty acids, alcohols, and esters have been studied by this method. Some of the results are given in Figs. 8 to 18. The curves are based on observations like those represented in Fig. 7, but the coördinates are expressed in different units. The areas of water covered by the films were divided by the number of molecules of oil added, and the areas per molecule in sq. cm. were thus calculated. These are plotted as abscissas while the forces acting on the films are expressed in dynes per cm. and are plotted as ordinates. The unit used for the abscissas of the curves is 10^{-16} sq. cm. per molecule.

In referring to these and similar curves in the following discussion we shall use a to denote areas per molecule and F to denote the force in dynes per cm. with which the film resists compression. The coördinates of any particular point on the curve we shall indicate by subscripts, thus the coördinates of the point H in Fig. 7 are F_H and a_H . The letter H is used to denote a kink in the curve at which the slope (as a decreases) becomes *horizontal* or nearly so. The letter V denotes a kink where the slope suddenly increases so that the curve tends to become *vertical* (for example in Fig. 11). The value of a corresponding to the point O will be usually denoted by a_o , since the ordinate of this point is $F = 0$.

The substances studied by this method included acids, alcohols and esters of saturated and unsaturated aliphatic hydrocarbons.

The materials used differed very considerably in purity. The samples of lauric, palmitic, stearic and oleic acids, and the ethyl palmitate were of high purity and were kindly given by Prof. W. D. Harkins. Arachidic, myristic, cerotic and erucic acids, cetyl and ceryl alcohol, ethyl palmitate, amyl stearate and cholesterol were furnished from the chemical museum of Columbia University through the kindness of Prof. J. L. R. Morgan. The amyl stearate, arachidic acid and ethyl palmitate appeared to be of high purity, but the erucic and myristic acids and cholesterol were of doubtful purity. Samples of myricyl alcohol, cerotic acid, cetyl alcohol and cetyl palmitate, and oleic acid, of a high degree of purity, were prepared in this laboratory by Mr. Harold Mottsmith. Samples of myricyl and cetyl alcohols, oleic, cerotic, myristic, arachidic and linoleic acids were purified by fractional distillation in very high vacuum (pressure lower than 0.0001 mm. of mercury). Samples of linoleic and linolenic acids from a well-known manufacturer (in sealed tubes) were also available. The specimens of triolein, trielaidin, tristearin, and ricinoleic acid were prepared by Mr. Mottsmith without attempting to get very high purity. Samples of oils such as linseed, cottonseed, soya bean, etc., purified by his special process were kindly furnished by Dr. Charles Baskerville.

Saturated Acids.—Lauric ($C_{11}H_{23}COOH$), myristic ($C_{13}H_{27}COOH$), palmitic ($C_{16}H_{31}COOH$), stearic ($C_{17}H_{35}COOH$), arachidic ($C_{19}H_{39}COOH$) and cerotic ($C_{25}H_{51}COOH$) acids were investigated. Lauric acid proved too soluble in water for reliable measurements, the films contracting in area during the course of the measurements. Myristic acid showed some indications of solubility but not enough to interfere seriously with measurements. The curve obtained with a film of pure palmitic acid on distilled water at 16° is given in Fig. 8. The point marked S is that at which the film became solid.

The value of a_o is about 21.8×10^{-16} .

The force necessary to compress the film to $a_H = 13 \times 10^{-16}$ sq. cm. is about $F_H = 63$ dynes per cm. This is nearly as great as the surface tension of pure water (73 dynes per cm.).

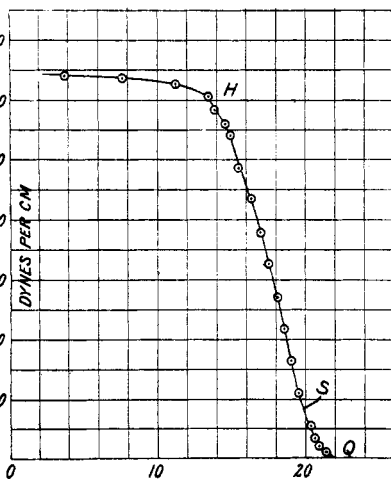

Fig. 8.—Palmitic acid on water at 16° C.

The curves obtained with stearic, arachidic and cerotic acids on pure water at 16° were in all respects practically identical with those found for palmitic acid (Fig. 8).

Upon cooling the water to 4° the curves still remained unchanged. With the water at 45° the curve for palmitic acid (but not the higher fatter acids) changed to the form given in Fig. 9. Up to the point marked S the film remained liquid. Evidently then, the melting point of the film

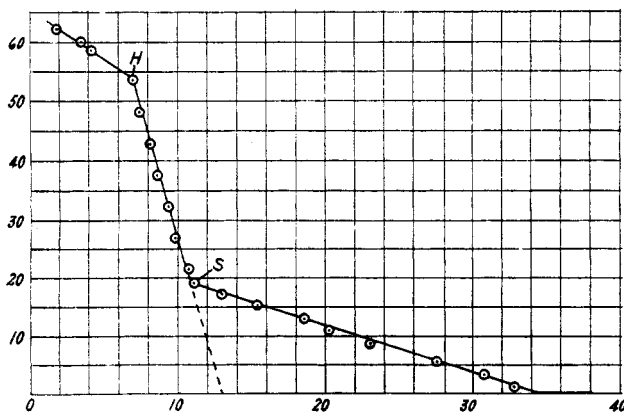

Fig. 9.—Palmitic acid on water at 45° .

is a function of the area available per molecule. At this higher temperature the value of a_0 for palmitic acid is very materially greater than at lower temperatures, namely, 34×10^{-16} instead of 21.8×10^{-16} sq. cm.

Extremely interesting effects are observed when very small quantities of hydrochloric or sulfuric acids are added to the water. Figs. 10, 11 and 12 illustrate the curves obtained with water at 16° containing 0.1% of hydrochloric acid (0.028 *N*). The points marked S indicate where the films become solid. For comparison, the curve (Fig. 8) normally obtained in the absence of the mineral acid is shown as a dotted line in each figure. It is interesting to note that the first kinks in the curve (marked H in Figs. 10, 11 and 12) occur at points which lie approximately on the normal curve (dotted line).

In carrying out these measurements the weights were placed on the pan of the balance and then the paper strip A (Fig. 6) was moved along until the movable strip B came to rest under the point J. When the point H on the curve was reached it was found that the strip B would not remain permanently under the point J but would very slowly move to the left. In order to keep the strip under the point it was necessary continually to advance the strip A. At first this shrinking of the film was slow (about

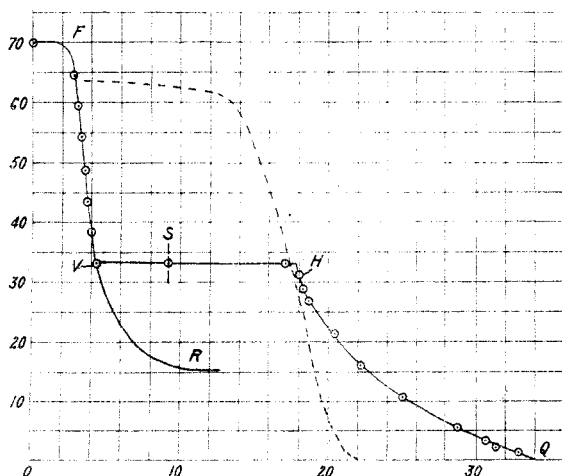

Fig. 10.—Palmitic acid on water containing 0.1% HCl.

10% in 30 seconds), but as the area decreased the shrinking became more and more rapid. The last third of the line HV (Figs. 10 and 11) was passed over in a few seconds. These results suggest that the transformation which occurs in the film is of the nature of a change in phase and that the rate of change depends upon the number of nuclei of the new phase present at any time. These phenomena were further studied by taking weights off the pan after the film had begun to shrink, that is, after the point H (Fig. 10) had been passed. By then putting back the weights one by one it was possible to observe the curve RV which forms a lower extension of the curve VF.

The force per cm. which must be applied to cause shrinking to begin (at H) is somewhat variable and depends to a considerable extent upon the rapidity with which the readings are taken. For palmitic acid the

ordinates of the kink H have been found to vary between 26 and 34 dynes per cm., the smaller force corresponding to the slower taking of the readings.

Experiments were undertaken at several temperatures and with many different strengths of hydrochloric acid. With palmitic acid the curves obtained at 4° were the same as those at 16° except that the ordinate of the point H was somewhat greater, about 30–38 dynes per cm. With impure arachidic acid at 16° the kink H occurred at about 60 dynes per cm., while at 35° it was observed at 48 dynes per cm.

Within wide limits the strength of the acid had no appreciable effect on the curves. About one part of HCl in a million of water was sufficient to cause the curve to change from that shown in Fig. 8 to that in Fig. 10, and a 10,000 fold further increase in the strength made no further change. These films are thus extraordinarily sensitive to very small quantities of acid.

It was found that sulfuric acid gave exactly the same effect as hydrochloric acid. A small amount of hydrogen sulfide dissolved in the water gave a kink H as in Fig. 10, but the Curve VF was shifted much further to the right and the point Q came further to the left.

The abscissa of H was about the same as for hydrochloric acid. In another case 0.2% of potassium cyanide, together with 0.01% of hydrochloric acid were added to the water. This gave a curve in which the kink H occurred at $a = 18.6 \times 10^{-16}$ sq. cm., $F = 27$ dynes per cm. while the kink V occurred at $a = 11 \times 10^{-16}$ sq. cm. The point Q was at $a = 26 \times 10^{-16}$.

These results seem to show that as the hydrogen-ion concentration is made extremely small the Curve RF shifts to the right and the point Q shifts to the left, while the kink H remains practically fixed.

Curve I (Fig. 12) was obtained with a sample of arachidic acid of doubtful purity. The film became solid just before the vertical part of the curve (below H) was reached. The sample of the acid was then fractionally distilled in high vacuum, the first and last thirds being rejected. Curve II was then obtained. In this case the film became solid at the point

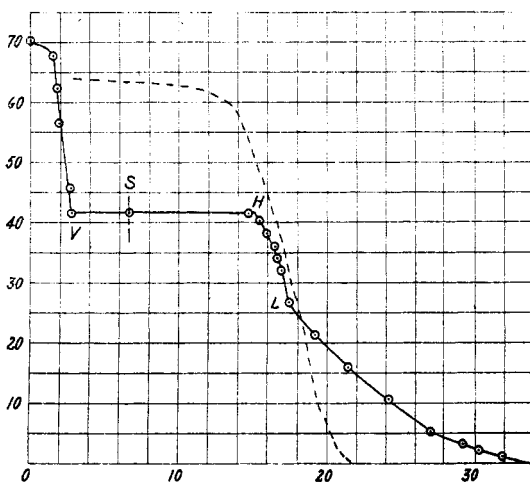

Fig. 11.—Stearic acid on water containing 0.1% HCl.

marked S' which is located in a position corresponding to those observed with palmitic and stearic acids (Figs. 10 and 11).

Myristic acid on 0.1% hydrochloric acid at 16° gave a curve very much like that found with palmitic acid (Fig. 10). The maximum area per molecule was, however, considerably greater, $a = 52 \times 10^{-16}$ sq. cm. The film became solid at a point corresponding to S in Fig. 10.

Cerotic acid films were not changed by the presence of hydrochloric acid, that is, the curves always resembled those of palmitic acid on pure water (Fig. 8).

With dilute solutions of salts such as the chlorides of sodium, calcium or magnesium the curves obtained are not very greatly different from those found with distilled water (Fig. 8). The small effects which do occur with these and other salts are being made the subject of further study.

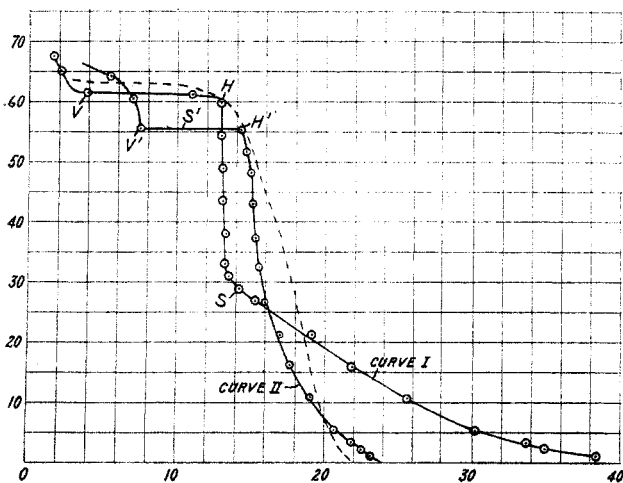

Fig. 12.—Arachidic acid on water containing 0.1% HCl.

Saturated Alcohols.—Cetyl ($C_{16}H_{33}OH$), ceryl ($C_{25}H_{53}OH$) and myricyl ($C_{30}H_{61}OH$) alcohols were studied. The curve obtained for cetyl alcohol is given in Fig. 13. The maximum area per molecule a_0 , is 21×10^{-16} sq. cm. which is about the same as that of the saturated acids on distilled water. The film of this substance is liquid even when compressed into a small area and even when the water is cooled to 4°. It would seem, therefore, that the compression and expansion of such a film should be practically reversible instead of showing the marked hysteresis observed with the solid films of the saturated fatty acids. This, however, is by no means the case. In compressing the film, the force must be increased as shown by the Curve QHU (Fig. 13). If now the weights are removed gradually no perceptible expansion of the film occurs until the point V is reached and then the area increases as shown by the curve VR. This

hysteresis loop is not greatly different from those observed with solid films yet the cetyl alcohol film is extremely mobile.

Ceryl alcohol and myricyl alcohol give solid films. The curves obtained are, however, very similar to those of cetyl alcohol except that a_0 is considerably larger. With myricyl alcohol it seems to be difficult to get consistent results, perhaps owing to the great thickness and hence stiffness or rigidity of the film. When one or two drops of the benzene solution is applied and the benzene has evaporated, it is found by sprinkling talc on the surface that the film has gathered into large cakes. When the area is decreased these cakes pack together leaving irregular spaces between them. On still further decreasing the area the cakes crush each other at their points of contact. It is therefore not surprising that the values of a_0 vary from about 20 to 31×10^{-16} sq. cm.

Within the range from 4 to 45° , temperature seems to have no important effect on the shapes of the curves obtained with these alcohols. The addition of hydrochloric acid to the water is also without apparent effect.

Saturated Esters.—Tristearine ($C_{17}H_{35}COO$) $_3C_2H_5$, cetyl palmitate, $C_{15}H_{31}COOC_{16}H_{33}$, amyl stearate, $C_{17}H_{35}COOC_5H_{11}$, and ethyl palmitate, $C_{15}H_{31}COOC_2H_5$, were the esters investigated. The curve for tristearine was of the same type as that of palmitic acid (Fig. 8). The value of a_0 was 68×10^{-16} sq. cm. while the kink H occurred at $a_H = 48 \times 10^{-16}$ and $F_H = 61$ dynes per cm.

With cetyl palmitate (Fig. 14) the curves obtained at different temperatures differed greatly. At 4° and at 16° the curves closely resembled those for palmitic acid (Fig. 8) and gave values of a_0 ranging from 20.5 to 25×10^{-16} sq. cm., while a_T (see Fig. 7) was always very close to 20.5×10^{-16} . At higher temperatures, however, the value of a_0 increased to 37×10^{-16} at 35° , 52×10^{-16} at 40° and about 95×10^{-16} at 45° . At all temperatures the film became solid at approximately the same area of 23×10^{-16} sq. cm.

Typical results with amyl stearate are shown in Fig. 15. At 4° the film became solid at the point marked S but at 16° and higher temperatures the film remained liquid even when greatly compressed. Between 4° and 46° , temperature had relatively little effect on the results except where

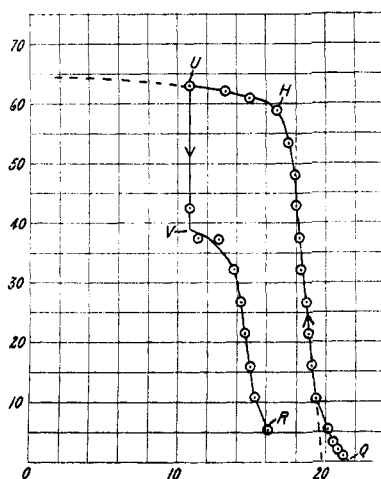

Fig. 13.—Cetyl alcohol on water.

the film became solid at 4° . The area per molecule a_0 averaged about 95×10^{-16} sq. cm. The curves for amyl stearate thus resemble those obtained with cetyl palmitate at the highest temperatures. One dotted curve in Fig. 15 shows the results for cetyl palmitate at 45° as taken from

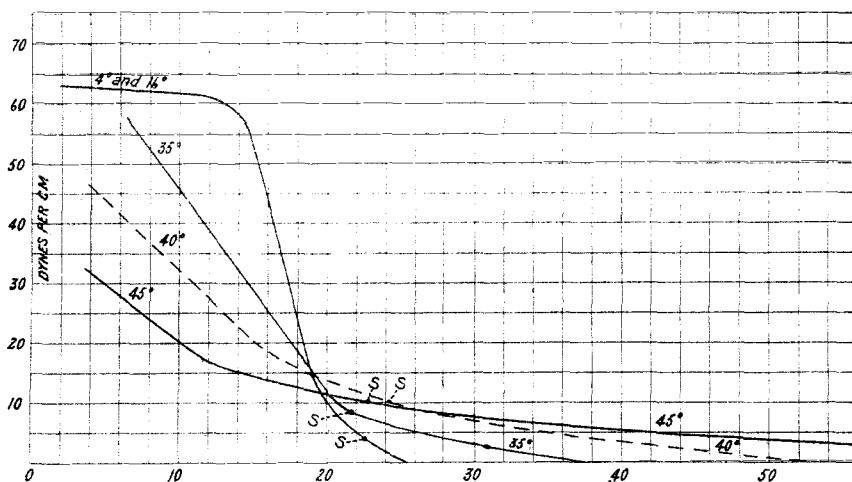

Fig. 14.—Cetyl palmitate on water at different temperatures.

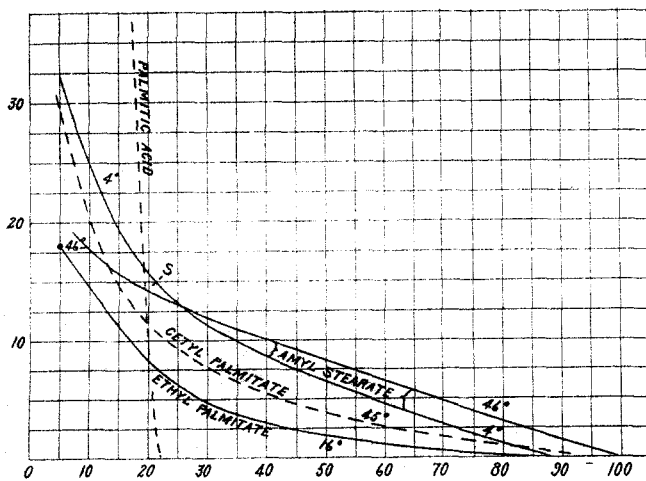

Fig. 15.—Saturated esters on water.

Fig. 14 but replotted to the same scale as that used for the amyl stearate. A second dotted curve gives for comparison the data for palmitic acid as taken from Fig. 8.

Ethyl palmitate gives a rather similar curve which is also shown in Fig. 15.

Curves obtained with cetyl palmitate and amyl stearate on water containing hydrochloric acid did not differ materially from those on pure water.

Tristearin on 0.1% hydrochloric acid, on the other hand, gave a curve rather similar to that of stearic acid in Fig. 11. The value of a_0 was 108×10^{-16} sq. cm. as compared to 68×10^{-16} for tristearin on pure water. The kink H occurred at $a_H = 53 \times 10^{-16}$; $F_H = 48$. The film of tristearin on the acidulated water remained liquid until the area per molecule had been reduced to $a = 21 \times 10^{-16}$ sq. cm.

Unsaturated Acids.—Oleic, $C_{17}H_{33}COOH$, erucic, $C_{21}H_{41}COOH$, linoleic, $C_{17}H_{31}COOH$, linolenic, $C_{17}H_{29}COOH$, and ricinoleic, $C_{17}H_{32}(OH)COOH$, acids were tried. The curves for oleic, lin-

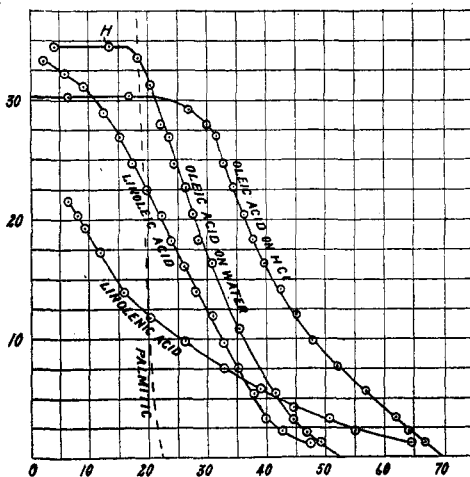

Fig. 16.—Unsaturated acids on water.

oleic and linolenic acids are given in Fig. 16. The data for palmitic acid (Fig. 8) is also given (as dotted curve) for comparison. Hydrochloric acid in the water produces a marked effect on the oleic acid film causing it to increase in area as shown in the curve.

Erucic acid gave a curve very much like that of oleic acid (Fig. 16). The coordinates of the important points were

$$a_0 = 44 \times 10^{-16} \text{ sq. cm.}$$

$$a_H = 12.6 \times 10^{-16}$$

$$F_H = 36 \text{ dynes per cm.}$$

The film remained liquid until very highly compressed.

Upon adding hydrochloric acid, the curve underwent approximately the same changes that occurred with palmitic acid, giving a curve similar to Fig. 10. The coordinates were

$$a_0 = 82 \times 10^{-16} \text{ sq. cm.}$$

$$a_H = 27 \times 10^{-16}$$

$$a_V = 7 \times 10^{-16}$$

$$F_H = 26 \text{ dynes per cm.}$$

$$a_S = 10 \times 10^{-16} \text{ sq. cm.}$$

Ricinoleic acid (Fig. 17) gave remarkable results. On distilled water no constant readings could be obtained until a force of more than 4 dynes per cm. had been applied. With smaller forces the area would continually shrink, so that the curve obtained depended entirely on the rapidity with which the readings were taken. This part of the curve is indicated by a dotted line. On hydrochloric acids, as well as on various

salt solutions, this tendency to shrink disappeared. The curve obtained

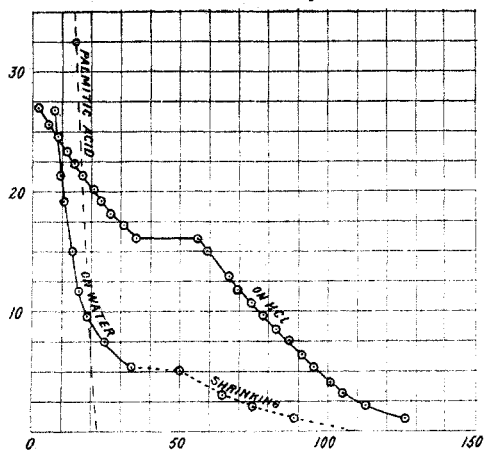

Fig. 17.—Ricinoleic acid on water and on water containing 0.1% HCl.

with dilute hydrochloric (0.1%) is given in Fig. 17. Two kinks with a horizontal part of the curve between them were observed as in the case of the saturated fatty acids (Figs. 9 and 10). These results may be complicated by the presence of impurities.

Unsaturated Alcohols.—Anhydrous cholesterol was the only substance of this class investigated. The curve obtained resembled that with oleic acid on pure water (Fig. 16). The following values of

the coordinates for the singular point were found:

$$\begin{aligned} a_o &= 44 \times 10^{-16} \text{ sq. cm.} & a_s &= 15 \times 10^{-16} \text{ sq. cm.} \\ a_H &= 11 \times 10^{-16} \text{ sq. cm.} & F_H &= 45 \text{ dynes per cm.} \end{aligned}$$

The addition of hydrochloric acid to the water (0.1%) caused the curve to take the general character of the curve for palmitic acid on the acid (Fig. 10). The constants were

$$\begin{aligned} a_o &= 72 \times 10^{-16} \text{ sq. cm.} \\ a_H &= 23 \text{ to } 28 \times 10^{-16}. \\ F_H &= 27 \text{ to } 35 \text{ dynes per cm.} \\ a_s &= \text{about } 10 \times 10^{-16} \text{ sq. cm.} \\ a_v &= 9 \times 10^{-16}. \end{aligned}$$

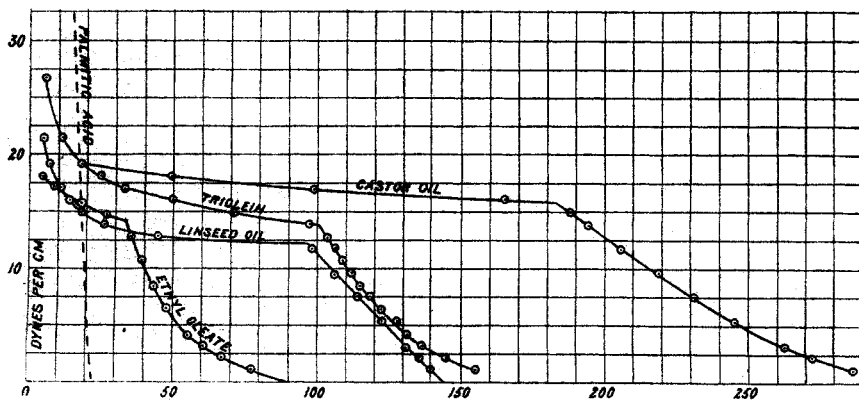

Fig. 18.—Unsaturated esters.

Unsaturated Esters. — Triolein ($C_{17}H_{33}COO$)₃ C_3H_5 , trielaidin ($C_{17}H_{33}-COO$)₃ C_3H_5 , ethyl oleate, $C_{17}H_{33}COOC_2H_5$, linseed oil ($C_{17}H_{31}COO$)₃ C_3H_5 , castor oil ($C_{17}H_{32}(OH)COO$)₃ C_3H_5 , and many other oils were studied. Some of the results are given in Fig. 18.

The rising parts of the curve for small values of a may well be due to small amounts of saturated fatty acids or esters. The curve for trielaidin was practically identical with that of triolein.

Discussion of Results.

These experimental results afford the strongest kind of confirmation of the theory that the spreading of films on surfaces is determined by the shapes of molecules and the relative activities of the different portions of the molecules. The maximum areas given in Table I are in substantial agreement with the values of a_0 taken from the curves in Figs. 8 to 18. The sharpness with which the force increases as the area available for the film is decreased is an excellent proof of the small range of the forces acting between the group molecules.

The saturated fatty acids (from palmitic to cerotic) cover approximately equal areas per molecule ($a_0 = 21 \times 10^{-16}$ sq. cm.), irrespective of the length of the hydrocarbon chain. The glycerides cover about the same area as the fatty acids obtainable from them. The results with cetyl palmitate, amyl stearate, and ethyl palmitate show that the relations are not always as simple as this and that the areas, even in the case of saturated hydrocarbon derivatives, are not always determined solely by the number of $-COO-$ or other active groups present.

In the case of esters, such as amyl stearate, in which the molecules have two hydrocarbon chains of very unequal length, it is probable that a part, at least, of the hydrocarbon chain lies in the surface in contact with the water. We shall see, in another part of this paper, that with very dilute solutions of the lower members of the fatty acid series, the molecules lie spread out flat on the surface. Evidently this tendency exists to some extent among certain esters of the higher fatty acids, especially at high temperatures. We will postpone the further discussion of this subject until we have considered the results obtained in connection with the adsorption of fatty acids in the surface of their solutions in water.

The unsaturated fatty acids all cover much greater areas per molecule than the saturated. The double bond in oleic acid is thus apparently drawn down onto the water surface. It is interesting to note, however, that linoleic acid, with its two double bonds, does not cover any greater area per molecule than oleic acid. It may be that the double bonds attract one another to some extent in place of the water. Linolenic acid, however, with three double bonds, covers a considerably greater area than oleic or linoleic. As the number of double bonds increases, the energy

consumed in compressing the film decreases (see Fig. 16), probably because the —COO— groups tend to be attracted by the double bonds in adjacent molecules and are thus more easily separated from the water surface.

The molecule of ricinoleic acid appears to lie almost wholly flat on the surface, the value of a_0 being in the neighborhood of 110×10^{-16} sq. cm. In this molecule there are three active groups: carboxyl, hydroxyl, and the double bond. These three together should not cover more than $60\text{--}70 \times 10^{-16}$ sq. cm. The value $a_0 = 110 \times 10^{-16}$, corresponds to a film thickness $\tau = 4.7 \times 10^{-8}$ cm., which is about what we should expect for a hydrocarbon molecule spread out flat on the surface. The castor oil (triricinolein) molecule is also evidently spread out flat on the surface.

The presence of the sharp kinks in the curves, such as H and V, makes it evident that several different processes are often involved in the compression of a film, and that these occur one at a time. Thus, in compressing a palmitic acid film (Fig. 8) between Q and H the molecules are being squeezed together more and more tightly, but without involving any radical change in their relative positions. When the point H is reached, the film begins to crumple up, probably by the folding of the whole film, but possibly by tearing molecules one by one from the surface of the water and squeezing them into a second layer on top of the first.

The kink S in Fig. 9 and in Curve I, of Fig. 12, are undoubtedly due to the solidification of the film.

With films which are liquid, as, for example, cetyl alcohol films, the kink H probably occurs when the active group is forced away from the water surface and a second layer of molecules begins to form.

In attempting to account for the remarkable curves obtained with films of fatty acids on acidulated water, it is important to bear in mind that the curves (Fig. 8) obtained on pure water represent wholly irreversible conditions. Even with a liquid film (Fig. 13), the Curve UVR obtained by expanding the film, does not even approximate that obtained during compression (QHU). This is probably to be explained as follows: At the point Q all the molecules of cetyl alcohol lie on the surface with the OH group in contact with the water and the hydrocarbon chains vertical. As the force of compression is increased, the molecules are subjected to forces quite analogous to those acting on a watermelon seed squeezed between the fingers. In this latter case a very considerable pressure may be exerted before the seed moves at all; when it does, however, it is projected with high velocity. Similarly, the molecule of cetyl alcohol may be acted on by strong forces without causing it to be pulled away from the water surface. When the force reaches a certain value, however, the molecule is ejected. The energy involved may be much greater than that

theoretically required to separate an OH group from the water surface. This ejection of molecules first begins when the point H is reached.

Now after a molecule has been forced into the second layer, its active group cannot come in contact with the water at all. If the force on the film is decreased (as at U in Fig. 13), the film therefore does not at first tend to spread. If the force is sufficiently decreased (for instance, to V), then the thermal agitation causes some gaps in the first layer to form from time to time, and into these the molecules in the second layer may descend until they come in contact with the water. This causes a spreading of the film.

The presence of hydrochloric acid in the water seems to cause an increase in the effective volume of the —COOH group, probably by adsorption of hydrogen ions. When the film is compressed the hydrocarbon chains are thus held so far apart at their lower ends that they cannot pack together in the manner necessary to form a solid film. As the force is increased, the adsorbed ions (?) on the —COOH groups are forced off until (at L, Fig. 11) the —COOH groups occupy the same area as if no acid were present. The film, for some unknown reason, remains liquid (except Curve I, Fig. 12), and the molecules are thus more easily ejected (at H) into the second layer. The hydrogen ions thus act as a catalyzer in two ways: by increasing the mobility of the film and by making it easier for the molecules to pass into the second layer. This is not caused, however, by any decreased attraction between the water and the —COOH group.¹

The action of hydrochloric acid on these films is undoubtedly intimately related to the action of acids in catalyzing esterification. It must also be connected with the potential changes observed by Haber and Klemenciewicz² and others.

The Structure of Adsorbed Films on the Surface of Liquids.³

The films of oil or solid fats described in the preceding section differ from other adsorbed films only by their insolubility and non-volatility. When a soluble fatty acid or alcohol is dissolved in water, or when the vapor of a substance like hexane or benzene is brought into contact with water, the surface tension is very materially decreased. According to the principle enunciated by Gibbs, this indicates that the dissolved substance or the vapor is adsorbed in the surface.

From the viewpoint developed in this paper we should expect that these

¹ This conclusion is based on the fact, discussed in a forthcoming paper by Harkins, that the surface tension at the interface of oils is not appreciably affected by the presence of acid.

² *Z. physik. Chem.*, **67**, 385 (1909).

³ A brief preliminary account of part of the work described in this section has appeared in the *Proc. Nat. Acad. Sci.*, **3**, 25 (1917).

adsorbed films in general should consist of not more than a single layer of molecules.

By means of Gibbs' equation,¹

$$q = - \frac{c}{RT} \frac{d\gamma}{dc}, \quad (1)$$

the amount of material q adsorbed per sq. cm. of surface may be calculated from the rate at which the surface tension γ varies as the concentration of the dissolved substance changes. The equation may also be applied to the depression of surface tension caused by a gas or vapor above the liquid.

It was pointed out by Milner that when substances which strongly depress the surface tension are added to water, the surface tension is a linear function of the logarithm of the concentration of the dissolved substance for all except very dilute solutions. We may write Equation 1, as follows:

$$q = - \frac{1}{RT} \frac{d\gamma}{d \ln c} \quad (2)$$

If γ is a linear function of $\ln c$ then q will be independent of the concentration. Milner thus calculates from Whatmough's data for acetic acid solutions that q is 3.8×10^{-10} mols per sq. cm. over a rather wide range of concentration. The constancy of q under these conditions is readily explained according to our theory as being determined by the number of molecules needed to form a single layer. If we multiply Milner's result for q by N we find that the amount adsorbed corresponds to 23×10^{18} molecules per sq. cm. The area occupied by each molecule is thus 43×10^{-16} sq. cm. This result is in fair agreement with the value 22×10^{-16} which we have found for films of the higher fatty acids on water. It is probable that each molecule of a substance as soluble as acetic acid is surrounded by water molecules, so that these and the acetic acid molecules are packed in the surface layer alternately, each acetic acid molecule being surrounded by a definite number of water molecules. The CH_3 groups in the acetic acid molecule undoubtedly come to the surface but cover only a part of the surface.

Szyszkowski² measured the surface tensions of aqueous solutions of propionic, butyric, valeric and caproic acids (in each case both the normal and the iso compound) and found that results could be accurately expressed by the empirical relation

¹ A simple derivation of this equation is given by Milner (*Phil. Mag.*, 13, 96 (1907)). In this derivation it is not assumed that the gas law $pv = RT$ holds in the surface layer; it is only necessary that it should hold for the osmotic pressure inside the solution, or in the case of adsorbed vapors, for the vapor above the liquid. The equation thus rests on a firm foundation, at least in the case of dilute solutions.

² *Z. physik. Chem.*, 64, 385 (1908).

$$\frac{\gamma}{\gamma_0} = 1 - B \log_{10} \left(\frac{c}{A} + 1 \right). \quad (3)$$

Here γ is the surface tension of the solution while γ_0 is that of pure water, c is the concentration of the fatty acid in mols per liter. A and B are constants.

Szyszkowski found that the constant B was the same for all the fatty acids studied, its numerical value being 0.411. A was a constant for any one substance, but its value decreased rapidly as the length of the hydrocarbon chain increased as follows:

TABLE II.

	A. Mols per liter.	Ratio.
Propionic acid.....	0.165	3.25
Butyric acid.....	0.051	3.40
Valeric acid.....	0.0150	3.48
Caproic acid.....	0.0043	

The iso-compounds gave practically the same results as the normal. No reason is given by Szyszkowski for the constancy of B or the changes in A . If we deal with rather concentrated solutions so that c is large compared to A then in Equation 3 we may neglect unity in comparison with c/A . Under these conditions γ is a linear function of the logarithm of c . This is the relation found for acetic acid by Milner, and according to Gibbs' equation this must mean that the amount of fatty acid adsorbed in the surface is independent of the concentration.

By differentiating (3) we obtain

$$d\gamma = -0.434 B\gamma \frac{dc}{c + A}. \quad (4)$$

Substituting this in (1) yields

$$q = \frac{0.434 B\gamma_0}{RT} \frac{c}{c + A}. \quad (5)$$

This equation shows us that for very dilute solutions (c small compared to A) the amount adsorbed in the surface is proportional to the concentration and is equal to

$$q = \frac{0.434 B\gamma_0}{RT} \frac{c}{A}. \quad (6)$$

The amount adsorbed increases more slowly than the concentration, and finally when c is large compared to A , the surface becomes saturated. The limiting amount adsorbed is then

$$q_\infty = \frac{0.434 B\gamma_0}{RT}. \quad (7)$$

Since B was found to be the same for different fatty acids, the number of molecules adsorbed per unit area must be the same. If we multiply q_∞ by N (the Avogadro number), we obtain the number of molecules per sq. cm. The reciprocal of this gives us a_s , the area covered by each molecule when the surface is saturated. We thus find

$$a_s = \frac{1}{Nq_\infty} = \frac{RT}{0.434 NB\gamma_0}. \quad (8)$$

Taking $R = 83.2 \times 10^6$, $N = 6.06 \times 10^{23}$, $T = 293^\circ$ and $\gamma_0 = 72.5$.

$$a_s = \frac{12.8 \times 10^{-16}}{B}. \quad (9)$$

Substituting the value $B = 0.411$ found by Szyszkowski we obtain $a_s = 31 \times 10^{-16}$ sq. cm. per molecule. This value comes reasonably close to the value $a_0 = 21.5 \times 10^{-16}$ found for the higher fatty acids by the study of the films on water. The fact that a_s has the same value for each of the acids from propionic to caproic shows that in the more concentrated solutions the molecules in the adsorbed surface layer are packed tightly side by side with the hydrocarbon chains arranged vertically.

In the case of very dilute solutions we see from Equation 6 that the different acids are adsorbed in the surface layer in different amounts, these being inversely proportional to the values of A (Table II). The longer the hydrocarbon chain the greater the adsorption from a dilute solution, although with more concentrated solutions the length of the chain is without influence.

These facts are readily explainable by the new theory of surface tension. Let us consider what must be the mechanism of these phenomena. In the surface of a sufficiently dilute solution the molecules of the fatty acid will be so far apart that they do not influence one another. There must be a kinetic equilibrium between the molecules arriving at the surface from the interior and those passing from the surface to the interior. The rate at which the molecules arrive at the surface is proportional to the concentration. The rate at which they pass into the interior is proportional to the number in the surface. For equilibrium in dilute solutions it is evident that the number in the surface must be proportional to the number in the interior. This explains the form of Equation 6 which merely states that q is proportional to c and serves as a definition of the constant A . From the above kinetic considerations, together with the conclusion that a saturated surface layer must consist of a layer one molecule deep, we thus obtain from Gibbs' equation, a rational derivation of Szyszkowski's empirical equation.

The potential energy of a molecule of a fatty acid is lower when the molecule is on the surface than when it is in the interior. The rate at which molecules pass from the interior to the surface depends primarily

on the concentration of the solution, but not on the difference of potential energy between the molecules in the interior and on the surface. The rate at which the molecules pass from the surface back to the interior depends on the number of molecules in the surface, but is also dependent to a very great degree on the difference in the potential energy of the molecule in the two states. The phenomena is quite analogous to evaporation. The manner in which m the "rate of evaporation" of the molecules from the surface into the interior of the liquid, varies with the difference of potential energy may be calculated from Maxwell's distribution law.¹

Taking into account the kinetic equilibrium between the surface layer and the interior of the solution it may be readily shown that the following relation should hold between the amount adsorbed in the surface and the concentration in the solution:

$$\frac{q}{c} = Ke^{\lambda/RT}. \quad (10)$$

Here λ is the decrease in potential energy which occurs when a gram molecule of the dissolved substance passes from the interior of the solution into the surface layer. K is a constant.

We may now apply this equation to the case of a series of solutions of homologous compounds. If λ increases in arithmetical proportion as we pass from one member of the series to the next, then according to (10) the ratio q/c will increase in geometrical proportion. By Equation 6, q/c is inversely proportional to A , the constant tabulated in Table II. Combining Equations 6 and 10 we obtain for any two members of a homologous series

$$\frac{A}{A'} = e^{\lambda' - \lambda/RT}. \quad (11)$$

Now the experimental data of Table II show that A decreases in a constant ratio each time a CH_2 group is added to the hydrocarbon chain. Taking this ratio to be 3.4 and substituting in Equation 11 gives $\lambda' - \lambda = 2.98 \times 10^{10}$ ergs per gram molecule or 710 g. calories per mol. We may thus conclude from the experimental data that each CH_2 added to the hydrocarbon chain of a fatty acid increases the potential energy λ in very dilute solutions by the constant amount of 710 calories per gram molecule. This must mean that each CH_2 added occupies a similar position, in regard to the structure of the surface layer, as the CH_2 groups already present. Since the range of the forces involved is small compared to the size of the molecule, it must therefore follow that each CH_2 group in these dilute solutions forms a part of the surface. In other

¹ For further details see Equation 5 and the references given in the footnote on page 2254 of Part I of this paper (THIS JOURNAL, 38, 2221 (1916)).

words, the hydrocarbon chain lies spread out flat on the surface of the water. As the concentration of the solution increases, the molecules become more closely packed in the surface layer, and finally when the surface becomes saturated, the molecules are all arranged with their hydrocarbon chains placed vertically.

We have seen in the case of the higher fatty acids that the surface films have no appreciable effect on the surface tension until their molecules are packed tightly. With the saturated fatty acids they must even be packed so that they stand vertically on the surface before affecting the surface tension. The lower fatty acids on the other hand change the surface tension considerably even when the number of molecules on the surface is very much less than enough to cover the surface with a single layer.

We have seen in the derivation of Equation 6 that for dilute solutions of fatty acids q is proportional to c . From Equation 1 this means that $d\gamma/dc$ is constant, or in other words γ is a linear function of c . We may therefore place

$$-\frac{d\gamma}{dc} = \frac{F}{c}, \quad (12)$$

where

$$F = \gamma_0 - \gamma. \quad (13)$$

The number of molecules adsorbed in the surface is Nq so the area per molecule is

$$a = \frac{1}{Nq}. \quad (14)$$

Substituting (12) and (14) in (1) we find

$$F.Na = RT. \quad (15)$$

This equation is exactly analogous to the gas law $pV = RT$. The quantity Na is the area available per gram molecule and corresponds to V . The force F is the force with which the film tends to spread over the surface, and this corresponds to the gas pressure p .

With dilute solutions of the lower fatty acids the adsorbed films thus follow the laws of ideal gases. From the kinetic viewpoint this means that the molecules are free to diffuse over the surface and are taking part in the thermal agitation (Brownian movement) just as any gas molecule does. The strips of paper on the surface of the water in the apparatus shown in Fig. 6 correspond to semipermeable membranes which allow the water to pass, but not the substance in the surface film.

The magnitude of the forces due to this gas-like expansion of surface film is by no means small. Thus from Equation 15 we calculate that at 20° the force F would be 4 dynes per cm. when $a = 100 \times 10^{-16}$ sq. cm. per molecule.

From Fig. 8 we see that in the case of the higher fatty acids the

films do not spread upon the surface in the way required by Equation 15. Thus with palmitic acid the force F falls to less than 0.2 dyne per cm. when $a = 23 \times 10^{-16}$ sq. cm., whereas by (15) the force should be 17.5 dynes per cm. for this value of a .¹

This means that the film no longer behaves like a gas, but rather as a liquid or solid. Adsorbed films in the surfaces of liquids may thus exist in three distinct conditions corresponding to the solid, liquid, and gaseous states. It is to be expected that the transition from gaseous to liquid films may be either continuous (as in the case of the lower fatty acids), or discontinuous (higher fatty acids), and that under proper conditions, phenomena quite analogous to the critical phenomena of gases should be observed.

Any solid or liquid film must have a certain tendency to spread on the surface by giving off separate molecules which will follow the gas laws. This tendency may be measured as a "surface-vapor-pressure." With palmitic acid and higher fatty acids this pressure is less than 0.1 dyne per cm. The smallness of this pressure for the higher fatty acids must be due to attractive forces between the molecules powerful enough to prevent their separation. These same forces tend to prevent the film from evaporating from the surface into the vapor phase and from going into solution in the water. There are thus intimate relationships between the lowering of surface tension produced by fatty acids and the vapor pressures and solubilities of these substances. These relationships will be discussed in more detail in another part of this paper.

When the solubility or vapor pressure of a surface film is not negligible the paper strips of the apparatus shown in Fig. 6 are no longer equivalent to semipermeable membranes, so that this method fails. It will probably be possible by means of Gibbs' Equation 1 or a more accurate equation of similar type, to study the relations between F and a during the transition from the state of liquid films to that of "gaseous" films.

Before discussing in more detail the mechanism of adsorption in the surfaces of liquids, let us consider some additional experimental data on the surface tension of solutions.

The surface tensions (at 15°) of a large number of aqueous solutions of

¹ To measure the relation between a and F for very small values of F a special balance like that of Fig. 6 but of greater sensitiveness was constructed. By also using a weaker air blast it was possible to increase the sensitiveness many fold, so that a force of 0.05 dyne per cm. could be measured with certainty. Until the force F decreases to about 0.4 dyne per cm. or less the curves shown in Figs. 8-18 approach the horizontal axis, forming a definite angle with it, instead of approaching it asymptotically. For still weaker forces (0.05 to 0.3 dyne per cm.) a transition curve asymptotic to the horizontal axis was sometimes observed, but this appeared to be due to some contamination of the water surface rather than to the substances investigated.

organic substances have been accurately determined by J. Traube.¹ His results are given in a form which renders them particularly adapted to our present purposes. In each case he measured the surface tensions of solutions of the following concentrations: 1, 0.5, 0.25, 0.125, etc., gram molecules per liter. He continued diluting each solution until the surface tension became nearly equal to that of pure water. In some cases it was necessary to dilute to $1/1024$ mols per liter. Traube drew the following general conclusions from his work on organic substances containing hydrocarbon chains with a single active group (acids, alcohols, esters, amines, and aldehydes):

1. For very dilute solutions the depression of the surface tension $\gamma_0 - \gamma$ (or F) is proportional to the concentration. In other words F/c is constant.

2. The ratio F/c for dilute solutions increases about threefold for each CH_2 added to the hydrocarbon chain in the molecules.

3. As the concentration of the solution increases F ceases to be proportional to c , but increases more slowly than c .

4. The concentration at which F ceases to be proportional to c is lower the greater the length of the hydrocarbon chain.

5. At still higher concentrations F increases by constant increments (about 8.0 dynes per cm.), each time the concentration is doubled. That is, the surface tension decreases in arithmetical proportion while the concentration increases in geometrical proportion.

6. The depression of the surface tension F is expressed as a function of the concentration c by the following equation:

$$F = f(c/A) \quad (16)$$

Here A is a constant characteristic of each substance and f represents a function which is the same for all substances.

Traube explained the first of the above conclusions by kinetic considerations much as has been done in this paper. He either did not attempt to explain the other relations or he gave explanations which at present are of little value.

It is interesting to note that in the above conclusions Traube anticipates by 16 or 17 years most of the relations found by Milner and by Szyszkowski. The present theory of the structure of the surface layer furnishes a rational explanation of each of Traube's conclusions.

Traube's results can be expressed fairly well by Szyszkowski's Equation 3. This equation may be written in the form

$$F = B\gamma_0 \log \left(1 + \frac{c}{A} \right). \quad (17)$$

¹ *Ann.*, 265, 27-55 (1891).

For very dilute solutions, where c/A becomes small compared to unity the ratio F/c becomes constant and equal to

$$\left(\frac{F}{c}\right)_o = \frac{0.434 B \gamma_o}{A}. \quad (18)$$

On the other hand for concentrated solutions where c/A is large compared to unity, Equation 17 reduces to

$$F = B \gamma_o \log c - \text{constant}. \quad (19)$$

Traube usually started with a gram-molecular solution repeatedly doubling its volume so that the molecular volume V was increased through the steps 1, 2, 4, 8, 16, etc. The value of F at first decreased by more or less constant increments— ΔF . But as the solution became more dilute ΔF became approximately proportional to c as would be expected by Equation 18. For concentrated solutions where Equation 19 still holds, we thus obtain

$$\Delta F = B \gamma_o \log 2. \quad (20)$$

Substituting $\gamma_o = 72.95$, we get

$$B = 0.0454 \Delta F. \quad (21)$$

In attempting to calculate B from Traube's data it was found that the range of concentration was usually not quite sufficient to allow Equation 21 to be applied with accuracy.

The equation actually used in calculating B was obtained by expanding (17) into a series and combining the result with (18) and (21) as follows:

$$B = 0.0454 \Delta F \left(1 + \frac{\Delta F}{(cF/c)_o} \right) \quad (22)$$

The correction term in the second member usually amounts to less than 10%.

Similarly it was found that the values F/c given by Traube did not quite reach a constant value as the solutions were diluted. An extrapolation formula based on an expansion of (17) was also developed for this case.

$$\left(\frac{F}{c}\right)_o = \frac{F}{c} \left(1 + \frac{F}{63B} \right). \quad (23)$$

Here B was first calculated by (22).

Table III contains values of B and $(F/c)_o$ calculated for a large number of substances from Traube's data. The first column gives the range in the molecular volumes V of the solutions used by Traube. The second gives values of $(F/c)_o$ calculated by Equation 23. The next column gives values of B by (22). In some cases the maximum concentration used by Traube was not sufficient to yield a saturated surface. This was shown by a marked lack of constancy in the values of ΔF for the higher concentrations.

In such cases the value of B could not be determined, or at most only a lower limit for B could be found.

TABLE III.

Substance.	Range of V.	(F/c) ₀ .	B.	λ _{obs.}	λ _{cal.}	a _s × 10 ⁻¹⁸ , sq. cm.
Formic acid HCOOH.....	1-8	8.0	..	1078	1062	..
Acetic acid CH ₃ COOH.....	1-16	27.0	..	1710	1687	..
Propionic acid C ₂ H ₅ COOH.....	1-64	77.0	0.37	2290	2312	33.8
Butyric acid C ₃ H ₇ COOH.....	1-128	230.0	0.40	2910	2937	31.2
Iso-butyric acid C ₃ H ₇ COOH.....	1-128	240.0	0.40	2940	2937	31.2
Iso-valeric acid C ₄ H ₉ COOH.....	4-256	720.0	0.41	3570	3562	30.5
Methyl alcohol CH ₃ OH.....	1-8	11.0	..	1240	1200	..
Ethyl alcohol C ₂ H ₅ OH.....	1-16	33.0	0.39	1820	1825	32.0
Propyl alcohol C ₃ H ₇ OH.....	1-32	98.0	0.43	2430	2450	29.1
Iso-propyl alcohol C ₃ H ₇ OH.....	1-32	98.0	0.36	2430	2450	34.7
Iso-butyl alcohol C ₄ H ₉ OH.....	1-64	310.0	0.45	3080	3075	27.8
Iso-amyl alcohol C ₅ H ₁₁ OH.....	4-128	910.0	0.45	3700	3700	27.8
Methylacetate CH ₃ COOCH ₃	1-32	85.0	0.42	2340	2345	29.8
Propyl formate HCOOC ₃ H ₇	4-128	250.0	..	2960	2970	..
Ethyl acetate CH ₃ COOC ₂ H ₅	2-128	270.0	0.42	3000	2970	29.8
Methyl propionate C ₂ H ₅ COOCH ₃	2-128	245.0	0.44	2950	2970	28.4
Propyl acetate CH ₃ COOC ₃ H ₇	8-256	840.0	> 0.41	3650	3595	30.5
Ethyl propionate C ₂ H ₅ COOC ₂ H ₅	8-256	745.0	> 0.41	3580	3595	30.5
Propyl propionate C ₂ H ₅ COOC ₃ H ₇	32-1024	2050.0	> 0.37	4160	4220	33.8
Allyl acetate CH ₃ COOC ₃ H ₅	8-256	470.0	> 0.42	3320	3195	29.8
Allyl alcohol C ₃ H ₅ OH.....	1-32	46.0	0.44	2000	2050	28.4
Allyl amine C ₃ H ₅ NH ₂	1-32	51.0	0.31	2060	2075	38.4
Propyl amine C ₃ H ₇ NH ₂	1-32	110.0	0.35	2490	2475	34.0
Butyl aldehyde C ₃ H ₇ CHO.....	2-64	160.0	0.48	2710	2710	24.8
Oxy-butyric acid C ₃ H ₆ (OH)COOH.....	2-32	53.0	0.25	2080	2137	47.7
Acetone CH ₃ .CO.CH ₃	1-32	62.0	0.28	2170	2170	42.5
Dimethyl-ethyl carbinol (CH ₃) ₂ (C ₂ H ₅)OH	2-256	590.0	0.33	3450	3450	36.1
Paraldehyde C ₆ H ₁₂ O ₃	2-64	240.0	0.42	2940	..	28.4
Glycol (CH ₂ OH) ₂	1-8	2.4	..	563	550	..
Acetamide CH ₃ CONH ₂	1-8	3.8	..	740	740	..
Oxalic acid (COOH) ₂	4-8	2.1	..	516	550	..
Methyl oxalate (COOCH ₃) ₂	4-32	36.0	..	1870	1800	..
Malonic acid CO ₂ H.CH ₂ .CO ₂ H.....	4-8	12.0	..	1280	1175	..
Succinic acid CO ₂ H.CH ₂ .CH ₂ .CO ₂ H.....	4-8	18.5	..	1510	1800	..
Maleic acid CO ₂ HCH:CHCO ₂ H.....	4-32	8.3	..	1090	1400	..
Fumaric acid CO ₂ H.CH:CH.CO ₂ H.....	32	11.5	..	1260	1400	..
Malic acid CO ₂ H.CH ₂ .CHOH.CO ₂ H.....	4-8	6.0	..	940	1000	..
Tartaric acid CO ₂ H(CHOH) ₂ .CO ₂ H.....	1-8	0.5	..	172	200	..

From the values of (F/c)₀ we can calculate λ the loss in potential energy when a gram molecule of the solute passes from the interior to the surface of the solution. We have previously shown from Szyszkowski's data how the increase in λ for each CH₂ could be determined. To estimate the approximate absolute value of λ we may proceed as follows:

It is shown in works on the kinetic theory¹ that for a state of equilibrium the distribution of a gas between two regions in which the potential energy is different, is given by the relation

$$\frac{c}{c'} = e^{-\lambda/RT}. \quad (24)$$

Here c and c_1 are the respective concentrations in the two regions and λ is the difference in potential energy per gram molecule.²

For solutions so dilute that F/c is constant, we may expect Equation 24 to be applicable and we may thus use it to calculate the concentration c in the surface layer in terms of λ or vice versa.

The equation may also be derived from purely thermodynamical principles.

If λ is expressed in calories, Equation 24 may be written

$$\lambda = RT \ln \frac{c_1}{c} = 4.57T \log \frac{c_1}{c}. \quad (25)$$

This equation is similar in form and analogous in meaning to Nernst's equation of the electromotive force of reversible cells.

The amount of solute q adsorbed in the surface layer per sq. cm. may be roughly taken to be

$$q = \frac{\tau(c_1 - c)}{1000}, \quad (26)$$

where τ is the thickness of the surface layer in which adsorption takes place.

Combining Gibbs' Equation 1 with (12) we obtain

$$q = \frac{c}{RT} \left(\frac{F}{c} \right). \quad (27)$$

Eliminating q from (26) and (27) and combining with (25) gives for dilute solutions

$$\lambda = 4.57T \log \left[1 + \frac{1000}{\tau RT} \left(\frac{F}{c} \right)_o \right]. \quad (28)$$

Taking $T = 288$ and assuming $\tau = 6 \times 10^{-8}$ cm. this equation reduces to

$$\lambda = 1318 \log \left[1 + 0.695 \left(\frac{F}{c} \right)_o \right]. \quad (29)$$

This equation was used for calculating the values of λ_{obs} given in Table

¹ For example Jean's, "Dynamical Theory of Gases," p. 78.

² The above equation is closely related to Boltzmann's conception, according to which entropy is equal to the logarithm of the probability. The ratio between the probability that a molecule will be in the interior, and the probability that it will be in the surface is thus proportional to $e^{-\phi}$ where ϕ is the entropy. The quantity λ/RT corresponds to the entropy.

III. The choice of the particular value of τ to use in (28) is somewhat arbitrary, but since the molecules adsorbed in the surfaces of these dilute solutions lie flat in the surface it is probable that τ is of the same order of magnitude as the values found for ricinoleic acid or triricinolein, namely, 4.7×10^{-8} .

The last column of Table III gives the values of A calculated from B by an equation similar to (9) except that the numerical constant was 12.5 instead of 12.8, since the temperature in Traube's experiments were 15° instead of 20° .

It is seen from the table that λ_{obs} increases on the average by about 625 calories for each CH_2 added to the molecule. This means that λ can be expressed in general by an equation of the form

$$\lambda_{\text{cal.}} = \lambda_0 + 625 n, \quad (30)$$

where n is the number of carbon atoms in the molecule. The quantity λ_0 has a different value for each type of substance as is shown in Table IV.

TABLE IV.
Values of λ_0 .

Type.	Formula.	λ_0 .
Tertiary alcohol.....	R_3COH	950
Primary amine.....	RCH_2NH_2	600
Primary alcohol.....	RCH_2OH	575
Ester.....	RCOOR'	470
Monobasic acid.....	RCOOH	437
Ketone.....	RCOR'	295
Aldehyde.....	RCHO	210
Amide.....	RCONH_2	-510
Dibasic acid (or alcohol).....	-700

When a double bond is present in the molecule the value of λ_0 is decreased by about 400. The addition of one or more hydroxyl groups to a mono- or dibasic acid decreases λ_0 by about 800 for each hydroxyl group.

The fifth column of Table III gives values of $\lambda_{\text{cal.}}$ which have been calculated by Equation 30, using the values of λ_0 given in Table IV.

An examination of Table IV shows that λ_0 becomes smaller as the active groups in the molecule become more polar in character. It also shows that the polar character is not additive. Two active groups attached to adjacent carbon atoms, as in glycol, cause a very great decrease in λ_0 . Such effects, with which chemists are familiar, are undoubtedly due to forces transmitted from atom to atom in the group molecule. It is probable that these forces are caused by a displacement in the relative positions of the electrons and positive nuclei. Thus if an oxygen atom is combined with a carbon atom at one end of a hydrocarbon chain the electrons in the carbon atom are probably displaced towards the oxygen atom and the positive nucleus of the carbon atom displaced away from the oxygen

atom. This displacement causes a similar but smaller displacement of the electrons of the next carbon atom and so on.¹

The close agreement between the observed and calculated values of λ in Table III shows that, except in the case of active groups in close proximity within the molecule, the change in potential energy λ between the interior and surface of the liquid is an additive property.

The results for a_s in Table III are in substantial agreement with the results previously discussed. For the saturated acids, alcohols, and esters the values are approximately the same (30×10^{-16} sq. cm.) and are independent of the number of carbon atoms.

The presence of double bonds (allyl alcohol and acetate) does not seem to cause any increase in a_s , probably because these are forced away from the water before the surface becomes saturated. With oxy-butyric acid a_s is much greater (48×10^{-16}), indicating that the hydroxyl group is in contact with the water even when the surface is saturated. The large value for acetone (42.5) and the small value for butyl aldehyde (24.8) are noteworthy, but until verified by other data it would hardly be safe to draw conclusions from these differences.

There are many other data available from which the arrangements of group molecules in surface layers are determinable. Some of these will be briefly mentioned.

Morgan and Egloff² give the surface tensions of solutions of phenol and water at three temperatures. From these data by Equation 1 the amounts of phenol adsorbed per sq. cm. (q) may be calculated.

It is found that with increasing concentration q increases, rapidly at first, then more slowly until it reaches a maximum of about 48×10^{-11} g. molecules per sq. cm., showing that the surface becomes saturated with phenol molecules. This maximum value of q is approximately the same at all three temperatures (0° , 35° and 65°), but at the higher temperatures it requires a greater concentration of phenol in the solution to give a saturated surface than at lower temperatures. This fact is a natural result of the kinetic agitation which tends to equalize the concentration in the surface and in the solution. From the above value of q it can be readily calculated that the area per molecule of adsorbed phenol is $a_o = 34 \times 10^{-16}$ and the thickness of the film is $\tau = 4.3 \times 10^{-8}$ cm. These results would seem to indicate that the phenol molecules in the surface of an aqueous solution lie flat on the surface, and that the diameter of the disk-shaped (assumed) molecule is about one and a half times its thickness.

¹ Effects of this kind are probably of importance not only in organic chemistry, but in the study of the structure of the surfaces of crystals and of liquids. In some cases such phenomena may cause adsorbed layers to be more than one group molecule in thickness.

² THIS JOURNAL, 38, 844 (1916).

Morgan and Egloff's data on triethyl amine-water solutions show that the surface is saturated with this substance even with the most dilute solutions used (0.5%). The values of q were fairly constant $q = 40 \times 10^{-11}$ and were the same at 0° as at 30° . This result corresponds to

$$a_0 = 41 \times 10^{-16} \text{ sq. cm.}$$

$$\tau = 5.6 \times 10^{-8} \text{ cm.}$$

It is probable from these results that the three ethyl groups lie spread out upon the surface while the nitrogen atom is below the surface and is surrounded by water molecules combined with it by secondary valence.

Worley¹ gives data for aqueous solutions of aniline at several temperatures from 15° to 75° . The values of q calculated from (1) show a variation quite similar to that found from the data on phenol-water solutions. The surface becomes saturated more easily at low than at high temperatures. The data are apparently not as accurate as those of Morgan and Egloff, but they indicate a fairly constant saturation value of $q_s = 45 \times 10^{-11}$. This corresponds to

$$a_0 = 37 \times 10^{-16} \text{ sq. cm.}$$

$$\tau = 4.0 \times 10^{-8} \text{ cm.}$$

Evidently the arrangement of the aniline molecules in the saturated surface is about the same as that of the phenol molecules.

We have thus far considered cases where the solute is adsorbed in the surface layer, so that the surface tension is less than that of the pure solvent. When inorganic salts are dissolved in water or alcohol the surface tension increases. The surface of the solution thus contains an excess of the solvent. In general we should expect the surface of any liquid to consist of molecules or atoms arranged in a rather definite manner different from that in the interior. If the molecules or atoms of the dissolved substance are surrounded by fields of force strong compared to those of the solvent then it is improbable that the solute molecules will be able to displace solvent molecules in the surface. Hence the surface layer should consist of a single layer of molecules of the solvent from which solute molecules are excluded.

From Gibbs' Equation 1 we see that if the surface tension *increases* linearly with the concentration, there is a *deficiency* of the solute in the surface layer which is proportional to the concentration. Now this is exactly what we should expect if the surface layer consists of pure solvent. Let τ be the thickness of this layer. Then q the deficiency of solute per sq. cm. of surface is

$$q = \frac{\tau c}{1000}$$

or by (1)

¹ *J. Chem. Soc. (London)*, 105, 260 (1914).

$$\tau = 1000 \frac{-q}{c} = \frac{1000}{RT} \frac{d\gamma}{dc}. \quad (31)$$

We can thus calculate τ the thickness of a single layer of molecules of the solvent by measuring the increase of surface tension produced by the addition of a soluble salt.

Unfortunately the data for $d\gamma/dc$ for aqueous salt solutions are rather variable. Thus for potassium chloride solutions different observers have found results given in Table V.

Observer.	$d\gamma/dc.$	τ cm.	a sq. cm.
Forch ¹	1.41	3.3×10^{-8}	9.0×10^{-16}
Whatmough ²	1.81	4.24×10^{-8}	7.02×10^{-16}
Linebarger ³	1.75	4.1×10^{-8}	7.26×10^{-16}
Quincke ⁴	1.747	4.1×10^{-8}	7.27×10^{-16}
Volkman ⁵	1.56	3.66×10^{-8}	8.15×10^{-16}
Rother ⁶	1.63	3.83×10^{-8}	7.80×10^{-16}

The values of τ were calculated from Gibbs' equation by (31), taking into account the electrolytic dissociation of the potassium chloride solution. This is best done by using Lovelace, Frazer and Miller's data⁷ on the vapor pressure of potassium chloride solutions and then applying Gibbs' equation in the form

$$q = \frac{-p}{RT} \frac{d\gamma}{dp}, \quad (32)$$

where p is the vapor pressure of the solution. By substituting values of q obtained in this way into (31) the values of τ given in Table V were found.

From these results it may be concluded that the layer of pure water adsorbed in the surface of a potassium chloride solution is about 4×10^{-8} cm. thick. This probably represents the length of the water molecules in the surface, so that their cross-section (assuming H_2O as the group molecule) is about 7.4×10^{-16} sq. cm.

It is interesting to note that the results obtained with other salts are in substantial agreement with the above. Although different salts give different values of $d\gamma/dc$, these differences seem to be almost wholly accounted for by differences in the degree of electrolytic dissociation.

Cederberg⁸ finds for solutions of sodium iodide in ethyl alcohol $d\gamma/dc = 1.09$. This leads to $\tau = 4.4 \times 10^{-8}$ cm. and $a = 22. \times 10^{-16}$ sq. cm. for the adsorbed layer of pure alcohol in the surface of this solution.

¹ Forch, *Ann. Phys.*, [4] 17, 744 (1905).

² Whatmough, *Z. physik. Chem.*, 39, 154 (1901).

³ Linebarger, *THIS JOURNAL*, 21, 413 (1899).

⁴ Quincke, *Ann. Phys.*, [2] 160, 337, 560.

⁵ Volkman, *Ibid.*, [3] 11, 177; 17, 353 (1881).

⁶ Rother, *Ibid.*, [3] 21, 576 (1884).

⁷ *THIS JOURNAL*, 38, 515 (1916).

⁸ *J. chim. phys.*, 9, 10 (1911).

Gibbs' equation may also be applied to cases where the surface tension of a liquid is decreased by the presence of a vapor above the liquid. For example, benzol or hexane vapors brought into contact with the water decrease the surface tension of the water very markedly. By measuring the surface tension as a function of the partial pressure of the vapor up to pressures sufficient to yield a saturated adsorbed film, it must be possible to obtain very definite information as to the shapes and arrangements of these hydrocarbon molecules. Experiments of this kind were begun in this laboratory, but owing to the present unsettled conditions have been discontinued.

Adsorption of Liquids by Solids.

The heats of adsorption of various organic liquids when brought into contact with Fuller's earth, bone charcoal, or kaolin, have been carefully studied by Gurvich¹ in an investigation of the nature of the forces involved in adsorption. Gurvich traces relationship between this heat of adsorption and such properties as chemical reactivity, solubility, latent heat of evaporation, dielectric constant, "internal pressure," and surface tension, explaining these relationships in terms of his previously mentioned theory of "physico-chemical forces."

TABLE VI.
Heat of Adsorption.

Substance.	Fuller's earth.	Bone charcoal.	Kaolin.	Volume adsorbed from saturated vapor by 1 g. of Fuller's earth, cc.	Dispersive power. %.
Amylene.....	57.1	..	78.8	...	1.54
Water.....	30.2	18.5	..	0.683	2.82
Acetone.....	27.3	19.3	..	0.684	1.72
Methyl alcohol.....	21.8	17.6	27.6	0.679	1.60
Ethyl acetate.....	18.5	16.5	..	0.636	1.05
Ethyl alcohol.....	17.2	16.5	24.5
Aniline.....	13.4
Amyl alcohol.....	10.9	10.6	20.4
Ethyl ether.....	10.5	0.90
Chloroform.....	8.4	14.0	15.7	0.611	0.86
Benzene.....	4.6	11.1	9.9	0.610	0.39
Carbon disulfide.....	4.6	8.4	9.9	0.621	..
Carbon tetrachloride.....	4.2	13.9	9.4	0.625	0.27
Hexane.....	3.9	8.9	7.2	...	0.22

The results of his determinations of the heats of adsorption are given in Table VI. These are the heats in small calories, liberated when 1 g. of the absorbent is added to a relatively large quantity of the liquid in a calorimeter.

¹ L. G. Gurvich, *J. Russ. Phys. Chem. Soc.*, **47**, 805-27 (1915). As this excellent paper is in the Russian language, and has been especially translated for me, it may be worth while to give here Gurvich's results in some detail, especially since they have a very intimate bearing on my theories of the constitution of solids and liquids.

Gurvich remarks:

"A glance at this table shows that with all three absorbents, most heat is evolved when compounds with double bonds or those containing oxygen or nitrogen are used; and the least heat is generated by saturated hydrocarbons or such saturated compounds as carbon disulfide or tetrachloride. The substances which are most active chemically exhibit the most intense attraction for the absorbents.

"The most natural conclusion from this fact would be that in adsorption we have to do with rather unstable molecular compounds. It would seem that Werner's theory of secondary valence would thus find further confirmation; *but further experiments have proved that this is not so.*"

Gurvich rejects the theory that these phenomena are the result of chemical forces for the following three reasons:

1. He finds that amounts of different liquids adsorbed by a given amount of absorbent are not in agreement with stoichiometric relations. Instead, he finds that the *volumes* of the different substances adsorbed are very nearly equal. In these determinations he placed 1 g. of the absorbent in a Hempel exsiccator in presence of the *saturated vapor* of the liquid until the weight became constant, which required from 15-25 days. The results thus obtained with Fuller's earth are given in the fourth column of Table VI. The volumes of liquid adsorbed from the vapor thus vary over only the relatively small range from 0.61 to 0.684 cc. per g. The number of gram molecules adsorbed per 100 g. of Fuller's earth, however, vary from 0.65 for CCl_4 up to 3.79 for H_2O .

2. From experiments, and by reference to work of other investigators he concludes that the range of the forces causing adsorption and the other phenomena considered, is always of the order of 3×10^{-6} cm. He experimented with silver foil and glass wool in *saturated vapors* of CCl_4 , CS_2 and ethyl acetate. The absorbents were placed in six glass tubes within the exsiccator, and the increase in weight in 20 hours was determined. No further increase occurred in an additional 22 hours. The silver foil had a surface of 4150. sq. cm. while the glass wool (threads 0.018 mm. diameter), had a surface of 2250 sq. cm. By calculation from the increases in weight (20-50 mg.) the "thickness" of the adsorbed film, in the six cases studied, were found to lie within the range between 2.6 and 3.5×10^{-6} cm.

Gurvich refers to results of similar magnitude obtained by Magners for the adsorption of SO_2 by glass, by Shapin for adsorption of CO_2 , NH_4OH , etc., by glass, and by Parks for the adsorption of water vapor by glass. Quincke, Reinold and Ruecker, Moro, Wensam and others have obtained results of the same order of magnitude by entirely different methods.

Gurvich concludes:

"It seems to me, therefore, very probable that the physico-chemical force of attraction *in all its manifestations, is not limited* to adjacent molecules, but reaches out

upon a large number of more distant molecules, its influence gradually decreasing as the distance from the center increases.¹

"The action of the force of chemical affinity involved in the formation of compounds according to more or less simple stoichiometric proportions, is limited to distances of atomic order, or, at most, to distances separating neighboring molecules. The sphere of action of physico-chemical forces is many times greater.

3. "Finally, the third distinction between physico-chemical and purely chemical forces is the following:

"The heat of reaction between any two elements, generally speaking, is the greater, the more dissimilar the elements are. In the action of the residual chemical energy (physico-chemical forces) we see just the reverse; hydrocarbons and their immediate derivations generate much more heat (see Table VI) with charcoal than with Fuller's earth or kaolin; alcohols and in general oxygen compounds act in just the reverse manner. In the study of solubility it was noted long ago that chemically similar substances dissolve one another more easily than dissimilar substances."

Gurvich gives these three reasons as convincing proof that adsorption phenomena are not the result of purely chemical forces. The heat of adsorption is, however, in some way, clearly related to the chemical properties. This is due he thinks "to some residual energy in the chemical molecule intermediate in character between chemical and physical." This residual energy differs from the purely chemical in the three ways given above but it also differs essentially from the potential energy of purely physical attraction by its specific action or "specificity."

In discussing the relation between these "physico-chemical" forces and "true chemical forces" Gurvich points out that chloroform, which is chemically more active than carbon tetrachloride, has the higher heat of adsorption (Table VI). Among the alcohols there is a parallelism between the heat of adsorption and the velocity of esterification and also the heat liberated during the formation of complex compounds with magnesium propyl iodide.

Gurvich observes that when Fuller's earth is shaken up with hexane it settles out rapidly, leaving a nearly clear liquid, but with acetone the liquid remains turbid. The disintegration of the Fuller's earth by acetone can even be observed under the microscope. By determining the percentage of the Fuller's earth which remains in suspension in different liquids he determines the dispersive power as given in the last column of Table VI. The closeness of the parallelism between this phenomena and the heat of adsorption is very striking.

The disintegration of the Fuller's earth by these liquids is looked upon as entirely analogous to the solubility of substance in a liquid, except that the particles in the latter case are smaller. In fact there is a rather close

¹ These views of Gurvich are cited here at such length because they appear to be the prevalent views among workers in this field. The insufficiency and unreliability of the data upon which these views are based are typical of nearly all the data upon which the general distinction between "physical" and "chemical" forces usually rests.

parallelism between the solvent power of the liquids shown in Table VI and the observed heats of adsorption. For example, benzol and unsaturated hydrocarbons are in general better solvents than the saturated. Chloroform is about ten times more soluble in water than is carbon tetrachloride. Benzol mixes in all proportions with methyl alcohol, while only 31% of hexane can be dissolved in this alcohol.

In general the substances with high heats of adsorption have high dielectric constants.

Among closely related chemical compounds Gurvich finds that the substances with the higher heats of adsorption have in general the higher surface tensions, but this parallelism is not nearly as good as in the cases of the properties cited above.

The chemical properties of substances are characterized by their "specificity." Thus we usually cannot predict how a substance A will react toward a substance B merely from a knowledge of the behavior of A and B (separately) towards a third substance C. Certain very general relationships may exist between different classes of substances, but we are not often able to express the chemical properties of a substance in terms of a single constant as for example the gravitational properties of a body can be expressed by the mass, or the electrical properties by the electric charge.

Gurvich considers that this "specificity" is a sufficient criterion to establish a close relationship between "molecular" and "chemical energy," but for the reasons already given he feels compelled to class the molecular forces as physico-chemical. As illustrating the "specificity" of "molecular processes" he calls attention to the fact "that benzene and hexane liberate twice as much heat (Table VI) with charcoal as with Fuller's earth, but acetone, ether and alcohols yield on the contrary more with Fuller's earth than with charcoal."

From the viewpoint adopted in the present paper the forces involved in adsorption, surface tension, etc., are strictly chemical in nature, that is, that do not differ in any essential respect from the forces causing the formation of typical chemical compounds. Let us see how this theory can be reconciled with Gurvich's experimental results.

Consider first the adsorption of a liquid by a plane solid surface. If the molecules of the liquid contain active groups, the molecules will become oriented and will pack into the surface layer in much the same manner as in the case of oil films spread upon the surface of water. In general, there will be a *tendency* for the number of molecules adsorbed to bear a simple integral relation to the number of atoms exposed in the surface of the solid. When the surface is a cleavage plane from a crystal, so that the surface atoms are arranged in a regular lattice, the amounts of different

liquids (or gases) needed to saturate the surface would probably frequently stand in stoichiometric relations with each other.

In fact the experiments with oil or adsorbed films on water have already shown that these stoichiometric relations are very common. Thus it was found that the number of molecules of different fatty acids adsorbed per unit area was practically the same for all the acids from propionic up to cerotic. Similarly, the number of molecules of stearic acid per unit area was three times that found for tristearine, etc.

It is evident that the configurations of the adsorbed molecules in general are of great influence in determining the number of molecules that can be adsorbed per unit area. This phenomena is, however, nothing more than *steric hindrance*. In adsorption phenomena, particularly on solid bodies, this steric hindrance must be of very far-reaching significance, much more so for example than in the fields ordinarily covered by organic chemistry.

Suppose we consider the adsorption of two such substances as methyl alcohol and phenol. Since the phenyl group will necessarily occupy more space than the methyl group, the number of molecules of phenol per unit area of a saturated surface will be less than that of methyl alcohol.

We might still expect that the number of phenol molecules would bear a simple relation (such as $\frac{1}{3}$ or $\frac{1}{4}$) to the number of methyl alcohol, but when we take into account the thermal agitation and the kinetic interchange which must occur, it appears more probable that the relative numbers of molecules adsorbed would bear an incommensurate ratio. This would be especially true if instead of a cleavage surface we should give a surface of an amorphous body as absorbent.

Now in the case of porous bodies such as those employed in Gurvich's experiments, there are cavities of nearly all possible sizes and shapes. It is obvious, therefore, that the phenomenon of steric hindrance will become of dominating importance and that even in the case of a series of homologous acids or alcohols we should no longer expect to find stoichiometric relations. For example the number of ethyl alcohol molecules which could attach themselves to the walls of a small cavity would be less than the number of methyl alcohol molecules which could be similarly attached. This difference will become more and more marked as the size of the cavities becomes smaller.

This absence of stoichiometric relationship, therefore, is not to be regarded as evidence that the forces involved are not chemical in nature. It is merely the result of purely geometrical factors. In fact, apart from reactions involving primary valence forces, it seems that stoichiometric relations are the exception rather than the rule, and that where these relations do hold it is merely the result of particularly favorable geometric conditions.

The heat of adsorption is determined in general by the interaction of the active groups and the atoms of the solid body. Thus in Table VI we see that those groups which cause oils, etc., to spread on water surfaces are just those which cause an increase in the heat of adsorption.

Those groups or radicals are the double bond, $-\text{OH}$, $=\text{CO}$, $-\text{COO}-$, $-\text{NH}_2 - \text{O}-$.

The parallelism between these heats of adsorption and the phenomena described in the early part of this paper could hardly be more striking. There can be no reasonable doubt but that the causes of the adsorption are in both cases fundamentally similar.

Let us now consider from the viewpoint of our theory, the three reasons which led Gurvich to decide that these adsorption phenomena are not due to chemical forces.

1. We have already seen that the absence of stoichiometric relationship cannot be taken as a proof of the absence of chemical combination, but that it is simply a result of steric hindrance.

It remains to explain why Gurvich's experiments showed that the *volumes* adsorbed were the same for all the liquids. It must be noted that Gurvich allowed the adsorption to occur in saturated vapors, and that equilibrium was not reached for from 15 to 25 days. Under such conditions every small cavity must fill up completely with liquid because of the decrease of vapor pressure caused by the concavity of the surfaces in the pores of the absorbent. This is a purely secondary phenomenon, being dependent only on the surface tension of the adsorbed liquid, and not on the forces acting between the absorbent and the liquid.

We must picture the processes occurring during the adsorption of, for example, ethyl alcohol by charcoal as follows: The hydroxyl groups of the alcohol are attracted to the carbon atoms, so that as many carbon atoms as possible come into contact (or combine) with the hydroxyl groups. The ethyl groups fill up many of the small cavities, and, in other ways, prevent the hydroxyl groups from coming into contact with the carbon atoms. The larger pores or cavities are, however, covered over with a single layer of molecules. When the vapor is *saturated* it is evident that these cavities must also gradually become filled with liquid. But this is to be classed as a capillary phenomena and not as adsorption. It has, for example, nothing to do with the forces acting between the carbon atoms and the hydroxyl groups.

Under these conditions it is only natural that the volume *absorbed* should be about the same for different liquids, since it is simply a measure of the total volume of the larger pores. The amount truly adsorbed is much smaller, and, in the case of the three alcohols given in Table VI, is probably quite accurately proportional to the observed heat of adsorption. The three values, 21.8, 17.2 and 10.9, for methyl, ethyl and

amyl alcohols adsorbed by Fuller's earth, indicate how marked is the effect of steric hindrance.

2. Gurvich and many other workers in this field lay a great deal of stress on the supposed fact that the range of the molecular forces is about 3×10^{-6} cm. or at any rate is larger than molecular dimensions. According to our theory, however, the range is rather of the order of 10^{-8} cm.

Gurvich experimented with 4150 sq. cm. of silver foil in a small tube. This was probably crumpled up loosely and squeezed into the tube. In any case it would be practically impossible to get such a large surface into a tube without having an enormous number of surfaces of contact between adjacent pieces of foil. These capillary spaces in *presence of saturated vapor* or even vapor anywhere near saturation must become filled with liquid held by surface tension and not by adsorption. The same objection may be raised against the experiments with glass wool.

We have seen in Part I (pages 2282-5) that other data given in the literature are unreliable for similar reasons.

I have not studied in detail all the references cited by Gurvich as evidence of the large range of molecular forces, but the evidence of a contrary nature which has already accumulated is enough to make me feel confident that the large ranges are only apparent, and are due to secondary causes.

To obtain further information regarding the forces causing adsorption and the thickness of adsorbed films, some experiments have been undertaken for me by Mr. Sweetser. We have used glass, mica, and platinum, with very nearly plane surfaces and have endeavored to reduce the number of contacts between surfaces to a minimum. The pressures used were much below saturation and were usually less than 200 bars. It was found that at 100 bars' pressure the amount of oxygen, nitrogen, hydrogen, carbon monoxide, carbon dioxide and argon adsorbed on glass or mica at room temperature were not measurable, although if 0.0002 of the surface had been covered by a layer one molecule deep it could have been readily detected. On cooling these surfaces to liquid air temperature the surfaces became covered with a monomolecular layer to the extent of 1 to 10% and at 100 bars' pressure they seemed nearly saturated. The relative amounts of different gases adsorbed were in the same order as the boiling points, showing that the forces involved in this adsorption were secondary valence forces such as those involved in the liquefaction of these gases.

With platinum surfaces the phenomena were totally different. Even at pressures below one bar the surface adsorbed hydrogen, carbon monoxide or oxygen immediately to form a layer covering the surface with a layer approximately one molecule (or atom) deep. These films could not be driven off by heating to 360° , but could be made to displace one another. The surfaces were wholly saturated at a few bars' pressure, and no increase

in adsorption could be noted by raising the pressure to 200 bars. These films are evidently held to the platinum by primary valence forces.

With the platinum at liquid air temperature the gases are first adsorbed by secondary valence forces, because when the temperature is raised to room temperature the gas first comes off the surface, and then at a temperature somewhat below room temperature goes back again onto the surface.

In no case, however, was any adsorption noted which corresponded to a layer more than one molecule deep.

It is, of course, possible in certain exceptional cases that more than one layer of molecules may be adsorbed on a surface. The tendency of molecules to evaporate from a second layer will in general be somewhat different (either greater or less) than from the surface of the liquid en masse. Such effects may be transmitted from layer to layer because of the orientation of the first layer of molecules, but in most liquids, these effects are probably not transmitted in appreciable degree to more than one or two layers. Effects of this kind would be particularly noticeable with nearly saturated vapors.

From the foregoing considerations we may conclude that the "molecular forces" studied by Gurvich are really chemical forces according to all the tests given by him and that their range of action is not greater than that of other chemical forces.

3. Gurvich's third objection to classing molecular forces as chemical is that they seem most active between similar rather than dissimilar bodies. This objection, however, arises merely from a confusion of secondary and primary valence forces.

In the formation of compounds of the first order we generally find the most marked combining tendencies between strongly electronegative and electropositive elements as for example between the alkali metals and the halogens. This tendency is most readily explained in terms of Lewis' theory.

On the other hand, all through chemistry we find evidence of reactions occurring between substances of similar type, especially where secondary valences are involved. This is shown by reactions between oxides, between halides, between metals, etc., and even by the reactions occurring between various organic compounds. Therefore, the fact that substances of similar character are usually mutually soluble, or that absorbing agents show a preference for chemically related substances, is not to be looked upon as evidence that these phenomena differ in any essential respect from chemical phenomena, but merely as an indication that secondary rather than primary valence forces are involved.

As a final result of this discussion of Gurvich's paper we may conclude that the principles outlined in the beginning of the present paper are applicable to adsorption phenomena in general.

(In the remaining part of this paper surface tension, association, evaporation, freezing, melting, viscosity, solubility, and the internal structure of liquids will be briefly considered.)

[CONTRIBUTION FROM THE CHEMICAL LABORATORY OF THE UNIVERSITY OF CALIFORNIA.]

THE POTENTIAL OF THE LEAD ELECTRODE.

By GILBERT N. LEWIS AND THOMAS B. BRIGHTON.

Received July 11, 1917.

On account of our almost complete ignorance as to the activity of bivalent ions, there are few cases where it has been possible to calculate even with moderate accuracy the electrode potentials of bivalent metals.¹ Numerous measurements² have been made, which involve the lead electrode, but there is none from which the normal electrode potential can be calculated with any certainty. Much of the former work has been done with solutions of lead nitrate. Aside from the difficulties due to the possible formation of nitrite from nitrate solutions there is no known method for determining the amount of intermediate ion in $\text{Pb}(\text{NO}_3)_2$ or the activity of Pb^{++} .

We have investigated the potential of lead in the presence of solid PbI_2 . This salt is so very insoluble in water that we may, without any serious error, estimate the activity of Pb^{++} in its saturated solution in pure water, and are thus enabled to calculate the normal electrode potential of lead. We have also investigated lead electrodes in the presence of PbBr_2 , PbCl_2 and PbSO_4 .

All measurements, unless otherwise stated, were made at 25°.

Solid Lead Electrodes.—It was found in a number of experiments that sticks of the best purchasable lead, scraped with a glass edge, gave the same potential as lead deposited by electrolysis, either upon lead or upon platinum, from a solution of lead perchlorate (containing for an accidental reason a certain amount of lead acetate). The electrodes of the three classes differed no more from one another than did several electrodes of the same class, the average deviation from the mean in both cases being less than 0.0001 volt.

This behavior is just what we should expect from a metal as soft as lead. It is our belief that the lack of reproducibility in electrodes of solid metal is due solely to conditions of strain in the solid surface. In the case of metals which flow readily, like lead or sodium or potassium,

¹ See Lewis and Lacey, *THIS JOURNAL*, 36, 804 (1914).

² Immerwahr, *Z. Elektrochem.*, 7, 477 and 625 (1900-01); Sackur, *Arbeit. k. Gesundheitsamt.*, 20, 539 (1903); Labendzinski, *Z. Elektrochem.*, 10, 77 (1904); Cumming, *Trans. Faraday Soc.*, Nov., 1906; Lewis, W. K., *Dissert.*, Breslau, 1908; Jaques, *Trans. Faraday Soc.*, 5, Nov., 1909; Getman, *THIS JOURNAL*, 38, 796 (1916); Fernau, *Z. physik. Chem.*, 17, 343 (1898); Brönsted, *Z. physik. Chem.*, 56, 645 (1906).