

## **A PRELIMINARY STUDY INTO TURBOFAN PERFORMANCE WITH LP-HP POWER EXCHANGE**

**Hossein Balaghi Enalou**  
**University of Nottingham**

Hossein.Balaghienalou@nottingham.ac.uk  
Nottingham, UK

**Serhiy Bozhko**

**University of Nottingham**

Serhiy.Bozhko@nottingham.ac.uk  
Nottingham, UK

**Mohamed Rashed**  
**University of Nottingham**

Mohamed.Rashed@nottingham.ac.uk  
Nottingham, UK

**Ponggorn Kulsangchareon**  
**University of Nottingham**

Ponggorn.Kulsangchareon@nottingham.ac.uk  
Nottingham, UK

### **ABSTRACT**

Once an engine is designed, its Low Pressure (LP) and High Pressure (HP) shaft speeds are inevitably thermodynamically coupled which imposes certain operational constraints. These spools are not mechanically connected, however, in future more electric aircraft with electrical machines linked to both HP and LP shafts it is possible to transfer power between them electrically seeking for optimized operation depending on Engine Operating Mode (EOM). This paper investigates possible achievements of the novel configuration of power circulation between shafts using turbofan model, developed by Inter-Component Volume (ICV) method. Results show that a considerable improvement can be achieved not only in fuel consumption but also in surge margin of compressors along with providing ability to have compatible thrust with flight mission.

### **INTRODUCTION**

In order to accomplish ambitious overall aircraft fuel burn goals, hence environmental impact, propulsion technology plays prominent role which emphasizes the importance of its further improvements.

Turbofans, as primary source of propulsion, are designed for cruise phase, which consumes most of an aircraft's fuel. However, after assembly of all components, where sealing and rotor dynamic issues depend on high manufacturing and assembly tolerances (Lattime and Steinetz, 2002), there is a possibility that an engine will deviate from its design point for some of its components. With all the improvement in CFD (Computational Fluid Dynamics) analysis, the deviation is not expected to be significant, however, there is still room for improvement.

Another important fact is that with aging of an engine, its optimum point of operation shifts to a different point with different shaft speeds which can either decrease efficiency or safe margins. Normally, HP shaft components are more susceptible to wear out due to higher speed and pressure

operation condition (Kurz and Brun, 2001; Meher-Homji et al., 2001).

On the other hand, having been designed for Aerodynamic Design Point (ADP), an engine operates in sub-optimal condition during low power settings at other flight phases, such as taxiing and descent, creating inconsistent thrust with aircraft mission on top of being fuel inefficient. Engine shaft speeds are designed to be matched at ADP to keep the air mass flow balanced between Low Pressure Compressor (LPC) and High Pressure Compressor (HPC) (Razak, 2007; Walsh and Fletcher, 2008). LP and HP shafts are not connected mechanically, while their speed are coupled aero-thermodynamically within the engine which enforces unmatched shaft speeds at low speed settings. This as a consequence creates imbalanced air mass flow between LPC and HPC. In order to overcome this problem designers are obliged to implement bleeding between LPC and HPC which consequently limits the engine at a permissible minimum speed. If the engine speed falls below the minimum level, due to increase in required bleeding, core airflow across High Pressure Turbine (HPT) and Low Pressure Turbine (LPT) will not be adequate to produce power to drive compressors which results in an engine not being self-sustained anymore.

Therefore, for engine operation at low speed settings, undesirable measures are taken due the imminent thermodynamic coupling between shaft speeds for which an engine pays off both in terms of fuel efficiency and excessive thrust at low speed settings.

However, single dc bus Electric Power System (EPS) architecture with electrical machines on both LP and HP shafts (Gao and Bozhko, 2016a; Gao et al., 2015; Gao et al., 2016b) provides the ability to transfer power between shafts electrically to decouple shaft speeds. This novel configuration is expected to:

- enable engine core components to operate closer to their optimum design point after aging
- reduce the fuel burn during low speed settings

- help faster recovery of thrust in case of abrupt thrust demand
- increase available surge margins compressors
- transfer wind-milling power from LP to HP shaft for engine restart

Certainly, due to weight and occupied space of power transfer mediums, a built-in inefficiency is a penalty for this idea which should be considered in future studies to see the impact of this system on aircraft overall propulsion efficiency.

In literature, a lot of research have been done on electrical machines and control architecture for the concept of LP spool generator for MEA (Avery et al., 2007; Bhangu and Rajashekara, 2014; Jia and Rajashekara, 2017; Muehlbauer and Gerling, 2010; Provost, 2002).

This paper investigates the concept of power exchange approach and some of aforementioned objectives. For this purpose, compressor matching will be elaborated firstly to see its impact on engine stability. Then, results at different flight scenarios are provided, using turbofan model developed by ICV method (Enalou et al., 2016) and verified in (Enalou et al., 2017).

## MULTI-SPOOL MATCHING

Compressor surge occurs when it cannot pump against high back pressure, causing the flow to separate and reverse its direction. It should be noted that operating at higher efficiency implies operation closer to surge, however, there should be always enough margin to avoid surge since it causes severe mechanical damage to the blades and thrust bearings. Surge margin (SM) is normally defined as:

$$SM = \frac{PR_{surge} - PR_{working}}{PR_{working}} \quad (1)$$

where  $PR_{surge/working}$  denotes the pressure ratio on the surge/working line at the same corrected mass flow rate (Boyce, 2017).

Figure 1 shows a two-spool unmixed flow turbofan for which LPT drives fan and LPC and HPT drives HPC. Although LP and HP shafts are not connected mechanically, their speeds are thermodynamically coupled throughout range of operation from low to high shaft speeds.

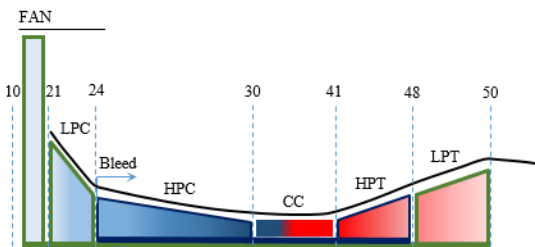

**Figure 1. Illustration of turbofan components**

Pumping characteristics of HP shaft ( $\frac{W_{24}\sqrt{\theta_{24}}}{\delta_{24}}, \frac{p_{48}}{p_{24}}, \frac{T_{48}}{T_{24}}$  and  $\frac{f \times LHV}{\dot{c}_p T_{24}}$ ) are functions of its speed and  $\frac{T_{41}}{T_{24}}$ ; however, inlet and exhaust conditions of it are determined by the LPC and LPT.

With the assumption of no pressure drop along the Combustion Chamber (CC) the pressure ratio of HPC can be expressed as:

$$\frac{p_{30}}{p_{24}} = \left[ \frac{(1+f)(A_{24}/A_{41})}{\left(\frac{W_{41}\sqrt{\theta_{41}}}{A_{41}\delta_{41}}\right)} \right] \frac{W_{24}\sqrt{\theta_{24}}}{A_{24}\delta_{24}} \sqrt{\frac{T_{41}}{T_{24}}} \quad (2)$$

where  $\theta$  and  $\delta$  are corrected temperature and pressure values.

Knowing the fact that HPT is choked,  $\frac{W_{41}\sqrt{\theta_{41}}}{A_{41}\delta_{41}}$  keeps constant, then the quantities in the bracket are constant, which means the equation is the operating line on HPC map where its slope depends on  $\frac{T_{41}}{T_{24}}$  for a fixed geometry turbine (Kerrebrock, 2001). Normally, HPC operating line slope is in a way that HPC surge margin is lower at lower HPC corrected speed.

For design purposes, if the value of  $\frac{T_{41}}{T_{24}}$  is chosen firstly, based on pumping characteristics of HPC, its mass flow and pressure ratio are determined. Afterwards, the operating point of LPC should be specified to keep its air mass flow matched to HPC one at ADP.

LP spool can be described by relations analogous to equation 2, except that the combustor is replaced by HP spool where the corrected speed of HPC determines the outlet condition to LPC. HPC will swallow and pass flow delivered by LPC provided that HPC speed is properly matched with LPC one. But for the same LPC speed line if HPC speed is less than matched value, HPC demands less mass flow. Hence, it acts as a blockage for rear side of LPC, pushing LPC to decrease its mass flow on the same speed line. As it is shown in Figure 2 the pressure ratio of LPC increases and the operation point of LPC gets closer to surge.

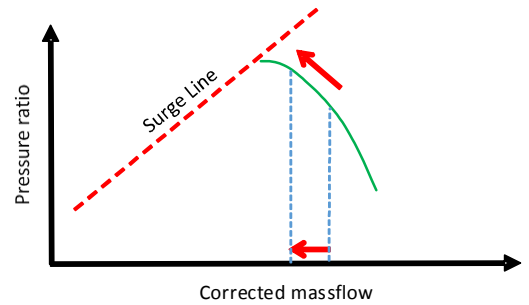

**Figure 2. Operational speed line on LPC performance map**

Therefore, the operating line of LPC is determined by flow requirement of HPC which is determined by HPC corrected speed.

LPC and HPC speeds match for the high speed setting while due to HPT/LPT power split ratio at lower speed settings, HPC speed is lower than desired matched value. In this case, HPC accepts less airflow causing LPC discharge pressure to increase, creating a risk of LPC surge at low speed settings.

To prevent this, Variable Bleed Valves (VBVs) are located between LPC and HPC and their function is to regulate the primary flow entering HPC and bypass excess air from

core flow to fan discharge duct. VBV's act primarily at low speeds due to lower LPC surge margin. Because the bleeding of compressed air is loss of energy, VBV's are opened no more than necessary. For this reason, VBV position is scheduled to increase bleeding with HPC speed decrease.

However, if HP speed goes below a minimum permissible speed, due to the considerable amount of bleeding, primary flow will not be enough to produce power by turbines to drive compressors. As a result an engine will not able to sustain its speed anymore.

The minimum HP speed limit is a source of trouble for engine idle condition. For instance, it creates inconsistent thrust with aircraft mission while consuming extra fuel. Excessive thrust in flight idle setting leads an aircraft not to descent quickly enough, lengthening the descent phase (which is a fuel inefficient operational combination) or results in a significantly higher than normal airspeed during descent (steeper pitch angle). In ground idle excessive thrust demands extra-braking, which is fuel inefficient as well.

During the approach phase, the idle speed setting is normally higher to provide immediate recovery of thrust in case of go around manoeuvre (Linke-Diesinger, 2010).

These scenarios can even get more critical due to increased electrical load for more electric aircraft where an engine may need to be operated at a higher speed level to maintain in a stable region.

**INTRODUCING LP-HP POWER EXCHANGE**

Since HPC receives the airflow from LPC, it is always favourable if HPC operates at higher speeds, however, designers cannot exceed a limit for produced power by HPT due to HPC maximum permissible massflow. This causes a compromise for HPT power at engine low speed settings, thus a trade-off for HPC at low operational speeds. This cannot be compensated, provided that with the current engine configuration, once HPT and LPT turbines are designed for high speed setting, the power split ratio between compressors

at off-load condition is fixed and shafts are thermodynamically coupled.

However, within the innovative single-bus multi-source EPS architecture concept for future more electric aircraft illustrated in Figure 3, two electrical machines are connected to LP and HP shafts through gearboxes. Given that these machines are connected to the dc bus through converters, there is the ability of dynamically controllable bidirectional power exchange between shafts at various operational speeds.

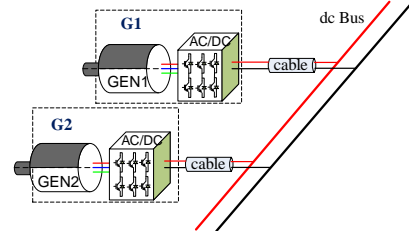
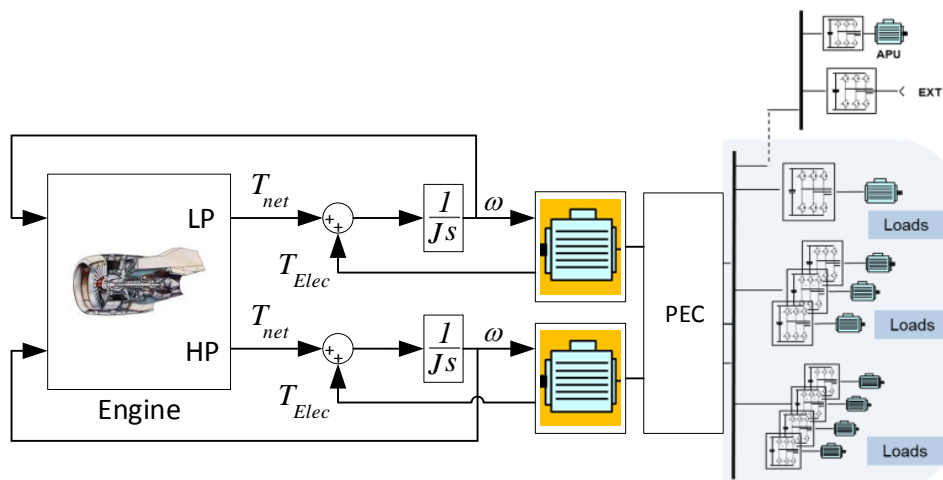

**Figure 3 Configuration of single dc bus multi-source EPS**

This configuration accommodates an engine with flexible power split ratios at different operational speeds. At low power settings, HPC speed can be increased by taking power from LP shaft and feeding it to HP shaft. While at higher speeds, with the privilege of electric power transfer fast dynamic to handle surge phenomena, transferring power from HP to LP can be allowed to help compressors operate closer to their surge line at higher efficiency.

**MODELLING**

ICV method has been implemented in MATLAB-SIMULINK environment to model multiple spool turbofan (Enalou et al., 2016) for which engine shafts are connected to independent motor/generator shafts through gearboxes. The engine model interacts with electrical system models through shaft inertia blocks shown in Figure 4.



**Figure 4. Schematic diagram of engine-electrical system interaction**

Net torque from engine shaft,  $P_{net}$ , for each drivetrain is:

$$P_{net} = P_{Turb} - P_{Comp} \quad (3)$$

$P_{Turb}$  is generated power by turbine to drive its corresponding compressor which consume  $P_{Comp}$ . If the rotor is assumed to be solid, Newton's second law gives:

$$P_{net} + P_{Elec} = J\omega\dot{\omega} \quad (4)$$

where  $J$  and  $\omega$  are drivetrain moment of inertia and engine shaft speed respectively and  $P_{Elec}$  is electrical torque imposed on engine shaft by electrical machines through gearbox.

A bump-less override control structure has been implemented for the turbofan with limit controllers for over-temperature, surge and bleeding pressure for Environmental Control System (ECS).

## RESULTS

Maps from GASTURB have been used to model a two-spool high bypass ratio (BPR=8) unmixed flow 140 kN turbofan. LPT drives fan and LPC on LP shaft while HPT drives axial HPC and radial HPC.

In order to investigate the idea of power exchange between shafts, considering losses in gearbox, electrical machine and converter, total power transfer efficiency is assumed to be 90 %.

For figures 5-11 negative power transfer means from HP to LP shaft and positive means from LP to HP shaft and per-unit quantities are fractions of their amount during engine maximum available thrust.

Since power circulation direction depends on the thrust demand, results are presented for different flight scenarios.

### Cruise

The engine has already been designed to deliver a specific amount of thrust during cruise to create optimum flight speed for the aircraft to have maximum propulsion efficiency. For this reason, a controller has been designed for the engine model to keep the calculated thrust at its fixed ADP value while exchanging power between shafts.

TSFC is plotted in Figure 5 together with per-unit calculated thrust. It can be seen that thrust starts to decrease beyond 700 kW when Turbine Inlet Temperature (TIT) hits its limit.

Power transfer from HP shaft to LP shaft not only increases compression efficiency, but also increases the speed of the fan, mounted on LP shaft, which produces main portion of thrust for high bypass ratio turbofans where for a fixed amount of thrust, TSFC is minimum around -750 kW power transfer.

To assess the impact at cruise, almost 4.2 % change in TSFC is observed around ADP for a fixed amount of thrust with  $\pm 1$  MW electric power transfer. Whereas, assuming the existing ADP in the model to be consistent with real engine ADP, fuel consumption of the engine at cruise condition can be reduced up to 1.04%.

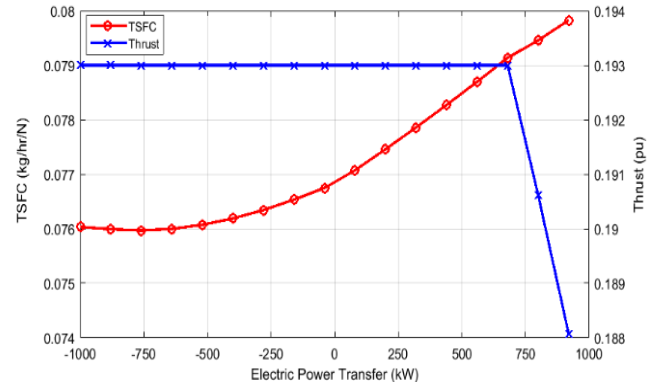

**Figure 5. TSFC and per-unit thrust (cruise)**

Figure 6 shows the increase in engine efficiency is not free of charge, where, as discussed before, transferring power from HP to LP decreases LPC and axial HPC surge margin since radial HPC acts as a blockage with a drop in its speed.

Higher surge margin is considered for ADP to create excessive safety margins at other critical flight scenarios such as ISA SLS. While, with less probability of surge at cruise condition, it can be allowed to decrease with power transfer from HP to LP shaft.

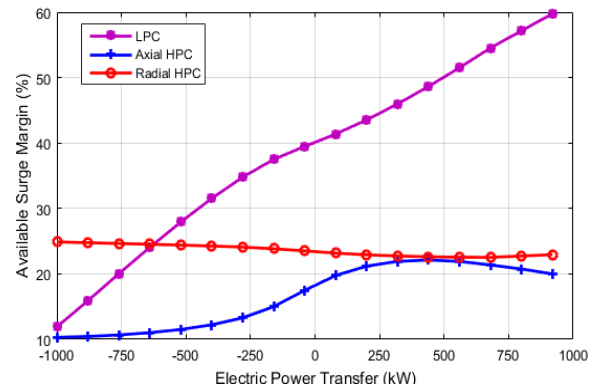
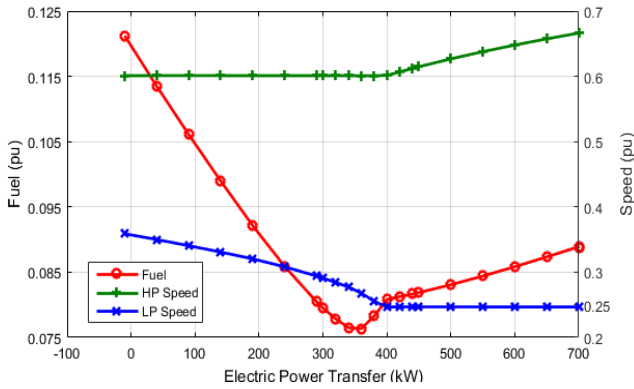

**Figure 6. Available surge margin (cruise)**

### Ground Idle

In order to keep the engine operation within its limits while allowing immediate recovery of thrust during power transfer, the controller must maintain HP speed at its default minimum idle setting. Consequently, by transferring power from LP to HP shaft, LP speed drops up to a minimum permissible speed where the LP speed controller overrides HP speed controller.

With higher HP speeds HPC can afford more massflow which is accordingly provided by scheduled VBVs. Figure 7 shows transferring power from LP to HP shaft, while maintaining minimum HP speed at idle ground, decreases fuel consumption up to 33% at 350 kW power transfer. For this configuration a minimum LP speed controller at idle should also be implemented since LP speed drops when LPT cannot provide enough power at lower speeds.



**Figure 7. Fuel consumption and LP-HP speeds (ground idle)**

Illustrated in Figure 8, the calculated thrust also decreases up to 85%, which is favourable for ground idle to have less braking effort, noise and fuel consumption.

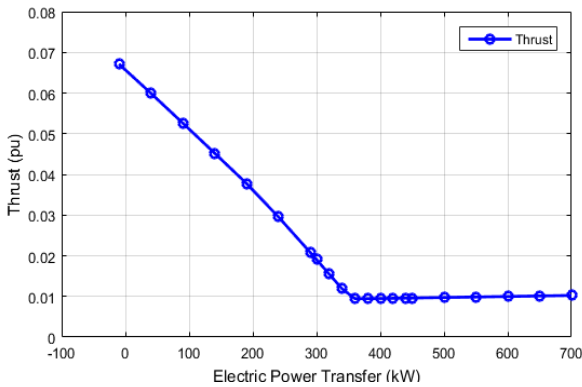

**Figure 8. Calculated thrust (ground idle)**

Increased surge margin, as expected due to higher HPC corrected speed, is another achievement which is shown in Figure 9. However slipping back beyond 350 kW up to 400 kW. This is mainly due to HPC upstream pressure increase due to increase T41 (equation 2) at constant massflow while beyond 400 kW, massflow starts to increase consistently with pressure ratio.

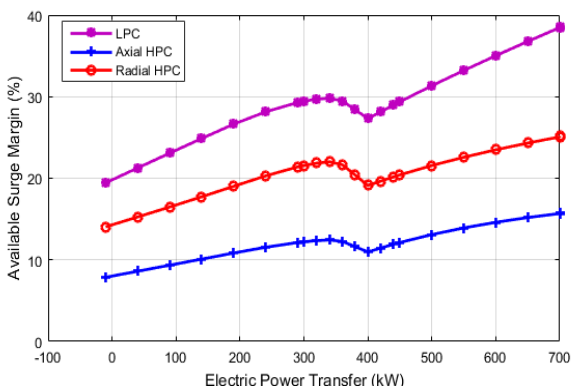
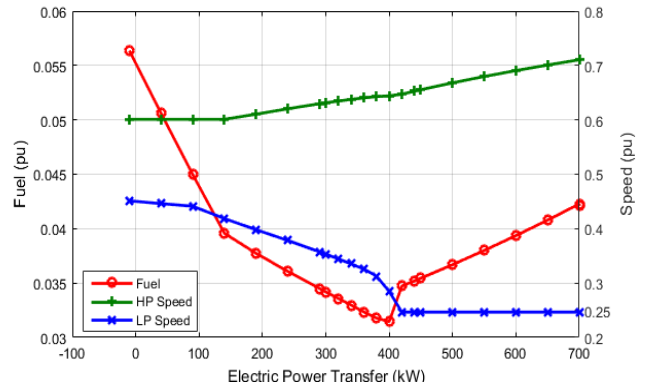

**Figure 9. Available surge margin (ground idle)**

### Flight Idle

During descent, flight idle mode is selected where bleeding pressure should not be lower than a minimum for its

application in ECS. Results for flight idle at 20000 ft, presented in Figure 10 and Figure 11, show the fact that between 150 kW and 410 kW, p30 limit controller protects against the supply pressure for ECS (Linke-Diesinger, 2010) which has been assumed to be 210 kPa for this engine. The amount of fuel burn reduction during descent is up to 43% at 400 kW (Figure 10) together with considerable increase in available surge margin (Figure 11).



**Figure 10. Fuel consumption and shaft speeds (flight idle-20000ft)**

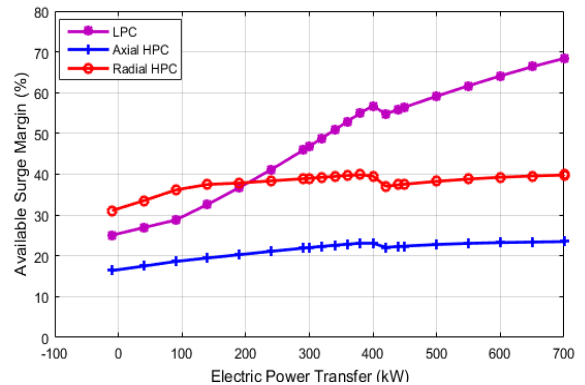

**Figure 11. Available surge margin (flight idle-20000ft)**

### FUTURE WORK

The highly controversial concerns of this idea are its added weight and occupied space which should be scrutinized in terms of aircraft overall propulsion efficiency. Other factors such as proper electrical machine and power electronics design for operation on wide speed span, system fault scenarios, etc. can be challenging as well.

In addition to this, other flight scenarios such as transient modes should be studied as well. Another interesting area of research can be integration of energy storage system into this configuration since its application in aircraft propulsion is conceivable with its evolutionary development in terms of power density.

### CONCLUSION

This paper presented a conceptual study of the novel idea of power circulation between shafts through electrical machines on both LP and HP shafts connected to dc bus

through bidirectional AC-DC convertors. Results for a 140 kN thrust turbofan show that depending on the amount of power exchange up to 1% fuel saving can be reached for cruise condition, however, suffering the penalties for compressor surge margins. While at low speed settings such as ground and flight idle settings, transferring power from LP to HP is favourable in terms of fuel saving, compressor surge margins and thrust management. For the studied engine, 400 kW power transfer will decrease the amount of fuel consumption by 33% and 42% for ground and flight idle settings respectively and decreases thrust for ground idle by 80%.

The achievements represented by this novel configuration, however, should be more evaluated taking into account the impact of its penalties such as weight and space on overall propulsion efficiency.

## NOMENCLATURE

$W$	massflow
$p$	pressure
$P$	power
$T$	temperature
$f$	fuel to air ratio
$LHV$	fuel low heat value
$\bar{c}_p$	specific heat capacity at constant pressure
$A$	area
$T$	torque

## ACKNOWLEDGMENTS

This project has received funding from the Clean Sky 2 Joint Undertaking under the European Union's Horizon 2020 research and innovation programme under grant agreement No 807081.

## REFERENCES

Avery C. R., Burrow S. G., and Mellor P. H. (2007). Electrical generation and distribution for the more electric aircraft. 42nd International Universities Power Engineering Conference, vols 1-3, 1007-1012. DOI: Doi 10.1109/Upec.2007.4469088.

Bhangu B. S., and Rajashekara K. (2014). Electric starter generators their integration into gas turbine engines. IEEE Industry Applications Magazine, 20, 14-22. DOI: 10.1109/Mias.2013.2288398.

Boyce M. P. (2017). Gas Turbine Engineering Handbook, Elsevier Science.

Enalou H. B., Rashed M., Kulsangcharoen P., Hill C. I., and Bozhko S. (2016). Nonlinear aircraft engine model for future integrated power center development. 2016 International Conference on Electrical Systems for Aircraft, Railway, Ship Propulsion and Road Vehicles & International Transportation Electrification Conference (ESARS-ITEC), <Go to ISI>://WOS:000399133700079.

Enalou H. B., Soreshjani E. A., Rashed M., Yeoh S. S., and Bozhko S. (2017). A detailed modular governor-turbine model for multiple-spool gas turbine with scrutiny of bleeding effect. Journal of Engineering for Gas Turbines and Power-Transactions of the ASME, 139, <Go to ISI>://WOS:000415790100019.

Gao F., and Bozhko S. (2016a). Modeling and impedance analysis of a single dc bus-based multiple-source multiple-load electrical power system. IEEE Transactions on Transportation Electrification, 2, 335-346. DOI: 10.1109/Tte.2016.2592680.

Gao F., Bozhko S., Asher G., and Wheeler P. (2015). Comparative study of power sharing strategies for the dc electrical power system in the MEA. SAE International. DOI: https://doi.org/10.4271/2015-01-2410.

Gao F., Bozhko S., Asher G., Wheeler P., and Patel C. (2016b). An improved voltage compensation approach in a droop-controlled dc power system for the more electric aircraft. IEEE Transactions on Power Electronics, 31, 7369-7383. DOI: 10.1109/Tpel.2015.2510285.

Jia Y. J., and Rajashekara K. (2017). An induction generator-based ac/dc hybrid electric power generation system for more electric aircraft. IEEE Transactions on Industry Applications, 53, 2485-2494. DOI: 10.1109/Tia.2017.2650862.

Kerrebrock J. L. (2001). Aircraft Engines and Gas Turbines, MIT Press.

Kurz R., and Brun K. (2001). Degradation in gas turbine systems. Journal of Engineering for Gas Turbines and Power-Transactions of the ASME, 123, 70-77. DOI: Doi 10.1115/1.1340629.

Lattime S., and Steinetz B. (2002). Turbine engine clearance control systems: Current practices and future directions. 38th AIAA/ASME/SAE/ASEE Joint Propulsion Conference & Exhibit. American Institute of Aeronautics and Astronautics. https://doi.org/10.2514/6.2002-3790

Linke-Diesinger A. (2010). Systems of Commercial Turbofan Engines: An Introduction to Systems Functions, Springer Berlin Heidelberg.

Meher-Homji C. B., Chaker M. A., and Motiwala H. M. (2001). Gas turbine performance deterioration. Texas A&M University. Turbomachinery Laboratories. DOI: https://doi.org/10.21423/R19Q1P.

Muehlbauer K., and Gerling D. (2010). Two-generator-concepts for electric power generation in more electric aircraft engine. The International Conference on Electrical Machines - ICEM 2010, 6-8 Sept. 2010. 1-5. DOI: 10.1109/ICELMACH.2010.5607966.

Provost M. J. (2002). The more electric aero-engine: a general overview from an engine manufacturer. International Conference on Power Electronics, Machines and Drives, 246-251, <Go to ISI>://WOS:000177846400043.

Razak A. M. Y. (2007). Industrial Gas Turbines: Performance and Operability, Elsevier Science.

Walsh P. P., and Fletcher P. (2008). Gas Turbine Performance, Wiley.