

HEXAFLY-INT Project: Design of a High Speed Flight Experiment

S. Di Benedetto, M. P. Di Donato, A. Rispoli, S. Cardone, J. Riehmer, J. Steelant, L. Vecchione

Abstract—Thanks to a coordinated funding by the European Space Agency (ESA) and the European Commission (EC) within the 7th framework program, the High-Speed Experimental Fly Vehicles – International (HEXAFLY-INT) project is aimed at the flight validation of hypersonics technologies enabling future trans-atmospheric flights. The project, which is currently involving partners from Europe, Russian Federation and Australia operating under ESA/ESTEC coordination, will achieve the goal of designing, manufacturing, assembling and flight testing an unpowered high speed vehicle in a glider configuration by 2018. The main technical challenges of the project are specifically related to the design of the vehicle gliding configuration and to the complexity of integrating breakthrough technologies with standard aeronautical technologies, e.g. high temperature protection system and airframe cold structures. Also, the sonic boom impact, which is one of the environmental challenges of the high speed flight, will be assessed. This paper provides a comprehensive and detailed update on all the current projects activities carried out to date on both the vehicle and mission design.

Keywords—Design, flight testing, hypersonics, integration.

I. INTRODUCTION

THE HEXAFLY-INT project is devoted to in-flight testing of enabling technologies for future hypersonic flights. The HEXAFLY Experimental Flight Test Vehicle (EFTV) is planned to be launched by the Brazilian VS43 launcher, which will perform a suborbital trajectory having an apogee at 90 km.

The experimental payload, shown in Fig. 1, is composed by the EFTV and the Experimental Support Module (ESM). This latter has the aim of controlling the vehicle attitude at the higher altitudes by means of cold gas Reaction Control Systems thrusters. At a specific altitude the ESM will be released and the EFTV will autonomously handle its flight attitude by two ailerons.

The EFTV will be equipped with an avionic system composed by an inertial measurement unit (IMU), GPS, servo-

actuators, a mission specific flight control computer (FCC) which will ensure the on-board mission management. The vehicle will also be equipped with an in-flight measurement system which will acquire pressure and temperature data sensors for the sake of post flight analysis and simulation tools validation. The on-board avionic will also include a downlink telemetry system which will transmit all the mission data to the Ground Control Station (GCS) located in Alcantara, Brazil.

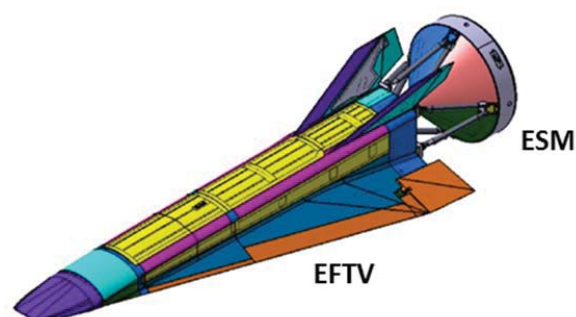

Fig. 1 Experimental payload

II. BACKGROUND

The HEXAFLY-INT project stems from the interest of Europe in hypersonic civil transportation vehicles. In the past ten years projects like LAPCAT and LAPCAT II [1], [2], as well as ATLLAS I & II [3], [4] helped to identify the major challenges in the development of hypersonic vehicles for long distance civil transport. Among the major technology challenges, the application of high-temperature materials originally developed for single use applications (e.g. re-entry vehicles) is currently under investigation for the long-life benefit and multiple mechanical-thermal cycles withstanding capability. Also, environmental impact issues such as sonic boom propagation and pollutant emissions (NO_x) may be considered still as challenges requiring mitigation measures. Therefore, the preceding HEXAFLY project [5] aimed to demonstrate the feasibility of these different aspects in dedicated experimental flight campaigns either with combined or dedicated technologies demonstrations. In order to achieve the scientific goals of the projects, by means of flight testing, a mission profile was defined.

III. MISSION DEFINITION AND SCENARIO

The major HEXAFLY-INT objective is to perform a high-speed flight experiment as a glider without the presence of an internal flowpath with a target flight Mach number of 7 to 8

S. Di Benedetto, M.P Di Donato, A. Rispoli and L. Vecchione are with the Italian Aerospace Research Center, Aeronautical Department, Via Maiorise, 81043 Capua, Italy (phones: +39-0823623377, +39-0823623254, +39-0823623348, +39-0823623918 fax: +39-0823623700; e-mails: s.dibenedetto@cira.it, m.didonato@cira.it, a.rispoli@cira.it, l.vecchione@cira.it).

S. Cardone is with Technosystem-Engineering and Technology, 80133 Naples, Italy (phone +39 081 5512292, fax: +39 081 5520290, email: scardone@tecnosistemspa.it).

J. Riehmer is with the Deutsches Zentrum für Luft- und Raumfahrt, email: Johannes.Riehmer@dlr.de

J. Steelant is with the European Space Agency, ESTEC-ESA, Keplerlaan 1, P.O. Box 299, 2200 AG Noordwijk, The Netherlands (phone +31/71/565.5552; Fax: +31/71/565.5421; email: Johan.Steelant@esa.int).

and altitude range in between 27 and 33 km, collecting a large amount of experimental data.
 The vertical launch is planned from the Centro de Lançamento de Alcântara (CLA) in Brazil; the launcher

trajectory is described in Fig. 2. The total ground range is of about 1200 km.

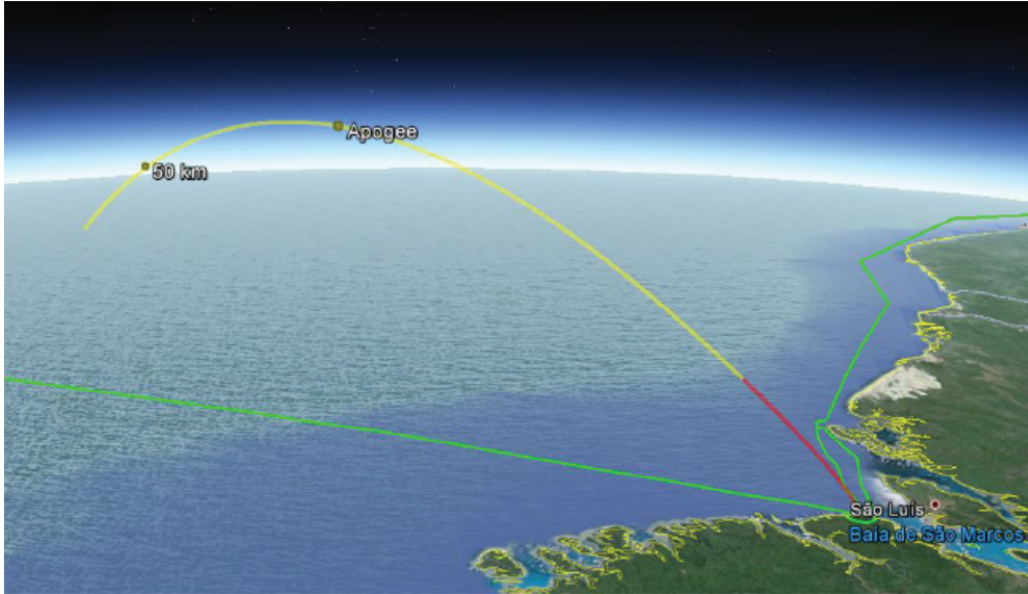

Fig. 2 Planned launch trajectory from CLA: Both the EFTV+ESM are planned to be released together from the rocket stage at an altitude of 90 km

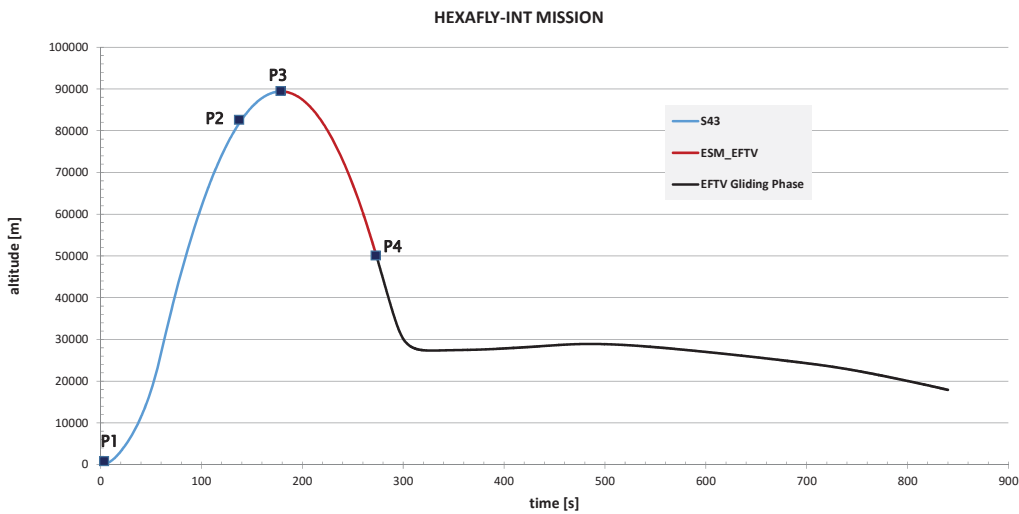

Fig. 3 HEXAFLY-INT flight trajectory; altitude vs time

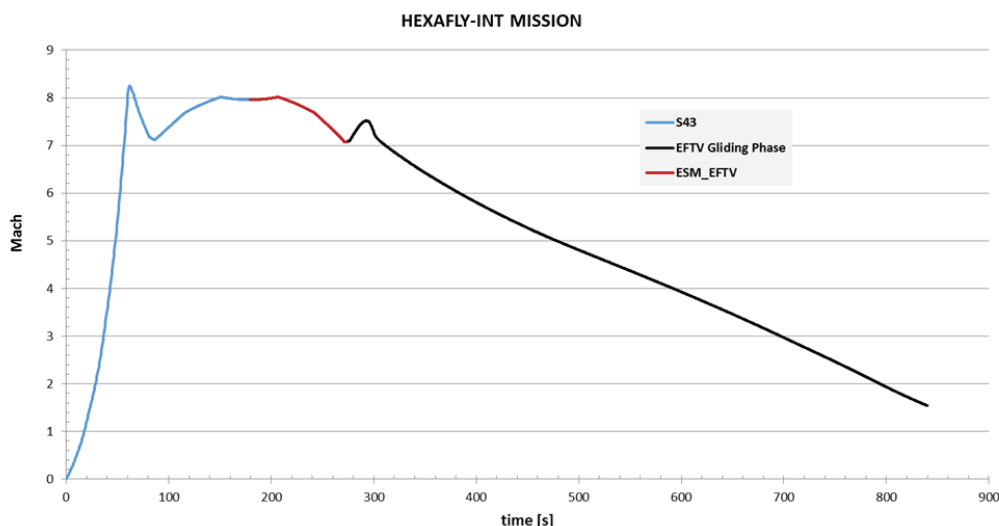

Fig. 4 HEXAFLY-INT flight trajectory; Mach number vs time

Both the EFTV+ESM are planned to be released together from the rocket stage at an altitude of 90 km.

During the early phase of its descent flight segment, the EFTV is docked to the Experimental Service Module (ESM) that has the goal to control the vehicle attitude by means of cold gas Reaction Control Systems thrusters (RCS). After the separation from the ESM, at about 50 km, a pull-out manoeuvre brings the EFTV at a target altitude of 32km where the experimental phase starts in controlled hypersonic cruise at approximately Mach 7.

The mission reference trajectory in terms of altitude vs time is shown in Fig. 3. The following critical points have been indicated:

- P1: Lift-Off;
- P2: Fairing Ejection;
- P3: Payload release;
- P4: ESM separation.

Mach number trajectory profile is shown in Fig. 4.

As no recovery of the payload is foreseen, the reception of experimental data is guaranteed by telemetry (TM).

To cover the full range of about 1200 km, in addition to the main TM station positioned at the launch range, a second station will be placed within the maximum range defined for the mission in a position still to be defined.

IV. EFTV AND ESM CONFIGURATION DESIGN

A. Cold Structure

The main structure of HEXAFLY-INT is composed by two sub systems: EFTV and ESM. The separation of ESM from the EFTV is realized by pyro-bolts.

The EFTV cold structure is composed by the following major items: fuselage, wings and fins.

The fuselage structure, realized with a buildup approach, is composed by the three main sections represented in:

- a. forward (FWD) fuselage
- b. central (CTR) fuselage
- c. rear fuselage

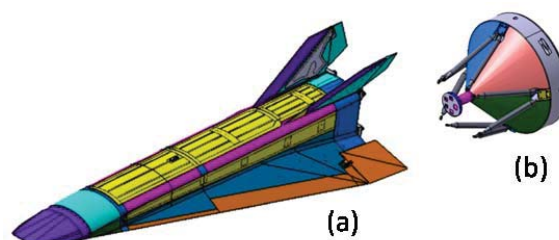

Fig. 5 (a) EFTV and (b) ESM

The fuselage structure is composed by milled frames, upper beam and panels. The assembly of fuselage structure is realized by joining upper beam frames and lower panels with fixed bolts while the upper panels are joined to the frames and upper beams by removable bolts in order to allow the access inside of the fuselage for the installation of internal equipment.

The rear fuselage is composed by two shells and a rear panel. The upper part is joint with a bolted strap, the bottom with an overlap between the two shells also joined with fixed bolts. The rear panel is joined with removable bolts to allow the access to the internal part of fuselage; a hole is also foreseen for the installation of pyro-bolts.

The structure of the ESM is composed by eight interconnected struts, a main frame with a cylindrical shape and a two cross frames to support the 4 panels (see Fig. 7). The joints at the front part are connected to the EFTV with four pyrotechnic bolts.

ESM to EFTV assembly is realized by four fittings with two lugs to fix the rods coming from ESM. The fittings are bolted to the rear fuselage by four pyro-bolts.

B. Hot Structure and Thermal Protection System

Due to the severe conditions encountered during the flight, a multilayer ZrO_2 coating is expected to protect the metallic parts of the EFTV external structure. Moreover, high temperature materials have been selected for the most critical parts, i.e. nose, wings leading edge, aileron and vertical tail

leading edge (see Fig. 8).

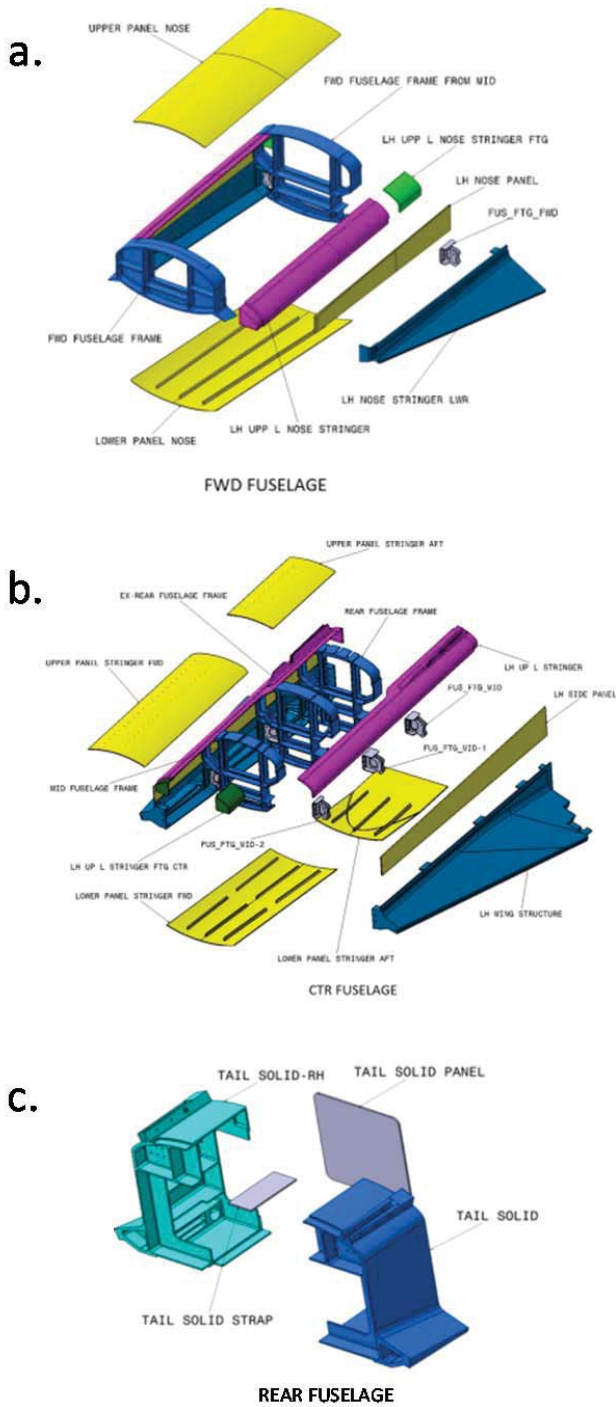

Fig. 6 EFTV cold structure main parts: (a) forward, (b) central and (c) rear fuselage

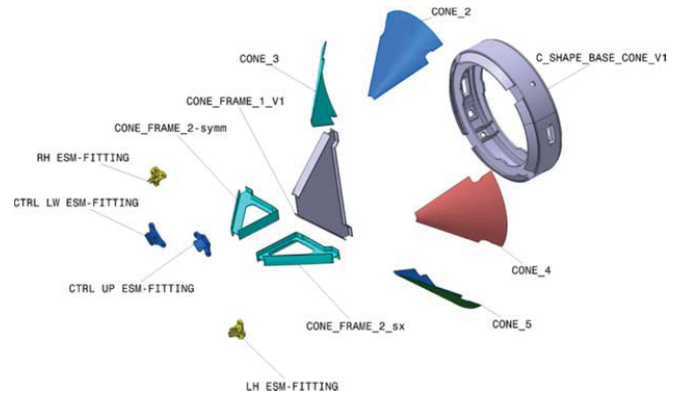

Fig. 7 ESM structure main parts

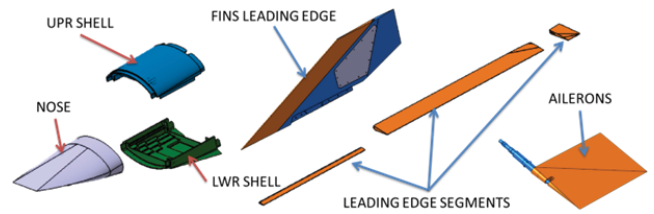

Fig. 8 EFTV hot structures

Coated copper is the material used for the nose and the V-tail leading edge acting as heat sinks throughout the trajectory.

The remaining parts (wings leading edge and aileron) are realized by DLR-St in CMC (Carbon Matrix Composite) material.

Maximum temperatures expected along the flight trajectory for the different parts have been evaluated by means of the Finite Element Method implemented in the software Ansys, and are plotted in Fig. 9.

The materials selected for the different vehicles components are summarized in Fig. 10, showing that zirconia coating and C/SiC components would widely survive the aerothermal environment, whereas some critical spots exist for the titanium structure.

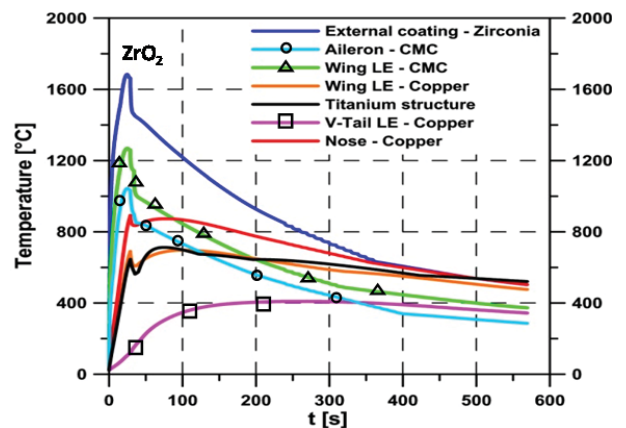

Fig. 9 Maximum temperatures along the flight trajectory on the main vehicle components [6]

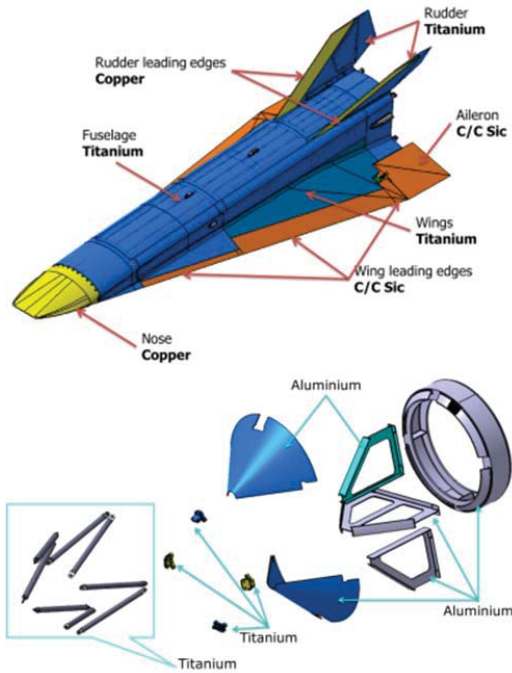

Fig. 10 Payload materials

V. ON-BOARD SYSTEMS

The functions of Mission management, Guidance, Navigation and Communication to ground and Power

Management are performed by EFTV on board systems both for the flying test bed (EFTV itself) and ESM. IMU, GPS, control actuators, and FCC are dedicated to vehicle Guidance, Navigation and Control.

A sensor suite is integrated along the vehicle to carry out the measurement of pressure, temperature and thermo-mechanical deformations. The In Flight Measurement system-DAQ collects and conditions those data for the scientific purposes of the mission. The Telemetry and Telecommand Unit with the antenna system performs the Communication function with the mission control centre.

The control of the vehicle attitude after the Payload release and before the ESM separation is performed by means of the cold gas Reaction Control Systems (CGS) unit that commands the thruster system. The on-board systems are connected to each other in a network to exchange data for a proper mission management. The functional scheme of the links established among the systems is sketched in Fig. 11.

The Power Management function is ensured by the power supply system. Electrical power is supplied to on board systems and actuators by rechargeable Li-ion batteries. The Power control unit manages the power supply along all the mission phases, contributing to the mission success.

On-board systems are installed as sketched in Fig. 12.

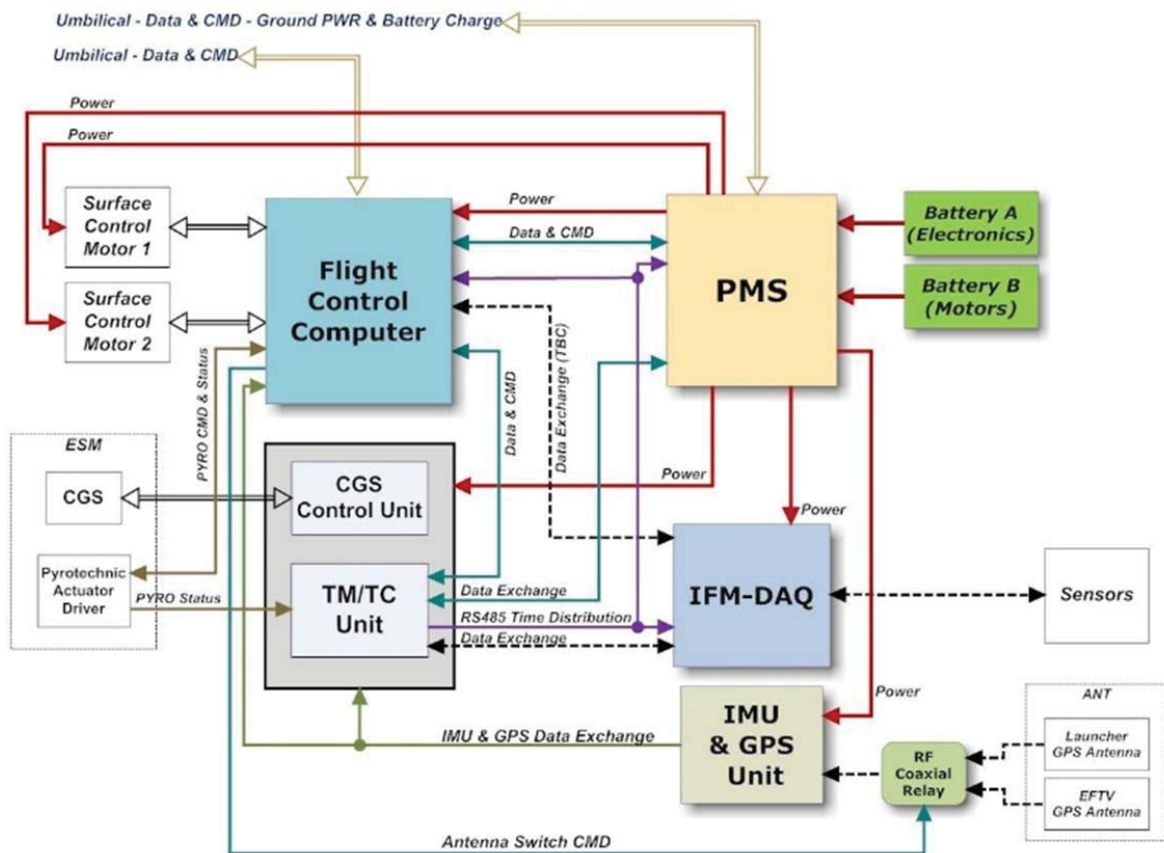

Fig. 11 HEXAFLY-INT On Board Systems architecture

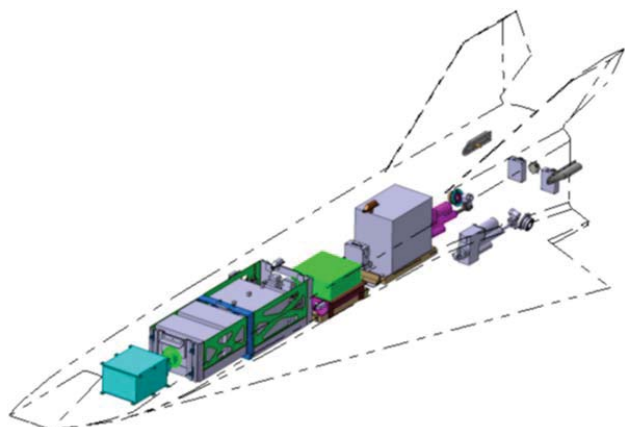

Fig. 12 On-board systems installation

VI. INFLIGHT EXPERIMENTS

The inflight experiment is a fundamental task of the project. The main experimental investigations focused on are:

- Free stream quantities derivation by means of Flush Air Data System (FADS) integration;
- Aerodynamic heating
- Flap separation and gap-flow;
- Transition;
- Shock wave boundary layer interaction
- Wake and corner flow;
- Internal structure stress determination;
- Internal health monitoring;
- Visual vehicle status.

The instrumentation layout has been defined in order to cover the above different scientific objectives with different sensor types mounted in the interested regions. More than one hundreds sensors will collect flight data as described in Fig. 13.

Position	Subsystem	Comment	Pressure	Structural	Temperature	Surface Temperature (HF)	Heatflux	Strain	Acceleration	Sum
Nose	FADS	Orientation/Heating	8	4						12
Top Side	Body	Heating/Aerodynamics	2	2	5	1			2	12
	Wing	Heating/Aerodynamics	2	2					2	6
Bottom Side	Body	Heating/Aerodynamics/Transition	3	2	14	5				24
	Wings	Heating/Aerodynamics/Transition	2	2	6					10
Leading Edges		Heating/Structural			12					12
Vertical Fins		Transition/Heating/SWBL			11			6	2	19
Rudder		Heating/Structural		5				2	2	9
Base		Wake flow	1	3	2					6
Internal Structure		Health Monitoring			8			4		12
Total			18	51	27	6	12	8		122

Fig. 13 Preliminary in-flight sensors layout (DLR-Co)

Additionally, five cameras, three external and two internal, will be used to get visual feedback from the vehicle flight status and get temperature measurements of the Temperature Sensitive Paint (TSP).

Two external cameras are mounted in the fuselage lateral part with the main task aim to observe the motion of the rudders. The third one is installed in the aft of the EFTV to observe the separation process of the ESM and to track the position during the separation.

The two internal cameras will be used to monitor the TSP on the upper and lower side of the fuselage.

VII. CONCLUSIONS

The key features of the HEXAFLY-INT mission and flight payload have been described.

The project has the final aim to demonstrate the technical feasibility of concepts and technologies for the hypersonic flight and to increase the Technology Readiness Level (TRL) of the breakthrough technologies on board.

Project Critical Design review (CDR) is foreseen by the end of 2016.

ACKNOWLEDGMENT

This work was performed within the 'High-Speed Experimental Fly Vehicles-International' project fostering International Cooperation on Civil High-Speed Air Transport Research. HEXAFLY-INT, coordinated by ESA-ESTEC, is supported by the EU within the 7th Framework Programme Theme 7 Transport, Contract no.: ACP0-GA-2014-620327 and by the Ministry of Industry and Trade, Russian Federation. Further info on HEXAFLY-INT can be found on <http://www.esa.int/hexafly-int>.

REFERENCES

- [1] Steelant J., 'Achievements obtained for sustained hypersonic flight within the LAPCAT project', 15th AIAA International Space Planes and Hypersonic Systems and Technologies Conference. Dayton, OH: AIAA 2008-2578, 2008.

- [2] Steelant J., Varvill R., Defoort S., Hanneman K. and Marini M., '*Achievements Obtained for Sustained Hypersonic Flight within the LAPCAT-II Project*', 20th AIAA International Space Planes and Hypersonic Systems and Technologies Conference, 06-09 July 2015, AIAA-2015-3677, Glasgow (UK).
- [3] Steelant J., "Achievements obtained on Aero-Thermal Loaded Materials for High-Speed Atmospheric Vehicles within ATLLAS", AIAA-2009-7225, 16th AIAA/DLR/DGLR International Space Planes and Hypersonic Systems and Technologies Conference, Bremen, Germany, October 19th-22nd, 2009.
- [4] Bouchez M. et al., 'Combustor and Material Integration for High Speed Aircraft in the European Research Program ATLLAS2', 19th AIAA Hypersonic Space Plane Conference, Atlanta, Georgia, US, AIAA-2014-2950.
- [5] Steelant J., Langener T., Hannemann K., Riehmer J., Kuhn M., Dittert C., Jung W., Marini M., Pezzella G., Cicala M. and Serre L., 'Conceptual Design of the High-Speed Propelled Experimental Flight Test Vehicle HEXAFly', 20th Int. Space Planes and Hypersonic Systems and Technology Conference, AIAA-2015-3539, 5-8 July 2015, Glasgow, UK.
- [6] V. Carandente et al., "Finite Element Thermal Design of the Hexafly-INT Experimental Flight Test Vehicle", 6th European Conference for Aeronautics and Space Sciences (EUCASS), Kraków, Poland, July 2015.