

# 1G2A IMU\GPS Integration Algorithm for Land Vehicle Navigation

O. Maklounf, Ahmed Abdulla

**Abstract**—A general decline in the cost, size, and power requirements of electronics is accelerating the adoption of integrated GPS/INS technologies in consumer applications such Land Vehicle Navigation. Researchers have looking for ways to eliminate additional components from product designs. One possibility is to drop one or more of the relatively expensive gyroscopes from microelectromechanical system (MEMS) versions of inertial measurement units (IMUs). For land vehicular use, the most important gyroscope is the vertical gyro that senses the heading of the vehicle and two horizontal accelerometers for determining the velocity of the vehicle. This paper presents a simplified integration algorithm for strap down (ParIMU)\GPS combination, with data post processing for the determination of 2-D components of position (trajectory), velocity and heading. In the present approach we have neglected earth rotation and gravity variations, because of the poor gyroscope sensitivities of the low-cost IMU and because of the relatively small area of the trajectory.

**Keywords**—GPS, ParIMU, INS, Kalman Filter.

## I. INTRODUCTION

THE most popular partial IMU (ParIMU) configuration for land vehicles consists of one heading gyro (Gz) plus two horizontal accelerometers (Ax and Ay), which we denote as 1G2A. As a result, considerable research has recently been directed towards finding ways to minimize gyroscope usage in the INS or even developing gyro-free INS systems. One possibility is to drop one or more of the relatively expensive gyroscopes from micro electro mechanical system (MEMS) versions of inertial measurement units (IMUs). This design is based on the fact that the removed sensors provide minimal navigation information for land vehicles. For example, the vertical accelerometer (Az) mainly outputs constant gravity plus vehicle bumps, while the roll and pitch gyros (Gx and Gy) are mainly sensing the angular bumping of the vehicle. Besides, land vehicle navigation normally concentrates on the horizontal location rather than the vertical height [1].

An efficient way to reduce the expense of these systems is to reduce the number of gyros and accelerometers, therefore, to use a (ParIMU) configuration. For land vehicular use, the most important gyroscope is the vertical gyro that senses the heading of the vehicle and two horizontal accelerometers for determining the velocity of the vehicle. In the present approach we have neglected earth rotation and gravity variations, because of the poor gyroscope sensitivities of our

low-cost IMU and because of the relatively small area of the trajectory.

## II. INERTIAL NAVIGATION

The basic principle of an INS is based on the integration of accelerations observed by the accelerometers on board the moving platform. The system accomplishes this task through appropriate processing of the data obtained from the specific force and angular velocity measurements. Thus, an appropriately initialized inertial navigation system is capable of continuous determination of vehicle position, velocity and attitude without the use of the external information [2].

A major advantage of using inertial units is that given the acceleration and angular rotation rate data in three dimensions, the velocity and position of the vehicle can be evaluated in any navigation frame. For land vehicles, a further advantage is that unlike wheel encoders, an inertial unit is not affected by wheel slip. However, the errors caused by bias, scale factors and non-linearity in the sensor readings cause an accumulation in navigation errors with time and furthermore inaccurate readings are caused by the misalignment of the unit's axes with respect to the local navigation frame. This misalignment blurs the distinction between the acceleration measured by the vehicles motion and that due to gravity, thus causing inaccurate velocity and position evaluation. Since an inertial unit is a dead reckoning sensor, any error in a previous evaluation will be carried onto the next evaluation, thus as time progresses the navigation solution drifts [3].

Rotational motion of the body with respect to the inertial reference frame may be sensed using gyroscopic sensors and used to determine the orientation of the accelerometers at all times. Given this information, it is possible to transform the accelerations into the computation frame before the integration process takes place. At each time-step of the system's clock, the navigation computer time integrates this quantity to get the body's velocity vector. The velocity vector is then time integrated, yielding the position vector [4]. Hence, inertial navigation is the process whereby the measurements provided by gyroscopes and accelerometers are used to determine the position of the vehicle in which they are installed. By combining the two sets of measurements, it is possible to define the translational motion of the vehicle within the inertial reference frame and to calculate its position within that frame.

## III. GLOBAL POSITIONING SYSTEM

The Global Positioning System is a satellite-based navigation system that was developed by the U.S. Department

of Defense in the early 1970s. Initially developed as a military system, it was later made available to civilians, and is now a dual-use system that can be accessed by both military and civilian users. The GPS consists basically of three segments: the space segment, the control segment, and the user segment. The space segment consists of 24 satellites arranged in 6 orbital planes with an inclination angle of  $55^\circ$  relative to the Earth equator, as shown in Fig. 2. The satellites have approximately an average orbit radius of 20200 km and complete one orbit in 11 hours and 58 minutes. The control segment monitors the health of the orbiting satellites and uploads navigation data. It consists of a system of tracking stations located around the world, including six monitor stations, four ground antennas, and a master control station. The user segment consists of receivers specifically designed to receive, decode, and process the GPS satellite signals [5].

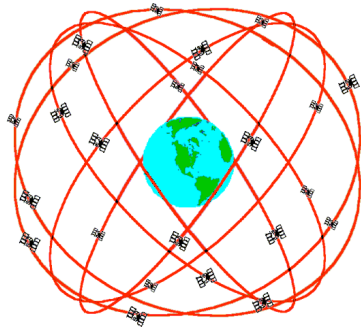

Fig. 1 GPS satellite constellation

#### IV. GPS ERROR SOURCES

There are several sources of error that degrade the GPS position from a theoretical few meters to tens of meters. These error sources are:

- Ionosphere and atmospheric delays
- Satellite and Receiver Clock Errors
- Multi path
- Dilution of Precision
- Selective Availability (S/A).
- Anti Spoofing (A-S).

#### V. TWO DIMENSIONAL REPRESENTATION OF INS

For a vehicle moving in 2D space, it is necessary to monitor both the translational motion in two directions and the change in the direction of vehicle (i.e. rotational motion). Two accelerometers are required to detect the acceleration in two directions. One gyroscope is required to detect the direction of the vehicle (rotational motion) in a direction perpendicular to the plane of motion. Strap down systems mathematically transform the output of the accelerometers attached to the body into the navigation coordinate system before performing the mathematical integration. These systems use the output of the gyroscope attached to the body to continuously update the transformation necessary to convert from body coordinate to navigation. The derivation of the transformation matrix is explained as follow.

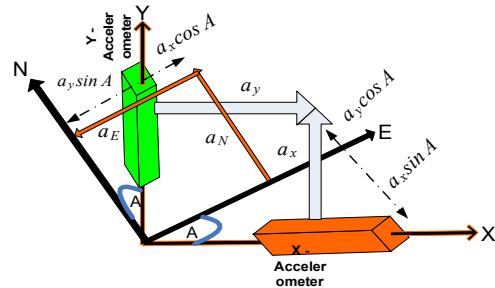

Fig. 2 Two Dimensional vector representation of transformation matrix [4]

As seen from the above Fig. 2 the two accelerometers are fixed in X and Y directions, these directions represent the body coordinates. The measured acceleration will be transformed to the navigation frame (ENU) using the following transformation matrix.

$$\begin{pmatrix} a_E \\ a_N \end{pmatrix} = \begin{pmatrix} \cos \theta & -\sin \theta \\ \sin \theta & \cos \theta \end{pmatrix} \begin{pmatrix} a_x \\ a_y \end{pmatrix} \quad (1)$$

$$a^n = R_b^l a^b \quad (2)$$

where  $a_E, a_N$  are the accelerations in the (East and North directions) navigation frame,  $\theta$  is azimuth angle,  $a^b$  is the acceleration in the body frame defined by the accelerometers and  $R_b^l$  is the rotation matrix which rotates  $a^b$  to the navigation frame.

#### VI. INS 2-D MECHANIZATION EQUATIONS

INS mechanization is the process of determining the navigation states (position, velocity and attitude) from the raw inertial measurements through solving the differential equations describing the system motion. Mechanization is usually expressed by a set of differential equations and typically performed in the local level frame defined by the local east, north and ellipsoid normal. The IMU measurements include one angular rate components provided by the gyroscope and denoted by  $\dot{\theta}$  as well as two linear accelerations components provided by the accelerometers and denoted by the  $2 \times 1$  vector  $\dot{v}_b$ . This means that the angular velocity  $\dot{\theta}$  of the body frame is measured with respect to the inertial frame.

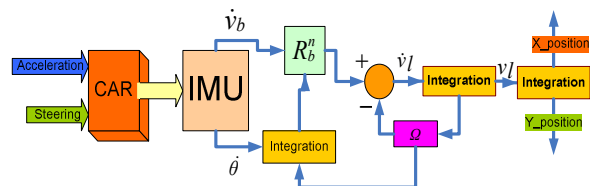

Fig. 3 INS mechanization equations in 2 D

Considering the block diagram shown in Fig. 3, the differential equations describing the INS mechanization equation can be derived as follows; Firstly, the output of the two accelerometers  $\dot{v}_b$  is transformed from the body frame to the navigation frame (local level frame) using the transformation matrix  $R_b^l$  as given in the following equation

$$\dot{v}_l = R_b^l \dot{v}_b \quad (3)$$

where

$$R_b^l = \begin{pmatrix} \cos \theta & \sin \theta \\ \sin \theta & \cos \theta \end{pmatrix} \quad (4)$$

After the transformation of the acceleration components from the body frame to the navigation frame, the velocity components can be derived by integrating the given acceleration in the navigation frame. Consequently the corresponding position can be obtained by double integrating the acceleration in the navigation frame. Also the velocity component of the navigation frame can be directly calculated using the transformation of the velocity component in the body frame using the transformation matrix  $R_b^l$

$$v_l = R_b^l v_b \quad (5)$$

Differentiating equation (9) with respect to time, yields

$$\dot{v}_l = R_b^l \dot{v}_b + \dot{R}_b^l v_b \quad (6)$$

where

$$\dot{R}_b^l = \Omega R_b^l \quad (7)$$

$\Omega$  is a skew symmetric matrix defined as

$$\Omega = \begin{pmatrix} 0 & \theta \\ -\theta & 0 \end{pmatrix} \quad (8)$$

Then

$$\dot{R}_b^l = \Omega R_b^l = \begin{pmatrix} 0 & \theta \\ -\theta & 0 \end{pmatrix} \begin{pmatrix} \cos \theta & -\sin \theta \\ \sin \theta & \cos \theta \end{pmatrix} \quad (9)$$

Therefore (7) can be rewritten as follow

$$\dot{v}_l = R_b^l \dot{v}_b - \Omega R_b^l v_b \quad (10)$$

$$\dot{v}_l = R_b^l \dot{v}_b - \Omega v_l \quad (11)$$

The term  $\Omega v_l$  in (11) represents the angular acceleration induced due to the relative rotation of the body frame with respect to the navigation frame. Finally the acceleration components in the navigation frame can be expressed as

$$\begin{pmatrix} a_E \\ a_N \end{pmatrix} = \begin{pmatrix} \cos \theta & -\sin \theta \\ \sin \theta & \cos \theta \end{pmatrix} \begin{pmatrix} \dot{v}_x \\ \dot{v}_y \end{pmatrix} - \begin{pmatrix} 0 & \theta \\ -\theta & 0 \end{pmatrix} \begin{pmatrix} \cos \theta & -\sin \theta \\ \sin \theta & \cos \theta \end{pmatrix} \begin{pmatrix} v_x \\ v_y \end{pmatrix} \quad (12)$$

## VII. 2-D INS SIMULATION AND TESTING

In order to validate the INS algorithm in 2-D scheme the following steps are carried out:

- Generation of the reference trajectory.
- Carry out the INS simulation in error-free case (i.e. no sensor errors), in order to obtain the derived INS trajectory.
- Accelerometer bias, gyro drift errors, and initial tilt error were taken as case study and their effects on the derived INS trajectory are illustrated.

### A. Reference Trajectory

A car like robot model using Simulink under MATLAB environment (Fig. 4) is used to generate a reference trajectory, more details about modeling of a car like robot can be found in [6]. The suggested reference trajectory consists of nine segments. This reference trajectory has been adopted in all simulation results for analysis and comparison studies in this work. These segments are defined as follows:

1. Straight segment heading east.
2. Left turn segment.
3. Straight segment heading (north).
4. Left turn segment.
5. Straight segment heading (- east).
6. Left turn segment.
7. Straight segment heading (- north).
8. Left turn segment.
9. Straight segment heading east.

The previous illustrated segments are set in a program. The simulation results are recorded and plotted in Figs. 5-7. Fig. 5 shows the reference trajectory in the local level frame. The associated velocity components and heading angle are illustrated in Figs. 6 and 7 respectively.

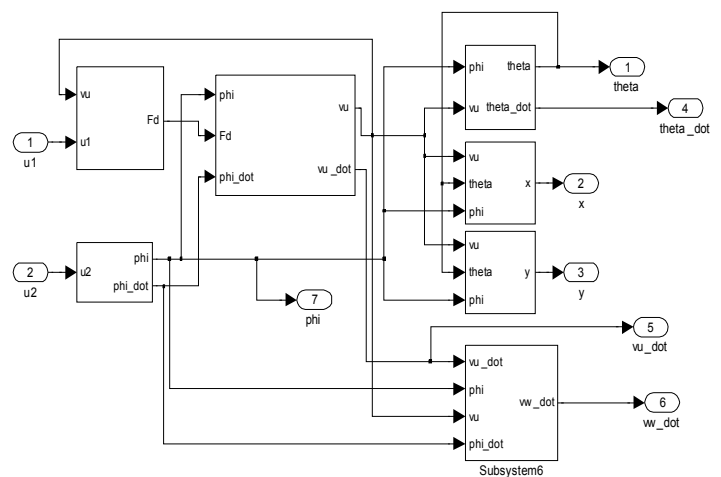

Fig. 4 Modeling Of a Car like robot Using Simulink

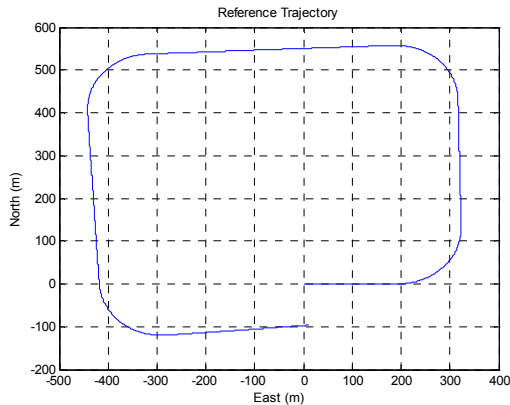

Fig. 5 Reference trajectory in the local level frame

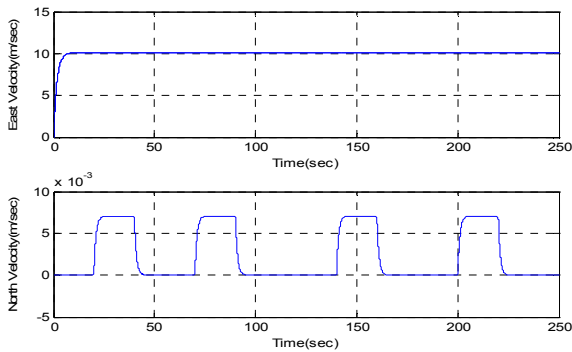

Fig. 6 Velocity components of the reference trajectory

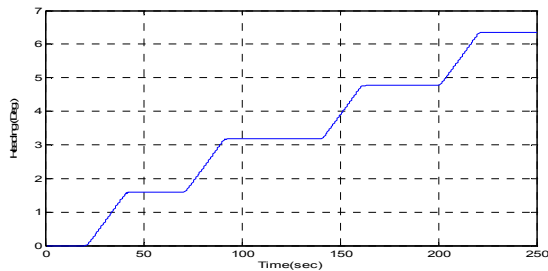

Fig. 7 Heading angle of the reference trajectory

The reference trajectory created earlier is applied as an input for the proposed INS algorithm (Fig. 8). Simulation runs have been conducted to discuss the effect of various types of errors that may degrade the performance of navigation system.

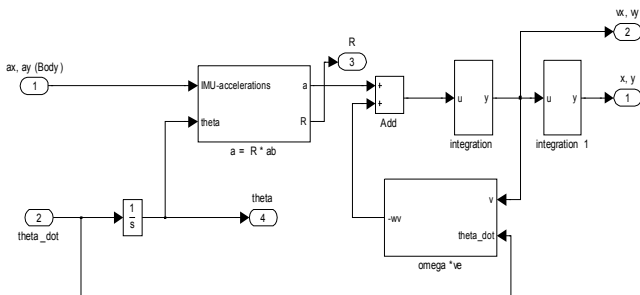

Fig. 8 Block diagram of INS algorithm using Simulink under MATLAB

### B. INS Simulation without Sensor Errors

In this section an INS simulation is demonstrated without sensor errors. The INS derived trajectory matches up quite closely with the truth generated one as shown in Fig. 9. The differences should be due only to imperfect numerical integration. Consequently, Figs. 10 and 11 show the errors in east and north positions between INS derived trajectory and the real trajectory.

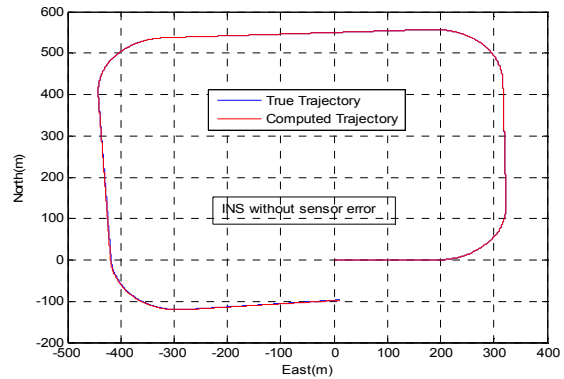

Fig. 9 Reference and INS derived trajectories without sensor errors

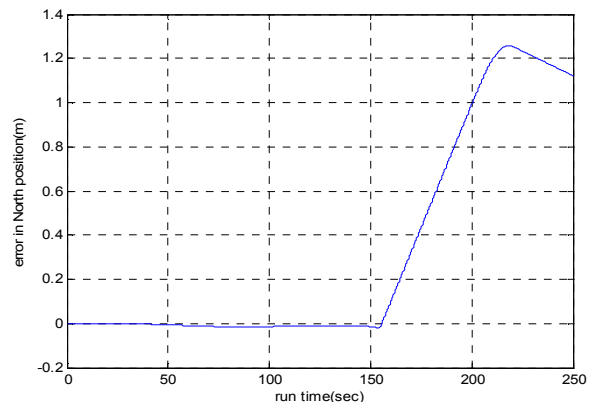

Fig. 10 Algorithm errors in East position

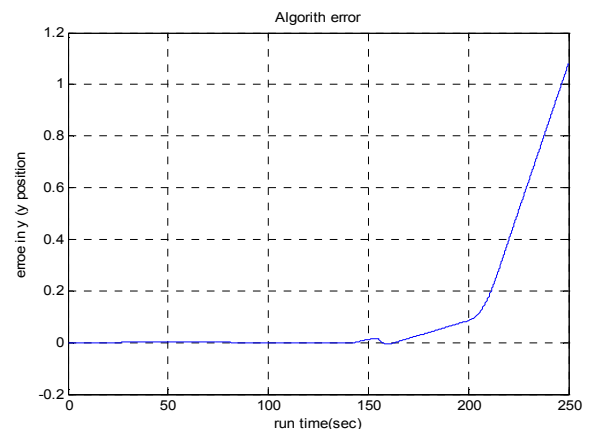

Fig. 11 Algorithm errors in East position

### C. INS Simulation with Sensor Errors

In order to study the effect of the accelerometer bias on the derived INS trajectory, two values have been adopted. The

adopted values are 0.01g and 0.05g which represented the navigation and the tactical grade respectively. First, 0.01g is set into the program. Fig. 12 shows the reference and the derived INS trajectories. Obviously there is a difference between the two trajectories. It is clear that this difference is due to the improper measurement of the accelerometer which in turn, results in improper computation in position. Second, 0.05g accelerometer bias is adopted. As one would expect, the difference between the two trajectories, will increase. This is clear in Fig. 13.

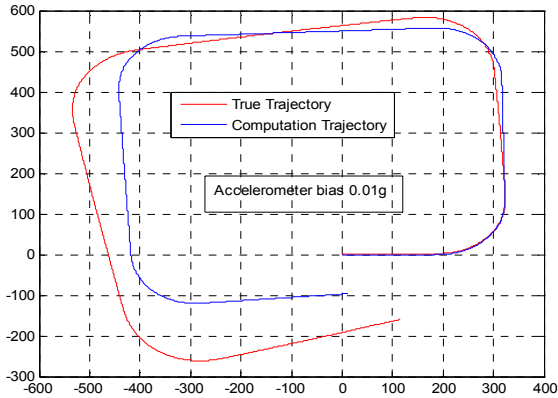

Fig. 12 Reference and INS derived trajectories with 0.01 accelerometer bias

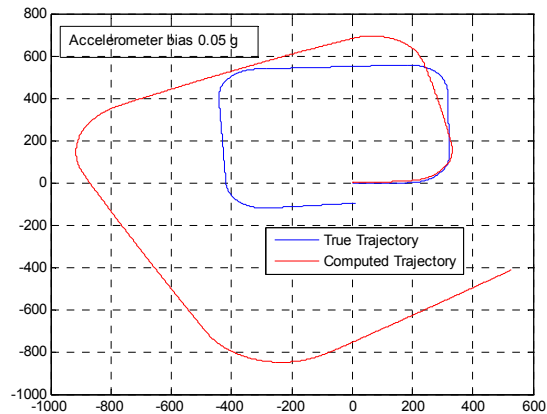

Fig. 13 Reference and INS derived trajectories with 0.05g accelerometer bias

The same scenario is adopted. Two values of gyro bias have been selected. These values are 0.0015 rad/hr and 0.015rad/hr which represented the navigation and the tactical grade respectively. Fig. 14 shows the difference between the reference and the derived INS trajectories when a 0.0015 rad/hr gyro drift is set. Due to this drift which in turn results in improper projection of the accelerometer measurement into the reference frame, a deviation between the two trajectories has been occurred. Clearly when the gyro drift is increased to 0.015rad/hr the deviation between the two trajectories, is increased. This is illustrated in Fig 15.

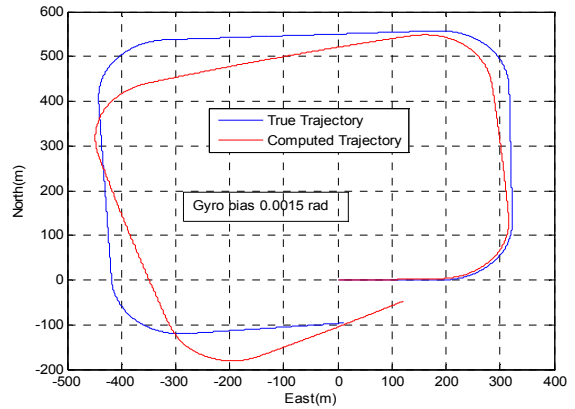

Fig. 14 Reference and INS derived trajectories with 0.15rad/hr gyro drift

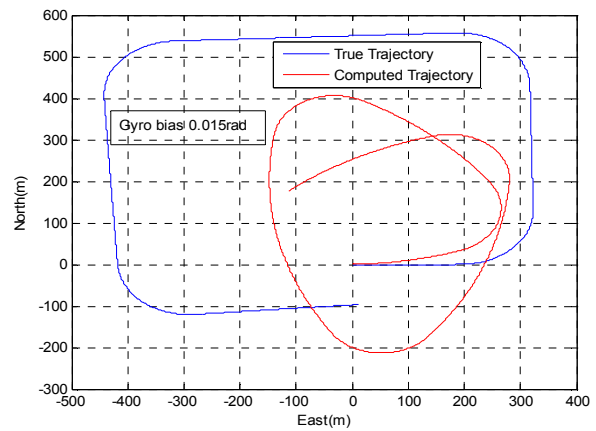

Fig. 15 Reference and INS derived trajectories with 0.15rad/hr gyro drift

Also two values 0.1deg and 0.5 deg as initial tilt error are set to the program. Fig. 16 shows the difference between the two trajectories with tilt error equal to 0.1deg. Obviously, the derived INS trajectory is deviated too much from the reference trajectory. The reason is that, since the horizontal plane is unlevelled, the east and north accelerometer will read a component of the gravity from the beginning instead of reading zero component if the horizontal plane is leveled. Then these components will results in error which accumulated with time. Clearly increasing this tilt error to be 0.5deg, the results get worst. These results are listed in Fig.17.

#### D. Advantages and Limitations of INS

INS is a perfect navigation system, as it provides continuous navigation information without being affected by the surrounding environment. Orthogonal mounted accelerometers and gyroscopes measure specific force and angular rate that can be combined with the mechanization equation and error state equation in order to get position, velocity and attitude increments in a certain navigation frame. When the increments are integrated overtime, they describe any motion of the INS as a function of time.

The INS computation process is more complicated as it sounds because any errors in the accelerometer or gyroscope

measurements will lead to errors in the determined position, velocity and attitude. Gyroscope errors will result in errors in the transformation matrix between body and navigation frame, while accelerometer errors will result in errors in the integrated velocity and position. The integration will result in errors proportional to the integration time  $t$  and its square,  $t^2$  for velocity and position respectively. For inertial sensors with large errors this will lead to errors increasing without limits in a very short time. The main problem about using INS to navigation systems is therefore the unlimited errors that will occur over time if no precautions are taken. The system therefore sees to drift with time. In order to minimize these errors, external measurements at regular time intervals must be utilized. Different types of update measurements can be used in order to update the position, the velocity or the attitude. GPS is one of the main position update methods. Other methods could be velocity update from a wheel speed sensor or attitude update from a compass [4]. Integration between the INS measurement and the one from the external systems are normally done by use of different filtering techniques. Kalman filtering is a very common method in order to limit the noise from the two systems. The shortcomings as well as the features of INS lead to search for performance enhancement via aided navigation system.

adopted to specify the user position. Then, a GPS receiver is simulated using MATLAB environment. The structure of the navigation algorithm based on GPS only is presented in Fig. 18.

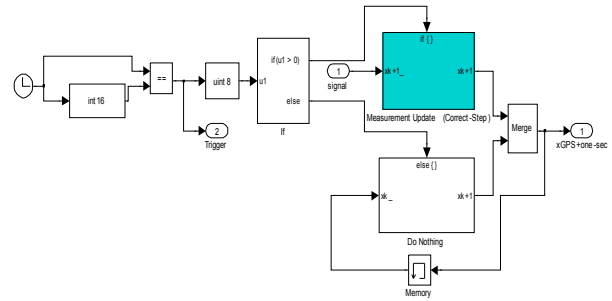

Fig. 18 Structure of the navigation algorithm based on GPS only

The true position and the GPS estimated position are shown in Fig. 19. Obviously, the two trajectories are very similar and the difference between them is illustrated in Fig. 20 where the horizontal position error in x and y (east and north) reached 20m.

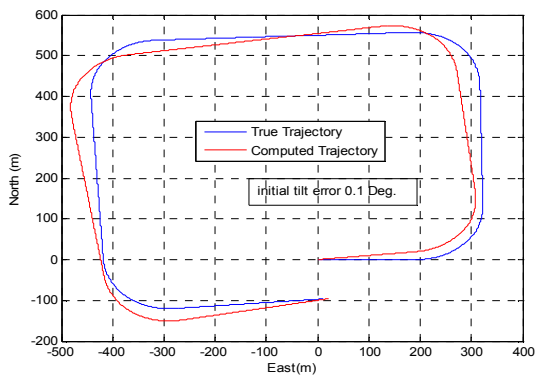

Fig. 16 Reference and INS derived trajectories with 0.1deg tilt error

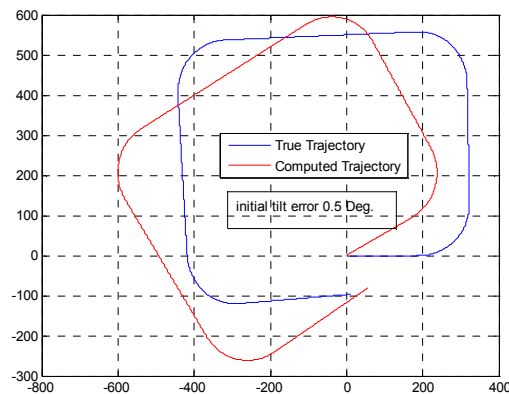

Fig. 17 Reference and INS derived trajectories with 0.5deg tilt error

### VIII. SIMULATED GPS TRAJECTORY

In order to obtain the simulated GPS trajectory, the same reference trajectory, which was used in previous section, is

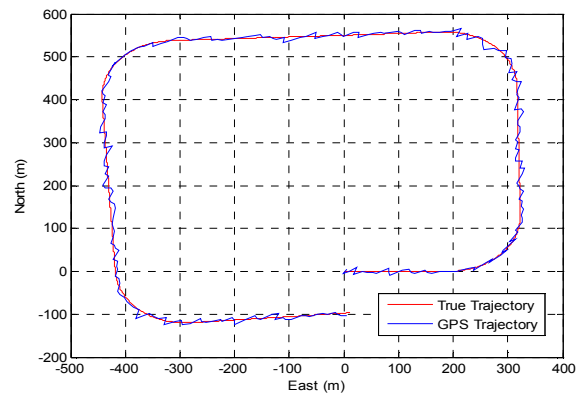

Fig. 19 True and simulated GPS trajectories

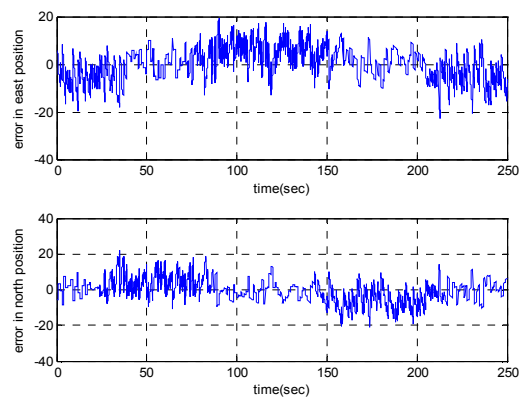

Fig. 20 Position error between the true and simulated GPS trajectories

### IX. KALMAN FILTER THEORY AND ALGORITHM

An extended Kalman filter was developed to estimate the position, velocity and attitude of the system. The full Kalman

filter equations will not be presented here due to limited space, but an overview of the process is shown in Fig. 8 and further information can be found in [7].

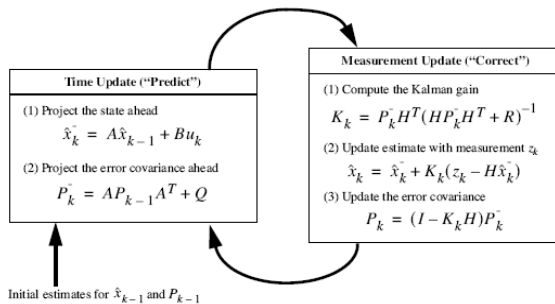

Fig. 21 Kalman filter algorithm

### X. PAR IMU\GPS INTEGRATION IN 2-D MODEL

While the main aspects of GPS and INS were reviewed in previous sections, this section is devoted to the theoretical and practical aspects of integrating the two systems. Traditionally Kalman filter is used for error estimation in integrated systems. Its calculation algorithm is also explored in last section.

In this section the configuration of the ParIMU\GPS integration in land vehicle navigation application will be investigated, Fig 22 show a simplified block diagram for a (1G2A) ParIMU\GPS processing in 2-D navigation algorithm. In this paper loosely coupled integration scheme is used to share the data between the two sensors, Fig. 23 shows the block diagram of loosely coupled integration mode.

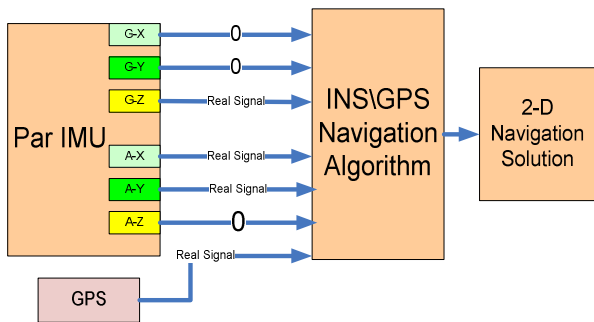

Fig. 22 Principle of the Par IMU processing in 2-D navigation algorithm

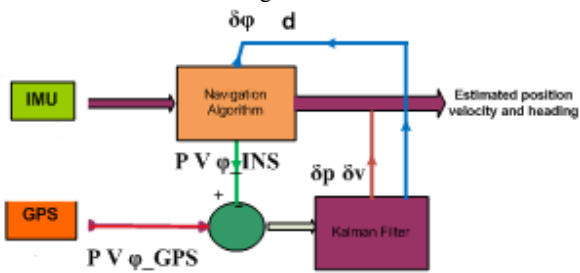

Fig. 23 Structure of the ParIMU\GPS integration in loosely coupling mode

Taking in to consideration the process of INS alignment which defined as the determination of the initial values of the transformation matrix and can be done in stationary mode using gyro-compassing, MEMES IMU due to their large biases and low signal to noise ratio gyro-compassing cannot be applied. So that in this work the heading has been determined from the GPS sensor and hence in motion alignment is considered. Fig. 24 shows the GPS derived velocity which can be used as in motion alignment procedure, if the forward axis is parallel to the velocity vector which holds for approximately most land vehicle navigation applications.

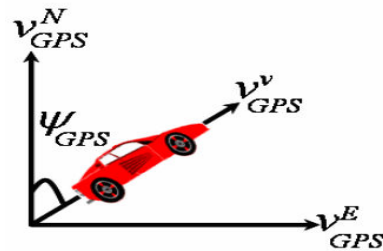

Fig. 24 Heading estimation

The heading can be initialized as follow:

$$\varphi = \tan^{-1}\left(\frac{v_E}{v_N}\right) \quad (13)$$

where  $v_E$  and  $v_N$  are east and north velocity respectively.

### XI. PARIMU\GPS ERROR MODELING

The error dynamics equations are obtained by perturbing the kinematic equations [8]. These error equations will be necessary to build the ParIMU/GPS Kalman filter. The KF error state vector used is therefore, an 8-state vector, as follows:

$$x^T = [\delta_x \quad \delta_y \quad \delta_{vx} \quad \delta_{vy} \quad \delta_\varphi \quad d \quad b_x \quad b_y] \quad (14)$$

The general form of error state equations used in the Kalman filtering (obtained by linearizing the INS mechanization equation) has the form:

$$\dot{\delta x} = F\delta x + GW \quad (15)$$

$$\begin{bmatrix} \delta \dot{x} \\ \delta \dot{y} \\ \delta \dot{v}_x \\ \delta \dot{v}_y \\ \delta \dot{\varphi} \\ \dot{d} \\ \dot{b}_x \\ \dot{b}_y \end{bmatrix} = [F] \begin{bmatrix} \delta_x \\ \delta_y \\ \delta_{vx} \\ \delta_{vy} \\ \delta_\varphi \\ d \\ b_x \\ b_y \end{bmatrix} + [G]W \quad (16)$$

with:

$\delta x$ : error states

F: dynamics matrix and defined as:

$$F = \begin{bmatrix} 0 & 0 & 1 & 0 & 0 & 0 & 0 & 0 \\ 0 & 0 & 0 & 1 & 0 & 0 & 0 & 0 \\ 0 & 0 & 0 & 0 & 0 & 0 & R_{b11}^n & R_{b12}^n \\ 0 & 0 & 0 & 0 & 0 & 0 & R_{b21}^n & R_{b22}^n \\ 0 & 0 & 0 & 0 & 0 & 0 & 0 & 1 \\ 0 & 0 & 0 & 0 & 0 & 0 & 0 & 0 \\ 0 & 0 & 0 & 0 & 0 & 0 & 0 & 0 \\ 0 & 0 & 0 & 0 & 0 & 0 & 0 & 0 \end{bmatrix} \quad (17)$$

G: design matrix

W: forcing noise (white Gaussian).

The measurement (update) equation is obtained by comparing the output of the aiding source  $PV\phi_{GPS}$  (GPS position, velocity and heading measurements) to the INS output  $PV\phi_{INS}$  (INS position, velocity and heading measurements). The observation  $Z$  supplied to the Kalman filter is therefore expressed as follows

$$Z = PV\phi_{GPS} - PV\phi_{INS} \quad (18)$$

Therefore, the observation  $Z$  is related to the error state vector  $x$  as follows:

$$Z = Hx + n \quad (19)$$

and

$$Z = \begin{bmatrix} 1 & 0 & 0 & 0 & 0 \\ 0 & 1 & 0 & 0 & 0 \\ 0 & 0 & 1 & 0 & 0 \\ 0 & 0 & 0 & 1 & 0 \\ 0 & 0 & 0 & 0 & 1 \end{bmatrix} \begin{bmatrix} \delta x \\ \delta y \\ \delta vx \\ \delta vy \\ \delta \varphi \end{bmatrix} + n \quad (20)$$

The covariance matrix of noise measurement

$$R = \text{diag}(\delta x^2) \quad (21)$$

## XII. PARIMU\GPS SIMULATION AND TESTING

In order to validate the ParIMU/GPS integration a Simulink Code under MATLAB environment is designed for this purpose, Fig. 25 shows a Simulink block diagram for ParIMU/GPS integration scheme. The results of simulating ParIMU/GPS integration is shown in Figs. 26-28. Fig. 26 shows the different trajectories of the vehicle in presence of low values of inertial sensors errors. It is clear that the estimated trajectory using GPS\INS integration is more effective for tracking the real trajectory of the vehicle compared to the INS stand alone trajectory. Fig. 27 shows the different trajectories of the vehicle when the values of inertial sensors errors are increased. Closely looking to Fig. 27 reveals that the estimated trajectory using GPS\INS integration is still more effective for tracking the real trajectory of the vehicle compared to the INS stand alone even the inertial sensors are increased. Fig. 28 shows the estimated bias, drift and heading using the Kalman filtering.

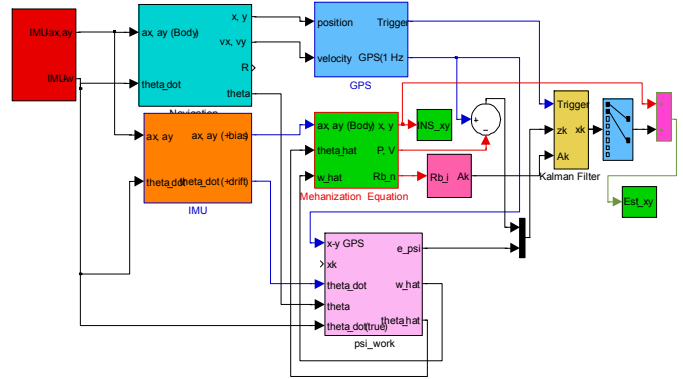

Fig. 25 Simulink block diagram of ParIMU/GPS

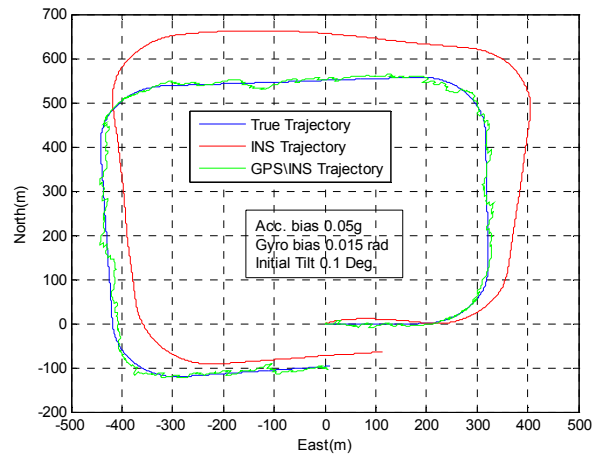

Fig. 26 The different trajectories of the vehicle for low inertial sensors errors



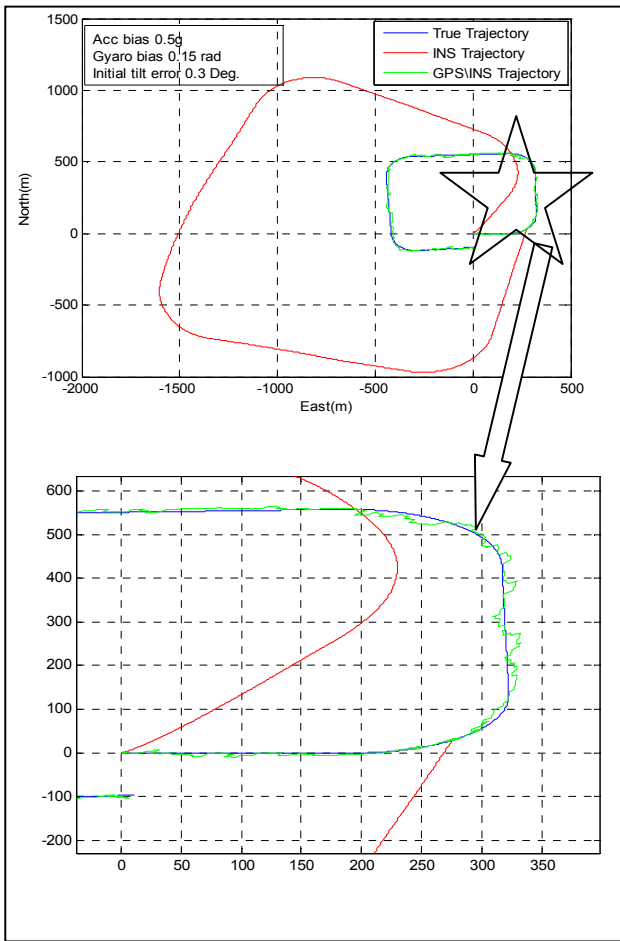

Fig. 27 The effects of Kalman filter in estimation of car trajectory for high level inertial sensor error

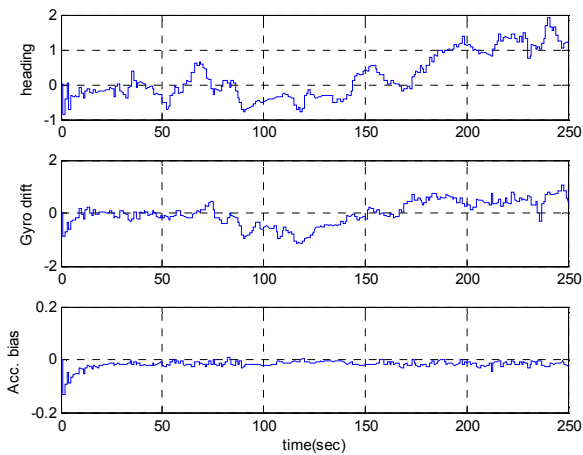

Fig. 28 Kalman filter estimated bias, drift and heading.

### XIII. CONCLUSION

The aim of this paper is attempted to show the advantages of ParIMU/GPS navigation systems, for reducing the cost and improving the performance of land vehicle navigation. The data fusion process is done with an extended Kalman filter. Simulation and testing results of a ParIMU configuration

consisting of one vertical gyro and two horizontal accelerometers (1G2A) can reduce the cost approximately by half of the total price of MEMES IMUs, while maintaining an acceptable navigation performance for land-vehicle navigation applications.

### REFERENCES

- [1] El-Sheimy N., "The Potential of Partial IMUs for Land Vehicle Navigation", Geomatics department, University of Calgary. (2008).
- [2] Grewal, M., S., Weill, L., R., Andrews, A., P. "Global Positioning Systems, Inertial Navigation, and Integration", John Wiley & Sons. (2000).
- [3] Titterton D.H. and Weston, J.L. (1997): "Strapdown Inertial Navigation Technology," Peter Peregrinus Ltd., London, UK, 1997.
- [4] El-Sheimy N." Inertial Techniques and INS/DGPS Integration". ENGO 623- Lecture Notes, the University of Calgary, Department of Geomatics Engineering, Calgary.
- [5] Hoffmann-Wellenhof, B., H. Lichtenegger, and J. Collins "Global positioning System; Theory and Practice", Springer New York. (2001).
- [6] Eric N. M. "Dynamic Modeling and Control of a Car-Like Robot" Masters Thesis, Virginia Polytechnic Institute and State University" February, 2003.
- [7] Greg W. and Gary B. "An Introduction to the Kalman Filter" Gary Bishop University of North Carolina at Chapel Hill Department of Computer Science Chapel Hill, NC 27599-3175. (2001).
- [8] Dorobantu, R., Zebhauser, b., "Field Evaluation of a Low-Cost Strapdown IMU by means of a GPS," Technical University of Munchen, Germany.