

# STEP Implementation on Turn-mill Manufacturing Environment

Ahmad Majdi Bin Abdul-Rani, Mesfin Gizaw, Yusri Yusof

**Abstract**—Researches related to standard product model and development of neutral manufacturing interfaces for numerical control machines becomes a significant topic since the last 25 years. In this paper, a detail description of STEP implementation on turn-mill manufacturing has been discussed. It shows requirements of information contents from ISO14649 data model. It covers to describe the design of STEP-NC framework applicable to turn-mill manufacturing. In the framework, EXPRESS-G and UML modeling tools are used to depict the information contents of the system and established the bases of information model requirement. A product and manufacturing data model applicable for STEP compliant manufacturing. The next generation turn-mill operations requirements have been represented by a UML diagram. An object oriented classes of ISO1449 has been developed on Visual Basic dot NET platform for binding the static information model represented by the UML diagram. An architect of the proposed system implementation has been given on the bases of the design and manufacturing module of STEP-NC interface established. Finally, a part 21 file process plan generated for an illustration of turn-mill components.

**Keywords**—CAPP, ISO14649, Product modeling, STEP-NC

## I. INTRODUCTION

STEP is standard for exchange of product data with a language independent, network enabled programming interface for accessing different level product data (SDAI) [1]. Data interface framework proposal for milling, intelligent manufacturing and manufacturing inspection in supporting STEP compliant are the major research mile stones of Project OPTIMAL and Loughborough University and the University of Bath STEP researches respectively [2]. Application of STEP on technology such as turn-mill manufacturing environment has been considered as STEP implementation. It intended to provide a new contention STEP-NC compliant information model to support the decision making process of a turn-mill operation from CAD to CNC process chain.

The paper is structured as follows; Section 2 gives high lights of literature review regarding on the state of the art, methodologies and research progresses. Section 3 covers product model, manufacturing model and machine tool data model development: outline of framework architecture CAD/CAPP/CAM system and design of information model of

STEP compliant system for turn-mill operations. Section 4 shows architect of interface and process plan data generation. Section 5 shows a case study. Finally, conclusions are given.

## II. LITERATURE REVIEW

Computer aided process planning (CAPP) has either a retrieval (variant) or generative approach and served as a link between feature generation of product families and features, capabilities and configuration of machining systems and their components [3]. In Grover et al. [4] explained variant approach as group technology, parts classification and coding which intern is used to correlate feature based designs with corresponding manufacturing operation such as turning and milling. In case of generative approach systematic procedures are utilized to assist process planning by expert system having knowledge base, computer compatible part description and inference engine. CAPP has main benefit to rationalize and standardize manufacturing system to acquire automated process plan. The standardization of the data is accomplished by Standard for the Exchange of Product model data (STEP) enabling product data transfer between computer aided design (CAD) and computer aided manufacturing (CAM) in different computer systems and environment.

Former researches accomplished STEP implementation model on technologies of turning, milling and Wire EDM (electric discharge machining) etc. by using standard data model of ISO14649-12, 14649-11 and ISO 14649-13 respectively [2, 5-6]. These STEP implementation models commonly used ISO14649-10 general data.

S.Heusinger et.al.[7] developed STEP compliant manufacturing model that support the process planning activity of turn-mill machining using ISO10303-224 and ISO 10303-240 in addition to ISO14649 10, 11 and 12 data models. It was comprised of workstation level manufacturing model which consists of resource capabilities and process capabilities.

The STEP-NC compliant product and manufacturing information model offers a standardized structure for information related to the component and its features, material, tolerances, machining and inspection specification. In addition, it is further used to generate a machining and inspection process plan for a component with regard to intelligent CNC machine tools.

The development of STEP-NC interface has been aimed at to address integration and portability of information between the design and manufacturing modules. The design of system framework has been suitable for investigation of the information requirement and specification of the machining environment as the primary focus.

AP Dr. Ahmad Majdi Bin Abdul Rani is the Head of Department (PhD), Mechanical & Manufacturing, Mechanical Engineering Department, Universiti Teknologi Petronas, 31750 Tronoh, Perak, Email: majdi@petronas.com.my

Mesfin Gizaw, Mechanical Engineering Department, Universiti Teknologi Petronas, mesfingizaw@yahoo.com

AP Dr. Yusri Yusof is a Deputy Dean Research and Development, Faculty of Mechanical and Manufacturing Engineering of University Tun Hussein Onn Malaysia (UTHM), yusri@uthm.edu.my

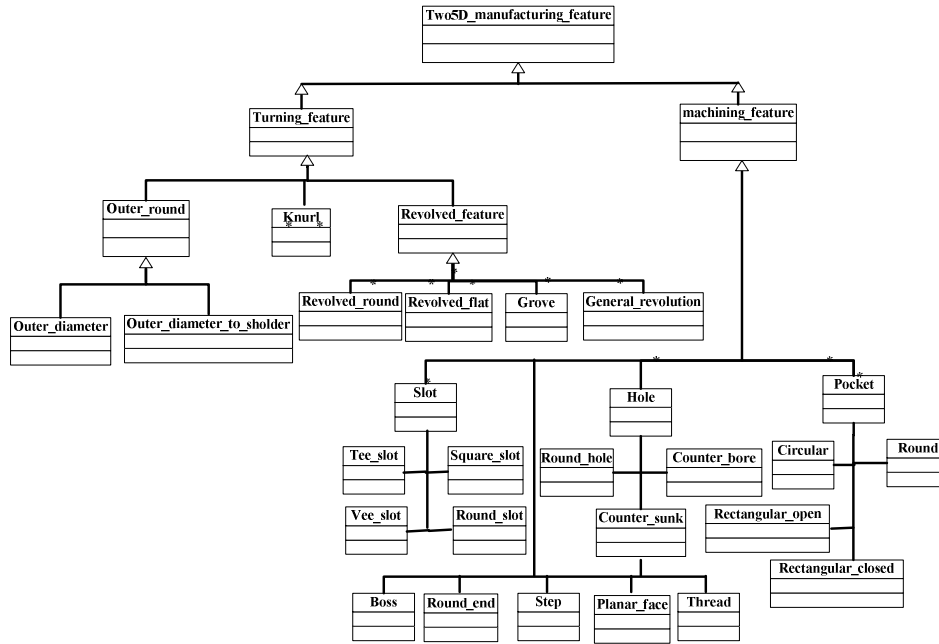

Fig. 1 Two5D\_manufacturing\_feaature in UML format

Therefore; in the next section the methodology and representation STEP-NC complaint framework regarding turn-mill machining environment will be discussed. In which the content and structure of the system framework has been mapped with the requirement of the functional module of the system.

### III. ISO14649 INFORMATION CONTENT & SYSTEM FRAMEWORK

The framework is used to investigate information requirement and specifying the context of turn-mill manufacturing system in STEP. It is mainly intend to describe or represent process data of NC programming regarding part base geometry, feature bases part design, manufacturing process representation, and structured document output as a physical file format consists of these contents. A representation of turn-mill manufacturing requirement begins with the amalgamated consideration of ISO 14649-10, 11, 12,111 and 121[8-12]. This comprised of general manufacturing information, milling and turning manufacturing feature and machining operation information requirements as presented in Fig. 1 and Fig. 2.

The ISO10303 is used to establish a formalized CNC data model on ISO14649 and includes process plan information. It avoids the weakness of traditional CAD systems being exclusively geometric representation by feature based design information elaborated with ISO14649-AP224 ARM suits which has an inheritance structure given as in Fig. 1.

The discussion of the contents follows with the manufacturing information requirement corresponding to the features suit mentioned.Two5D\_manufacturing\_feature class includes subtypes of turning\_feature and milling\_feature as

their subclasses of features are shown in the Fig. 1.In Fig. 2 the manufacturing process requirements and its structural content has been shown as (ABS) machining\_operation of ISO14649. It has included (ABS) milling\_operation and turning\_machining\_operations as subtypes. These are capable of representing the manufacturing information requirement of turn-mill machining environment.

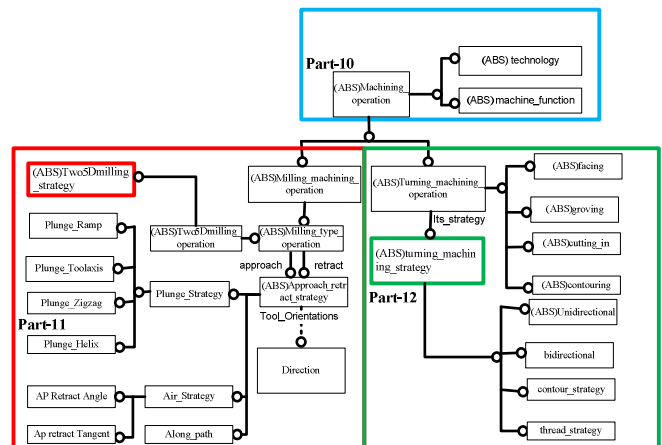

Fig. 2 The EXPRESS-G representations for machining\_operation

Therefore; it is possible to derive a machining feature and machining process model suitable for turn-mill machining on ISO14649 data model to construct a unit workingstep. The workingstep includes machining strategies and machine tool information requirements of turn-mill operation forming unit workplan as shown in Fig. 3. In the workingstep, milling and turning cutting tool data models of Part 111, and Part121 has been used for including information requirement of a cutting tool in an operation.

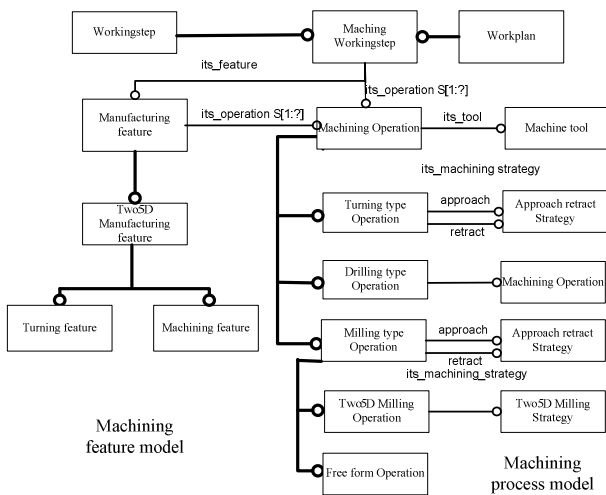

Fig. 3 Workplan structure for turn-mill operation

A pre-processor has been developed on an object-oriented platform of Visual Basic Dot NET to generate a physical STEP-NC process plan file in Part 21 or part 28 [13]. It has been mainly used as an interface able to receive feature based workpiece design information that can be produced by machining process with selected cutting tools and parameters. The main framework of the interface consists of feature-based design process plans for manufacturing process utilizing the ISO14649 data model. These data models are the bases to establish requirement of information models such as Product model and Process model described in the next section according to the nature and functionality of turn-mill manufacturing environment.

#### IV. INFORMATION MODEL

The two modules of manufacturing namely design and manufacturing are represented by information models applicable to support product and manufacturing data suitable to turn-mill operations respectively. That provides about product, resources, operation and strategy information requirements considerations perspectives in design and manufacturing. A UML diagram represents the inheritance relationships, attributes and operations. All the entities are based on ISO14649 parts 10, 11, 12, 111 and 121 [8-12].

A “what to do” information model established based on the provision of manufacturing features and tool requirements and followed by a generic manufacturing task description of “How-to-do” hardware independent process plan information [14]. It is on the bases of ISO14649-1 digital manufacturing data model as shown in IDEFO Fig. 4 [15]. A graphical user interface (GUI) constructed on Visual Basic dot NET used to maintain functionalities in STEP-NC structure and a tool data base formed on Micro soft SQL server helps to perform a bidirectional flow of manufacturing information.

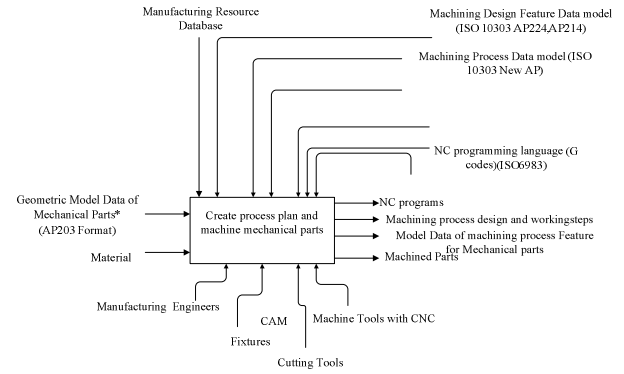

Fig. 4 Digital manufacturing based on ISO14649-1(ISO, 2003b)

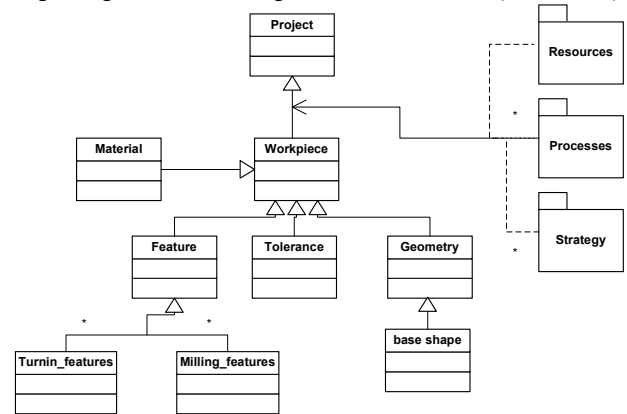

Fig. 5 Representation of STEP-NC compliant model for turn-mill-product data model

The design stage perspective of the proposed system is represented as product model given in Fig. 5. It is based on the methodology of object-oriented modeling suit of information requirements regarding material specification, management information and preliminary integrated & interoperable process planning expressed with objects as defined in ISO14649 entity sets.

Molina approaches of a workstation level manufacturing modeling used to establish a suitable representation of processes, resources and strategies requirements for turn-mill operations. The proposed system supported by the manufacturing operations shown in Fig. 6 [16].

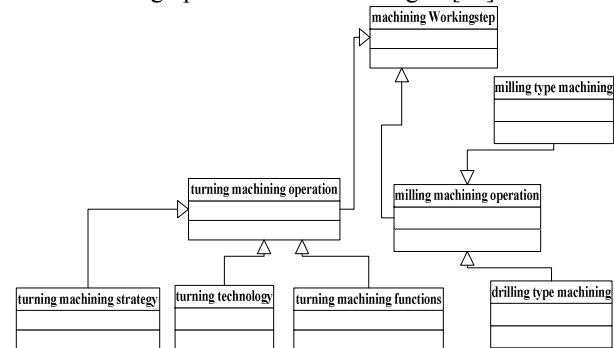

Fig. 6 Representation of STEP-NC compliant for turn-mill – manufacturing data model

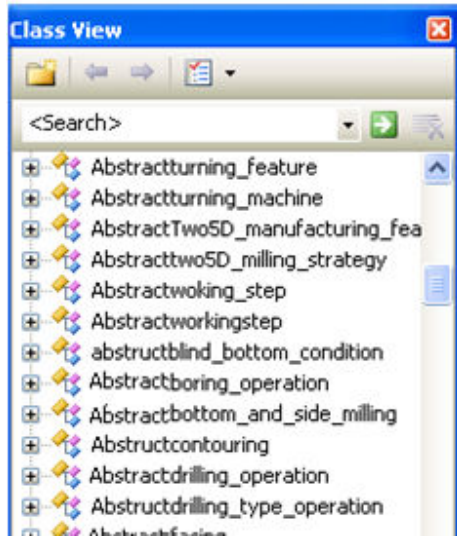

Fig. 7 The proposed system class diagram

The ISO14649 process data for milling and turning is part 11 and 12 respectively, which specifies the technology specific data element that are needed as process data for milling and turning [9-10]. Part 10 [15] is general process data which describes the interface between CNC controller and shop floor programming system for milling and turning. Fig. 7 shows classes of ISO14649 developed for turn-mill operations. It is developed on object oriented platform of Visual Basic dot NET 2005 on the integrated product and manufacturing model given on Fig. 5 and Fig.6 on aspect of feature based design.

Since the information models are not limited to on specifying “what to do” information, it has been extended to “How to do” information of manufacturing. A provision of manufacturing resource information model, working with ISO14649 data model, as shown in Fig.8 is fundamental for this phase.

The model enables the proposed system to support a machine tool specific implementation in STEP-NC data file development which has been supported by the STEP-NC machine tool data model (STEP-NCMTdM) [17]. This promotes to transform generic STEP-NC process plan to a specific Native STEP-NC process plan relevant to available machine resources.

### V. IMPLEMENTATION OF THE PROPOSED SYSTEM

The proposed system implementation can be reviewed or described according to the following three principal phases. These are:-

- Feature based design consideration of the workpiece i.e. it can be accomplished with user defined base shape and feature selection or reading/ Deserializing an AP203 format data file output from commercial graphic software regarding a manufacturing feature forming the design which is on the bases of ISO14649 Part 11 and Part 12 feature definition [9-10].

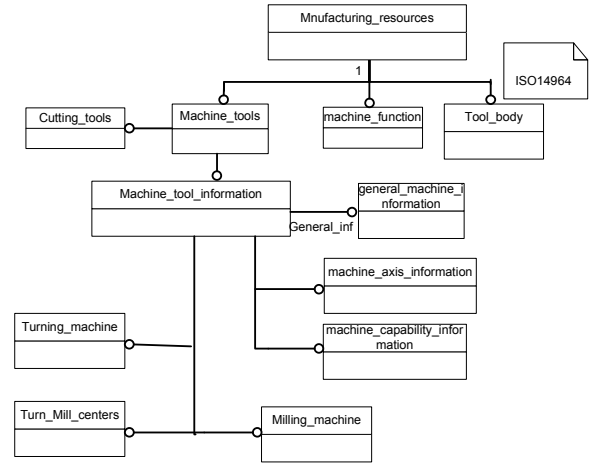

Fig. 1 EXPRES-G manufacturing resources model of the system

- The second procedure is related to submit attributes of operation required for machining the design features. It includes setting of attributes related to machining strategy, machining technology, appropriate machine functions and cutting tools selection.
- Finally, generation of process plan in Part 21 file format. It consists of the previous information inputs and selections on a structured format as described in earlier section of information model. It allows edition of its data content.

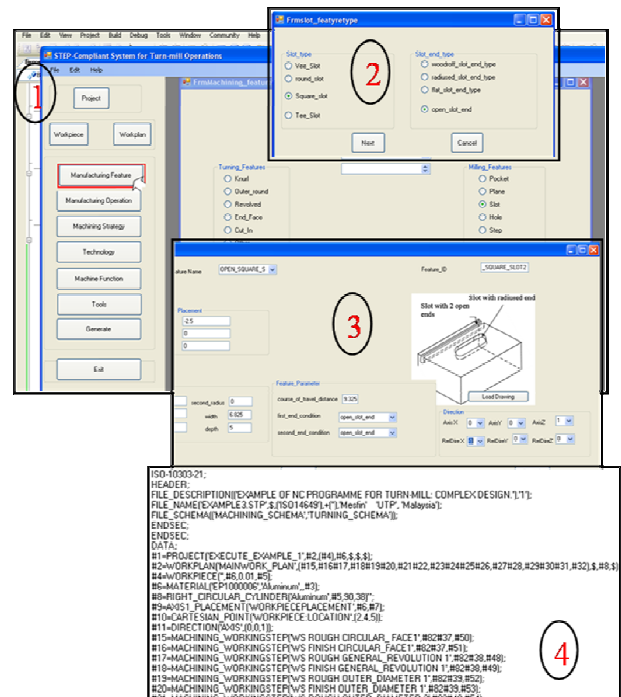

Fig. 9 the overall Framework of the proposed system

The description of the above three phases have various STEP-NC interface suitable for user interaction. Fig. 9 shows the interface indexed as 1 interface to start design,

manufacturing and process plan generation module. The figure displayed flows of machining feature selection and feature attribute setting & submitting actions can be performed with interface labeled as 2 and 3 respectively. Finally, the Part 21 file format process plan generated using the system shown by index 2. In addition, ABS *manufacturing\_operation* EXPRESS class has been shown in fig.10.

```
Public Class AbstractMachining_operation
    Public operation_id, retract_plane As String
    Public milling_machining_operation As New Abstractmilling_machining_operation
    Public turning_machining_operation As New Abstractturning_machining_operation
    Public turn_mill_machining_operation As New Abstractturn_mill_machining_operation
    Public its_machining_strategy As New two3D_machining_strategy

    Public start_point As cartesian_point

    Public its_machining_tool As New Abstractmachining_tool

    Public its_technology As New Abstracttechnology
        Public its_machine_functions As New Abstractmachine_functions
    Public its_machine_tool As New Abstractmachine_tool
End Class
```

Fig. 10 Maching\_operation

### VI. CONCLUSION

The case study component provides turning and milling features. The overall size of the components is 90mm x Ø 38mm. The aspects of feature placement, machining configuration and cutting tools are taken into consideration in the design of the component. The machining feature found are labeled as in Fig.11. It has five turning features and five milling features. The Part 21 physical file format generated describes the attributes of the machining features, machining operation attributes, machining strategy attributes etc as shown in Fig. 12.

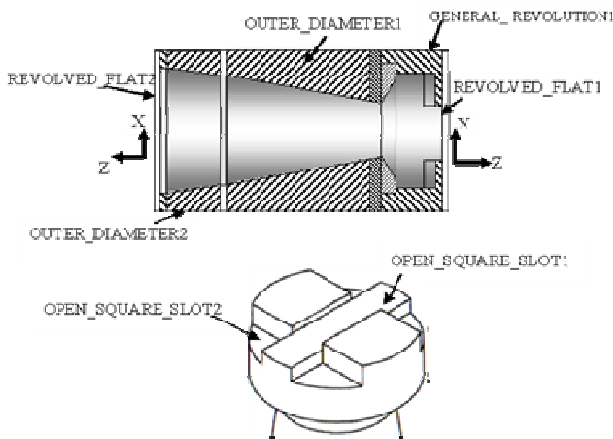

Fig. 11 Castel as a turn-mill component

These functions of the system are based on the above described information model formed on the given STEP compliant framework. It was established on the provision information content from ISO14649 data model that ascertains expected compliance of the proposed system.

Since the information model and accompanied architect of STEP-NC interface of the proposed system includes

manufacturing resources model as represented in Fig. 8, this provides a means to incorporate machine tool information formulated on the bases of STEP-NCmDm.

This provides a means to capture homogeneous coordinate transformation data between workpiece and machine tool axis in tool-path generation and error detection of a part program which leads to feature driven machining of turn-mill operations. It can be considered as an additional achievement of the implementation along with integration, portability and easy of a part programming of STEP-NC manufacturing environment.

4/8/2011 9:00:47 AM

```
ISO-10303-21;
HEADER;
FILE_DESCRIPTION(('EXAMPLE OF NC PROGRAMME
FOR TURNING: COMPLEX
DESIGN. '),1);
FILE_NAME('EXAMPLE1.STP',$(ISO14649),+('),'Mesfin'
'UTP', 'Malaysia');
FILE_SCHEMA(('MACHINING_SCHEMA','TURNING_SC
HEMA'));
ENDSEC;
DATA;
#1=PROJECT('EXECUTE_EXAMPLE_3',#2,(#4),#6,$,$,$);
#2=WORKPLAN('MAINWORK_PLAN',(#15,#16#17,#18#1
9#20,#21#22,#23#24#25
#26,#27#28,#29#30#31,#32),$,#8,$);
#4=WORKPIECE(",#6,0.01,#5);
....
#15=MACHINING_WORKINGSTEP('WS ROUGH
CIRCULAR_FACE1',#82#37,#50);
#16=MACHINING_WORKINGSTEP('WS FINISH
CIRCULAR_FACE1',#82#37,#51);
....
#32=MACHINING_WORKINGSTEP('WS FINISH
OPEN_SQUARE_SLOT5',#82#45,#65);
#36=REVOLVED_FLAT('REVOLVED
FLAT1',#4(#22,#23)#172,#176,11.65,#178);
#37=REVOLVED_FLAT2('REVOLVED
FLAT2',#4(#42,#43)#183,#187,13.325,#188)
....
#55=CONTOURING_FINISH($,$,'FINISH
OUTER_DIAMETER2',40,$,#280,#73,#70,$,#130,#130,#132
,0.01);
#56=BOTTOM_AND_SIDE_ROUGH_MILLING($,$,'BOT
TOM_AND_SIDE_ROUGH_
MILLING',40,$,#285,#75,#70,$,#130,#130,#131,0.05);
#57=BOTTOM_AND_SIDE_FINISH_MILLING($,$,'BOT
TOM_AND_SIDE_ROUGH_
MILLING',40,$,#285,#75,#70,$,#130,#130,#132,0.05);
.....contd.
(*****Functions / Technology***** )
#70=TURN_Mill_MACHINE_FUNCTIONS(.T.,$,$,(),.F.$,$,
(),$,$,$);
#71=TURN_Mill_TECHNOLOGY($,.TCP.,#62,0.300,().F.,F,
F,$);
#72=CONSTANT_SPINDLE_SPEED(0);
```

```

.....
(*****Tools***** )
#280=TURNING_CUTTING_TOOL(,"#281,(#283),120,40,$
);
#282=TOOL_DIMENSION($,$,$,$,0,50,3,5,0,$);
#283=CUTTING_COMPONENT(0,$,$,$);
#285=MILLING_CUTTING_TOOL('END_MILL5MM',#286
(#287),$,$);
(*****Placements / Lengths***** )
#172=AXIS2_PLACEMENT_3D('PLACEMENT
REVOLVED
FLAT1',"#173,"#174,"#175.);
#173=CARTESIAN_POINT('REVOLVED
FLAT1:LOCATION',(0,0,0.));
#174=DIRECTION("AXIS',(0,0,-1.));
#175=DIRECTION("REF_DIRECTION',(0,0,1.));
#176=DIRECTION("MATERIAL_SIDE',(0,0,-1.));
#178=LINEAR_PROFILE('REVOLVED_FLAT_RADIUS',#
179,11.825);
#179=AXIS2_PLACEMENT_3D('PLACEMENT
REVOLVED
FLAT1',"#180,"#181,"#182.);
.....
ENDSEC;
END-ISO-10303-21;

```

Fig. 12 Part 21 output file generated by the system

#### REFERENCES

- [1] V. Kern, et al., "Implementation of standardized shareable product databases," 1996.
- [2] S. T. Newman, et al., "Strategic advantages of interoperability for global manufacturing using CNC technology," *Robotics and Computer Integrated Manufacturing*, vol. 24, pp. 699-708, 2008.
- [3] H. A.ElMaraghy, *Changeable and Reconfigurable Manufacturing Systems*. London: Springer-Verlager, 2009.
- [4] M. Groover, *Fundamentals Of Modern Manufacturing: Materials Processes, And Systems*: Wiley-India, 2007.
- [5] S.-H. Suh, et al., "STEP-compliant CNC system for turning: Data model, architecture, and implementation," *Computer-Aided Design*, vol. 38, pp. 677-688, 2006.
- [6] Wonseok Lee and Young-Bong Bang, "Development of ISO14649 Compliant CNC Milling Machine Operated by STEP-NC in XML Format," W. S. Lee and Y.-B. Bang: *International Journal of the KSPE*, vol. Vol. 4, September ,2003.
- [7] R. S. U. R.-J. S. Heusinger, P. Klemm, S. T. Newman and S. Rahimifard, "Integrating the CAx Process Chain for STEP Compliant NC Manufacturing of Asymmetric Parts.," *International Journal of Computer Integrated manufacturing*, vol. Vol. 19, pp. pp 533 - 545, 2006.
- [8] ISO, "International Standard 14649-10: Part 10 : Industrial automation system and integration - Physical device control - Data model for computerized numerical controllers - Part 10 : General process data," February 2002.
- [9] ISO, "International Standard 14649-11: Part 11 : Industrial automation system and integration - Physical device control - Data model for computerized numerical controllers - Part 11 : Process data for milling," 2004.
- [10] ISO, "Part 12: PROCESS DATA FOR TURNING," vol. ISO/DIS 14649-12, 2003-10-24.
- [11] ISO, "Industrial automation systems and integration - Physical device control - Data model for computerized numerical controllers - Part 111: Tools for milling machines," ISO/TC 184/SC 1/WG 7, vol. ISO/FDIS 14649-111, 2002.
- [12] ISO, "International Standard 14649-121: Part 121 : Industrial automation system and integration - Physical device control - Data

- model for computerized numerical controllers -Part 121: Tools for Turning Machines," ISO/TC 184/SC 1/WG 7vol. ISO/TC 184/SC1 N 000, 2003.
- [13] ISO. 14649-1, "Part 1: Overview and fundamental principles," ISO/TC 184/SC 1/WG 7, vol. ISO/FDIS 14649-1, 2002.
- [14] H. Wang and X. Xu, "A STEP-Compliant" Adaptor" for Linking CAPP with CNC," 2004, p. 45.
- [15] ISO, "Part 1: Overview and fundamental principles," ISO/TC 184/SC 1/WG 7, vol. ISO/FDIS 14649-1, 2002.
- [16] A. M. Gutierrez, "A manufacturing model to support data-driven applications for design and manufacture," 1995.
- [17] W. Yang and X. Xu, "Modelling machine tool data in support of STEP-NC based manufacturing," *Int. J. Comput. Integr. Manuf.*, vol. 21, pp. 745-763, 2008.