

# GPS \ INS Integration Application in Flight Management System

Othman Maklouf, Abdurazag Ghila, Saleh Gashoot, and Ahmed Abdulla

**Abstract**—Flight management system (FMS) is a specialized computer system that automates a wide variety of in-flight tasks, reducing the workload on the flight crew to the point that modern aircraft no longer carry flight engineers or navigators. The primary function of FMS is to perform the in-flight management of the flight plan using various sensors (such as GPS and INS often backed up by radio navigation) to determine the aircraft's position. From the cockpit FMS is normally controlled through a Control Display Unit (CDU) which incorporates a small screen and keyboard or touch screen. This paper investigates the performance of GPS/ INS integration techniques in which the data fusion process is done using Kalman filtering. This will include the importance of sensors calibration as well as the alignment of the strap down inertial navigation system. The limitations of the inertial navigation systems are investigated in order to understand why INS sometimes is integrated with other navigation aids and not just operating in stand-alone mode. Finally, both the loosely coupled and tightly coupled configurations are analyzed for several types of situations and operational conditions.

**Keywords**—GPS, INS, Kalman Filter.

## I. INTRODUCTION

GPS and INS have complementary qualities that make them ideal use for sensor fusion. The limitations of GPS include occasional high noise content, outages when satellite signals are blocked, interference and low bandwidth. The strengths of GPS include its long-term stability and its capacity to function as a stand-alone navigation system. In contrast, inertial navigation systems are not subject to interference or outages, have high bandwidth and good short-term noise characteristics, but have long-term drift errors and require external information for initialization. A combined system of GPS and INS subsystems can exhibit the robustness, higher bandwidth and better noise characteristics of the inertial system with the long-term stability of GPS

## II. INERTIAL NAVIGATION SYSTEM

INS systems are generally found in almost all forms of long distance aircraft and sea vessels, submarine and missile applications, and this is due to their initial wide spread use in military roles[1]. In such applications the inertial sensors implemented have to be of supreme quality, providing stable

readings, extremely high resolution and high-bandwidth. The algorithms and electronics implemented are also of high quality in order to minimize the introduction of any errors. With the current trend to better navigation performance for civilian applications, INS systems can provide a useful sensor. The basic principle of an INS is based on the integration of accelerations observed by the accelerometers on board the moving platform. The system accomplishes this task through appropriate processing of the data obtained from the specific force and angular velocity measurements [1]. A major advantage of using inertial units is that given the acceleration and angular rotation rate data in three dimensions, the velocity and position of the vehicle can be evaluated in any navigation frame. However, the errors caused by bias, scale factors and non-linearity in the sensor readings cause an accumulation in navigation errors with time and furthermore inaccurate readings are caused by the misalignment of the unit's axes with respect to the local navigation frame. Table I shows different sources that generated errors in INS, Since an inertial unit is a dead reckoning sensor, any error in a previous evaluation will be carried onto the next evaluation, thus as time progresses the navigation solution drifts [2].

TABLE I  
SOURCES GENERATED ERRORS IN INS

Alignment errors	Roll, pitch, and heading errors
Accelerometer bias or offset	a constant offset in the accelerometer output that changes randomly after each turn-on.
Accelerometer scale factor error	results in an acceleration error proportional to sensed acceleration.
Non-orthogonality of gyros the axes of accelerometer and gyro and accelerometers	The axes of accelerometer and gyro uncertainty and misalignment.
Gyro drift or bias (due to temperature changes)	A constant gyro output without angular rate presence.
Gyro scale factor error	results in an angular rate error proportional to the sensed angular rate
Random noise	random noise in measurement

The first type of INS developed was a gimbaled system. The accelerometers are mounted on a motorized gimbaled platform which was always kept aligned with the navigation frame. These systems are very accurate, because the sensors can be designed for very precise measurements in a small measurement range. However this setup has several detractors

O. Maklouf is with the Department of Electrical Engineering, Engineering Academy Tajoura. Libya, (e-mail: omaklouf@yahoo.com).

A. Ghila is with Department of Aeronautical Engineering, Engineering Academy Tajoura. Libya, (e-mail: arghila@gmail.com).

S. Gashoot is with Department of Aeronautical Engineering, Tripoli University. Libya, (e-mail: srabdu@yahoo.com).

A. Abdulla is with Department of Computer Engineering, Engineering Academy Tajoura. Libya, (e-mail: ahmohajer@yahoo.co.uk).

which make it undesirable. In contrary, a strap-down inertial navigation system uses orthogonal accelerometers and gyro triads rigidly fixed to the axes of the moving vehicle. The angular motion of the system is continuously measured using the rate sensors. The accelerometers do not remain stable in space, but follow the motion of the vehicle. A strap-down system is a major hardware simplification of the old gimballed systems. The accelerometers and gyros are mounted in body coordinates and are not mechanically moved. Instead, a software solution is used to keep track of the orientation of the IMU (and vehicle) and rotate the measurements from the body frame to the navigational frame. This method overcomes the problems encountered with the gimballed system, and most importantly reduces the size, cost, power consumption, and complexity of the system.

### A. Coordinate Frame Definition

Three coordinate frames are important for this work. These include the ECEF (Earth-Centered Earth-Fixed) frame (e frame), the body frame (b frame) and the local level frame (LLF). The three frames are shown in Figure 1. The origin of the ECEF frame is the center of the Earth's mass. The X-axis is located in the equatorial plane and points towards the mean Meridian of Greenwich. The Y-axis is also located in the equatorial plane and is 90 degrees east of the mean Meridian of Greenwich. The Z-axis parallels the Earth's mean spin axis. LLF is a local geodetic frame serves as local reference directions for representing vehicle attitude and velocity for operation on or near the surface of the Earth; for this reason, it is often referred to as navigation frame (n-frame). A common orientation for LLF coordinates is the North-East-Up (NEU) system. The origin of the LLF frame is coincides with sensor frame.

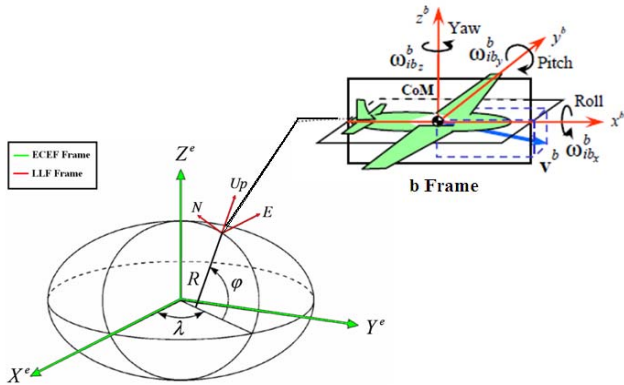

Fig. 1 Coordinate Frames

The Z-axis is orthogonal to the reference ellipsoid pointing up. The X-axis is pointing towards geodetic East. The Y-axis is pointing toward geodetic North. The body frame represents the orientation of the IMU axes. The IMU sensitive axes are assumed to be approximately coincident with the moving platform upon which the IMU sensors are mounted. The origin of the body frame is at the center of the IMU. The X-axis points towards the right of the moving platform, the Y-axis points toward the front of the moving platform, and the Z-axis

is orthogonal to the X and Y axes to complete a right-handed frame.

### B. INS Mechanization Equations

INS mechanization is the process of determining the navigation states (position, velocity and attitude) from the raw inertial measurements through solving the differential equations describing the system motion. Mechanization is usually expressed by a set of differential equations and typically performed in the local level frame defined by the local east, north and ellipsoid normal. Figure 2 shows the block diagram of LLF mechanization algorithm [3].

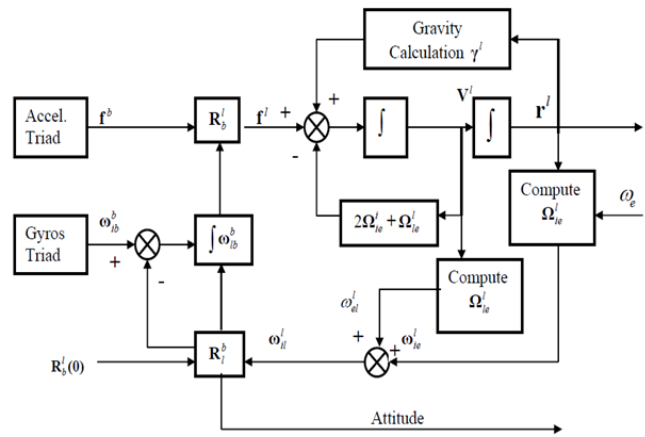

Fig. 2 Local Level Frame Mechanization Equations Block Diagram [3]

The IMU measurements include three angular rate components provided by the gyroscopes and denoted by the 3x1 vector  $\omega_{ib}^b$  as well as three linear acceleration components provided by the accelerometers and denoted by the 3x1 vector  $f^b$ . This means that the angular velocities  $\omega_{ib}^b$  of the body frame are measured with respect to the inertial frame. The navigation equations for the Local Level Frame (LLF) are shown below [3]:

$$\begin{pmatrix} \dot{r}^l \\ \dot{V}^l \\ \dot{R}_b^l \end{pmatrix} = \begin{pmatrix} D^{-1}V^l \\ R_b^l f_b - (2\Omega_{ie}^l + \Omega_{el}^l) V^l + g^l \\ R_b^l (\Omega_{ib}^b - \Omega_{il}^b) \end{pmatrix} \quad (1)$$

where  $v^n$  is the velocity vector in the local level frame ( $v_{east}^n, v_{north}^n, v_{up}^n$ ),  $R_b^n$  is the transformation matrix from body to local frame as a function of attitude components,  $g^n$  is the gravity vector in the local level frame,  $\Omega_{ib}^b, \Omega_{in}^b$ , are the skew-symmetric matrices of the angular velocity vectors  $\omega_{in}^b, \omega_{ib}^b$  respectively, and  $D^{-1}$  is a 3x3 matrix whose non zero elements are functions of the user's latitude  $\phi$  and ellipsoidal height (h).

The solution and numerical implementation of the above differential equation are discussed in more detail in several references.

### III. GLOBAL POSITIONING SYSTEM (GPS)

The GPS consists basically of three segments: the space segment, the control segment, and the user segment. The space segment shown in Figure 3 consists of 24 satellites arranged in 6 orbital planes with an inclination angle of  $55^\circ$  relative to the Earth equator. The satellites have approximately an average orbit radius of 20200 km and complete one orbit in 11 hours and 58 minutes. The control segment monitors the health of the orbiting satellites and uploads navigation data. It consists of a system of tracking stations located around the world, including six monitor stations, four ground antennas, and a master control station. The user segment consists of receivers specifically designed to receive, decode, and process the GPS satellite signals.



Fig. 3 GPS satellite

GPS satellites transmit two carrier frequencies: the primary L1 (1575.42 MHz) and the secondary L2 (1227.60 MHz). These frequencies are modulated by the navigation message and by spread spectrum codes with a unique pseudorandom noise sequence for each satellite [4]. Currently, GPS signals are modulated by two codes, namely, the Coarse-Acquisition (C/A) code on L1 and the Precise (P) code on L1 and L2. The P-code is restricted to military use via its encryption by the Y-code, a practice known as anti-spoofing. In general, the GPS signal contains pseudo range, carrier phase and Doppler measurements. The L1 C/A-code pseudo range and Doppler measurements can be used for position and velocity calculation [1].

Under good conditions GPS will be able to provide continuous and accurate positioning to the user at all time. But unfortunately good conditions will not always occur as the signal from the satellites can be blocked by (e. g mountains and high buildings). Further as the electromagnetic signal travels from the satellites to the Earth it can be influenced by magnetic fields, areas with high amount of free electrons and moisture air that cause the signal to travel slower than expected (speed of light in vacuum). At the Earth the signal can be extended by reflections from e. g (glass), the clocks

onboard the satellites and in the receivers can be unsynchronized and therefore cause more errors on the signal. Some of these errors can be reduced or even removed by use of e g differential GPS but not all. Hence any sophisticated urban navigation system cannot depend on GPS as a stand-alone system. Instead one can integrate two (or more) different navigation systems. [5].

### IV. GPS/INS INTEGRATION TECHNIQUES

There are several approaches for integration of GPS and INS information to provide a combined navigation solution. Differences between the various approaches are based on the type of information that is shared between the individual systems. In practice, two main integration approaches are implemented in the navigation field: the loosely coupled (LC) and tightly coupled (TC) schemes [3], Table II shows a brief comparison between the two schemes. Both the strategies can be open-loop, where the estimation of the INS errors does not interfere with the operation of the INS, or closed loop, where the sensor errors are compensated within the calculation procedure of the INS mechanization algorithm.

TABLE II  
 A BRIEF COMPARISON OF LC VS TC ARCHITECTURES

Implementation	Advantages	Disadvantages
Loosely coupled	<ul style="list-style-type: none"> <li>• INS and GPS Kalman are implemented separately</li> <li>• The size of individual Kalman filter is small</li> <li>• Flexible, modular combination</li> <li>• Suitable for parallel processing, reliability</li> <li>• Less computation complexity</li> </ul>	<ul style="list-style-type: none"> <li>• Sub-optimal performance</li> <li>• Four satellite required for a stable solution</li> <li>• INS data is not used for ambiguity estimation</li> </ul>
Tightly coupled	<ul style="list-style-type: none"> <li>• One error state model</li> <li>• Optimal solution, accuracy</li> <li>• GPS measurements can be used with less than 4 satellites</li> <li>• Faster ambiguity estimation</li> </ul>	<ul style="list-style-type: none"> <li>• Large size of error state model</li> <li>• More complex processing</li> </ul>

### V. SIMULATION RESULTS

#### A. Stand Alone INS

A MATLAB code is developed to test and evaluate the navigation algorithm based on INS only. In order to validate the INS algorithm the following steps are carried out:

1. Generation of the reference trajectory.
2. Carry out the INS simulation in error-free case (i.e. no sensor or initialization errors), in order to obtain the derived INS trajectory.
3. Initial velocity error, accelerometer bias, gyro drift and initial tilt error were taken as case study and their effects on the derived INS trajectory are illustrated.

4. All considered errors are listed in Table III with various values and then the derived INS trajectory and its components are illustrated.

In order to evaluate the INS algorithm, a reference trajectory was generated. A GPSofT toolbox under MATLAB environment is used to generate this reference trajectory. The main features of this toolbox can be summarized as follows:

- Non-linear 6DOF flight profile generator.
- Three-dimensional trajectories emulation (straight-and-level, climbs, descents, and turns).

F-16 model is adopted in the code development of the GPSofT toolbox which is fully described in various textbooks and in particular in Aircraft control and simulation [6]. The suggested reference trajectory consists of five segments. This reference trajectory has been adopted in all simulation results for analysis and comparison studies. These segments are defined as follows:

1. Straight and leveled segment heading east.
2. Right turn segment.
3. Straight and leveled segment heading (- north).
4. Right turn segment.
5. Straight and leveled segment heading (- east).

The previous illustrated segments are set in a program. The simulation results are recorded and plotted in Figures (4 and 5). Figure 4 shows the reference trajectory in the local level frame while Figure 5 presents this reference trajectory in the earth frame.

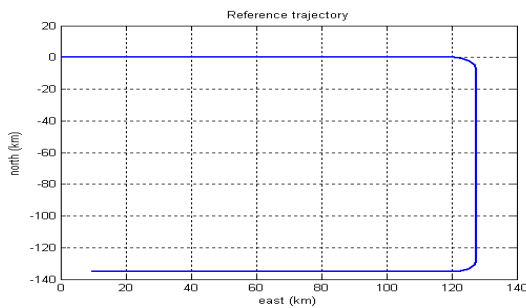

Fig. 4 Reference trajectory in the local Level frame

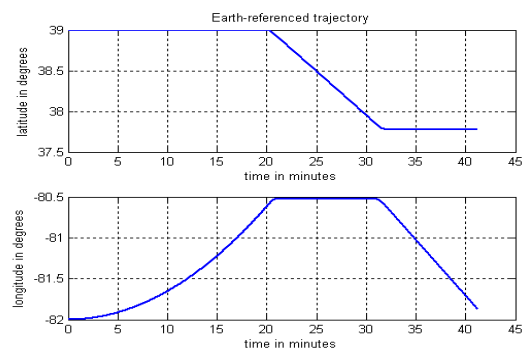

Fig. 5 reference trajectory in the earth frame

### B. Error Analysis

The reference trajectory created earlier is applied as an input for the proposed INS algorithm. Simulation runs have been conducted to discuss the effect of various types of errors

that may degrade the performance of navigation system. Two main types of errors are discussed in this section, the navigation algorithm error and the sensors errors. First an INS simulation is demonstrated without sensor errors. The INS derived trajectory matches up quite closely with the truth generated one as shown in Figure 6. The differences should be due only to imperfect generation of the simulated measurements ( $\Delta V$ 's and  $\Delta \theta$ ) and imperfect position/velocity/attitude updating algorithm (primarily imperfect numerical integration).

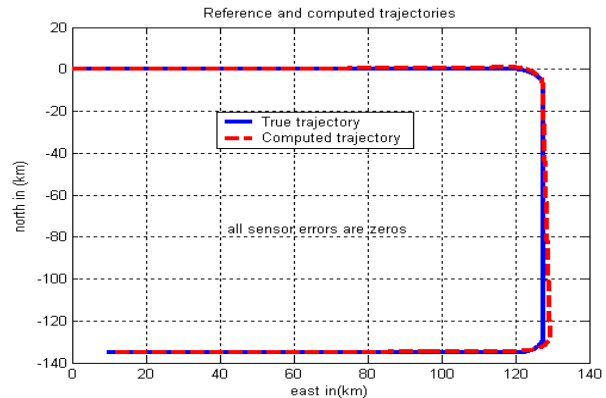

Fig. 6 Reference and INS derived trajectories without sensor errors

TABLE III  
 THE VALUES OF THE ERRORS

The Errors	The Values		
	Low	Intermed.	High
Initial velocity error (m/s)	0.1	0.3	0.5
Initial tilt error (deg)	0.1	0.2	0.5
Accelerometer bias ( $\mu g$ )	50	75	100
Gyro bias (deg/hr)	0.015	0.055	0.15

Second, when sensor's errors are included, in this work the effects of the various errors (initial velocity, initial tilt, accelerometer bias and gyro bias) have been studied. Table II gives the values of the mentioned errors adopted in the simulation. These have been chosen as case study for the effect of the errors on the INS derived trajectory.

1) *The Initial Velocity Error Effect:* For 0.1 m/s north and east (x,y) velocity error, Figure 7 shows that the reference and the INS derived trajectories are match up quite closely with RMS error in the horizontal position equal to 19.865m as shown in Figure 8. However, when the velocity error is increased to 0.5 m/s, the RMS error in the horizontal position increased to 99.3269 m as illustrated in Figure 8.

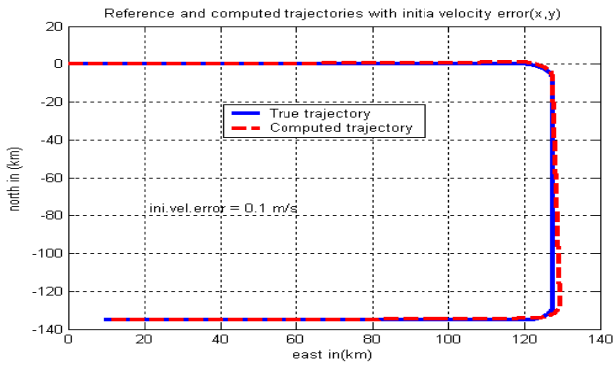

Fig. 7 Reference and INS derived trajectories with 0.1 m/s  $\delta v$

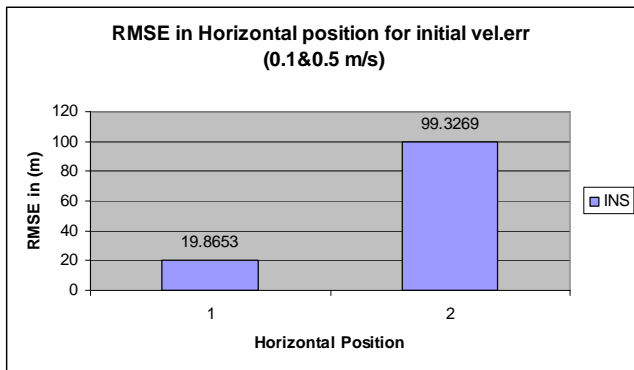

Fig. 8 RMSE in horizontal position for 0.1 and 0.5 m/s  $\delta v$

2) *The Accelerometer Bias Effect:* In order to study the effect of the accelerometer bias on the derived INS trajectory, two values have been adopted. The adopted values are  $50\mu g$  and  $100\mu g$  which represented the navigation and the tactical grade respectively. First,  $50\mu g$  is set into the program. Figure 9 shows the RMSE in horizontal position. It is clear that this difference is due to the improper measurement of the accelerometer which in turn, results in improper computation in velocity and position. Figure 10 shows the RMSE in east and north velocities. For  $50\mu g$  accelerometer bias, the RMSE in east velocity is bigger than the RMSE in the north velocity. This is because the time spent in moving east is more than the time spent in moving north (when the vehicle is moving east the north velocity is very small compared to the east velocity). Second,  $100\mu g$  accelerometer bias is adopted. As one would expect, the difference between the two trajectories as well as the RMSE in both horizontal position and horizontal velocities, will increase. This is clear in Figures 9 and 10, where the values are list below these figures.

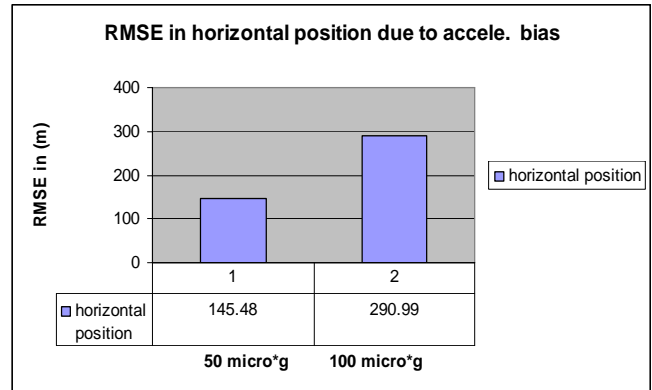

Fig. 9 RMS in horizontal position due to accelerometer bias

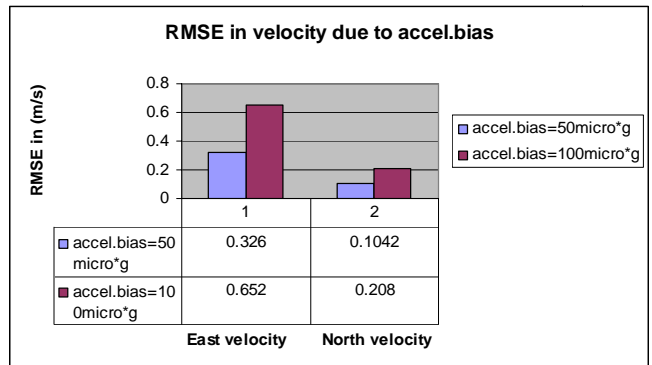

Fig. 10 RMSE in velocity due to accelerometer bias

3) *The Gyro Drifts Effect:* Two values of gyro bias have been selected; these values are 0.015 rad/hr and 0.15rad/hr which represented the navigation and the tactical grade respectively. Due to this drift which in turn results in improper projection of the accelerometer measurement into the reference frame, a deviation between the two trajectories has been occurred. This deviation is illustrated in Figure 11 as 297.229m RMSE in the horizontal position. This also occurred in the east and north velocities as illustrated in Figure 12. Clearly when the gyro drift is increased to 0.15 rad/hr the deviation between the two trajectories as well as the RMSE in the horizontal velocity, are increased.

4) *The Tilt Error Effect:* Also two values 0.1deg and 0.5 deg as initial tilt error are set to the program. Figure 13 shows the difference between the two trajectories with tilt error equal to 0.1deg. Obviously, the derived INS trajectory is deviated too much from the reference trajectory. This is also shown in Figure 14 as 6663m RMSE in the horizontal position. The reason is that, since the horizontal plane is unlevelled, the east and north accelerometer will read a component of the gravity from the beginning instead of reading zero component if the horizontal plane is leveled. Then these components will results in error which accumulated with time. Clearly, the computed horizontal velocity will behave in similar manner. As shown in Figure 15 increasing this tilt error to be 0.5deg, the results get worst.

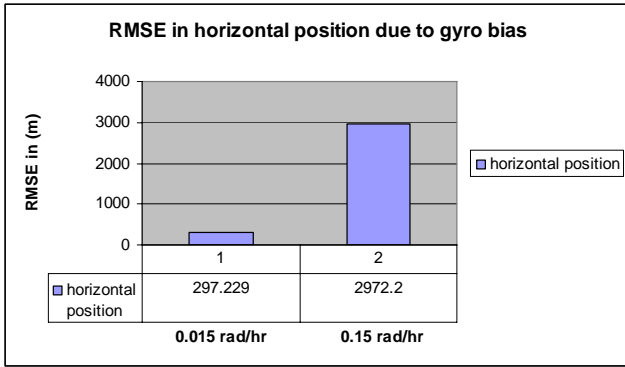

Fig. 11 RMSE in horizontal position due to gyro drifts

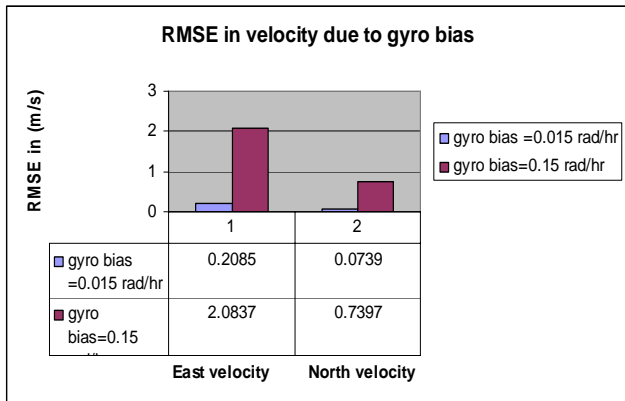

Fig. 12 RMSE in velocity due to gyro drift

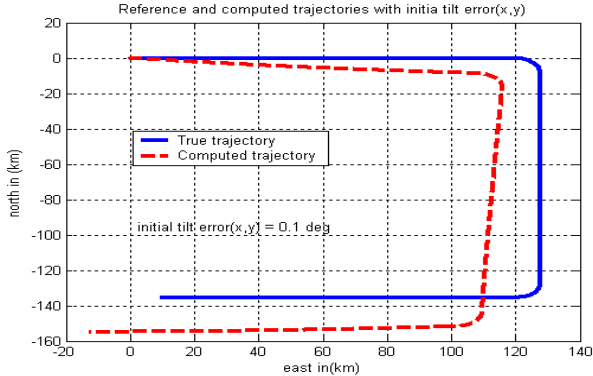

Fig. 13 Reference and INS derived trajectories with 0.1deg tilt error

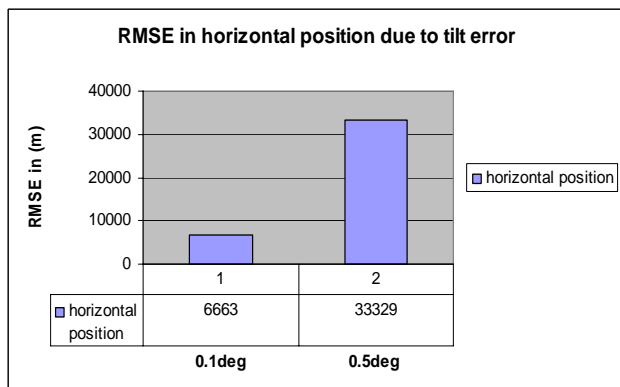

Fig. 14 RMSE in horizontal position due to tilt error

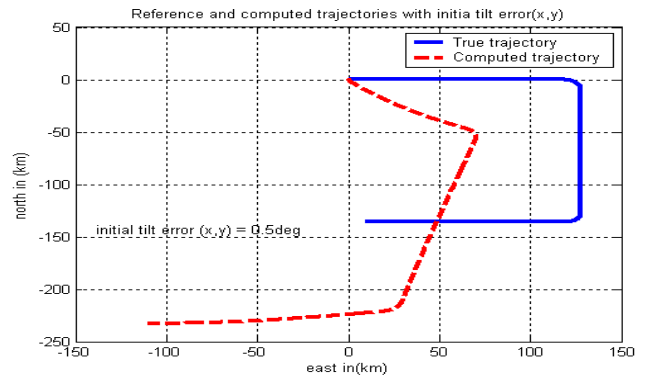

Fig. 15 Reference and INS derived trajectories with 0.5deg tilt error

It is clear that the tilt error has significant effect on the INS derived trajectory. This is why the INS should be initially aligned to the navigation frame.

5) *The effect of the all errors:* Extensive simulation has been carried out for each individual error. After the effects of the individual error have been studied, the effects of the all errors together have been conducted. First the minimum values of the errors, which mentioned in Table III, have been set. It is obvious that there is a difference between the reference and the INS derived trajectories which increase with the time and results in the horizontal position error as shown in Figure 16. The RMS error in the horizontal position for all cases (i.e. minimum, intermediate and maximum), is shown in Figure 17. It is obvious from this figure that the RMS error increased as the sensor and initialization errors are increased. The RMS error in latitude and longitude for the other cases is shown in Figure 18. Also the RMS error in lat/long is increased as the sensor and initialization errors increased. The RMS error in the east and north velocities for the other cases are shown in Figure 19. The error is increased due to the increasing in the sensor errors.

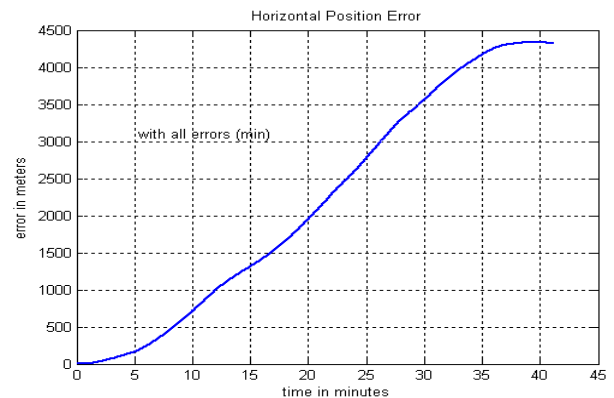

Fig. 16 Horizontal position error

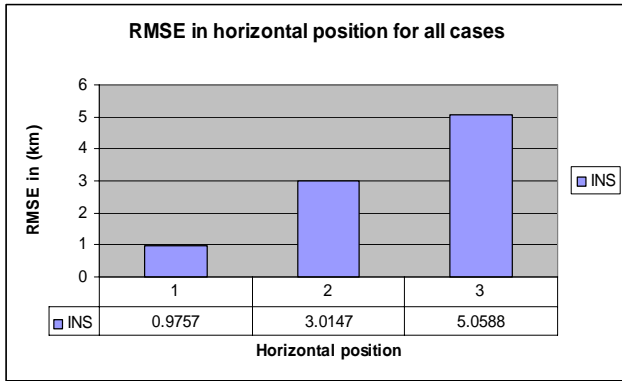

Fig .17 RMSE in horizontal position for all cases

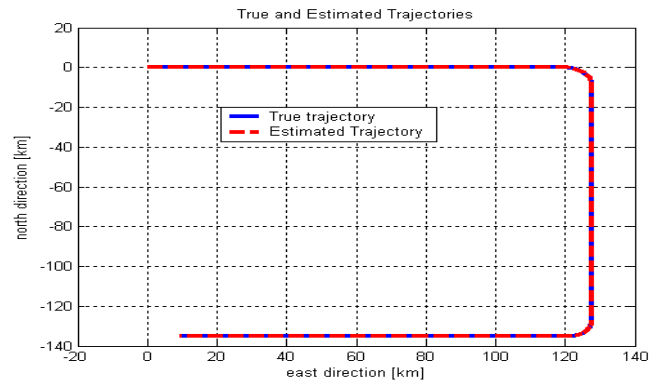

Fig. 20 True and simulated GPS trajectories

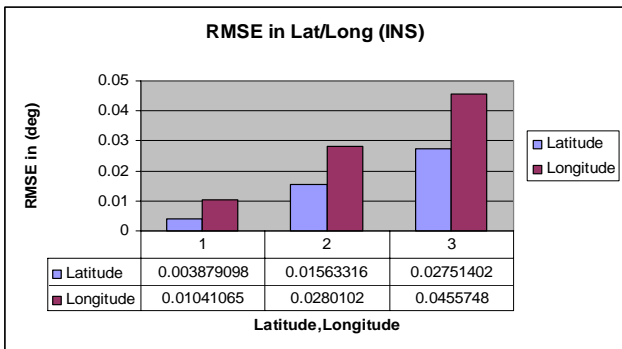

Fig 18 RMSE in the latitude and longitude for all cases

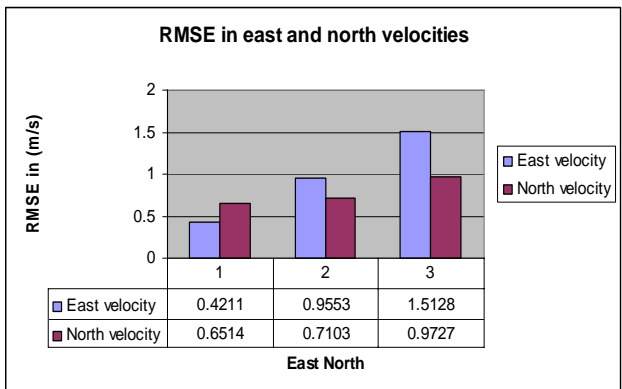

Fig. 19 RMSE in north and east velocities for all cases

## VI. GPS ONLY SOLUTION

In order to obtain the simulated GPS trajectory, the same reference trajectory, which was used in previous section, is adopted here to specify the user position. Then, a GPS receiver is simulated using MATLAB environment and GPSofT Toolbox. The true position and the GPS estimated position are shown in Figure 20 Obviously, the two trajectories are very similar and the difference between them is illustrated in Figure 21. As it is widely known that satellite based navigation systems perform worse for vertical positioning than for horizontal positioning, this is clear in Figure 21 where the vertical position error reached 100 m while the horizontal position error in x and y (east and north) reached 18 m.

The RMS error for the east, north and up position is shown in Figure 22. As mentioned above the vertical position has the worst RMS error. In this figure the tropospheric, multi path and ionospheric errors are included. Figure 23 shows the RMSE in the GPS position for the individual error mentioned above. Also the RMSE in the vertical position has the worst value in each error source.

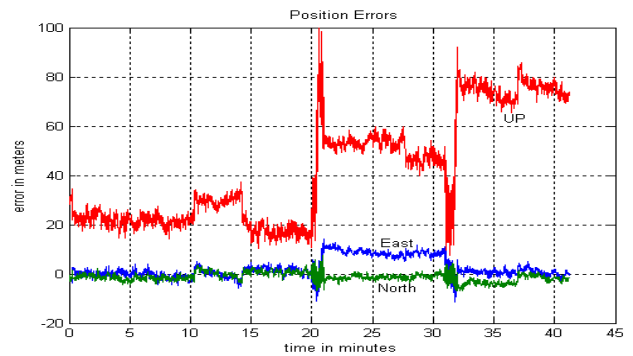

Fig. 21 Position error between the true and simulated GPS trajectories

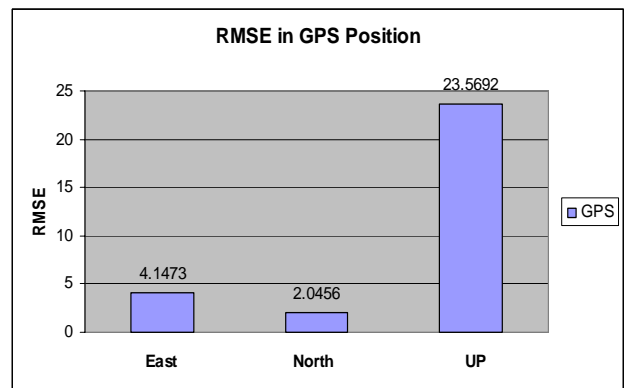

Fig. 22 RMS error for GPS position

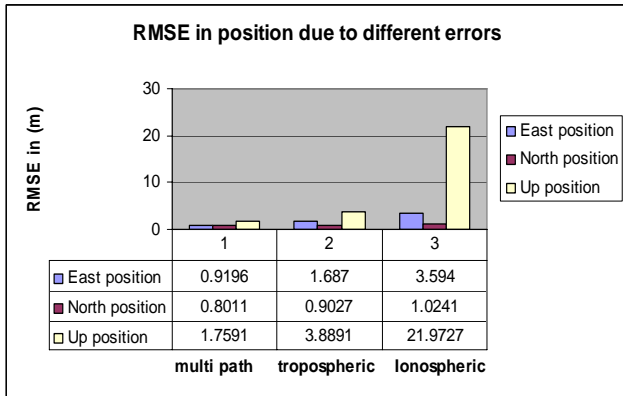

Fig. 23 RMS error for GPS position individual error

### VII. INS/GPS INTEGRATION USING KALMAN FILTER

The detailed implementation of the Kalman filter can be found in [7]. An example of a 15 states Kalman filter is given as follows: The error states include three position parameters, three velocity parameters, three attitude parameters, three accelerometer bias parameters and three gyro drift parameters.

$$X = [\delta\phi \ \delta\lambda \ \delta h \ \delta v_E \ \delta v_N \ \delta v_U \ \delta\varphi \ \delta\theta \ \delta\psi \ \delta x \ \delta y \ \delta z \ \delta a_x \ \delta a_y \ \delta a_z] \quad (2)$$

The state transition matrix  $F_{k,k-1}$  can be obtained using the dynamics matrix,  $F$ , as follows:

$$F_{k,k-1} = \exp(F\Delta t) \approx I + F\Delta t \quad (3)$$

The measurement equation that uses GPS velocity and position as measurements update is given as follows [6]:

$$z_k = \begin{bmatrix} v_{INS}^x - v_{GPS}^x \\ v_{INS}^y - v_{GPS}^y \\ v_{INS}^z - v_{GPS}^z \end{bmatrix} = \begin{bmatrix} \varphi_{INS} - \varphi_{GPS} \\ \lambda_{INS} - \lambda_{GPS} \\ h_{INS} - h_{GPS} \end{bmatrix}, H_k = \begin{bmatrix} I_{3 \times 3} & 0_{3 \times 3} & 0_{3 \times 3} & 0_{3 \times 3} & 0_{3 \times 3} \\ 0_{3 \times 3} & I_{3 \times 3} & 0_{3 \times 3} & 0_{3 \times 3} & 0_{3 \times 3} \end{bmatrix} \quad (4)$$

The measurement equation that uses zero velocity update (ZUPT) as measurements is given as follows [6]:

$$z_k = [v_{INS}^x - 0] = \begin{bmatrix} v_E - 0 \\ v_N - 0 \\ v_U - 0 \end{bmatrix}, H_k = [0_{3 \times 3} \ I_{3 \times 3} \ 0_{3 \times 3} \ 0_{3 \times 3} \ 0_{3 \times 3}] \quad (5)$$

#### A. Loosely Coupled Results

In this case the same dynamic vehicle trajectory and the same INS simulation are used. A Kalman filter with 18 states is used. These states are:

- 3-position errors.
- 3-velocity errors.
- 3-attitude errors
- 3-gyro biases.
- 3-accelerometer biases.
- 3- Bias in GPS estimated position.

The Kalman observables are the east and north position differences between the INS and the external aiding source

GPS. For the same trajectory which contained the errors, the difference between the reference and the derived aided trajectories is illustrated in Figure 24 as a horizontal position error. The RMS error in the horizontal position for the aided trajectory is 8.4435 m compared with 975.7888 m in case of stand-alone INS as shown in Figure 25.

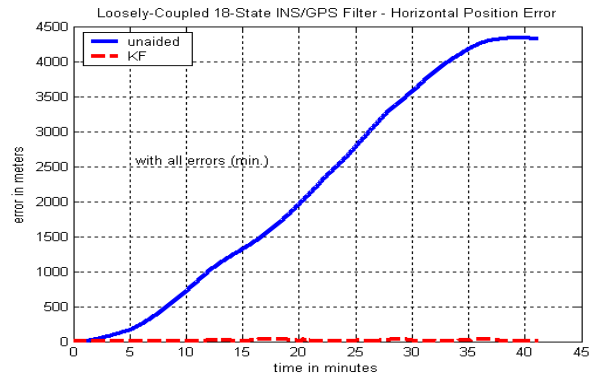

Fig. 24 Horizontal position error in INS and aided trajectories (LC)

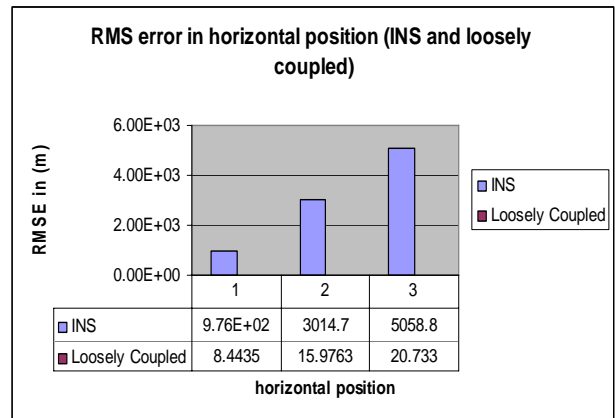

Fig. 25 RMSE in the horizontal position for INS and GPS/INS (LC)

Figure 26 shows the error in the east and north velocity components in both aided and unaided trajectories. It is clear that the results are improved when a Kalman filter is used. It is clear from this figure that the error of east and north velocities is improved compared with the stand-alone INS. It should be noted that the over shoots which appeared in the curves due to the transient as the Kalman filter is converging. The duration of the transient is a function of the initial Kalman filter parameters along with the trajectory being simulated. Figure 27 shows the latitude and the longitude errors in both aided and unaided trajectories. Obviously these errors are significantly improved compared with the stand-alone INS.



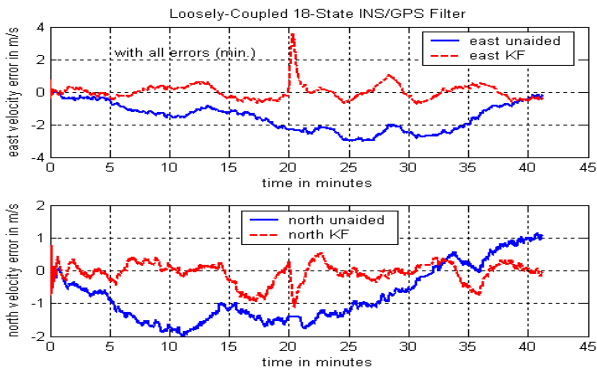

Fig. 26 Velocity components in INS and INS/GPS trajectories (LC)

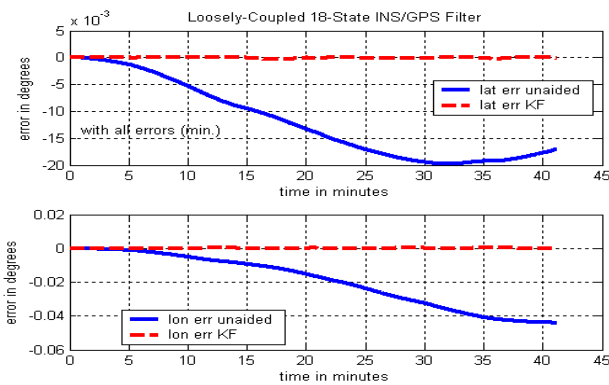

Fig. 27 Latitude and longitude errors in INS and INS/GPS trajectories (LC)

### B. Tightly Coupled Results

In this architecture, as mentioned before, the filter is able to access the raw, unprocessed, aiding data. This helps ensure the independence of the data and allows the filter to be constructed such that it can still extract some aiding information even if there are less than 4 satellites in view.

The filter differs from the 18-state loosely coupled approach in that the three position biases states are replaced by two receiver clock bias states (bias and drift) and twelve pseudo range bias states. The assumption here is that there will be no more than 12 satellites in view at any one time. The difference between the two trajectories is illustrated in Figure 28 as a horizontal position error. Figure 29 shows the horizontal position error in both aided and unaided trajectory. Figure 30 shows the east and north velocity components in both tightly coupled aided and unaided trajectories. The RMS error in the horizontal position for the aided trajectory is 3.2183 m compared with 975.7888 m in case of stand-alone INS. As shown in figure 31 the results of the tightly coupled are differ slightly from the loosely coupled. The tightly coupled approach proves its value, however, when the satellite coverage is degraded.

This can be shown in Figure 31 when the number of satellites are decreased from 6 down to 3 (2 minutes) and then 1 (also 2 minutes) and finally to 0. As the results, shows, the filter does quite well even when there are less than 4 satellites in view. In this case, although there is complete GPS data outage, the RMS error in horizontal position is 269.02 m

which is significantly decreased compared with stand-alone INS (975.7888 m).

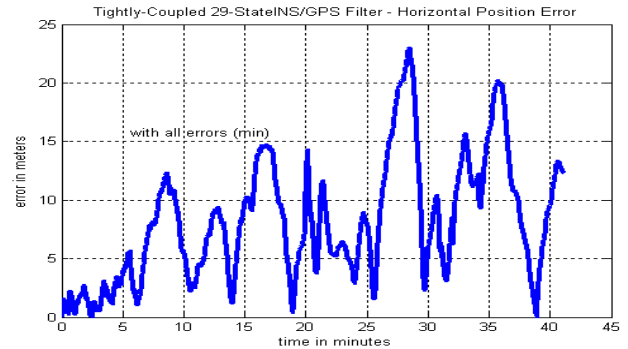

Fig. 28 The horizontal position error (TC)

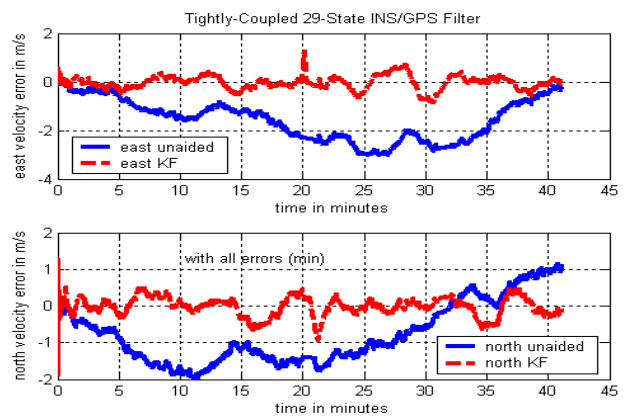

Fig. 29 Horizontal position error in INS and aided trajectories (TC)

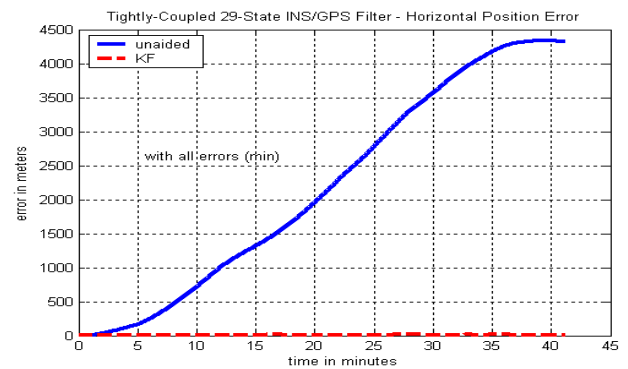

Fig. 30 Velocity components in INS and INS/GPS trajectories (TC)

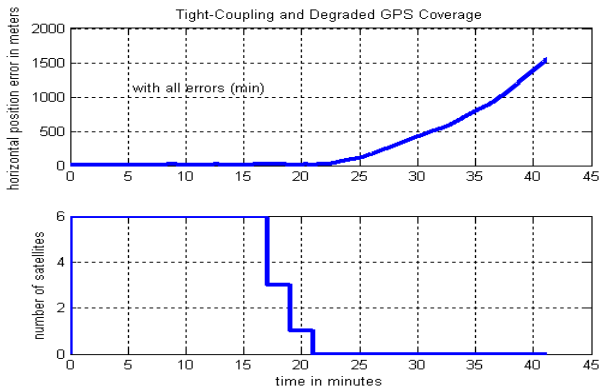

Fig. 31 TC and degraded GPS coverage

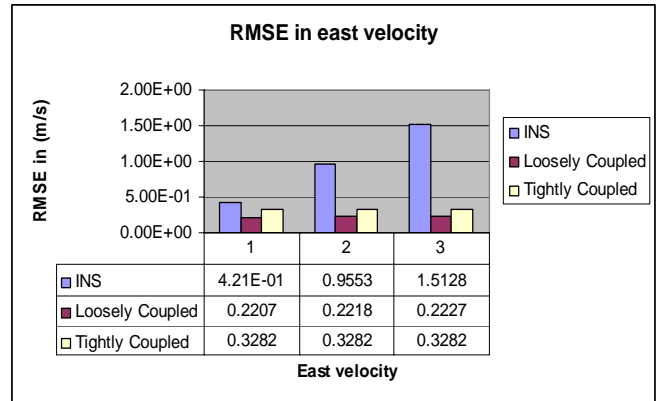

Fig. 33 RMSE in east velocity for INS, LC and TC

**C. Loosely Vs Tightly Coupled Results**

The following figures illustrate the RMS error in longitude, east velocity, north velocity and horizontal position for INS, loosely coupled and tightly coupled integration for all cases (minimum, intermediate and maximum errors). Figure 32 shows the RMS error in longitude. The values of the loosely and tightly are too small so, they are not appear in the figure but they are listed below. It is clear that from this figure the tightly coupled integration has the best performance.

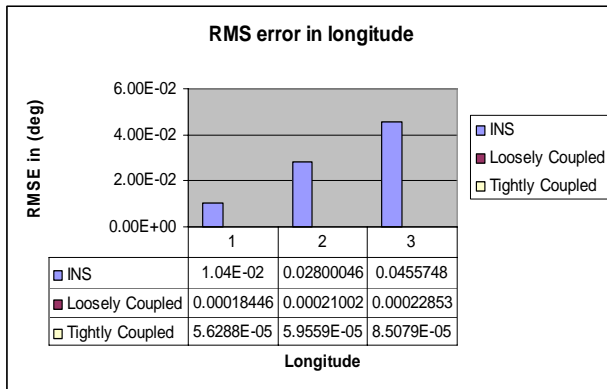

Fig. 32 RMSE in longitude for INS, LC and TC

The RMSE in east and north velocity are shown in Figure 33 and Figure 34 respectively. The loosely coupled performs slightly better than the tightly coupled. The RMSE in the horizontal position is illustrated in Figure 35 the tightly coupled results are the best.

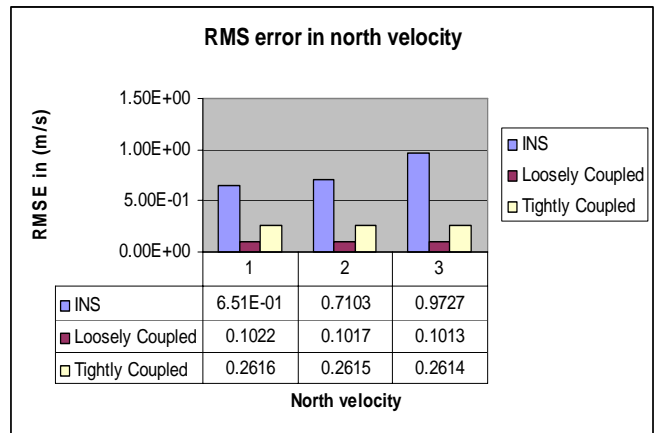

Fig. 34 RMSE in north velocity for INS, LC and TC

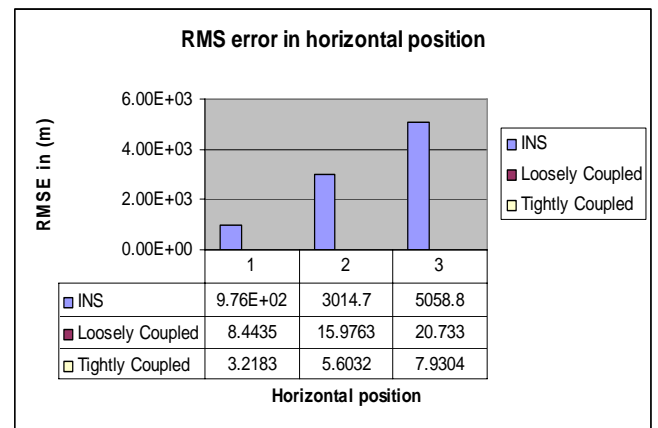

Fig. 35 RMSE in horizontal position for INS, LC and TC

**VIII. CONCLUSION**

INS is a perfect navigation system, as it provides continuous navigation information without being affected by the surrounding environment. While the main problem about using INS to navigation systems is therefore the unlimited errors that will occur over time if no precautions are taken. Errors analysis of INS shows that the initial tilt error has significant effect on the derived INS trajectory so the accurate alignment is necessary to minimize this effect. Under good conditions GPS will be able to provide continuous and

accurate positioning to the user at all time. But unfortunately good conditions will not always occur as the signal from the satellites can be blocked or attenuated by different error sources. The idea is that as INS solutions tend to drift with time, it will be updated as often as possible with measurements from the GPS. The aim of this paper is attempted to show the advantages of INS/GPS integrated navigation system, the INS/GPS integrated system provided a level of position accuracy which is directly associated to the GPS-only solution in a situation of good satellite geometry and no GPS outages. The loosely coupled integrations provide good accuracy under full satellite visibility. Under such conditions, a loosely coupled integration strategy is preferred due to its easier implementation and lower computational load. Even during poor satellite coverage (less than four satellites), using tightly coupled integration the updating of the INS can still be performed. This is due to the use of predicted and raw pseudo range and Doppler measurements.

#### REFERENCES

- [1] Mohander, S.G., Lawrance, R.W., Angus, P.A. *Global positioning system inertial navigation system and integration*, JohnWiley & Sons, 2001.
- [2] Titterton D.H. and Weston, J.L. (1997): "*Strapdown inertial navigation technology*," Peter Peregrinus Ltd., London, UK, 1997.
- [3] El-Sheimy." *Inertial techniques and INS/DGPS Integration*". *ENGO 623- Lecture Notes*, the University of Calgary, Department of Geomatics Engineering, Calgary (2004).
- [4] Hoffmann-Wellenhof, B., H. Lichtenegger, and J. Collins "*Global positioning System; Theory and Practice*", Springer New York. (2001).
- [5] El-Rabbany, A., "*Introduction to GPS: the global positioning system*". (*Artech House mobile communications series*). © 2002 ARTECH HOUSE, INC. 685 Canton Street Norwood, MA 02062.
- [6] B. L. Stevens and F. L. Lewis. *Aircraft Control and Simulation*. John Wiley & Sons, Inc., 1992.
- [7] Greg Welch, "*An Introduction to the Kalman Filter*" Gary Bishop University of North Carolina at Chapel Hill Department of Computer Science Chapel Hill, NC 27599-3175 (2001).