

Gasifier System Identification for Biomass Power Plants using Neural Network

Jittarat Satonsaowapak, Thanatchai. Kulworawanichpong., Ratchadaporn Oonsivilai, Anant Oonsivilai

Abstract—The use of renewable energy sources becomes more necessary and interesting. As wider applications of renewable energy devices at domestic, commercial and industrial levels has not only resulted in greater awareness, but also significantly installed capacities. In addition, biomass principally is in the form of woods, which is a form of energy by humans for a long time. Gasification is a process of conversion of solid carbonaceous fuel into combustible gas by partial combustion. Many gasifier models have various operating conditions; the parameters kept in each model are different. This study applied experimental data, which has three inputs, which are; biomass consumption, temperature at combustion zone and ash discharge rate. One output is gas flow rate. For this paper, neural network was used to identify the gasifier system suitable for the experimental data. In the result, neural network is usable to attain the answer.

Keywords—Gasifier System, Identification, Neural Network

I. INTRODUCTION

THE use of renewable and sustainable energy resources will play a major role in many aspects of electricity generation. In particular, due to environment issues and ever increasing energy demands, the world is forced to look for alternative energy sources. Also, it is anticipated that shortage of hydrocarbon fuel will be inevitable. In terms of population growth, it has been estimated that by the year 2060, the world population will be in excess of 12 billions. Currently, over 80% of the crude oil reserves are under the control of only eight countries. Therefore, a number of strategies, such as special tariff and subsidy agreements, have been established in many countries in order to stimulate the research and utilization of alternative energy sources [5][6].

Biomass is organic material, which has stored solar energy from sunlight in the form of chemical in the plants through

J. Satonsaowapak is with School of Electrical engineering, Institute of Engineering, Suranaree University of Technology 111 University Avenue, Muang District, Nakhon Ratchasima, Thailand 30000 (e-mail: satonsaowapak@hotmail.com).

T. Kulworawanichpong is with Smart Materials and Intelligent System School of Electrical engineering, Institute of Engineering, Suranaree University of Technology 111 University Avenue, Muang District, Nakhon Ratchasima, Thailand 30000 (e-mail: thanatch@sut.ac.th).

A. Oonsivilai, corresponding autor, and R. Oonsivilai are with Center of Excellence in Electric Energy, Smart Materials, and Health Science, Postharvest Technology Research Center, School of Electrical Engineering, Institute of Engineering, Suranaree University of Technology, Nakhon Ratchasima, 30000 Thailand. (e-mail: anant@sut.ac.th).

the process called photosynthesis. Biomass fuels include agricultural wastes, crop residues, wood, and woody wastes etc. Unlike fossil fuels, biomass does not add carbon dioxide to the atmosphere as it absorbs the same amount of carbon while growing. It is the cheapest, eco-friendly, renewable source of energy [4].

Power generation from biomass has emerged as a very interesting complement to conventional sources of energy because of its contribution to the reduction of green house gases [1]. Biomass is recognized to be one of the major potential sources for energy production. There has been an increasing interest for thermochemical conversion of biomass and urban wastes for upgrading the energy in terms of more easily handled fuels, namely gases, liquids, and charcoal in the past decade. It is a renewable source of energy and has many advantages from an ecological point of view [2]. Biomass fuels are characterized by high and variable moisture content, low ash content, low density, and fibrous structure [3].

Biomass gasification is a technology that transforms solid biomass into syngas. It is an important and efficient energy conversion technology along with interventions to enhance the sustainable supply of biomass fuels can transform the energy supply situation in rural areas [2].

Gasifier system is an important part to produce fuel gas. This paper studied the experimental data which have three inputs; biomass consumption, temperature at combustion zone and ash discharge rate. Only output is gas flow rate. This is the energy conversion technologies which is suitable for small-scale.

Backpropagation algorithm refers to the gradient descent algorithm based on the Widrow-Hoff learning rule, in which the network weights are moved along the negative of the gradient of the performance function. The term backpropagation refers to the manner in which the gradient is computed for nonlinear multilayer networks. There are a number of variations on the basic algorithm that are based on other standard optimization techniques.[8]

This paper is divided into five sections. Section 2 presents gasification system. Section 3 presents neural network. Section 4 shows results. Finally, conclusions are presented in section 5.

II. BIOMASS GASIFICATION

Biomass gasification is a Technology that transforms solid biomass into syngas (hydrogen and carbon monoxide mixtures produced from carbonaceous fuel). Biomass fuels are

characterized by high and variable moisture content, low ash content, low density and fibrous structure. In comparison with other fuels, they are regarded as of low quality despite low ash content and very low sulfur content [1]. Biomass gasification system consists of 2 main parts. They are gasifier and gas cleaning system. For the first part, this paper used downdraft gasifiers which are simple and robust. The gas exiting the reactor flowed through a cyclone and scrubbers just to remove a dust and the tars. Next, the clean gas passed through several heat exchangers to condense water vapor. After that, the gas was conditioned to be used in the internal combustion engine [1]. Figure 1 show the biomass gasification system which consists of gasifier, gas cleaning system and engine-generator.

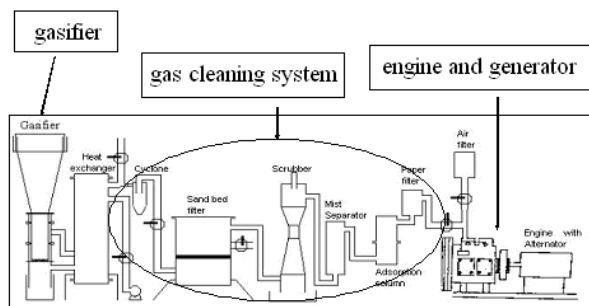

Fig. 1 Shows biomass gasification system

A. Gasifier

Biomass gasification converts solid biomass into more convenient gaseous form. This process is made possible in a device called gasifier. The gasifier was a cylindrical reactor which had the moving bed of biomass rested on a perforated eccentric rotating grate which was at the bottom of the gasifier. The ash fell through the perforated grate to be collected in a lower chamber. The biomass feeding at the top of gasifier after that biomass was burnt in process zones. Finally, the gasifier received producer gas [4]. This is the energy conversion technologies which is suitable for small-scale. Figure 2 shows process zone for downdraft gasifiers.

B. Process zone

Four distinct process take place in a gasifier as the fuel makes its way to gasification. They are [7]:

- a) Drying zone
- b) Pyrolysis zone
- c) Combustion zone
- d) Reduction zone

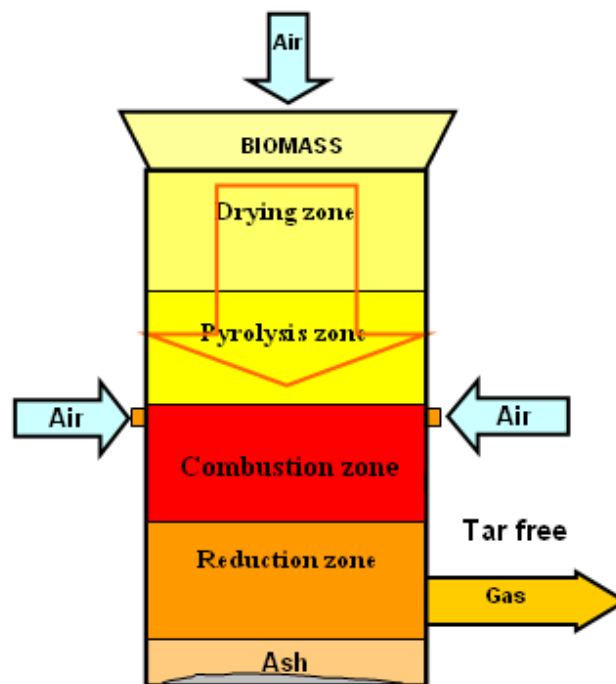

Fig. 2 Shows process zone for downdraft gasifiers

III. BACKPROPAGATION NEURAL NETWORK

Backpropagation is one of the self-learning methods of ANN to give desired answers. ANN is a parallel computing system emulating the ability of the biological neural network by interconnecting many artificial neurons. A three-layered network with an input layer, a hidden layer, and an output layer is depicted in Fig.1. Each layer consists of several neurons and the layers are interconnected by sets of correlation weights. The neurons receive inputs from the initial inputs or the interconnections and produce outputs by transformation using an adequate nonlinear transfer function. A common transfer function is the sigmoid function expressed by [8]

$$f[\cdot] = \text{logsig}(n, b) = \frac{1}{1 + e^{-(n+b)}} \quad (1)$$

Whereas:

n is summation output

b is bias adjust

Based on the schematic relationship shown in Fig. 1 [5]

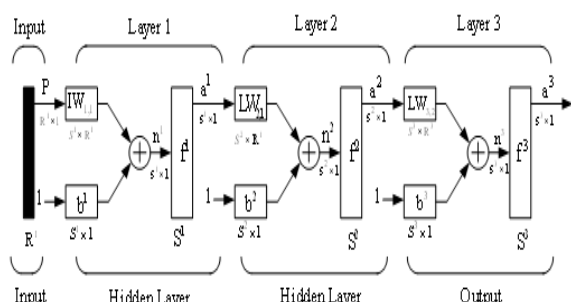

Fig. 3 Shows structure of backpropagation network

Fig.3 shows structure of backpropagation neural network. Input patterns have P_1, P_2, \dots, P_R , a^1 to be output of hidden layer 1 and to be input of hidden layer 2, a^2 to be output of hidden layer 2, a^3 to be final output. f^1, f^2 and f^3 are transfer functions a^1, a^2 and a^3 can get from the algebraic equation as following could:[9]

$$a^1 = f^1(IW_{1,1}P + b^1) \quad (2)$$

$$a^2 = f^2(LW_{2,1}a^1 + b^2) \quad (3)$$

$$a^3 = f^3(LW_{3,2}a^2 + b^3) \quad (4)$$

Whereas:

$IW_{1,1}$ is weights value connections between input layer with hidden layer 1

$LW_{2,1}$ is weights value connections between hidden layer 1 with hidden layer 2

$LW_{3,2}$ is weights value connections between hidden layer 2 with output layer

b^1 is bias value in hidden layer 1

b^2 is bias value in hidden layer 2

b^3 is bias value in output value

In the learning process of backpropagation, the interconnection weights are adjusted using an error convergence technique to obtain a desired output for a given output.

IV. RESULTS AND DISCUSSION

Neural network was successfully applied to estimate gas flow rate. Fig.4-11 show comparison of gas flow rate with observed data set 1 and backpropagation network which various number of neurons which use tansig-purelin function. Fig.4-7 show gas flow rate with 5-1 network. Fig.8-11 show gas flow rate with 10-1 network. Fig.12-19 show comparison of gas flow rate with observed data set 2 and backpropagation network which various number of neurons which use tansig-purelin function. Fig.12-15 show gas flow rate with 5-1 network. Fig.16-19 show gas flow rate with 10-1 network. In the result, neural network which use 10-1 network was better to get the answer.

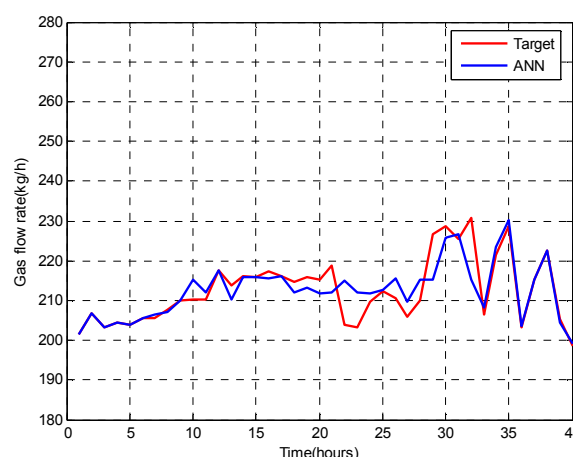

Fig. 4 Comparison of gas flow rate with training data set 1 and 5-1 network

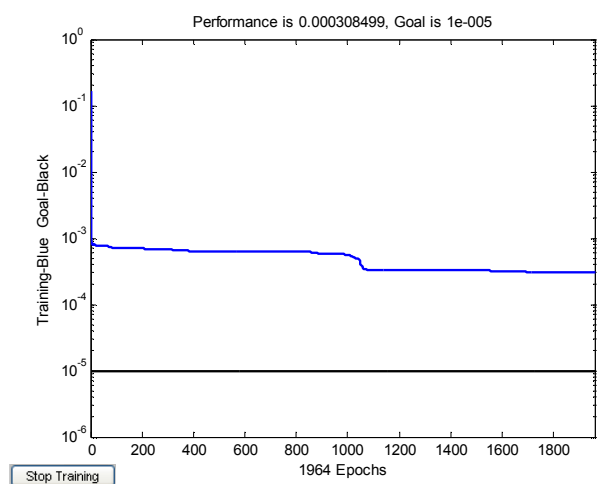

Fig. 5 Gas flow rate error with training dataset 1 and 5-1 network

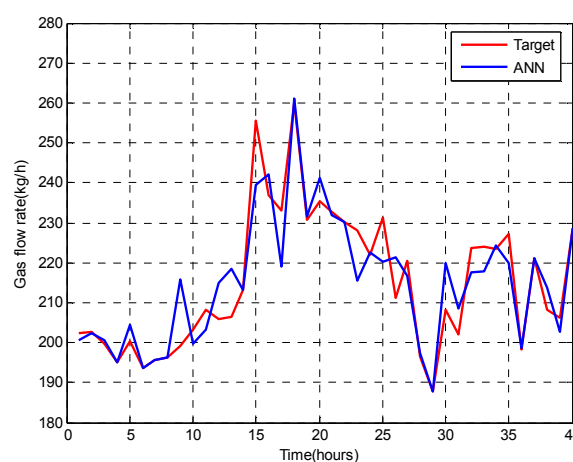

Fig. 6 Comparison of gas flow rate with testing data set 1 and 5-1 network

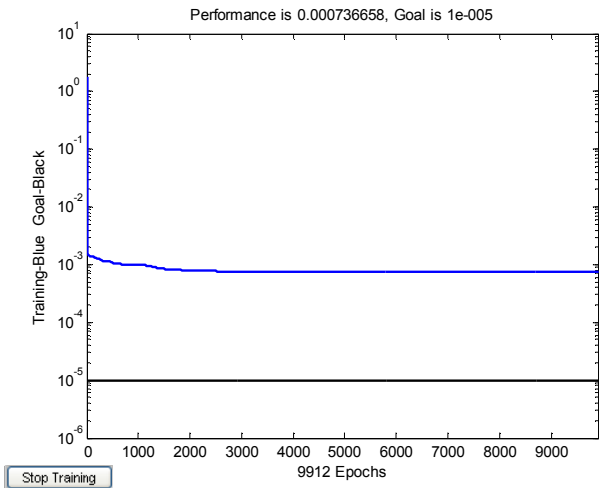

Fig. 7 Gas flow rate error with testing dataset 1 and 5-1 network

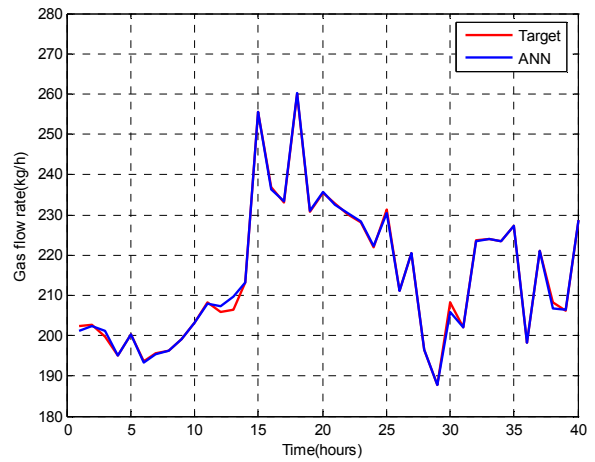

Fig. 10 Comparison of gas flow rate with testing data set 1 and 10-1 network

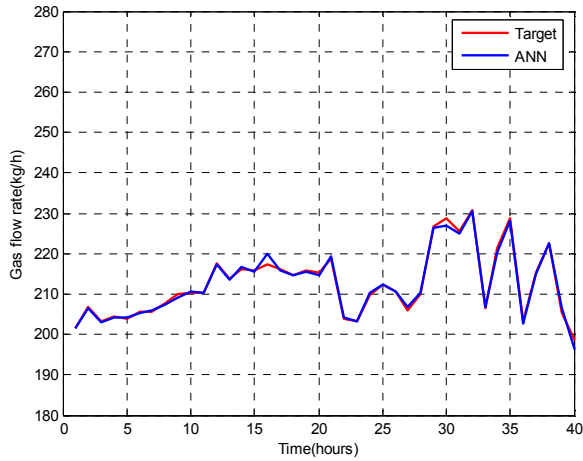

Fig. 8 Comparison of gas flow rate with training data set 1 and 10-1 network

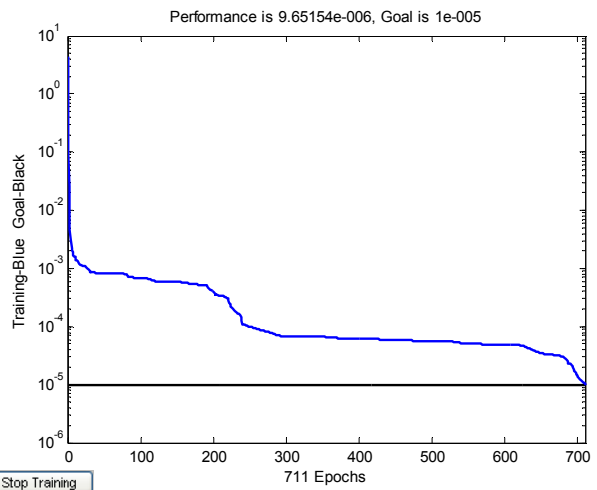

Fig. 11 Gas flow rate error with testing dataset 1 and 10-1 network

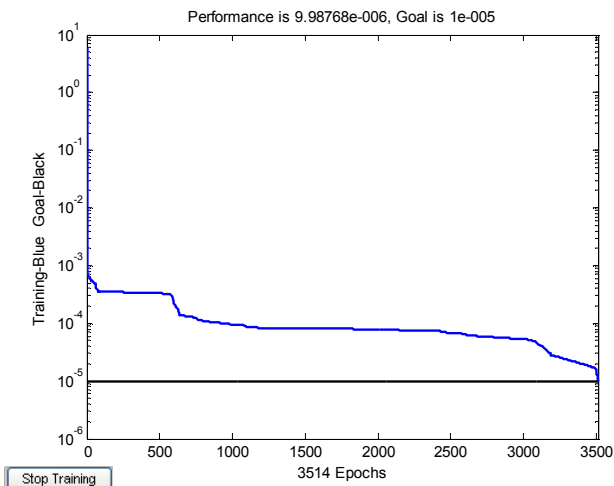

Fig. 9 Gas flow rate error with training dataset 1 and 10-1 network

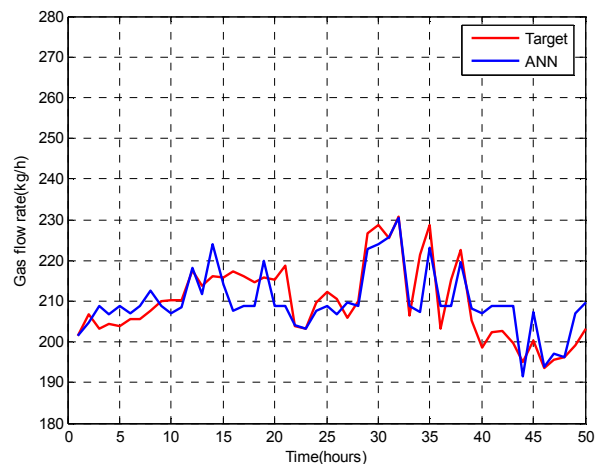

Fig. 12 Comparison of gas flow rate with training data set 2 and 5-1 network

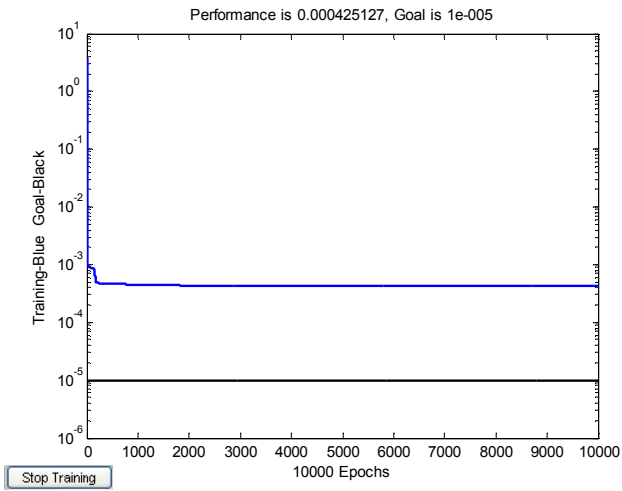

Fig. 13 Gas flow rate error with training data set 2 and 5-1 network

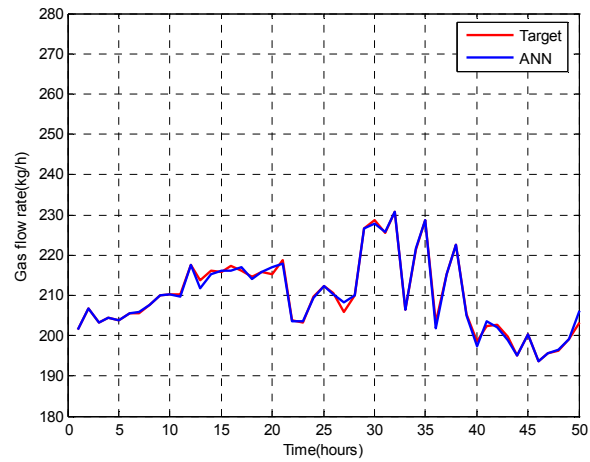

Fig. 16 Comparison of gas flow rate with training data set 2 and 10-1 network

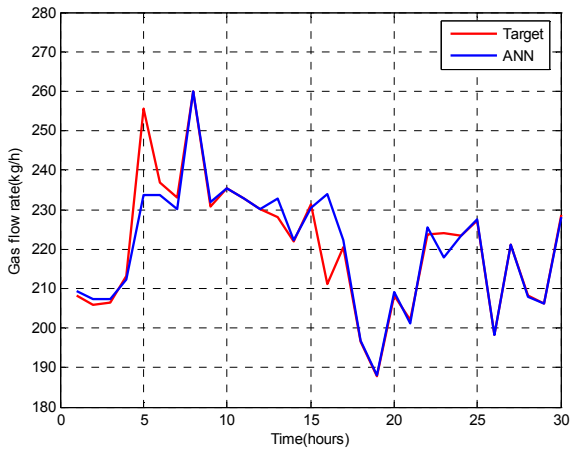

Fig. 14 Comparison of gas flow rate with testing data set 2 and 5-1 network

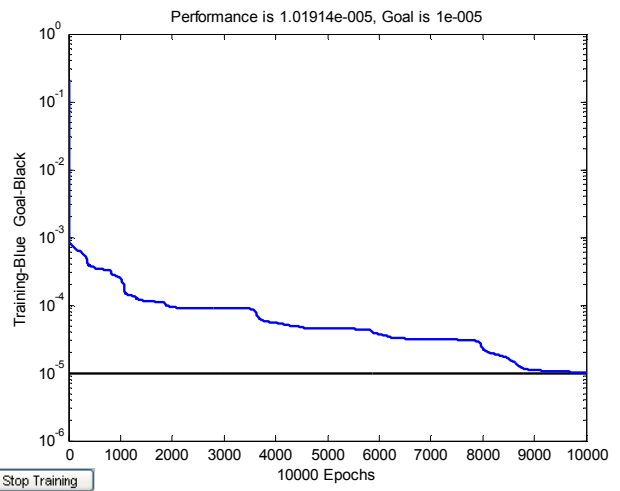

Fig. 17 Gas flow rate error with training data set 2 and 10-1 network

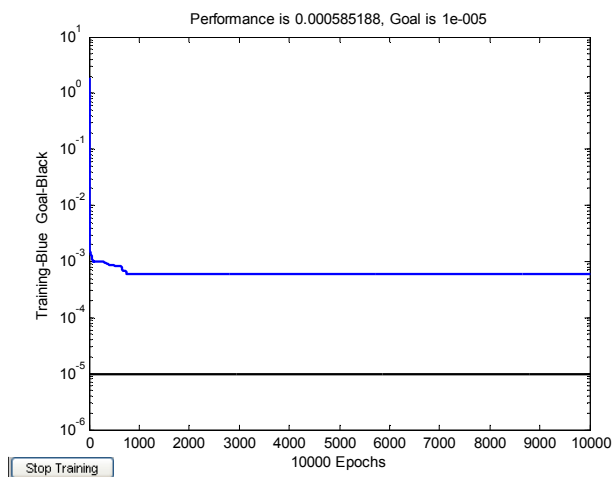

Fig. 15 Gas flow rate error with testing data set 2 and 5-1 network

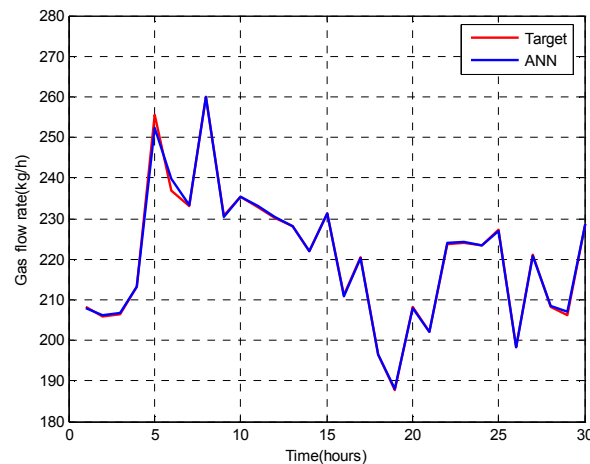

Fig. 18 Comparison of gas flow rate with testing data set 2 and 10-1 network

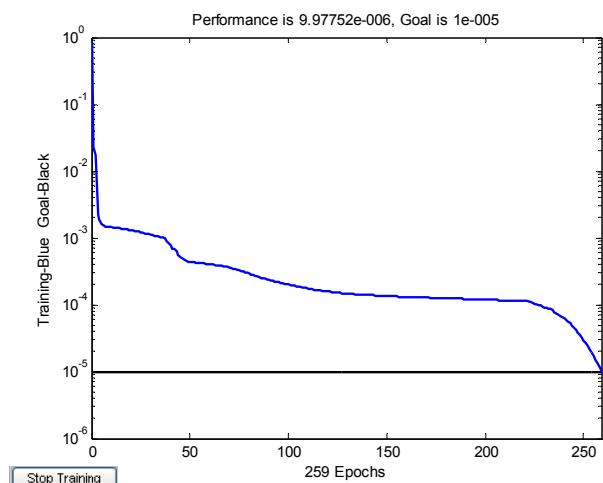

Fig. 19 Gas flow rate error with testing data set 2 and 10-1 network

V.CONCLUSION

Gasifier system is an important part to produce fuel gas. It is good practice to know the function which can be used to predict the results. This study applied the experimental data which have three inputs that entry the system are biomass consumption, ash discharge rate and temperature at combustion zone. Output of system is gas flow rate, which is fuel gas that used in the internal combustion engine. In the results, backpropagation neural network can identify gasifier system to attain an answer and 10-1 network is suitable for using for this experiment.

ACKNOWLEDGMENT

This research was supported by Research and Development Institute Funds, Suranaree University of Technology, Nakhon Ratchasima, Thailand.

REFERENCES

- [1] C. Sagues, P. Hirano, Garcia-Bacaicoa, and S. Serrano, "Automatic control of biomass gasifiers using fuzzy inference systems," *Bioresource Technology*, vol. 98, 1987, pp. 845-855.
- [2] P. N. Sheth, and B. V. Babu, "Effect of Moisture Content on Composition Profiles of Producer Gas in Downdraft Biomass Gasifier," *Proceedings of International Congress Chemistry and Environment (ICCE)*, 2005, pp. 356-360.
- [3] G. Schuster, G. Loffler, K. Weigl, and H. Hofbauer, "Biomass Steam Gasification-an Extensive Parametric Modeling Study," *Bioresource Technology*, 2001, pp. 71-79.
- [4] S. Ashok, and P. Balamurugan, "Biomass Gasifier Based Hybrid Energy System for Rural Areas," *IEEE Canada Electrical Power Conference*, 2007, pp. 371-375.
- [5] W. Panote, C. F. Chun, and C. N. Chem, "A Study on The Potential of Corn Cob Engine-Generator for Electricity Generation in Thailand," *Proceeding of IEEE TENCON'02*, 2002, pp. 1958-1961.
- [6] K. R. Anil, "Biomass Gasification," *Alternative Energy in Agriculture*, vol. II, 1986, pp. 83-102.
- [7] A. Oonsivilai, J. Satonsaowapak, T. Ratniyomchai, T. Kulworawanichpong, P. Pao-La-Or, and B. Marungsri, "Response Surface Method Application in Gasifier System Identification for Biomass Power Plants," *WSEAS Transactions on Systems*, vol. 9, 2010, pp. 629-638.
- [8] S. Chai, B. Veenendaal, G. West, and J. Walker, "Backpropagation Neural Network for Soil Moisture Retrieval using Nafe'05 Data : a Comparison of Different Training Algorithms," *The International*

- Archives of the Photogrammetry, Remote Sensing and Spatial Information Sciences*, vol. XXXVII, 2008, pp. 1345-1349.
- [9] C. Tsai, and T. Lee, "Back-Propagation Neural Network in Tidal-Level Forecasting," *Journal of Waterway, Port, coastal and Ocean Engineering*, vol. 125, 1999, pp. 195-202.