

Prototype Symbol Set Questionnaire

The following images are possible candidates for a specific semantic construct of a visual programming language. Please read the definition of the construct and choose the notation that you think best represents it.

Some of the representations have text in round brackets, this is a note with information to help understand the representation. Text in curly brackets is part of the representation and that text changes based on a variable (Out of context example: "{current date}").

When choosing a representation please ignore its quality, these are quick drafts. To answer just input the number present in the left corner of the visual representations.

1. Pauses the flow waiting for a timeout.

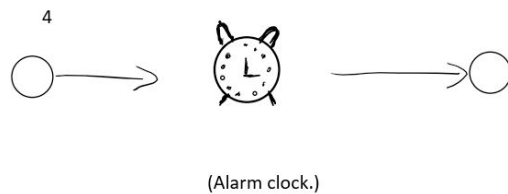
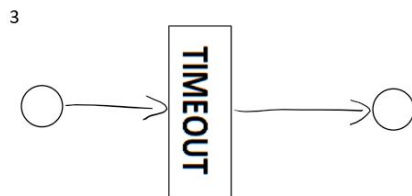
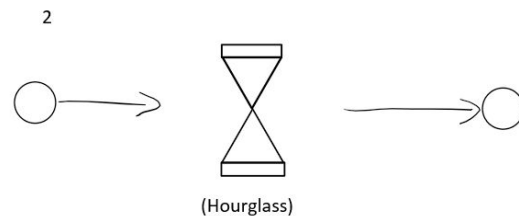
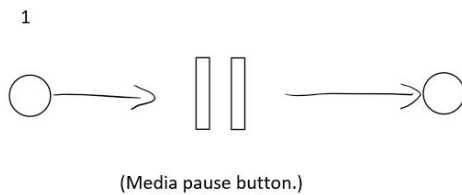

Answer: _____

2. Represent parallelism. The process execution path divides into two parallel paths.

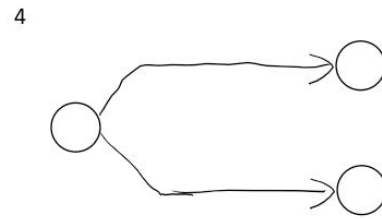
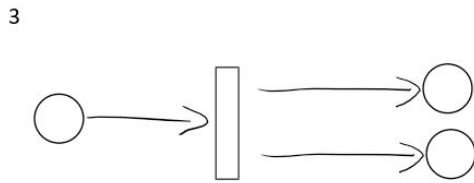
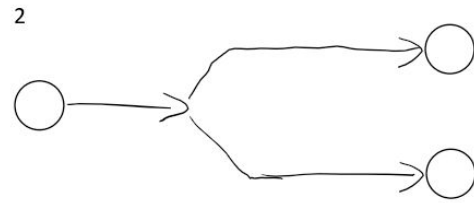
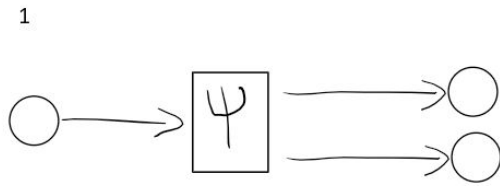

Answer: _____

3. Runs a subprocess. The parent process only proceeds after all flows of the subprocess finish.

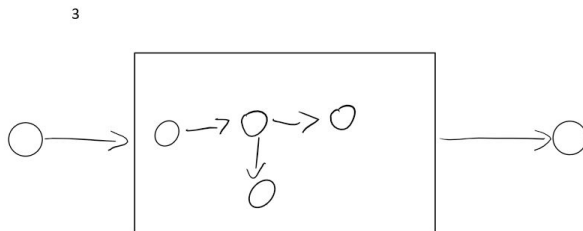
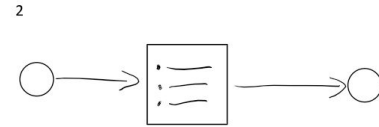
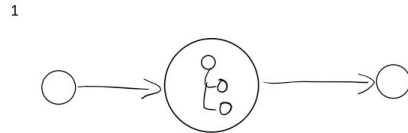

(Inline preview of the logic. Expanded when mouse hover.)



Answer: _____

4. Initiates the process.

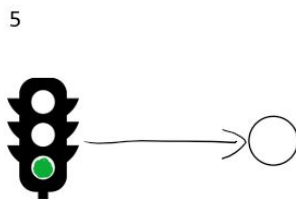
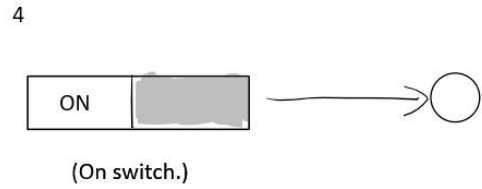
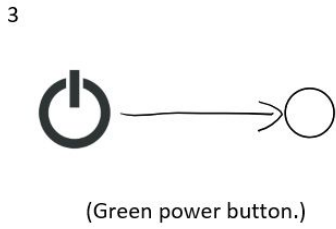
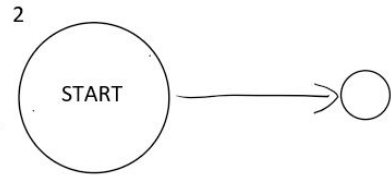
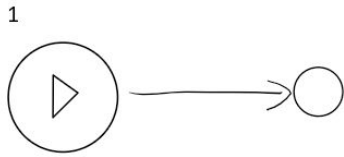

Answer: _____

5. Sends a specified email message in the process flow.

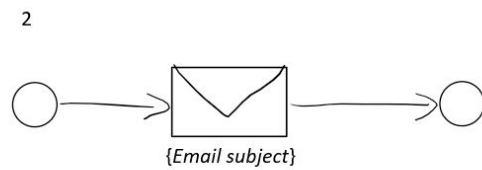

Answer: _____

6. Pauses the execution waiting for a DB event.

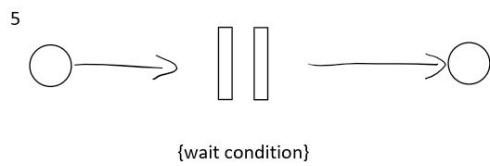
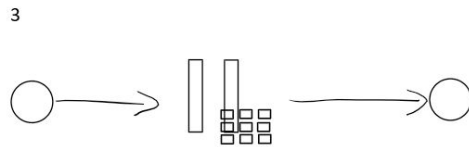
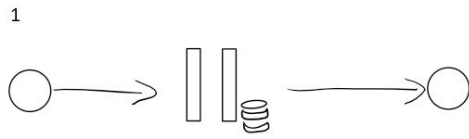

Answer: _____

7. Finishes a process flow. The process may continue in parallel flows.

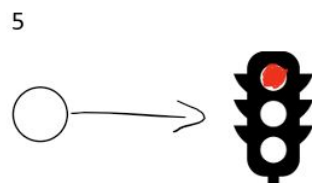
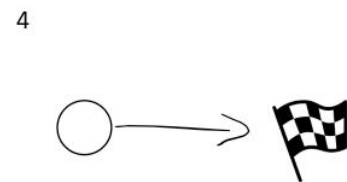
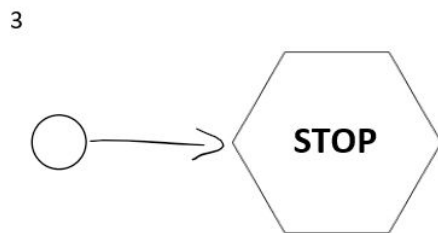
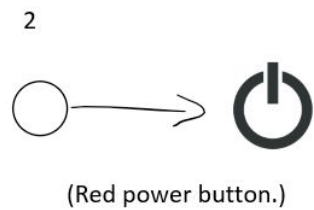
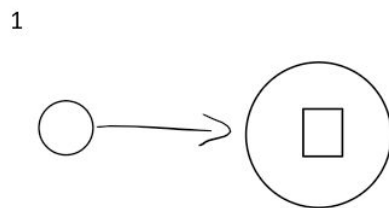

Answer: _____

8. Directs the execution path to a specific activity based on custom logic.

1

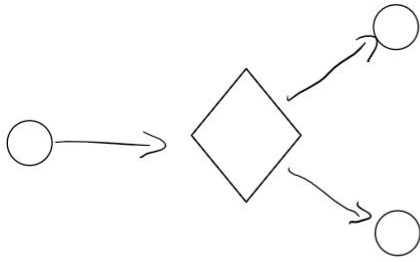

2

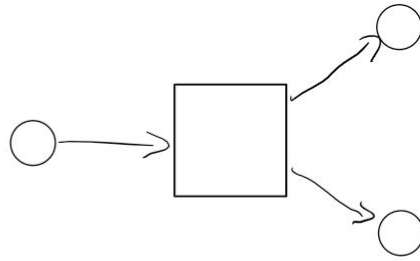

3

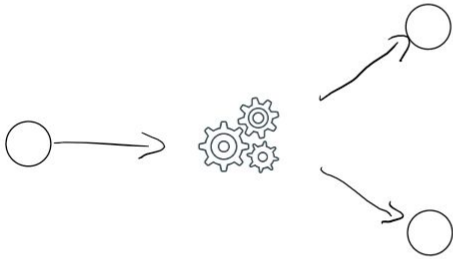

4

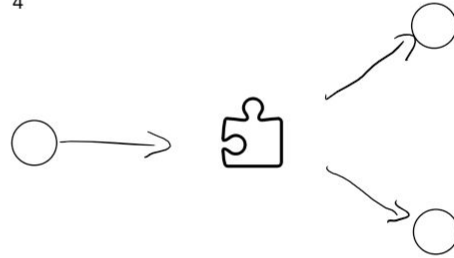

5

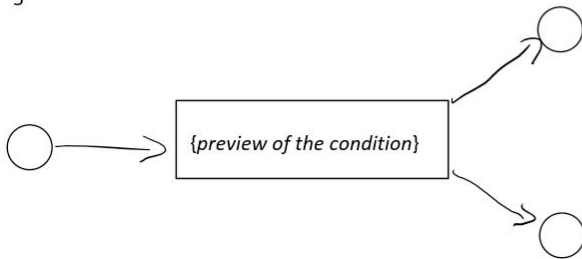

Answer: _____

9. Performs custom logic in the application or in external systems.

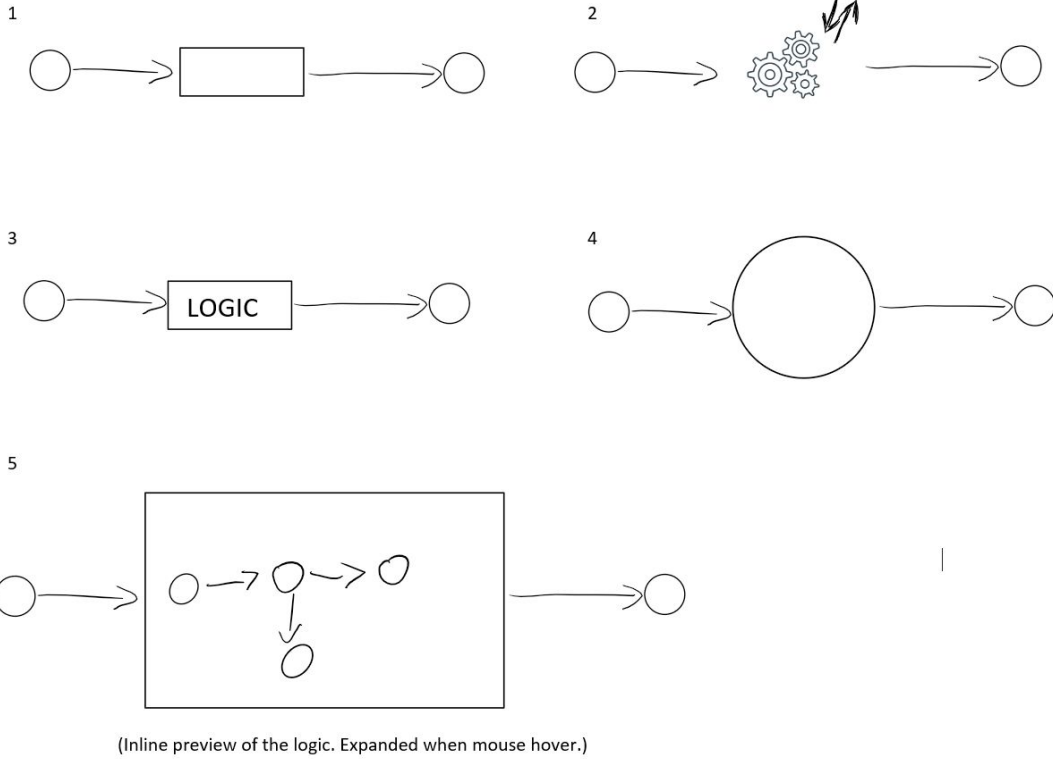

Answer: _____

10. Initiates an alternative flow and may be triggered by a DB event or an explicit API call.

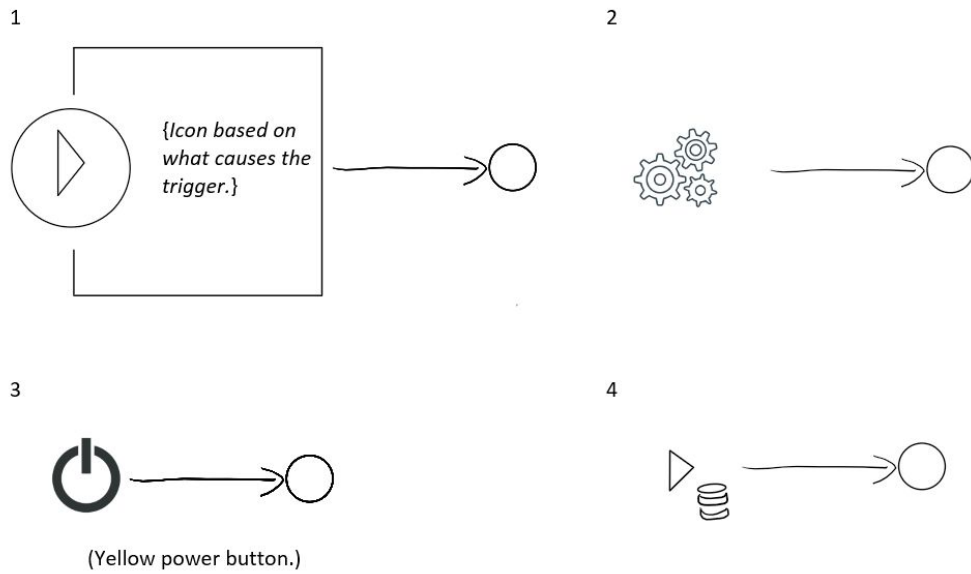

Answer: _____

11. Represent a fork and join: The main execution path is divided into two parallel paths and after each path has finished their task , they merge back into the main execution.

1

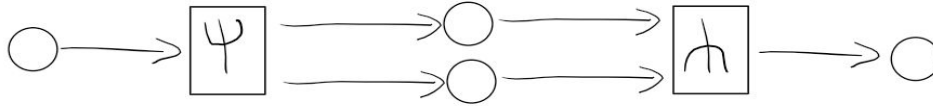

2

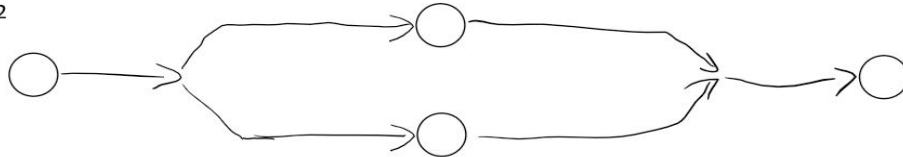

3

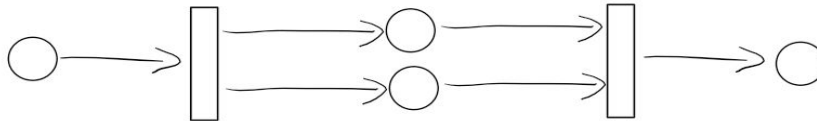

Answer: _____

12. Terminate all the flows of the a process.

1



2

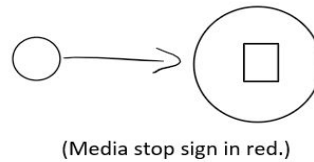

3



4

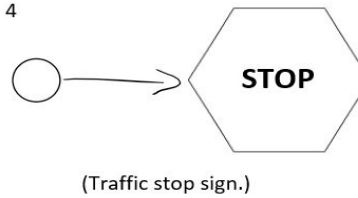

5

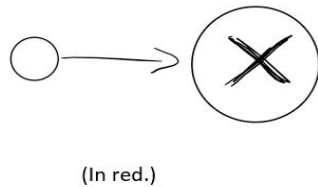

Answer: _____

13. Waits for a user, or group, to complete the given task.

1

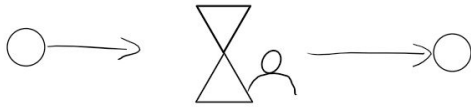

2

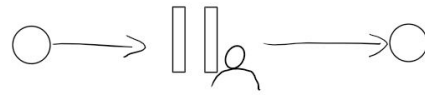

(Media pause button.)

3



4

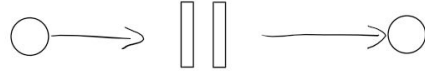

{wait condition}

(Media pause button.)

Answer: _____

14. Used to broadcast an event (via DB) or call an API to deliver an event to a specific activity or process.

1



2

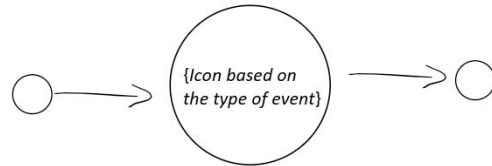

3

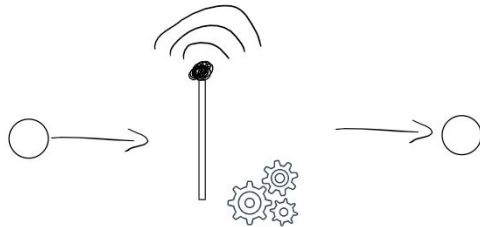

4



Answer: _____

15. Pauses the execution path and resumes when a specific API action is called.

1

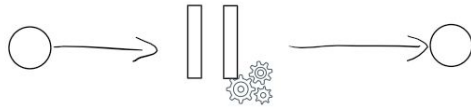

(Media pause button.)

2

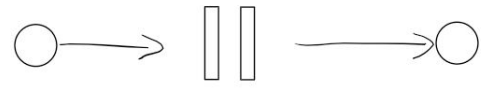

{wait condition}

(Media pause button.)

3

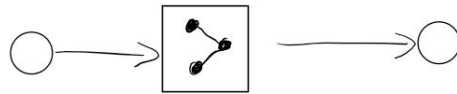

4



5

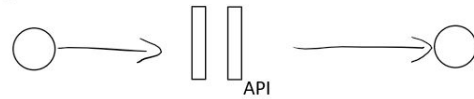

(Media pause button.)

Answer: _____