

On the Virtual Inertia Provision by BESS in Low Inertia Power Systems

Lucian Toma, Mihai Sanduleac,
Stefan Andrei Baltac
Department of Electrical Power
Systems
University Politehnica of Bucharest
Bucharest, Romania

Francesco Arrigo, Andrea Mazza,
Ettore Bompard
Dipartimento Energia
Politecnico di Torino
Torino, Italy

Aysar Musa, Antonello Monti
Institute for Automation of Complex
Power Systems
E.ON Energy Research Center
RWTH Aachen University
Aachen, Germany

Abstract— This paper emphasizes the importance of battery energy storage systems (BESS) for frequency stability in low inertia power systems. A mixed input signal is considered for the BESS control, consisting of the frequency variation and the rate of change of frequency, as a solution to deploy the BESS for providing both inertia and primary frequency control. A sensitivity analysis on the influence of each input signal and the reaction time of the BESS on the frequency control, as well as on the frequency stabilization was performed. Simulation are conducted on a two-area interconnected power system to study and validate the capability of BESS to provide virtual inertia and contribute to system frequency regulation.

Keywords— *virtual inertia, battery, frequency control, power system.*

I. INTRODUCTION

In the last years, the electricity gained the role of multi-purpose vector, due to its possible penetration in mobility (especially with electric vehicle [1]) and heating production (e.g., with the use of heat pumps [2]). On the other hand, the constant increase of the share of Renewable Energy Sources (RES) can lead to decarbonization of the entire electricity sector, thus allowing a substantial decrease of greenhouse gases worldwide. However, to reach this point, the electric system will have to face several important challenges.

Inertia-less system operation is one of the critical challenges that for the power system operators. This is due to the very high share of power electronic-based renewable energy sources, such as photovoltaic (PV) and wind power plants [2]. In such systems, any power disturbance will lead to a significant frequency deterioration and eventually instability problems. Hence, call for new technological advancements is required to preserve a stable frequency profile and enhance system dynamic performance. For this aim, the Battery Energy Storage Systems (BESSs) represents a promising solution to compensate system shrunken inertia by providing virtual (or synthetic) inertia. This in turn, contributes with system frequency regulation.

Recent literature has investigated different approaches for the provision of virtual inertia and frequency regulation. In [4], the authors proposed a control scheme based on frequency

variation and frequency derivative, without considering a droop value, for a wind turbine to calculate the mechanical torque. A similar scheme was proposed in [5] for a storage system to provide frequency control as the sole solution in a microgrid. A sizing methodology for an energy storage system is presented in [6] in case of mixed participation to inertial and primary control in low inertia power systems.

BESSs are very well suited for fast frequency control thanks to their speed and precision in regulating their active power in comparison to traditional generation (TG) units. In fact, TG plant governors have some difficulties to follow fast frequency swings, and power changes could go against the frequency control signal [7]. In the case of Primary Frequency Control (PFC) some studies pointed out that PFC is already profitable for BESSs, while other studies forecasted that the profitability will come in the near future, both alone or in combination with other grid services [8][9][10]. In Germany and UK the ancillary service for frequency control has been already opened to storage systems, and batteries represent the major part of new resources collected [11][12]. Technology and safety reasons make installations expensive and besides severe State of Charge (SOC) dynamics can affect their useful life [13] (optimal use and design need to be assured).

BESSs could be used also to mimic the inertial response of synchronous generators. Virtual synchronous generators [14][15] are converters controlled for reproducing the dynamics of synchronous generators. The storage is needed to provide the energy necessary to control the active power output. Various forms of control can be possible with different impact on the grid [16][17].

This paper aims to highlight the impact of BESSs in low inertia power systems, when a proper combination of frequency variation signal and Rate of Change of Frequency (RoCoF) signal is used as an input to the control of BESSs. The study is conducted by considering two-area power system dynamically modeled, and shows how BESSs can contribute to compensate system shrunken inertia and suppress effectively the frequency deviation during power disturbances. Furthermore, a sensitivity analysis has been performed, for highlighting the influence of relevant input signals on sizing and the reaction time response of BESSs.

The paper is organized as follows. Section II presents the rationale behind the scenarios definition. Section III shows the two-area power system and all the components used in the simulations. Section IV presents the simulation results, and finally Section V reports the final remarks.

II. RATIONALE FOR THE SCENARIO DEFINITION

The scenarios considered in this paper aim to represent a future condition of 100% RES-based system: the implementation of this condition leads to consider several aspects of planning and operation of the system, as well as to overcome new challenges [18].

By considering frequency regulation, the indication of 100% RES-based electricity system is not useful for understanding which type of control will be implemented in the future. In fact, the most important aspect to be considered for frequency is the existence (or not) of system inertia. The inertia is strictly correlated to the installation of rotating machines, e.g., turbines and generators, which are the basic components of the frequency regulation as it is now.

In this framework, the EU project RE-SERVE [19] aims to study the possible operation of the electricity system in terms of voltage and frequency control, in case of 100% RES electricity production.

Within the project, two different scenarios have been suggested. The Scenario A implies the use of both inertial generators (in particular, hydroelectric power plants) and inverter-based sources (PV and wind in particular), whereas the Scenario B is entirely based on inverter-based power plants, (i.e., zero inertia generators). Both of them aim to reach 100% RES-based electricity generation, and both require the use of storage systems.

In this framework, this paper defines more precisely the values to be used in Scenario A. The implemented Scenario A is compared with a *Base case*, which also considers thermoelectric power plants in operation.

III. SYSTEM DESCRIPTION

A two-area power system is considered and modelled for frequency control studies. The two areas, generically denoted by i and k , are interconnected through a tie-line. Both primary and secondary frequency controls are considered, as illustrated in the next sections.

A. Governor-Turbine models

Three types of governor-turbine models are used in the model, i.e., for hydraulic, reheat and non-reheat units. Additionally, the BESS is also considered for inertial control.

Fig. 1 shows the governor-turbine generic model for a hydraulic unit. The input is the reference value of the variation of the mechanical power ΔP_m^{ref} (resulting from primary and secondary control), whereas the output is the variation of the mechanical power produced by the turbine.

Fig. 2 shows the governor-turbine generic model for a reheat unit, whereas Fig. 3 shows the governor-turbine generic model for a non-reheat unit.

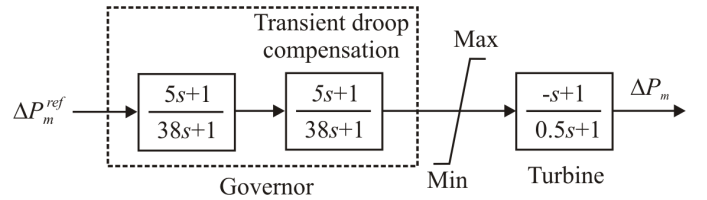

Fig. 1. Block diagram of hydraulic unit [20].

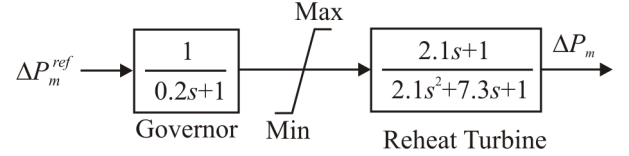

Fig. 2. Block diagram of reheat unit [20].

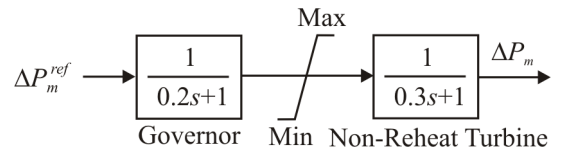

Fig. 3. Block diagram of non-reheat unit [20].

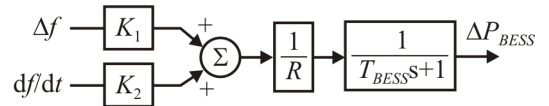

Fig. 4. Control block diagram of BESS.

B. BESS modelling

The dynamic model for the BESS is shown in Fig. 4.

The component related to Δf is similar to the primary frequency control level (droop control), whereas the component related to RoCoF (df/dt) aims to simulate a virtual inertia. The two input signals are weighted by K_1 and K_2 factors. The battery dynamics is modelled as a first order transfer function [21] which is suitable for power system stability studies such as the study presented in this paper.

C. Modelling the interconnection link

The power flow through the tie-line between the two interconnected systems is given by [22]:

$$P_{ik} = \frac{E_i E_k}{X_L} \sin(\delta_i - \delta_k) \quad (1)$$

where E_i and E_k are the voltage magnitudes at the two terminals of the tie-line, X_L is the tie-line reactance, and δ_i and δ_k are the voltage angles at the two terminals. Note that, if ΔP_{ik} (power flowing between areas i and k) is positive for one area, it will be negative for the other area.

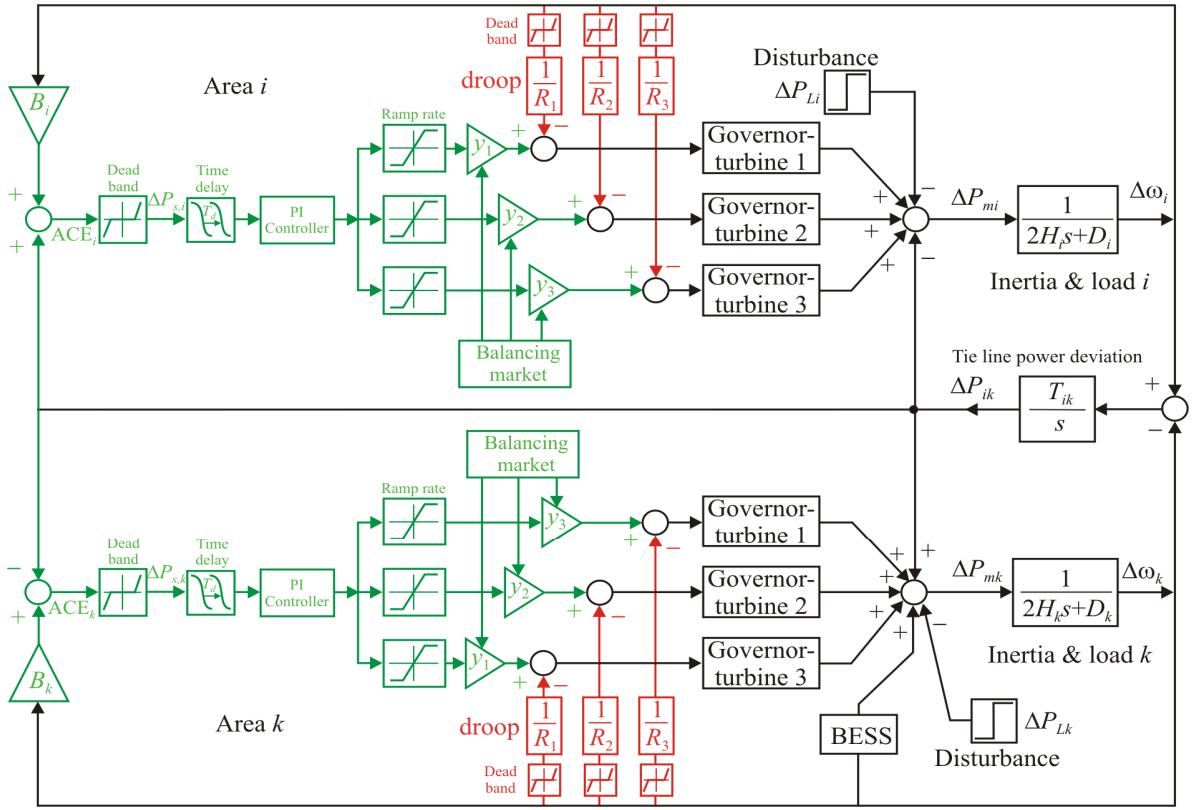

Fig. 5. Power system model used for the study.

Linearizing about an initial operating point represented by $\delta_i = \delta_{i0}$ and $\delta_k = \delta_{k0}$, one can obtain the active power variation on the interconnection line:

$$\Delta P_{ik} = T_{ik} \Delta \delta_{ik} \quad (2)$$

where $\Delta \delta_{ik} = \delta_i - \delta_k$, and T_{ik} is the synchronizing torque coefficient between the two power systems, that is:

$$T_{ik} = \frac{E_i E_k}{X_L} \cos(\delta_{i0} - \delta_{k0}) \quad (3)$$

Note that, in initial conditions, the phase angle difference $\delta_{i0} - \delta_{k0}$, should not exceed 30° .

D. System inertia and load

The power system as a whole is modelled through the equivalent inertia H , and the load factor D . The purpose of this work is to analyze the behavior of a power system in terms of frequency control capability in the case of reduced equivalent inertia, based on the indications reported in Section II. For this reason, the simulations have been done for inertia values smaller than the traditional ones.

As mentioned in Section II, *Base case* scenario indicates a power system with a high share of generation from renewable

energy sources, where thermoelectric power plants are still in operation. For the *Base case* scenario, an average inertia $2H = 6.5$ s was assumed. Note that the higher mechanical inertia values characterize the thermoelectric power plants [20][23], while the lower values are specific to the hydroelectric power plants. Therefore, as the thermoelectric power plants are shut down, the mechanical inertia will significantly decrease.

The above *Base case* scenario has been compared with a *Future scenario*, in which no thermoelectric power plants are considered. This scenario defines more precisely the Scenario A introduced in RESERVE [19]. Only the hydroelectric units are considered in the simulations as traditional plants and, due to this, an equivalent inertia $2H = 3$ s (lower than the one of the *Base case* scenario) has been considered.

E. Primary control

The primary control is simulated through the droop control signal, as illustrated in Fig. 5 (in red). Using the droop equation, we achieve the contribution of a generation unit t for frequency stability, that is:

$$\Delta P_{i,t} = -\frac{\Delta \omega_i}{R_{i,t}} \quad (4)$$

The droop R was considered 5% for all units.

F. Secondary Control

An Area Control Error (ACE) is calculated for each area, using the following formulas:

$$ACE_i = \Delta P_{ik} + B_i \Delta \omega_i \quad (5)$$

$$ACE_k = \Delta P_{ki} + B_k \Delta \omega_k \quad (6)$$

where $B = 21$ is the bias factor, and $\Delta \omega$ is the angular speed deviation.

The tie-line bias control, $\Delta P_{ik} = -\Delta P_{ki}$, forces the area with the disturbance to meet its own power mismatch with the other area contributing to the transient condition of the system [22].

A PI regulator is then employed for each area, aiming at bringing the steady state frequency deviation to zero. The output signal is first weighted by a participation factor y_i (different for every generator and established within the balancing market), then fed into the governor summing point along with the droop signal as shown in Fig. 5. Note that, the sum of all participation factors must be 1.

IV. SIMULATIONS AND RESULTS

Two scenarios have been performed, in order to emphasize the importance of the energy storage systems in low inertia power systems. The model and the parameter settings have been developed to identify qualitative solutions.

All simulations have been performed assuming a reference step power imbalance in area k of 0.01 p.u. occurring at 5 seconds from the simulation start.

A. Influence of inertia on the frequency stability

The importance of the mechanical inertia for frequency stability (in a system without storage) has been then analyzed. Fig. 6 shows the comparison between the *Future scenario* ($2H=3$ s and indicated as Freq. 1) and the *Base case scenario* ($2H=6.5$ s, indicated as Freq. 2). It is worth to note that the *Future scenario* (i.e., Freq. 1) is characterized by mechanical inertia (provided only by hydro power plants) close to the stability limit, and this leads to have large frequency oscillations.

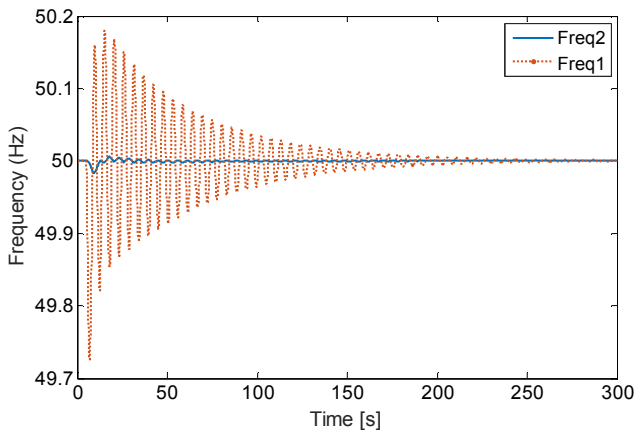

Fig. 6. Frequency variation in low inertia power system.

B. Contribution of the classical power plants to frequency control

After having shown the importance of the mechanical inertia in Section IV.B, this section aims to analyze the contribution of the different traditional plants installed in the system when the *Base case* scenario is considered. For making this scenario comparable with the *Future* scenario, also BESSs (characterized by a time response $T_{BESS} = 0.1$ s) are employed for frequency control. In particular, the input signal of the BESSs has been set to be $0.2\Delta f + 0.8df/dt$.

Fig. 7a illustrates the frequency variation in areas i and k for *Base case* scenario: the variation is within acceptable limits, i.e. 20 mHz.

The simulation also shows that the thermoelectric power plants (reheat and non-reheat) are capable to provide better response than the hydroelectric units for frequency stabilization, in droop control (Fig. 7b). Then, the powers are controlled to reach a steady state value within the AGC level, equal to the participation factor set by the balancing market.

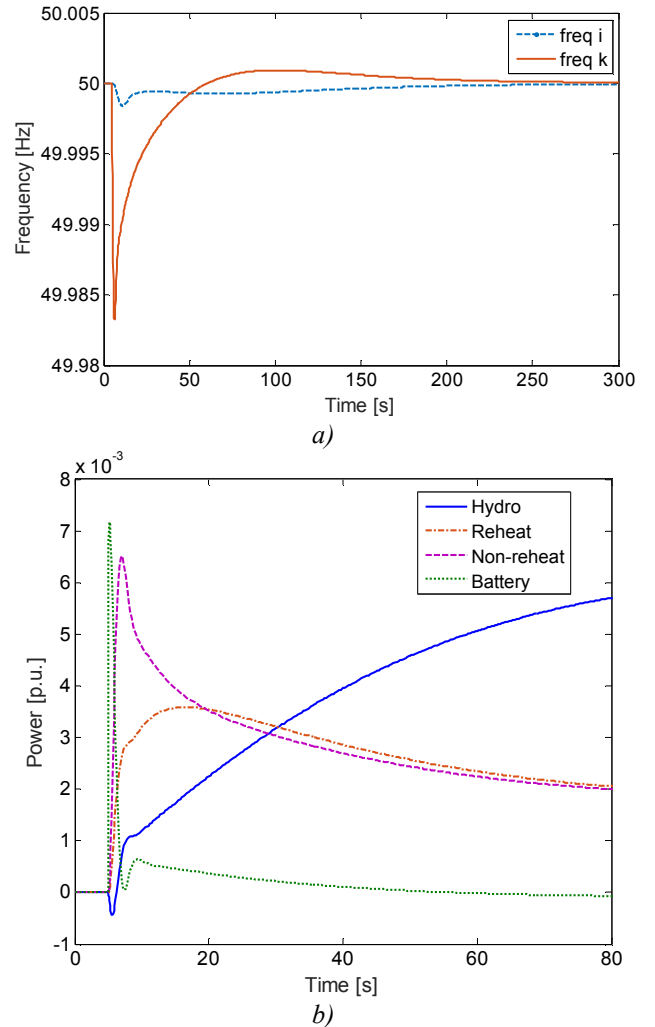

Fig. 7. System behaviour under normal inertia value and all types of generation units considered for frequency control.

C. BESS contribution to frequency stabilization

In most power systems, the hydraulic power plants are the most suitable for the secondary frequency control because they have the best performances in terms of reserve deployment. However, as shown in Fig. 7b, their reaction time in transient conditions is higher than those of the thermoelectric power plants. This inconvenience can be overcome by using a battery energy storage.

Let us consider the *Future scenario* ($2H = 3$ s) and find out appropriate frequency stability solutions. Hydroelectric units are kept as the only entity for power balancing, whereas BESS units are introduced to provide frequency support. The BESS model employed is the one shown in Fig. 4. Three types of analysis have been performed, as explained in the following.

1) Analyzing the effect of the weights in the controller

As shown in Fig. 4, a mixed input signal is considered for the BESS model, i.e. the frequency variation and the rate of change of frequency. The two input signals have been weighted in order to determine their contribution in the frequency response. The two coefficients range between 0.2 (low weight) to 0.8 (high weight) to initially study the controller response. As further hypothesis, unlimited power is available in the battery for frequency control. Time response $T_{BESS} = 0.1$ s was considered and moreover virtual inertia term follows the BESS natural dynamics.

Fig. 8 shows the frequency response when using different weighting factors for the input signals to BESS. The simulations show that a larger weighting factor assigned to the frequency variation reduce the frequency sag, whereas a larger weighting factor assigned to the RoCoF component provide a smoother behavior in terms of frequency oscillations damping.

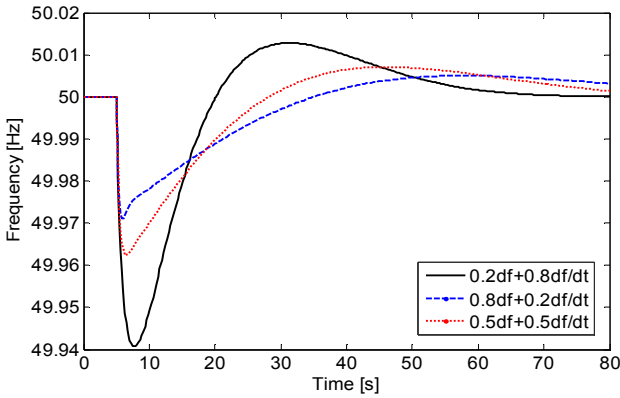

Fig. 8. Frequency response in low inertia power system by contribution of BESS (the case of unlimited power reserve).

2) Analyzing the effect of battery size

In order to identify the importance of the input signal for frequency control, we have introduced in the model a saturation block to reduce the reserve available for control. The BESS control band was set to $P_{max}=0.005$ p.u. and $P_{min} = -0.005$ p.u, values smaller than the unbalance.

Fig. 9 illustrates the frequency response for the same weighting factors used in the case shown in Section IV.C.1).

For all the weighting values, the frequency drops to the same value (around 49.92 Hz, worse than the one reach in case of unlimited reserve shown in Fig. 8), and then it is damped toward a steady value within a similar time frame. This fact shows that, even if the size of the deployed reserve is very important to limit the frequency sag, the limited reserve does not affect the frequency stabilization.

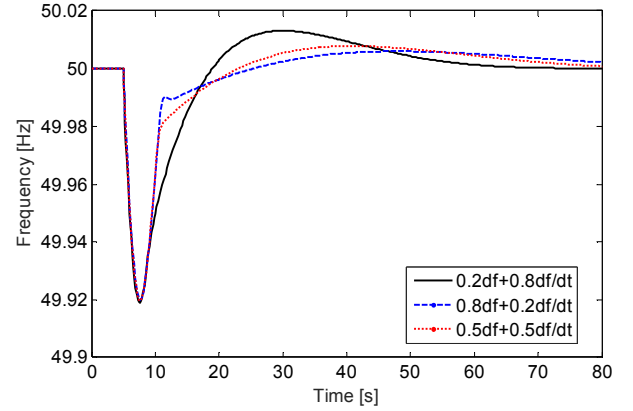

Fig. 9. Frequency response for battery having reserve limits.

3) Analyzing the effect of the time reaction

The previous simulations have been done for time response of the BESS of 0.1 seconds. However, different BESS technologies may have different time reactions. In the following, the input signal of the BESS has been set to $0.2\Delta f+0.8df/dt$, and three different time constant for the BESS have been analyzed

Fig. 10 illustrates the frequency response for three time response values of the BESS model, showing that, in low inertia power systems, for time reactions of the BESS greater than 1 second, the frequency oscillations become unacceptable. The oscillations are caused by the slow intervention of BESS (Fig. 10 shows only the frequency of the area k).

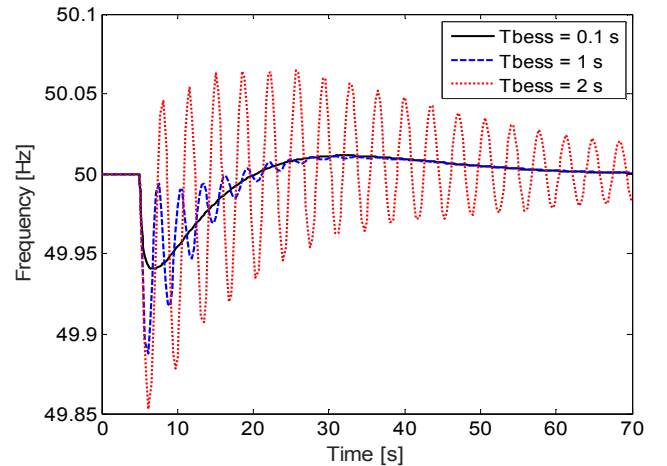

Fig. 10. Influence of the BESS time response on the frequency stability.

The fast reaction time is needed in order to compensate the low inertia caused by the replacement of the thermal power plants (characterized by large inertia) with power electronic based generation units (characterized by low inertia).

4) Worth results from the simulation

Some remarkable results from the previous simulations are pointed out in the following

- Fig. 8 shows as unlimited reserve (i.e., representative of power-intensive and fast responsive devices) is more appropriate for providing inertial frequency control. Thus, flywheels and super-capacitors are good choices for this type of control. From technical point of view, these two forms of storage can be charged very fast, meaning that they are capable to provide inertial response for the next (and relative close in time) important events occurring in the power system.
- Fig. 9 shows as limited reserve (i.e., representative of power-limited devices), are more appropriate for providing primary frequency control. As a matter of example, batteries such as the Li-ion batteries can be a good choice, due to the fact that they are characterized by lower power and higher energy than other batteries.

V. CONCLUSIONS

This paper proposed a control model for the participation of BESSs to the frequency control. In order to evaluate the proposed model, a sensitivity analysis have been conducted. The simulations have revealed the following aspects:

- In power systems with reduced mechanical inertia, the hydraulic units alone are not capable of stabilizing the frequency.
- In order to allow frequency stabilization, fast reaction power sources, such as BESSs, must be used in such a way to simulate a virtual inertia.
- Frequency stabilization depends on the immediate action of the fast sources. The amount of power produced by the sources influences the frequency nadir.
- The primary frequency control level can be improved by compounding two input signals, namely the RoCoF and Δf .

In future work BESS model will be improved based on these results and different layouts to provide virtual inertia will be considered.

ACKNOWLEDGMENT

This work has been funded by the European Commission through the Horizon 2020 research and innovation programme, under the RESERVE project grant agreement No. 727481, and Storage4Grid project grant agreement No. 731155.

REFERENCES

- [1] EU Commission, GreenMotion project, <http://www.greenemotion-project.eu>
- [2] J. Schachter, N. Good and P. Mancarella, P. (2015). "Business case for electric heat pumps under different day-ahead price scenarios," 2015 12th International Conference on the European Energy Market (EEM), Lisbon, Portugal, 2015.
- [3] H. Bevrani, Robust Power System Frequency Control, 2nd Edition, Springer International Publishing, Switzerland, 2014.
- [4] J. Morren, S.W.H. de Haan, W.L. Kling, J.A. Ferreira, "Wind turbines emulating inertia and supporting primary frequency control", IEEE Transactions in Power Systems, vol. 21, no. 1, pp. 433-434, February 2006.
- [5] I. Serban, R. Teodorescu, M. Marinescu, "Energy storage systems impact on the short-term frequency stability of distributed autonomous microgrids, an analysis using aggregate models", IET Renewable Power Generation, vol. 7, no. 5, pp. 531-539, September 2013.
- [6] V. Knap, S.K. Chaudhary, D.-I. Stroe, M. Swierczynski, B.-I Craciun, R. Teodorescu, "Sizing of an Energy Storage System for Grid Inertial Response and Primary Frequency Reserve", IEEE Transactions on Power Systems, vol. 31, no., 5, September 2016.
- [7] S. Chen, T. Zhang, H.B. Gooi, R. Masiello, and W. Katzenstein, "Penetration rate and effectiveness studies of aggregated BESS for frequency regulation". IEEE Transactions on Smart Grid, vol. 7, no. 1, pp. 167-177, 2016.
- [8] A. Oudalov, D. Chartouni, C. Ohler, and G. Linhofer, "Value analysis of battery energy storage applications in power systems", 2006 IEEE PES Power Systems Conference and Exposition, PSCE'06, pp. 2206-2211, October 2006.
- [9] R. Kempner, E. Borden, "Case studies: battery storage," IRENA, 2015
- [10] J. Fler and P. Stenzel. "Impact analysis of different operation strategies for battery energy storage systems providing primary control reserve," Journal of Energy Storage.2016.
- [11] R. Hollinger, L.M. Diazgranados, and T. Erge, "Trends in the German PCR market: perspectives for battery systems". 12th IEEE International Conference on the European Energy Market (EEM), 2015.
- [12] National Grid. National Grid website. url: <http://www2.nationalgrid.com/Enhanced-Frequency-Response.aspx>
- [13] M. Koller, T. Borsche, A. Ulbig, G. Andersson, "Defining a degradation cost function for optimal control of a battery energy storage system," 2013. IEEE Grenoble PowerTech, Grenoble, France, 2013.
- [14] B. Hassan, T. Ise, and Y. Miura, "Virtual synchronous generators: A survey and new perspectives," International Journal of Electrical Power & Energy Systems, vol. 54, pp. 244-254; January 2014.
- [15] S. Rubino, A. Mazza, G. Chicco, M. Pastorelli, "Advanced control of inverter-interfaced generation behaving as a virtual synchronous generator," 2015 IEEE Eindhoven PowerTech, Netherlands, 2015.
- [16] F. Gonzalez-Longatt, M. Francisco., and S. M. Alhejaj. "Enabling inertial response in utility-scale battery energy storage system." 2016 IEEE Innovative Smart Grid Technologies-Asia (ISGT-Asia), Melbourne, Australia, 2016.
- [17] F. Gonzalez-Longatt, S. Alhejaj, A. Bonfiglio, R. Procopio, and J.L. Rueda. "Inertial frequency response provided by battery energy storage systems: Probabilistic assessment," 2017 6th International Conference on Clean Electrical Power (ICCEP), pp. 403-409, June 2017
- [18] B.P. Hearda, B.W. Brookb, T.M.L. Wigleya, C.J.A. Bradshawd, "Burden of proof: A comprehensive review of the feasibility of 100% renewable-electricity systems," Renewable and Sustainable Energy Reviews, vol. 76, pp. 1122-1133, September 2017,
- [19] EU project RES-ERVE, <http://www.re-serve.eu/>
- [20] P. Kundur, Power System Stability and Control, McGraw-Hill, New York, 1994.
- [21] S. Chen, T. Zhang, HB Gooi, RD Masiello, W Katzenstein. Penetration rate and effectiveness studies of aggregated BESS for frequency regulation. IEEE Transactions on Smart Grid. 2016 Jan;7(1):167-77.
- [22] M. Eremia and M. Shahidehpour, (Editors), Handbook of Electrical Power System Dynamics: Modeling, Stability, and Control, Wiley & IEEE Press, Power Engineering Series, Hoboken-USA, March 2013.
- [23] D.P Kothari, I.J Nagrath, Modern Power System Analysis. Third Edition, Tata McGraw Hill, New Delhi, 2003.
- [24] J. Cerqueira, F. Bruzzone, C. Castro, S. Massucco, F. Milano, "Comparison of the dynamic response of wind turbine primary frequency controllers constraints", 2017 IEEE PES General Meeting, Chicago, USA, 2017.
- [25] Á. Ortega, F. Milano, Modeling, Simulation and Comparison of Control Techniques for Energy Storage Systems", IEEE Transactions on Power Systems, vol. 32, no. 3, pp. 2445-2454, May 2017.