



# Hypothesis on *Serenoa repens* (Bartram) small extract inhibition of prostatic $5\alpha$ -reductase through an *in silico* approach on $5\beta$ -reductase x-ray structure

Paolo Governa<sup>1,2</sup>, Daniela Giachetti<sup>1</sup>, Marco Biagi<sup>1</sup>, Fabrizio Manetti<sup>3</sup> and Luca De Vico<sup>2</sup>

<sup>1</sup>Department of Physical Sciences, Earth and Environment, University of Siena, Siena, Italy

<sup>2</sup>Department of Chemistry, University of Copenhagen, Copenhagen, Denmark

<sup>3</sup>Department of Biotechnology, Chemistry and Pharmacy, University of Siena, Siena, Italy

## ABSTRACT

Benign prostatic hyperplasia is a common disease in men aged over 50 years old, with an incidence increasing to more than 80% over the age of 70, that is increasingly going to attract pharmaceutical interest. Within conventional therapies, such as  $\alpha$ -adrenoreceptor antagonists and  $5\alpha$ -reductase inhibitor, there is a large requirement for treatments with less adverse events on, e.g., blood pressure and sexual function: phytotherapy may be the right way to fill this need. *Serenoa repens* standardized extract has been widely studied and its ability to reduce lower urinary tract symptoms related to benign prostatic hyperplasia is comprehensively described in literature. An innovative investigation on the mechanism of inhibition of  $5\alpha$ -reductase by *Serenoa repens* extract active principles is proposed in this work through computational methods, performing molecular docking simulations on the crystal structure of human liver  $5\beta$ -reductase. The results confirm that both sterols and fatty acids can play a role in the inhibition of the enzyme, thus, suggesting a competitive mechanism of inhibition. This work proposes a further confirmation for the rational use of herbal products in the management of benign prostatic hyperplasia, and suggests computational methods as an innovative, low cost, and non-invasive process for the study of phytocomplex activity toward proteic targets.

**Subjects** Computational Biology, Pharmacology

**Keywords** *Serenoa repens* (Bartram) Small, Benign prostatic hyperplasia,  $5\alpha$ -reductase, Molecular docking, PyRosetta, AutoDock

## INTRODUCTION

Benign prostatic hyperplasia (BPH) is a non-cancerous growth of the prostatic gland, due to hyper-proliferation of both stromal and glandular prostatic elements (*Shrivastava & Gupta, 2012*).

With increasing life expectancy, BPH incidence is in continuous growth; it has been estimated that the annual cost of managing patients with BPH overcomes \$4 billion

Submitted 29 April 2016  
Accepted 18 October 2016  
Published 22 November 2016

Corresponding author  
Paolo Governa,  
paolo.governa@unisi.it

Academic editor  
Pedro Silva

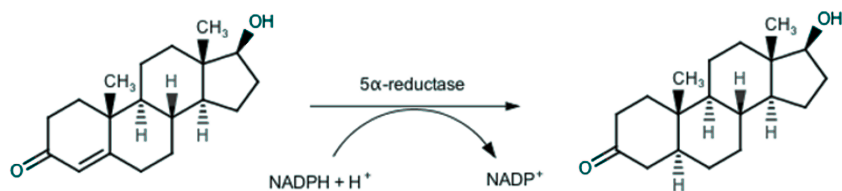
Additional Information and  
Declarations can be found on  
page 16

DOI 10.7717/peerj.2698

© Copyright  
2016 Governa et al.

Distributed under  
Creative Commons CC-BY 4.0

OPEN ACCESS



**Figure 1** Conversion of testosterone into 5 $\alpha$ -dihydrotestosterone by 5 $\alpha$ -reductase.

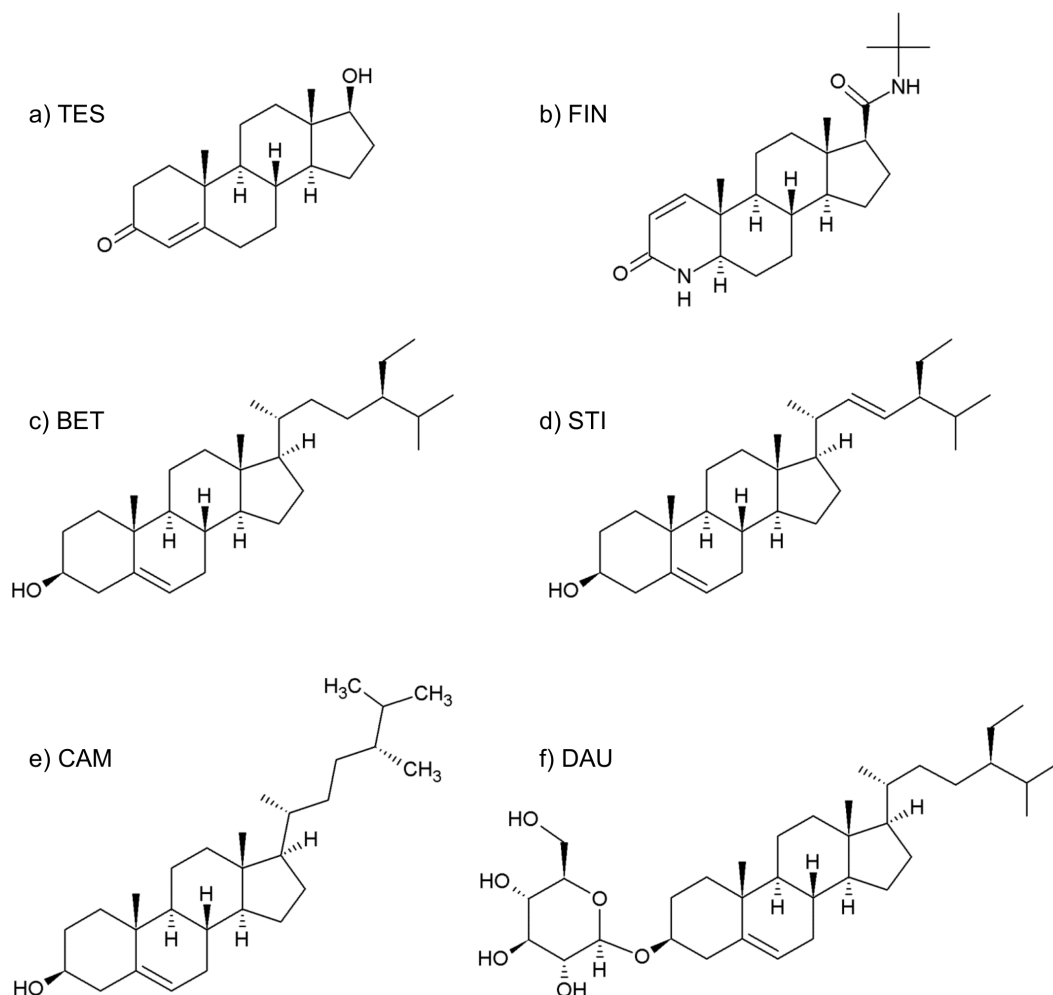
(Shrivastava & Gupta, 2012). Pharmacological interest in BPH is therefore likely to rise in the coming years.

About 60% of male population aged over 50 years shows histological symptoms of BPH, and this grows to 80% over the age of 70 (Aggarwal et al., 2012). BPH is a chronic and progressive disease, with a multifactorial etiology related, among others, to androgenic activity in prostatic tissue (Kumar, Malla & Kumar, 2013). An increase in levels of dihydrotestosterone, the most potent androgen in our organism, is particularly observed in BPH tissue (Carson & Rittmaster, 2003). The main clinical manifestation of BPH affects the lower urinary tract, and can be divided in irritative and obstructive symptoms.

Endogenous androgens, such as testosterone and dihydrotestosterone, play a key-role in growth and development of prostatic tissue, and thus also in prostatic diseases, especially in BPH. In the prostatic gland, testosterone is irreversibly converted through a 5 $\alpha$ -reductase (5AR) catalyzed reaction (Russell & Wilson, 1994), as depicted in Fig. 1, in the more active dihydrotestosterone, which is responsible for BPH (Rittmaster, 2008).

The management of BPH foresees various possibilities, including watchful-waiting, surgery and pharmacological therapies. The pharmacological approach mainly comprises  $\alpha$ -adrenoceptor blockers, such as alfuzosin and tamsulosin (Fine & Ginsberg, 2008), and 5AR inhibitors, such as finasteride (see Fig. 2B) (Nickel et al., 2011).

Alongside other therapeutic approaches, phytotherapeutic agents, such as *Serenoa repens* (Bartram) Small extract (SRE), are also often prescribed for BPH treatment. A large number of papers established the clinical effectiveness of *Serenoa* in controlling lower urinary tract symptoms (LUTS) related to BPH (Champault, Patel & Bonnard, 1984; Carraro et al., 1996). A recent review stated SRE is as effective as conventional therapies in treating BPH related symptoms (Allkanjari & Vitalone, 2015). In clinical trials reported to date, side effects due to treatment with SRE are less frequent and severe than those observed with finasteride, primarily a lower incidence on sexual and gastro-enteric functions (Wilt et al., 1998). In 2012, a systematic review by the Cochrane group stated that no improvement in BPH related symptoms are provided by the use of SRE, compared to placebo (Tacklind et al., 2012). Nevertheless, this review included clinical trials performed by administering different SRE preparations, at different dosages. Bio equivalence of different herbal preparations is an everlasting issue, as the quality of the final product can be influenced by many manufacturing steps, such as the botanical source, the employed part of the plant, extraction process, used solvents and drug extract ratio. In order to reduce the results variability during clinical trials only standardized, chemically reproducible, extracts should be administered.



**Figure 2** Formulas of (A) testosterone, (B) finasteride, (C)  $\beta$ -sitosterol, (D) stigmasterol, (E) campesterol, (F) daucosterol.

SRE mechanism of action remains unclear. Different mechanisms have been proposed, including anti-androgenic actions ([Carilla et al., 1984](#)), inhibition of 5AR ([Bayne et al., 1999](#)), anti-inflammatory ([Breu et al., 1992](#); [Vela-Navarrete et al., 2002](#)), anti-aedematous and anti-oxidant effects ([Tarayre et al., 1983](#)), and antiproliferative influence leading to apoptosis through the inhibition of growth factors ([Paubert-Braquet et al., 1996](#); [Vacherot et al., 2000](#)). Nevertheless, these effects are supported only by *in vitro* enzymatic studies, while the true *in vivo* mechanism has yet to be described ([Geavlete, Multescu & Geavlete, 2011](#)), and it is difficult to state which is the exact role of different active compounds ([Lowe, 2001](#); [Cabeza et al., 2003](#)). It is the scope of this work to shed light on the possible mechanism of action of SRE on 5AR.

Although its full composition remains not completely known, SRE essentially consists of about 90% of free and esterified fatty acids, 6.8% of glycerides, 2.3% of unsaponified

**Table 1** SRE chemical composition.

Compound	%
Oleic acid	32
Lauric acid	29
Myristic acid	11
Palmitic acid	9
Linoleic acid	0.5
Methyl and ethyl esters	2.5
Long-chain esters	1.36
Glycerides	6.8
Unsaponified matter	2.27
$\beta$ -sitosterol and daucosterolo	0.25
Stigmasterol	0.07
Campesterol	0.02

matter of which less than 0.3% consist of phytosterols (*Habib & Wyllie, 2004; Buck, 2004*) (see [Table 1](#)).

Both lipids and phytosterols are known to have significant biological properties and they are used as nutraceuticals and drugs for the prevention and treatment of several important diseases (*Dalen & Devries, 2014; Mooradian & Haas, 2014; Morley, 2014*). However, there is a lack in studies of single SRE component activity in the treatment of BPH, as the therapeutic effect is attributed to the whole phytocomplex.

Enzymatic *in vitro* studies demonstrated the ability of SRE and its components to inhibit 5AR. In 2008, *Scaglione et al.* reported that different compositions of the extract led to differences in 5AR inhibition potency. In a coculture model of epithelial and fibroblast cells, 10  $\mu\text{g/mL}$  SRE showed an effective inhibition of both 5AR isoforms in epithelial cells and a selective inhibition of type II isozyme in fibroblast (*Bayne et al., 1999*).  $\beta$ -sitosterol alone has been shown to inhibit 5AR obtained from hamster prostate tissue with an  $\text{IC}_{50}$  of 2.7  $\mu\text{M}$  (*Cabeza et al., 2003*). *Abe et al. (2009)* performed inhibition studies by using SRE and its components on type I and type II 5AR. As a result, SRE (40–300  $\mu\text{g/mL}$ ) inhibited both the isoforms with an  $\text{IC}_{50}$  of 101  $\mu\text{g/mL}$ . A similar result was found for most of the isolated fatty acid (10–300  $\mu\text{g/mL}$ ), that showed an  $\text{IC}_{50}$  between 42 and 68  $\mu\text{g/mL}$ . In particular, linoleic acid was found to be the most potent inhibitor. However, being oleic acid approximately 6-fold more abundant in SRE, it is expected to be 3–5-fold more active than linoleic acid. In 2002, following a similar experimental protocol, *Raynaud et al.* demonstrated that enzyme inhibition depends on the chain length and saturation state of the fatty acid. Effectively, compounds bearing saturated short chains were active toward both isoforms, while compounds with unsaturated chains were more potent and selective toward type I 5AR (*Raynaud, Cousse & Martin, 2002*). Contrary to *Cabeza et al. (2003)*, they did not find any inhibition activity for SRE phytosterols.

*Niederprüm, Schweikert & Zänker (1994)* observed that linoleic acid is more potent than oleic acid and saturated fatty acids, and stated that 5AR inhibition depends on the chemical structure of fatty acids, with unsaturation being critical for the activity. They



hypothesized that hydrophobic interactions between fatty acids and the enzyme are a mandatory condition for activity, and that unsaturated fatty acids could strongly interact with the enzyme, through the carbon–carbon double bond.

However, the possible mechanism of inhibition attributed to the fatty acids fraction is not well defined. Most of the studies speculate that fatty acids inhibit 5AR by altering the composition of the cell membrane to which the enzyme is functionally related (*Abe et al., 2009*), but there is a lack in knowledge about molecular interaction between SRE compounds and 5AR.

The attempt of this study is to evaluate the possibility that every single component of SRE may have an inhibitory effect on 5AR, by competitive interaction with testosterone for the binding site of the enzyme.

To test this hypothesis, we conducted computational tests, including molecular modeling and docking studies. It has been possible to dock all lipids and sterols of SRE in the active site of 5 $\beta$ -reductase (5BR) crystal, and thus speculate on each binding affinity among 5AR putative active site. In turn, the computed binding affinities allow us to make hypotheses on the overall effect of SRE in the treatment of BPH.

## MATERIALS AND METHODS

X-ray crystal structures of 5AR are not available, and a BLAST search gave no significant sequence similarity. Functional similarities are known with 5BR (*Yao et al., 2011*), the structure of which is well known and present in the PDB database. Furthermore, 5AR and 5BR share the same substrate (testosterone) and inhibitor (finasteride). For this work the crystal structure of 5BR and its complex with NADP<sup>+</sup> and testosterone (PDB: 3BUR (*Di Costanzo et al., 2008*)), and with NADP<sup>+</sup> and finasteride (PDB: 3G1R (*Drury et al., 2009*)) were used. A homology model of 5AR obtained by Min-Rui and Jun-Qian, built using 5AR type 1 sequence as the target sequence and 3BUR as the template, is also available (*Min-Rui & Jun-Qian, 2012*) and was also used.

Chain A from 3BUR (326 aminoacids) was selected, and used as apo-protein through Pymol (PyMOL Molecular Graphics System, Version 1.3r1; Schrödinger, LLC, Portland, OR, USA): all non-catalytic waters and glycerols were removed and hydrogen atoms were added.

The structures of NADP<sup>+</sup>, testosterone and finasteride were saved from the pdb files, whereas the structures of SRE compounds of interest were obtained in two different ways:  $\beta$ -sitosterol, stigmasterol, campesterol and daucosterol were modelled on the basis of testosterone, whereas the structures of oleic, lauric, myristic, palmitic and linoleic acids were modelled from scratch and minimized using Avogadro (*Hanwell et al., 2012*) software. Structures were graphically displayed, modified and evaluated using Pymol (PyMOL Molecular Graphics System, Version 1.3r1; Schrödinger, LLC, Portland, OR, USA) and PyRosetta (*Kaufmann et al., 2010*).

To validate the docking protocol, self-docking of testosterone and finasteride in the relative x-ray structure (3BUR and 3G1R) was performed and RMS was calculated through Pymol. Re-docking of testosterone in 3BUR gave a RMS of 0.103 Å, whereas re-docking of

finasteride in 3G1R gave an RMS of 0.124 Å, thus confirming the validity of the docking protocol.

As phytosterols structures were built by simply adding or removing substituents from testosterone and finasteride structures retrieved from 3BUR and 3G1R pdb files, the coordinates of the steroid nucleus were kept unvaried. Phytosterols were therefore put into the catalytic site manually, using the same coordinate of testosterone and finasteride from the crystal structures, and automatically by docking studies realized with AutoDock 4.2.5.1 and AutoDockTools 1.5.6 (Morris *et al.*, 2010). Fatty acids were docked by means of AutoDock and AutoDockTools.

Complexes obtained from manual and AutoDock docking were submitted to optimization through PyRosetta 1.0.

The flowchart of the calculations is shown in Fig. 3.

To further validate our experimental protocol, a set of decoy ligands was generated using DUD-E (Mysinger *et al.*, 2012). The top six decoy ligands generated by DUD-E were docked in both the productive and the unproductive position and submitted to PyRosetta optimization rounds. The binding energies of the top 6 decoys generated by DUD-E are reported in Table S5.

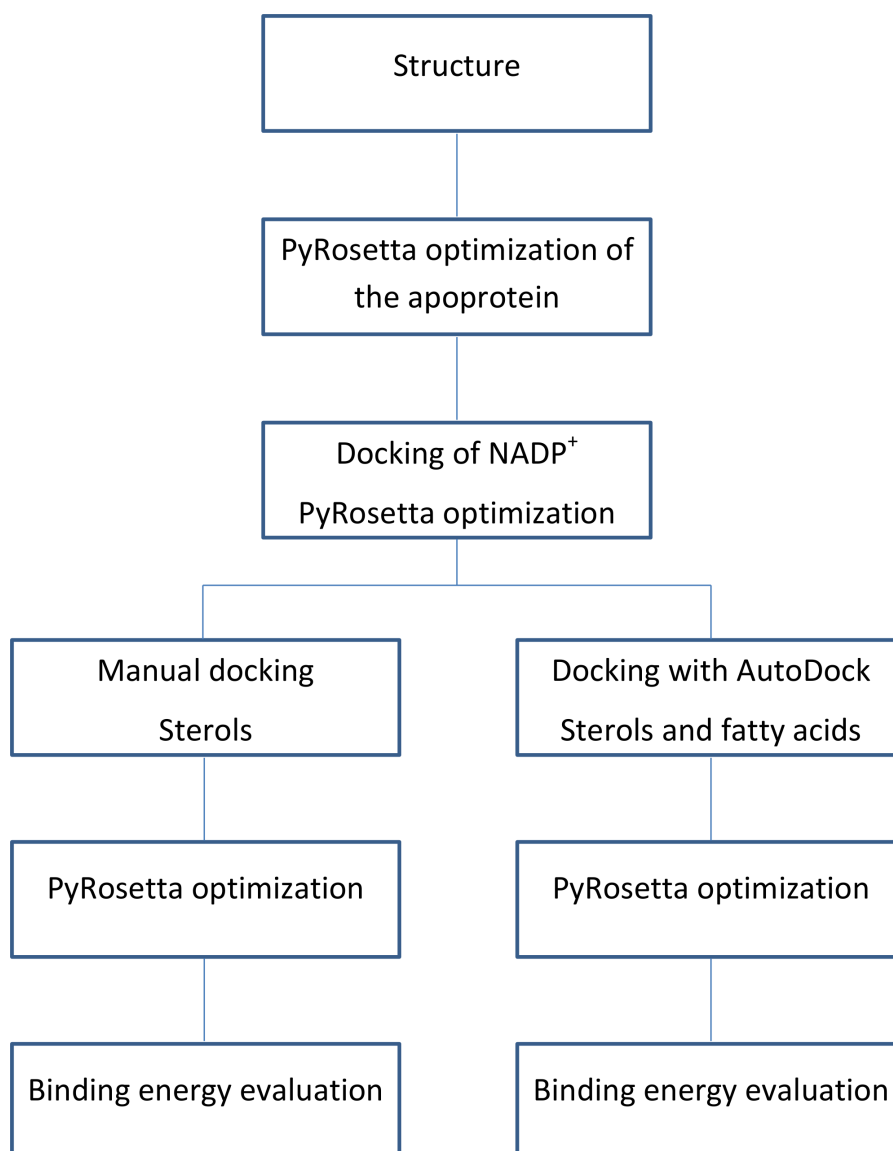
After PyRosetta based energy optimizations, polar and hydrophobic interactions between the ligand and the enzyme were visualized through LigPlot<sup>+</sup> (Laskowski & Swindells, 2011).

All calculations were performed on personal computer and on the sunray cluster available at the department of chemistry, University of Copenhagen.

### PyRosetta algorithm

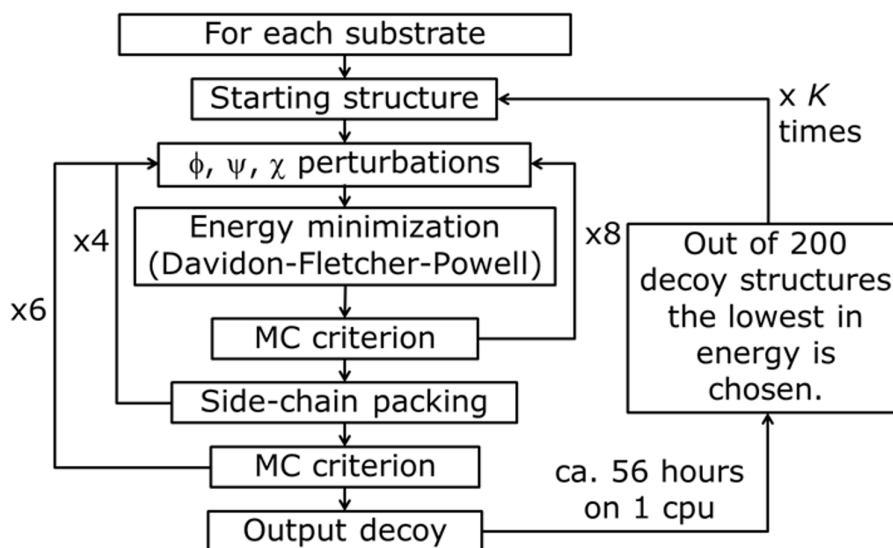
Crystal structures are only available for two of the tested ligands (testosterone and finasteride). In the attempt of making complexes generated after docking simulation, as well as computed binding energies, comparable to each other, we applied computational optimizations through PyRosetta software.

The used algorithm, executed in PyRosetta 1.0 and described in Fig. 4, is based on the flexible peptide docking algorithm used by Chaudhury & Gray (2009), but, with respect to that, there are some differences: a larger number of cycles ( $8 \times 4 \times 6 = 192$  compared to  $8 \times 12 = 96$ ) and more “small” and “shear” moves for the perturbation of both side chain and backbone atoms are performed (Jensen *et al.*, 2014). The side chain conformations are further optimized through a repacking algorithm (Kuhlman & Baker, 2000) and using the extended Dunbrack library (Dunbrack & Cohen, 1997; Wang, Schueler-Furman & Baker, 2005). The moves are applied to all substrates, including NADP<sup>+</sup> and the catalytic water, plus a selected number of residues of the enzyme, with the following criterion: for the first cycle of optimization, all residues within a 4 Å distance from any atom of the NADP<sup>+</sup> and the substrate, including all the residues reported as active by Di Costanzo *et al.* (2008), Di Costanzo *et al.* (2009) and Drury *et al.* (2009); for all the following cycles, only residues inside a 4 Å distance from any atom of the substrate. After the moves, an energy minimization step was executed, based on the Davidon–Fletcher–Powell method (Fletcher & Powell, 1963; Davidon, 1991). Each structure is then accepted or rejected based on a Monte Carlo criterion depending on the standard RosettaDock energy function (Dunbrack

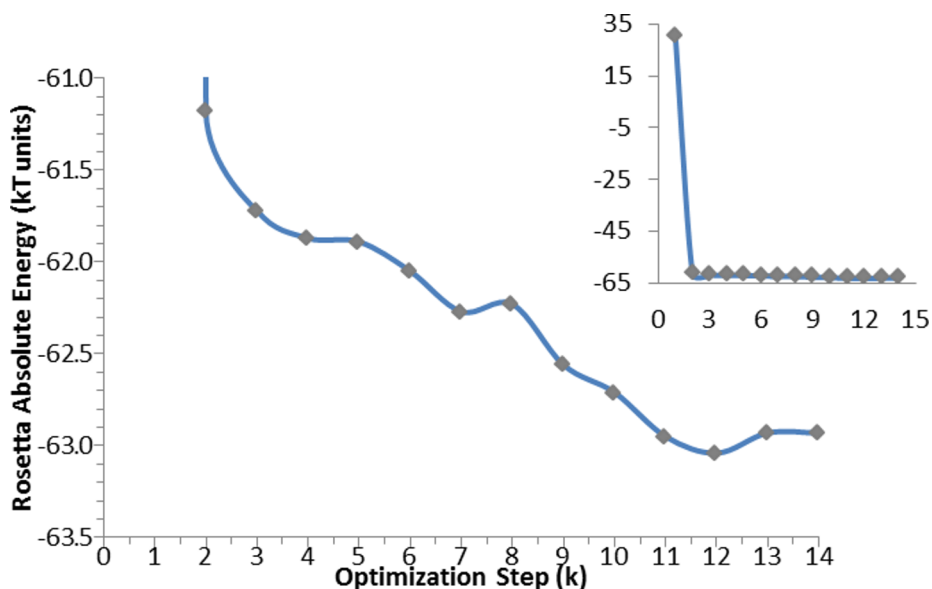


**Figure 3** Calculations process flowchart.

& Cohen, 1997; Lazaridis & Karplus, 1999; Kuhlman & Baker, 2000; Kortemme & Baker, 2002; Gray et al., 2003). Along the optimization a temperature gradient was applied, from an initial value of  $kT = 3.0$  to  $1.0$ . 200 new model of the given protein, defined by Chaudhury and colleagues as “decoy structures” (Chaudhury, Lyskov & Gray, 2010), were generated using each algorithm run. Once the 200 decoy structures were produced, the lowest in energy was chosen and used as a starting structure for another cycle of optimization. This process was repeated  $K$  times until convergence; at the end of the  $K$  cycles the resulting decoy was chosen as the PyRosetta optimized structure. Convergence was defined as when the computed energies of two subsequent cycles were the same.



**Figure 4** PyRosetta based optimization algorithm.  $\phi$ ,  $\psi$ ,  $\chi$  represent perturbation applied to both backbone and side chain dihedral angles. MC criterion stands for Monte Carlo based check of decoy structure.



**Figure 5** Optimization algorithm convergence. Energy convergence steps in the optimization algorithm for the apo-protein. Each point corresponds to the energy of the lowest in energy decoy out of the 200 produced during each of the  $K$  steps. The inset graph shows the total progress of the algorithm, whereas the central graph displays in details the optimization steps.

The same algorithm was used for the optimization of the apo-protein (see Fig. 5), and of the enzyme in complex with: catalytic water; catalytic water +  $\text{NADP}^+$ ; catalytic water +  $\text{NADP}^+$  + substrate. For the substrate alone, only an energy calculation was performed.

### AutoDock calculations

The ligands were used as flexible molecule, and the torsion count together with the number of active torsion was automatically set; the macromolecules used were chain A from 3BUR and chain B from 3GIR, after PyRosetta optimization, containing NADP<sup>+</sup> and the catalytic water.

The map type was defined based on the ligand, and the grid box was centered on the macromolecule and extended to the entire surface. For docking calculations, the genetic algorithm parameters were modified to get the maximum number of evals (25,000,000) and a Lamarckian genetic algorithm was performed. The results of the docking calculation were evaluated in AutoDockTools: the best pose, among the 10 different poses produced by AutoDock for each ligand, was selected on the basis of the graphical analysis of binding mode and interactions with residues in the binding sites.

### Evaluation of binding energies

As it was not possible to use a reasonable number of flexible residues in the enzyme for Autodock calculation, the binding energies obtained were not sufficiently reliable. Therefore, after every docking process, the obtained complexes were optimized through PyRosetta and binding energies were evaluated using PyRosetta computed energies.

The following equation was used to evaluate qualitative binding energies of the different ligands:

$$E_{\text{bind}} = E_{\text{complex}} - (E_{\text{NAP+HOH}} + E_{\text{lig}})$$

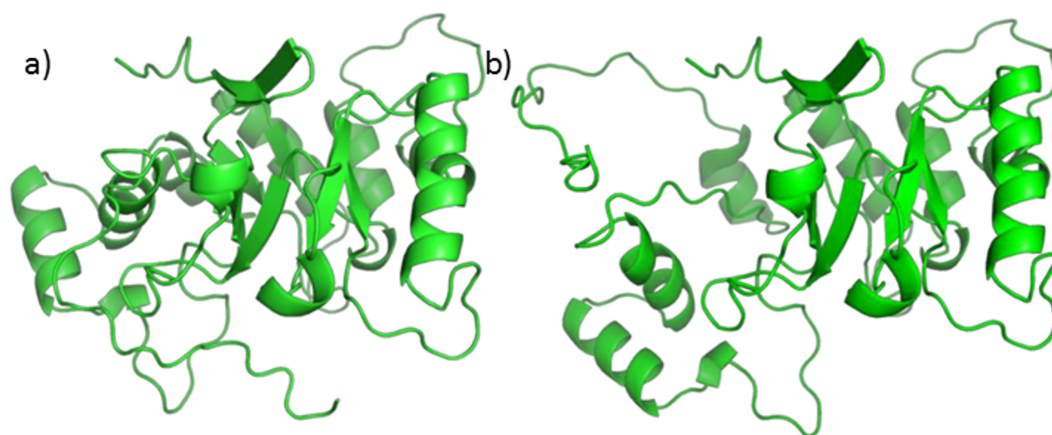
where:  $E_{\text{bind}}$  is the binding energy;  $E_{\text{complex}}$  is the energy of the enzyme in complex with NADP<sup>+</sup>, catalytic water molecule and the ligand;  $E_{\text{NAP+HOH}}$  is the energy of the enzyme in complex with NADP<sup>+</sup> and the catalytic water molecule and  $E_{\text{lig}}$  stands for the energy of the ligand alone.

In computing and comparing these qualitative binding energies, we assume that every substrate has the same probability to reach the enzyme active site, and that overall entropic effects are nearly the same for every considered target molecule.

## RESULTS AND DISCUSSION

An *in silico* structure-based approach has been applied in the attempt to dissect SRE activity toward 5AR and to identify single components able to bind to the enzyme. In particular, phytosterols, which are structurally similar to testosterone, and fatty acids, representing the major components of SRE, have been docked into the enzyme active site to check for their putative ability to block 5AR activity. However, due to the lack of any three-dimensional structure of this enzyme, only two strategies were applicable: to use homology modeling structures of 5AR or the available three-dimensional structure of a functionally similar protein.

A homology model, using 5AR type 1 sequence as target and 5BR crystal as the template already exists (*Min-Rui & Jun-Qian, 2012*), but its refinement does not seem to be trustworthy. Attempts to optimize the model alone, the binary complex with NADP<sup>+</sup>, or



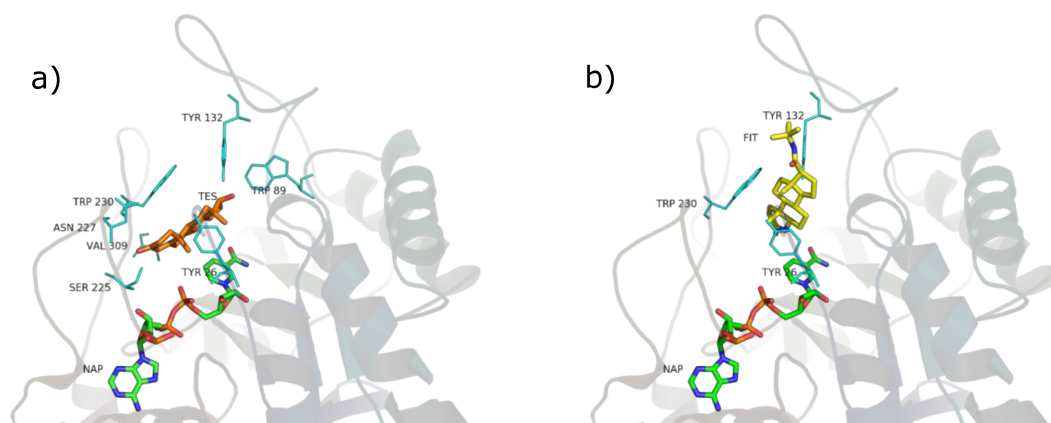
**Figure 6** 5AR model before (A) and after (B) optimization. The loss of structural features is evident.

the ternary complex with  $\text{NADP}^+$  and one of testosterone, finasteride or SRE components through PyRosetta gave no reliable results. The structure of the model changed significantly upon optimization, and the protein secondary elements (such as alpha helices and beta sheets) suffered from structural limitations (see Fig. 6).

Moreover, the total energies were extremely high, reaching more than 4,000 kcal/mol. For these reasons our protocol was not applicable to the homology model and we decided to use a similar protein for this work. Nevertheless, we tried to perform Autodock calculations for  $\text{NADP}^+$  on the 5AR homology model; the obtained complex was then used to dock testosterone, finasteride and each of the SRE compounds of interest. Despite the doubts generated by the quality of the homology model, it is interesting that both sterols and fatty acids assumed similar positions and that AutoDock energies evaluation shows comparable affinity for every ligands Table S1.

5BR is, as 5AR, a member of the oxidoreductase family, using alkanes as electron donors and  $\text{NADP}^+$  as the acceptors (Enzyme Commission code: EC. 1.3.1). Although there is poor protein sequence similarity (approximately 10%), both 5AR and 5BR are  $\text{NADP(H)}$ -dependent and share a conserved nicotinamide-cofactor-binding pocket (Jez *et al.*, 1997), same substrate (testosterone) and same inhibitor (finasteride), thus suggesting some similarities in their substrate binding domains (Langlois *et al.*, 2010) and function (Min-Rui & Jun-Qian, 2012). Furthermore, the sequence alignment shows that 5BR binding site residues W89 and W230 are identical in both 5AR type 1 and type 2 and that the active residue Y58 is also conservatively substituted by a phenylalanine in the type 1 isozyme.

Analysis of the available crystal structures of 5BR and its ligands showed that testosterone and finasteride can assume two different orientations: one is judged as productive (capable of carrying out the double bond reduction), perpendicular with respect to  $\text{NADPH}$ , and the other as unproductive (unable of carrying out the double bond reduction), parallel to  $\text{NADPH}$ . Both positions are shown in Fig. 7. Finasteride has been crystalized in the productive position (Drury *et al.*, 2009) whereas it was not possible to obtain the crystal structure of the productive position assumed by testosterone Di Costanzo *et al.* (2008) assumed that testosterone could occupy more than one position and that at the high steroid concentration



**Figure 7** Testosterone in the unproductive position (A) and finasteride in the productive position (B).

**Table 2** Testosterone, finasteride, SRE phytosterols and SRE fatty acids binding energies (kcal/mol) obtained with PyRosetta, using 5BR as a target protein.

Substrates	Unproductive position	Productive position
Testosterone	-7	-11
Finasteride	-6	-27
$\beta$ -sitosterol	-2	-28
Stigmasterol	0.1	-29
Campesterol	0.5	-8
Daucosterol	-34	-30
Oleic acid	-12	-34
Lauric acid	-3	Not binding
Myristic acid	-8	-20
Palmitic acid	-12	-13
Linoleic acid	-7	-28

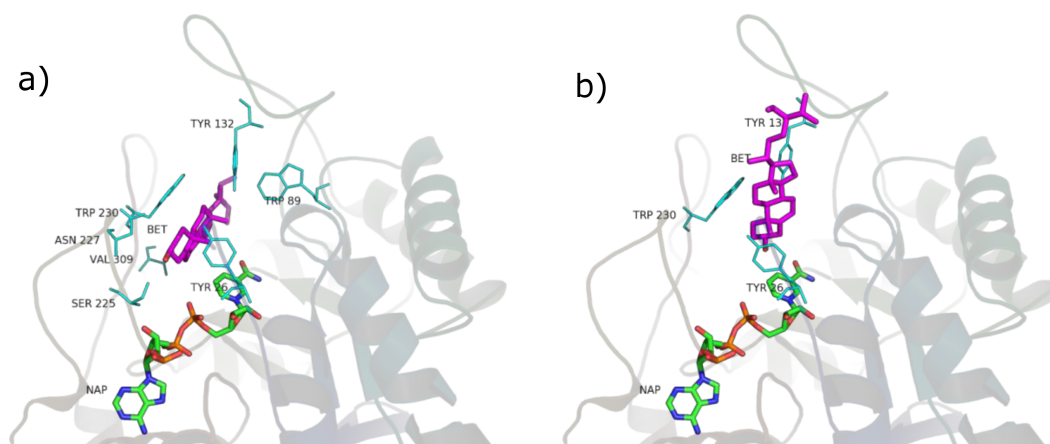
used in the crystallization trials, the unproductive binding mode is favored. In our opinion, this fact has at least two consequences: (i) when binding in the productive position, testosterone quickly reacts and is subsequently released, making it very difficult to obtain a crystal structure of an active enzyme; (ii) we suppose that the unproductive position could work as a regulatory element of the enzyme activity. If testosterone could not bind also to this position the enzyme could possibly be misregulated.

### Protocol validation

Testosterone and finasteride were docked in both productive and unproductive positions and the binding energies were computed through the PyRosetta scoring function (Table 2).

According to PyRosetta-computed binding energies, testosterone and finasteride have the same affinity for the unproductive position, whereas finasteride is a better candidate for binding the productive position, thus confirming the effectiveness of finasteride as a 5AR-inhibitor already known from clinical experience.





**Figure 8**  $\beta$ -sitosterol in the unproductive (A) and productive (B) position.

PyRosetta effectiveness in predicting the correct binding energies was validated by docking 6 automatically generated ligands in the productive and unproductive positions. PyRosetta algorithm efficiently addressed the DUD-E generated inactive ligands, for which it computed worse binding energies [Table S5](#) than those of testosterone, finasteride and SRE components.

### Phytosterols

SRE phytosterols' ([Table 1](#)) structures are very similar to that of the endogenous substrate of the enzyme (see [Fig. 2](#)), so it has been possible to perform manual and AutoDock docking simulations. As expected,  $\beta$ -sitosterol, stigmasterol and campesterol bind the active site of 5BR in the two possible orientations ([Fig. 8](#) and [Fig. S1](#)).

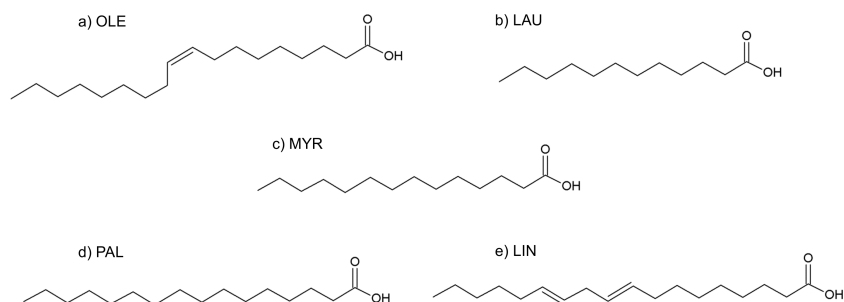
PyRosetta-computed binding energies after AutoDock docking resulted higher, although comparable, than those calculated after manual docking [Table S4](#); for this reason, in this work SRE phytosterols–5BR complexes resulting from manual docking were chosen, when comparing with other complexes.

Considering PyRosetta binding energies ([Table 2](#)),  $\beta$ -sitosterol, stigmasterol and daucosterol resulted to be the best candidates to compete with testosterone for the active site of the enzyme, giving a binding energy comparable to that of finasteride. Campesterol is comparable to testosterone.

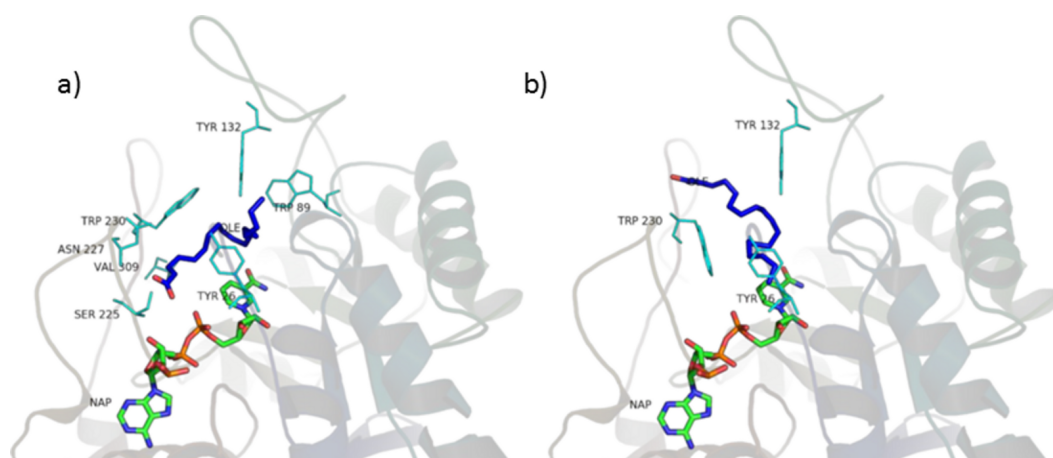
### Fatty acids

The fatty acids contained in SRE (see [Table 1](#) and [Fig. 9](#)) were docked in the active site of the enzyme by means of AutoDock: although completely different in chemistry and structure, they were found to be able to dock in both productive and unproductive positions ([Fig. 10](#) and [Fig. S2](#)) and most of the interactions (see later) were conserved, thus suggesting a possible competitive mechanism of inhibition.

According to PyRosetta binding energies (reported in [Table 2](#)), oleic and linoleic acid seem to be the best competitor (comparable to finasteride), whereas myristic and palmitic



**Figure 9** Formulas of (A) oleic acid, (B) lauric acid, (C) myristic acid, (D) palmitic acid, (E) linoleic acid.



**Figure 10** Oleic acid in the unproductive (A) and productive (B) position.

are similar to testosterone. Lauric seems to be useless, as it cannot bind the productive position.

### Residues interactions

The main interactions of the obtained complexes, resulted from LigPlot+ evaluations, are shown in [Tables S3](#) and [S4](#). In the unproductive position, interactions with Y26, W89, Y132, S225, N227, W230, V309 are shared by almost every ligand. In the productive position, interactions with Y26, Y132 and W230 are shared by every ligand binding in this position.

Considering these results, it could be said that interactions with Y26, Y132 and W230, which are cavity residues, are important for ligand binding to the active site and this has to be taken into consideration when studying a pharmacophore model for the inhibition of this enzyme. Furthermore, W230 is a conserved residue in both the isozymes of 5AR (see sequence alignment in [Figs. S3](#) and [S4](#)), suggesting an important role for the binding of ligands to the active site of 5AR too.

Although the tested ligands are mainly hydrophobic, some of them have polar and hydrophilic substituents in their structures. This fact seems to be important for the correct alignment in the binding pocket and for the binding energy scoring. In particular, in the

unproductive position, testosterone and finasteride established a hydrogen bond between the oxygen atom in 3 and residue S255. This kind of polar interaction is conserved by the non-glycosylated phytosterols ( $\beta$ -sitosterol, stigmasterol, campesterol). The carboxyl group present in the tested fatty acids also established hydrogen bond with S225. Furthermore, lauric, linoleic and myristic acid made polar interactions with R226, and oleic, lauric and linoleic acid with N227. Palmitic acid made no hydrophilic interactions.

In the productive position, instead, testosterone and finasteride made no polar contacts with residues in the active site, and this is shared by the tested phytosterols. Oleic and linoleic acid, on the contrary, established hydrogen bonds between the carboxyl group and residues E310 and L311. This could be an explanation for their better binding energies with respect to the other ligands.

### Bioavailability

The recommended dosage of *Serenoa repens* extract is 320–640 mg/day; phytosterols concentration reaching the prostate after oral treatment at therapeutic dosage of SRE is expected to be comparable to that of finasteride ([Duchateau et al., 2012](#); [Merck & Co., 2013](#)).

Little information is available in literature about dietary fatty acids distribution in prostate; nevertheless, they are expected to reach the prostate in high concentration, on the basis of some studies carried on SRE and similar extracts pharmacokinetics ([De Bernardi di Valserra, Tripodi & Contos, 1994](#); [Bernard, Cousse & Chevalier, 1997](#); [Yohani, Men & Rosa, 2006](#)).

In this work, daucosterol was included in the set of substrates for docking calculation, even if it is a glucoside, hence it cannot reach the prostate as such but as  $\alpha$ - and  $\beta$ -sitosterol. Daucosterol binding position differs from that assumed by the non-glucoside phytosterols, due to the presence of the glucose portion. Nevertheless, its binding energy resulted to be comparable to that of finasteride,  $\beta$ -sitosterol and stigmasterol, suggesting that it could be used as a 5AR inhibitor by means of currently known nanodevices specific drug-delivery systems.

Making the hypothesis that 5AR and 5BR share mechanisms of regulation as they share many features of the binding pocket and function, given the expected concentration of SRE phytosterols reaching the prostate after oral delivery ([Duchateau et al., 2012](#); [Merck & Co., 2013](#)), and the computed qualitative binding energies reported in [Table 2](#), we can reasonably assume that SRE phytosterols have a similar inhibition action on 5AR to that of finasteride. Published experimental tests to confirm this hypothesis are controversial: [Cabeza et al. \(2003\)](#) observed the inhibitory effect of  $\beta$ -sitosterol alone on 5AR, and this is in agreement with our findings. Nevertheless, Raynaud and colleagues observed no inhibitory effect for the unsaponified matter (i.e., containing phytosterols) of SRE ([Raynaud, Cousse & Martin, 2002](#)).

On the basis of our computational results, long chain and unsaturated fatty acids, like oleic and linoleic acid, are the best candidates from SRE to act as competitive inhibitors of 5AR with respect to saturated and short/middle chain fatty acids. These results are in agreement with those reported by previously conducted *in vitro* experiments ([Niederprüm, Schweikert & Zänker, 1994](#); [Raynaud, Cousse & Martin, 2002](#); [Abe et al., 2009](#)).

However, fatty acids are a very common food intake and testosterone is expected to compete with them regularly, being the amount of fatty acids taken up by diet much greater than that taken by therapeutic dosage of SRE.

SRE may be clinically effective because of the free form of the fatty acids. Food intake is predominantly composed of esterified fatty acids: free fatty acids may be assimilated by the digestive system in a higher concentration (Niederprüm, Schweikert & Zänker, 1994). This hypothesis is confirmed by the fact that another phytotherapeutic treatment used in the tradition of many countries to relieve LUTS is the oil obtained from *Cucurbita pepo* L. seeds (Allkanjari & Vitalone, 2015; European Medicines Agency, 2010), which contains a high amount of free fatty acids (Badr, Shaaban & Elkholy, 2011).

However, the reason behind lower incidence of secondary effects from SRE than from finasteride treatment remain to be understood, as they are possibly related to further mechanisms of action of SRE.

## CONCLUSIONS

*Serenoa repens* has been used to treat the symptoms related to BPH for long time, thanks to its large set of mechanisms of action and to its handed down information on effectiveness.

Within the variety of mechanisms of action, the inhibition of 5AR seems to have an important role and has been demonstrated by many studies; nevertheless, a competitive mechanism of inhibition has never been speculated, as to SRE only an action toward cell membrane to which 5AR is functionally related has been attributed.

In this work, an *in silico* approach has been applied to study the 5AR molecular mechanism of inhibition induced by SRE in depth. The tridimensional structure of 5AR has not been described to date, but many of the binding site features are conserved in the available 5BR; until a better-refined structure of 5AR will be available, 5BR is the most reliable asset to use for these kind of studies.

SRE phytosterols and free fatty acids have been demonstrated to be good inhibitors for 5AR in enzymatic tests (Niederprüm, Schweikert & Zänker, 1994; Raynaud, Cousse & Martin, 2002; Cabeza et al., 2003; Abe et al., 2009) and are supposed to have a good prostatic bioavailability: this work proposes a competitive mechanism of inhibition, considering their affinity for the active site of 5BR.

Computed qualitative binding energies of testosterone, finasteride and SRE components show that: (i) the phytosterols part can act as inhibitor just like finasteride (Table 2), also considering the expected concentrations in the prostate tissues; (ii) the fatty acid fraction can also act as inhibitor (Table 2), as previously demonstrated by the *in vitro* experiments. How they can arrive to the prostate and what differentiates them from fatty acids in food intake is still to be examined.

Future development of a better-refined structure of 5AR is an exciting prospect for better understanding molecular mechanism of action of synthetic 5AR inhibitors and phytotherapeutics like SRE, and would allow repeating this study comparing differences and similarities with 5BR.

Several pharmacophoric models for 5AR inhibitors have been already reported in the literature. In particular, Chen et al. (2001) described a hypothetical pharmacophore for

5AR inhibitor constituted by two hydrogen bond acceptors (HBA) and three hydrophobic features. In 2003, *Faragalla et al.* developed several pharmacophores for human and rat type I and type II 5AR, and compared them to those obtained earlier by Chen. In detail, they described two different hypotheses for human type II 5AR inhibitors: hIIA consisted of one HBA, a negative ionizable group and two ring aromatic features, and was the most similar to that obtained from Chen; hIIB was however considered more reliable by the authors and consisted of one HBA, one hydrophobic and two ring aromatic features.

An analysis of our results showed that the hydrophobic features are maintained by the steroid core of phytosterols and by the long aliphatic chain of fatty acids. One of the HBA reported by Chen corresponds to the substituent in position 3 of the steroid structure. Moreover, each of the steroid ligands (testosterone, finasteride and phytosterols), docked in the unproductive position, made a hydrogen bond involving its substituent in position 3 and the portion of the binding site comprising S225, R226 and N227. This hydrogen bond is also conserved by the carboxyl group of the tested fatty acids, apart from palmitic acid.

In addition, two recent 3D-QSAR studies indicated that C17 substituents are responsible for the hydrophobic interactions of steroid inhibitors with the active site of 5AR, thus suggesting that bulky hydrophobic substituent at C17 are necessary for inhibitory activity (*Kumar et al., 2013; Thareja, Rajpoot & Verma, 2015*). In agreement with these findings, our results confirmed that many hydrophobic interactions are established between phytosterols C17 substituent and 5BR active site, both in the unproductive and productive positions. Long chain fatty acids, such as oleic and linoleic acid, share similar hydrophobic interactions, and this could explain their better *in vitro* inhibitory activity and calculated binding energies. More studies are required to confirm and further investigate the results here presented; comparisons between the effects of free and esterified fatty acids would be particularly useful to explain the difference in the effectiveness of SRE with respect to common food intake. Also, as one limit of this study is due to the lack of consideration of entropic effects, we hope that more rigorous calculations of free binding energies will be conducted in the future. Nevertheless, the described method will be useful to test the mechanism of action of other phytotherapeutic treatments traditionally used in the management of BPH, such as *Prunus africana* (Hook. f.) Kalkman, *Urtica dioica* L., *Cucurbita pepo* L. and many others.

Furthermore, other aspects to be investigated about SRE mechanism of action (e.g., Aromatase inhibition) will benefit from *in silico* studies.

## ADDITIONAL INFORMATION AND DECLARATIONS

### Funding

The authors received no funding for this work.

### Competing Interests

The authors declare there are no competing interests.

## Author Contributions

- Paolo Governa performed the experiments, analyzed the data, wrote the paper, prepared figures and/or tables.
- Daniela Giachetti contributed reagents/materials/analysis tools, reviewed drafts of the paper.
- Marco Biagi conceived and designed the experiments, reviewed drafts of the paper.
- Fabrizio Manetti analyzed the data, reviewed drafts of the paper.
- Luca De Vico conceived and designed the experiments, analyzed the data, wrote the paper, reviewed drafts of the paper.

## Data Availability

The following information was supplied regarding data availability:

The research in this article did not generate any raw data.

## Supplemental Information

Supplemental information for this article can be found online at <http://dx.doi.org/10.7717/peerj.2698#supplemental-information>.

## REFERENCES

- Abe M, Ito Y, Oyunzul L, Oki-Fujino T, Yamada S. 2009.** Pharmacologically relevant receptor binding characteristics and 5 $\alpha$ -reductase inhibitory activity of free fatty acids contained in saw palmetto extract. *Biological & Pharmaceutical Bulletin* 32:646–650 DOI 10.1248/bpb.32.646.
- Aggarwal S, Thareja S, Bhardwaj TR, Haupenthal J, Hartmann RW, Kumar M. 2012.** Synthesis and biological evaluation of novel unsaturated carboxysteroids as human 5 $\alpha$ -reductase inhibitors: a legitimate approach. *European Journal of Medicinal Chemistry* 54:728–739 DOI 10.1016/j.ejmech.2012.06.026.
- Allkanjari O, Vitalone A. 2015.** What do we know about phytotherapy of benign prostatic hyperplasia? *Life Sciences* 126:42–56 DOI 10.1016/j.lfs.2015.01.023.
- Badr SEA, Shaaban M, Elkholy YM. 2011.** Chemical composition and biological activity of ripe pumpkin fruits (*Cucurbita pepo* L.) cultivated in Egyptian habitats. *Natural Product Research* 25:1524–1539 DOI 10.1080/14786410903312991.
- Bayne CW, Donnelly F, Ross M, Habib FK. 1999.** *Serenoa repens* (Permixon): a 5 $\alpha$ -reductase types I and II inhibitor-new evidence in a coculture model of BPH. *The Prostate* 40:232–241 DOI 10.1002/(SICI)1097-0045(19990901)40:4<232::AID-PROS4>3.0.CO;2-0.
- Bernard P, Cousse H, Chevalier G. 1997.** Distribution of radioactivity in rats after oral administration of lipidosterolic extract of *Serenoa repens* (Permixon<sup>®</sup>) supplemented with [1-<sup>14</sup>C]-lauric acid, [1-<sup>14</sup>C] oleic acid or [4-<sup>14</sup>C] beta-sitosterol. *European Journal of Drug Metabolism and Pharmacokinetics* 22:73–83 DOI 10.1007/BF03189787.
- Breu W, Hagenlocher M, Redl K, Tittel G, Stadler F, Wagner H. 1992.** Anti-inflammatory activity of sabal fruit extracts prepared with supercritical carbon



- dioxide. *In vitro* antagonists of cyclooxygenase and 5-lipoxygenase metabolism. *Arzneimittel-forschung* **42**:547–551.
- Buck AC. 2004.** Is there a scientific basis for the therapeutic effects of *serenoa repens* in benign prostatic hyperplasia? Mechanisms of action. *The Journal of Urology* **172**:1792–1799 DOI [10.1097/01.ju.0000140503.11467.8e](https://doi.org/10.1097/01.ju.0000140503.11467.8e).
- Cabeza M, Bratoeff E, Heuze I, Ramírez E, Sánchez M, Flores E. 2003.** Effect of  $\beta$ -sitosterol as Inhibitor of  $5\alpha$ -reductase in Hamster Prostate. *Proceedings of the Western Pharmacology Society* **155**:153–155.
- Carilla E, Briley M, Fauran F, Sultan C, Duvilliers C. 1984.** Binding of Permixon, a new treatment for prostatic benign hyperplasia, to the cytosolic androgen receptor in the rat prostate. *Journal of Steroid Biochemistry* **20**:521–523 DOI [10.1016/0022-4731\(84\)90265-6](https://doi.org/10.1016/0022-4731(84)90265-6).
- Carraro JC, Raynaud JP, Koch G, Chisholm GD, Di Silverio F, Teillac P, Da Silva FC, Cauquil J, Chopin DK, Hamdy FC, Hanus M, Hauri D, Kalinteris A, Marencak J, Perier A, Perrin P. 1996.** Comparison of phytotherapy (Permixon) with finasteride in the treatment of benign prostate hyperplasia: a randomized international study of 1,098 patients. *The Prostate* **29**:231–240 DOI [10.1002/\(SICI\)1097-0045\(199610\)29:4<231::AID-PROS4>3.0.CO;2-E](https://doi.org/10.1002/(SICI)1097-0045(199610)29:4<231::AID-PROS4>3.0.CO;2-E).
- Carson C, Rittmaster R. 2003.** The role of dihydrotestosterone in benign prostatic hyperplasia. *Urology* **61**:2–7 DOI [10.1016/S0090-4295\(03\)00045-1](https://doi.org/10.1016/S0090-4295(03)00045-1).
- Champault G, Patel JC, Bonnard AM. 1984.** A double-blind trial of an extract of the plant *Serenoa repens* in benign prostatic hyperplasia. *British Journal of Clinical Pharmacology* **18**:461–462 DOI [10.1111/j.1365-2125.1984.tb02491.x](https://doi.org/10.1111/j.1365-2125.1984.tb02491.x).
- Chaudhury S, Gray JJ. 2009.** Identification of structural mechanisms of HIV-1 protease specificity using computational peptide docking: implications for drug resistance. *Structure* **17**:1636–1648 DOI [10.1016/j.str.2009.10.008](https://doi.org/10.1016/j.str.2009.10.008).
- Chaudhury S, Lyskov S, Gray JJ. 2010.** PyRosetta: a script-based interface for implementing molecular modeling algorithms using Rosetta. *Bioinformatics* **26**:689–691 DOI [10.1093/bioinformatics/btq007](https://doi.org/10.1093/bioinformatics/btq007).
- Chen GS, Chang C, Kan WM, Chang C, Wang KC, Chern J. 2001.** Novel lead generation through hypothetical pharmacophore three-dimensional database searching: discovery of isoflavonoids as nonsteroidal inhibitors of rat  $5\alpha$ -reductase. *Journal of Medicinal Chemistry* **44**:3759–3763 DOI [10.1021/jm010433s](https://doi.org/10.1021/jm010433s).
- Dalen JE, Devries S. 2014.** Diets to prevent coronary heart disease 1957–2013: what have we learned? *The American Journal of Medicine* **127**:364–369.
- Davidon W. 1991.** Variable metric method for minimization. *SIAM Journal on Optimization* **1**:1–17 DOI [10.1137/0801001](https://doi.org/10.1137/0801001).
- De Bernardi di Valserra M, Tripodi A, Contos S. 1994.** *Serenoa repens* capsules: a bioequivalence study. *Acta Toxicologia Therapeutica* **15**:21–39.
- Di Costanzo L, Drury JE, Christianson DW, Penning TM. 2009.** Structure and catalytic mechanism of human steroid  $5\beta$ -reductase (AKR1D1). *Molecular and Cellular Endocrinology* **301**:191–198 DOI [10.1016/j.mce.2008.09.013](https://doi.org/10.1016/j.mce.2008.09.013).



- Di Costanzo L, Drury JE, Penning TM, Christianson DW. 2008.** Crystal structure of human liver Delta4-3-ketosteroid 5 $\beta$ -reductase (AKR1D1) and implications for substrate binding and catalysis. *The Journal of Biological Chemistry* **283**:16830–16839 DOI [10.1074/jbc.M801778200](https://doi.org/10.1074/jbc.M801778200).
- Drury JE, Di Costanzo L, Penning TM, Christianson DW. 2009.** Inhibition of human steroid 5 $\beta$ -reductase (AKR1D1) by finasteride and structure of the enzyme-inhibitor complex. *The Journal of Biological Chemistry* **284**:19786–19790 DOI [10.1074/jbc.C109.016931](https://doi.org/10.1074/jbc.C109.016931).
- Duchateau G, Cochrane B, Windebank S, Herudzinska J, Sanghera D, Burian A, Mu M, Zeitlinger M, Lappin G. 2012.** Absolute oral bioavailability and metabolic turnover of  $\beta$ -sitosterol in healthy subjects. *Drug Metabolism and Disposition* **40**:2026–2030 DOI [10.1124/dmd.112.046623](https://doi.org/10.1124/dmd.112.046623).
- Dunbrack RL, Cohen FE. 1997.** Bayesian statistical analysis of protein side-chain rotamer preferences. *Protein Science* **6**:1661–1681 DOI [10.1002/pro.5560060807](https://doi.org/10.1002/pro.5560060807).
- European Medicines Agency. 2010.** EMA Assessment report on *Cucurbita pepo* L., semen. Available at [http://www.ema.europa.eu/docs/en\\_GB/document\\_library/Herbal\\_-\\_HMPC\\_assessment\\_report/2013/03/WC500140759.pdf](http://www.ema.europa.eu/docs/en_GB/document_library/Herbal_-_HMPC_assessment_report/2013/03/WC500140759.pdf).
- Faragalla J, Bremner J, Brown D, Griffith R, Heaton A. 2003.** Comparative pharmacophore development for inhibitors of human and rat 5 $\alpha$ -reductase. *Journal of Molecular Graphics and Modeling* **22**:83–92 DOI [10.1016/S1093-3263\(03\)00138-4](https://doi.org/10.1016/S1093-3263(03)00138-4).
- Fine SR, Ginsberg P. 2008.** Alpha-adrenergic receptor antagonists in older patients with benign prostatic hyperplasia: issues and potential complications. *The Journal of the American Osteopathic Association* **108**:333–337.
- Fletcher R, Powell MJD. 1963.** A rapidly convergent descent method for minimization. *The Computer Journal* **6**:163–168 DOI [10.1093/comjnl/6.2.163](https://doi.org/10.1093/comjnl/6.2.163).
- Geavlete P, Multescu R, Geavlete B. 2011.** *Serenoa repens* extract in the treatment of benign prostatic hyperplasia. *Therapeutic Advances in Urology* **3**:193–198 DOI [10.1177/1756287211418725](https://doi.org/10.1177/1756287211418725).
- Gray JJ, Moughon S, Wang C, Schueler-Furman O, Kuhlman B, Rohl CA, Baker D. 2003.** Protein–protein docking with simultaneous optimization of rigid-body displacement and side-chain conformations. *Journal of Molecular Biology* **331**:281–299 DOI [10.1016/S0022-2836\(03\)00670-3](https://doi.org/10.1016/S0022-2836(03)00670-3).
- Habib FK, Wyllie MG. 2004.** Not all brands are created equal: a comparison of selected components of different brands of *Serenoa repens* extract. *Prostate Cancer and Prostatic Diseases* **7**:195–200 DOI [10.1038/sj.pcan.4500746](https://doi.org/10.1038/sj.pcan.4500746).
- Hanwell MD, Curtis DE, Lonie DC, Vandermeersch T, Zurek E, Hutchison GR. 2012.** Avogadro: an advanced semantic chemical editor, visualization, and analysis platform. *Journal of Cheminformatics* **4**:Article 17 DOI [10.1186/1758-2946-4-17](https://doi.org/10.1186/1758-2946-4-17).
- Jensen JH, Willemoës M, Winther JR, De Vico L. 2014.** *In silico* prediction of mutant HIV-1 proteases cleaving a target sequence. *PLoS ONE* **9**:e95833 DOI [10.1371/journal.pone.0095833](https://doi.org/10.1371/journal.pone.0095833).

- Jez JM, Bennett MJ, Schlegel BP, Lewis M, Penning TM. 1997.** Comparative anatomy of the aldo-keto reductase superfamily. *The Biochemical Journal* **326**(Pt 3):625–636 DOI [10.1042/bj3260625](https://doi.org/10.1042/bj3260625).
- Kaufmann KW, Lemmon GH, Deluca SL, Sheehan JH, Meiler J. 2010.** Practically useful: what the Rosetta protein modeling suite can do for you. *Biochemistry* **49**:2987–2998 DOI [10.1021/bi902153g](https://doi.org/10.1021/bi902153g).
- Kortemme T, Baker D. 2002.** A simple physical model for binding energy hot spots in protein–protein complexes. *Proceedings of the National Academy of Sciences of the United States of America* **99**:14116–14121 DOI [10.1073/pnas.202485799](https://doi.org/10.1073/pnas.202485799).
- Kuhlman B, Baker D. 2000.** Native protein sequences are close to optimal for their structures. *Proceedings of the National Academy of Sciences of the United States of America* **97**:10383–10388 DOI [10.1073/pnas.97.19.10383](https://doi.org/10.1073/pnas.97.19.10383).
- Kumar R, Malla P, Kumar M. 2013.** Advances in the design and discovery of drugs for the treatment of prostatic hyperplasia. *Expert Opinion on Drug Discovery* **8**:1013–1027 DOI [10.1517/17460441.2013.797960](https://doi.org/10.1517/17460441.2013.797960).
- Kumar R, Malla P, Verma A, Kumar M. 2013.** Design of potent human steroid 5 $\alpha$ -reductase inhibitors: 3D-QSAR CoMFA, CoMSIA and docking studies. *Medicinal Chemistry Research* **22**:4568–4580 DOI [10.1007/s00044-012-0456-5](https://doi.org/10.1007/s00044-012-0456-5).
- Langlois VS, Zhang D, Cooke GM, Trudeau VL. 2010.** Evolution of steroid-5 $\alpha$ -reductases and comparison of their function with 5 $\beta$ -reductase. *General and Comparative Endocrinology* **166**:489–497 DOI [10.1016/j.ygcen.2009.08.004](https://doi.org/10.1016/j.ygcen.2009.08.004).
- Laskowski RA, Swindells MB. 2011.** LigPlot+: multiple ligand to protein interaction diagrams for drug discovery. *Journal of Chemical Information and Modeling* **51**:2778–2786 DOI [10.1021/ci200227u](https://doi.org/10.1021/ci200227u).
- Lazaridis T, Karplus M. 1999.** Effective energy function for proteins in solution. *Proteins* **35**:133–152 DOI [10.1002/\(SICI\)1097-0134\(19990501\)35:2<133::AID-PROT1>3.0.CO;2-N](https://doi.org/10.1002/(SICI)1097-0134(19990501)35:2<133::AID-PROT1>3.0.CO;2-N).
- Lowe FC. 2001.** Phytotherapy in the management of benign prostatic hyperplasia. *Urology* **4295**:71–77.
- Merck & Co. 2013.** Proscar(R) [package insert]. Available at [http://www.merck.com/product/usa/pi\\_circulars/p/proscar/proscar\\_pi.pdf](http://www.merck.com/product/usa/pi_circulars/p/proscar/proscar_pi.pdf) (accessed on 24 April 2015).
- Min-Rui O, Jun-Qian L. 2012.** Modeling steroid 5 $\alpha$ -reductase and characterizing its potential active sites. *Chinese Journal of Structural Chemistry* **31**:1618–1626.
- Mooradian A, Haas M. 2014.** The effect of nutritional supplements on serum high-density lipoprotein cholesterol and apolipoprotein A-I. *American Journal of Cardiovascular Drugs* **14**:253–274 DOI [10.1007/s40256-014-0068-1](https://doi.org/10.1007/s40256-014-0068-1).
- Morley JE. 2014.** Vitamins: the good, the bad, and the ugly. *Journal of the American Medical Directors Association* **15**:229–231 DOI [10.1016/j.jamda.2014.01.013](https://doi.org/10.1016/j.jamda.2014.01.013).
- Morris GM, Huey R, Lindstrom W, Sanner MF, Belew RK, Goodsell DS, Olson AJ. 2010.** AutoDock4 and AutoDockTools4: automated docking with selective receptor flexibility. *Journal of Computational Chemistry* **30**:2785–2791 DOI [10.1002/jcc.21256](https://doi.org/10.1002/jcc.21256).

- Mysinger MM, Carchia M, Irwin JJ, Shoichet BK. 2012.** Directory of useful decoys, enhanced (DUD-E): better ligands and decoys for better benchmarking. *Journal of Medicinal Chemistry* **55**:6582–6594 DOI [10.1021/jm300687e](https://doi.org/10.1021/jm300687e).
- Nickel JC, Gilling P, Tammela TL, Morrill B, Wilson TH, Rittmaster RS. 2011.** Comparison of dutasteride and finasteride for treating benign prostatic hyperplasia: the Enlarged Prostate International Comparator Study (EPICS). *BJU International* **108**:388–394 DOI [10.1111/j.1464-410X.2011.10195.x](https://doi.org/10.1111/j.1464-410X.2011.10195.x).
- Niederprüm HJ, Schweikert HU, Zänker KS. 1994.** Testosterone 5 $\alpha$ -reductase inhibition by free fatty acids from *Sabal serrulata* fruits. *Phytomedicine* **1**:127–133 DOI [10.1016/S0944-7113\(11\)80030-9](https://doi.org/10.1016/S0944-7113(11)80030-9).
- Paubert-Braquet M, Richardson FO, Servent-Saez N, Gordon WC, Monge M-C, Bazan NG, Authie D, Braquet P. 1996.** Effect of *Serenoa repens* extract (PERMIXON) on estradiol/testosterone-induced experimental prostate enlargement in the rat. *Pharmacological Research* **34**:171–179 DOI [10.1006/phrs.1996.0085](https://doi.org/10.1006/phrs.1996.0085).
- Raynaud J-P, Cousse H, Martin P-M. 2002.** Inhibition of type 1 and type 2 5 $\alpha$ -reductase activity by free fatty acids, active ingredients of Permixon®. *The Journal of Steroid Biochemistry and Molecular Biology* **82**:233–239 DOI [10.1016/S0960-0760\(02\)00187-5](https://doi.org/10.1016/S0960-0760(02)00187-5).
- Rittmaster RS. 2008.** 5 $\alpha$ -reductase inhibitors in benign prostatic hyperplasia and prostate cancer risk reduction. *Best Practice & Research* **22**:389–402 DOI [10.1016/j.beem.2008.01.016](https://doi.org/10.1016/j.beem.2008.01.016).
- Russell DW, Wilson JD. 1994.** Steroid 5 $\alpha$ -reductase: two genes/two enzymes. *Annual Review of Biochemistry* **63**:25–61 DOI [10.1146/annurev.bi.63.070194.000325](https://doi.org/10.1146/annurev.bi.63.070194.000325).
- Scaglione F, Lucini V, Pannacci M, Caronno A, Leone C. 2008.** Comparison of the potency of different brands of *Serenoa repens* extract on 5 $\alpha$ -reductase types I and II in prostatic co-cultured epithelial and fibroblast cells. *Pharmacology* **82**:270–275 DOI [10.1159/000161128](https://doi.org/10.1159/000161128).
- Shrivastava A, Gupta VB. 2012.** Various treatment options for benign prostatic hyperplasia: a current update. *Journal of Mid-Life Health* **3**:10–19 DOI [10.4103/0976-7800.98811](https://doi.org/10.4103/0976-7800.98811).
- Tacklind J, Macdonald R, Rutks I, Stanke JU, Wilt TJ. 2012.** *Serenoa repens* for benign prostatic hyperplasia. *Cochrane Database of Systematic Reviews* **12**:CD001423.
- Tarayre JP, Delhon A, Laouressergues H, Stenger A, Barbara M, Bru M, Villanova G, Caillol V, Aliaga M. 1983.** Anti-edematous action of a hexane extract of the stone fruit of *Serenoa repens* Bartr. *Annales Pharmaceutiques Francaises* **41**:559–570.
- Thareja S, Rajpoot T, Verma SK. 2015.** Generation of comparative pharmacophoric model for steroidal 5 $\alpha$ -reductase I and II inhibitors: a 3D-QSAR study on 6-azasteroids. *Steroids* **95**:96–103 DOI [10.1016/j.steroids.2015.01.001](https://doi.org/10.1016/j.steroids.2015.01.001).
- Vacherot F, Azzouz M, Gil-Diez-de-Medina S, Colombel M, De La Taille A, Lefrère Belda M-A, Abbou CC, Raynaud J-P, Chopin DK. 2000.** Induction of apoptosis and inhibition of cell proliferation by the lipido-sterolic extract of *Serenoa repens* (LSEsr, Permixon®) in benign prostatic hyperplasia. *The Prostate* **45**:259–266 DOI [10.1002/1097-0045\(20001101\)45:3<259::AID-PROS9>3.0.CO;2-G](https://doi.org/10.1002/1097-0045(20001101)45:3<259::AID-PROS9>3.0.CO;2-G).

- Vela-Navarrete R, Garcia-Cardoso J, Barat A, Manzarbeitia F, Monton M, López-Farre A. 2002.** Effects of the lipido sterolic extract of *Serenoa repens* (Permixon®) on infiltrating cells and inflammatory markers in prostatic tissues from BPH patients. *European Urology Supplements* **1**:62.
- Wang C, Schueler-Furman O, Baker D. 2005.** Improved side-chain modeling for protein–protein docking. *Protein Science* **14**:1328–1339 DOI [10.1110/ps.041222905](https://doi.org/10.1110/ps.041222905).
- Wilt TJ, Ishani A, Stark G, MacDonald R, Lau J, Mulrow C. 1998.** Saw palmetto extracts for treatment of benign prostatic hyperplasia: a systematic review. *JAMA* **280**:1604–1609 DOI [10.1001/jama.280.18.1604](https://doi.org/10.1001/jama.280.18.1604).
- Yao Z, Xu Y, Zhang M, Jiang S, Nicklaus MC, Liao C. 2011.** Discovery of a novel hybrid from finasteride and epristeride as 5 $\alpha$ -reductase inhibitor. *Bioorganic & Medicinal Chemistry Letters* **21**:475–478 DOI [10.1016/j.bmcl.2010.10.112](https://doi.org/10.1016/j.bmcl.2010.10.112).
- Yohani LP, Men R, Rosa M. 2006.** Plasma levels , tissue distribution , and excretion extract of the fruit of roystonea regia, in rats. *Current Therapeutic Research* **67**:406–419 DOI [10.1016/j.curtheres.2006.12.005](https://doi.org/10.1016/j.curtheres.2006.12.005).