

# ADS-B WITHIN A MULTI-AIRCRAFT SIMULATION FOR DISTRIBUTED AIR-GROUND TRAFFIC MANAGEMENT

*Richard Barhydt and Michael T. Palmer, NASA Langley Research Center, Hampton, VA*

*William W. Chung, Science Applications International Corporation, Hampton, VA*

*Ghyrn W. Loveness, NASA Langley Research Center, Hampton, VA*

## Abstract

Automatic Dependent Surveillance Broadcast (ADS-B) is an enabling technology for NASA's Distributed Air-Ground Traffic Management (DAG-TM) concept. DAG-TM has the goal of significantly increasing capacity within the National Airspace System, while maintaining or improving safety. Under DAG-TM, aircraft exchange state and intent information over ADS-B with other aircraft and ground stations. This information supports various surveillance functions including conflict detection and resolution, scheduling, and conformance monitoring.

To conduct more rigorous concept feasibility studies, NASA Langley Research Center's PC-based Air Traffic Operations Simulation models a 1090 MHz ADS-B communication structure, based on industry standards for message content, range, and reception probability. The current ADS-B model reflects a mature operating environment and message interference effects are limited to Mode S transponder replies and ADS-B squitters. This model was recently evaluated in a Joint DAG-TM Air/Ground Coordination Experiment with NASA Ames Research Center. Message probability of reception vs. range was lower at higher traffic levels. The highest message collision probability occurred near the meter fix serving as the confluence for two arrival streams. Even the highest traffic level encountered in the experiment was significantly less than the industry standard "LA Basin 2020" scenario.

Future studies will account for Mode A and C message interference (a major effect in several industry studies) and will include Mode A and C aircraft in the simulation, thereby increasing the total traffic level. These changes will support ongoing enhancements to separation assurance functions that focus on accommodating longer ADS-B information update intervals.

## Introduction

Automatic Dependent Surveillance Broadcast (ADS-B) is an enabling technology for an operational concept under study by NASA that has the goal of significantly increasing capacity within the National Airspace System (NAS). Distributed Air Ground Traffic Management (DAG-TM) represents a paradigm shift from a centralized, ground-based air traffic management system to a distributed network involving pilots, Air Traffic Service Providers (ATSPs), and aeronautical operational control centers [1].

Under DAG-TM, separation assurance responsibilities are assigned to the most appropriate decision maker. Pilots flying appropriately equipped "autonomous" aircraft fly under Autonomous Flight Rules (AFR), where they are allowed to choose their own routes subject to maintaining separation from all other aircraft and conforming to traffic flow management constraints. ATSPs continue to provide separation services to "managed" aircraft unequipped for autonomous operations. Managed aircraft fly under today's Instrument Flight Rules (IFR) and operate in the same airspace as autonomous aircraft. ATSPs also issue waypoint constraints to all aircraft when needed to meet local traffic flow management needs.

All aircraft flying in a DAG-TM environment use ADS-B to transmit position, velocity, and intent information to nearby aircraft and ground stations. ADS-B satisfies DAG-TM's requirement for collaborative information sharing between system participants. Accurate and reliable state and trajectory information provided by ADS-B supports various DAG-TM surveillance functions including conflict detection and resolution, scheduling, and conformance monitoring.

The reliance on ADS-B information by several key DAG-TM operations highlights the importance of considering ADS-B performance capabilities when conducting concept feasibility studies. A comprehensive ADS-B performance review conducted by the Technical Link Assessment Team in 2001 has shown that long-range flight path deconfliction applications, such as those used in DAG-TM, will pose a challenge for data link systems [2]. These challenges are especially apparent in the high-density traffic environments targeted by DAG-TM.

In order to evaluate DAG-TM concepts in an operationally realistic environment, NASA Langley has developed the Air Traffic Operations Simulation (ATOS), hosted by the Air Traffic Operations Lab (ATOL). ATOS incorporates an ADS-B model that considers several real-world performance attributes and limitations. Pilot workstations within a multi-aircraft simulation environment exchange ADS-B information that considers message formats, update intervals, range capabilities, and message collisions. A recent Joint Experiment between NASA Langley and Ames Research Centers served as a test bed for the ADS-B model.

## ADS-B Message Generation

### *Air Traffic Operations Simulation*

The airspace environment simulated within ATOS places a heavy emphasis on maintaining appropriate levels of compatibility with real-world avionics system architectures. The ATOS is instantiated by a computer-workstation based airspace simulation that consists of many components, as shown in Figure 1 below. The components include twelve individual simulated aircraft piloted by a single pilot, multiple pseudo-pilot workstations in which multiple simulated aircraft can be controlled by a single operator, a local air traffic generation tool to provide additional background traffic, and a link to the air traffic control services provided by an offsite facility. This offsite facility, the NASA Ames Airspace Operations Laboratory, is connected through an Internet gateway that converts ADS-B, CPDLC, and other data into the appropriate format for each site. All ATOS components, including this Internet gateway, are linked together by a High-Level Architecture (HLA) bus for data communications.

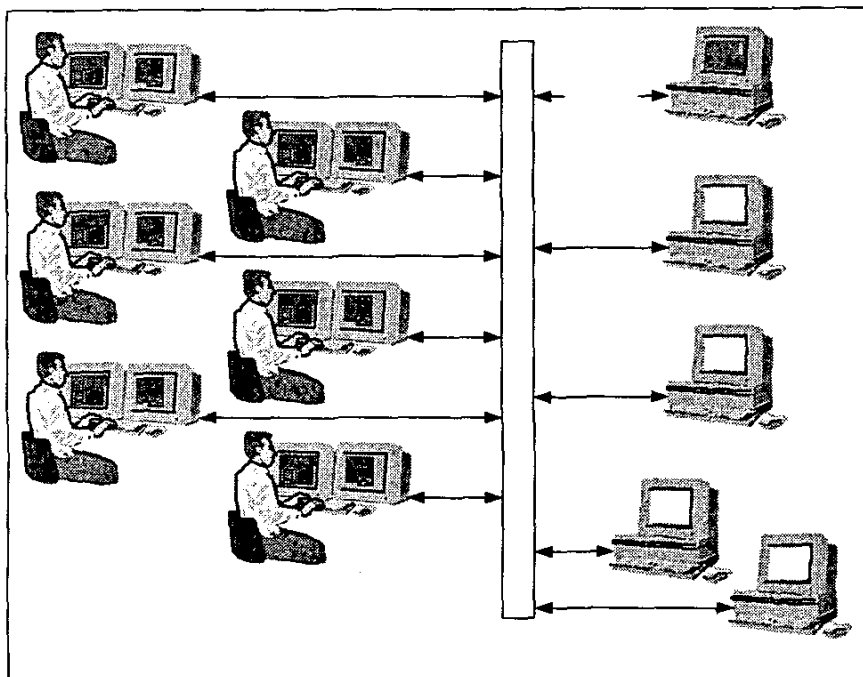


Figure 1. High-Level Structure of the Air Traffic Operations Simulation (ATOS)

### ***Information Flow between ASTOR System Components***

The data that are passed between the various elements of ATOS are tightly controlled, in the sense that they are very closely modeled after existing industry standards for signal transmission. Specifically, all aircraft state and trajectory intent data are based on the current version of the ADS-B Minimum Aviation System Performance Standards (MASPS) document (RTCA/DO-242A) [3]. Although, as described below, the DO-242A specification has been extended in certain areas to support new airborne conflict management functions performed by the Langley-developed Autonomous Operations Planner (AOP), great care has been taken to maintain the underlying assumptions and limitations inherent in the industry standard.

Each individual simulated aircraft within ATOS is called an Aircraft Simulation for Traffic Operations Research (ASTOR). Within each ASTOR, ADS-B data are handled through different processes depending on whether an ownship outgoing message is being created or a traffic incoming message is being analyzed. For outgoing messages, the data are generated by the appropriate ASTOR component such as the Flight Management Computer (FMC), AOP, or autopilot/autothrottle system and then assembled for transmission by AOP and sent to a simulated ADS-B transponder for broadcast. Incoming messages from nearby traffic aircraft are received by the same simulated ADS-B transponder, and are assembled into reports and then placed onto a newly defined channel of a simulated ARINC 429 data bus [4] for internal transport to any ASTOR avionics components making use of ADS-B data.

### ***Development of ADS-B Message Elements***

The ADS-B specification in RTCA/DO-242A describes the content of the various reports used for surveillance applications. Three of these reports are especially useful for estimating the flight trajectory of nearby traffic aircraft. The first of these report types is the State Vector (SV) report, which contains an aircraft's three-dimensional position and velocity. The second report is the Target State (TS) report, which contains information on the horizontal and vertical targets of an aircraft's flight

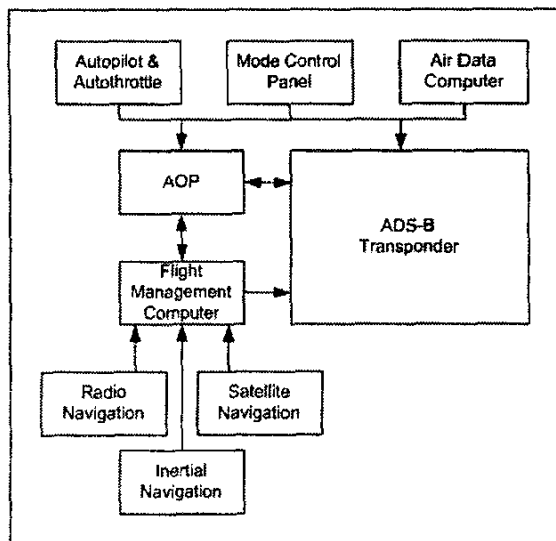
guidance system for the current flight segment. The final report type is the Trajectory Change (TC) report, which describes the characteristics of one Trajectory Change Point (TCP) and its preceding flight segment. These characteristics include the latitude and longitude, track to and from the TCP, turn radius, expected crossing altitude and time, and various conformance flags. Multiple TC reports are used to describe the series of TCPs that comprise a portion of either the *command* or *planned* trajectory of the aircraft. AOP generates both of these trajectories for the own aircraft and the differences between them are described below.

The ADS-B MASPS differentiates between two types of aircraft flight path trajectories [3,5]. The first is the *command* trajectory, which is the path the aircraft will fly unless the pilot engages a new flight guidance mode or changes the targets for the active or upcoming guidance modes. Although changes to the command trajectory usually result from specific pilot actions, changes may also occur as a result of non-programmed guidance mode transitions or reversions due to, for example, an overspeed condition. In contrast, the *planned* trajectory includes flight segments that are dependent upon the pilot engaging a new guidance mode. An example of the difference between command and planned trajectories is the case of an aircraft at FL310 descending towards a flight plan waypoint that has a crossing restriction of 17,000 feet, with a selected autopilot limit altitude of FL240. Although the planned trajectory descends all the way to 17,000 feet, the command trajectory levels out at FL240 because the aircraft will level out at that altitude without further pilot action.

Because the command trajectory describes the currently programmed flight path of the aircraft, it is considered to represent the best estimate of the aircraft's current intent and is therefore given broadcast priority over the planned trajectory [3]. The TC report structure enables the receiving system to clearly distinguish between the command and planned trajectories.

A general schematic of the information flow for the creation of ADS-B messages is shown in Figure 2 below. Most of the ownship data assembled for transmission by the ADS-B transponder is available on one of the many simulated ARINC 429 data bus channels. For

example, state vector data including position, north and east velocities, barometric and geometric altitudes, and vertical speed are taken directly from channels such as the FMC general output channel, the air data computer channel, and the GPS and/or inertial reference system channels.



**Figure 2. General Schematic of Information Flow for ADS-B Message Creation**

In contrast, some of the mode status data including participant category and class codes, and aircraft size code, are stored within the transponder itself because these values are essentially invariant for each modeled ADS-B participant. Because ATOS does not currently support a mixture of surveillance capabilities, most elements from the Mode Status Report are not provided. Some other data must be newly generated from multiple sources for each transmission. For example, data for the target state message requires additional processing because depending on the active lateral and vertical guidance modes, the target heading and altitude may require combining information from both the FMC flight plan as well as the selected values in the Mode Control Panel (MCP).

Because the current ASTOR architecture relies upon the advanced trajectory processing capability within AOP to produce the series of TCPs that will be broadcast over ADS-B, the AOP must have access to the necessary data describing the future flight path of the ownship aircraft. AOP extracts

this needed data primarily from the FMC trajectory intent channel, which includes data blocks for each trajectory change point in both the active and modified (if one exists) navigation routes stored in the FMC. When AOP assembles the trajectory change messages, however, it only uses up to four TCPs from the FMC. This limitation is maintained for operational realism because it is unlikely that many of the initial ADS-B implementations will support even this many TCPs [2].

When the aircraft is flying under FMC guidance modes, the data for each trajectory change point includes the location and FMC predicted crossing altitude, airspeed, and time. Because the broadcast TCPs must reflect the command trajectory, the FMC flight plan TCPs cannot be sent out unmodified. AOP must consider the active or anticipated flights modes, as well as autopilot system targets and current aircraft states to determine the proper command trajectory. AOP sends the command trajectory TCPs to the ADS-B transponder for transmission to other participants.

Although the data included in the trajectory change messages currently exceeds the FMC trajectory intent channel's defined contents as specified in ARINC 702A, the extensions are limited and should be easily available within the FMC. The block-data transfer format of the trajectory intent channel eliminates the need for any new ARINC 429 word label assignments.

### ADS-B Performance Modeling

To simulate ADS-B performance, ASTOR uses a modeled Mode S 1090 MHz communication link to broadcast and receive ADS-B messages. This Mode S transmission and receiving model simulated in ATOS was developed by Seagull Technology and consists of two components: Mode S broadcast range and message reception validity. Broadcast range performance is modeled as a function of ADS-B transmitter and receiver characteristics. Message reception validity is modeled as a function of message collisions due to various messages and interrogation replies sent over 1090 MHz. Both components contribute to the probability that an ADS-B message is received by its recipient.

### Range

Equations 1 and 2 give the maximum no interference range as a function of transmitter and receiver antenna power, cable loss, and standard free space loss. The maximum range is defined as having 90% probability of reception with no interference. Figure 3 shows the no interference probability of reception vs. range. The maximum range simulated in the experiment is 81 NM. This value was chosen to be slightly less than the 90 NM minimum prescribed by the ADS-B MASPS for Class A3 equipment [3]. This value limits the number of messages received by AOP and improves its processing performance.

$$R_{\max} = a \cdot 10^{\left(\frac{L_{FS}}{20}\right)} \quad (1)$$

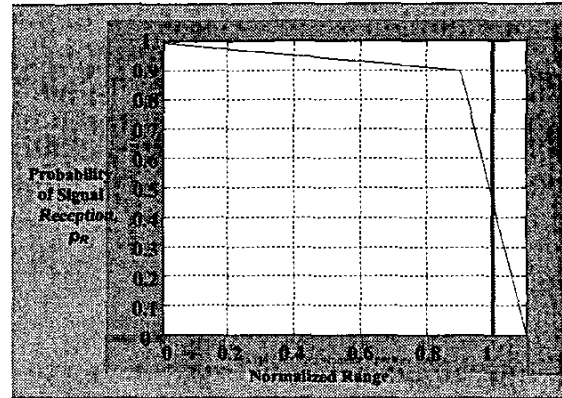
where  $a$  is the standard free space loss at 1090 MHz,  $a = 1.188e-5$  mw-NM, and  $L_{FS}$  in dB is the maximum allowable signal power transmission loss.

$L_{FS}$  is defined in Equation 2 and is a function of minimum triggering received power level (MTL), Mode S transmitter power ( $P_T$ ), cable loss ( $L_{TC}$ ), transmitter antenna gain ( $G_T$ ), receiver antenna gain ( $G_R$ ), and receiver cable loss ( $L_{RC}$ ). Transmitter power is set to 500 watts or 54 dBm and MTL is set to  $3.686 \times 10^{-5}$  watt or  $-88.67$  dBm, which both conform with recommended high-end system performance [2]. Cable loss ( $L_{TC}$  or  $L_{RC}$ ) is assumed to be 50% or  $-3$ dB of original send or receiving power and no antenna gain loss is assumed.

$$L_{FS} = MTL - (P_T + L_{TC} + G_T + G_R + L_{RC}) \quad (2)$$

### Message Reception Validity

Message reception validity is modeling message collision effects caused by interference from various radar interrogation replies and messages over 1090 MHz. A message collision occurs if the broadcast time interval from two separate messages or replies overlap partially or completely.



**Figure 3. Probability of Correct Message Reception vs. Normalized Range (No Interference)**

The current ATOS only models Mode S air-air and air-ground communication. Although numerous flight test evaluations of 1090 MHz signals in the current NAS show a strong dominance of Mode A and C replies over those from Mode S [6-7], DAG-TM feasibility studies are focusing on mature operating environments. Under DAG-TM, all aircraft are presumed to have ADS-B capabilities and corresponding Mode S transponders. All secondary surveillance radar sites are also presumed to interrogate over Mode S. Some industry activity indicates a trend toward ADS-B surveillance, including radar replacement in Australia and Boeing and Airbus commitments to offer ADS-B transmitters as part of an avionics upgrade [8]. Despite these trends, future ATOS development efforts will include the substantial interference contribution from Mode A and C replies.

Message collisions in the current ATOS implementation are due to:

- 1) Mode S short messages [7] (56 bit, 64  $\mu$ sec), which include ground surveillance, data link, All-Call interrogation, and TCAS, and
- 2) Mode S long messages (112 bit, 120  $\mu$ sec), which include ground data link (GDL), ADS-B position message, ADS-B velocity message, ID message, and on-demand squitter (ODS) message.

ASTOR's Mode-S probability of having correct message reception is determined by Equation 3 and is based on a Poisson probability distribution [9].

$$P_{T,Long} = P_R \cdot P_{Short} \cdot P_{Long} \quad (3)$$

where,

$P_{T,Long}$  = Probability of correct long message reception between two ADS-B equipped airplanes

$P_R$  = Probability of correct long message reception based on relative range without message collision (no interference, Figure 3)

$P_{Short}$  = Probability of correct long message reception in presence of potential short message collisions

$P_{Long}$  = Probability of correct long message reception in presence of potential collisions with other long messages

Probabilities of individual reception are defined in Equations 4-6, where message reception frequencies are listed in Table 1.

$$P_{Short} \cong e^{-\lambda_{Short} \tau_{Short}} \quad (4)$$

$$P_{Long} \cong e^{-\lambda_{Long} \tau_{Long}} \quad (5)$$

where  $\tau$  values are total time intervals during which a message collision can occur:  $\tau_{A/C} = 140 \mu\text{sec}$ ,  $\tau_{Short} = 186 \mu\text{sec}$ , and  $\tau_{Long} = 240 \mu\text{sec}$  [10]. Values of  $\lambda$  are total number of message replies/second for each type and are defined in Equation 6.

$$\lambda_i = N_i \times F_{ij} \quad (6)$$

where  $N_i$  is the number of aircraft in range emitting a particular type of interference and  $F_{ij}$  is the broadcast rate for the corresponding type. Default values used in the simulation are shown in Table 1.

**Table 1. Message Reply Rates Used in Message Collision Probability**

Message replies/s	Modeled by
$\lambda_{Short}$	$N_{a/c\_in\_range} \times (F_{SSR} + F_{All\_Call}) + N_{TCAS} \times F_{TCAS}$ <ul style="list-style-type: none"> <li>• <math>R_{max}</math> used to determine <math>N_{a/c\_in\_range}</math></li> <li>• <math>N_{TCAS}</math> is # aircraft within 14 NM TCAS range</li> <li>• <math>F_{SSR} = 2 \text{ Hz}</math></li> <li>• <math>F_{All\_Call} = 1 \text{ Hz}</math></li> <li>• <math>F_{TCAS} = 1 \text{ Hz}</math></li> </ul>
$\lambda_{Long}$	$(F_{GDL} + F_{Position} + F_{Velocity} + F_{ID} + F_{ODS}) \times N_{a/c\_in\_range}$ <ul style="list-style-type: none"> <li>• <math>F_{GDL} = 2 \text{ Hz}</math></li> <li>• <math>F_{Position} = 2 \text{ Hz}</math> [2]</li> <li>• <math>F_{Velocity} = 2 \text{ Hz}</math> [2]</li> <li>• <math>F_{ID} = 0.2 \text{ Hz}</math></li> <li>• <math>F_{ODS} = 0.3 \text{ Hz}</math></li> </ul>

#### Message Broadcast Rate and Report Update Interval

ATOS supports five ADS-B message types that provide information for the corresponding report types specified in the ADS-B MASPS: State Vector, Mode Status, Air-Referenced Velocity, Target State, and Trajectory Change [3]. Although a real ADS-B receiving system may require several incoming messages to assemble a report, the current simulation conveys all information needed for a report in a single message. Therefore, the report update interval is equal to the corresponding message broadcast rate multiplied by the probability of correct message reception ( $P_{T,Long}$  from Equation 3). ASTOR updates traffic aircraft positions every second, coasting a target up to 30 seconds if a new message is not received. Resulting update intervals due to the message broadcast rates in Table 2 are notably faster than those currently prescribed in the ADS-B MASPS [3]. The decision to use these values was due to current AOP separation assurance performance limitations that require high information update rates and to satisfy Joint Experiment lab connectivity needs. Future ATOS enhancements will work to reduce this performance gap.

**Table 2. ADS-B Message Broadcast Rate**

<i>ADS-B Message</i>	<i>Broadcast Rate (Hz)</i>
State Vector	1
Mode Status	3
Air-Referenced Velocity	3
Target State	3
Trajectory Change	3

## Joint Experiment

### Design

A recently conducted Joint Experiment between NASA Langley and Ames Research Centers evaluated air/ground coordination issues during DAG-TM en route and arrival operations. It also served as an initial test platform for the ATOS ADS-B model described above. Corresponding to the DAG-TM goal of substantially increasing traffic levels in a mixed equipage environment (autonomous and managed aircraft flying in the same airspace), the experiment included two primary factors:

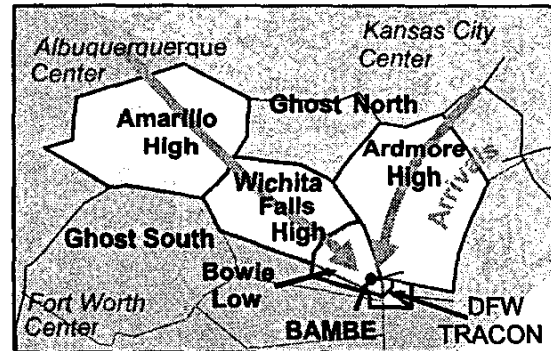
- Mixed Operations (comparison of mixture of autonomous and managed aircraft in same airspace vs. managed aircraft alone, at the same traffic level).
- Scalability (addition of increasing levels of autonomous aircraft to level of managed aircraft occurring under current operations).

Traffic scenarios were run at three different traffic levels (“L1,” “L2,” and “L3”), with the L1 level repeated for the “all managed” and “mixed” autonomous/managed traffic conditions. The L2 and L3 levels included the same number of managed aircraft as the L1 mixed condition, while adding autonomous aircraft. This design led to a total of four experimental conditions.

The Langley ATOL and Ames Airspace Operations Lab were connected for the experiment and operations at both labs were conducted simultaneously as part of an overall traffic environment. Twelve subject pilots participated at Langley (each flying one ASTOR station) and five subject controllers and nine subject pilots participated at Ames. Pseudo pilots monitored pre-programmed background aircraft added to achieve

the desired traffic level. Subject pilots flew four different traffic scenarios for each of the four conditions, using a within-subjects design.

The experimental airspace modeled the Dallas Ft. Worth area and is shown in Figure 4. Subject controllers staffed the Amarillo, Ardmore, and Wichita Falls High Sectors and the Bowie Low sector. A pseudo controller handled each “ghost” sector and performed handoff duties to the subject controllers. Aircraft flew in the ghost sectors, but no data were collected there. Each subject pilot flew two overflights and two arrivals for each experimental condition. Overflights crossed either the Amarillo or Ardmore High sectors. For arriving aircraft, two streams began in level flight in Amarillo or Ardmore and both included a descent to cross the BAMBE meter fix at 250 knots and 11,000 ft. The subject controller used a scheduler to assign required times of arrival at BAMBE to each arriving aircraft. The scenario ended for each subject pilot when he or she crossed the high altitude sector for overflights or the BAMBE fix for arrivals. Controllers continued to work traffic until all subject pilots from Ames and Langley had finished.



**Figure 4. Joint Experiment Airspace**

Traffic levels for the three high altitude sectors are provided in Table 3. All were established by a controller workload study conducted by Ames. During this study, traffic levels (containing only managed aircraft) were ramped up in each sector. The L1 level was set at the point where controller workload was judged to be manageable, but challenging. The L2 and L3 levels were set a proportional amount higher than L1, with each level determined to be above the amount that a controller could handle if all aircraft were managed. Traffic

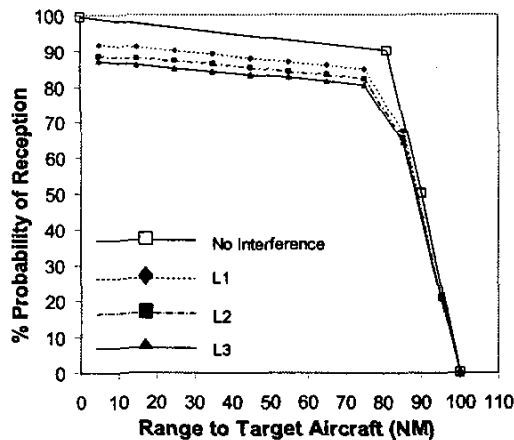
levels were varied by changing the number of overflights, while arrivals were held constant. The Bowie Low sector contained no overflights and was therefore at a constant traffic level across all test conditions.

**Table 3. Traffic Levels for High Altitude Sectors**

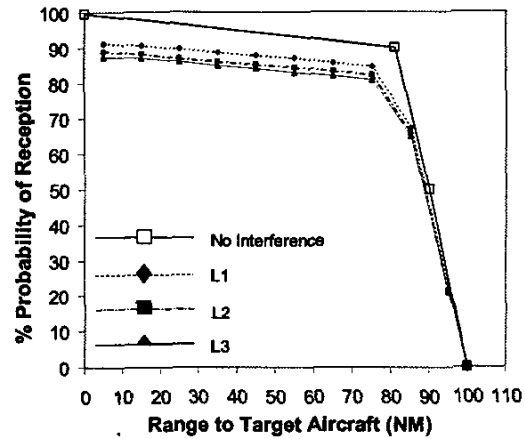
Sector	L1	L2	L3
Amarillo	20	30	40
Ardmore	20	30	40
Wichita Falls	16	20	24

**ADS-B Model Performance Results**

The results described below focus on the air-air ADS-B model performance used during the experiment. Figures 5 and 6 give the probability of message reception vs. range to the target aircraft for Langley subject pilot overflights and arrivals, respectively. Points are derived from a histogram with 10 NM bins (centered at each point) that incorporates all messages received by ASTOR aircraft over the course of all runs for the respective traffic level. The L1 points only include the mixed autonomous/managed condition.



**Figure 5. Overflight ADS-B Message Reception Probability**



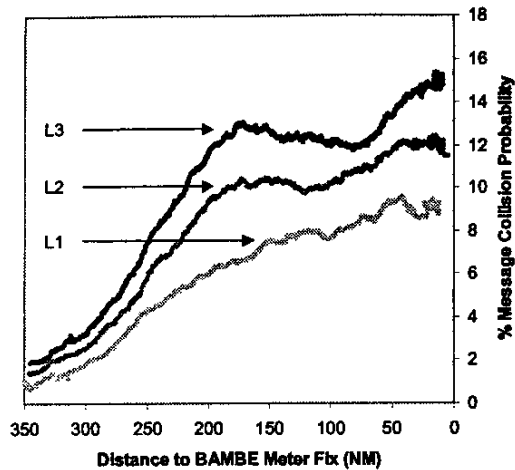
**Figure 6. BAMBE Arrival ADS-B Message Reception Probability**

The charts show the anticipated lower probability of reception at the higher traffic levels. Performance curves tend to follow the no interference probability of reception vs. range shown in Figure 3.

Because the density of traffic does not necessarily remain constant for the entire run, the message collision probability may vary as an aircraft progresses toward the meter fix. Figure 7 shows the message collision probability as a function of distance to the BAMBE meter fix. For clarity, the figure only shows every hundredth message received for all arriving ASTOR aircraft. As expected, each aircraft encounters more traffic as it nears the meter fix, thereby causing the probability of message collision to increase.

Each subject-piloted aircraft was initialized just outside the Ardmore or Amarillo sectors, causing aircraft inbound from Ardmore to fly a much shorter distance before arriving at BAMBE. The level off in message collision probability at ~150 NM is likely due to the inclusion of Ardmore traffic at about that point. This traffic was closer to the boundary of the simulation airspace and encountered a lower traffic density.

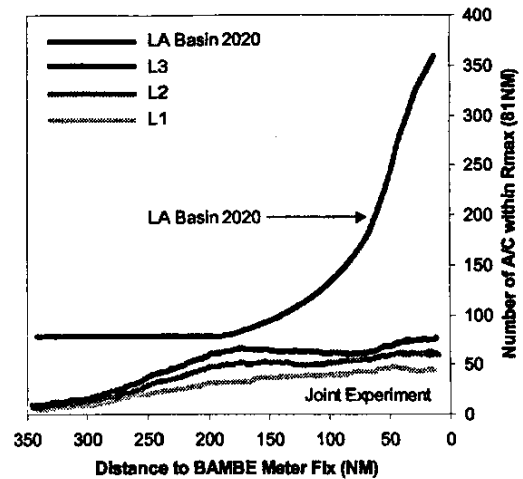




**Figure 7. BAMBE Arrival ADS-B Message Collision Probability**

To compare the traffic density encountered by arriving aircraft during this experiment with a common baseline, Figure 8 overlays the Los Angeles Basin 2020 airborne traffic levels used in the TLAT scenario [2]. The upper curve shows the number of aircraft that would have been within  $R_{max}$  (81 NM) of an aircraft flying a comparable distance from Los Angeles International Airport as the reference ASTOR aircraft (lower curves) was flying from Dallas Ft. Worth International Airport (KDFW). All distances from the BAMBE meter fix were cross-referenced with the ASTOR aircraft's distance from KDFW. Those distance to airport values were used to determine the corresponding LA 2020 levels.

Clearly, the LA 2020 scenario represents a significantly higher traffic level than the numbers encountered during this experiment. Reasons include the lower density Mode S traffic outside the subject controller sectors, extremely high traffic density of the LA area [7], and the absence of Mode A and C aircraft in the ADS-B performance model. Future ADS-B modeling within ATOS will work to alleviate these differences.



**Figure 8. BAMBE Arrival Traffic Levels within  $R_{max}$  (81 NM) Compared to LA Basin 2020 Scenario**

## Conclusions

Feasibility assessments of advanced operational concepts such as DAG-TM will need to include reliable performance modeling of all enabling technologies. The concept can only work as intended when assumptions of system capabilities used for simulation are in line with current and anticipated real-world system performance.

The ADS-B performance model implemented in the Joint Experiment represents a first step toward a real-world representation. Message elements comply well with established ADS-B standards and those elements are largely supported through limited extensions to existing ARINC data buses.

To make the ATOS ADS-B model more compatible with existing systems, Mode A and C aircraft effects must be included and simulations should be carried out at higher traffic levels. These enhancements will also drive improvements to AOP and ASTOR system handling of dropped or otherwise unavailable messages. Real ADS-B systems are held to a very high standard. The ADS-B MASPS requires all proposed ADS-B applications to comply with its specifications under the LA Basin 2020 environment [3]. Proposed

operational concepts must ultimately conform to these rigid standards and performance capabilities.

Recent development work at Lincoln Lab is showing promising results for improving 1090 MHz ADS-B signals in the presence of Mode A and C reply interference [11]. Further developments to the ATOS ADS-B model as well as ongoing 1090 MHz system enhancements should help bridge the gap between assumed DAG-TM data link capabilities and actual operational performance.

## References

- [1] Ballin M., D. Wing, M. Hughes, and S. Conway, 1999, Airborne Separation Assurance and Traffic Management: Research of Concepts and Technology, AIAA-99-3989, AIAA.
- [2] RTCA and Eurocontrol, 2001, ADS-B Technical Link Assessment Team Technical Link Assessment Report, RTCA and Eurocontrol, [http://www.eurocontrol.int/ads/ADS\\_Programme\\_content.htm](http://www.eurocontrol.int/ads/ADS_Programme_content.htm)
- [3] RTCA, 2002, Minimum Aviation System Performance Standards for Automatic Dependent Surveillance Broadcast (ADS-B), RTCA/DO-242A, Washington, DC, RTCA.
- [4] Palmer M. and M. Ballin, 2003, A High-Performance Simulated On-Board Avionics Architecture to Support Traffic Operations Research, AIAA-2003-5452, AIAA.
- [5] Barhydt R. and A. Warren, 2002, Newly Enacted Intent Changes to ADS-B MASPS: Emphasis on Operations, Compatibility, and Integrity, AIAA-2002-4932, AIAA.

[6] Bernays, D.J., S.D. Thompson, and W.H. Harman, 2000, Measurements of ADS-B Extended Squitter Performance in the Los Angeles Basin Region, 19<sup>th</sup> Digital Avionics Systems Conference, Vol. 2, Philadelphia, PA, IEEE/AIAA, pp. 7.B.1-1 – 7.B.1-8.

[7] Harman, W.H and M.J. Brennan, 1997, Beacon Radar and TCAS Reply Rates: Airborne Measurements in the 1090 MHz Band, Project Report ATC-256, Lincoln Laboratory, MIT.

[8] Eurocontrol, 2004, ASAS Thematic Network, Report of the Third Workshop, ASAS-TN/WP1/WS3/Report, Eurocontrol.

[9] Orlando, V.A. and W.H. Harman, GPS-Squitter Capacity Analysis, DOT/FAA/RD-94/8, Lincoln Laboratory, MIT.

[10] Orlando, V.A. and G.H. Knittel, 1993, GPS-Squitter: System Concept and Performance, ATC Quarterly, Vol. 1, No. 4, Air Traffic Control Association, pp. 303-326.

[11] Harman, W, J. Gertz, and A. Kaminsky, 1998, Techniques for Improved Reception of 1090 MHz ADS-B Signals, 17<sup>th</sup> Digital Avionics Systems Conference, Vol. 2, Bellevue, WA, IEEE/AIAA, pp. G25-1 – G25-9.

## Email Addresses

- Richard Barhydt, [richard.barhydt@nasa.gov](mailto:richard.barhydt@nasa.gov)
- Michael Palmer, [michael.t.palmer@nasa.gov](mailto:michael.t.palmer@nasa.gov)
- William Chung, [w.w.chung@larc.nasa.gov](mailto:w.w.chung@larc.nasa.gov)
- Ghyrn Loveness, [g.e.loveness@larc.nasa.gov](mailto:g.e.loveness@larc.nasa.gov)